

DPG Desk panels and Desk Control Apps



To learn more about LINAK, please visit:
www.linak.com

Contents

| | |
|---|----|
| Preface | 4 |
| Important information | 5 |
| Safety instructions | 5 |
| Only for EU markets | 8 |
| Only for Non EU markets | 8 |
| Misuse | 8 |
| Informations importantes | 9 |
| Consignes de sécurité | 9 |
| Seulement pour les marchés au sein de l'UE | 10 |
| Seulement pour les marchés hors UE | 10 |
| Utilisation abusive | 10 |
| Repairs | 11 |
| Declaration of incorporation of partly completed machinery | 11 |
| Misc. on the DESKLINE® system | 12 |
| Warranty | 12 |
| Maintenance | 12 |
| ETL-marking | 12 |
| Products | 13 |
| Operation of the DPG series | 14 |
| Operation of the DPG1M | 15 |
| Operation of the DPG1B/C | 20 |
| Placement of the DPG1K/M | 27 |
| Placement of the DPG1B/C | 28 |
| Mounting of the DPG | 29 |
| Preparing the tabletop for both DPG sizes | 30 |
| Bluetooth® Adapter | 32 |
| How to put the adapter in pairing mode..... | 33 |
| Desk Control | 34 |
| Disposal of LINAK's products | 45 |
| Drawing appendix | 46 |
| Labels | 49 |
| Declaration of Conformity | 50 |
| LINAK application policy | 51 |
| Addresses | 52 |

Preface

Dear User,

We are delighted that you have chosen a product from LINAK®.

LINAK systems are high-tech products based on many years of experience in the manufacture and development of actuators, electric control boxes, controls and chargers.

This User Manual does not address the end-user. It is intended as a source of information for the manufacturer of the equipment or system only, and it will tell you how to install, use and maintain your LINAK electronics. It is the responsibility of the manufacturer of the end-use product to provide a User Manual where relevant safety information from this manual is passed on to the end-user.

We are sure that your LINAK product will give you many years of problem-free operation.

Before our products leave the factory they undergo full function and quality testing. Should you nevertheless experience problems with your systems, you are always welcome to contact your local dealer.

LINAK subsidiaries and some distributors situated all over the world have authorised service centres, which are always ready to help you.

LINAK provides a warranty on all its products. This warranty, however, is subject to correct use in accordance with the specifications, maintenance being done correctly and any repairs being carried out at a service centre, which is authorised to repair LINAK products.

Changes in installation and use of LINAK systems can affect their operation and durability. The products are not to be opened by unauthorised personnel.

The User Manual has been written based on of our present technical knowledge. We are constantly working on updating the information and we therefore reserve the right to carry out technical modifications.

LINAK A/S

Important information

Important information on LINAK® products can be found under the following headings:



Warning!

Failure to comply with these instructions may result in accidents involving serious personal injury.



Failing to follow these instructions can result in the product being damaged or being destroyed.

Safety instruction



General

Safe use of the system is possible only when the operating instructions are read completely and the instructions contained are strictly observed.

Failure to comply with instructions marked with the "NOTE" symbol may result in serious damage to the system or one of its components.



It is important for everyone who is to connect, install, or use the systems to have the necessary information and access to this User Manual. Follow the instructions for mounting – risk of injury if these instructions are not followed.



The appliance is not intended for use by young children or infirm persons without supervision.



If there is visible damage on the product it must not be installed.



Note that during construction of applications, in which the actuator is to be fitted, there must be no possibility of personal injury, for example the squeezing of fingers or arms.



Assure free space for movement of application in both directions to avoid blockade.

This device complies with part 15 of the FCC Rules. Operation is subject to the following two conditions:

- (1) This device may not cause harmful interference, and**
- (2) This device must accept any interference received, including interference that may cause undesired operation**

- **Statement – for all intentional and unintentional radiators:**

Changes or modifications not expressly approved by the party responsible for compliance could void the user's authority to operate the equipment.

- **Statement for digital devices for Class B:**

NOTE: This equipment has been tested and found to comply with the limits for a Class B digital device, pursuant to part 15 of the FCC Rules. These limits are designed to provide reasonable protection against harmful interference in a residential installation. This equipment generates, uses and can radiate radio frequency energy and, if not installed and used in accordance with the instructions it may cause harmful interference to radio communications. However, there is no guarantee that interference will not occur in a particular installation. If this equipment does cause harmful interference to radio or television reception, which can be determined by turning the equipment off and on, the user is encouraged to try to correct the interference by one or more of the following measures:

- Reorient or relocate the receiving antenna.
 - Increase the separation between the equipment and the receiver.
 - Connect the equipment into an outlet on a circuit different from that to which the receiver is connected.
 - Consult the dealer or an experienced radio/ TV technician for help.
-

This device complies with Industry Canada licence-exempt RSS standard(s).

Operation is subject to the following two conditions:

(1) this device may not cause interference, and (2) this device must accept any interference, including interference that may cause undesired operation of the device.

Le présent appareil est conforme aux CNR d'Industrie Canada applicables aux appareils radio exempts de licence. L'exploitation est autorisée aux deux conditions suivantes :

- (1) l'appareil n' doit pas produire de brouillage, et
 - (2) l'utilisateur de l'appareil doit accepter tout brouillage radioélectrique subi, même si le brouillage est susceptible d'en compromettre le fonctionnement.
-

Labeling Requirements:

This Class B digital apparatus complies with Canadian ICES-003.

Cet appareil numérique de la classe B est conforme à la norme NMB-003 du Canada.

Only for EU markets



This appliance can be used by children aged from 8 years and above and persons with reduced physical, sensory or mental capabilities or lack of experience and knowledge if they have given supervision or instruction concerning use of the appliance in a safe way and understand the hazards involved.



Children shall not play with the appliance. Cleaning and user maintenance shall not be made by children without supervision.

Only for Non EU markets



Persons who do not have the necessary experience or knowledge of the product/products must not use the product/products. Besides, persons with reduced physical, sensory or mental abilities must not use the product/products, unless they are under surveillance or they have been thoroughly instructed in the use of the apparatus by a person who is responsible for the safety of these persons.



Moreover, children must be under surveillance to ensure that they do not play with the product.

Misuse



Do not overload the actuators – this can cause danger of personal injury and damage to the system.



Do not use the actuator system for lifting persons. Do not sit or stand on a table while operating – risk of personal injury.



Do not use the system in environments other than the intended indoor use

Informations importantes

Les informations importantes sur les produits LINAK® peuvent être trouvées dans les rubriques suivantes:



Attention!

Le non respect de ces instructions peut entraîner des accidents impliquant des blessures graves.



Ne pas suivre ces instructions peut entraîner l'endommagement ou destruction du produit.

Consignes de sécurité



Général

Le non respect de ces instructions peut entraîner des accidents impliquant des blessures graves.

Ne pas suivre ces instructions peut entraîner l'endommagement ou destruction du produit.

L'utilisation en toute sécurité du système n'est possible que si l'intégralité des instructions ont été lues et ont été strictement suivies.



Le non respect de se conformer aux instructions marquées du symbole "note" peut entraîner de graves dommages au système ou à un de ses composants.

Il est important pour tout individu qui connecte, installe, ou utilise le système d'avoir les informations nécessaires et l'accès à ce manuel d'utilisation.

Suivez les instructions pour le montage – risque de blessure si ces instructions ne sont pas suivies.



L'appareil n'est pas destiné à être utilisé par des enfants ou des personnes handicapées sans surveillance.



S'il y a des dommages visibles sur le produit, l'installation ne doit pas être effectuée.



Prendre en compte lors de la construction du matériel, dans lequel l'actionneur est incorporé, qu'il ne doit y avoir aucune possibilité de blessures corporelles, telles que la compression des doigts ou des bras.



Assurez un espace libre autour du matériel pour éviter tout blocage.

Seulement pour les marchés au sein de l'UE:



Cet appareil peut-être utilisé par des enfants âgés de 8 ans et plus, ainsi que les personnes dont les capacités physiques, sensorielles ou mentales sont réduites ou ayant un manque d'expérience et de connaissance si elles ont bénéficié d'une surveillance ou d'instructions concernant l'utilisation de l'appareil en toute sécurité et compris les risques encourus.



Les enfants ne doivent pas jouer avec l'appareil. Le nettoyage et l'entretien ne doivent pas être réalisés par des enfants sans surveillance.

Seulement pour les marchés hors UE.



Les personnes qui n'ont pas l'expérience ou les connaissances nécessaires sur le ou les produit(s) ne doivent pas le ou les utiliser. Par ailleurs, les personnes ayant des capacités physiques, sensorielles ou mentales réduites ne doivent pas utiliser le ou les produit(s), sauf si elles sont sous surveillance ou ont suivi une formation approfondie de l'utilisation de l'appareil par l'individu responsable de la sécurité de ces personnes.



De plus, les enfants doivent-être sous surveillance afin de s'assurer qu'ils ne jouent pas avec le produit.

Utilisation abusive:



Ne surchargez pas les actionneurs – cela peut engendrer un risque de blessures corporelles et endommager le système.



Ne pas utiliser les actionneurs pour soulever des personnes. Ne pas s'asseoir ou se tenir debout sur une table en fonctionnement – risque de blessures.



Ne pas utiliser le système dans des environnements autres que l'utilisation intérieure prévue.

Repairs

In order to avoid the risk of malfunction, all DESKLINE® repairs must only be carried out by authorised LINAK® workshops or repairers, as special tools must be used and special gaskets must be fitted. Lifting units under warranty must also be returned to authorised LINAK workshops.



Warning!

If any of the DESKLINE® products are opened, there will be a risk of subsequent malfunction.



Warning!

The DESKLINE® systems are not resistant to cutting oil.

DECLARATION OF INCORPORATION OF PARTLY COMPLETED MACHINERY

LINAK A/S
Smedevænget 8
DK - 6430 Nordborg

Herewith declares that LINAK DESKLINE® products as characterized by the following models and types:

Control Boxes CBD4, CBD6S

And

Linear Actuators LA31, DB4, DB5, DB6, DB7, DB9, DB12, DB14, DB16, LA23

Lifting Columns DL1A, DL2, DL4, DL5, DL6, DL7, DL8, DL9, DL10, DL11, DL12, DL14, DL15,
DL16, DL17, LP2, LP3, BASE1

And

Desk Panels DP, DPA, DPB, DPH, DPF, DPT, DP1C, DP1K, DP1L, DP1V, DP1U, WDPL1

RF Controls HB10, HB20, RFR and RFT

And

Accessories SLS

comply with the following parts of the Machinery Directive 2006/42/EC, ANNEX I, *Essential health and safety requirements relating to the design and construction of machinery*:

1.5.1 Electricity supply

The relevant technical documentation is compiled in accordance with part B of Annex VII and that this documentation or part hereof will be transmitted by post or electronically to a reasoned request by the national authorities.

This partly completed machinery must not be put into service until the final machinery into which it is to be incorporated has been declared in conformity with the provisions of the Machinery Directive 2006/42/EC where appropriate.

Nordborg, 2014-04-10

LINAK A/S
John Kling, B.Sc.E.E.
Certification and Regulatory Affairs
Authorized to compile the relevant technical documentation

Misc. on the DESKLINE® system

Warranty

There is a 60 months' warranty on the DESKLINE products when used in DESKLINE applications against manufacturing faults from the production date of the individual products. LINAK A/S' warranty is only valid in so far as the equipment has been used and maintained correctly and has not been tampered with. Furthermore, the system must not be exposed to violent treatment. In the event of this, the warranty will be ineffective/invalid. For further details, please see LINAK A/S' ordinary conditions of sale.

Maintenance

Clean dust and dirt on the outside of the system at appropriate intervals and inspect for damage and breaks. Inspect the connections, cables, and plugs and check for correct functioning as well as fixing points.



The cleaners and disinfectants must not be highly alkaline or acidic (pH value 6-8).

ETL-marking

Due to space limitations, the complete ETL-marking demands are not represented on the marking plates.

The full ETL Recognized Component markings are shown here.



C/N 120690

Conforms to ANSI/AAMI Std. ES60601-1
Cert. to CSA Std. C22.2 No. 60601-1

ETL Recognized Component mark for Canada and United States



C/N 4008003

Conforms to ANSI/AAMI Std. ES60601-1
Cert. to CSA Std. C22.2 No. 60601-1

ETL Recognized Component mark for Canada and United States



C/N 4008004

Conforms to ANSI/AAMI Std. ES60601-1
Cert. to CSA Std. C22.2 No. 60601-1

ETL Recognized Component mark for Canada and United States



C/N 9901916

Conforms to ANSI/AAMI Std. ES60601-1
Cert. to CSA Std. C22.2 No. 60601-1

ETL Recognized Component mark for Canada and United States



C/N 4008671

Conforms to UL962
Cert. to CSA Std. C22.2 No. 68-09

ETL Recognized Component mark for Canada and United States

Products



DPG1K

- Up/down drive

DPG1M

- Up/down drive
- 2 memory positions
- LED diode reminder
- Bluetooth®

DPG1B

- Up/down drive
- 2 memory positions
- Light strip reminder
- Bluetooth®

DPG1C

- Up/down drive
- 4 memory positions
- Light strip reminder
- Bluetooth®
- Display



Desk Control Apps

- Up and down drive (if supported by the connected product)
- Displays actual height
- Displays error codes and links to LINAK website support
- Up to 4 memory positions
- Tracks usage of the desk
- Reminder notifications to get standing
- Possibility to enable automatic drive on memory positions (if supported by the connected product)
- Works via Bluetooth® Low Energy Technology
- Available in English, German, French, Spanish, Italian, Korean, Chinese and Japanese

Operation of the DPG series:

The desk panel is operated by tilting; Tilt and hold the DPG up to make the desk drive up, press and hold the DPG down to make the desk drive down. Release the DPG when you have reached your requested position.

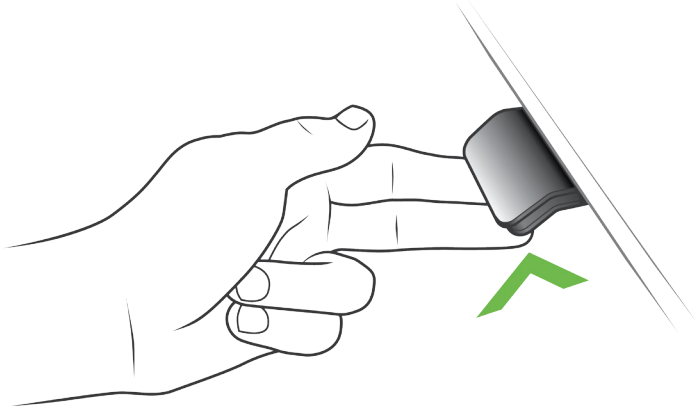

Figure 1: Tilt and hold the DPG1K to make the desk drive up

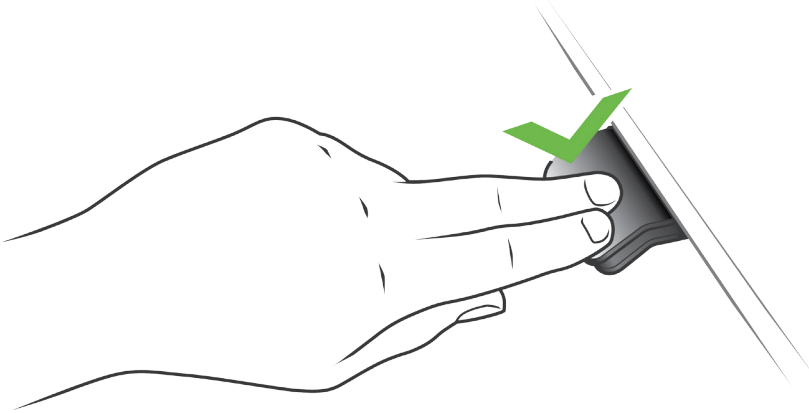

Figure 2: Press and hold the DPG1K to make the desk drive down

Operation of the DPG1M

Storing the memory positions

Memory positions

The DPG1M has a "store memory" button to the right symbolised with a star.

Adjust the desk to a preferred position and press the "Star"-button for 2 seconds. The LED will now blink white two times to indicate that saving the position is in progress. When the LED becomes static white, the position is saved. If the user adjusts the desk to another position and saves the position, it will overwrite the memory position closest to the current position.

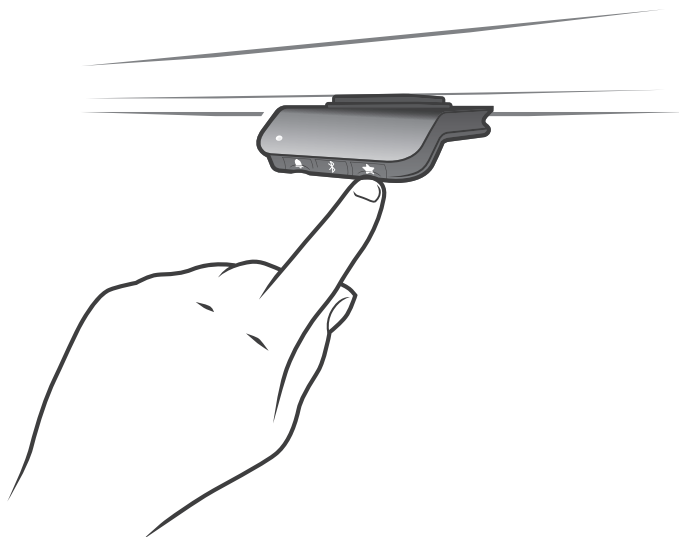

Driving to memory positions

After storing the memory positions, the positions can be reached simply by tilting the DPG1M. Tilt and hold - when a stored position is reached, the desk stops. This way the user can easily change between sitting and standing position without looking at the DPG1M in the meantime. The DPG1M will stop at all stored memory positions. When the desk stops at a memory position, the user can continue to tilt the DPG1M for 1 second and the desk will move past the memory position and continue in the direction of the tilt. Furthermore, when the desk stops at a memory position, the user can release the DPG and tilt again immediately to move past a memory position.

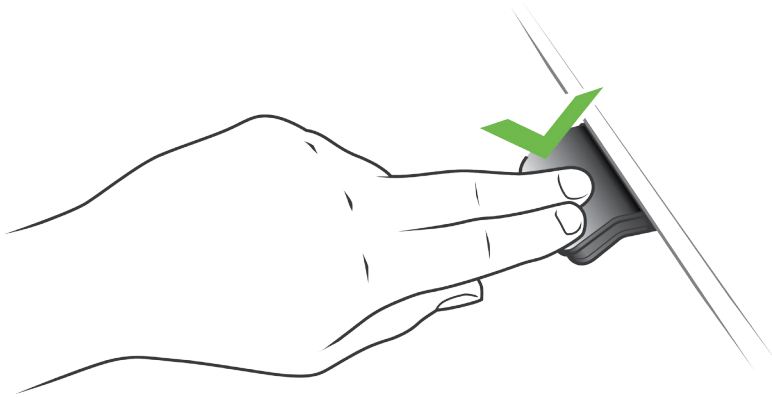

Driving to memory positions (Automatic drive enabled, only possible for "Full version")

After storing the memory positions, the positions can be reached simply by tilting the DPG1M. Double tap on the DPG1M to let the desk adjust automatically to the first position in the direction of the double tap. Simply tap the DPG again to stop the driving of the desk.



Figure 3: Double tap to adjust the desk to a memory position automatically

Erase memory positions

Pressing the "Memory" button for 8 seconds will erase all saved memory positions. The LED will blink red to indicate when the action is completed.



Connecting Bluetooth®

Pressing the Bluetooth® button in the middle for 2 seconds will enable pairing mode. A blue blinking light in the LED indicates this.

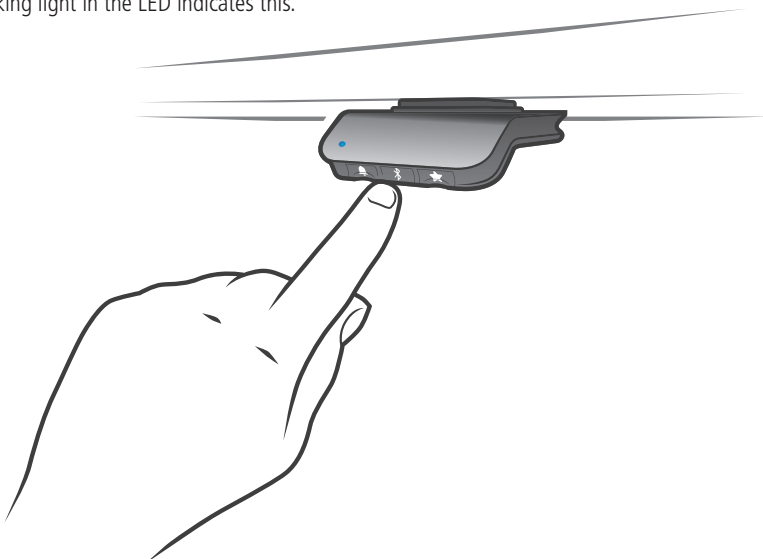

Download the Desk Control App suited for your device in App, Google Play or Windows store and pair the app and device.

Reminder

Setting the reminder interval

The DPG1M has a "Reminder" button to the left symbolised with a bell. Pressing this button will adjust the interval of how often to get reminders to change position. The LED will light up in 3 different intensities which each represents an interval and the 3 standards are:

- Interval 1: Reminder after 55 minutes sitting
- Interval 2: Reminder after 50 minutes sitting
- Interval 3: Reminder after 45 minutes sitting

The default interval chosen is reminding after 55 mins, which means the LED will be lit up white in the weakest intensity. Simply toggle through the intervals by pressing the bell button and notice the light intensity change. When the LED is not lit up, the reminder is turned off.

Through the apps, it is possible to personalise the three intervals to custom values.

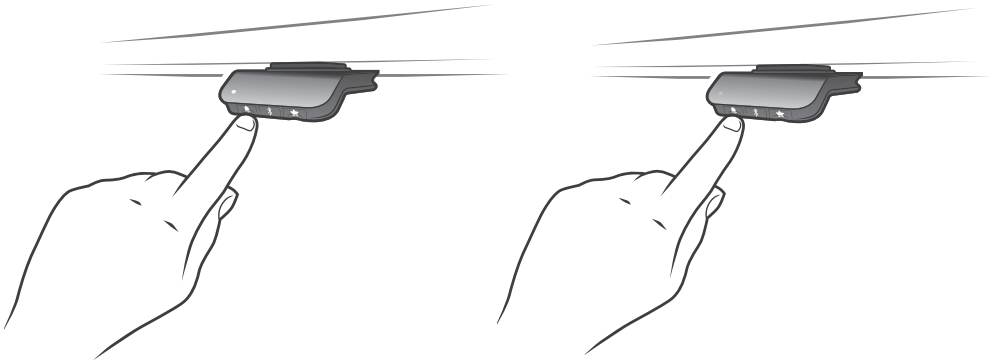

Setting reminder interval.

Reminder off

Reminder reset

It is possible to reset the reminder to default values by pressing the "bell" symbol for 8 seconds. The LED will blink red to indicate when the action is completed.

LED reminder

The LED is placed in the lower left corner of the DPG1M. The LED is intended to indicate the status of the desk user. The status depends on the reminder interval chosen. When the user is in position in an appropriate amount of time according to the interval, the LED calmly pulsates green. When the sitting interval runs out, the calm pulsating green turns into fast pulsating orange for 1 min hereafter static orange – this is an indication to the user to adjust the desk to standing height. In standing height, the LED will pulsate green until a potential time out. When the desk is adjusted back to sitting position, the LED will pulsate green until the reminder goes off again.

After 4 hours without any action, the LED will time out. When the DPG1M is tilted, the green light will come back on.



Please be aware; When the LED is enabled for reminders, the DPG1M is no longer in ZERO mode as long as the light is on/active.



Figure 4: Pulsating green LED indicates everything is okay



Figure 5: Pulsating orange LED indicates the user needs to change position

Factory reset

Pressing and holding the “Memory” and “Reminder” for 8 seconds will set the DPG1M to factory default. The LED will flash red 3 times.

Operation of the DPG1B/C

The desk panel is operated by tilting; Tilt and hold the DPG up to make the desk drive up, press and hold the DPG down to make the desk drive down. Release the DPG, when you have reached your requested position.

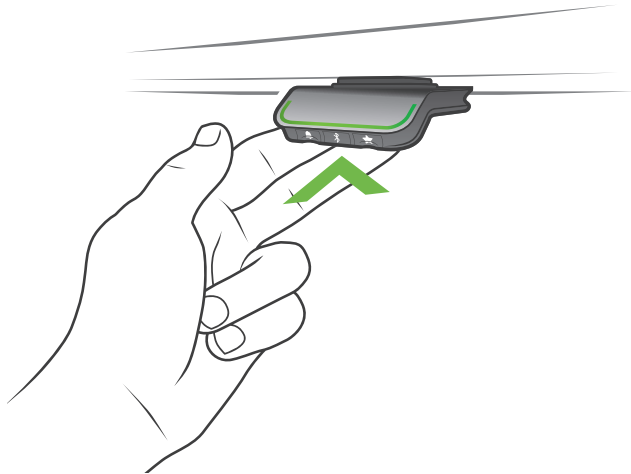

Figure 1: Tilt and hold the DPG to make the desk drive up

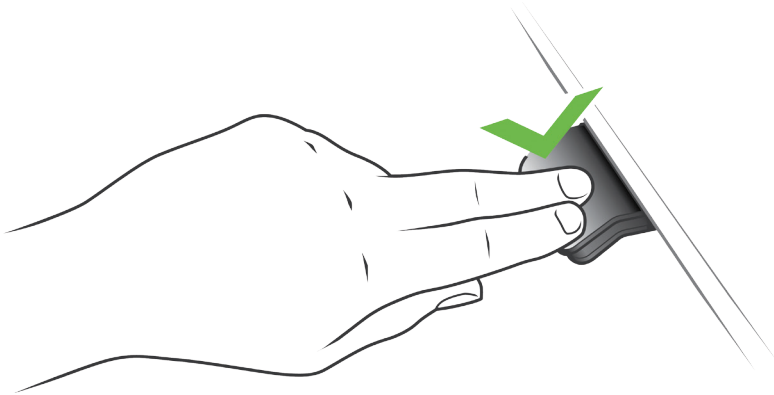

Figure 2: Press and hold the DPG to make the desk drive down

Storing the memory positions

Memory positions 1 and 2

The DPG1B/C have a "store memory" button to the right symbolised with a star.

Adjust the desk to a preferred position and press the "Star"-button for 2 seconds. The light strip will now blink white two times to indicate that saving the position is in progress. When the light strip becomes static white, the position is saved. In the DPG1C: The display will indicate the saved position with a star and a number of the position. The number inside the star is according to in which order the positions are saved; First position saved; A star with a "1" inside. This is how to save the 2 memory positions "1" and "2". If the user adjusts the desk to another position and saves the position, it will overwrite the memory position 1 or 2 closest to the current position.

DPG1C: Memory positions 3 and 4

The DPG1C features 4 memory positions. Pressing the "Star" shortly will make the display show the 4 memory positions: A "star" with the number next to it. Now the user can toggle through these 4 memory positions in the display and choose which one to save the current position as. E.g. a user wants to store the current position as memory 3: Press the "star"-button and toggle to the "star" with "3" next to it. Now use the same storing procedure as described above: Press the star for 2 seconds and the memory position is saved.

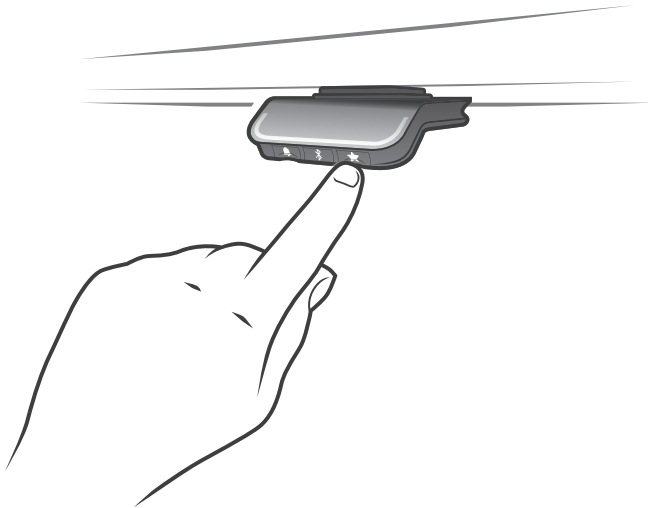

Driving to memory positions

After storing the memory positions, the positions can be reached simply by tilting the DPG. Tilt and hold - when a stored position is reached, the desk stops. This way the user can easily change between sitting and standing position without looking at the DPG in the meantime. While driving the display in the DPG1C will show the height of the desk. When a position is reached, this will be indicated in the display by the star and the memory number.

The DPG will stop at all stored memory positions, which means up to 4 different positions (in DPG1C) during the stroke length of the desk. When the desk stops at a memory position, the user can continue to tilt the DPG for 1 second and the desk will move past the memory position and continue in the direction of the tilt. Furthermore, when the desk stops at a memory position, the user can release the DPG and tilt again immediately to move past a memory position.

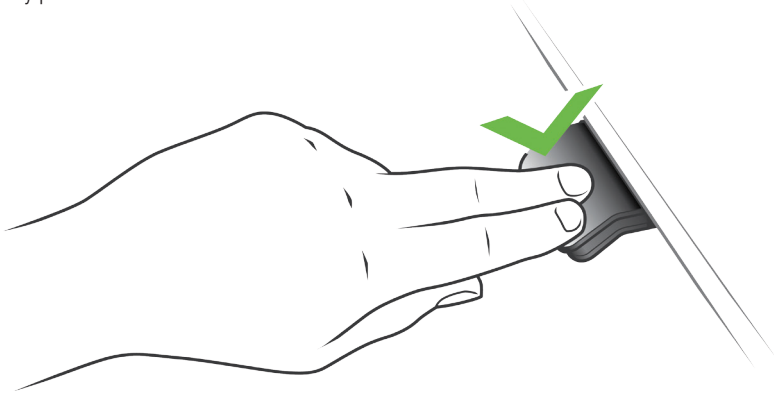

Driving to memory positions (Automatic drive enabled, only possible for "Full version")

After storing the memory positions, the positions can be reached simply by tilting the DPG. Double tap on the DPG to let the desk adjust automatically to the first position in the direction of the double tap. Simply tap the DPG again to stop the driving of the desk.

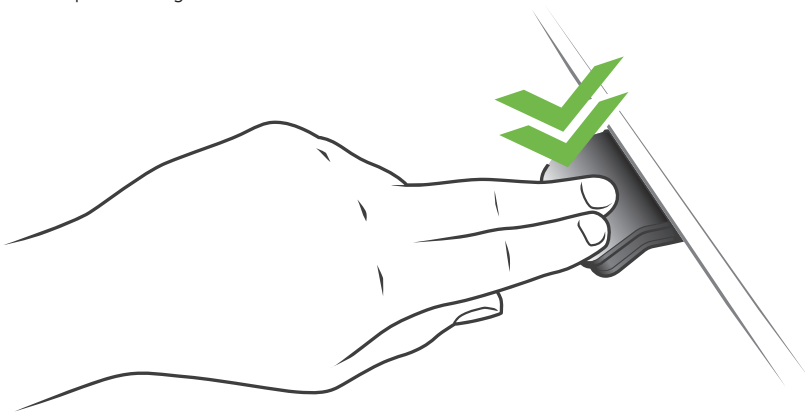

Figure 3: Double tap to adjust the desk to a memory position automatically

Erase memory positions

Pressing the "Memory" button for 8 seconds will erase all saved memory positions. In the DPG1C: The display will make a countdown and the light strip will blink red to indicate when the action is completed.



Connecting Bluetooth®

Pressing the Bluetooth® button in the middle for 2 seconds will enable pairing mode. A blue blinking light in the light strip indicates this.

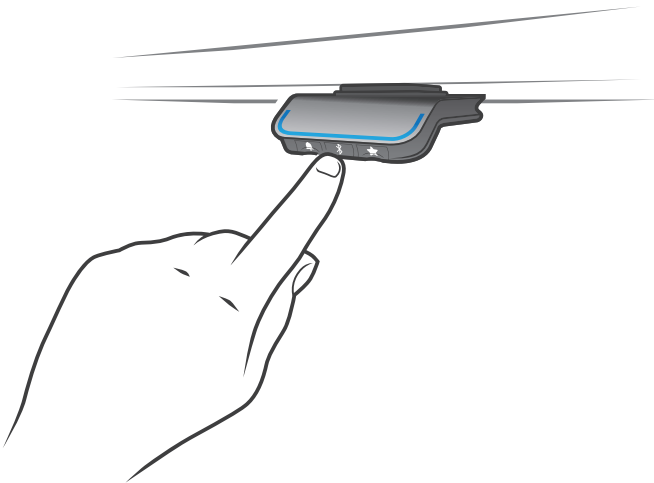

Download the Desk Control App suited for your device in App, Google Play or Windows store and pair the app and device

The display on the DPG1C will inform about the Bluetooth-ID of the desk, which is "DESK" followed by a 4-digit number – look for this ID in the list of "Desks nearby".

Reminder

Setting the reminder interval

The DPG has a "Reminder" button to the left symbolised with a bell. Pressing this button will adjust the interval of how often to get reminders to change position. Each white block represents an interval and the 3 standards are:

- Interval 1: Reminder after 55 minutes sitting
- Interval 2: Reminder after 50 minutes sitting
- Interval 3: Reminder after 45 minutes sitting

The default interval chosen is reminding after 55 mins, which means one white block will be lit up. Simply toggle through the intervals by pressing the bell button. When no white blocks are lit up, the reminder is turned off.

Through the apps, it is possible to personalise the three intervals to custom values.

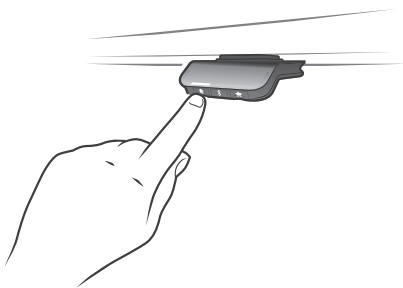

Interval 1: Reminder after 55 minutes sitting

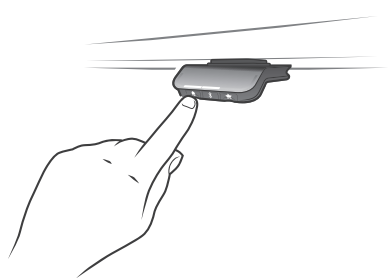

Interval 2: Reminder after 50 minutes sitting

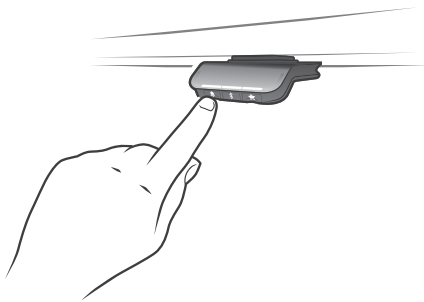

Interval 3: Reminder after 45 minutes sitting

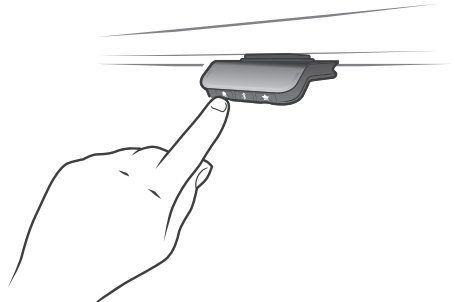

Reminder off

Reminder reset

It is possible to reset the reminder to default values by pressing the "bell" symbol for 8 seconds. The display will make a countdown and the light strip will blink red to indicate when the action is completed.

Light strip reminder

The light strip is a thin line of LED light shining through the surface of the DPG. The light strip is intended to indicate the status of the desk user. The status depends on the reminder interval chosen. When the user is in position in an appropriate amount of time according to the interval, the light strip calmly pulsates green. When the sitting interval runs out, the calm pulsating green turns into fast pulsating orange for 1 min hereafter static orange – this is an indication to the user to adjust the desk to standing height. In standing height, the light strip will pulsate green until a potential time out. When the desk is adjusted back to sitting position, the light strip will pulsate green until the reminder goes off again.

After 4 hours without any action, the light strip will time out. When the DPG is tilted, the green light will come back on.



Please be aware; When the light strip is enabled for reminders, the DPG is no longer in ZERO mode as long as the light is on/active.



Figure 4: Pulsating green light strip indicates everything is okay



Figure 5: Pulsating orange light strip indicates the user needs to change position

Factory reset

Pressing and holding the "Memory" and "Reminder" for 8 seconds will set the DPG to factory default. The light strip will flash red 3 times. In the DPG1C: After 3 seconds of the command, the display will light up: It has an arrow with a countdown [seconds] to the factory reset and it says RESET.

DPG1C

Display

The DPG1C has an OLED display, which shows the height during drive of the desk and many other texts to guide the user.

Adjust initial height of the desk

If the height shown in the display is not correct the height can be adjusted. When pressing the "Reminder" and the "Bluetooth" button on the DPG1C at the same time in 5 seconds; the height in the display starts to blink. When tilting the DPG1C the height in the display changes without moving the desk. Tilt up to increase the height, tilt down to decrease the shown height in the display. Pressing any button will confirm the choice or wait for 10 seconds and the confirmation happens automatically.

Switching between centimetre and inch

Pressing the "Memory" and the "Bluetooth" button on the DPG1C at the same time for 5 seconds; the current measurement unit blinks. When e.g. CM is blinking and the user wants to change to inch; Tilt the DPG once and it now says "Inch" in the display. Pressing any button will confirm the choice or wait for 10 seconds and the confirmation happens automatically.

Error codes

The DPG1C shows error codes in case of errors in the system. The most common errors loop between the error code (EXX) and the cause, check the code below:

| Error codes in CBD6S | Cause |
|----------------------|----------------|
| E01 | INITIALISATION |

Placement of the DPG1K/M:

The drawings below are side views examples on how to position the DPG1K/M according to the edge of the tabletop.

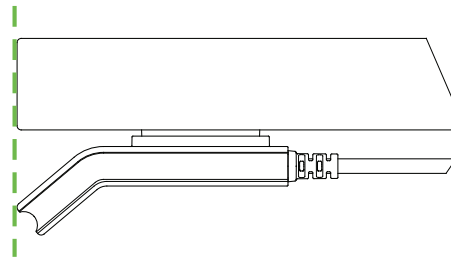
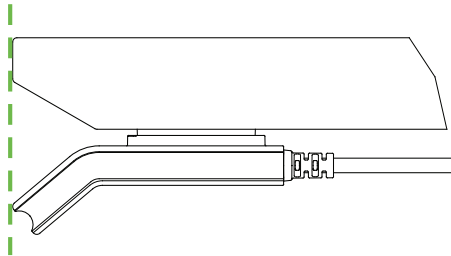
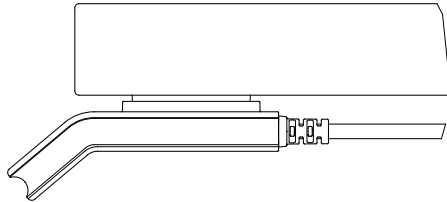

Placement of the DPG1B/C:

The drawings below are side views examples on how to position the DPG1B/C according to the edge of the tabletop. Because of the light strip, we recommend placing the DPG1B/C in a visible position.

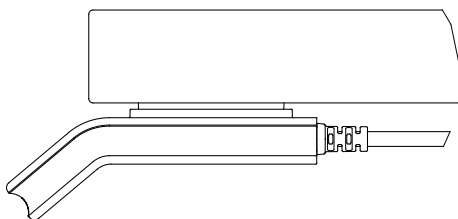
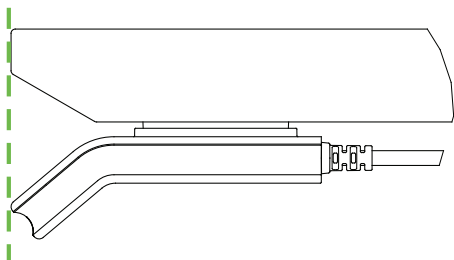

Mounting of the DPG:

When mounting the DPG it is important to ensure that the cable is not tightened, but has free mobility in the first centimetres from the housing. We recommend attaching the cable to the tabletop with a clip as shown on the picture below:

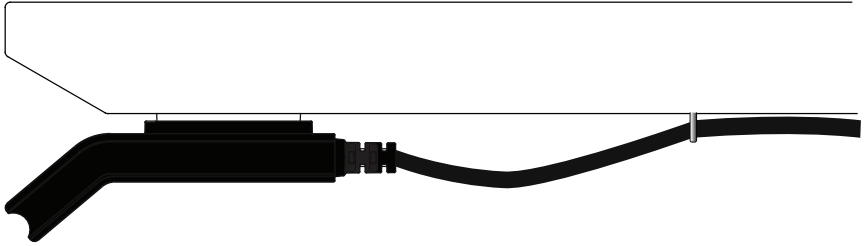

When mounting the DPG to the tabletop screws with following spec must be used:

- Ø4.5 mm
- 90° countersink screw



Do not use screws with a milling head as this will cut into the housing of the DPG.

The screws must be fastened sufficiently, without overtightening the screws. It is not possible to mention a specific torque, as this depends on the type of screw, material of tabletop and whether there are predrilled holes or not.

We recommend predrilling the holes for the DPG to ensure the same aligned position for every desk.

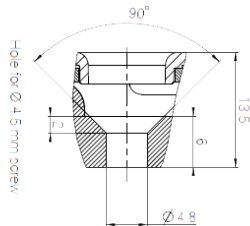

Figure 6: Cross-sectional view of the DPG screw hole

Preparing the tabletop for both DPG sizes (DPG1K/M and DPG1B/C)

The DPG series consists of 4 different desk panels in 2 different sizes. The DPG1K and DPG1M are the same size and the DPG1B and the DPG1C are the same size.

The two sizes share one hole in the hole pattern, which means 3 predrilled holes in the tabletop will make it possible to mount both sizes of the DPG and all 4 versions.

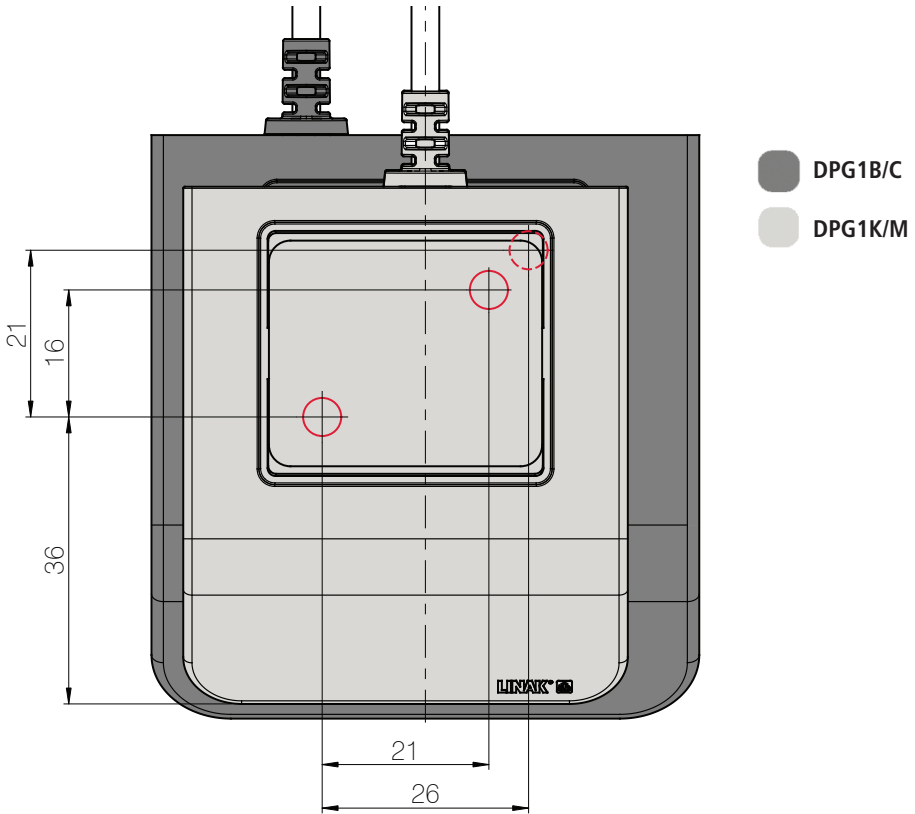
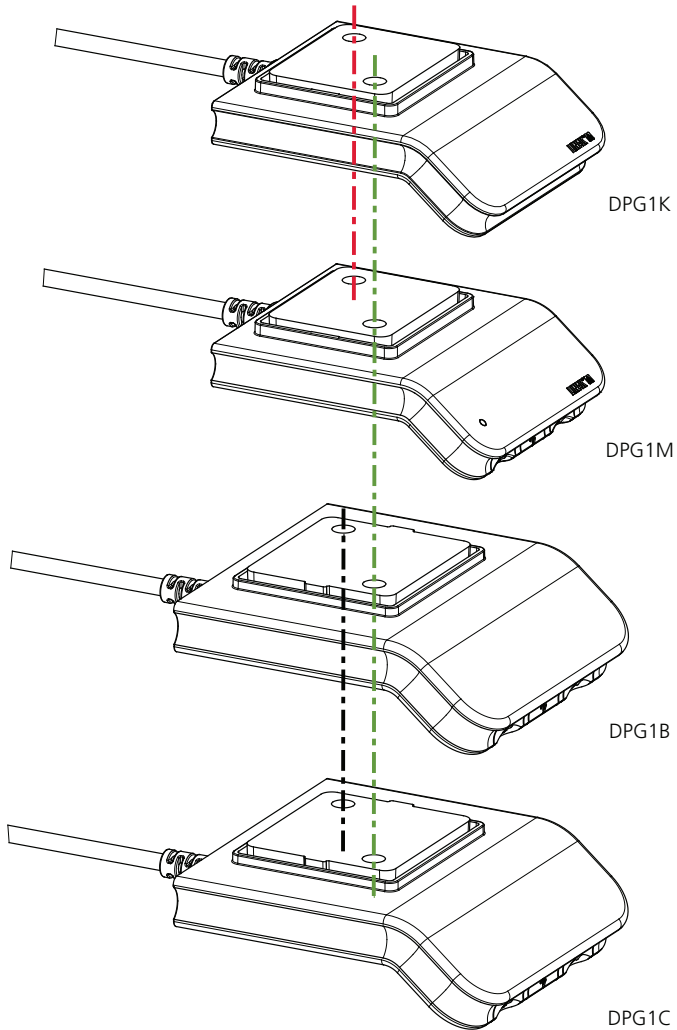

Figure 7: Hole pattern of the DPG sizes. The dashed line is the second hole of the DPG1B/C

The front hole of all 4 DPG variants are shared; Here indicated by the green line.
As the DPG1K and DPG1M are the same size, they share the hole indicated by the red line.
As the DPG1B and DPG1C are the same size, they share the hole indicated by the black line.



Bluetooth® Adapter

The Bluetooth® Adapter allows you to adjust your LINAK product wirelessly from the Desk Control App. Simply plug the Bluetooth® Adapter in your DESKLINE® control box and download the app: Your application can now be adjusted via your smartphone or tablet.

The Bluetooth® Adapter is a very compact unit requiring a minimum of space. No mounting is needed, just plug in the adapter and you are ready.

Usage:

- Compatible with:
 - DESKLINE control boxes CBD6S and CBD4A (Only with SW 77432 or 77474)
- Compatible with Desk Control Apps
- Ambient temperature: +5°C to +40°C
- Storage and transport temperature: -10°C to +50°C
- Complies with FCC ID (PART 15C) and IC (RSS247)



How to put the adapter in pairing mode

1. Plug the Bluetooth® adapter into a powered DESKLINE Control Box

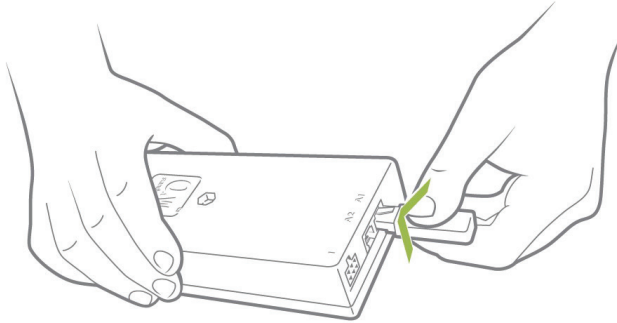

2. The Adapter is now in pairing mode. The pairing mode will last 3 minutes and is indicated by a blue flashing LED through the transparent plastic.

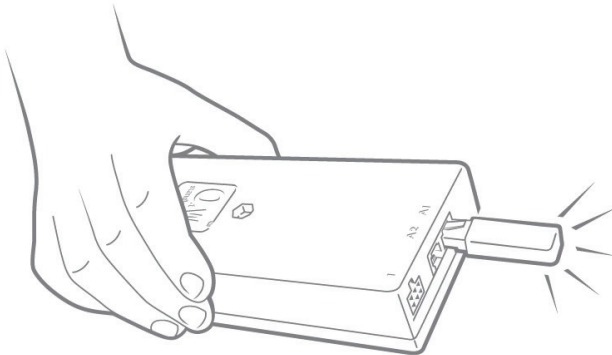

The adapter will be in pairing mode for 30 seconds every time, you make a short activation of your DESKLINE application.

Download the software you want in App Store or Google Play store and follow the instructions in the programs.

When searching; All devices will be called BLE2LIN followed by a 4-digit number.

Desk Control

Desk Control is an app developed for users of sit/stand desks. The app allows the user to connect to the desk via Bluetooth® and will now motivate to use the desk efficiently. The app tracks the usage of the desk shown and helps the users reach their daily goal by sending reminder notifications on the smart device. By downloading the "Desk Control" app, the desk user comes one step closer to changing the prolonged sitting behaviour and the user gets the friendly reminder needed to build a healthy routine during the workday.

The app is available for 4 different platforms: iOS for iPhones and iPads, Android for Android smartphones and tablets, MacOS for MAC computers and Windows for PCs.



Downloading the App

The apps are called "Desk Control" and have the following app logo in iTunes, Apple App store, Google Play store and Windows store:



How to download the App for iOS

- Step 1:** Use your Apple device to log into App store
- Step 2:** Type "Desk Control" in the search column
- Step 3:** Select the "Desk Control" app
- Step 4:** Click install to download the app to your device

How to download the App for Android

- Step 1:** Use your Android device to log into Google Play Store
- Step 2:** Type "Desk Control" in the search column
- Step 3:** Select the "Desk Control" app
- Step 4:** Click install to download the app to your device

How to download the App for MacOS:

- Step 1:** Use your MAC to log into iTunes store
- Step 2:** Type "Desk Control" in the search column
- Step 3:** Select the "Desk Control" app
- Step 4:** Click install to download the app to your device

How to download the App for Windows computers:

- Step 1:** Use your PC to log into Windows store
- Step 2:** Type "Desk Control" in the search column
- Step 3:** Select the "Desk Control" app
- Step 4:** Click install to download the app to your device

Onboarding flow

The first time you start the Desk Control app; An onboarding flow will show to guide the user to the first-time use of the app.

The two main purposes of the onboarding flow is to inform the user of the benefits of changing posture during the workday and get the connection between the app and the device established. Pressing "connect to your desk" on the below screen will lead to the "Pairing Bluetooth®" guide.

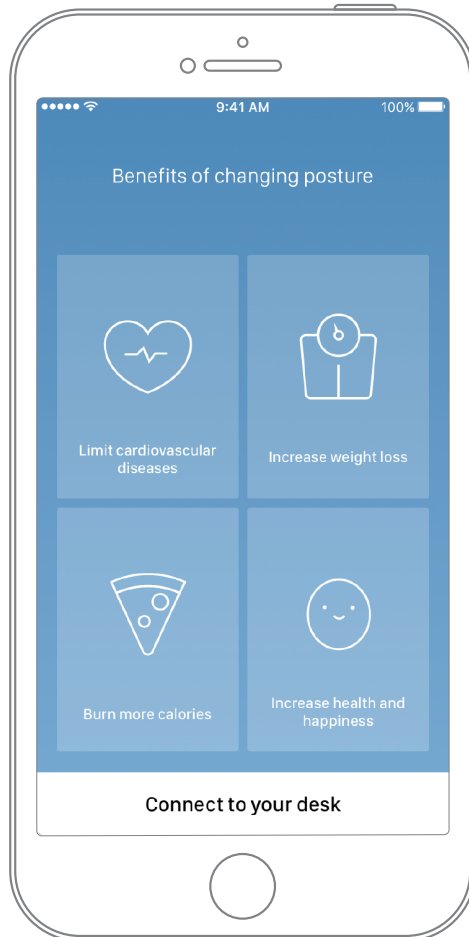

Pairing Bluetooth®

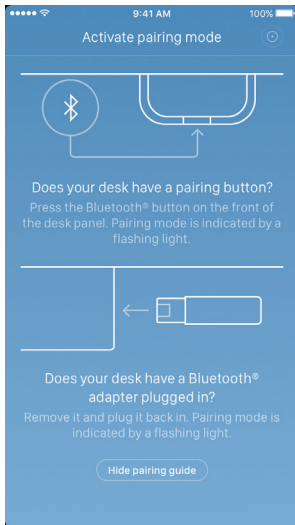

To get a functional app, you must have the LINAK Bluetooth® Adapter or desk panel with integrated Bluetooth® such as DPG1M, DPG1B or DPG1C. The screen to the left informs the user how to get the product they received in pairing mode.

The Bluetooth® Adapter must be plugged into the DESKLINE® control box and it will blink blue and be in pairing mode for 3 minutes.

To set a DPG1M/B/C in pairing mode, the Bluetooth® button in the front of the desk panel must be pressed for 2 seconds and the light strip or light LED will blink blue to indicate that it is in pairing mode.

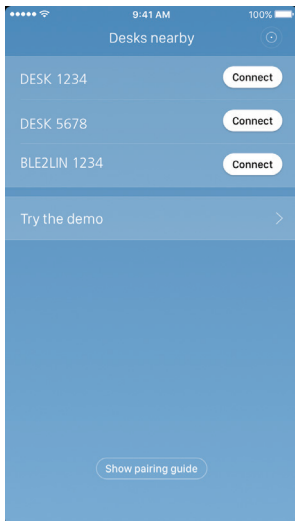

When pressing "Hide pairing guide" the screen with the list of devices in pairing mode will appear. Press the "connect" button to the right of the device to pair.

All Bluetooth® Adapters Bluetooth® IDs are named BLE2LIN followed by a 4-digit number.

All DPG desk panel Bluetooth® IDs are named DESK followed by a 4 digit-number.

Demo: By selecting "Try the demo", you will get access to explore the functionality of the Desk Control App but without connection to a product.

After pressing the "connect" button and the connection has been established successfully, the user will be lead to the "Control" page of the app.

The following question pops up on the screen, which the user have to answer.

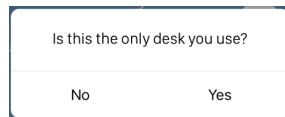

If the user only uses one desk with this app; Press yes
If the user uses this app for multiple desk; Press no

How to use the app

The Desk Control App consists of 3 different tabs to navigate between; "Control", "You" and "Settings"



Control

Adjustment of the desk (if supported by connected device)



You

Statistics of the usage of the desk



Settings

All settings

Control

This is the landing page after the Bluetooth® connection is established. The functionality of the control page depends on the product to which app is connected. The screen below is when the app is connected to a "full version" of a DPG or Bluetooth® Adapter. When the connection is with a "Limited version" of the DPG or Bluetooth® Adapter; The adjustment of the desk through the app will not be possible and the memory positions will only be for saving the positions not adjusting to them via the app. The graphics will adjust to the possibilities.

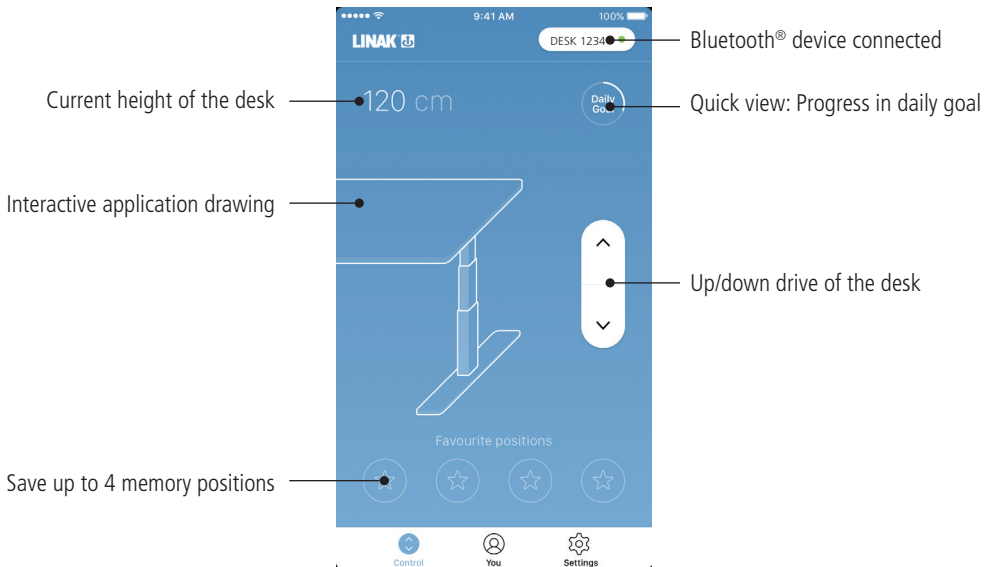

Up/down drive

Moves the application upwards/downwards while pressing and holding the button.

Bluetooth® device

Leads back to "Desks nearby" and lets the user connect to another product in pairing mode

You

"You" is the page for setting the daily goal of standing at the desk.

The first time you press the "You"-tab will require following input:

- Choose a goal of sitting and standing. Choose a predefined one or customise it by pressing the symbol to the right.
- Choose if the smart device should remind via pop-up notifications when it is time to change position
- Type in height and weight of the user to calculate the calories burned.

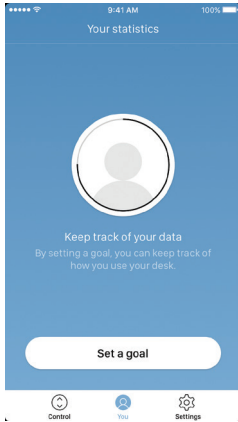

First time setup view

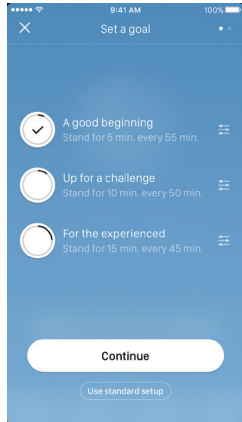

Choose the sit/stand interval

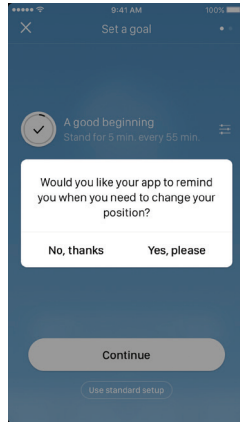

Choose to have reminder notifications

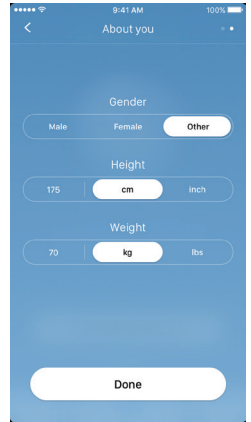

Type user data in

With these input given the statistics page is ready for use, see the screen below for features:

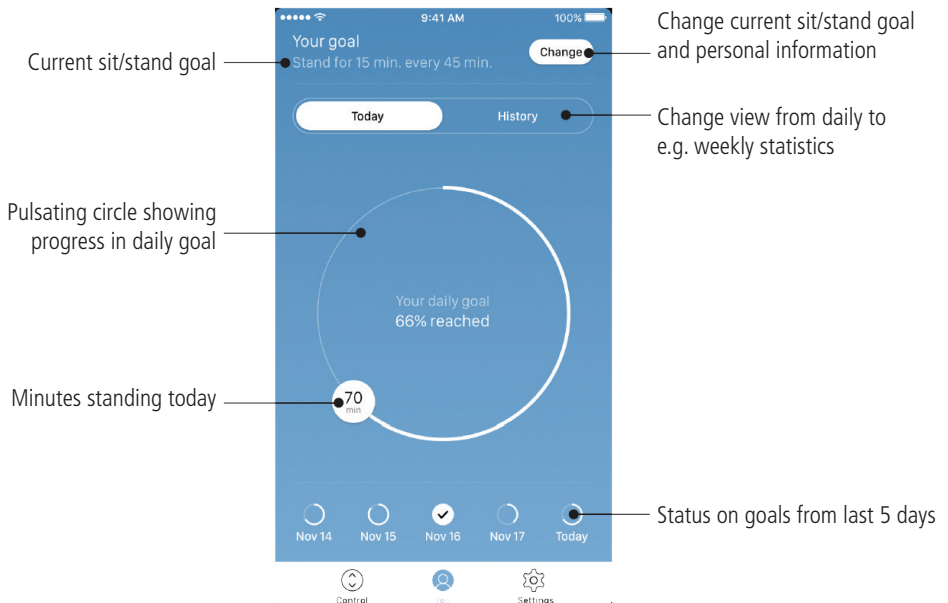

History

When sliding the slider from “Today” to “History”, the complete statistic of the app will be shown. The bars show the statistics according to the horizontal line, which represents the goal. It is possible to get daily, weekly, monthly and yearly views by using the slider below the graphs. When mousing over on computers or pressing the bar on phones, a small window will inform about the amount of standing time and the corresponding calories for the chosen period.

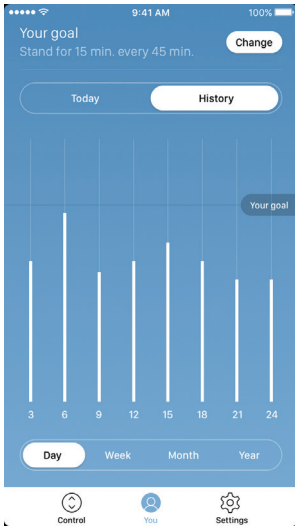

Daily view: Hourly divided

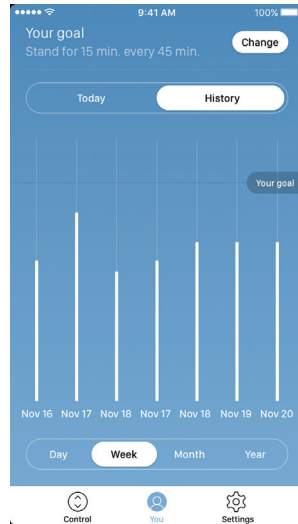

Weekly view: Daily divided

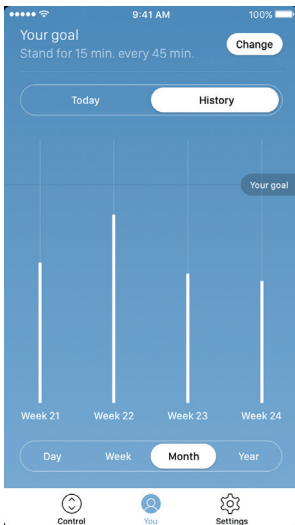

Monthly view: Weekly divided

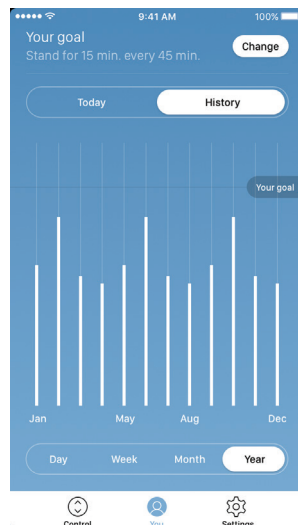

Yearly view: Monthly divided

Settings

Pressing the “Settings” will provide a list of choices:

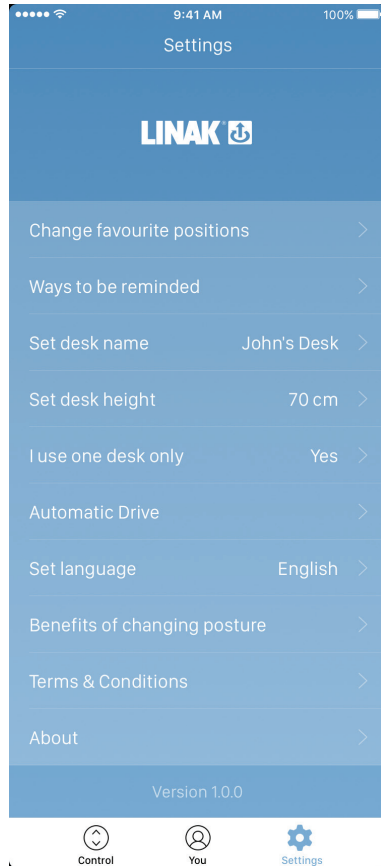

Change the favourite positions

The favourite positions are stored through the control page. If the user wants to change the height of the stored positions, it can be done through this menu.

Ways to be reminded

Enable or disable reminder notifications as pop-ups on computers and smartphones.

If supported by the connected product, e.g. the DPG1B, enable or disable the light strip as a reminder function.

Set desk name

Change the name of the connected product. The renaming will only affect the local name in the smartphone or computer - not in the DPG or Bluetooth® Adapter.

Set desk height

Set the current height of the desk. An illustration guides the user on how to measure. Choose in which units the height is shown: cm or inches.

I use one desk only

Choose between “Yes” or “No”.

Yes: This is the only desk, you use and to which you connect your app. Your reminder and memory settings are stored in the DPG on the desk.

No: You connect to several desks. Your reminder and memory settings are stored on your smart device and when you connect to a desk, the settings will reflect in the DPG. When you are no longer connected, the DPG will go back to the settings it had before you connected after 2 hours

Automatic drive

Enable automatic drive on memory positions. The user has to accept the terms in the pop-up, before this feature can be enabled. This feature can only be enabled in the “full versions” of the DPG1M/B/C and BLE2LIN, not the “limited versions”. An animation shows the user how this feature works.

Set language

Choose between 8 different languages in the app. This change does not affect the language in the display of a DPG1C.

Benefits of changing posture

An overview of some of the benefits by using a sit/stand desk and changing posture.

Terms & conditions

Terms & conditions for using the Desk Control app.

About

Use your desk

Link to “Made to Move”; Get guidance on how to use a sit/stand desk correctly.

Product information

Link to LINAK website with information about this app.

Support

Link to LINAK website with troubleshooting videos on the DPG products.

Reminder notifications

When reminder notifications are enabled on the smart device, pop-ups will occur to help guide the user when there is a need to change position. Below are examples on the notifications that will pop up on your screen when it is time to adjust your desk again. The reminders will appear based on your settings. Remember that the program goes in standby mode if you do not use your computer and therefore it will not remind you until you start using your computer again.

The notification will tell the user to change position. There are 3 notification options:

- Snooze the reminder: The notification will pop up one hour later.
- Disable reminders for today: The notifications will stop for the day, but they will be enabled again the next day.
- Open app: Opens the app allowing the user to adjust the desk. (If supported by the connected product)

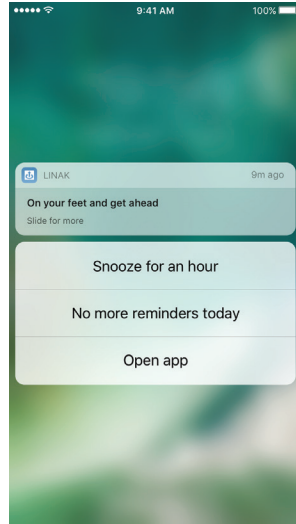
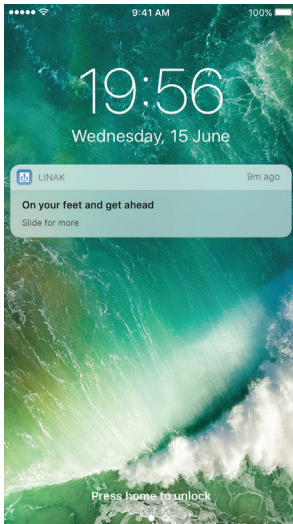

Recommendations on how to use Desk Control

Overriding a learned sedentary behaviour is a true behavioural challenge. We have put together a guide for how to break up with your chair during your workday.

How to vary between standing and sitting while your work

The most important thing is to vary your position and to move around, preferably three times an hour. Instead of sitting for too long at a time, you can switch between standing and sitting position. Remember good posture and to stand with your body weight evenly distributed on both legs.

- Start by raising your desk and standing for 15 minutes each hour before you go to lunch.
- Raise your desk just before your lunch break. Then your desk will be in the right position when you get back from lunch.
- Just after lunch, stand for 15 minutes before lowering your desk to sit for 45 minutes.
- Raise your desk again every hour, so that you stand up working for 15 minutes each hour for the rest of the day.
- Raise your desk before you leave for the day – then it is ready for the next day.

Important reservations when varying between standing and sitting position:

If you are pregnant, have varicose veins or have a health condition that may prevent you from standing for 5-15 minutes at a time every hour, you should contact your doctor to make sure that this will not be detrimental to your health.

Disposal of LINAK's products

As LINAK's customers often ask us how our products can be disposed of or scrapped we have prepared this guidance that enables a classification to different waste fractions for recycling or combustion.

Guidance

We recommend that our products be disassembled as much as possible and divided into different waste groups for recycling or combustion.

For example, waste can be sorted into metals, plastics, cable scrap, combustible material and recoverable resources.

Some of these main groups can be further divided into subgroups; e.g. metal can be divided into steel/aluminium/copper and plastic can be divided into ABS/PA/PE/PP.

As an example, the table below breaks down the different components in LINAK products to various recycling groups:

| Product | Components | Recycling group |
|-------------------------|---------------------------------------|---|
| Handset/Control: | Plastic housing Cable PCB board | Plastic recycling or combustion Cable scrap or combustion Electronics scrap |

By now, almost all our casted plastic parts are supplied with an interior code for plastic type and fibre contents, if any.

Main groups of disposal

| Product main groups | Metal scrap | Cable scrap | Electronics scrap | Plastic recycling or combustion | Comments |
|---------------------------|-------------|-------------|-------------------|---------------------------------|----------|
| Desk Control App | | | | | |
| Bluetooth® Adapter | | | X | X | |
| DPG | | X | X | X | |

Disposal of batteries

"Details regarding safe disposal of used and leaking batteries:

Batteries should be disposed in accordance with appropriate federal, state and local regulations. LINAK recommends that used or leaking batteries are disposed through local recycling system. Please do not throw used or leaking batteries in normal household waste or in nature. This will cause damage to the environment.

How to deal with leaking batteries

Leaking batteries should be disposed as described above.

If leaking batteries are discovered in the product, the batteries must be removed at once to minimise damage to the product.

If leaking batteries are left in the product, it become defective.

It is recommended to use plastic gloves when handling leaking batteries. The contents of a leaking batteries can cause chemical burns and respiratory irritation.

If exposed to the contents of a leaking battery, please wash with soap and water. If irritation persists, please seek medical attention. In case of eye contact, please flush eyes thoroughly with water for 15 minutes and seek medical attention."

DRAWING APPENDIX

DPG1K

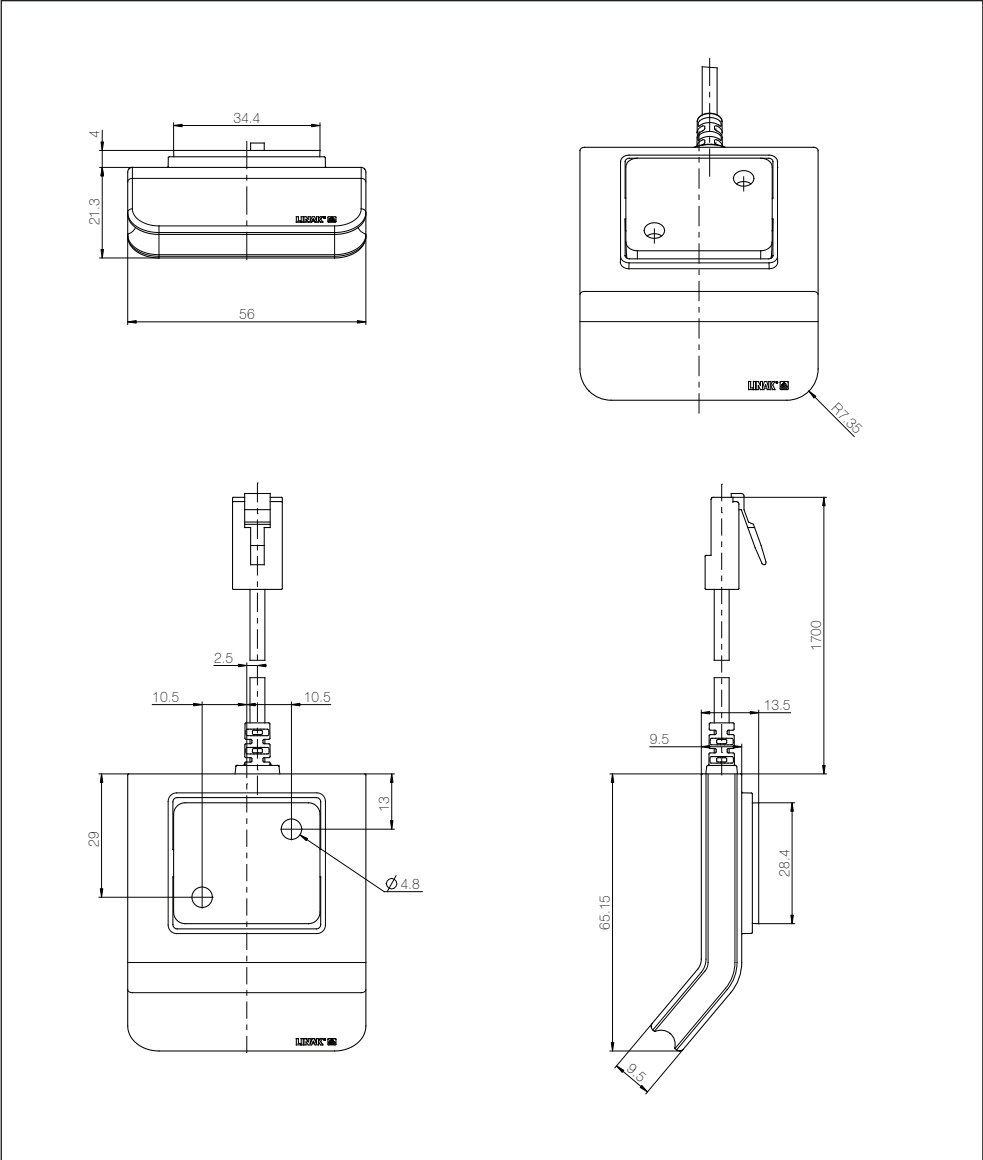

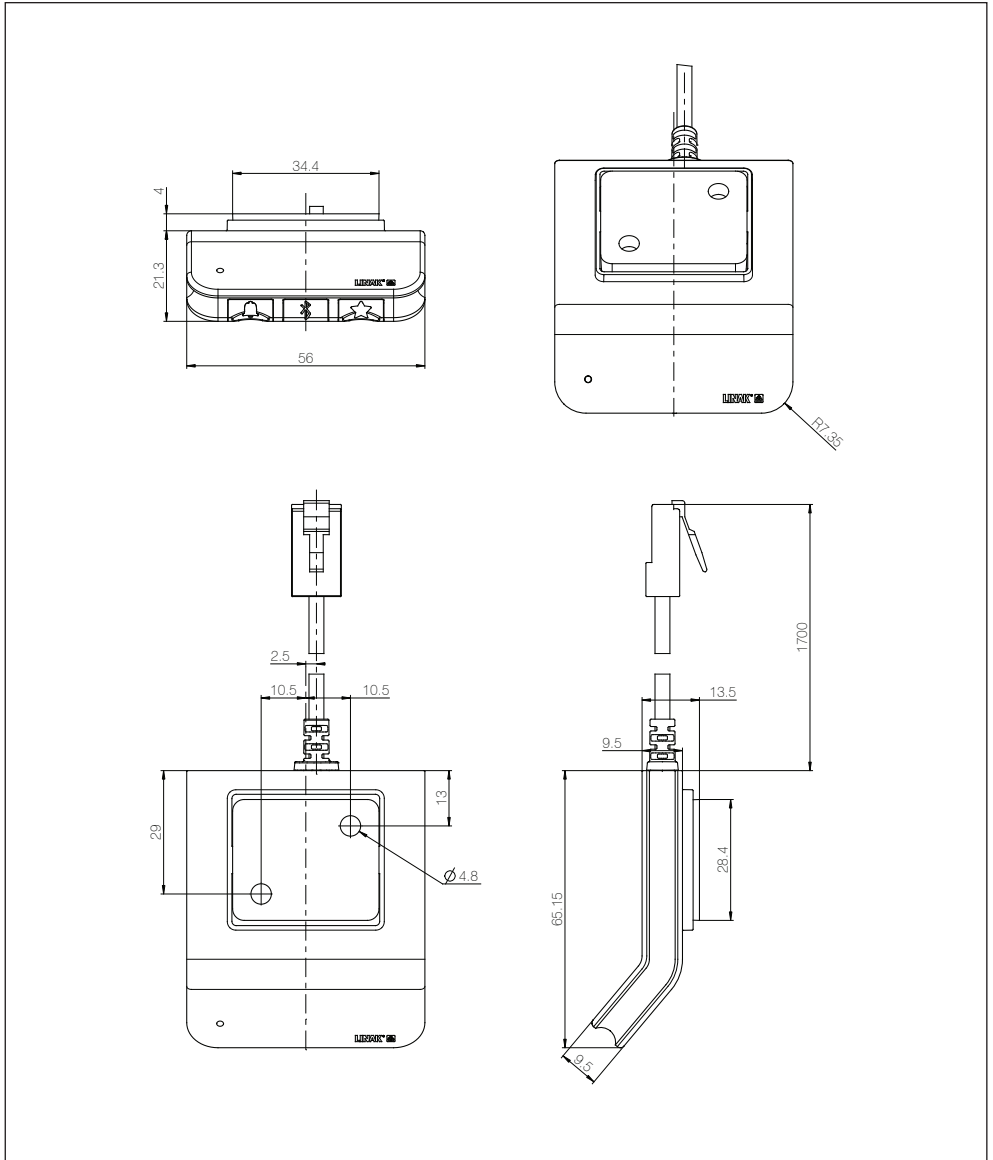

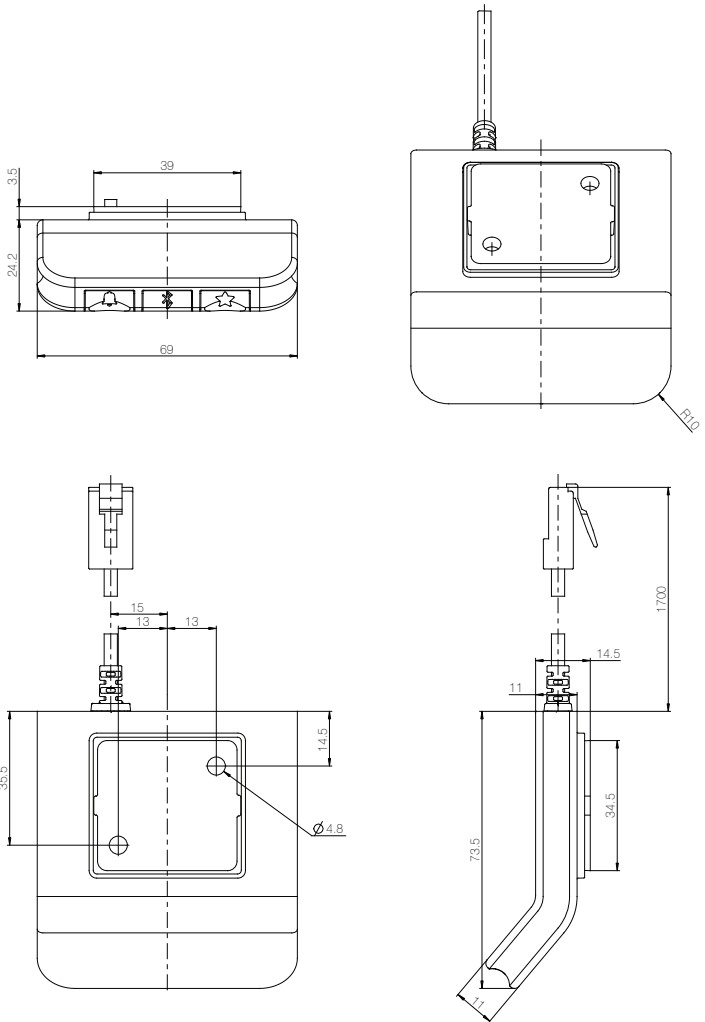

Bluetooth® Adapter

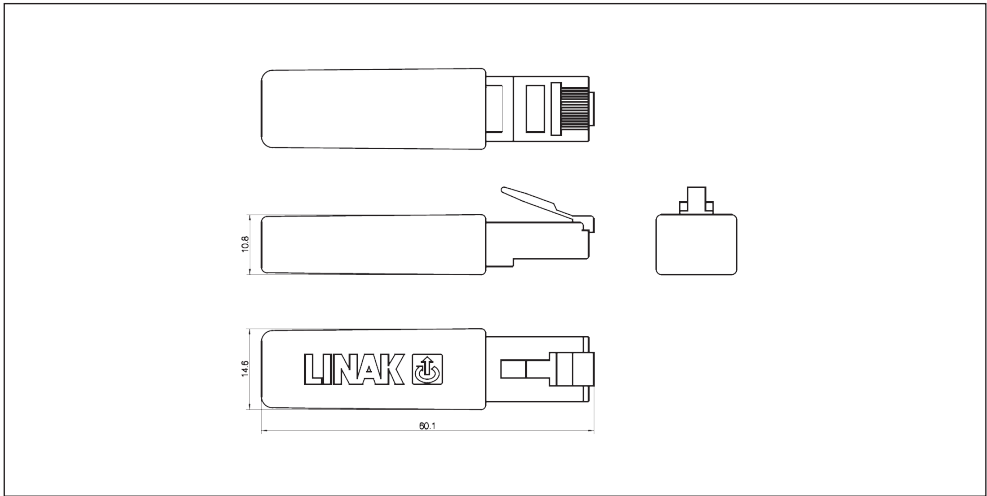

Labels

DPG1B



DPG1C



DPG1M



Bluetooth® Adapter

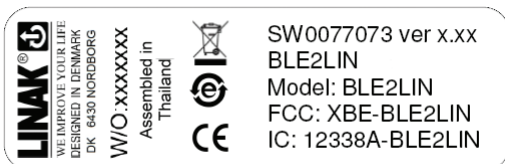

LINAK APPLICATION POLICY

The purpose of the application policy is to define areas of responsibilities in relation to applying a LINAK product defined as hardware, software, technical advice, etc. related to an existing or new customer application.

LINAK products as defined above are applicable for a wide range of applications within the Medical, Furniture, Desk and Industry areas. Yet, LINAK cannot know all the conditions under which LINAK products will be installed, used, and operated, as each individual application is unique.

The suitability and functionality of the LINAK product and its performance under varying conditions (application, vibration, load, humidity, temperature, frequency, etc.) can only be verified by testing, and shall ultimately be the responsibility of the LINAK customer using any LINAK product.

LINAK shall be responsible solely that the LINAK products comply with the specifications set out by LINAK and it shall be the responsibility of the LINAK customer to ensure that the specific LINAK product can be used for the application in question.



iPod touch, iPhone, and iPad are trademarks of Apple Inc., registered in the U.S. and other countries.

"Made for iPod touch", "Made for iPhone," and "Made for iPad" mean that an electronic accessory has been designed to connect specifically to iPod touch, iPhone, or iPad, respectively, and has been certified by the developer to meet Apple performance standards. Apple is not responsible for the operation of this device or its compliance with safety and regulatory standards. Please note that the use of this accessory with iPod touch, iPhone or iPad may affect wireless performance.

The Bluetooth word mark and logos are owned by the Bluetooth SIG, Inc. and any use of such marks by Ascion, LLC is under license. Other trademarks and trade names are those of their respective owners.

FACTORIES

CHINA
LINAK (Shenzhen) Actuator Systems, Ltd.
Phone: +86 755 8610 6656
Fax: +86 755 8610 6990
E-mail: sales@linak.cn - www.linak.cn

DENMARK - Group Headquarters
LINAK A/S, Guderup
Phone: +45 73 15 15 15
Fax: +45 74 45 80 48
Fax: +45 73 15 16 13 (Sales)
E-mail: info@linak.com - www.linak.com

SLOVAKIA
LINAK Slovakia s.r.o.
Phone: +421 51 75 63 414
Fax: +421 51 75 63 410
E-mail: jp@linak.sk - www.linak.com

USA
LINAK U.S. Inc.
North and South American Headquarters
Phone: +1 502 253 5595
Fax: +1 502 253 5596
E-mail: info@linak-us.com - www.linak-us.com

SUBSIDIARIES

AUSTRALIA
LINAK Australia Pty. Ltd
Phone: +61 3 8796 9777
Fax: +61 3 8796 9778
E-mail: sales@linak.com.au - www.linak.com.au

AUSTRIA
LINAK Repräsentanz Österreich (Wien)
Phone: +43 (1) 890 7446
Fax: +43 (1) 890 744615
E-mail: info@linak.de - www.linak.at

BELGIUM & LUXEMBOURG
LINAK Actuator-Systems NV/SA
Phone: +32 (0)9 230 01 09
Fax: +32 (0)9 230 88 80
E-mail: beinfo@linak.be - www.linak.be

BRAZIL
LINAK Do Brasil Comércio De Atuadores Ltda.
Phone: +55 (11) 2832 - 7070
Fax: +55 (11) 2832 - 7060
E-mail: info@linak.com.br - www.linak.com.br

CANADA
LINAK Canada Inc.
Phone: +1 502 253 5595
Fax: +1 416-255-7720
E-mail: info@linak.ca - www.linak-us.com

CZECH REPUBLIC
LINAK C&S S.R.O.
Phone: +420581741814
Fax: +420581702452
E-mail: info@linak.cz - www.linak.cz

DENMARK - Sales
LINAK Danmark A/S
Phone: +45 86 80 36 11
Fax: +45 86 82 90 51
E-mail: linak@linak-silkeborg.dk - www.linak.dk

DISTRIBUTORS

ARGENTINA
Novotec Argentina SRL
Phone: 011-4303-8989/8900
Fax: 011-4032-0184
E-mail: info@novotecargentina.com
www.novotecargentina.com

COLOMBIA
MEM Ltda
Phone: +[57] (1) 334-7666
Fax: +[57] (1) 282-1684
E-mail: servicioalcliente@memltda.com
www.mem.net.co

INDIA
Mechatronics Control Equipments India Pvt Ltd
Phone: +91-44-28558484/85
E-mail: bala@mechatronicscontrol.com
www.mechatronicscontrol.com

FINLAND
LINAK OY
Phone: +358 10 841 8700
E-mail: linak@linak.fi - www.linak.fi

FRANCE
LINAK France E.U.R.L
Phone: +33 (0) 2 41 36 34 34
Fax: +33 (0) 2 41 36 35 00
E-mail: linak@linak.fr - www.linak.fr

GERMANY
LINAK GmbH
Phone: +49 6043 9655 0
Fax: +49 6043 9655 60
E-mail: info@linak.de - www.linak.de

INDIA
LINAK A/S India Liaison Office
Phone: +91 120 4734613
Fax: +91 120 4273708
E-mail: info@linak.in - www.linak.in

IRELAND
LINAK UK Limited - Ireland
Phone: +44 (0)121 544 2211
Fax: +44 (0)121 544 2552
+44 (0)796 855 1606 (UK Mobile)
+35 387 634 6554 (Republic Of Ireland Mobile)
E-mail: sales@linak.co.uk - www.linak.co.uk

ITALY
LINAK Italia S.r.L
Phone: +39 02 48 46 33 66
Fax: +39 02 48 46 82 52
E-mail: info@linak.it - www.linak.it

JAPAN
LINAK K.K.
Phone: 81-45-533-0802
Fax: 81-45-533-0803
E-mail: linak@linak.jp - www.linak.jp

INDONESIA
Pt. Himalaya Everest Jaya
Phone: +6 221 544 8956/8965
Fax: +6 221 619 4658/1925
E-mail: heplastic-div@centrin.net.id
www.hej.co.id

IRAN
Bod Inc.
Phone: +98 2188998635-6
Fax: +98 2188954481
E-mail: info@bod.ir - www.bod.ir

RUSSIAN FEDERATION
000 FAIM
Phone: +7 812 3319333
Fax: +7 812 3271454
E-mail: purchase@fam-drive.ru - www.fam-drive.ru

MALAYSIA
LINAK Actuators Sdn. Bhd.
Phone: +60 4 210 6500
Fax: +60 4 226 8901
E-mail: info@linak-asia.com - www.linak.my

NETHERLANDS
LINAK Actuator-Systems B.V.
Phone: +31 76 5 42 44 40
Fax: +31 76 5 42 61 10
E-mail: info@linak.nl - www.linak.nl

NEW ZEALAND
LINAK New Zealand Ltd.
Phone: +64 9580 2071
Fax: +64 9580 2072
E-mail: nzsales@linak.com.au
www.linak.com.au

NORWAY
LINAK Norge AS
Phone: +47 32 82 90 90
Fax: +47 32 82 90 98
E-mail: info@linak.no - www.linak.no

POLAND
LINAK Polska
Phone: +48 22 295 09 70
E-mail: info@linak.pl - www.linak.pl

REPUBLIC OF KOREA
LINAK Korea Ltd.
Phone: +82-(0)2-6231-1515
Fax: +82-(0)2-6231-1516
E-mail: info@linak.kr - www.linak.kr

RUSSIAN FEDERATION
000 LINAK
Phone: +7 495 280 14 26
Fax: +7 495 687 14 26
E-mail: info@linak.ru - www.linak.ru

SINGAPORE
Servo Dynamics Pte. Ltd.
Phone: +65 6844 0288
Fax: +65 6844 0070
E-mail: servodynamics@servo.com.sg
www.servo.com.sg

SOUTH AFRICA
Industrial Specialised Applications CC
Phone: +27 11 312 2292 or
+27 11 2077600 (Switch Board)
Fax: +27 11 315 6999
E-mail: gartht@isagroup.co.za
www.isaza.co.za

SPAIN
LINAK Actuadores, S.L.u
Phone: +34 93 588 27 77
Fax: +34 93 588 27 85
E-mail: esma@linak.es - www.linak.es

SWEDEN
LINAK Scandinavia AB
Phone: +46 8 732 20 00
Fax: +46 8 732 20 50
E-mail: info@linak.se - www.linak.se

SWITZERLAND
LINAK AG
Phone: +41 43 388 31 88
Fax: +41 43 388 31 87
E-mail: info@linak.ch - www.linak.ch

TAIWAN
LINAK (Shenzhen) Actuator systems Ltd. Taiwan Representative
Phone: +886 2 27290068
Fax: +886 2 27290096
Mobile: +886 989292100
E-mail: sales@linak.com.tw - www.linak.com.tw

TURKEY
LINAK İhr. İht. San. ve Tic. A.Ş.
Phone: +90 312 4726338
Fax: +90 312 4726635
E-mail: info@linak.com.tr - www.linak.com.tr

UNITED KINGDOM
LINAK UK Limited
Phone: +44 (0)121 544 2211
Fax: +44 (0)121 544 2552
E-mail: sales@linak.co.uk - www.linak.co.uk

UNITED ARAB EMIRATES
Mechatronics
Phone: +971 4 267 4311
Fax: +971 4 267 4312
E-mail: mechtron@emirates.net.ae

For contact details on other countries please visit www.linak.com or contact:

LINAK INTERNATIONAL
Phone: +45 73 15 15 15
Fax: +45 74 45 90 10
Fax: +45 73 15 16 13 (Sales)
E-mail: info@linak.com - www.linak.com

Terms of use

The user is responsible for determining the suitability of LINAK products for specific application. LINAK takes great care in providing accurate and up-to-date information on its products.

However, due to continuous development in order to improve its products, LINAK products are subject to frequent modifications and changes without prior notice. Therefore, LINAK cannot guarantee the correct and actual status of said information on its products.

While LINAK uses its best efforts to fulfill orders, LINAK cannot, for the same reasons as mentioned above, guarantee the availability of any particular product. Therefore, LINAK reserves the right to discontinue the sale of any product displayed on its website or listed in its catalogues or other written material drawn up by LINAK.

All sales are subject to the Standard Terms of Sale and Delivery for LINAK. For a copy hereof, please contact LINAK.



WE IMPROVE YOUR LIFE