

# owners manual

- ENGLISH
- SPANISH
- FRENCH



brío 20



brío 30

brío 60



flat / sleep



head only



feet only



zero-gravity

PRELIMINARY

PRELIMINARY

## CONTENTS

Advisory.....	4
Acoustics.....	6
Installation .....	7
brío 20 & 30 Remote Control Function .....	11
brío 60 Remote Control Function .....	12
Troubleshooting.....	13
Accessories .....	15



If adjustable base does not operate or if parts are missing, call:

800-888-3078

Do not contact retail store or dealer.

## IMPORTANT INFORMATION

## READ THE FOLLOWING INFORMATION CAREFULLY BEFORE USING THIS PRODUCT

 **WARNING**

**FOR OPTIMUM ADJUSTABLE BASE OPERATION, USE A GROUNDED, ELECTRICAL SURGE PROTECTION DEVICE (NOT INCLUDED). FAILURE TO USE A SURGE PROTECTION DEVICE COULD COMPROMISE SAFETY OR CAUSE PRODUCT MALFUNCTION.**

**ELECTRICAL RATING**

Electrical components are rated for 110/120 voltage, 60Hz, 100 watt.

**ELECTRICAL GROUNDING**

This product is equipped with a polarized or grounded electrical power cord. The power cord will only fit into a grounded, electrical surge protection device (not included) or a grounded electrical outlet.

**WARRANTY WARNING**

Do not open any control boxes, motors or remote control devices. The product warranty will be void if these components are tampered with. Do not attempt to alter component wiring or adjust or modify the structure of the product in any way or the warranty will be void. Any repair or replacement of base parts must be performed by authorized personnel.

**LUBRICATION**

This product is designed to be maintenance free. The lift motors are permanently lubricated and sealed—no additional lubrication is required. Do not apply lubricant to lift motor lead screws or any nylon nuts or the base may inadvertently creep downward from the elevated position.

**PRODUCT RATINGS**

The base lift motors are *not* designed for continuous use. Reliable operation and full life expectancy will be realized as long as the lift motor operation does not exceed five (5) minutes over a forty-five (45) minute period, or approximately 11% duty cycle. Any attempt to circumvent or exceed product ratings will shorten the life expectancy of the product and may void the warranty.

The recommended weight restrictions for this adjustable base is 450 lb (204 kg), all sizes. The base will structurally support the recommended weight distributed evenly across the head and foot sections. This product is not designed to support or lift this amount in the head or foot sections alone. **Note: Exceeding the recommended weight restrictions could damage the base and void the warranty.**

For best performance, consumers should enter and exit the adjustable base with the base in the flat (horizontal) position. **DO NOT SIT ON THE HEAD OR FOOT SECTIONS WHILE IN THE RAISED POSITION.**

UL (Underwriters Laboratories) recognized components.

CFR 1633 approved for use with most mattresses.

Assembled in USA.

IMPORTANT INFORMATION

READ THE FOLLOWING INFORMATION CAREFULLY BEFORE USING THIS PRODUCT

**SMALL CHILDREN / PETS WARNING**

After the base is unboxed, immediately dispose of packaging material as it can smother small children and pets. To avoid injury, children or pets should not be allowed to play under or on the base. Children should not operate this base without adult supervision.

**PACEMAKER WARNING**

This product produces a vibrating sensation. It is possible that individuals with heart-assist pacemakers may experience a sensation similar to exercise. Consult physician for complete information.

**HOSPITAL USE DISCLAIMER**

*This base is designed for in-home use only.* It is not approved for hospital use and does not comply with hospital standards. Do not use this base with tent type oxygen therapy equipment, or use near explosive gases.

**SERVICE REQUIREMENTS**

Service technicians are not responsible for moving furniture, removing headboards and footboards or any items required to perform maintenance on the base. In the event the technician is unable to perform service due to lack of accessibility, the service call will be billed to the purchaser and the service will have to be rescheduled.

**FCC COMPLIANCE**

The equipment has been tested and found to comply with the limits for a Class B digital device, pursuant to Part 15 of the FCC Rules. These limits are designed to provide reasonable protection against harmful interference when the equipment is operated in a residential environment. This equipment generates, uses, and can radiate radio frequency energy and, if not installed and used in accordance with the instruction manual, may cause harmful interference to radio communications. However, there is no guarantee that interference will not occur in a particular installation. If this equipment does cause harmful interference to radio or television reception, which can be determined by turning off the equipment off and on, the user is encouraged to try to correct the interference by one or more of the following measures:

- Reorient or relocate the receiving antenna
- Increase the separation between the equipment and receiver.
- Connect the equipment into an outlet on a circuit different from that to which the receiver is connected.
- Consult the dealer or an experienced radio/TV technician for help.

Radio Frequency = 433MHz.

### LIFTING/LOWERING MECHANISMS

The lift/lower feature will emit a minimal humming sound during operation. This is normal.

During operation, the lift arm wheels make contact with the platform support of the base. This applies slight tension on the moving components and resonance is reduced to a minimum level. If excessive noise or vibration is experienced, reverse the movement action (up or down) of the base with the remote control. This should realign the base's activating mechanisms to the proper operational position.

### LOCATION ENVIRONMENT

The level of sound experienced during operation is directly related to the location environment. For example, when a base is located on a hardwood floor with the massage feature in operation, a vibrating tone will be audible. To minimize this resonance, place a piece of carpet, or rubber caster cups, under each leg or caster of the base.

It is possible to experience vibration or noise from headboard brackets, headboards or footboards (if used) if mounting bolts are not firmly tightened.

PRELIMINARY

# INSTALLATION

For installation and setup, complete the following procedures, in the order indicated below and on the following pages:

## STEP 1

Before discarding any packing materials, open the adjustable base shipping carton and verify the following items are included:

- (1) Mattress Retainer
- (4) Bed Legs
- (1) Remote Control (varies according to base type)
- (1) Owners Manual CD
- (1) Warranty Sheet
- (1) Warranty Activation Card
- (1) Quick Setup Guide



OWNERS MANUAL CD



WARRANTY



WARRANTY  
ACTIVATION CARD

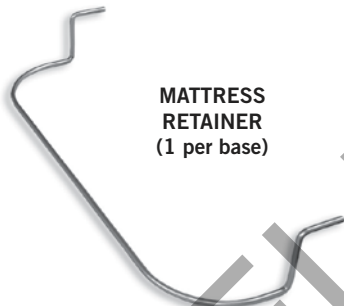

MATTRESS  
RETAINER  
(1 per base)



LEG  
(4 pieces)



REMOTE CONTROL  
(varies according to base type)



QUICK SETUP GUIDE

## INSTALLATION

### STEP 2

Carefully lift the adjustable base frame from the shipping carton, keeping the unit top-side-down.

### STEP 3

Install (4) legs into the base frame. Simply screw each leg into a tapped hole at each corner of the base frame (**FIGURE 1**).

**WARNING**

**AT LEAST TWO PEOPLE ARE RECOMMENDED FOR HANDLING AND MOVING ADJUSTABLE BASE.**

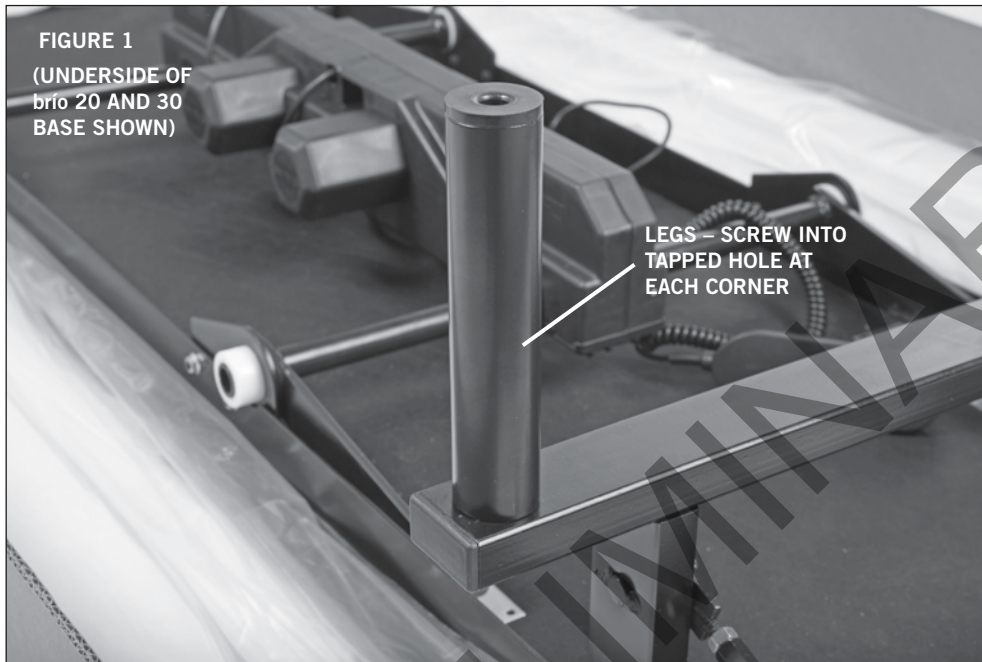

### STEP 4

Remove and extend out power cord from the protective packaging.

**WARNING**

**POWER CORDS MUST NOT INTERFERE WITH ANY ADJUSTABLE BASE MECHANISMS.**

### STEP 5

Remove the plastic packaging from the adjustable base frame. Carefully rotate the base frame over to position the base top-side-up.



## INSTALLATION

### STEP 6

Plug electrical power cord into a working, grounded electrical outlet.

**Note: an electrical surge protection device is recommended (not included).**

### STEP 7

If remote control is non-wired type, install batteries in remote control (wired remote controls do not require batteries) (FIGURES 2 thru 5).

Briefly activate all functions of the base with the remote control to verify all features are in working order. If base does not operate, refer to the *Troubleshooting* section of this manual.

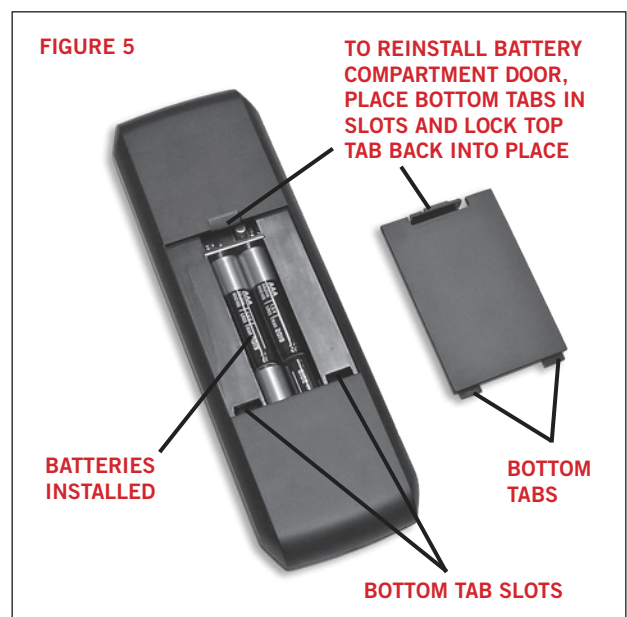
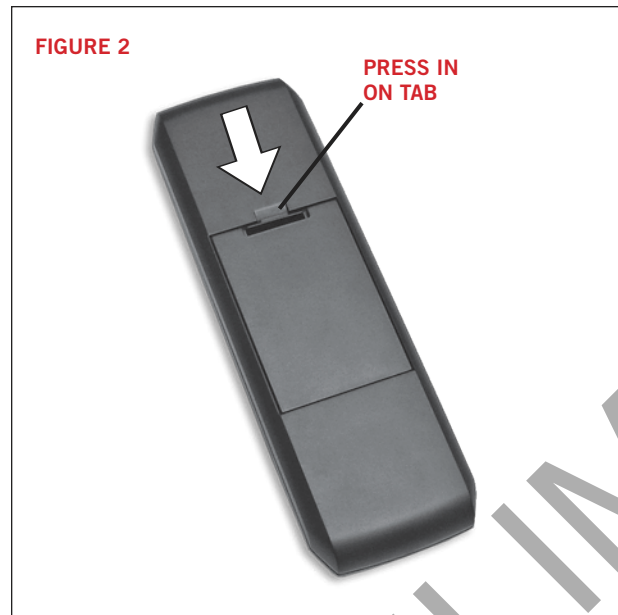

## INSTALLATION

### STEP 8

Return base to the level position.

### STEP 9

Install mattress retainer at the foot end of the base as follows:

- a. Locate grommets holes at foot of base (**FIGURE 6**).
- b. Place mattress retainer ends into grommets holes in top surface of adjustable base (**FIGURE 6**). Press down until horizontal retainer section is flush against base.

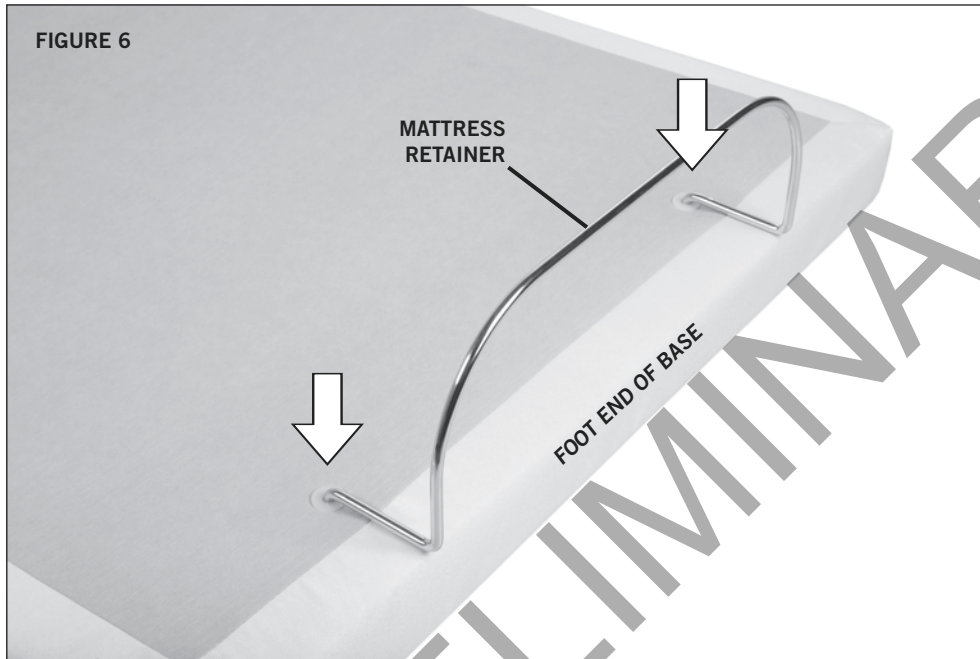

### STEP 10

Install mattress on adjustable base.

Typical brío™ adjustable base installation is now complete.

## brío 20 & 30 REMOTE CONTROL FUNCTION

**TRANSMISSION INDICATOR LIGHT**  
Verifies a button is being pressed and data is being sent to the base.

**HEAD UP BUTTON**  
Press and hold to raise the head section.

**HEAD DOWN BUTTON**  
Press and hold to lower the head section.

**FACTORY PREWIRED**  
Flexible remote control cord is pre-attached to the receiver unit and is ready to use. Removal is easy—depress the tab on the cord connector first, then pull *out*. Push cord connector *in* to re-attach.

**FOOT UP BUTTON**  
Press and hold to raise the foot section.

**HEAD/FOOT UP BUTTON**  
Press and hold to raise the head and foot sections simultaneously.

**HEAD/FOOT DOWN BUTTON**  
Press and hold to lower the head and foot sections simultaneously.

**FOOT DOWN BUTTON**  
Press and hold to lower the foot section.

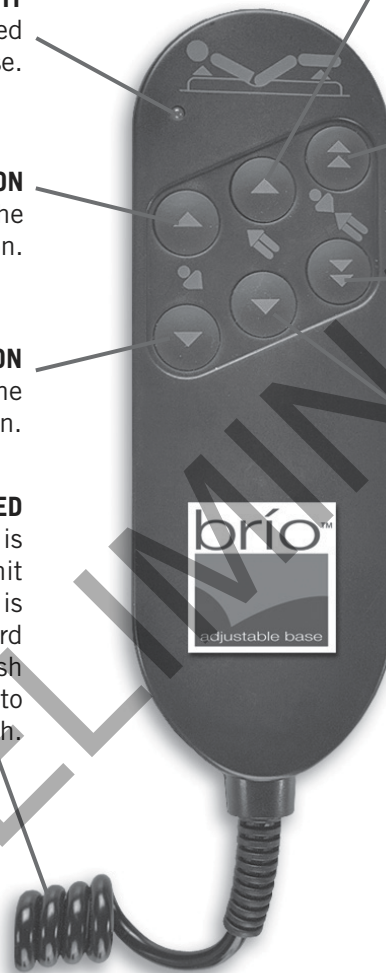

## brío 60 REMOTE CONTROL FUNCTION

### TRANSMISSION INDICATOR LIGHT

Verifies a button is being pressed and data is being sent to the base.

### FOOT MESSAGE UP BUTTON

Press to turn the foot massager on at low intensity. Pressing the button again will increase the level of intensity. **There are 3 levels of intensity.** The massager will automatically turn off after 30 minutes.

### FOOT MESSAGE DOWN BUTTON

Press to decrease the foot massager intensity. To turn off, press until massager stops.

### FOOT UP BUTTON

Press and hold to raise the foot section.

### FOOT DOWN BUTTON

Press and hold to lower the foot section.

### MEMORY BUTTON

Once the desired position or massage function has been achieved, press and hold the *memory button* for 5 seconds to record the position in the memory. After the position has been saved, press the *memory button* to return the base to this position from any other position.

### HEAD MESSAGE UP BUTTON

Press to turn the head massager on at low intensity. Pressing the button again will increase the level of intensity. **There are 3 levels of intensity.** The massager will automatically turn off after 30 minutes.

### HEAD MESSAGE DOWN BUTTON

Press to decrease the head massager intensity. To turn off, press until massager stops.

### HEAD UP BUTTON

Press and hold to raise the head section.

### HEAD DOWN BUTTON

Press and hold to lower the head section.

### FLAT BUTTON

Press to adjust the base to the flat position.

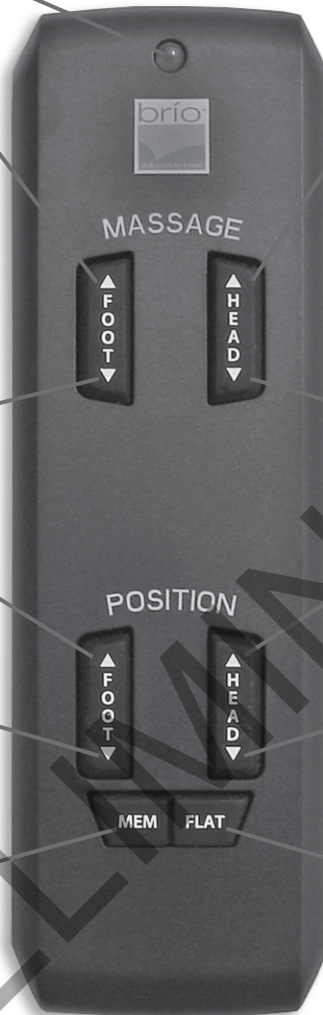

## TROUBLESHOOTING (WIRELESS BASE)

In the event the adjustable base fails to operate, investigate the symptoms and possible solutions provided in the chart below:

SYMPTOM	SOLUTION
Remote control illuminates and appears to be operable, but will not activate base.	<ul style="list-style-type: none"> <li>• Verify power cord is plugged into a working, grounded electrical outlet. <b>A grounded, electrical surge protection device is recommended.</b> Test outlet by plugging in another working appliance.</li> </ul>
No features of the base will activate.	<ul style="list-style-type: none"> <li>• Program the remote control (see <i>Remote Control Programming</i> section of this manual for programming procedures).</li> <li>• Unplug power cord, wait 30 seconds and plug in to reset electronic components.</li> <li>• Electrical circuit breaker may be tripped. Check electrical service breaker box to verify.</li> <li>• Defective surge protection device or electrical outlet. Test outlet by plugging in another working appliance.</li> </ul>
Remote control will not illuminate.	<ul style="list-style-type: none"> <li>• Replace batteries in the hand control.</li> </ul>
Head or foot section will elevate, but will not return to the horizontal (flat) position.	<ul style="list-style-type: none"> <li>• Base mechanism may be obstructed. Elevate base and check for obstruction. Remove obstruction.</li> <li>• Head section may be too close to the wall.</li> <li>• Headboard may be too close the edge of the mattress. Verify a 1.5" (38.1mm) to 2" (50.8mm) distance between headboard brackets and mattress. Adjust if required.</li> </ul>
Excessive massage motor noise.	<ul style="list-style-type: none"> <li>• Verify headboard brackets were removed during installation. Remove headboard brackets if still attached to the underneath side of base.</li> <li>• If base is located on hard surface flooring, place carpet pieces or rubber caster cups under each leg or caster of the base. (See accessory sheet, included with this product, for rubber caster cup order information.)</li> <li>• Elevate the head or foot section a short distance (with the remote control) to realign the lift/lower mechanisms with the base support platform.</li> <li>• Verify that base is not positioned against a wall, nightstand, or other object that may cause vibration or noise.</li> <li>• If base is installed over a base frame, verify massage motors are not causing base frame (or base frame components) to vibrate.</li> <li>• Verify that headboard attachment hardware is tightened firmly (if used).</li> </ul>

## TROUBLESHOOTING (WIRED BASE)







In the event the adjustable base fails to operate, investigate the symptoms and possible solutions provided in the chart below. For additional assistance call 800-888-3078.

SYMPTOM	SOLUTION
Remote control will not activate base.	<ul style="list-style-type: none"> <li>• Verify power cord is plugged into a working, grounded electrical outlet. <b><i>A grounded, electrical surge protection device is recommended.</i></b> Test outlet by plugging in another working appliance.</li> <li>• Verify remote control is plugged into the motor.</li> <li>• Unplug power cord, wait 30 seconds and plug in to reset electronic components.</li> <li>• Electrical circuit breaker may be tripped. Check electrical service breaker box to verify.</li> <li>• Defective surge protection device or electrical outlet. Test outlet by plugging in another working appliance.</li> </ul>
Head or foot section will elevate, but will not return to the horizontal (flat) position.	<ul style="list-style-type: none"> <li>• Base mechanism may be obstructed. Elevate base and check for obstruction. Remove obstruction.</li> <li>• Head section may be too close to the wall.</li> <li>• Headboard may be too close the edge of the mattress. Verify a 1.5" (38.1mm) to 2" (50.8mm) distance between headboard brackets and mattress. Adjust if required.</li> </ul>

## ACCESSORIES

### brío™ OPTIONAL EQUIPMENT

Contact customer service toll free (800-888-3078) to order the accessories indicated in the chart below.

ACCESSORY DESCRIPTION	CODE	IMAGE
Wired Remote Control Cable - Dual DC Motor	4B5431	
Head Board Brackets-TXL	4B6117	
Head Board Brackets-FXL/Q	4B6118	
Push-in Locking Casters (set of 4)	4B1806	
Bed Link Kit (connects two bases together)	4B7410	
Rubber Caster Cups (set of 4)	4B1792	
Leg Extension Kit	4B7365	

PRELIMINARY