



USER GUIDE

**WRT1900AC**  
DUAL-BAND GIGABIT  
Wi-Fi ROUTER

**LINKSYS**  
PERFORMANCE PERFECTED™

# Contents

---

## **PRODUCT OVERVIEW**

- 1 WRT1900AC

## **SETTING UP YOUR ROUTER**

- 5 Where to Find More Help
- 5 How to Install Your Router

## **HOW TO USE LINKSYS SMART WI-FI**

- 6 How to Connect to Linksys Smart Wi-Fi
- 6 How to Change Router Settings

## **TROUBLESHOOTING**

- 10 Your router was not successfully set up
- 11 Your Internet cable is not plugged in message
- 11 Cannot access your router message

## **SPECIFICATIONS**

- 13 Linksys WRT1900AC

# Product Overview

## WRT 1900AC

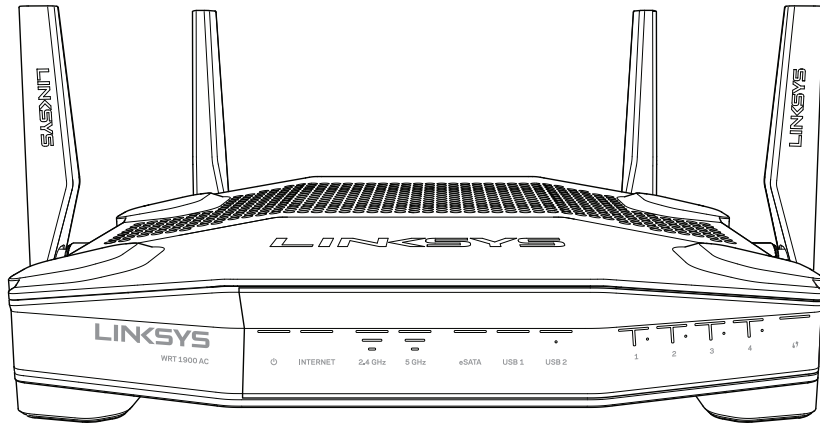

Front View

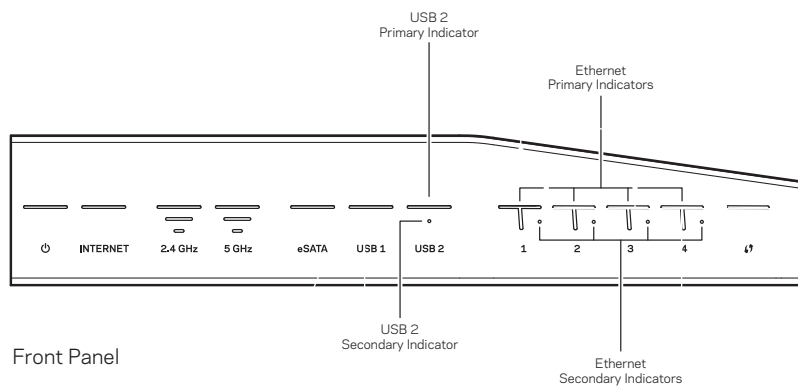

Front Panel

## FRONT PANEL INDICATORS



(White) The power LED is solid white while the router is powered on. It will blink when the router goes through its self-diagnostic mode during every boot-up.

### Internet

(White/Amber) The Internet LED is solid white when connected to the Internet. It blinks white while the router works to establish a connection. A solid amber LED indicates the connection is down due to configuration issues. Amber blinking indicates that the connection is down due to hardware issues.

### 2.4 GHz

(White) The Wireless LED is solid white when one or more clients are connected to the 2.4 GHz network. If the LED is blinking white, the router is sending or receiving data over the 2.4 GHz network.

### 5 GHz

(White) The Wireless LED is solid white when one or more clients are connected to the 5 GHz network. If the LED is blinking white, the router is sending or receiving data over the 5 GHz network.

### eSATA

(White) When off, the USB/eSATA port is off or a USB device is connected. The LED is solid white when an eSATA device is connected. A blinking white LED indicates activity through the eSATA port.

### USB 1

(White) When off, the USB /eSATA port is off or an eSATA device is connected. The LED is solid white when a USB device is connected. A blinking white LED indicates activity on the port.

### USB2 Primary

(White) When off, the USB 3.0 port is off. The LED is solid white when a USB device is connected. A blinking white indicates activity on the port.

### USB2 Secondary

(White) When off, a USB 1.0 or USB 2.0 device is connected. A solid white LED indicates a USB 3.0 device is connected.

### ETHERNET 1 through 4 (Primary)

(White) These numbered LEDs correspond with the numbered ports on the router's back panel. If the white LED is solid, the router is connected to a device through that port. A flashing white LED indicates network activity over that port.

# Product Overview

## ETHERNET 1 thru 4 (Secondary)

(White) If the white LED is off, the router is successfully connected to a device through that port at 10/100 Mbps. A solid white LED indicates that the router is successfully connected to a device at 1000 Mbps.



(White/Amber) The LED blinks slowly for up to two minutes during Wi-Fi Protected Setup. It will be solid white for five seconds to indicate a successful connection. The LED blinks amber if the Wi-Fi Protected Setup process fails. Make sure the client device supports Wi-Fi Protected Setup. Wait until the LED is off, and then try again. The router supports one session at a time.

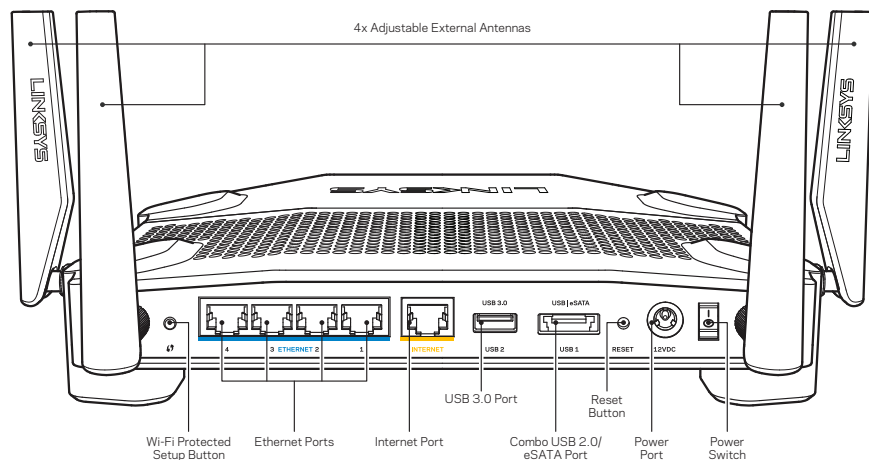

Back View

## Adjustable External Antennas

This router ships with four adjustable external antennas that should be connected to the router before powering it on. To connect the antennas, twist the antenna connector clockwise onto the antenna port on the router.

### Note:

For best performance, position the side antennas vertically as shown in the picture.

## Wi-Fi Protected Setup button

Press to easily configure wireless security on Wi-Fi Protected Setup-enabled network devices.

## Ethernet Ports

Connect Ethernet cables to these blue gigabit (10/ 100/ 1000) ports, and to wired devices on your network.

### Note:

For best performance, use CAT5e or higher rated cables on the Ethernet ports.

## Internet Port

Connect an Ethernet cable to this yellow gigabit (10/ 100/ 1000) port, and to a broadband Internet cable/DSL or fiber modem.

### Note:

For best performance, use CAT5e or higher rated cables on the Ethernet ports.

## USB 3.0 Port

Connect and share a USB or eSATA drive on your network or on the Internet.

## USB 2.0/eSATA Combo Port

Connect and share a USB or eSATA drive on your network or on the Internet. You can also connect a USB printer and share it across your network.

## Reset Button

Press and hold for 10 seconds (until the power LED starts flashing) to reset the router to factory settings. You can also restore the factory settings using Linksys Smart Wi-Fi on the Internet or mobile app.

## Power Port

Connect the included AC power adapter.

## Power Button

Press to turn on the router.

# Product Overview

## Avoid Overheating

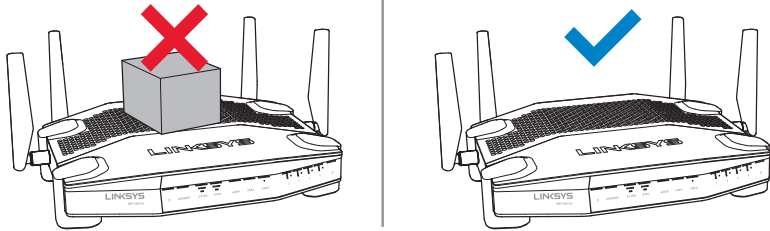

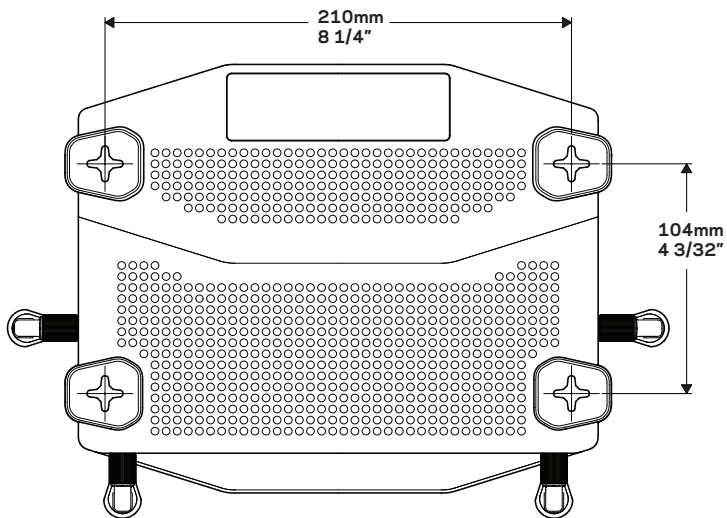

## Wall-Mounting Placement

The router has wall-mount slots on the bottom of each foot for flexibility in mounting the router on the wall. The distance between the slots on the short side is 104 mm. The distance between the slots on the longer side is 210 mm. Two screws are needed to mount the router.



## Suggested Mounting Hardware

 6-7 mm	 3 mm 1.5-2 mm
---	--

### Note:

Linksys is not responsible for damages incurred by unsecured wall-mounting hardware.

### Mounting Instructions

1. Determine where you want to mount the router and which side you should use to mount it. Make sure that the wall you use is smooth, flat, dry, and sturdy. Make sure the location is within reach of an electrical outlet.
2. Before drilling holes, choose the template (short side or long side) that fits your installation. Drill the holes using the correct template.
3. Insert a screw into each hole and leave 4 mm of its head exposed.
4. Position the router so the wall-mount slots line up with the two screws.
5. Place the wall-mount slots over the screws and slide the router down until the screws fit snugly into the wall-mount slots.

### Wall-Mounting Template (Short Side)

Print this page at 100% size.

Cut along the dotted line, and place on the wall to ensure precise spacing of holes.



# Product Overview

---

## Wall-Mounting Template (Long Side)

Print this page at 100% size.

Cut along the dotted line, and place on the wall to ensure precise spacing of holes.

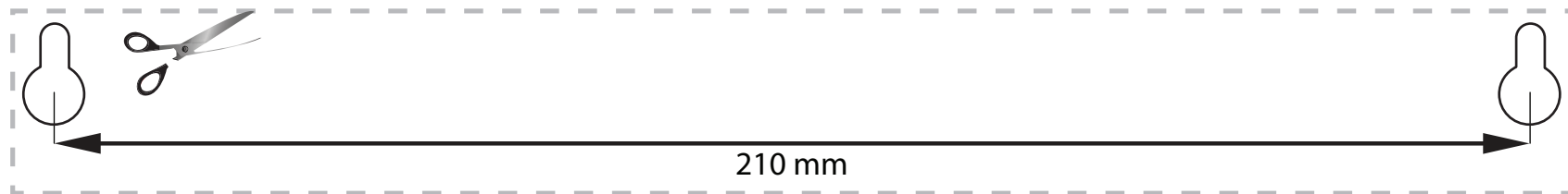



# Setting Up Your Router

---

## WHERE TO FIND MORE HELP

- [Linksys.com/support/WRT1900AC](https://linksys.com/support/WRT1900AC) (documentation, downloads, FAQs, technical support, live chat, forums)
- Linksys Smart Wi-Fi help (connect to **Linksys Smart Wi-Fi**, then click **Help** at the top of the screen)

## HOW TO INSTALL YOUR ROUTER

### To Install Your Router:

1. If replacing an existing router, disconnect it.
2. Connect the antennas and power on your new router.
3. Power cycle your modem
4. Connect the Internet cable from your modem to the yellow Internet port on your router. Wait until the power light on the front of the router is solid.
5. Connect to the secure wireless network name shown in the Quick Start Guide that came with your router. (You can change the network name and password later.)  
If you need help connecting to the network, refer to your device documentation.  
Note: You will not have Internet access until router setup is complete.
6. Open a web browser and follow the instructions to complete setup. If instructions do not appear in the web browser, enter [linksysmartwifi.com](https://linksysmartwifi.com) in the address bar.
7. At the end of setup, follow the on-screen instructions to set up your Linksys Smart Wi-Fi account. Use Linksys Smart Wi-Fi to configure your router from any computer with an Internet connection.

### Manage Your Router's Settings:

- Change your router's name and password
- Set up guest access
- Configure parental controls
- Connect devices to your network
- Test your Internet connection speed

#### Note:

As part of Linksys Smart Wi-Fi account setup, you will be sent a verification e-mail. Make sure that you open the e-mail and click the provided link.

# How to Use Linksys Smart Wi-Fi

## HOW TO CONNECT TO LINKSYS SMART WI-FI

### To Open Linksys Smart Wi-Fi:

1. Visit [linksysmartwifi.com](http://linksysmartwifi.com) or [myrouter.local](http://myrouter.local) (if not online) with a web browser.
2. Enter the email address and password you set up earlier, and click Log in.

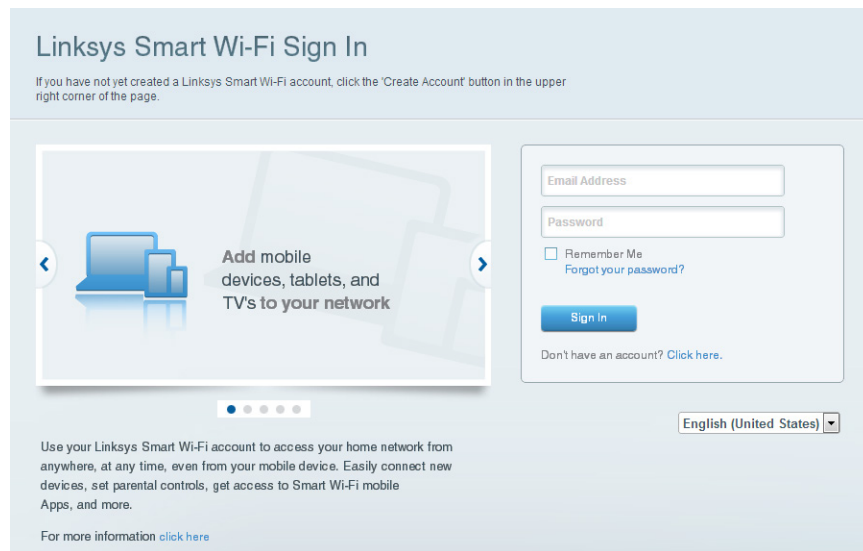

## HOW TO CHANGE ROUTER SETTINGS

### Note:

For additional help on any menu, click Help at the top of the screen.

1. Log into your Linksys Smart Wi-Fi account by visiting [linksysmartwifi.com](http://linksysmartwifi.com) or [myrouter.local](http://myrouter.local) (if not online) with a web browser.
2. In the menu on the left, click an option.

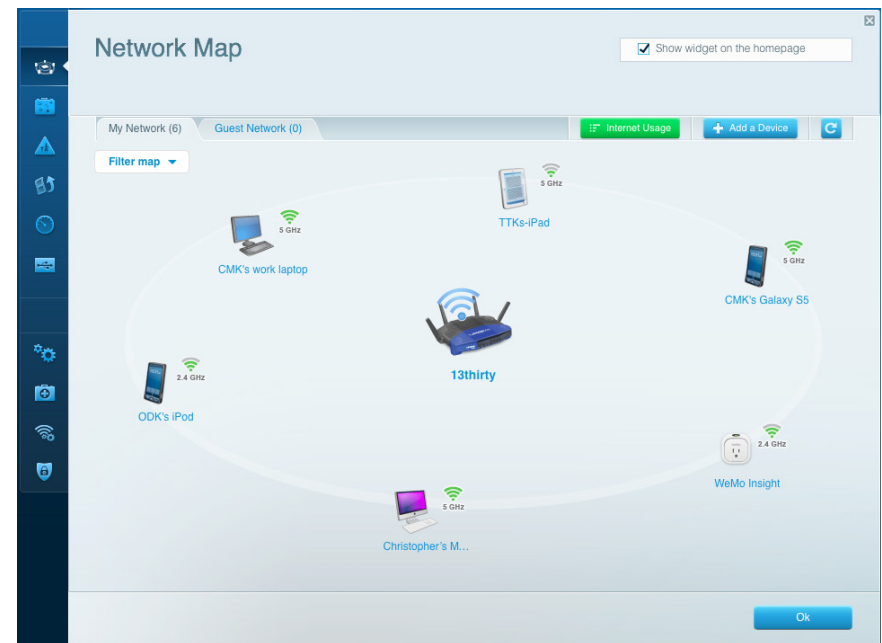

**Network Map** — Lets you display and manage all network devices connected to your router. You can view devices on your main network and your guest network, disconnect devices, or display information about each device.



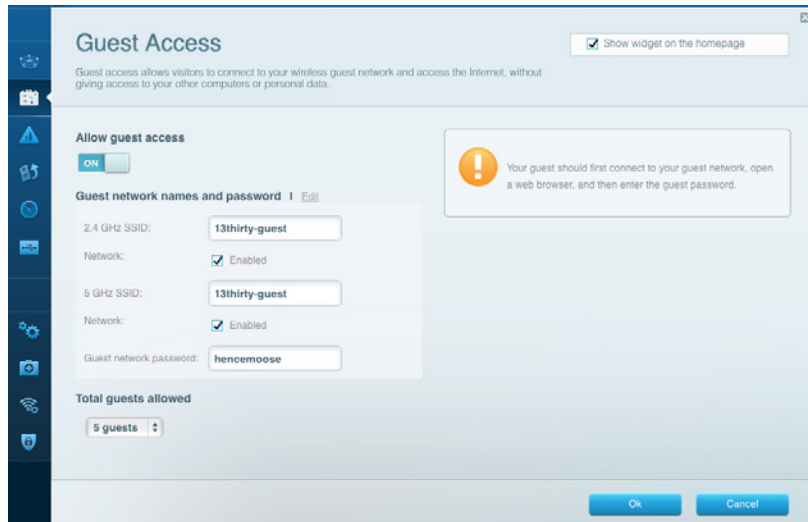

**Guest Access** — Lets you configure and monitor a network that guests can use without accessing all of your network resources.

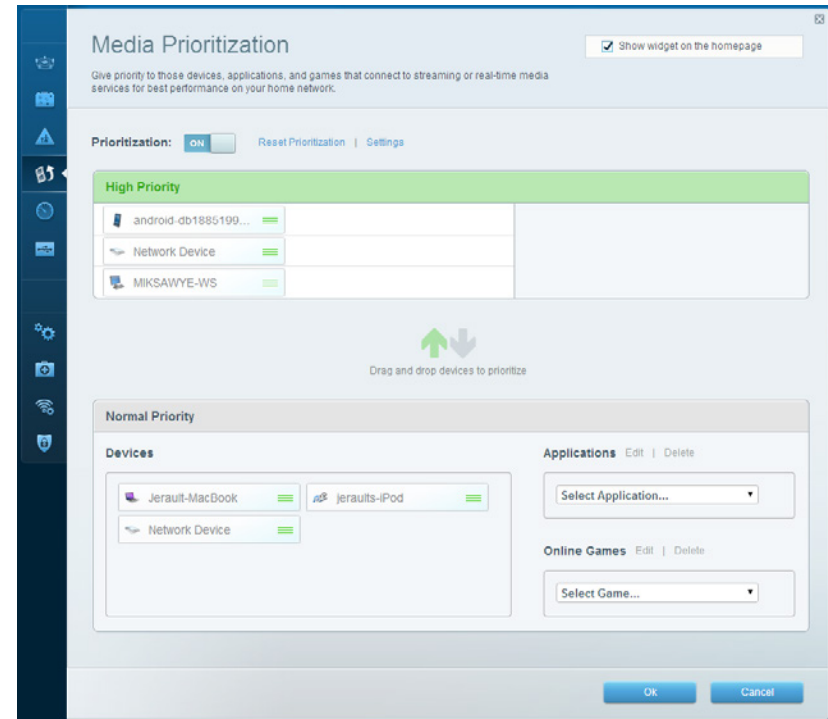

**Media Prioritization** — Lets you set which devices and applications have top priority for your network traffic.

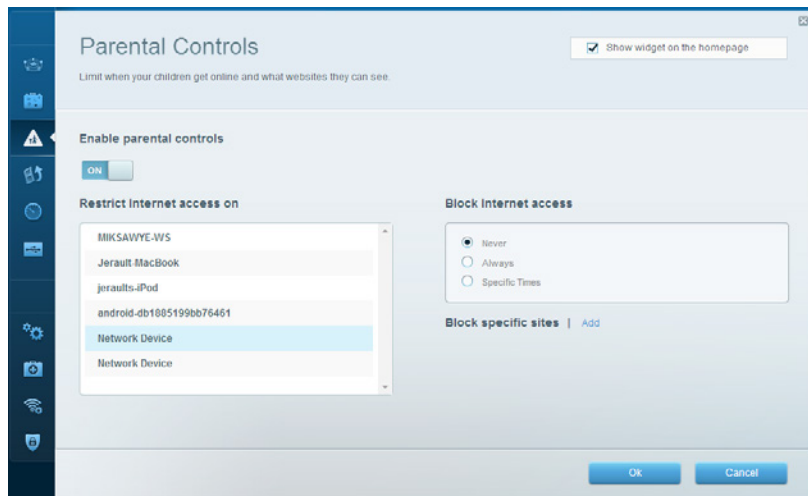

**Parental Controls** — Lets you block web sites and set Internet access times.

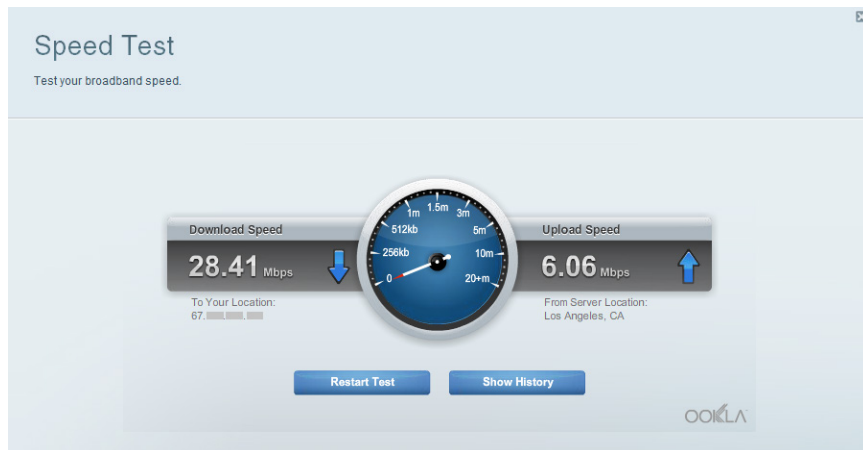

**Speed Test** — Lets you test your network's Internet connection speed.

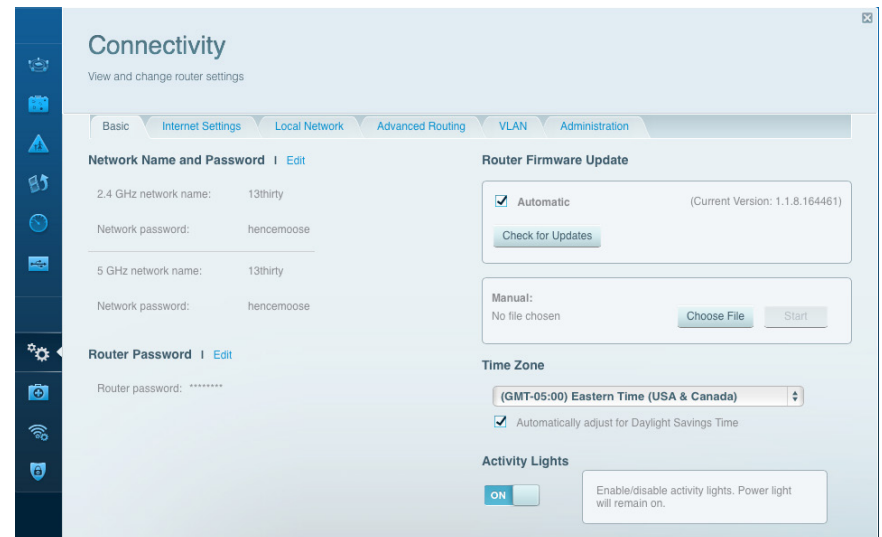

**Connectivity** — Lets you configure basic and advanced network settings.

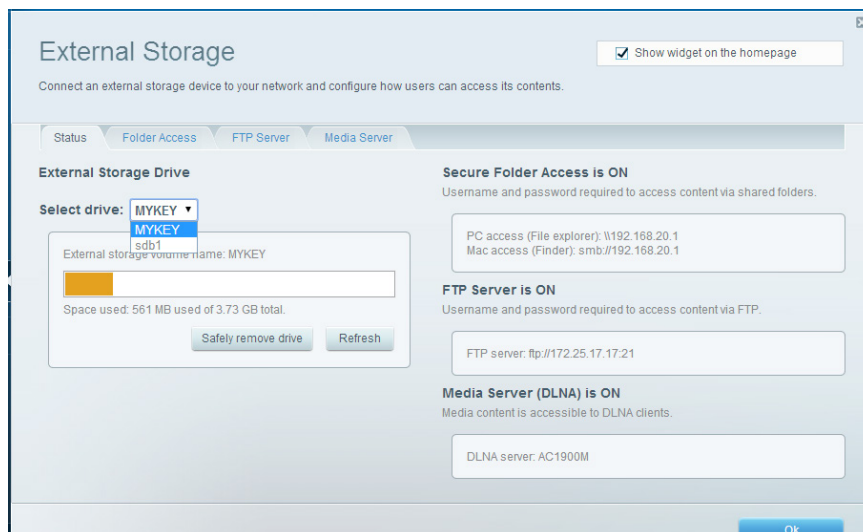

**External Storage** — lets you access an attached USB drive or eSATA drive (neither drive is included) and set up file sharing, a media server, and FTP access.

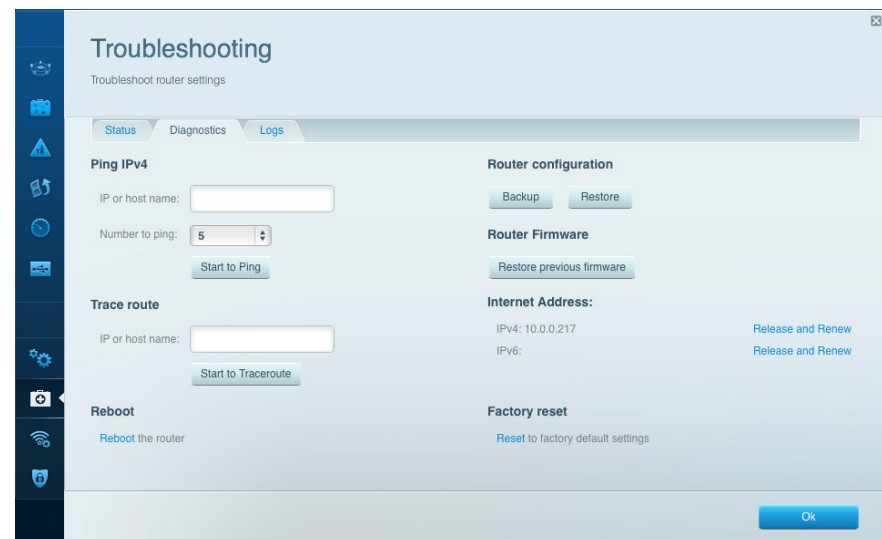

**Troubleshooting** — Lets you diagnose problems with your router and check the status of the network.

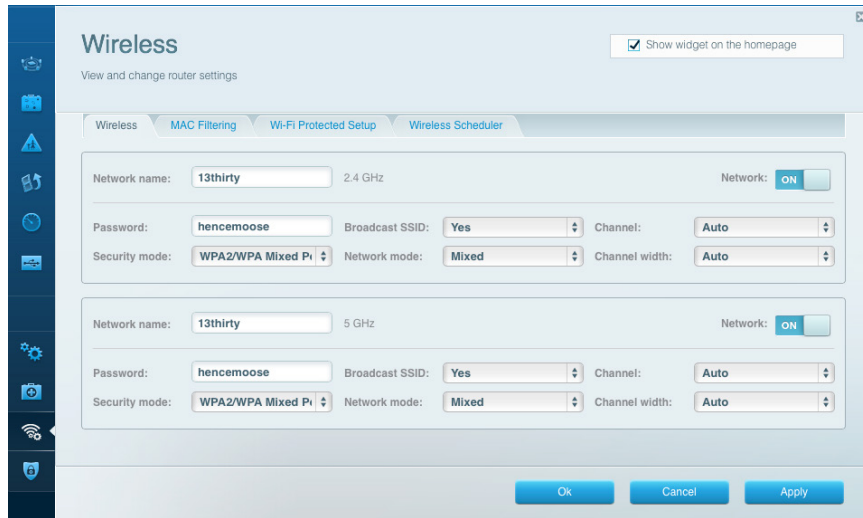

**Wireless** — Lets you configure your router's wireless network. You can change the security mode, password, MAC filtering, and connect devices using Wi-Fi Protected Setup™.

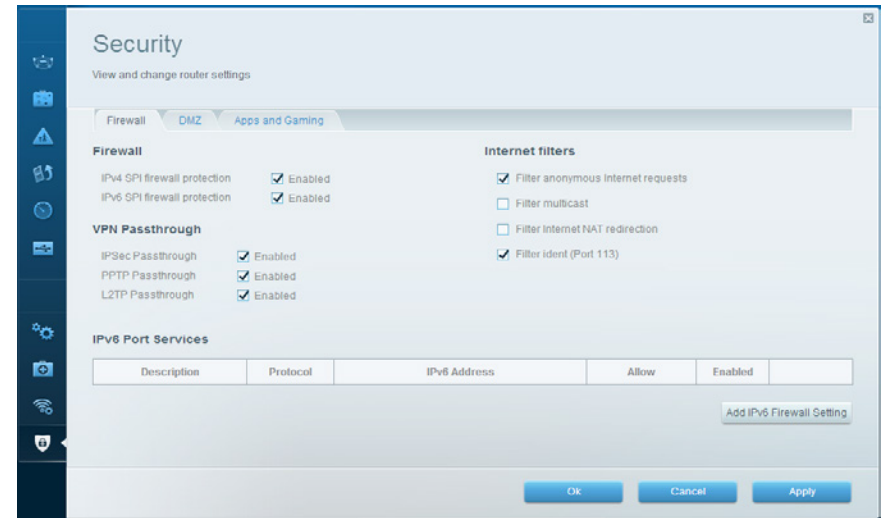

**Security** — Lets you configure your router's wireless security. You can set up the firewall, VPN settings, and make custom settings for applications and games.

# Troubleshooting

This chapter can help you solve common setup issues and connect to the Internet. You can find more help from our award-winning customer support at [linksys.com/support](https://linksys.com/support).

## YOUR ROUTER WAS NOT SUCCESSFULLY SET UP

### If Linksys Smart Wi-Fi Did Not Complete The Setup:

- Using a paperclip or pin, press and hold the Reset button until the power LED on the front of the router starts flashing (about 10 seconds). Install the router again.

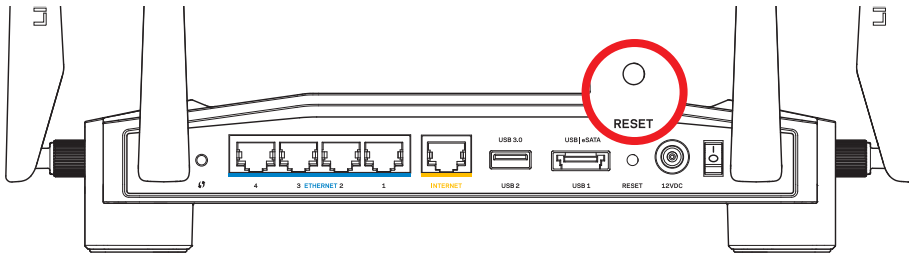

Your Router's Appearance May Vary

- If that doesn't work, temporarily disable your computer's firewall (see the security software's instructions for help). Install the router again.
- If you still haven't set up the router, find another computer, and use that computer to install the router again.

# Troubleshooting

## YOUR INTERNET CABLE IS NOT PLUGGED IN MESSAGE

If you get a “Your Internet cable is not plugged in” message when trying to set up your router:

1. Make sure that an Ethernet or Internet cable (or a cable like the one supplied with your router) is securely connected to the yellow **INTERNET** port on the back of the router and to the appropriate port on your modem. This port on the modem is usually labeled **Ethernet**, but may be named **Internet** or **WAN**.

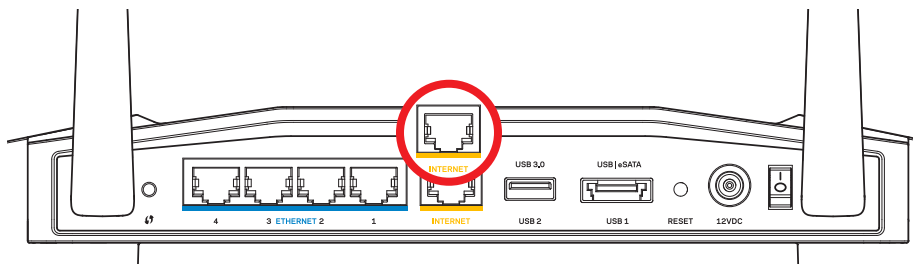

Back View of Router

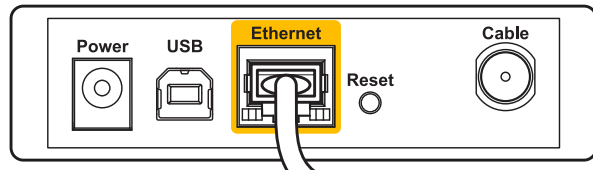

Back View of Cable Modem

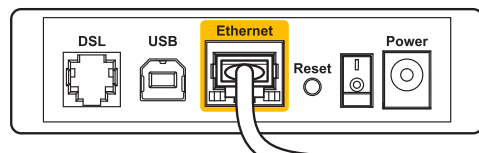

Back View of DSL Modem

2. Make sure that your modem is connected to power and is turned on. If it has a power switch, make sure that it is set to the **ON** or **I** position.
3. If your Internet service is cable, verify that the cable modem’s **CABLE** port is connected to the coaxial cable provided by your ISP.
4. Or, if your Internet service is DSL, make sure that the DSL phone line is connected to the modem’s **DSL** port.
5. If your computer was previously connected to your modem with a USB cable, disconnect the USB cable.

Install the router again.

## CANNOT ACCESS YOUR ROUTER MESSAGE

To access your router, you must be connected to your own network. If you currently have wireless Internet access, the problem may be that you have accidentally connected to a different wireless network.

### To Fix the Problem on Windows Computers:

1. On your Windows desktop, right-click the wireless icon in the system tray. Icon could be different depending on your version of Windows.



2. Click **View Available Wireless Networks**. A list of available networks appears.

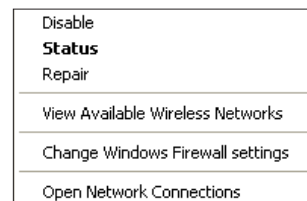

# Troubleshooting

3. Click your own network name. Click **Connect**. In the example below, the computer was connected to another wireless network named *JimsRouter*. The name of the Linksys E-Series network, *BronzeEagle* in this example, is shown selected.

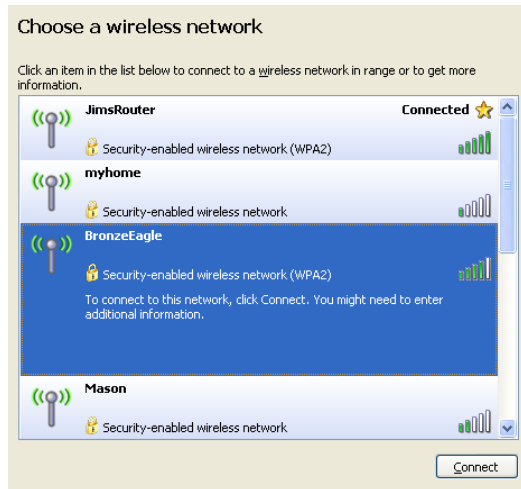

4. If you are prompted to enter a network key, type your password into the **Network key** and **Confirm network key** fields. Click **Connect**.



You should now be able to access the router.

## To Fix the Problem on Mac Computers:

1. In the menu bar across the top of the screen, click the **AirPort** icon. A list of wireless networks appears. Linksys Smart Wi-Fi has automatically assigned your network a name.
2. In the example below, the computer was connected to another wireless network named *JimsRouter*. The name of the Linksys E-Series network, *BronzeEagle* in this example, is shown selected.

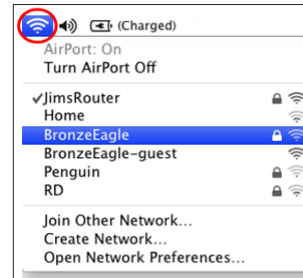

3. Click the wireless network name of your Linksys E-Series router (*BronzeEagle* in the example).
4. Type your wireless network password into the **Password** field. Click **OK**.

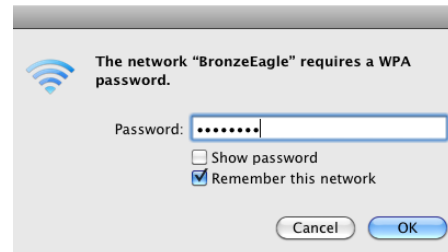

## Where to find more help

- [Linksys.com/support/WRT1900AC](http://support.linksys.com/WRT1900AC) (documentation, downloads, FAQs, technical support, live chat, forums)
- Linksys Smart Wi-Fi ([linksysmartwifi.com](http://linksysmartwifi.com); click Help at the top of the screen)

## Note:

Licenses and notices for third party software used in this product may be viewed on <http://support.linksys.com/en-us/license>. Please contact <http://support.linksys.com/en-us/gplcodecenter> for questions or GPL source code requests.

# Specifications

## LINKSYS WRT1900AC

Model Name	Linksys Dual-Band Gigabit Wi-Fi Router
Description	Dual-Band AC Router with Gigabit and 2×USB
Model Number	WRT1900AC
Switch Port Speed	10/100/1000 Mbps (Gigabit Ethernet)
Radio Frequency	2.4 GHz and 5 GHz
# of Antennas	4 external adjustable antennas
Ports	Power, 1 x USB 3.0, 1 x combo USB 2.0/eSATA, Internet, Ethernet (1-4), RP-SMA (4)
Buttons	Reset, Wi-Fi Protected Setup, Power
Front Panel Indicators	Power, INTERNET, 2.4 GHz, 5GHz,eSATA, USB1, USB2, Ethernet (1-4), Wi-Fi Protected Setup
UPnP	Supported
Security Features	WEP, WPA, WPA2, RADIUS
Security Key Bits	Up to 128-bit encryption
Storage File System Support	FAT, NTFS, and HFS+
Browser Support	Internet Explorer 8 or higher, Firefox 4 or higher, Google Chrome 10 or higher, and Safari 4 or higher

<b>Environmental</b>	
Dimensions	9.68" x 7.64" x 2.05" without antennas (246 x 194 x 52 mm)
Unit Weight	31oz. (883g)
Power	12V, 3A
Certifications	FCC, IC, CE, Wi-Fi a/b/g/n/ac, Windows 7, Windows 8, DLNA
Operating Temp.	32 to 104°F (0 to 40°C)
Storage Temp.	-4 to 140°F (-20 to 60°C)
Operating Humidity	10 to 80% relative humidity, non-condensing
Storage Humidity	5 to 90% non-condensing

### Note:

For regulatory, warranty, and safety information, see the CD that came with your router or go to [Linksys.com/support](http://Linksys.com/support).

Specifications are subject to change without notice.

Maximum performance derived from IEEE Standard 802.11 specifications. Actual performance can vary, including lower wireless network capacity, data throughput rate, range and coverage. Performance depends on many factors, conditions and variables, including distance from the access point, volume of network traffic, building materials and construction, operating system used, mix of wireless products used, interference and other adverse conditions.



Visit [linksys.com/support](https://linksys.com/support) for award-winning technical support

BELKIN, LINKSYS and many product names and logos are trademarks of the Belkin group of companies.  
Third-party trademarks mentioned are the property of their respective owners. © 2015 Belkin International, Inc. and/or its affiliates. All rights reserved.

LNKPG-00214 Rev. B00