

# AXVUE™

BABY MONITOR INSTRUCTION MANUAL

Model-E610

# List

- 1 ..... Safety Instruction
- 2 ..... Features & Components
- 3 ..... Set up & Use
- 4 ..... Troubleshooting
- 5 ..... After-sell service & Warranty card

## WELCOME USE AXVUE PRODUCT

Please read the following instructions and warnings carefully. For technical support see last page. For adult use only, this product is not a toy. Reminder: The installation requires parents to complete, do not let children near the installation. Thank you for purchasing the AXVUE Baby Monitor MS43M1. Now you can observe and listen to the baby is sleeping and playing in another room. Please refer to the manual's instructions for installation and use. Manual does not mention, not removable or change any product components

## This device complies with part 15 of the FCC Rules.

Operation is subject to the following two conditions:

- (1) This device may not cause harmful interference, and
- (2) this device must accept any interference received, including interference that may cause undesired operation.

NOTE: This equipment has been tested and found to comply with the limits for a Class B digital device, pursuant to Part 15 of the FCC Rules. These limits are designed to provide reasonable protection against harmful interference in a residential installation. This equipment generates, uses and can radiate radio frequency energy and, if not installed and used in accordance with the instructions, may cause harmful interference to radio communications. However, there is no guarantee that interference will not occur in a particular installation. If this equipment does cause harmful interference to radio or television reception, which can be determined by turning the equipment off and on, the user is encouraged to try to correct the interference by one or more of the following

### measures:

- Reorient or relocate the receiving antenna.
- Increase the separation between the equipment and receiver.
- Connect the equipment into an outlet on a circuit different from that to which the receiver is connected.
- Consult the dealer or an experienced radio/TV technician for help.

## Note:

The manufacturer is not responsible for any radio or TV interference caused by unauthorized modifications to this equipment. Such modifications could void the user's authority to operate this equipment.

Changes or modifications not expressly approved by the party responsible for compliance could void the user's authority to operate the equipment.

The baby monitor shall be installed and used should maintain the distance above 20 cm

# Safety Instruction

This product cannot replace responsible adult supervision.

---

1. Strangulation Hazard - Children have STRANGLED in cords. Keep this cord out of reach of children (more than 1m away from the crib). Use enclosed Security Clips to help secure cord away from baby's reach. Never use extension cords with AC Adapters. Only use the AC Adapter provided.
2. When an Adapter is plugged into an electrical outlet, do not touch the exposed end. Test monitor before first use, periodically, and when changing location of the Camera.
3. Do not use monitor near water (such as bathtub, sink, etc.)
4. Keep monitor away from heat sources (such as stoves, radiators, etc).
5. Make sure there is proper ventilation around all monitor components. Do not place on sofas, cushions, bed, etc. which may block ventilation. This product is not a toy. Do not allow children to play with it. This product contains small parts. Adult assembly required. Exercise care when unpacking and assembling the product.



## Battery Warning :

1. Use only the original rechargeable battery provided.
2. For replacement battery, please contact us.  
Contact information can be found on P.10 of these instructions.
3. Clean battery and product contacts prior to battery installation.  
Do not short-circuit supply terminals. Remove battery when product is stored for long periods of time or when battery is exhausted
4. Keep all batteries away from children.

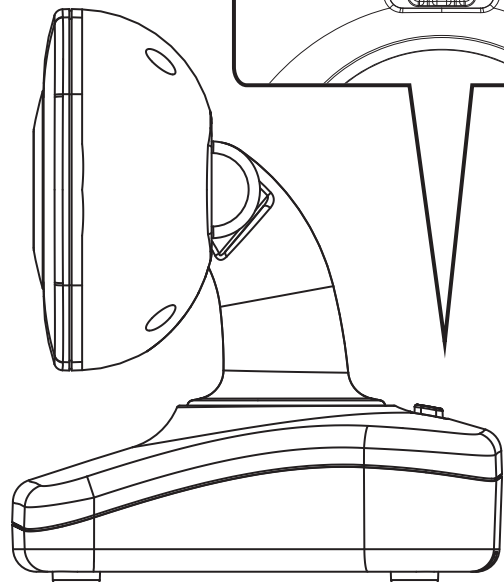
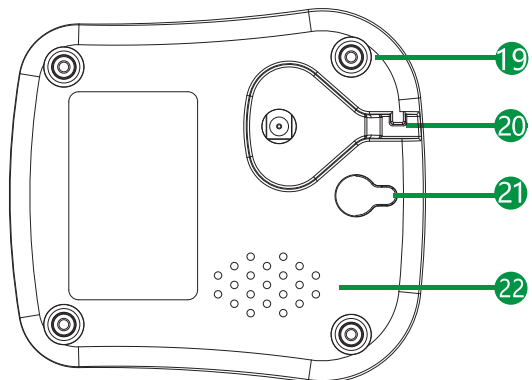
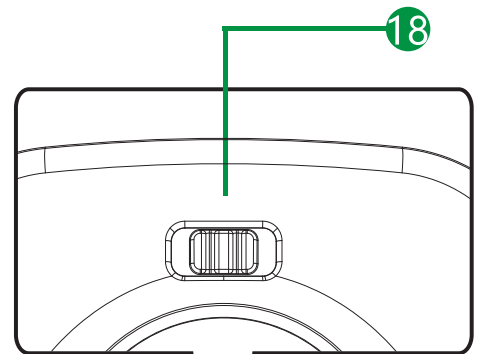
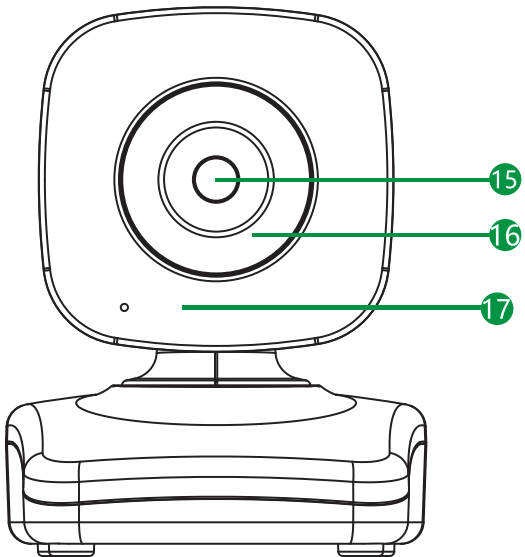
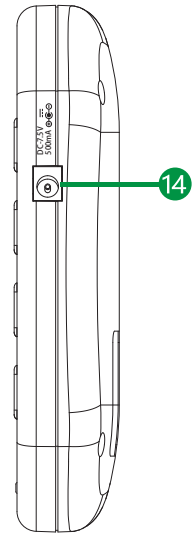
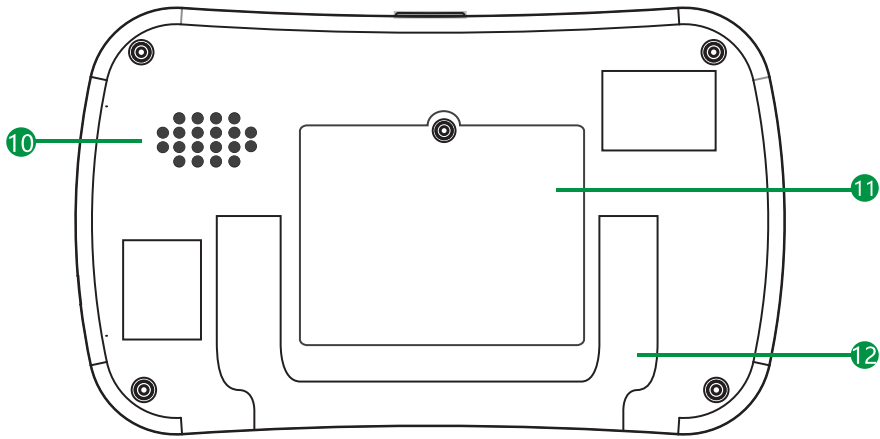
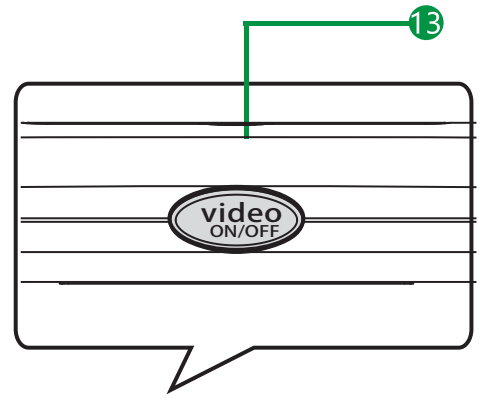
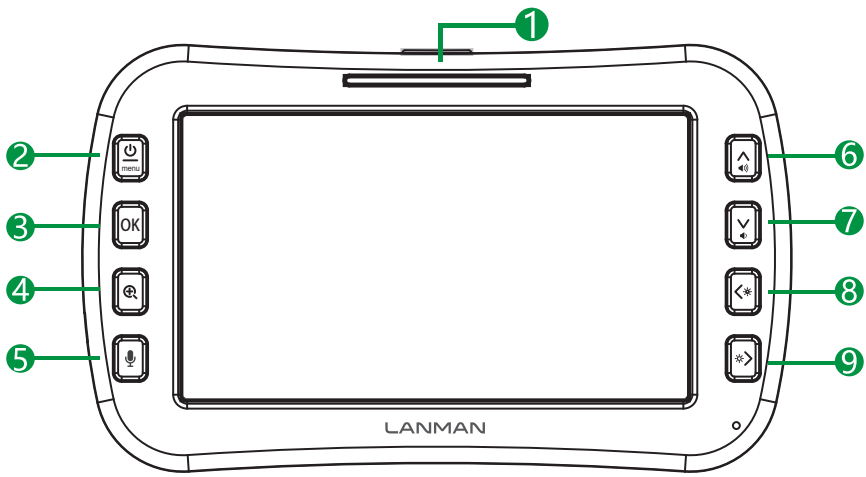

# Features

# Components

- |    |                     |  |
|----|---------------------|--|
| 1  | Battery Light       | Green light indicates that the device is turned on. When the low battery flashes Volume indicator, the greater the volume, the more lights |
| 2  | Power / Menu        | Press six seconds switching equipment, short look into the menu mode   |
| 3  | ENTER               | Confirm the arrow keys Options   |
| 4  | Zoom/Select         | Zoom in or resume the normal screen  |
| 5  | Talk-back           | Press and hold the camera with the end of the one-way intercom   |
| 6  | UP Key              | Turn up the volume level   |
| 7  | DOWN Key            | Turn down the volume level   |
| 8  | Left Key            | Increase the brightness level, enter the menu mode, select the left  |
| 9  | Right Key           | Decrease the brightness level, enter the menu mode, select the right   |
| 10 | Speaker             | Volume level or above may receive when the camera came on  |
| 11 | Battery Compartment | Monitor battery protection   |
| 12 | Kickstand           | After opening the display in position  |
| 13 | Video On/Off        | Turn on or off the display, press any key to re-open<br>Display on for three minutes it will automatically shut down to save power         |
| 14 | Adapte Jack         | Plug in the power adapter, you can use to monitor the charging and maintenance   |
| 15 | Camera Lens         | Transferring images  |
| 16 | Nighttime           | Night mode automatically when turned on, does not affect the baby sleep heliocentric   |
| 17 | Microphone          | Send Sound   |
| 18 | Power On/Off        | Camera Power turn on/off   |
| 19 | Screw               | Fixed monitor internal parts, do not open the screw  |
| 20 | Adapter Jack        | Plug in the power adapter and charge the battery after the opening of electricity use and maintain   |
| 21 | Wall hole           | Wiring can buckle and screw the camera fixed on the wall   |
| 22 | Speaker             | The monitor receives for outgoing voice  |

## Product and Parts List

4.3' Monitor 1pcs

Wireless Camera 1pcs

Monitor Battery 1pcs

Power Adapter 2p

# Set up & Use

Please refer to the manual carefully instructions to set up and use

## Installation and use 1

Testing Initial Setup: Before using AXVUE Baby Monitor, charging the 6-8 hours . Note: **STRANGULATION HAZARD - Children have STRANGLED** in cord out of reach of children, (more than 1m away from the crib) Use enclosed Security Clips to help secure cord away from baby's reach. Never use extension cords with Adapters. Only use the Adapters provided.

Step1: To test reception, determine a location for the camera that will provide the best view fo your baby in the crib (note: do not mount camera in permanent location until initial set up test completed). Plug Adapter into wall outlet and turn camera power on.

Step2: Press and hold POWER/MENU button on monitor for 5-seconds unit AXVUE the logo interface and power on screen. Video should immediately appear on screen. If video does not appear, go refer to "set up and use "checking the installation is complete, (Note: use only the supplied power adapter, Model: P50750500)  
Note: If video appears, the initial set up test is complete.

Installation Camera: Place the camera on a flat surface,such as a bureau or shelf (Picture 1) or mount the camera on a wall(Picture 2) for example: on the desk or cabinet or fixed to the wall, make sure that at least 1 meter from the crib, power lines should be placed above or behind the camera, adjust the camera angle, until the display see the entire crib, or do you think the best line of sight.

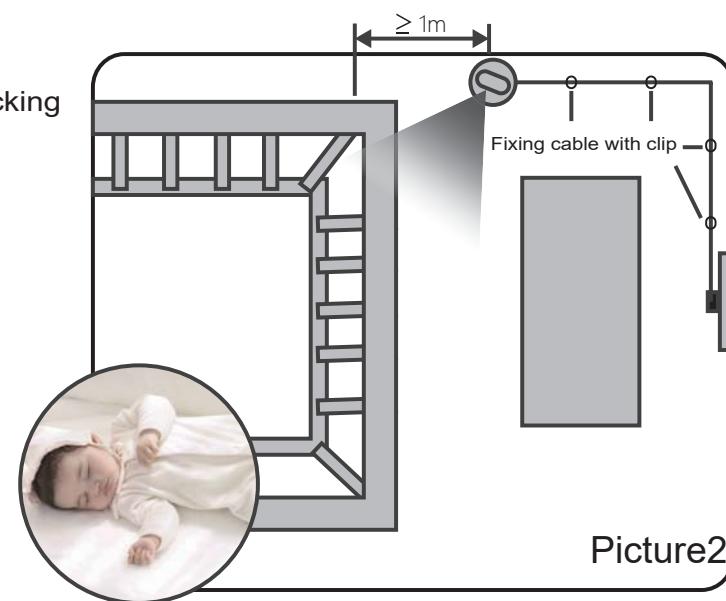
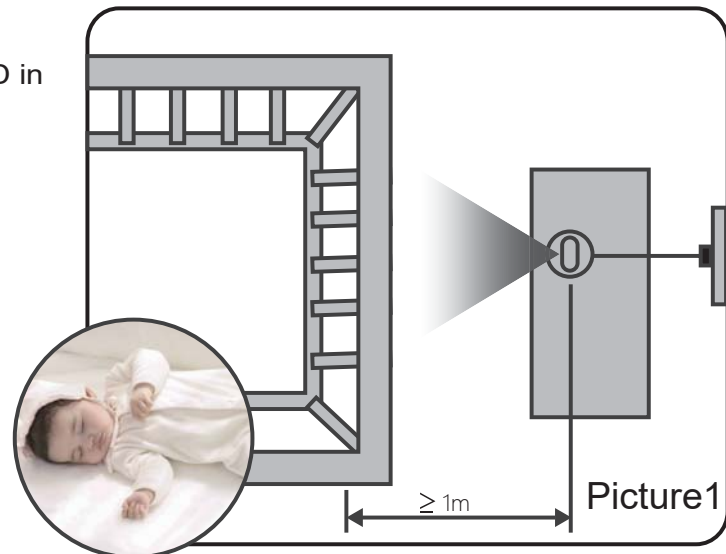

## Tips !

Since most users choose desktop display camera for the sake of environmental protection, product packaging is not included in the wall and screw clips and, if necessary, to buy at the official website of the company or .

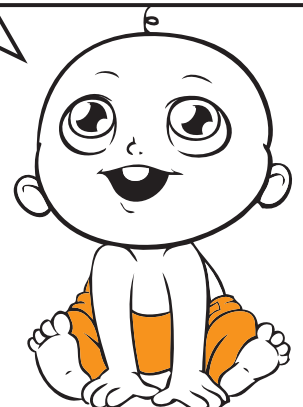

## Wall Mounting: (choose to buy)

- 1 Pre-drill a hole in the wall, a 4.8mm drill bit..
- 2 Insert the wall anchor included into the holo and with a hammer tap gently on the end until the wall anchor is flush with the wall
- 3 Tighten screw until only 6.2mm of the screw is exposed.
- 4 Insert camera Adapter into the camera's adapter jack.
- 5 Sile the back of the camera down onto the screw until the camera is secure to the wall.
- 6 Plug the Adapter into a standard electrical outlet.
- 7 Secure the cord to the wall using the security clips included to keep cord away from baby's reach.

# Installation and Use 2

## Monitor Use

Set the monitor complaints bedroom or living room a fixed position, the compact power adapter plug to the monitor and the other end connected to a power outlet. Press the power / open key for 5 seconds until the green light on the full screen, see AXVUE interface and power display completed open.

If you just listen to the sound, press the key to open the top of the video turns off the display

Such as the need to shut down the monitor, please press the screen until you see the progress bar is red, it means that has been shut down

## Monitor display of the portable use

Please charge the battery before use 4-5 hours

Please connect plug of the power adapter to charge the power plug monitor and the other end connected to a power outlet

## Monitor and Camera on the correspond





Step 1: Monitor and Camera in the same room, camera power after the power switch to the off

Step 2: Camera turn on switch 'Power/Menu', appear three or four options, moving the arrow choose a icon (Reference Picture 3)  then press 'OK' add the new monitor (Reference Picture 4)

4) Display icon '+', the option of adding a camera. After you press OK, the indicator light flashes, then immediately operate the camera, push the power switch to 'ON', that is, to start pairing. If it is not successful, please repeat steps 1 and 2.

## Clear Monitor and Camera correspond

Step 1: At the same time turned.

Step 2: (Reference Picture 5) Switch on 'Power/Menu', appear three or four options, moving the arrow choose a icon, then press 'OK' cancelled correspond. The icon from green to gray, it means that has been "cleared"    

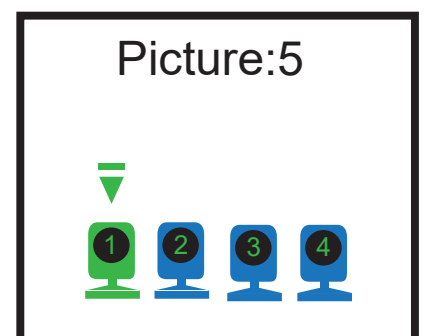
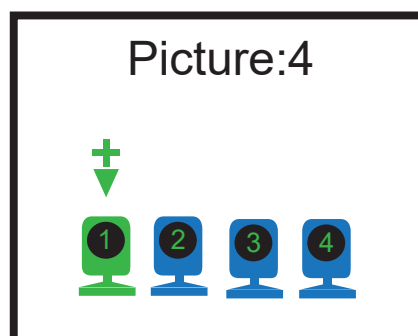
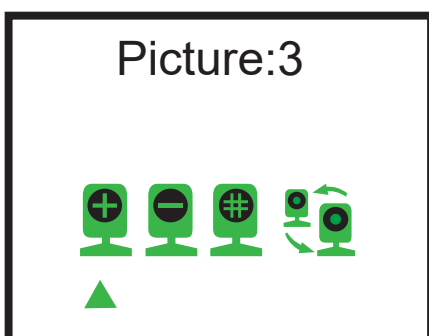





Tips!: Monitor display low battery when charging, often repeated charge will result in shorter battery life. The battery indicator light turns red, indicating low battery, recharge as soon as possible. Do not use this product for a long time, remove the battery when the battery fluid leakage, please remove the battery. Waste battery classified lost to designated collection points (Note: use only the supplied power adapter Model: P50750500)



# Installation and Use 3

Pairing or adding a camera: (Buy more cameras have this function)

---

Can be configured to monitor up to four cameras with scanning capabilities can be every 8 seconds automatically switches to receive another Camera, sound and image transmission: Step1: the monitor and camera are turned "ON" mode, both the distance of not more than 100 meters; Step2: Monitor operation, short press "Power / Menu key" to open, four options appear, press to select the camera     and then OK button to select the icon conversion lens 

## Product Function 1

**Adjustable brightness** Using the "Left and Right" arrows on the front of the monitor, adjust the brightness for lighter or darker video.

**Adjustable sound Volume** adjustments allow higher volume settings to hear every little sound, while lower volume settings monitor the louder sounds and cries from baby. Brightness can be adjusted, as well based on the level of light in the room.

**Automatic night vision** Rest assured knowing you can see your baby day and night, including overnight, with automatic night vision. Infrared automatically adjust to the level of light in the room and transmit a clear black and white image in low-night and darkened room conditions.

## Product Function 1

**Sound indicator light** 5 Sound indicator on the monitor will be in accordance with the size of the baby sound light, the greater the volume, the more light. This function is able to help parents distinguish the sound of the baby in the room size Language louder environment.

## Power saving function

Monitor in the boot state, you can press the display key to open the top of the video, turn off the video display, you can conserve power and extend battery life, video switch is pressed again to turn on the display screen. Standby mode, more than 210 seconds, the monitor will turn off automatically.

## Enlarge show

Press the zoom button, to change the level of zoom for increasingly closer views on screen.



**Tone:** When the battery is low, the monitor will emit a continuous sound three times, until no battery or recharge the battery. When the distance between the monitor and the camera is too far or interference caused not normally receive the signal, the display will show 'OUT OF RANGE', and issued three consecutive sound, plug the monitor from the camera to get closer to the position.

#### Tips!

This product package including one monitor, one camera and parts, if necessary, to buy at the official website of the company or authorized agents.

## Common Problems and Solutions

In case the problem can be resolved in accordance with the following method specification

---

### No picture or sound

1. Make sure the camera and monitor are paired
2. Make sure the camera and the monitor are turned on

### Sound but no picture

1. Press the video On-Off button once to turn on video mode. Check to make sure nothing is blocking the camera
2. Test reception by moving the monitor and/or camera to different locations
3. Make sure the camera and monitor are paired

### Picture but no sound

1. Turn up the volum using Volume Control
2. Power the monitor completely off, remove and re-insert the btturn monitor back on.
3. Make sure the camera and monitor are paired arrey, then

### Picture not clear

1. Position the monitor closer to the camera.
2. Move the monitor away from other electronic devices, cordless phone, etc. Test reception by moving the monitor and/or camera to different locations
3. Adjust the brightness using the Brightness Control

### Squealing sound coming from speaker on monitor

1. The need to monitor and camera distance of 1 m or more
2. Turn the volum down using Volume Control



## Notice :

1. Follow the instructions to use the product
2. Do not disassemble, open, chopped or metal piercing the product
3. Product power when not using the product for a long time, at least once a week to charge this product
4. Prohibition of the product is exposed to heat or fire, the ban into the fire, avoid direct exposure to sunlight.
5. Once the leak, do not touch the skin, eyes and other parts, such as inadvertent contact, rinse with plenty of water contact position, and seek immediate medical attention.
6. Requests the ambient temperature 0-45 degrees, relative humidity of 20-70% using Rh situation, and away from moisture, heat, water and fire.
7. The appearance of damage, burning smell, leakage, smoke, please stop using it immediate

## Tips!

Products are not available or there may be a method other problems first check the specification process, can't handle if you have questions, please contact us to follow up

## After-sell service & Warranty card

"Including but not limited to, the following circumstances are all not maintenance free:(Serviceable but the corresponding parts and labor costs to charge a fee)1. Human factors, damage caused by force majeure.2. Under non-work environment, do not follow the instructions to use the case of damage, and so on.3. Non-formal channels to buy, can't provide product brochures warranty card, and purchase receipt.4. The non-public service department or authority service user serviceable, in the case of disassembly.Note: The company has a product description can do the interpretation and amendment, the final interpretation of branded products"

### AXVUE Baby Monitor After-sell service:

Where to buy this product users are eligible for after-sales service: If you purchased the product itself quality problems, were not in the man-made damage, without overhaul, under paragraph damaged packaging, within 7 days after purchase for replacement.

### Contact us:

Loftynn Intelligence Technology Co, Ltd

Address: Room301,Xindonging Commercial Center, Liuxian 2nd Road

Tel:0755-26608994 [www.loftynn.com](http://www.loftynn.com)

# Maintenance card - charging products

---

## User information:

Name : \_\_\_\_\_

Tel: \_\_\_\_\_

Zip Code: \_\_\_\_\_

E-mail: \_\_\_\_\_

Wechat No : \_\_\_\_\_

Address: \_\_\_\_\_

Product Name: Baby Monitor Baby Camera Charging cable

## Product Information: :

Color: Silver Black Other

Purchase date and dealer: \_\_\_\_\_

Cause of issue: Monitor can not display

Unable to connect the monitor The monitor can't start

Can't give products charge Speaker no sound

Press made no response

Other: \_\_\_\_\_