

AXVUE™

Model-E660

INSTRUCTION MANUAL

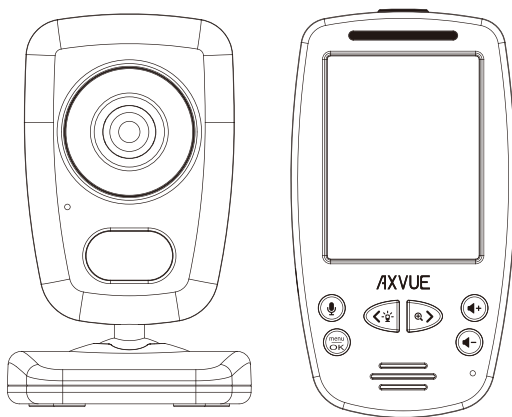

AXVUE E660 VIDEO BABY MONITOR WITH 2.4" LCD SCREEN AND NIGHT VISION

Please read the following instructions and warnings carefully

Tools required for wall mount: Screwdriver and drill (not included)

Keep this instruction manual for future reference.

For technical support see FAQ page.

For adult use only.

Get to know us at: www.axvue.com

WARNING

WARNING

THIS PRODUCT CANNOT REPLACE RESPONSIBLE ADULT SUPERVISION.

- Strangulation Hazard - Children have STRANGLED in cords. Keep this cord out of reach of children (more than 3 feet (0.9m) away from the crib). Use enclosed Security Clips to help secure cord away from baby's reach. Never use extension cords with AC Adapters. Only use the AC Adapter provided.
- When an Adapter is plugged into an electrical outlet, do not touch the exposed end.
- Test monitor before first use, periodically, and when changing location of the Camera.
- Do not use monitor near water (such as bathtub, sink, etc.).
- Keep monitor away from heat sources (such as stoves, radiators, etc). Make sure there is proper ventilation around all monitor components. Do not place on sofas, cushions, beds, etc. which may block ventilation.
- This product is not a toy. Do not allow children to play with it. This product contains small parts. Adult assembly required. Exercise care when unpacking and assembling the product.

BATTERY WARNING

- Use only the original rechargeable battery provided. Please contact Axvue Inc. for replacement battery. Contact information can be found on last page of these instructions.
- Clean battery and product contacts prior to battery installation.
- Do not short-circuit supply terminals.
- Remove battery when product is stored for long periods of time or when battery is exhausted.
- Keep all batteries away from children.
- Dispose of exhausted battery properly.



WARNING:



STRANGULATION HAZARD - Children have STRANGLED in cords. Keep this cord out of reach of children (more than 3 feet (0.9 m) away from the crib). Use enclosed Security Clips to help secure cord away from baby's reach. Never use extension cords with AC Adapters. Only use the AC Adapters provided.

Features and components

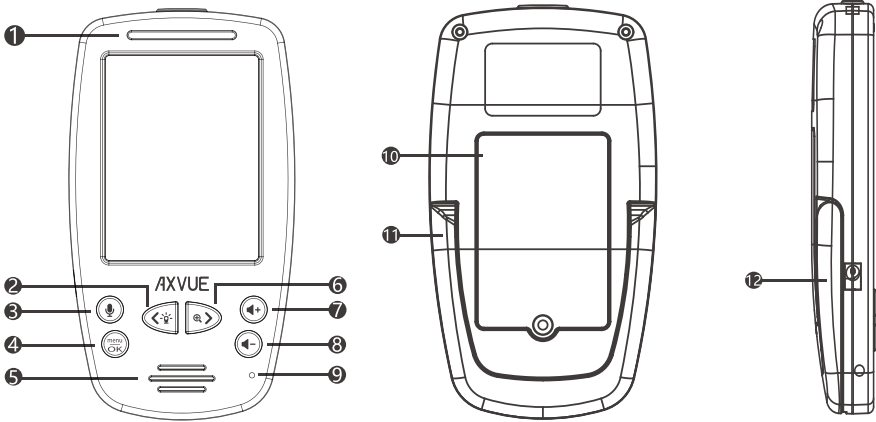

- 1 LED*
- 2 brightness
- 3 Talk Back
- 4 OK / menu
- 5 Horn

- 6 Right/Zoom In
- 7 Volume Up
- 8 Volume Down
- 9 Speaker
- 10 Battery Compartment

- 11 Kickstand
- 12 DC Jack

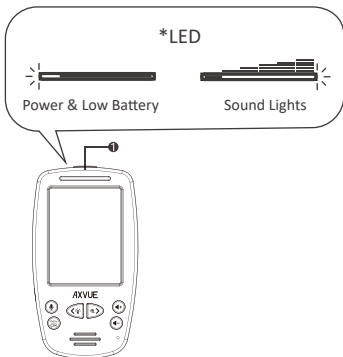

Adapter for monitor:

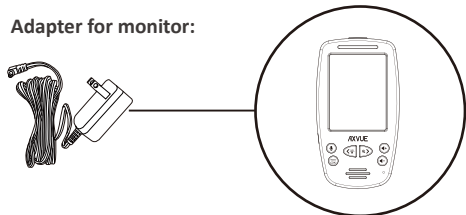

Features and components (continued)

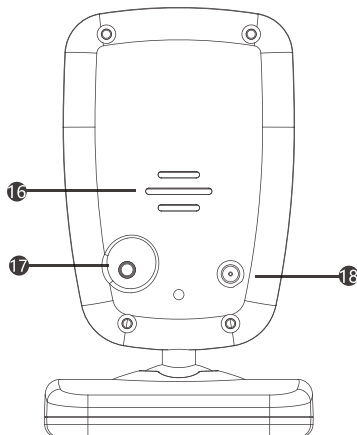
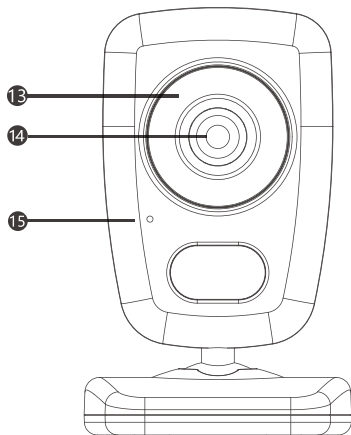

- 13 Nighttime LEDs
- 14 Lens
- 15 Microphone
- 16 Speaker
- 17 Power On / Off Switch
- 18 DC Jack

Adapter for camera:

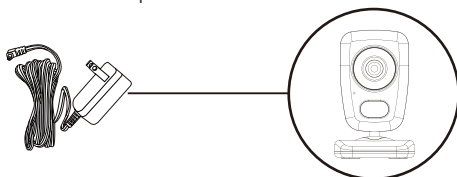

x6



x1



x1

WARNING

STRANGULATION HAZARD - Children have STRANGLED in cords. Keep this cord out of reach of children (more than 3 feet (0.9 m) away from the crib). Use enclosed Security Clips to help secure cord away from baby's reach. Never use extension cords with AC Adapters. Only use the AC Adapters provided.



Features and components

⚠ WARNING

STRANGULATION HAZARD - Children have STRANGLED in cord out of reach of children, (more than 3 feet away from the crib). Use enclosed Security Clips to help secure cord away from baby's reach. Never use extension cords with Adapters. Only use the Adapters provided.

TESTING INITIAL SETUP

Before using the monitor, charge the battery for 6-8 hours.

Step1: To test reception, determine a location for the camera that will provide the best view of your baby in the crib (note: do not mount camera in permanent location until initial set up test completed). Plug Adapter into wall outlet and turn camera power on.

Step2: Press and hold 'POWER/MENU' button on monitor for 5-seconds until the AXVUE showed on the screen. Video should immediately appear on screen. If video does not appear, go to page 5 'To pair monitor and camera'. If video appears, the initial set up test is complete, and you can install camera, instructions below.

Installation Camera: Place the camera on a flat surface, such as a bureau or shelf (Figure1) or mount the camera on a wall (Figure 2). For example: On the desk or cabinet or fixed to the wall, make sure that at least 3 feet from the crib, power lines should be placed above or behind the camera, adjust the camera angle, until the display see the entire crib, or do you think the best line of sight.

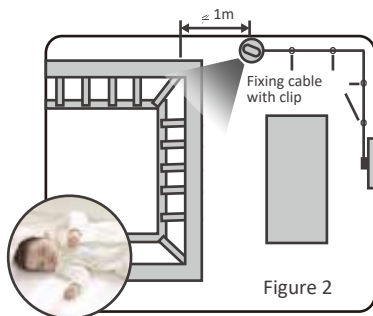
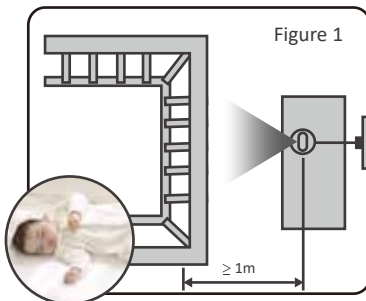

WALL-MOUNT

1. Pre-drill a hole in the wall, a 3/16" (4.8mm) drill bit.
2. Insert the wall anchor into the hole and with a hammer, tap gently on the end until the wall anchor is flush with the wall.
3. Tighten screw until only 1/4" (6.2mm) of the screw is exposed.
4. Insert camera Adapter into the camera's adapter jack.
5. Slide the back of the camera down onto the screw until the camera is secure to the wall.
6. Plug the Adapter into a standard electrical outlet.
7. Secure the cord to the wall using the security clips to keep cord away from baby's reach.

Setup & use (continued)

TO USE PLUGGED-IN

- Step 1:** Place the monitors in the rooms from which you want to monitor your baby (ie., living room or bedroom). Plug the monitor AC adapters into the AC adapter jacks and other ends into standard electrical outlets.
- Step 2:** Press and hold POWER/MENU button for 5-seconds to power up until the AXVUE logo or video appears on screen.
- Step 3:** For audio and no video, press the VIDEO ON/OFF button top of the unit.
- Step 4:** To turn the monitor off completely, press and hold the POWER/MENU button for 5-seconds.

TO USE PORTABLE / BATTERY MODE

Before using the monitor, charge the battery for 6-8 hours.

- Step 1:** Charge the battery for 4 hours at least, before using the monitor in portable mode.
- Step 2:** Make sure the monitor adapter is plugged into the monitor, camera adapter is plugged into the camera, as they are shown on the body.
- Step 3:** The battery life can be up to 6-hours if charged overnight.

Battery life will be weakened if recharging constantly. Charge the battery after the indicator is shown. Remove battery if long time of non-use, or exhausted.

TO PAIR MONITOR AND CAMERA (ADD A CAMERA)









The monitor and the camera are paired prior to the shipment. If the monitor and camera are found not paired for some reason, follow steps below:

- Step 1:** Make sure the monitor is at the same area as the camera.



- Step 2:** Keep the camera powered off.  OFF





- Step 3:** Press **Power/VIDEO**  button for 5 second to power on the monitor. Then press **OK/Menu** button , highlight camera option  by using **Left/Brightness**  or **Right/Zoom In**  button, press the **OK/menu**  button to enter the camera options menu which is show as below . Select ADD CAM icon , press **OK/menu**  button to camera list, select an available number and press **OK/menu**  button to start pairing, the red LED will flash and wireless connecting icon is shown.

-  Press 5 second to power on.

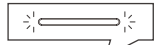

Red LED will flash



- Step 4:** Power on the camera within 8 seconds.  ON



- Step 5:** Wait 3 seconds, the red LED will stop flashing once paired successfully, and video will appear.

Setup & use (continued)

TO DELETE A CAMERA



TO SELECT A CAMERA



TO SCAN ALL CAMERAS (AUTO-SCAN)

This product accepts up to 4 cameras and operates on audio and video auto-scan to view each camera on an 8-second rotation.



The **SCAN**, **DELETE**, **ADD**, **VIEW CAMERA** menu options are used with additional cameras only. Order the extra camera by visiting us at <http://www.axvue.com>.

Favorite features (continued)

DIGITAL ZOOM

The zoom option enables you to get a closer view on screen. Press the **ZOOM IN/OUT** button once will move the image on the monitor screen to 2x view, press again to return the normal view.

TWO WAY COMMUNICATION

Your baby is always eager to your voice when crying. Press and hold the **TALK BACK** button on the monitor to activate two-way communication.

NIGHT VISION

The LEDs around the lens, is functioning to the night vision, which will be enabled automatically. It is appearing black and white image on the screen, when the camera is in a low-light and dark room.

SOUND LIGHTS

The 5 sound activated LED lights illuminate based on the level of baby's sounds. If baby is just cooing, green to amber lights will illuminate and if baby is crying, amber to red lights will illuminate. This feature is particularly helpful for parents if they are in crowded or noisy rooms.

Favorite features (continued)

ADJUSTABLE VOLUME AND BRIGHTNESS

Volume adjustments allow higher volume settings for parents who want to hear every little sound from baby, like cooing, and lower volume settings to monitor louder sounds and cries from baby. Easily adjust the volume based on your preferences and the level of other sounds in the home. Brightness can be adjusted, as well, to accommodate the level of light in the room. Using the brightness control feature enables lighter or darker video, depending on room viewing conditions. Use the UP and DOWN arrows to adjust the brightness.

POWER-SAVE MODE

While operating on battery power, the video screen will go to sleep, to conserve battery power. Audio and sound lights continue to function normally. Video sleep mode is not available when using AC adapter.

VIDEO ON-OFF BUTTON

This button turns the video mode on from video sleep mode. It is ideal for a quick view of baby in the middle of the night. To monitor in audio only mode, simply press the VIDEO ON/OFF again to turn the video screen off.

FAQ

NO PICTURE OR SOUND

- Make sure the camera and handheld monitor unit are paired (see page 5)
- Make sure the camera and handheld monitor unit are both turned on
- Make sure the AC adapters are plugged in
- Make sure the outlets are working
- Make sure the battery is charged before working as portable mode
- Keep the camera and monitor out of WiFi router (more than 10 feet) off.

SOUND BUT NO PICTURE

- Press the VIDEO ON/OFF button once to turn on video mode
- Check to make sure nothing is blocking the camera
- Test reception by moving the monitor and/or camera to different locations
- Pair the camera and monitor again

PICTURE BUT NO SOUND

- Power the monitor completely off, remove and re-insert the battery, then turn monitor back on.
- Turn up the volume using Volume Control
- Make sure the camera and handheld monitor unit are paired.

PICTURE NOT CLEAR

- Position the monitor closer to the camera, but not adjacent.
- Move the monitor away from other electronic devices, WiFi router, etc.
- Adjust the brightness using Brightness Control
- Test reception by moving the monitor and/or camera to different locations

SQUEALING SOUND COMING FROM SPEAKER ON MONITOR

- Move the monitor and camera further away from each other
- Turn the volume down using Volume Control
- Power the monitor completely off, remove and re-insert the battery, then turn the monitor on again.

IMPORTANT SAFETY INSTRUCTIONS

- Read safety and operating instructions before the product is operated.
- Retain instructions for future reference.
- Heed warnings on the product and in the operating instructions.
- Follow instructions and operate properly.
- Cleaning after unplugging this product from the wall outlet. And use a damp cloth for cleaning.
- Use product manufacturer recommended attachments to avoid possible hazards.
- Do not use this product near humid place, for example, bath tub, wash bowl, kitchen sink, laundry tub, wet basement, swimming pool and the like.
- Ensure this product is installed securely on a stable cart, stand, tripod, bracket, or table. -Otherwise, The falling product may cause serious injury to a child or adult, and serious damage to -the product.
- Use manufacture recommended cart, stand, tripod, bracket, or table. Follow the manufacturer's instructions strictly and use recommended mounting kits to mount the product.
- The slots and openings in the cabinet are provided for ventilation and to ensure reliable operation of the product and to protect it from overheating, and keep these openings not blocked or covered.
- The openings should never be blocked by placing the product on a bed, sofa, rug, or other similar surfaces. This product should not be placed in a built-in installation such as a bookcase or rack unless proper ventilation is provided or the manufacturer's instructions have been adhered to.
- This product should be operated only from the type of power source indicated on the marking label. If you are not sure of the type of power supply to your home, consult your product dealer or local power company. For products intended to operate from battery power, or other sources, refer to the operating instructions.
- Power-supply cords should be routed so that they are not likely to be walked on or pinched by items placed upon or against them, paying particular attention to cords at plugs, convenience receptacles, and the point where they exit from the product.
- An outside antenna system should not be located in the vicinity of overhead power lines or other electric light or power circuits, or where it can fall into such power lines or circuits. When installing an outside antenna system, extreme care should be taken to keep from touching such power lines or circuits as contact with them might be fatal.
- Do not overload wall outlets, extension cords, or integral convenience receptacles as this can result in a risk of fire or electric shock.

IMPORTANT SAFETY INSTRUCTIONS

- Never push objects of any kind into this product through openings as they may touch dangerous voltage points or short-out parts that could result in a fire or electric shock. Never spill liquid of any kind on the product.
- Do not attempt to service this product yourself as opening or removing covers may expose you to dangerous voltage or other hazards. Refer all servicing to qualified service personnel.
- Unplug this product from the wall outlet and refer servicing to qualified service personnel under the following conditions:
 - *When the power-supply cord or plug is damaged.
 - *If liquid has been spilled, or objects have fallen into the product.
 - *If the product has been exposed to rain or water.
 - *If the product does not operate normally by following the operating instructions. Adjusting only those controls that are covered by the operating instructions as an improper adjustment of other controls may result in damage and will often require extensive work by a qualified technician to restore the product to its normal operation.
 - *If the product has been dropped or damaged in any way, or when the product exhibits a distinct change in performance - this indicated a need for service.
- Replacement Parts - When replacement parts are required, be sure the service technician has used replacement parts specified by the manufacturer or have the same characteristics as the original part. Unauthorized substitutions may result in fire, electric shock, or other hazards.
- Safety Check - Upon completion of any service or repairs to this product, ask the service technician to perform safety checks to determine that the product is in proper operating condition.
- The product should be mounted to a wall or ceiling only as recommended by the manufacturer.
- The product should be situated away from heat sources such as radiators, heat registers, stoves, or other products (including amplifiers) that produce heat.

Get to know us at: www.axvue.com

FCC Information

This device complies with part 15 of the FCC Rules. Operation is subject to the following two conditions: (1) This device may not cause harmful interference, and (2) This device must accept any interference received, including interference that may cause undesired operation.

CAUTION

Changes or modifications not expressly approved by AXVUE may void the users authority to operate this equipment.

NOTE

This equipment has been tested and found to comply with the limits for a Class B digital device, pursuant to Part 15 of the FCC Rules. These limits are designed to provide reasonable protection against harmful interference in a residential installation. This equipment generates, uses and can radiate radio frequency energy and, if not installed and used in accordance with the instructions, may cause harmful interference to radio communications. However, there is no guarantee that interference will not occur in a particular installation. If this equipment does cause harmful interference to radio or television reception, which can be determined by turning the equipment off and on, the user is encouraged to try to correct the interference by one or more of the following measures:

- Reorient or relocate the receiving antenna.
- Increase the separation between the equipment and receiver.
- Connect the equipment into an outlet on a circuit different from that to which the receiver is connected.
- Consult the dealer or an experienced radio / TV technician for help.

CAUTION

1. To comply with FCC RF exposure compliance requirements, a separation distance of at least 20 cm must be maintained between the antenna of this device and all persons.
2. This transmitter must not be co-located or operating in conjunction with any other antenna or transmitter.

Get to know us at: www.axvue.com

Colors and styles may vary.

Please retain information for future reference.

Body-worn Operation

This device was tested for typical body-worn operations.

To comply with RF exposure requirements, a minimum separation distance of 5mm must be maintained between the user's body and the handset

, including the antenna. Third-party belt-clips, holsters,

and similar accessories used by this device should not contain any metallic components.

Body-worn accessories that do not meet these requirements may not comply with

RF exposure requirements and should be avoided. Use only the

supplied or an approved antenna.



AXVUE INC.

19 W 34TH STREET SUITE 1018

NEW YORK, NY 10001

All rights Reserved.