

LA CROSSE® TECHNOLOGY



Smart Watch, Phone, and Earbuds pictured are not included.

Wattz 2.0
5W
projection alarm clock

5-in-1

- * projection alarm
- * 5w wireless charger
- * usb-a-charging port
- * usb-c-charging port
- * temperature/humidity

SET UP GUIDE

MODEL NUMBER 616A-1413 | 616-30357

Table of Contents

BASICS		ALARM		PROJECTION	
Initial Setup	02	Setting the Alarm	07	Projection Brightness	09
Buttons	03	Activate/Deactivate	08	Adjusting the Projection	09
LCD Display	04	Snooze Duration	08	Projection Image Options	10
Accessories & Ports	04				
LCD Display Brightness	05				
Auto-Dim Settings	05				
Display Modes	06				
Display Mode Options	06				
CHARGING		ADD-ON SENSOR		APPENDIX	
Wireless Phone Charger	11	Purchase Information	15	Specifications	18
Phone Compatibility	11	Add-On Sensor Setup	16	Warranty	19
Adjustable Charging Coil	12	Delete Add-on Sensor	16	Recycling & Disposal	19
USB Charging Ports	12	Lost Connection	17	Cautions/Statements	19-21
Earbud Charging	13	Low Battery	17	Trademarks & Warning	21
Accessory Storage	13				
Smart Watch Stand	14				
Headphone Stand	14				
Cable Organizer	15				
				SUPPORT	
		Support Information	22		
		Stay in Touch	22		

BASICS

Initial Setup

Power Up

Insert the 5V Power Adapter into an outlet, and then plug it into the Power Jack on the bottom of the alarm clock. Next, remove the Insulation Tab from the Clock's Battery Compartment.

A greeting will appear on the LCD and the clock will then automatically move into the Settings Menu.

Settings Menu Order

Beep On/Off • 12/24 Format • Hour • Minutes • Year • Month • Date • Fahrenheit/Celsius

Note: To enter the Settings Menu after the initial startup, hold the **SET** button on the top of the clock.



Use the +/- buttons on the top of the clock to adjust the values.

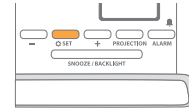

Press the **SET** button to confirm selection and move to next setting.

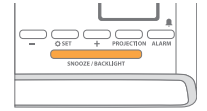

You may exit the Settings Menu at any time by pressing the **SNOOZE/BACKLIGHT** button.

Note: Weekday will set automatically after year, month, & date settings are adjusted.

BASICS

Buttons

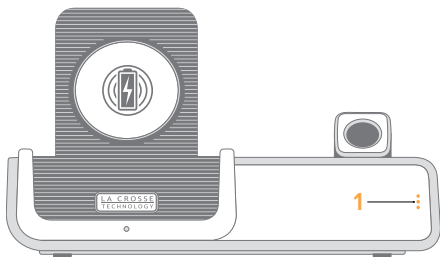

1. DISPLAY OPTION

Tap to select LCD display mode options

2. MINUS -

Press to decrease values, hold to change values quickly

3. SET

Hold to enter Settings Menu

4. PLUS +

Press to increase values, hold to change values quickly

5. PROJECTION

Press to adjust projection intensity. Hold to change projection mode*

6. ALARM

Press to activate/deactivate alarm. Hold to enter alarm settings

7. SNOOZE/BACKLIGHT

Press to adjust backlight or snooze a sounding alarm. Hold for Auto-Dim Settings.

8. ROTATION WHEEL

Scroll to rotate the projection image (left or right)

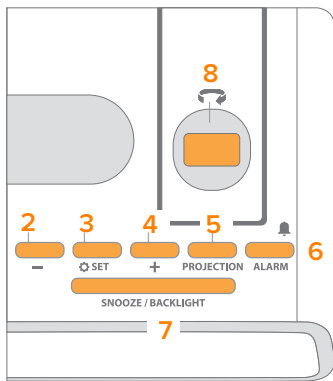

Top View

BASICS

LCD Display

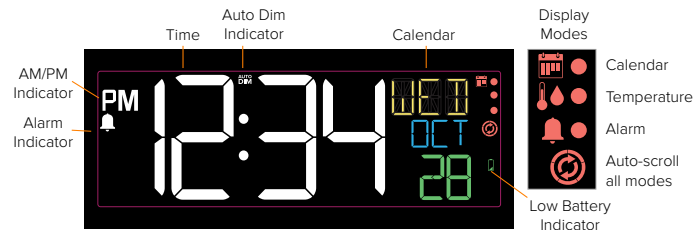

Accessories



Use, Organize & Store

1. Smart Watch Stand
2. Earbuds Dock
3. Dock Cover
4. Small Cable Fitting
5. Large Cable Fitting
6. Headphone Stand

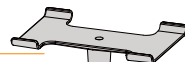

Ports

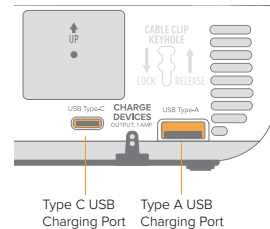

Back View

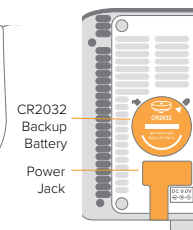

Bottom View

*An add-on sensor is required for additional projection options. See p.16 for details.

Small accessories are stored in the bottom compartment of your clock. The Dock Cover is on the top. Headphone stand is in the package.

LCD Display Brightness

Adjusting the LCD Display Brightness

Press the **SNOOZE/BACKLIGHT** button on the top of the clock to adjust the backlight intensity. There are 4 brightness levels, plus an off option.

Auto-Dim Settings

Program your LCD display to automatically dim during preselected times.

1. Hold the **SNOOZE/BACKLIGHT** button to enter the Auto-Dim Settings Menu.
2. Press the +/- buttons to turn the Auto-Dim feature on or off. Press the **SNOOZE/BACKLIGHT** to confirm.
3. Press the +/- buttons to adjust the starting hour. Press the **SNOOZE/BACKLIGHT** to confirm.
4. Press the +/- buttons to adjust the stopping hour. Press the **SNOOZE/BACKLIGHT** to confirm and exit.

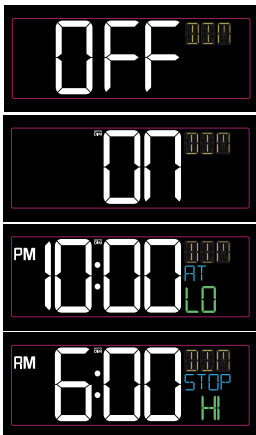

The **AUTO DIM** icon will appear on the LCD when activated.

Display Modes

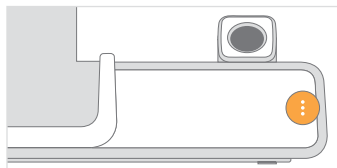

Selecting the Display Mode

Tap the **:** button on the front of the clock to select a display mode or automatically cycle through all of the available options.

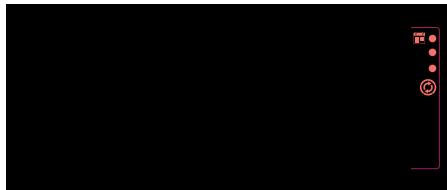

Display Modes



Calendar
Temperature
Alarm
Auto-scroll all modes

The Red Icons on the right side of the LCD indicate the current display mode.

The  icon will appear on the LCD when the Cycle Mode is active. This setting will automatically toggle through the available display mode options.

Display Mode Options



Weekday
Month + Date



Indoor
Temp/Humidity



Alarm Time
ON/OFF



Snooze
Countdown

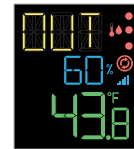



Outdoor
Temp/Humidity*

*An add-on sensor is required for outdoor data. See p.16 for details.

Time Alarm

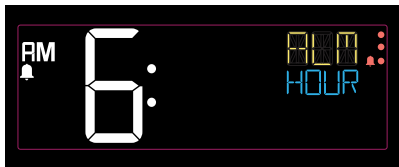
Setting the Alarm



1. Hold the  **ALARM** button on the top of the clock to enter the Alarm Settings Menu.

2. Use the +/- buttons to set your desired time. Press the **ALARM** button to confirm.

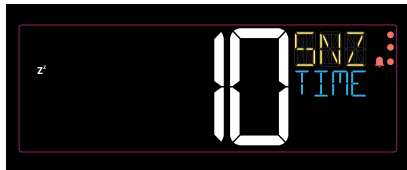

3. Next, use the +/- buttons to set your desired snooze duration (5 to 120 minutes). Press the **ALARM** button to confirm and exit the Alarm Settings Menu.

4. Your time alarm is now activated, indicated by the  icon on the LCD.

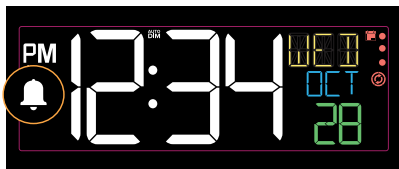

Time Alarm

Activating & Deactivating the Alarm

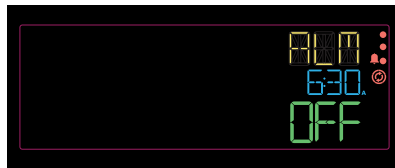

1. Press the **ALARM** button to activate/deactivate the alarm (ON/OFF).
2. The  icon will appear on the normal time display when the alarm is active.

Ascending Alarm

The alarm will increase in frequency over a 2-minute period. After the 2-minute time frame, the alarm will stop if not snoozed or turned off.

Snooze Duration Countdown



When your alarm sounds, press the **SNOOZE/BACKLIGHT** button to snooze your alarm for your preselected snooze duration. A countdown will appear on screen.



When the snooze time reaches "00," the alarm will sound again. The snooze feature can be repeated as many times as desired.

PROJECTION

Adjusting the Projection Image

Projection Brightness

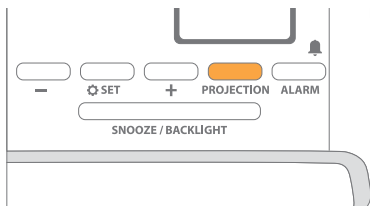

Press the **PROJECTION** button to adjust the projection's brightness (HI/LOW/OFF).

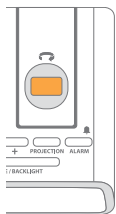

Use the Rotation Wheel on the Projection Arm to rotate the viewing angle of the image.

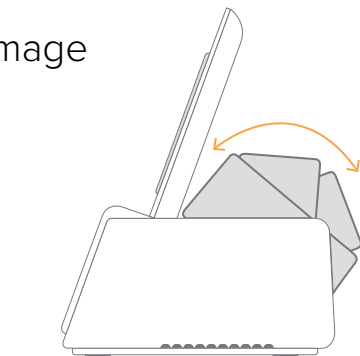

The Projection Arm tilts forwards and backwards to adjust the location of the projection image.

Note: The fixed focus projection image will look best at about 7ft. (2.1m).

PROJECTION

Projection Options

Projection Image Options

You can choose to see the (1) time, (2) outdoor temperature and humidity, or (3) cycle through both options.

Outdoor weather information is only available if an add-on sensor is connected.

Selecting Your Projection Image

1. When an outdoor sensor is connected, hold the **PROJECTION** button on the top of the clock to toggle between the projection options. If no sensor is connected, this button will only adjust the projection's brightness.
2. Time will be the default projection image. Hold and release the **PROJECTION** button each time to switch between projection modes.



Time-Only Projection

Outdoor Temperature & Humidity-Only Projection

Cycle Through Both Options

*An add-on sensor is required for additional projection options. See p.15 for details.



Current Time



Outdoor Temperature and Humidity

CHARGING

5W Wireless Charger

Charging your Qi-Enabled Phone

- Place your Qi-Enabled phone on the platform. Your phone should be centered and should sit flush to the charging cradle.
- The blue Charging Indicator Light below the platform will be solid when your phone is successfully charging.
- The light will flash slowly if your device is not positioned properly or if your device is not compatible with the wireless Qi charging technology. If this problem persists, try removing any large/bulky cases.



Phone Compatibility

Works with all Qi-Enabled phones, such as:

- iPhone 8 or newer
- Galaxy S8 or newer
- Galaxy Note 8 or newer

Compatibility may vary based on phone model and/or case selection. This list is not comprehensive. Please check your phone's manual for details regarding Qi-Enabled capabilities.

CHARGING

Adjustable Charging Coil

As phone sizes can vary greatly, simply slide the Phone Charger Adjustment Handle up or down to best match your device and get it charging correctly.

Note: Although this clock is capable of delivering 5W wireless charging, actual charging times will be determined by your mobile device.

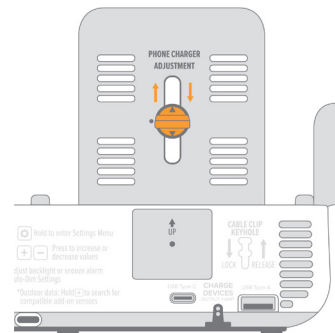

USB Charging Ports

There is a USB Type “A” Charging Port, and a USB Type “C” Charging Port located on the back of your alarm clock.

- Connect your external device's USB charging cable (not included) into the USB Charging Port.
- Charging times may vary.
- USB Power Output: 1 Amp maximum current



1 Amp

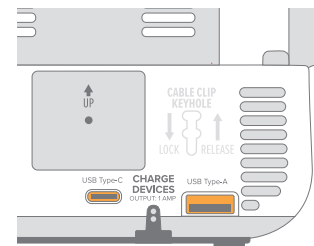

CHARGING

Earbud Charging

1. Remove the Dock Cover from the top of the alarm clock.
2. Open the bottom Accessory Compartment and find the Earbud Dock and Cable Fittings.
3. Feed your earbud charging cable (not included) up through the Earbud Dock, securing it with the correct Large or Small size Cable Fitting.
4. Wrap any extra cord up inside the Accessory Compartment and feed the charging end through the bottom hole.
5. Plug the cord into the appropriate 1 amp USB Charging Port.



Accessory Storage

The Earbud Dock, Cable Fittings, and Smart Watch Stand can all be stored in the Accessory Compartment on the bottom of the clock when not in use.

CHARGING

Smart Watch Stand

The removable Smart Watch Stand is engineered to fit a variety of smart watch brands. Its open design allows for easy access to your device's unique charging port location, for use with the included USB Charging Port.

How to attach the Smart Watch Stand

1. Remove the Smart Watch Stand from the Accessory Compartment on the bottom of the alarm clock.
2. Insert the watch stand into the left side of the clock.
3. Place your watch on the stand and attach its charging cord.
4. Plug the charging cord into the correct USB port.

Note: Smartwatch and charging cords not included.

Headphone Stand

How to attach the Headphone Stand

1. Insert the Headphone Stand into the hole on the top of the clock.
2. Place your headphones on the stand and attach their charging cord.
3. Plug the charging cord into the correct USB port.

Note: Headphones and charging cords not included.



Open design fits most smartwatches, including Apple Watch



CHARGING

Cable Organizer

Use the included Cable Organizer to keep your charging cords neat and secure. Insert the organizer into the Cable Clip Keyhole and slide it down to lock in place. Lift up and pull the Cable Organizer out to remove it.

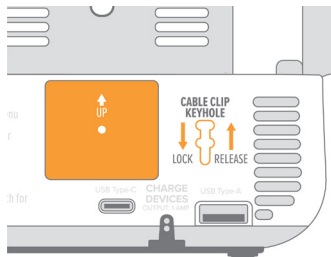

ADD-ON SENSOR

Optional Add-On Sensor



You can purchase an add-on Thermo-Hygro Sensor to get real-time temperature and humidity data, straight from your backyard.



Purchase Your Add-On Sensor at (or scan QR Code):
bit.ly/616a-1413_parts

Search for the compatible sensor using the alarm clock's model number (**616A-1413**).

ADD-ON SENSOR

Add-On Sensor Setup

1. Insert 2 "AA" Batteries into the sensor battery compartment.
2. Hold the + button on the clock to search for the sensor.
3. Press the **TX** button inside the sensor battery compartment to transmit a signal.

The sensor's data should then be viewable on your LCD and as an option to be projected.

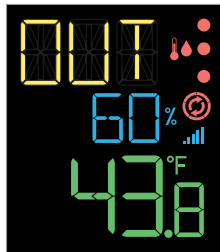

Outdoor
Temp/Humidity



Projection
Image

Delete Add-On Sensor

1. From normal display, press the – button to have the outdoor temperature reading begin flashing.
2. Hold the – button to delete the sensor. The sensor will remain deleted until manually reconnected.

Note: To manually reconnect the sensor, follow the Add-On Sensor Setup steps above.



ADD-ON SENSOR

Optional Add-On Sensor

Lost Connection

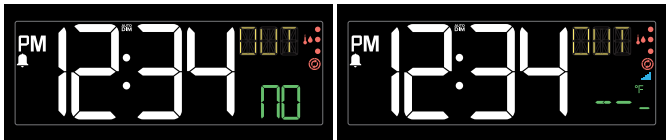
- If the sensor loses connection to the clock for any reason, the clock will show NO after 30 minutes of disconnection.



- The Sensor Reception Icon  will disappear from the bottom right of the LCD and the clock will search for up to 3 minutes every hour to try to reestablish the connection.
- To manually reconnect, hold the + button on the top of the clock to search for the sensor.
- Dashes will show while searching for the sensor and the  icon will flash for up to 3 minutes or until the sensor is connected.

Low Battery

The  icon will appear when the sensor batteries needs to be replaced.



APPENDIX

Specifications

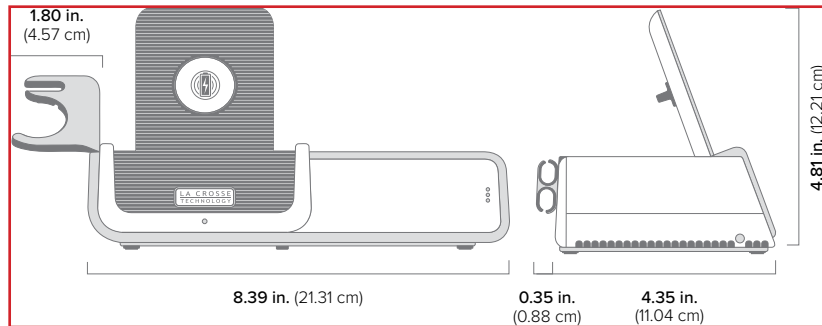

Power Requirements: 5.0V Power Cord (Included) HX18H-0503000-AU-001
CR2032 Battery for backup (Included)

The plug on the power adapter is intended to serve as the disconnect device, the socket-outlet shall be installed near the equipment and shall be easily accessible.

Projection Brightness: 2 Intensity Levels + OFF

LCD Brightness: 4 Intensity Levels + OFF (Programmable Auto-Dim Backlight Option)

Programmable Snooze Duration: 5 to 120 Minutes

Wireless Charger Power Output: 5 Watts

USB "A" and "C" Charging Port: 1 Amp Maximum Current (Charging Cords Not Included)

Indoor Temperature Range: 32°F to 122°F (0°C to 50°C)

Indoor Humidity Range: 10% to 99% RH

Settings Backup: The CR2032 Battery will save Time and Alarm Settings when power is lost. Projection will not show.

Warranty

La Crosse Technology, Ltd. provides a 1-year limited time warranty (from date of purchase) on this product, relating to manufacturing defects in materials and workmanship.

For full warranty details, you can visit: www.lacrossetechnology.com/support

La Crosse Technology, Ltd • 2830 S. 26th Street • La Crosse, WI 54601

Recycling & Disposal

Please consider the environment when deciding to dispose of this product. Although household electronics are generally safe to use on a daily basis, incorrect disposal can cause negative and potentially irreversible impacts on our environment.

Check with local donation centers to see if your product can be donated for future use. If disposal is the only option, federal agencies, local governments, and certified retailers may have electronic recycling programs in place. Programs may vary based on location.



Please Recycle

Caution!

The manufacturer is not responsible for any radio or TV interference caused by unauthorized changes or modifications to this equipment. Such changes or modifications could void the user authority to operate the equipment.

All rights reserved. This manual may not be reproduced in any form, even in part, or duplicated or processed using electronic, mechanical or chemical process without the written permission of the publisher.

This booklet may contain errors or misprints. The information it contains is regularly checked and corrections are included in subsequent editions. We disclaim any responsibility for any technical error or printing error, or their consequences. All trademarks and patents are recognized.

FCC Statement

1. This equipment has been tested and found to comply with the limits for a Class B digital device, pursuant to part 15 of the FCC Rules. These limits are designed to provide reasonable protection against harmful interference in a residential installation. This equipment generates, uses and can radiate radio frequency energy and, if not installed and used in accordance with the instructions, may cause harmful interference to radio communications. However, there is no guarantee that interference will not occur in a particular installation. If this equipment does cause harmful interference to radio or television reception, which can be determined by turning the equipment off and on, the user is encouraged to try to correct the interference by one or more of the following measures:

- Reorient or relocate the receiving antenna.
- Increase the separation between the equipment and receiver.
- Connect the equipment into an outlet on a circuit different from that to which the receiver is connected.
- Consult the dealer or an experienced radio/TV technician for help.

FCC Radiation Exposure Statement

This device complies with FCC radiation exposure limits set forth for an uncontrolled environment and it also complies with Part 15 of the FCC RF Rules. This equipment must be installed and operated in accordance with provided instructions and the antenna(s) used for this transmitter must be installed to provide a separation distance of at least 20 cm from all persons and must not be co-located or operating in conjunction with any other antenna or transmitter. End-users and installers must be provided with antenna installation instructions and consider removing the no-collocation statement.

This device complies with Part 15 of the FCC Rules. Operation is subject to the following two conditions:
 (1) this device may not cause harmful interference, and
 (2) this device must accept any interference received, including interference that may cause undesired operation.

Caution!

Any changes or modifications not expressly approved by the party responsible for compliance could void the user's authority to operate the equipment.

2. The interference potential of the device could cause the interference to the system whose fundamental is 110.5 KHz to 205 KHz.

Button Cell Battery



WARNING

1. This product contains a button battery.
2. If swallowed, it could cause severe injury or death in just 2 hours.
3. Seek medical attention immediately.

WARNING:

KEEP BATTERIES OUT OF REACH OF CHILDREN

1. Swallowing may lead to serious injury in as little as 2 hours or death, due to chemical burns and potential perforation of the esophagus.
2. If you suspect your child has swallowed or inserted a button battery, immediately seek urgent medical assistance.
3. Examine devices and make sure the battery compartment is correctly secured, e.g. that the screw or other mechanical fastener is tightened.
4. Do not use if compartment is not secure.
5. Dispose of used button batteries immediately and safely. Flat batteries can still be dangerous.
6. Tell others about the risk associated with button batteries and how to keep their children safe.

California Residents



WARNING:

This product can expose you to chemicals including styrene, which is known in the State of California to cause cancer.

For more information, go to: www.P65Warnings.ca.gov



WARNING: CHOKING HAZARD—Small Parts

Not for children under 3 yrs.

Trademarks & Warning

La Crosse Technology is not responsible for any damage or loss of performance with iPhone, iPod, or iPad while being used in associated with this accessory.

Apple is not responsible for the operation of this device or its compliance with safety and regulatory standards. Please note that the use of this accessory with iPhone, iPod, or iPad may affect wireless performance.

Apple, the Apple logo, iPad, iPhone, iPod, iPod touch, iTunes, Retina, Mac, Mac OS and OS X are trademarks of Apple Inc., registered in the U.S. and other countries.

Other company names and product names including Samsung, Galaxy, and Note are registered trademarks or trademarks of the respective companies.

Phone, charging accessories, and smart watch not included.

Important:

Wireless charging uses magnetic induction to charge your compatible smartphone. Do not place anything between your phone and the charging pad. Keep the charging pad clear of all foreign objects. Magnetic mounts, magnetic cases, or other objects between your phone and the wireless charger may reduce performance or damage magnetic strips or RFID chips found in some credit cards, security badges, passports, and key fobs. If your phone case holds any of these sensitive items, be sure to remove them before charging or make sure they are not between the back of your phone and the charging pad.

Having Trouble? We're here to help.

For detailed product videos, manuals, and more visit our support website: bit.ly/616a-1413_support

If you need additional assistance, contact our friendly customer support team:

Online: bit.ly/contact_techsupport

Phone Number: **1.608-782-1610**

Representatives available Monday-Friday, 8:00am to 6:00pm CST.



Stay in Touch

Ask questions, watch set up videos, and provide feedback on our social media outlets.



Follow La Crosse Technology on Youtube, Twitter, Facebook & Instagram.



LA CROSSE®
TECHNOLOGY

