

**DYMO**<sup>®</sup>



User Guide

LabelManager<sup>®</sup>

160

**Copyright**

© 2011 Sanford, L.P. All rights reserved.

No part of this document may be reproduced or transmitted in any form or by any means or translated into another language without the prior written consent of Sanford, L.P.

**Trademarks**

DYMO and LabelManager are registered marks in the US and other countries. All other trademarks are the property of their respective holders.

# Contents

<b>About Your New Label Maker</b> .....	<b>5</b>
Registering Your Label Maker .....	5
<b>Getting Started</b> .....	<b>5</b>
Connecting the Power .....	5
Inserting the Batteries .....	5
Connecting the Optional Power Adapter .....	5
Inserting and Removing the Label Cassette .....	5
<b>Using the Label Maker for the First Time</b> .....	<b>6</b>
<b>Getting to Know the Label Maker</b> .....	<b>6</b>
Power .....	6
LCD Display .....	6
Navigation Keys .....	6
Cancel .....	6
Backspace/Clear .....	6
Caps Mode .....	6
Menu .....	7
<b>Using Clip Art, Symbols, and Special Characters</b> .....	<b>7</b>
Adding Clip Art .....	7
Adding Symbols .....	7
Adding International Characters .....	7
<b>Formatting Your Label</b> .....	<b>7</b>
Changing the Font Size .....	7
Changing the Font Style .....	7
Adding Box and Underline Styles .....	8
Creating Vertical Labels .....	8
Creating Two-Line Labels .....	8
<b>Caring for Your Label Maker</b> .....	<b>8</b>
<b>Clip Art</b> .....	<b>9</b>
<b>Symbols</b> .....	<b>9</b>
<b>Troubleshooting</b> .....	<b>10</b>
<b>Documentation Feedback</b> .....	<b>11</b>
<b>Environmental Information</b> .....	<b>11</b>

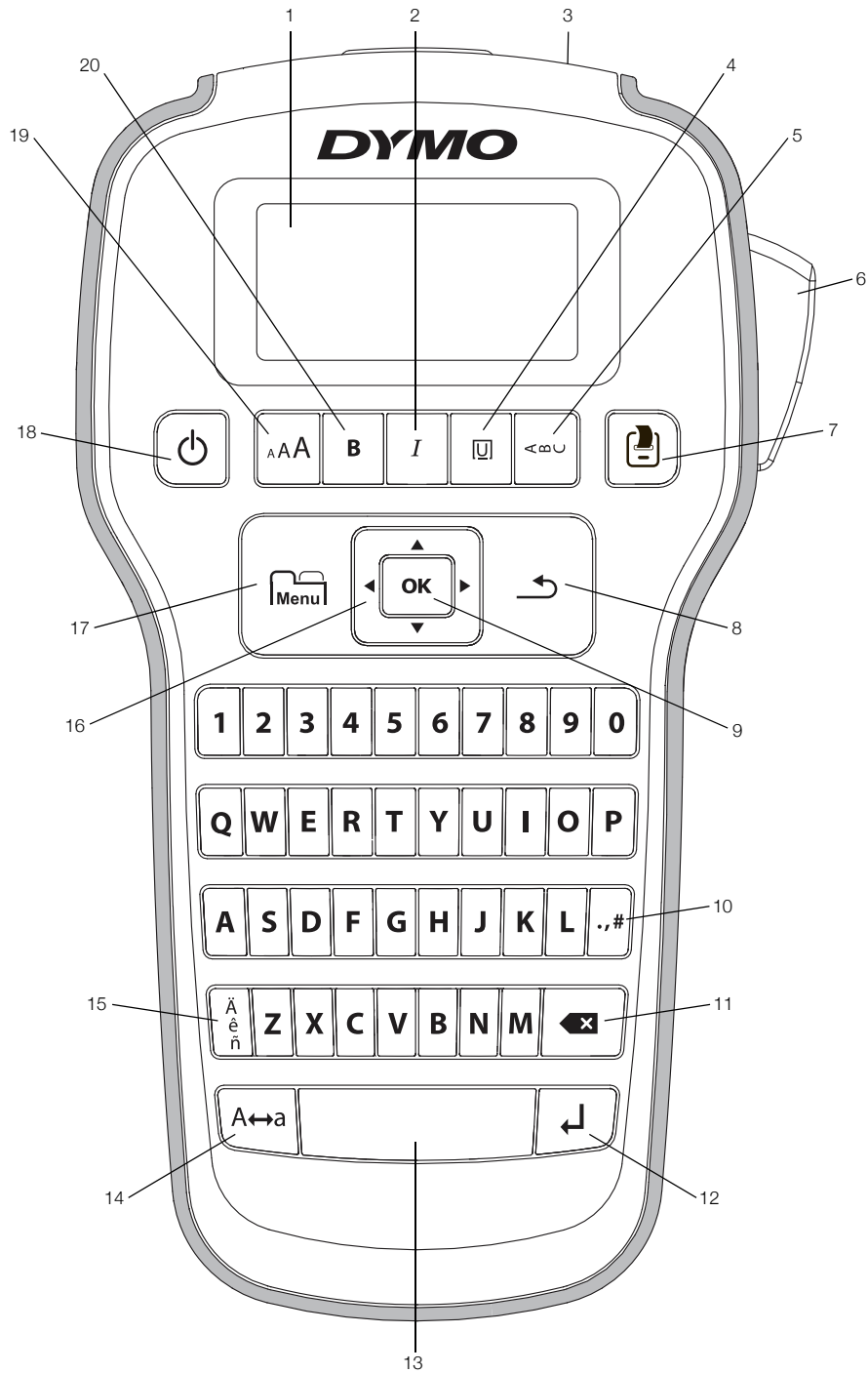

**Figure 1** DYMO LabelManager 160 Label Maker

- |                          |                                 |                               |
|--------------------------|---------------------------------|-------------------------------|
| <b>1</b> LCD display     | <b>8</b> Cancel                 | <b>15</b> Accented characters |
| <b>2</b> Italic          | <b>9</b> OK                     | <b>16</b> Navigation          |
| <b>3</b> Label exit slot | <b>10</b> Symbols – Punctuation | <b>17</b> Menu                |
| <b>4</b> Underline/Boxes | <b>11</b> Backspace             | <b>18</b> On/Off              |
| <b>5</b> Vertical        | <b>12</b> Return                | <b>19</b> Font size           |
| <b>6</b> Cutter button   | <b>13</b> Space bar             | <b>20</b> Bold                |
| <b>7</b> Print           | <b>14</b> Caps                  |                               |

## About Your New Label Maker

With the DYMO LabelManager 160 label maker, you can create a wide variety of high-quality, self-adhesive labels. You can choose to print your labels in many different font sizes and styles. The label maker uses DYMO D1 label cassettes in widths of 6 mm (1/4"), 9 mm (3/8"), or 12 mm (1/2"). Labels are available in a wide range of colors.

Visit [www.dymo.com](http://www.dymo.com) for information on obtaining labels and accessories for your label maker.

## Registering Your Label Maker

Visit [www.dymo.com/register](http://www.dymo.com/register) to register your label maker online.

Register your label maker to receive these benefits:

- An additional year of warranty
- Notification of availability of upgrades by email
- Special offers and new product announcements

During the registration process, you will need the serial number, which is located inside the back cover of the label maker.

## Getting Started

Follow the instructions in this section to print your first label.

### Connecting the Power

The label maker is powered by alkaline batteries or an optional AC power adapter. To save power, the label maker automatically turns off after two minutes of inactivity.

### Inserting the Batteries

The label maker is powered by six AAA alkaline batteries.

#### To insert the batteries

- 1 Press the thumb latch on the back of the label maker to remove the battery compartment cover. See Figure 2.

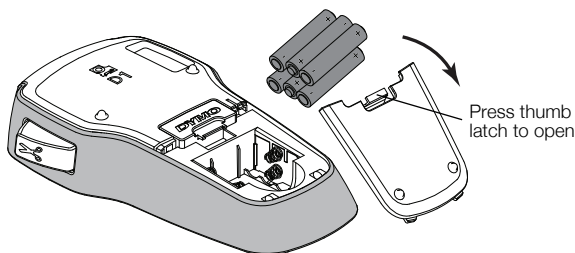



Figure 2

- 2 Insert the batteries following the polarity markings (+ and -).
- 3 Replace the battery compartment cover.

 Remove the batteries if the label maker will not be used for a long period of time.

### Connecting the Optional Power Adapter

An optional 9 Volt, 2 A power adapter can be used to power the label maker. Connecting the power adapter to the label maker disconnects the batteries as a power source.

#### To connect the optional power adapter

- 1 Plug the power adapter into the power connector on the top of the label maker.
- 2 Plug the other end of the power adapter into a power outlet.

### Inserting and Removing the Label Cassette

Your label maker uses DYMO D1 label cassettes. Visit [www.dymo.com](http://www.dymo.com) for information about purchasing additional label cassettes.

#### To insert the label cassette

- 1 Lift the label cassette cover to open the label compartment. See Figure 3.

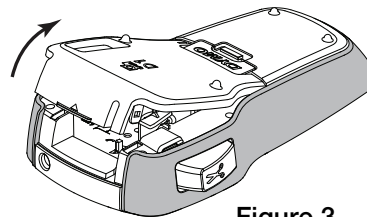

Figure 3

- 2 Make sure that the label and ribbon are taut across the mouth of the cassette and that the label passes between the label guides. See Figure 4.

If necessary, turn the ribbon rewind spool clockwise to tighten the ribbon.

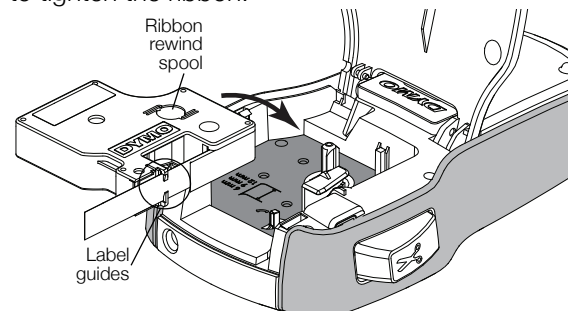

Figure 4

- 3 Insert the cassette and press firmly until the cassette clicks into place. See Figure 5.

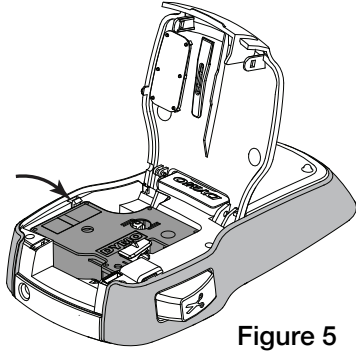



Figure 5

- 4 Close the label cassette cover.

 Each time you change the label cassette, you will be prompted to choose the label width.

#### To remove the label cassette

- 1 Lift the label cartridge door on the back of the printer.
- 2 Remove the label cassette.
- 3 Insert a new label cassette as described above.
- 4 Select the new label width when prompted by the label maker.

### Using the Label Maker for the First Time

The first time you turn on the power, you are asked to select the language, label width, and units of measure settings. These selections remain set until you change them.

You can change these selections using the  key.

#### To set up the label maker

- 1 Press  to turn on the label maker.
- 2 Select the language and press **OK**.
- 3 Select **Inches** or **mm** and press **OK**.
- 4 Select the width of the label cassette currently in the label maker and press **OK**.

You are now ready to print your first label.

#### To print a label

- 1 Enter text to create a simple label.
- 2 Press .
- 3 Press the cutter button to cut the label.
- 4 Remove the backing from the label to expose the adhesive, and then attach the label. See Figure 6.

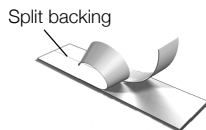



Figure 6

**Congratulations!** You printed your first label. Continue reading to learn more about the options available for creating labels.

## Getting to Know the Label Maker

Become familiar with the location of the function keys on your label maker. Refer to Figure 1 on page 4. The following sections describe each feature in detail.

### Power

The  key turns the label maker on and off. After two minutes of inactivity, the label maker is switched off automatically.

When the label maker is turned off, the current label text and formatting are remembered and will be displayed when power to the label maker is turned back on.

When the batteries are removed and the optional power adapter is disconnected, the current label text and formatting are lost.

### LCD Display

With DYMO's exclusive graphical display, most of the formatting you add is visible instantly.

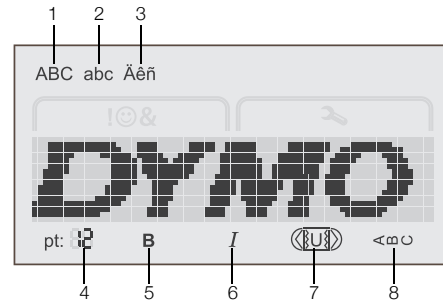

- |                       |                   |
|-----------------------|-------------------|
| 1 Uppercase           | 5 Bold            |
| 2 Lowercase           | 6 Italic          |
| 3 Accented characters | 7 Underline/Boxes |
| 4 Font size           | 8 Vertical        |

Feature indicators along the top and bottom of the LCD display appear black when a feature or setting is selected.



### Navigation Keys

You can review and edit your label using the left and right navigation keys. You can move through menu selections using all four navigation keys, and then press **OK** to make a selection.

### Cancel

The  key exits from a menu without making a selection or cancels an action, such as printing.

### Backspace/Clear

The  key deletes the character to the left of the cursor. Pressing and holding the  key quickly deletes the characters to the left of the cursor.

### Caps Mode

The  key toggles capitalization on or off. When CAPS mode is on, all the letters entered are in uppercase. When CAPS mode is off, all the letters entered are in lowercase. The default setting is CAPS mode on.

## Menu

The  key displays the Symbols/Clip Art and Settings tabs.

Pressing the  key toggles between the Symbols/Clip Art and Settings tabs.

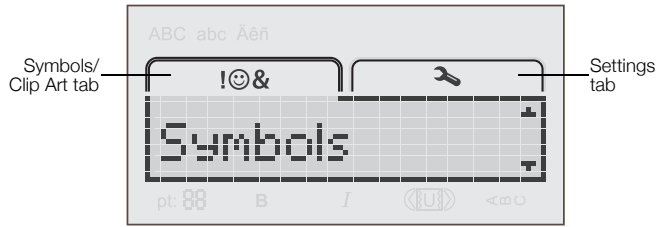

You can use the Symbols and Clip Art menu to insert symbols and clip art on your labels.

You can use the Settings menu to change the language, label width, and units of measure settings.



## Using Clip Art, Symbols, and Special Characters

You can add clip art, symbols, punctuation, and other special characters to your labels.

### Adding Clip Art

The label maker includes the clip art shown on page 9.



#### To insert clip art

- 1 Press .
- 2 Press  and  to select **Clip Art**.
- 3 Press **OK**.
- 4 Use the navigation keys to select the desired image.
- 5 Press **OK** to add the image to your label.

### Adding Symbols

The label maker supports the extended symbol set shown on page 9.

#### To insert a symbol

- 1 Press .
- 2 Press  and  to select **Symbols**.
- 3 Press **OK**.
- 4 Use the navigation keys to select the desired symbol.
- 5 Press **OK** to add the symbol to your label.

 You can quickly access the punctuation symbols by pressing **.,#**.

## Adding International Characters

The label maker supports the extended Latin character set.

Pressing  followed by a letter displays all of the available variations of that letter.

For example, if you press  and then the letter **a**, you will see **à á â ã ä** and so on through all the variations available.

### To add accented characters

- 1 Press  and then press an alpha character. The accent variations for that alpha character are displayed.
- 2 Use the navigation keys to select the character you want and press **OK**.

 You can also access the accent variations for a letter by pressing and briefly holding the corresponding alpha key.

## Formatting Your Label

You can choose from several format options to enhance the appearance of your labels.

### Changing the Font Size

Six font sizes are available for your labels.

The font sizes available depend on the label width selected. The font size applies to all characters on a label.

Label Width	Font Sizes Available
6 mm (1/4")	8, 10, 12 point
9 mm (3/8")	8, 10, 12, 16, 20 point
12 mm (1/2")	8, 10, 12, 16, 20, 24 point

### To change the font size

- ▶ Press **AA** until the desired font size is displayed.

### Changing the Font Style

Two font styles are available: bold and italic. These styles can be combined.

 Font styles are applied to all symbols and alphanumeric characters. However, font styles are not applied to clip art.

### To change the font style

- ▶ Press **B** to add or remove bold.
- ▶ Press **I** to add or remove italic.

The style is instantly visible in the display.



## Adding Box and Underline Styles

You can highlight the text by adding a box or underline style.

Five styles are available:

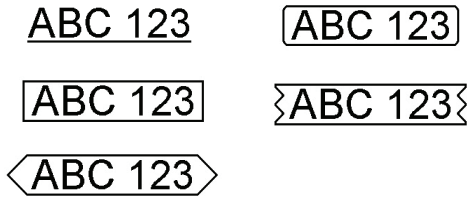

### To add a box or underline

- ▶ Press until the desired box or underline style is displayed.

A label can be underlined or enclosed within a box, but not both together.

When adding an underline on a two-line label, each line is underlined. When adding a box on a two-line label, both lines are enclosed in a single box.

## Creating Vertical Labels

You can print labels with the text oriented vertically.

When printing two-line vertical labels, the label will print with the second line of text after the first line.

### To create a vertical label

- 1 Press .
- 2 Enter text.
- 3 Press to print.

The underline style will not print on a vertical label.

## Creating Two-Line Labels

You can print a maximum of two lines on a label. Only one line of text can be printed on 6 mm (1/4") labels.

### To create a two-line label

- 1 Enter text for the first line and press .  
The symbol appears. This symbol is not printed.
- 2 Enter text for the second line.
- 3 Press to print.

## Caring for Your Label Maker

Your label maker is designed to give you long and trouble-free service, while requiring very little maintenance. Clean your label maker regularly to keep it working properly. Clean the cutter blade each time you replace the label cassette.

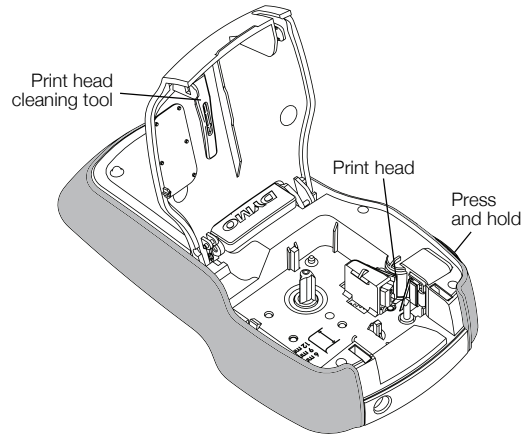

Figure 7

### To clean the cutter blade

- 1 Remove the label cassette.
- 2 Press and hold the cutter button to expose the cutter blade. See Figure 7.
- 3 Use a cotton ball and alcohol to clean both sides of the blade.

The cutter blade is extremely sharp. Use caution when cleaning.

### To clean the print head

- 1 Remove the label cassette.
- 2 Remove the print head cleaning tool from inside the label compartment cover. See Figure 7.
- 3 Gently wipe the padded side of the tool across the print head.



### Clip Art



### Symbols

'	"	,	.	;
!	?	i	¿	—
'	:	/	\	
§	•	¶	°	∞
€	\$	¢	£	¥
@	&	#	%	‰
+	-	*	÷	√
^	~	≈	=	≠
±	<	>	≤	≥
[	]	½	¼	¾
(	)	{	}	⅓
0	1	2	3	4
5	6	7	8	9
°	1	2	3	4
5	6	7	8	9
α	β	γ	δ	ε
ζ	η	θ	ι	κ
λ	μ	ν	ξ	ο
π	ρ	σ	τ	υ
φ	χ	ψ	ω	
A	B	Γ	Δ	E
Z	H	Θ	I	K
Λ	M	N	Ξ	O
Π	P	Σ	T	Υ
Φ	X	Ψ	Ω	

## Troubleshooting

Review the following possible solutions if you encounter a problem while using your label maker.

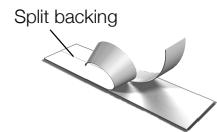
Problem/Error Message	Solution
No display	<ul style="list-style-type: none"> <li>■ Ensure the label maker is turned on.</li> <li>■ Replace batteries or connect the optional power adapter.</li> </ul>
Poor print quality	<ul style="list-style-type: none"> <li>■ Replace batteries or connect the optional power adapter.</li> <li>■ Ensure label cassette is installed properly.</li> <li>■ Clean the print head. See <b>Caring for Your Label Maker</b>.</li> <li>■ Replace the label cassette.</li> </ul>
Poor cutter performance	Clean the cutter blade. See <b>Caring for Your Label Maker</b> .
<b>Printing...</b>	No action required. Message disappears when printing is finished.
<b>Too many characters!</b> Exceeded maximum number of characters in buffer	Additional characters cannot be added.
<b>Too many lines!</b> Exceeded maximum number of lines	<ul style="list-style-type: none"> <li>■ Delete a line to fit text within the label width.</li> <li>■ Insert a wider label cassette.</li> </ul> <p>Only one line of text is allowed on 6 mm (1/4") labels. Up to two lines of text are allowed on 9 mm (3/8") and 12 mm (1/2") labels.</p>
 Battery low	Replace batteries or connect the optional power adapter.
<b>Insert cassette!</b> No label cassette is inserted.	Insert a label cassette. See <b>Inserting and Removing the Label Cassette</b> .
<b>Label jam!</b> Motor is stalled due to label jam.	<ul style="list-style-type: none"> <li>■ Remove jammed label; replace label cassette.</li> <li>■ Clean the cutter blade. See <b>Caring for Your Label Maker</b>.</li> </ul>
How do I remove the backing from the label?	<p>DYMO labels have an easy-to-peel split back.</p> <ol style="list-style-type: none"> <li>1 Locate the split on the label backing.</li> <li>2 Gently pinch the label length-wise, folding toward the printed side of the label. The label backing will separate.</li> <li>3 Carefully peel away the backing from the label.</li> </ol>



If you need further assistance, visit the DYMO Web site at [www.dymo.com](http://www.dymo.com).

## Documentation Feedback

We are constantly working to produce the highest quality documentation for our products. We welcome your feedback. Send us your comments or suggestions about our user guides. Please include the following information with your feedback:

- Product name, model number, and User Guide page number
- Brief description of instructions that are inaccurate or unclear, areas where more detail is needed, and so on

We also welcome your suggestions about additional topics you would like to see covered in the documentation.

Send email messages to: **documentation@dymo.com**

Keep in mind that this email address is only for documentation feedback. If you have a technical question, contact Customer Support.

## Environmental Information

The equipment that you have bought requires the extraction and use of natural resources for its production. It may contain substances that are hazardous to health and the environment.

In order to avoid the dissemination of those substances in our environment, and to diminish the pressure on natural resources, we encourage you to use the appropriate take-back systems. These systems will reuse or recycle most of the materials of your end-of-life equipment in an environmentally sound way.

The crossed-bin symbol marked on your device indicates you should use these systems.



If you need more information on the collection, reuse, and recycling of this product, please contact your local or regional waste administration.

You can also contact DYMO for more information on the environmental performance of our products.

This product is CE marked in accordance with the EMC directive and the low voltage directive and is designed to conform with the following international standards:  
US FCC Class B Compatibility  
Safety - UL, CUL, TUV, CE, T-Mark, SAA, BABT, C-Tick  
EMC - EMI Compatibility  
EN 55022; EN 61000 (+ addendums)  
RoHS 2002/95/EC