

LR3

QUICK START GUIDE



- 02 VEHICLE ACCESS
- 04 COMFORT AND SAFETY
- 08 CLIMATE CONTROL
- 09 EXTERIOR LIGHTING
- 10 FACIA OVERVIEW
- 11 WIPERS AND WASHERS
- 12 ON-ROAD AND OFF-ROAD
- 16 AUDIO SYSTEM
- 18 NAVIGATION AND TELEPHONE SYSTEMS
- 20 GAS STATION INFORMATION

Some of the information in this guide may not apply to your vehicle.

You must refer to your Owner's Handbook for full operating instructions.



Vehicle access

Remote control

Dependent upon specification and vehicle configuration, the operation of the remote control may differ from the following.

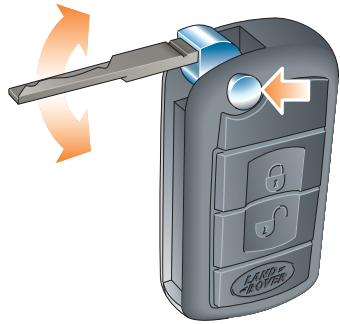

Automatic relock

If the vehicle is unlocked with the remote control, it will automatically relock and arm the alarm if a door or the tailgate is not opened within one minute.

Key blade

Press button (arrowed in illustration) to release the key blade.



- Press once to lock all doors and activate the alarm.



- Press once to deactivate the alarm and unlock the driver's door (**Single point entry**).
- A second press will unlock all other doors.



Customer configurable button. Can be programmed to remotely operate one of the following functions:

- Headlamp on (default).
- Panic alarm.
- Air suspension.

Refer to **Programming the remote control** in the Owner's Handbook.

Single point entry

This is a security feature that unlocks only the driver's door. It can be disabled on individual remote controls by simultaneously pressing and holding the lock and unlock buttons for three seconds. The vehicle will lock and then unlock in the currently selected mode to confirm the change.

Central locking

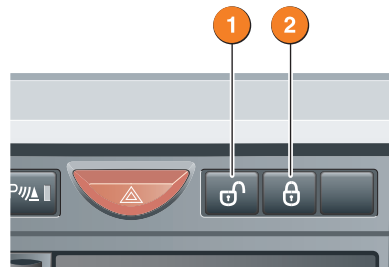

Master lock and unlock switches

1. Press to unlock all doors and tailgate.
2. Press to lock all doors and tailgate.

Speed-related locking

If enabled, the doors and tailgate will automatically lock when the vehicle's speed exceeds 5 mph.

This feature can be disabled or enabled in the **Settings** option accessed via the trip computer.

Tailgate

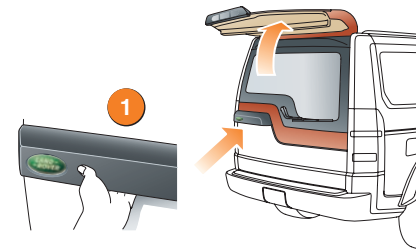

Opening the upper tailgate

With all the doors unlocked, press the release switch **1** on the underside of the exterior handle and pull to open.

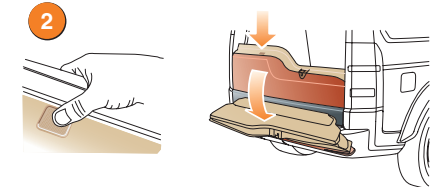

Opening the lower tailgate

With the upper tailgate open, press the touch pad **2** on the lower tailgate waist moulding.

Clock setting

The clock displayed on the audio unit and in the message centre is set via the audio unit menu.

To adjust the time:

1. Press the **MENU OK** button.
2. Rotate the rotary control clockwise until **Clock** is displayed and highlighted.
3. Press the control to select and enter the clock setting mode.
4. Dependent upon specification of audio unit, the time display may be changed between **12** and **24** hour modes.
5. Select **Set** to display the hour setting. Rotate the control to adjust and press to confirm.
6. The display then shows the minute setting. Rotate the control to adjust and press to confirm.

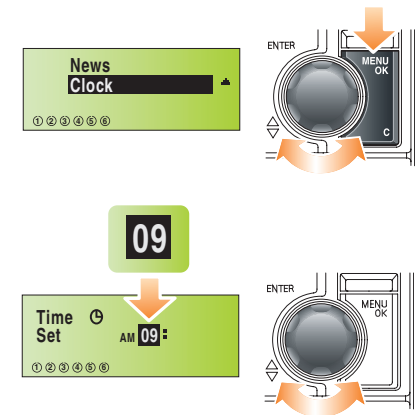

Comfort and safety

Driver's seat adjustment

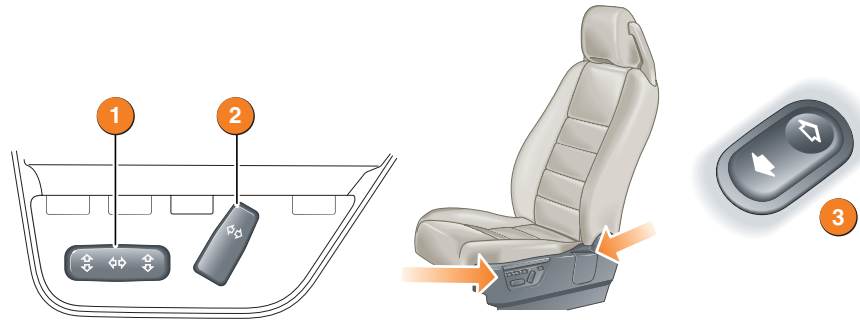

1. Seat fore/aft, cushion height and front tilt control switch.
2. Seat recline adjustment switch.
3. Lower backrest lumbar support switch.

Driving position memory

Once you have adjusted the driver's seat and exterior mirrors for your ideal driving position, the vehicle can memorise these settings for future use.

1. Press the memory store button to activate the memory function for five seconds.
2. Press one of the preset buttons within five seconds to memorise the current settings.

MEMORY STORED will be displayed on the message centre accompanied by an audible chime to confirm the settings have been memorised.

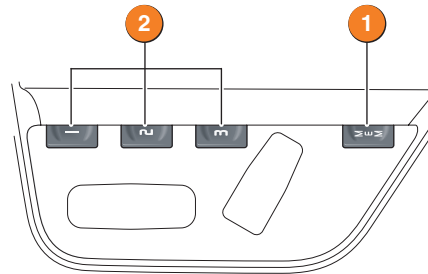

Operating note

A seat position will only be memorised during the five second active period.

Any existing settings will be over-written when programming a memory position.

Steering column adjustment

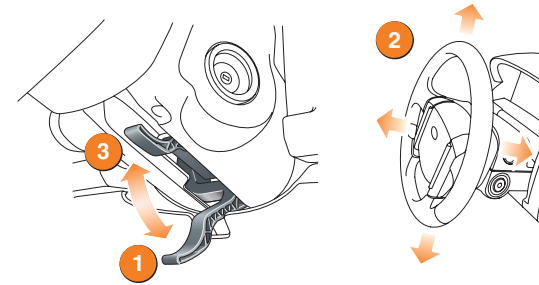

1. Move the lever located under the steering wheel fully downward.
2. Adjust the height and reach of the steering wheel to the desired position.
3. Move the lever fully up to lock the position of the wheel.

Windows and door mirrors

Windows

- To open a window, press and hold the respective switch.
- To close the window, pull and hold the switch. Window movement can be stopped at any time by releasing the switch.

The front windows have a one touch facility that allows them to be fully opened or closed with a single operation of the switch. Firmly press or lift the switch and release. Movement can be stopped by operating the switch again.

Press the right-hand side of switch **1** to inhibit the operation of the rear window switches.

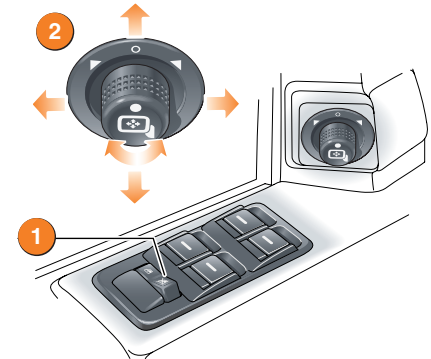

Resonance with lowered windows

If a resonance/booming sound occurs when a rear window is open, lowering an adjacent front window about 25 mm (1 inch) will eliminate the condition.

Door mirror adjustment

To adjust the mirrors, rotate the mirror adjustment knob **2** left or right to select the appropriate mirror. Move the knob in any direction to adjust the position of the mirror glass.

Comfort and safety

Sunroof

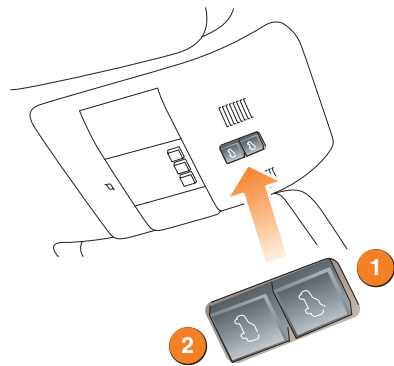

To open the sunroof:

- Press and release the rear of the switch **1** to open the roof to the tilt position.
- Press and release the rear of the switch again to open the roof fully.

Operating note

The sunroof can be operated with the starter switch in position **I** or **II** and for 40 seconds after position **0** has been selected, providing that neither front door has been opened.

With the starter switch in position **I** or **0**, the switch will need to be pressed and held until the roof reaches the desired position.

To close the sunroof:

- Press and release the front of the switch **2** to close the roof to the tilt position.
- Press and hold the front of the switch again to close the roof fully.

If the sunroof is moving, it can be stopped by pressing the switch again.

Homelink® transmitter

The buttons (arrowed) can be programmed to transmit radio frequencies that can operate external devices i.e. garage doors, entry gates, security systems, etc....

For more information, refer to **Garage transceiver** in the Owner's Handbook.

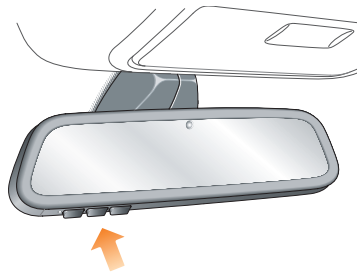

Seat belts and child restraints



A warning light on the instrument pack will illuminate to alert you that the driver's and/or front passenger's seat belt is unbuckled.

Automatic Locking Reels (ALR)

All passenger seat belts have ALR fitted for use with child seats or securing large items.

- To enable: extend belt to maximum length.
- Allow seat belt to retract onto the child seat/item (a clicking sound will be heard as the belt retracts). Ensure there is no slack by pressing the seat/item firmly into the vehicle seat.
- To disable: unbuckle the belt and allow the belt to fully retract.

With ALR enabled, as the seat belt retracts, it will automatically lock preventing re-extension.

Ensure passengers do not fully extend the restraints and inadvertently engage this feature during normal use.

Recommended child seat

Land Rover strongly recommends the use of LATCH (Lower Anchors and Tethers for Children) child seats.

LATCH child seats can only be fitted in the second-row outer seating positions.

Passenger air bag

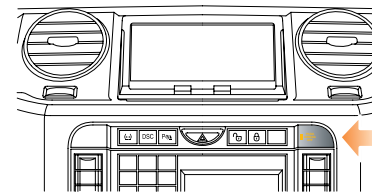

The front passenger seat is fitted with an occupancy sensor system that determines the state of seat occupancy and sets the air bag status to suit;

- Seat unoccupied - air bag deactivated and indicator off.
- Seat occupied - air bag activated and indicator off.
- Seat occupied by a child seat or low weight object - air bag deactivated and indicator on.

For further information, refer to **Occupant detection** in the Owner's Handbook

Operating note

If the indicator becomes permanently illuminated when the seat is definitely empty, please contact your Land Rover Dealer immediately.

Climate control and exterior lighting

Climate control

Dependent upon specification, the control panel may differ from the one shown.

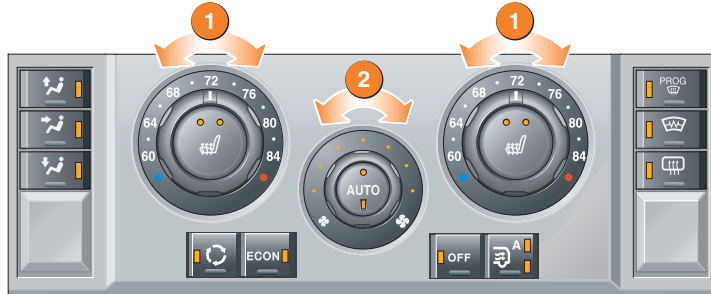

Recommended mode

Select **AUTO** as the normal operating mode. This will help prevent window misting.

AUTO (automatic) MODE

Press **AUTO** to select automatic operation of the system, both LEDs in the switch will illuminate.

The system will adjust the heat output, blower speed, air intake and airflow distribution to maintain the selected temperature(s) and reduce misting without further adjustments.

The air distribution and blower controls can be operated to override the automatic settings. This will extinguish the appropriate LED in the **AUTO** control.

External water deposits

The air conditioning system removes moisture from the air and deposits excess water beneath the vehicle. Puddles may form, but this is normal and no cause for concern.

Temperature selection

Rotate the controls **1** to adjust the temperature for the respective side of the passenger compartment.

Operating note

It is not possible to achieve a temperature differential of more than 7°F between the left and right.

Blower speed

Rotate the blower control **2** to adjust airflow through the vents.

Air distribution control

Press to select the desired distribution setting. An LED will illuminate in the switch.

Windshield and side window vents

Face level vents

Foot level vents

More than one setting can be selected to achieve the desired distribution.

Heated windshield (when fitted)

Heated rear window

Exterior lighting

Exterior lamps master switch

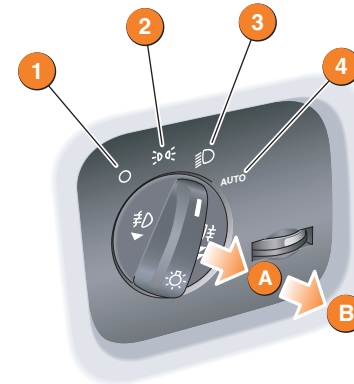

1. Exterior lamps off
2. Side lamps
3. Headlamps
4. Autolamps

In **AUTO** mode and the starter switch in position **II**, a sensor monitors the exterior light levels and will automatically switch the side lamps and dipped headlamps ON and OFF as required.

A. Front fog lamps

Pull the switch to position **A** to switch on the front fog lamps.

B. Rear fog lamps

Pull the switch to position **B** to switch on the rear fog lamps.

Fog lamps cannot be operated if the lamps master switch is in **AUTO**.

Direction indicators

Move the lever up or down to activate the direction indicators.

Moving the lever up or down against spring pressure and then releasing will flash the indicators three times. Useful for lane changing.

Headlamp high beam

Push the lever away from you to select headlamp high beam. A warning indicator will illuminate on the instrument pack.

To flash the headlamps, pull the lever towards the steering wheel and then release.

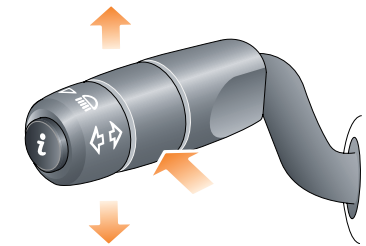

Facia overview

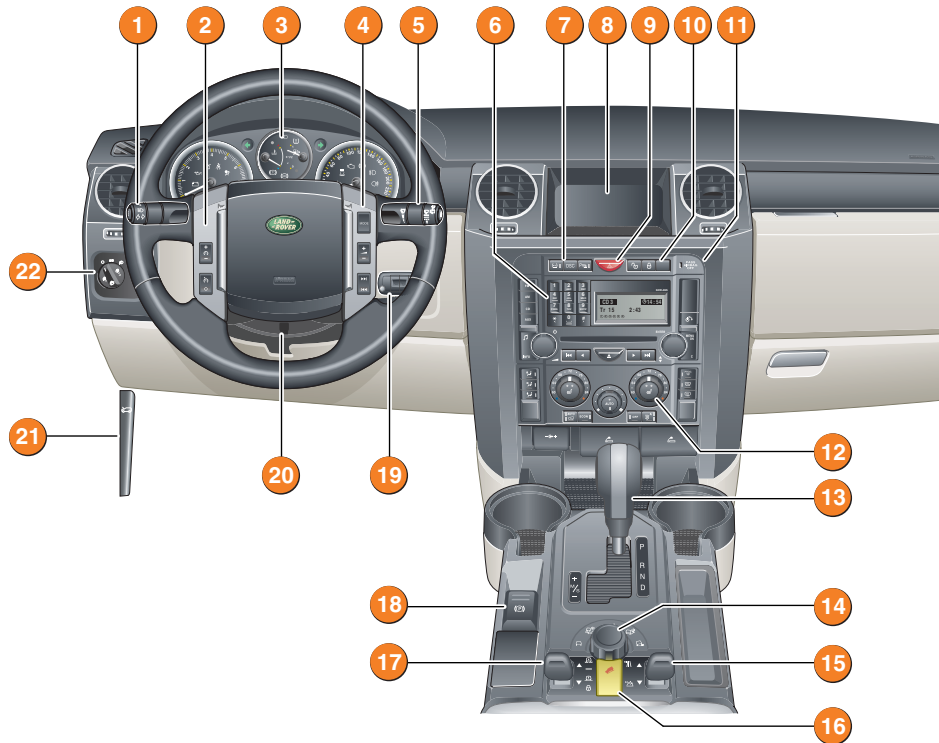

- | | |
|---|-------------------------------------|
| 1 Direction indicators/headlamps/trip computer switch | 12 Heater/air conditioning controls |
| 2 Cruise control switches | 13 Gear selector |
| 3 Instrument pack/warning indicators and message centre | 14 Terrain response control switch |
| 4 Audio/telephone switches | 15 Transfer gearbox switch |
| 5 Wiper/washer switch | 16 Hill Descent Control switch |
| 6 Audio system | 17 Air suspension control |
| 7 Dynamic stability control (DSC) switch | 18 Electric parking brake |
| 8 Touch screen | 19 Starter switch |
| 9 Hazard warning switch | 20 Steering column adjustment |
| 10 Master locking switches | 21 Hood release |
| 11 Passenger air bag status indicator | 22 Exterior lamps master switch |

Warning indicators (information)

The following will illuminate during normal driving to indicate that a particular system or feature is operating. If any other warning indicator illuminates, refer to Owner's Handbook.

- | | | | |
|--|-------------------------------|--|---------------------------|
| | Seat belt reminder | | Side lamps on |
| | Door open | | Headlamp high beam on |
| | LOW gear range selected | | Rear fog lamps on |
| | Hill Descent Control (HDC) on | | Front fog lamps on |
| | Cruise control active | | Electric parking brake on |
| | Direction indicator | | |

Wipers and washers

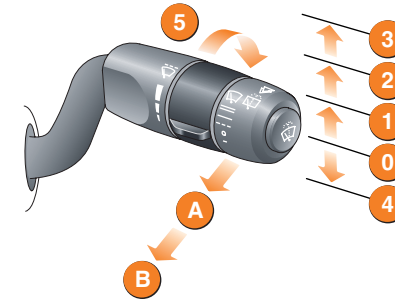

Windshield wiper

- Intermittent wipe or rain sensor operation.
- Normal speed operation.
- High speed operation.
- Single wipe - press down and release to operate.
- Rotate collar to adjust speed of intermittent wipe or sensitivity of the rain sensor.

	Intermittent wipe	Rain sensor
	Short delay.	Most sensitive to rain.
	Long delay.	Least sensitive to rain.

Windshield washer

- Press and release the button on the end of the lever to operate the windshield washer.
- Press and hold the button to operate the windshield washer and wipers.

Rear wiper and washer

- Pull the lever to position **A** for intermittent operation of the rear wiper. Pull and hold the lever in position **B** to operate the rear washer and wiper.

On-road and off-road

Electric parking brake

Applying

- With the vehicle stationary, pull up the parking brake lever and then release it. The red warning indicator in the instrument pack will illuminate.

Releasing

- The starter switch must be in position **I** or **II**. Apply the foot brake and press down on the parking brake lever.
- If the vehicle is stationary with the parkbrake applied and either **D** (Drive) or **R** (Reverse) selected, pressing the accelerator will automatically release the parking brake.

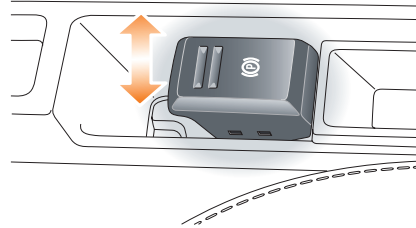

Automatic transmission

Gearshift interlock

The starter switch must be in position **II**, the foot brake applied and the selector release button pressed before the gear selector can be moved from **P** (Park) to **R** (Reverse).

The gear selector must be in the **P** position before the starter key can be removed.

Sport mode



In Sport mode, automatic gear changing is maintained but the gearshift changes are modified to improve performance.

To select Sport mode, move the gear selector from the **D** (Drive) position towards the left hand side of the vehicle.

The word **SPORT** will appear on the instrument pack display and the LED in the gear selector surround will illuminate.

With the gear selector in Sport, the transmission will stay in lower gears for longer with downshifts occurring more readily. Fuel consumption will be adversely affected. If Terrain Response is fitted, Sport mode is only available if the **General** program is selected.

CommandShift™

CommandShift gear selection can be used as an alternative to automatic gear selection and is particularly effective when rapid acceleration or engine braking is required.

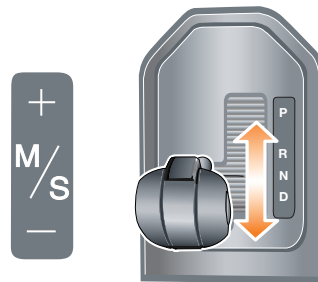

- Select Sport mode. The transmission will automatically select the gear most appropriate to the vehicle's road speed and accelerator position.
- Moving the selector lever forward (+) or backward (-) and then releasing will manually select a higher or lower gear (when available). The message **TRANSMISSION COMMANDSHIFT SELECTED** will appear in the message centre.
- Subsequent gear selections will display the selected gear on the instrument pack display.
- To deselect CommandShift mode, move the selector lever back to the **D** position.

Cruise control

Cruise control enables the driver to maintain a constant road speed without using the accelerator pedal.

- SET +**: to set a road speed or increase the speed in 1 mph steps when cruise control is operating.
- SET -**: to set a road speed or decrease the speed in 1 mph steps when cruise control is operating.
- RESUME**: resumes a SET speed retained in memory.
- CANCEL**: cancel cruise control but retains the set speed in memory.

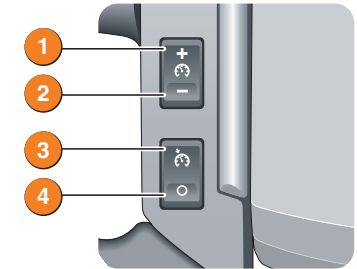

Cruise control will automatically **disengage** when the **brake pedal** is used or when the vehicle speed falls below 18 mph.

Air suspension

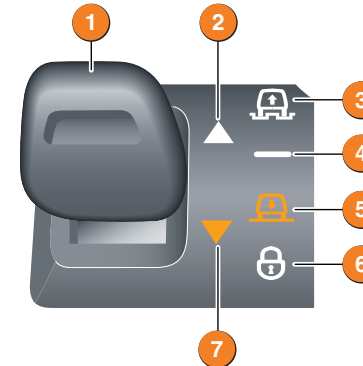

Vehicle height can be manually adjusted via the raise/lower lever **1**. Height changes may only be made when the engine is running and the driver and passenger doors are closed.

Indicators **2** or **7** will illuminate to show the direction of movement. They extinguish when the height change movement is completed.

Off-road height **3**, provides improved ground clearance and approach, departure and break-over angles.

On-road height **4**, is the normal height for the vehicle.

Access height **5**, lowers the vehicle to provide easier entry, exit and loading of the vehicle. This position may be selected up to 40 seconds after the starter switch is turned off.

Crawl (locked at Access height) **6**, allows the vehicle to be driven at low speeds at access height, to give increased roof clearance.

Vehicle height will be automatically adjusted according to road speed in order to maintain driveability and handling.

Some of the Terrain Response programs will automatically adjust the suspension height.

On-road and off-road

Terrain response system



The Terrain Response system is always active and cannot be switched off. When the vehicle is started the system will normally start in the **General** program.

Manual selection of a special program, by rotating the knob, will provide benefits in how the vehicle can be driven over different surfaces or terrains by automatically adjusting the vehicle's drive and suspension systems.

It is recommended that a special program be engaged whenever driving conditions could become difficult, and cancelled once the conditions for use are no longer present.

Wading

When wading through water, select the program suitable for the surface beneath the water. The maximum depth of the water should not exceed 600 mm (24 inches).

Hill Descent Control (HDC)

HDC operates in conjunction with the anti-lock braking system to provide greater control in off-road situations particularly when descending severe gradients.



Press the switch (arrowed in illustration) to select HDC. HDC can be selected at speeds below 80 km/h (50 mph) but will not be fully active until the vehicle speed reduces below 50 km/h (30 mph), confirmed by a continuously illuminated HDC indicator in the instrument pack.

Press the switch again to deselect HDC.

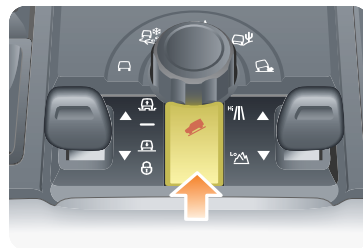

General

Suitable for surfaces that match typical road surfaces.



Grass-Gravel-Snow

Suitable for surfaces which are firm but have a slippery surface, e.g. grass, snow, loose gravel, pebbles or icy conditions.



Mud-Ruts

Suitable for soft, muddy, uneven or deeply rutted ground. It is recommended that LOW range is selected on the Transfer gearbox.



Sand

Suitable for soft, predominantly dry, yielding sandy ground, e.g. sand dunes and deserts. If the sand is damp or wet, the Mud-Ruts program may be more beneficial.



Rock Crawl

Only selectable when the transfer gearbox is in LOW range. Suitable for crossing wet or dry, solid unyielding ground requiring high levels of wheel displacement, e.g. clusters of boulders or rocky river beds.

Transfer gearbox

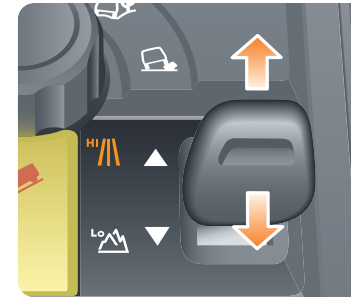

HIGH range should be used for all normal road driving and also for off-road driving across dry level terrain.



LOW range should be used in situations where low speed manoeuvring is necessary, or in extreme off-road conditions.

Range changing

The recommended method for range changing is with the vehicle stationary. With the engine running, and the main gearbox in **N** (Neutral), move the transfer gearbox lever to the required position and then release. The indicators on the switch and instrument pack display will flash during range changing. When range changing is complete a chime will sound and a message will be displayed on the message centre.

Parking aid

With the ignition on, the front and rear parking aids are activated whenever reverse gear is selected. A short confirmation tone will sound after one second.

If an obstruction is detected by the sensors, an intermittent tone will sound (higher pitch for objects detected by the front sensors). As the vehicle moves closer to the obstruction the intermittent tone increases in frequency.

When the distance between the sensor and the obstruction is less than approximately 30 cm (1 foot), the tone becomes continuous.

The parking aid is automatically switched off when the vehicle's forward speed exceeds 16 km/h (10 mph).



Front parking aid - manual operation

When driving into a limited space, the front parking aid can be manually activated by pressing the switch on the fascia. The switch will illuminate and a short confirmation tone will sound.

Audio system

Audio system controls

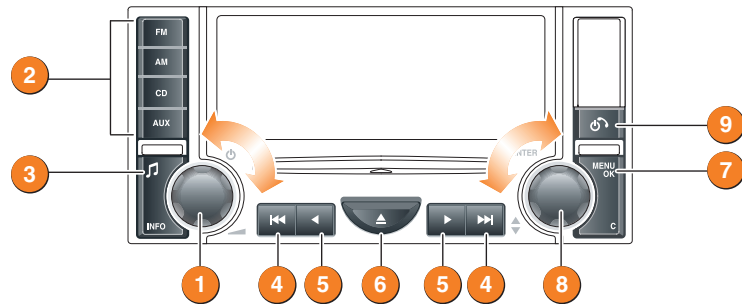

1. Press to switch audio unit on/off and rotate to adjust the volume.
2. Press the appropriate mode button to select FM, AM, CD or AUX.
3. Press button repeatedly to scroll through the sound settings options. With the desired sound setting selected, rotate control 1 to adjust. Confirm new setting by pressing button 3.
4. Press to automatically search for a radio station or select a track on a CD.
5. Press to manually search for a radio station or to search in a CD track
6. Press to eject the currently selected CD.
7. Press to access the audio unit menu.
8. Rotate control to scroll through menu options or adjust settings. Press control to select a menu item or confirm a change.
9. Telephone.

Steering wheel controls

1. Press to switch between Radio, CD or AUX.
2. Press to increase volume.
3. Press to decrease volume.
4. Press and release to scroll through preset radio stations or CD tracks. Press and hold for two seconds to search up for the next radio station or to advance through the CD track.
5. Press and release to scroll through preset radio stations or CD tracks. Press and hold for two seconds to search down for the next radio station or to reverse through the CD track.

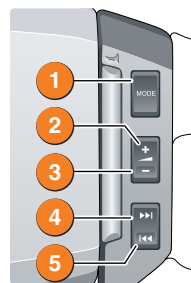

Radio operation

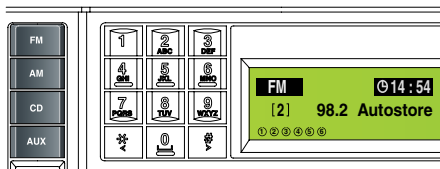

Press either the **FM** or **AM** button to select the required waveband. Repeated presses of either button will scroll through the FM and AM waveband memory options.

Storing radio stations

To automatically store radio stations, press and hold either the **FM** or **AM** button. **Autostore** will be shown on the information display and the stations will be stored under the preset numbers in the selected waveband.

To recall a preset station, press and release one of the numbered preset buttons.

To manually store a selection of radio presets, refer to the Owner's Handbook.

Satellite radio

Call Sirius
SAT Info.
Clock

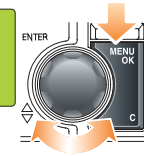

ESN 1234567890AB

In order to activate and use the satellite radio, you will need to call the satellite radio service provider (Sirius) and provide them with the Electronic Serial Number (ESN) of your audio unit.

To view the ESN:

1. Press the **MENU OK** button.
2. Rotate control to select **SAT Info**.
3. Press control to display the **ESN**.

The telephone number for Sirius can be found in the menu under **Call Sirius**.

CD operation

Compatible disc types

The use of discs with paper labels or double sided dual format discs (CD/DVD) should be avoided as they could become jammed.

Loading CDs

The audio unit features an integral 6-disc autochanger.

To insert a single disc, press the **CD** button, then one of the number buttons (1 to 6). When prompted by the information display, insert the disc, label side up. The autochanger will load the CD in the selected position.

To fully load the autochanger, press and hold the **CD** button. The information display will show **Loading All**. When prompted, insert a disc, label side up. This process is repeated until all six CD positions are occupied.



Playing CDs

When in CD mode, press the appropriate CD number (1 to 6) to start playing the selected disc. Playback commences and progresses sequentially through all of the loaded discs.

Playback can be paused by briefly pressing one of the other mode buttons (**FM**, **AM** or **AUX**). Playback will resume when the CD button is pressed again.

Ejecting CDs

To eject a single disc, select the required disc by pressing one of the number buttons 1 to 6 and then press the eject button (arrowed).

To eject all loaded discs, press and hold the eject button, the discs will be ejected one at a time. Remove disc(s) only when the display shows the message **Remove Disc**.

Navigation and telephone systems

Navigation

The screen allows touch-control of the navigation system. Only a light touch is required to operate the function, excess pressure on the screen could result in damage. On initial activation, ensure that both the correct country and area have been selected.

Setting a destination

To set a destination and start using the navigation system, use the following procedure:

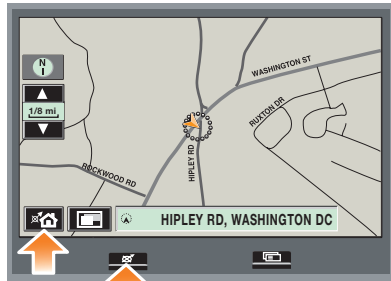

1. Press the **Navigation** button on the display surround, and when prompted, touch **Agree** to access the initial Home menu.
2. Touch the **Home** icon on the screen to access the navigation menu.

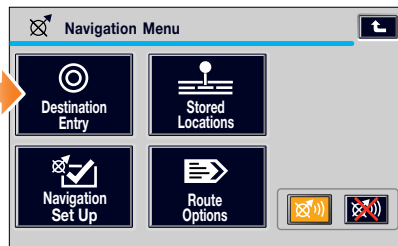

3. Touch the **Destination Entry** icon.

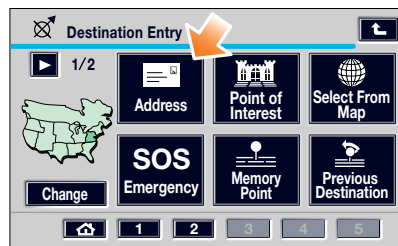

4. Touch the **Address** icon, then enter details using the on-screen keypad. Touch **OK** to enter.

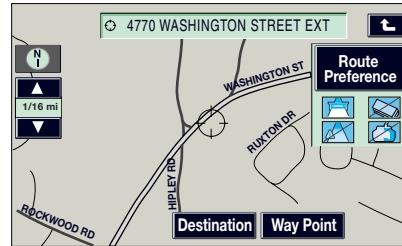

5. Once found, the screen displays the destination. To change the route settings, touch **Route Preference**, or touch **Destination** to start the route calculation.

Route preferences

When set, route preferences are remembered and used for calculating all new routes. If you encounter problems with the type of routes being selected or the guidance being given, please check the route preferences.

6. Once calculated, the screen highlights the route. Touch **3 Routes** to select an alternate route, or touch **Start** to start navigation. Drive away, following the voice guidance.

 Touch the audible repeat icon to hear the last voice instruction again.

When your destination is reached, voice and visual confirmation is given.

 **Cancelling guidance**
Touch the **Home** icon, select **Route options**, **Cancel guidance** and touch **Yes** to confirm.

Telephone – Bluetooth system

Mobile phones with Bluetooth capability can communicate with the vehicle's inbuilt telephone feature.

The following procedure demonstrates how to connect the most popular brands of mobile phone.

Pairing a handset to the vehicle's system

Prepare the mobile phone for pairing to the system. See the telephone manufacturer's instructions for further details, or follow the table below for generic commands.

Nokia	Motorola	Ericsson
1 Select Menu	Select Menu	Select Menu
2 Select Settings	Select Settings	Select Connectivity
3 Select Bluetooth OR Connectivity then Bluetooth	Select Connection	Select Bluetooth
4 Select On	Select Bluetooth link	Select My Devices
5 Select Search for audio devices	Select Hands-free	With New Device highlighted, select Add. Press OK to confirm
6 After search, select Land Rover	Select Look for devices	After search, select Land Rover
7 Enter pass code 2121. Press OK to confirm.	After search, select Land Rover	Select Connect
8 No connection? Select Bluetooth (Menu) then Paired devices Land Rover	Permission to bond? Select Yes, and enter pass code 2121	Enter pass code 2121 after prompt



When the handset has been successfully paired to the system, **Bluetooth** will appear on the Phone menu screen.

If more than one paired Bluetooth phone is in range, the system will automatically select the last phone used in Bluetooth mode.

Mobile phone compatibility

There are a number of mobile phones that have been tested for full functionality with the Land Rover system, however not all phones are compatible and some may only be partially compatible. For the latest list of compatible phones and software versions, please refer to www.ownerinfo.landrover.com. Alternatively consult your Dealer.

Making a call

1. With a paired or docked handset, press the  button on the audio unit, or operate the answer call switch **1** on the steering wheel controls.
2. Enter the required telephone number using the numeric keypad.
3. Press the  button, or operate the answer call switch **1** on the steering wheel to send.

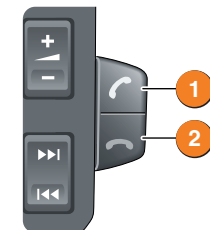
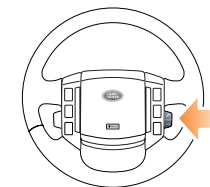

Receiving a call

To answer an incoming call, press the  button on the audio unit, or operate the answer call switch **1** on the steering wheel controls.

To end, or reject an incoming call, press the **C** button on the audio unit, or operate the end call switch **2** on the steering wheel.

Gas station information

Fuel filling

Fuel filler flap location



A small arrow on the fuel gauge indicates which side the fuel filler flap is located.

Fuel filler flap opening

Press and release the centre of the left edge of the fuel filler flap (where arrowed) to open.

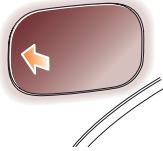

Operating note

The fuel flap has a spring loaded release, do not force it open.

Docking the filler cap

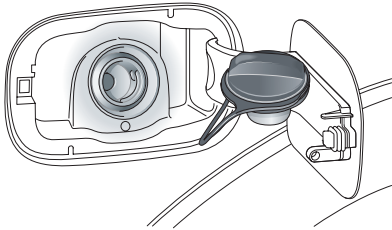

The filler cap is secured to the vehicle by a strap. For your convenience a holder is provided on the flap to store the cap whilst refuelling.

Fuel specification

The correct fuel specification for your vehicle is shown on the inside of the fuel filler flap.

Equipment necessary for use of fuels containing more than 10 per cent ethanol is not fitted to this vehicle.

Do not use E85 fuels (85 per cent ethanol content). If E85 fuels are used serious engine and fuel system damage will occur.

Tire pressures

Tire pressure label

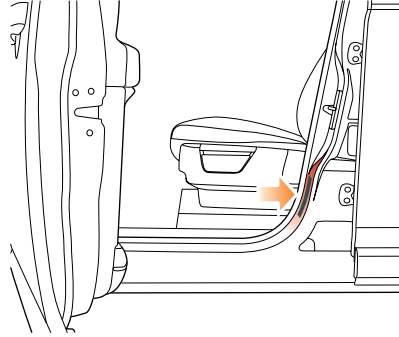

The correct tire pressures are shown on a label attached to the pillar behind the driver's door.

TIRE PRESSURE REMINDER

For your convenience, record the tire pressures specific to your vehicle.

Front



Rear

