

FCC Part 15.247 Certification
Test Report

FCC ID: R7PEC2R1S4

FCC Rule Part: 15.247

ACS Report Number: 06-0387-15C

Manufacturer: Cellnet
Model: Elster A3 Utilinet Endpoint

Manual



UtiliNet® Endpoint User Guide

Version: 1.1**Revision History**

Rev #	Date	Author	Pages	Description
1.0	1/16/2005	H. Glass R. Ridenour		Initial Document Creation
1.1	11/1/2006	M. Ruff		Update Module List/Tech Specs
1.2	1/5/2007	M. Ruff	13	Add antenna config details

Proprietary Rights Notice

This manual is an unpublished work and contains the trade secrets and confidential information of Cellnet, which are not to be divulged to third parties and may not be reproduced or transmitted in whole or part, in any form or by any means, electronic or mechanical for any purpose, without the express written permission of Cellnet. All rights to designs or inventions disclosed herein, including the right to manufacture, are reserved to Cellnet.

The information contained in this document is subject to change without notice. Cellnet reserves the right to change the product specifications at any time without incurring any obligations.

Trademarks Used in This Manual

Internet Explorer® is a trademark of Microsoft Corporation.

UtiliNet® is a trademark of Cellnet Innovations, Inc.

Cellnet® is a registered trademark of Cellnet Innovations, Inc.

Revision History	2
FCC/IC User Information	6
Chapter 1 Introduction	7
System Overview	7
UtiliNet Basics	7
Network of Intelligent Radios	8
Mesh Architecture	8
Radios With Programmable Intelligence	9
Packets Hop From Radio To Radio	9
Polling and Report By Exception	9
About This Manual	9
Icons	9
Contacting Technical Support	10
Chapter 2 UtiliNet Endpoint Under-Glass Radio	10
System Overview	10
UtiliNet Module Overview	11
Technical Features of the UtiliNet Endpoint Under-Glass Radio	11
Residential Meter Modules	11
Chapter 3 UtiliNet Endpoint Configuration	13
Connecting to a radio	13
Adding new Radios to RadioShop	14
Communicating with integrated meter modules	15
Setting the Latitude and Longitude	15
Updating the Network ID (CRC Adder)	16
Chapter 3 Network Engineering	17
Network Design Plan	17
OSI Layers	17
Traditional Radio Comparisons	18
Line-Of-Sight	18
Network Design for 900 MHz Systems	18
Calculating Latitude/Longitude Coordinates	19
Global Positioning System (GPS)	19
United States Geological Survey Maps - USGS Maps	20
MapInfo	20
RF Considerations and System Design	21
Radio Link Budget	21
Transmitter	21

Transmit Antenna.....	21
Ground Plane Effects	21
Transmitter Transmission Line Loss	22
Total Path Loss	22
Free Space Path Loss	22
Additional Path Loss Attenuation.....	22
Receiver Antenna.....	23
Receiver Transmission Line Loss.....	23
Receiver	23
Noise Floor Factor	23
Multipath Fade Factor.....	23
Margin of Safety	24
Summary	24
Keeping a Check on Interference.....	25
In-Band Interference	26
Out-of-Band Interference.....	26
Cellular Base Station Interference	26
Paging System Interference	26
Performing RF Field Studies	26
Design Considerations	27
Glossary	28

FCC/IC User Information

FCC Class B

This device complies with Part 15 of the FCC rules. Operation is subject to the following two conditions:

- (1) This device may not cause harmful interference, and
- (2) This device must accept any interference received, including interference that may cause undesired operation.

This equipment has been tested and found to comply with the limits for a Class B digital device, pursuant to Part 15 of the FCC Rules. These limits are designed to provide reasonable protection against harmful interference in a residential installation. This equipment generates, uses, and can radiate radio frequency energy and, if not installed and used in accordance with the Instructions, may cause harmful interference to radio communications. However, there is no guarantee that interference will not occur in a particular installation. If this equipment does cause harmful interference to radio or television reception, which can be determined by turning the equipment off and on, the user is encouraged to try to correct the interference by one or more of the following measures:

- Reorient or relocate the receiving antenna.
- Increase the separation between the equipment and receiver.
- Consult Cellnet or an experienced radio technician for help.



Changes or modifications to this device not expressly approved by Cellnet Technology, Inc. could void the user's authority to operate the equipment.

RF Exposure

In accordance with FCC requirements of human exposure to radio frequency fields, the radiating element shall be installed such that a minimum separation distance of 20 centimeters will be maintained.

Industry Canada

This Class B digital apparatus complies with Canadian ICES-003. Cet appareil numérique de la classe B est conforme à la norme NMB-003 du Canada.

This Class B digital apparatus meets all requirements of the Canadian Interference Causing Equipment Regulations. Operation is subject to the following two conditions:

- (1) this device may not cause harmful interference, and
- (2) this device must accept any interference received, including interference that may cause undesired operation.

Cet appareillage numérique de la classe B répond à toutes les exigences de l'interférence canadienne causant des règlements d'équipement. L'opération est sujette aux deux conditions suivantes: (1) ce dispositif peut ne pas causer l'interférence nocive, et (2) ce dispositif doit accepter n'importe quelle interférence reçue, y compris l'interférence qui peut causer l'opération peu désirée.

Chapter 1 Introduction

This manual provides technical information for the line of radios used in the UtiliNet® Wireless System. Included are photos, specifications, diagrams, and accessories for each radio type as well as detailed information on applications using the radios and other related information.

System Overview

UtiliNet is a comprehensive wireless data communications solution that utilizes spread-spectrum radios in the 902-928 MHz area of the radio spectrum to provide reliable network answers for remote telemetry or distributed control applications. UtiliNet radios combine three important technologies: a mesh architecture for peer-to-peer communications and true networking functionality, asynchronous spread spectrum frequency hopping for maximum use of bandwidth, and packet switching for guaranteed message transfer and automatic store-and-forward routing.

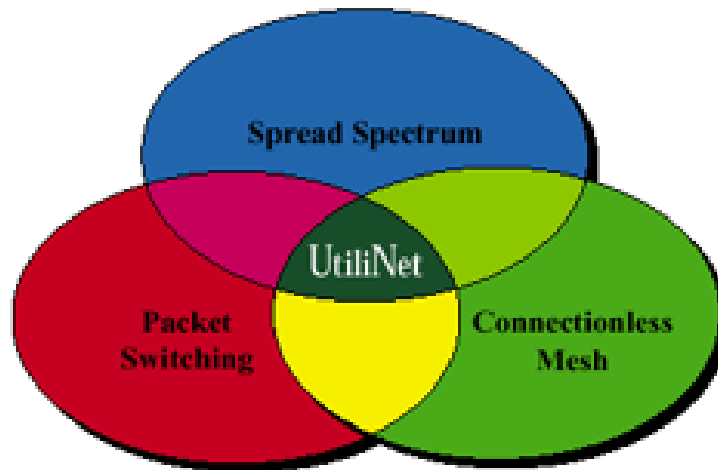

Figure 1.1 UtiliNet Technologies

These three technologies work together to ensure that UtiliNet networks are fast (up to 19200 bps), operate transparently, and are reliable in the delivery of all data messages. These are the key advantages of UtiliNet.

UtiliNet Basics

UtiliNet is a wireless data communications network based on spread-spectrum radio technologies.

Network of Intelligent Radios

UtiliNet radios form the foundation of a UtiliNet network and serve multiple functions.

- Each radio can communicate to end devices for some data collection or control function.
This may involve transparent applications where data is merely passed through UtiliNet radios, or it may involve programs running in radios and/or other gateway devices to perform custom applications, higher network efficiency or enhanced functionality.
- Each radio interacts with its UtiliNet radio RF neighbors to form a wide area network (WAN) into which it may initiate a packet, automatically route a packet between other radios, or accept a packet as the final destination.
- Each radio automatically integrates itself into an RF wide area network and routes packets.

Upon power up or reboot, and at intervals while powered on, a radio automatically scans the frequency band searching for other UtiliNet radios in its vicinity to learn about its RF neighbors. As the radios learn about one another, they pass their geographic address coordinates for routing and to keep communication statistics for choosing the best data transmission paths. This allows the radios to automatically route packets and dynamically build routing tables to choose the best paths if RF conditions change. Once configured by the user, radios automatically acquire radios and route packets.

- Each radio can execute one or more programs written in the Device Control Word (DCW) language.

These programs can send, receive, and process packets to and from other radios. They also are able to send, receive, and process data to and from end devices connected to the radio. Examples of DCW applications include: radio configuration, radio queries, data collection, communication to end devices, protocol translation and peer-to-peer control.

Several types of UtiliNet radios are available:

- The UtiliNet Endpoint under-glass radio used for under glass meter integration and other devices
- The Integrated WanGate Radio (IWR) and WanGate radio are used with RS-232 end devices and as additional repeaters if necessary (the IWR is designed for installation inside another enclosure and the WanGate is designed for independent outdoor installations).
- The MicroRTU WanGate radio allows an integrator to install an appropriate RTU into the specialized MicroRTU WanGate enclosure to create a combined RTU and radio communication package.

Mesh Architecture

Much like a giant net over a service area—UtiliNet radios work together to create a mesh. At each point where one thread of the net crosses over another, a node is created in the wider area network.



A node could be represented by one radio attached to end-devices.

Because each radio can forward messages to and respond to every other radio in the network, each radio is an equal participant in the network. The result is increased communication reliability because there is no single point of failure. While a radio is interacting with an end-device, it can be simultaneously acting as part of the mesh network. The concept of creating a mesh is central to what makes UtiliNet a truly robust data communication solution.

Radios With Programmable Intelligence

Each radio is similar to a programmable logic controller (PLC). The radio acts much like a small computer, carrying out any number of computing and command functions. The intelligence in each radio enables it to perform many functions not normally associated with radios such as making intelligent routing decisions, transporting industry protocols, and recognizing operating conditions and responding with pre-programmed logic.

Packets Hop From Radio To Radio

When an end device generates a message that needs to traverse the network, the end-device radio packets the data, places the data into an envelope—addressed to the destination radio—and enters it into the network. The data packet traverses the network by hopping from radio to radio in the direction of the destination radio. The number of hops between origin and destination radio(s) is automatically minimized to increase transmission speed. The route chosen for traversing the network is dynamic and employs automatic re-routing in the event a particular data path is not clear.

Polling and Report By Exception

Traditional point-to-multipoint systems are prone to network latency as only one radio can communicate with the master at a time. A mesh network eliminates this problem as data is evenly spread across the entire mesh (i.e., a multipoint-to-multipoint network). Further, most traditional network topologies poll, gathering data sequentially. UtiliNet radios can be programmed to respond under predetermined parameters or on an unsolicited, report-by-exception basis—which is both faster and more efficient.

About This Manual

This technical reference guide explains UtiliNet in great detail from application design through implementation and operation to after-sales services and support. Also included are a glossary of important terms and papers on extended UtiliNet topics.

Chapter	Title	Description
1	Introduction	Provides introductory information about the Utilinet network and this manual.
2	UtiliNet Endpoint Under-Glass Radio	Describes the details of the UtiliNet endpoint module
3	UtiliNet Endpoint Configuration	Provides information for radio configuration, radio installation, network routing, mobile radio configuration.
4	Network Engineering	Contains information on network design, latitude/longitude calculations, system design, and field studies.
	Glossary	Provides a list of terms and definitions commonly used in UtiliNet radio applications.

Icons

Throughout the document, various icons are used to draw your attention to important information. Below are examples:



The warning icon identifies information that is critical to maintaining the integrity of the software or data.



The caution icon identifies important information.



The note icon identifies information that clarifies a point within the text.

Contacting Technical Support

Within the United States, Cellnet technical support is available Monday through Friday, 8:00 A.M. to 5:00 P.M. Eastern Standard Time by email at techsupport@cellnet.com. Please be prepared to give the following information:

- Exactly what problem you encountered.
- A description of what happened and what you were doing when the problem occurred.
- A description of how you tried to solve the problem.

Chapter 2 UtiliNet Endpoint Under-Glass Radio

The UtiliNet Endpoint Under-Glass Radio is Cellnet's latest embedded communication module product targeting advanced RF communications for residential metering needs. The UtiliNet Endpoint is designed to be integrated under the glass of an existing meter enclosure. It provides the following benefits:

- Low operational cost AMR solution
- Supports small to large deployments
- Eliminates recurring data collection fees

System Overview

The UtiliNet Endpoint system looks as follows:

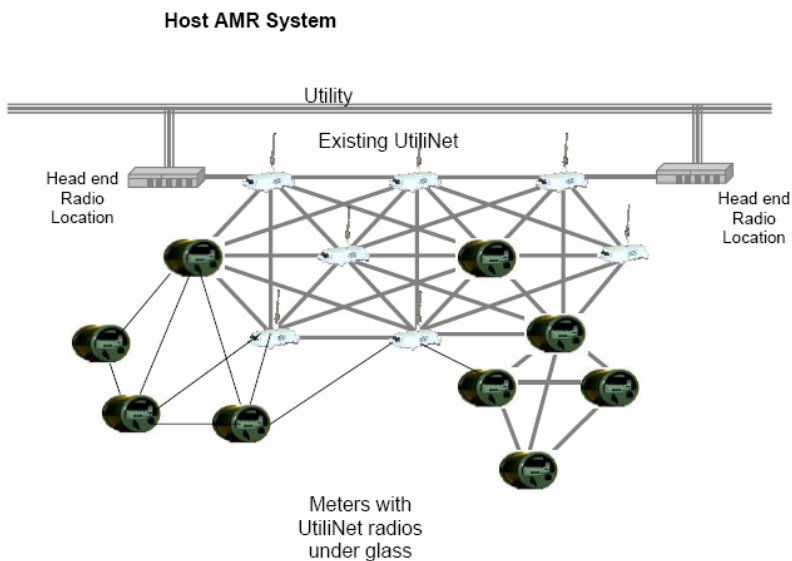

Data acquisition can be provided by a hosted service for small to large meter deployments or an own and operate solution. The UtiliNet network provides secure, packet based data transfer. UtiliNet Endpoint module supports the following system services:

- Uses Device Control Word (DCW) programming language
- Spread Spectrum Frequency Hopping Technology
- Utilizes an Unlicensed 902-928 MHz Frequency Band
- Devices act as end devices and repeaters
- Utilizes packet switching data transmission
- Increase coverage by adding more radios to the Mesh Network

UtiliNet Module Overview

The UtiliNet Endpoints are designed to for integration in both residential and commercial electric meters. The following list includes all UtiliNet modules, and the associated host electric meter:

UtiliNet Module	PCBA#	Meter Model	Meter Type
L&G Focus-2 Utilinet Endpoint	25-1053	Focus	Residential
GE I-210 Utilinet Endpoint	25-1055	GE I-210	Residential
GE kV2c Utilinet Endpoint	25-1054	GE KV2c	Commercial
Elster A3 Utilinet Endpoint	25-1014	Elster A3	Commercial

Technical Features of the UtiliNet Endpoint Under-Glass Radio

Endpoint Meter Modules

General	Specification
Number of Channels	258
Channel Spacing	100 KHz
Modulation Type	Direct 2-FSK
Baud Rate	9600
FCC Operation	Part 15.247 Spread Spectrum
Spreading Technique	Frequency Hopping
Hopping Technique	Pseudo Random Asynchronous
Hopping Patterns	65,536 (Unique per network)
Network Address	Latitude / Longitude Coordinates
Turn-Around Time	100[uS] max

Receiver	Frequency [MHz]	Condition	Specification
Type			Monolithic, Low IF, Quadrature digitized
Receiver Sensitivity - Residential	902.1~927.9	BER 5E-5	-104 dBm typ/-102 dBm min
Receiver Sensitivity - Commercial	902.1~927.9	BER 5E-5	-108 dBm typ/-105 dBm min
Adjacent Channel Rejection			> 50 dB
Worst case Image Rejection			> 35 dB

Transmitter	Frequency [MHz]	Condition	Specification
RF Output - Residential Minimum Typical	902.1~927.9	Referenced to Antenna connector, CW	+14.0 dBm +16.0 dBm
RF Output - Commercial Minimum Typical	902.1~927.9	Referenced to Antenna connector, CW	+18.0 dBm +20.0 dBm
Frequency Range	f0		902.1~927.9 MHz
Out-of-band Radiated Spurious	10~10000 2*f0 3*f0~10*f0	1KHz RBW, TX on, CW, +20 dBm	-20 dBc -45 dBc -70 dBc
Deviation			+/-5.0 KHz
Modulation Bandwidth			25 KHz
Frequency Stability		-40C ~ +85C	f0 +/- 2.5ppm

Processing	Specification
CPU	Renesas M16C/62
Clock Speed	14.7456[MHz]
Memory SRAM Flash (Code + Data)	31[KBytes] internal 384[KBytes] internal
Programming Language	Device Control Word (DCW)

Environmental	Specification
Operating Temperature	-40 to +85C
Storage Temperature	-40 to +85C
Humidity	ANSI 12.1 ~ 5.4.3.18

Endpoint Antenna Configurations

L&G Focus-2 Utilinet Endpoint Antenna:

This device has been designed with an integrated loop antenna, located on the PCB surface layer on the reverse (non-component) side of the assembly. This antenna has a typical gain of 3 dB.

GE I-210 Utilinet Endpoint Antenna:

This device has been designed with an integrated loop antenna, located on the PCB surface layer on the reverse (non-component) side of the assembly. This antenna has a typical gain of 3 dB.

GE kV2c Utilinet Endpoint Antenna:

This device has been designed to operate with the antenna listed below, and having a maximum gain of 1 dB. Antennas not included in this list or having a gain greater than 1 dB are strictly prohibited for use with this device. The required antenna impedance is 50 ohms.

GE kV2c Antenna – Flex Dipole, Cellnet p/n: 19-0077 or 19-1173

To reduce potential radio interference to other users, the antenna type and its gain should be so chosen that the equivalent isotropically radiated power (EIRP) is not more than that required for successful communication.

Elster A3 Utilinet Endpoint Antenna:

This device has been designed to operate with the antenna listed below, and having a maximum gain of 3 dB. Antennas not included in this list or having a gain greater than 3 dB are strictly prohibited for use with this device. The required antenna impedance is 50 ohms.

Elster A3 Antenna – Loaded Monopole, Elster p/n: 1B12150H01

To reduce potential radio interference to other users, the antenna type and its gain should be so chosen that the equivalent isotropically radiated power (EIRP) is not more than that required for successful communication.

Chapter 3 UtiliNet Endpoint Configuration

A local UtiliNet radio is required to communicate with the integrated UtiliNet radio modules inside your meters. This radio may be a standard UtiliNet Series 3000 IWR radio as seen below.



Connecting to a radio

Open RadioShop on your computer.

Connect your local radio's Lan Packet Protocol serial port to your computer's serial port. Select Communications>>Connect from the RadioShop main menu making sure you select the right Com port and a Baud rate. The default baud rate for UtiliNet radios is 9600 bps. When you are connected to the local radio, a Radio Configuration Report will be executed automatically and displayed.

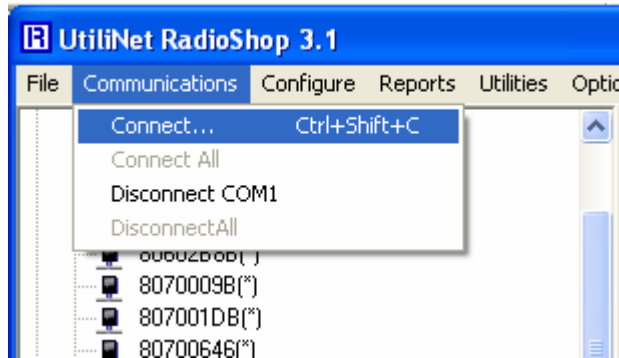

UtiliNet radios, including integrated meter modules, ship with a default network configuration that must be updated to reflect your company's unique network ID.

In order to communicate with a UtiliNet meter endpoint over-the-air, the locally connected radio must be a member of the same network as the integrated meter radio module.

Adding new Radios to RadioShop

You will now need to add the meter radios to the RadioShop database. This is done by invoking the automatic discovery feature from the RadioShop main menu. Make sure your local radio is highlighted in the network view and select Utilities>>Radio>>Discover Neighbors from the RadioShop main menu. This will automatically populate RadioShop's database with all required information about the integrated meter module in order to establish over-the-air communication. All visible UtiliNet radio modules will be automatically added to the network view in RadioShop.

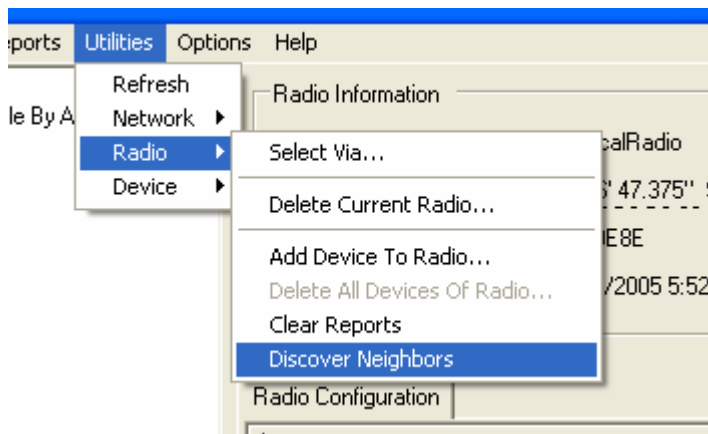

Communicating with integrated meter modules

In order to address a remote endpoint that has not been configured with a Latitude/Longitude you must select the endpoint “via” your local radio. This tells the network what path to take to reach the endpoint, which does not yet have a valid Latitude/Longitude. To select your endpoint “via” your local radio, right click on the endpoint and select “Select Via...” from the context menu.

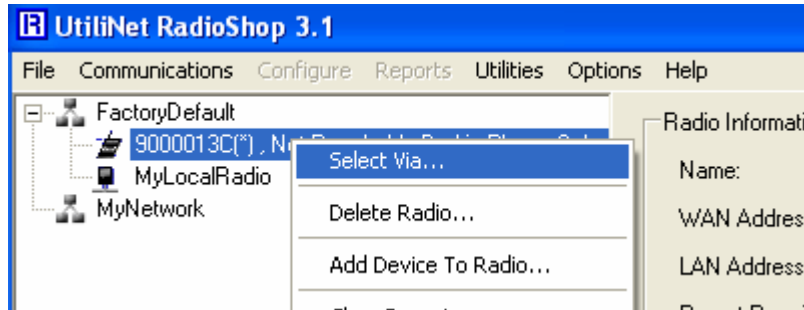

Once selected via, the text displayed in the network view should indicate that the remote endpoint is selected via your local radio.

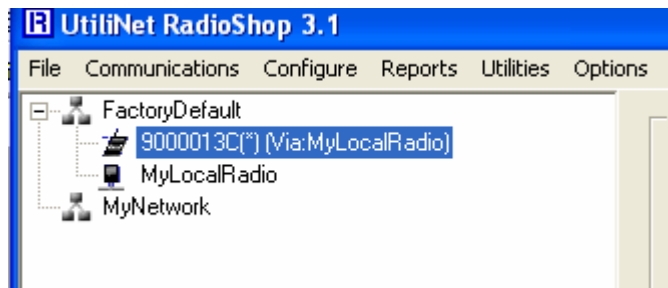

Setting the Latitude and Longitude

In order to give your device a fixed Latitude and Longitude you must first specify the meter module as a “non-mobile” device. Do this by selecting Configure>>Send DCW from the main menu and selecting the UMOBILE.HEX DCW. Once sent confirmation should be displayed on a “DCW Response” tab as shown below.

DCW Response		
Time Received	Response As Text	Response
12/14/2005 5:48:49 PM	SET AS NON-MOBILE ROUTER-REBOOT TO TAKE E...	53,45,54,

Next you will have to set up a Latitude and Longitude or “WAN Address” for your integrated meter module. This is the GPS coordinates of the radio. To set the WAN address, go to Configure>>Wan Address. Specify the new Latitude/Longitude of your integrated meter module and click OK. A message should appear indicating that the remote radio was successfully programmed. The color feature may be used if you are planning on installing more than one meter in the same geographic location.

Updating the Network ID (CRC Adder)

In order to configure your integrated meter module with your company's unique network ID or CRC Adder you must first add a network to RadioShop with your company's network ID. Select Utilities>>Network>>Add Network from the RadioShop main menu to access the "Add Network" screen. Name the network and specify the network ID (CRC Adder) to your company's assigned value. You may accept the default parameters for the protocol settings or change these to match your networks protocol settings if known.

Now you will be able to configure the radio to be a member of your new network. Select Configure>>Radio from the RadioShop main menu. Select the default radio configuration file and

the new network you would like the radio to be a member of and click OK. The radio will be automatically moved to the destination network and updated with the destination network's network ID.

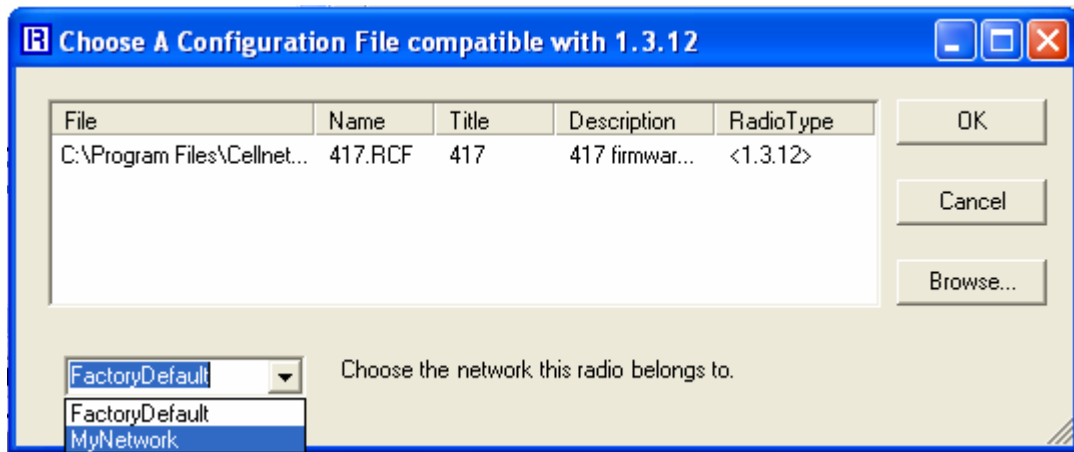

Note UtiliNet radios may only communicate on one network at a time. You will not be able to communicate to the integrated meter radio over-the-air until you move your locally connected radio to the same network.

For more information on UtiliNet module configuration, transparent port configuration, and routing configuration see the UtiliNet Technical Reference Guide.

Chapter 3 Network Engineering

This chapter discusses the network design plan, calculation of latitude/longitude, RF considerations, field studies and use of directional or gain antennas.

Network Design Plan

A UtiliNet network consists of two or more UtiliNet packet radios that communicate data to and from points in the network. When designing a UtiliNet network, it is important to remember that UtiliNet combines three different technologies: a connectionless (store and forward) mesh architecture, packet switched data transfer, and spread spectrum radio techniques. Since this combination of technologies affects the design layout and plays a part in the overall optimization of the network, each one is discussed in this chapter.

OSI Layers

For those familiar with the Open Systems Interconnection (OSI) model, the above technologies, or OSI layers, also address why a UtiliNet network communicates like a computer network. In fact, it is often said that UtiliNet radios are computers that use radio waves to communicate with each other, or that end devices do not talk through UtiliNet radios but to them. From a certain point of view, this is true. UtiliNet radios are computers first and spread spectrum radios second. Truly optimizing the benefits of a UtiliNet network requires understanding the interaction and purpose of the physical, data-link, network, transport, and session layers of the OSI model.

Traditional Radio Comparisons

Much of the work involved in the layout of a traditional voice or analog radio network deals with its variability and uncertainties. Its design can be quite complex. This is simply the nature of analog technology.

Digital radio, however, is different. System designers with a background in analog radio may find installing a UtiliNet system to be somewhat simplistic. Network users, when field testing to determine how far radios can communicate, describe it as either it does or it does not work. This is the nature of digital radio.

Network designers and users benefit from a UtiliNet radio's intelligence in many seen and unseen ways. The benefits of microprocessor-controlled communication algorithms are reduced installation time, reduced cost, and reliability uncertainties. Because UtiliNet radios dynamically adapt to changing conditions, designers can be confident that what will work today will work in the future.

UtiliNet also assures you that if the radios can communicate, then the data is correct. That is because, unlike traditional pass-through radios that include no provisions for interference protection at the data level, UtiliNet guarantees it through the benefits of packet switching.

Line-Of-Sight

Like traditional radios, UtiliNet radios operate in the 900 MHz range of the radio frequency spectrum and, therefore, fall into a class of communications equipment referred to as line-of-sight. As a general rule of thumb, line-of-sight communications equipment requires a clear, unobstructed view from the source radio to the destination radio in order for communications between the two to occur.

Network Design for 900 MHz Systems

Network design for 900 MHz system typically falls into two categories:

- The first category includes licensed channels that are generally trunking or MAS data systems. This category, in most cases, requires that all remote fixed points and/or mobile points have line-of-sight paths to a single repeater site typically located at the highest point in the geographic area of coverage.
- The second category includes spread spectrum systems into which UtiliNet falls. However, unlike other spread spectrum radios, UtiliNet radios utilize an OSI network layer. Each radio has store and forward features that allow intermediate nodes or routers to route data packets in cases where line-of-sight between the source and destination is not possible. A patented geographic addressing scheme is the method used to route the data through the network nodes.

In any case, the design of a 900 MHz communications network becomes a matter of providing line-of-sight paths between radios.

In most systems, the end points of the network are typically well defined and established. The data delivery points (master sites) as well as the data gathering points (remote sites) are known. In order to design a UtiliNet network that allows communications between the delivery points and the gathering points, a design plan similar to the following should be used:

1. Using a GPS receiver or geological maps, record the latitude and longitude of each data delivery/gathering point in the network.
2. Determine an approximate available antenna height for each site. This only needs to be an approximation. In some cases, the site may have height limitations due to clearance problems or

- aesthetics. In the 900 MHz frequency band, antenna height provides the largest gain in terms of RF distance. In general, the higher that antennas may be mounted the better.
3. Use topographical maps or computer prediction programs to plot paths between known nodes to get an indication of the ability of radios to communicate with one another over the average terrain in the area. This procedure provides an approximation for required antenna height in order to clear obstructions that may exist in the paths.
 4. If path profiles are generated that indicate that certain sites DO NOT have line-of-sight paths to any other site, use general area maps to identify where repeater or additional router locations might be needed to insure line-of-sight paths from every radio to at least one other radio.
 5. Field Survey - Regardless of the quality of maps or computer databases, predictions are still just predictions. The only way to insure RF connectivity, regardless of the product or the frequency, is to test the path.

Calculating Latitude/Longitude Coordinates

Each radio in the UtiliNet network is programmed with a unique latitudinal and longitudinal (lat/long) coordinate. These lat/long coordinates are used by the network to make logical routing decisions (see "Network Routing" on page 9-2 for more information). Because the network uses the lat/long information in a logical way, it is not necessarily important that the lat/long coordinates be physically accurate. What is important, is that the lat/long coordinates of each radio be relatively correct to one another.

In other words, if each radio in a particular network was programmed with the same distance offset from the actual physical location, network routing would not be adversely affected. However, if only a few of the radios were programmed with the offset, routing could potentially suffer due to logical routing that does not reflect the physical topology of the network. Therefore, it is not necessary for radios to have exact coordinates. What is important, however, is that the method used to derive the lat/long coordinates be capable of providing repeatable coordinate information which is physically relative and consistent system wide.

Below are the most common, commercially available, methods of deriving latitude longitude information. A brief analysis has been provided to compare and contrast the benefits of each.

- Global Positioning Systems
- United States Geological Survey Maps
- MapInfo®

Global Positioning System (GPS)

GPS devices receive global positioning information from government owned and operated satellites. Many manufacturers have developed consumer grade GPS devices for the commercial market. In most commercial applications, the GPS is used to approximate a location while in motion (such as boating, hiking, or skiing). These devices are readily available to the consumers for a price of about \$500.00 or less.



As a note, the signal from the government satellites has intentionally been degraded for security purposes. Commercial grade GPS specifications are typically +/- 300 meters. Only industrial grade GPS equipment, with a land based reference, will provide the type of accuracy used in military applications.

When considering the use of a GPS for constructing and maintaining a UtiliNet network, here are some issues to evaluate:

Repeatability of the GPS information has proven to be less than ideal. Readings taken from the same physical location at different times of the day tend to vary significantly (often more than the specified +/- 300 meters). As mentioned earlier, it is most important that the radios' lat/long coordinates be RELATIVELY correct to one another. Using a GPS may compromise the repeatability of relatively correct readings. The user may want to occasionally verify the GPS.

- When using a GPS it is necessary to physically visit each site in order to derive the lat/long coordinates. It may be desirable to pre-program the radios before they are taken to the site to be installed. This would require two trips to the site.
- Logistically speaking, only those with the GPS have the ability to derive lat/long coordinates. Efficient network deployment and maintenance could be compromised or limited by the availability of the GPS.

United States Geological Survey Maps - USGS Maps

USGS maps are readily available from local maps stores, through mail order, and from USGS directly. Each map section has lat/long coordinates printed along the borders of the map. When considering the use of a USGS map for constructing and maintaining a UtiliNet network, here are some issues to evaluate:

- Because all USGS maps have a central reference, all derived lat/long coordinates will always be relatively correct to one another. As mentioned earlier, this is important when considering UtiliNet's logical routing algorithms.
- In addition to the geographical information, USGS maps provide topological information that is helpful when planning and maintaining a UtiliNet network. If the network is installed in an area with high ridges and low valleys, USGS maps can be used to determine potential trouble areas as well as ideal repeater sites.
- Maps also provide an excellent graphical representation of the network. If a radio is programmed with the incorrect lat/long it can easily be identified in a graphical way.

For mail order USGS maps contact:

Map Link, Inc.

30 S. La Patera Lane, Unit #5

Santa Barbara, California 93117

Phone: (805) 692-6777

Toll-free phone: (800) 962-1394

Fax: (805) 692-6787

Toll-free fax: (800) 627-7768

U.S.G.S. Topo Dept. Fax: 1(800) 627-1839

Web: <http://www.maplink.com>

E-Mail: custserv@maplink.com

MapInfo

MapInfo® is a desktop software application that allows the user to graphically view city, county and state maps on a computer screen. Latitude and longitude coordinates can be derived by simply positioning a mouse cursor over the intended installation location. The approximate cost for the MapInfo application and associated map data is \$2000. When considering the use of a MapInfo for constructing and maintaining a UtiliNet network, here are some issues to evaluate:

- MapInfo has software hooks which allow it to connect to a database server. System integrators can use this feature to store specific installation information about many different networks. In addition to the lat/long information, the user can store other information such as a description of the site, the installation date, or the type of installation.
- MapInfo software can run on a laptop computer for field applications. When installing a UtiliNet radio, it may be easier, depending on the deployment technique, for field personnel to program radios while on site. With MapInfo, users can derive actual lat/long coordinates and program the radio while in the field.

Although the map data is usually provided from MapInfo on a CD ROM, it can be transferred to a hard disk.

- Additional computer hardware will be required to run the MapInfo application.

For additional information, contact MapInfo

MapInfo Corporation

One Global View

Troy, New York 12180

Tel: 518.285.6000 or 800.FASTMAP

Fax: 518.285.6070

Web: <http://www.mapinfo.com>

Email: webmaster@mapinfo.com

RF Considerations and System Design

Many books have been written on the subject of RF Considerations and System Design, but this section covers the important fundamentals.

Radio Link Budget

Link Budget is a term used to describe a radio link from transmitter to receiver, and all of the factors in between. Link budget analysis uses a simple method of allocating appropriate factors to each portion of the link and then algebraically adding these factors. Then, the proposed link can be evaluated by how many dB's are left over. To analyze link budget, you must look at each component of the communication system. Examine a sample radio link budget. Table 8.3 on page 8-9 summarizes the results.

Transmitter

For the UtiliNet product line, transmit power is +20 dBm nominally (100mW). The production minimum is +18 dBm. It is not unusual for a radio to measure +21 to +23 dBm.

Transmit Antenna

Frequently, antenna manufacturers will *not* advertise the unit of measure associated with antenna gain of their products. The commonly accepted unit of measure for antenna gain in the land-mobile industry is dBd, which refers to dB of gain relative to a dipole. If there is a doubt, this should be confirmed with the manufacturer. For our analysis, we need the dBi unit of measure, so a conversion factor is needed. The conversion factor is +2.15 dB, rounded to 2 dB for this example.

Example:

A "3 dB omni-directional" type antenna is used. The antenna gain may be stated as 5 dBi. The "3 dB omni-directional" antenna here refers to a very common, low cost antenna design consisting of a 1/4 wave element, a phasing coil, and a 5/8 wave element, over a large ground plane. Such antennas perform well, and are readily available from a variety of sources. It is a standard antenna for many applications, including land mobile radios and microcellular base radios. Refer to "*Use of Directional or Gain Antennas*" on page 8-14 for pertinent FCC restrictions.

Ground Plane Effects

In the example above, ground plane refers to the flat, horizontal, metal chassis or enclosure to which the antenna is secured. The ground plane works in conjunction with the antenna's vertical element(s) to form a complete antenna. Some types of antennas need a large ground plane to function properly, and some need no ground plane.

When a ground plane is required, but is not large enough, effective gain reduction results. If applicable, a reduction of 1 to 2 dB on antenna gain would be in order for ground planes smaller than about 6 to 8 inches along the narrowest axis.

Transmitter Transmission Line Loss

This is the equivalent cable loss of any transmission line that might be used to mount an antenna remotely from the radio assembly. Many times the purpose for remote mounting the antenna is to get it up higher and more in the clear. This functions to reduce the Path Loss Adder term by more than the amount of this transmission line loss term, hence a net gain is realized. The maximum tolerable cable loss is a subjective call. It is recommended that the cable type and length be selected such that this loss term does not exceed 3 dB. A cable loss of 1.5 dB would be a reasonable goal. For this example, assume a good quality cable is used, and the loss at 915 MHz is 1.5 dB.

Total Path Loss

The total path loss is highly variable and can be estimated by:

- Field propagation measurements—This can provide the most valuable data, but these results can still vary from one time to another time.
- CAD tools based on various models—Some models tend to overestimate path loss; some models tend to underestimate path loss.



If a high gain or directional type antenna were used, a ground plane would probably not be required because these types of antennas are usually designed to be ground plane independent.

As a basis, first calculate free-space path attenuation. Then add a correction factor of 0 to 45 dB (or more for very extreme conditions), depending on variables such as antenna height, terrain, foliage, or obstacles.

Free Space Path Loss

Free space assumes no obstacles blocking the path, no obstructions or significant field perturbations of any kind present. This is the best you can hope for, but is seldom achieved unless the path is perfectly line-of-sight. This is a useful starting point, however, for estimating path loss since it is the best achievable. Free space attenuation at 915 MHz, for isotropic antennas at each end, is 96 dB at one mile and increases 6 dB when distance doubles. Sometimes free space path loss is calculated differently, using dipole antennas instead of isotropic antennas. Such is not the case here, but if it were, the 2 dB factors for dBd to dBi antenna gain conversions would not be included.

Additional Path Loss Attenuation

For non-line-of-sight paths, an additional factor must be included that corrects for variables such as terrain, obstacles (including buildings), foliage, people, or antenna height. This is a factor to take into account for the installation and the path, as it is today. This factor can be derived from the works of many individuals who have studied radio propagation and derived mathematical models: Okumura/Hata, Longley/Rice, Lee, and others. There are various CAD tools available that are based on these measurements or algorithms. Note that some of these CAD tools will only return the total path loss factor. Other CAD tools perform the entire link budget analysis. For our discussion, let's continue to consider the RF path as a sum of the freespace path loss term and an additional path loss term. Height of both antennas, the type of environment

along the path, distance, and other parameters can determine this factor. Typically, this factor ranges from 5 to 40 dB.

This factor, plus the free space path loss, gives total median path loss.

Example: Assume a path that is 5 miles long. One antenna is on a hill or water tank 300 ft. higher than the surrounding area. The other antenna is on a 30 ft. support structure, for example on the rooftop of a 1 story building. Except for the

Table 3.1 Free-Space Path Loss

Distance, Miles	Free-Space, Isotropic Path Loss, dB
0.5	90
1	96
2	102
4	108
8	114
16	120
32	126
64	132

hill or water tank, the terrain is considered relatively flat. The path loss adder term is -10 dB at 915 MHz, according to the Okumura/Hata propagation prediction method using the suburban area model.

Receiver Antenna

The previously mentioned antenna considerations also apply here, including possible ground plane effects. For this example, this is (again) a “3 dB omni-directional.”

Receiver Transmission Line Loss

The principles and goals here are the same as those for the Transmitter Transmission Line Loss term.

Receiver

Receive sensitivity for the UtiliNet product line is typically -107 to -112 dBm. Automated production tests are performed on all deliverable radios at various frequencies, and with signal levels down to -104 dBm. For this example, assume the receiver sensitivity is -107 dBm. This is a safe, conservative estimate for current production radio sensitivity.

Noise Floor Factor

One of the factors that make the 800 to 900 MHz frequency band so attractive is the relatively low equivalent noise temperature of man-made noise. For a noisy business environment, this has been estimated to be 87 K at 915 MHz. Relative to an ambient antenna noise temperature of 298K, this translates to a noise floor increase of 1.2 dB. Thus, we will allocate 1 dB (rounded to the nearest dB) of the link budget to overcoming man-made noise.

Multipath Fade Factor

For most receive signal measurements, slight changes of antenna location (on the order of 1 wavelength), or measurements at different times, will show a short-term variance of received signal level. This is generally due to multipath. An allowance of approximately 8 dB should be made on most radio links at 915 MHz. This is because the difference between a median received signal level and a multipath null does not exceed 8 dB for about 80% of the measurements you could make. This factor can be reduced by one or more diversity schemes that are available. All Cellnet spread-spectrum radios inherently employ frequency diversity; however, it doesn't hurt to be conservative and still include this factor. Tabulated below are 915 MHz multipath factors for other values of percent coverage. This factor varies slightly (1 to 3 dB) for various types of environments. Values shown are for 915 MHz urban area, small city.

Table 3.2 Multipath vs. Percent Coverage

Percent Coverage	Multipath Factor, dB	Percent Coverage	Multipath Factor, dB
10	+7	90	-12
30	+4	95	-16
50	0	97	-18
70	-5	99	-23
80	-8	99.9	-33

Margin of Safety

Radio systems are usually not designed to operate precisely at threshold, or even at threshold plus the multipath factor. Usually they are designed with some extra margin. This is called a margin of safety, and is used to account for long-term variance in the received signal level. A value of 0 to 35 dB is suggested—the actual number depends on how conservative you are. You will use 5 dB for this example. If the actual path could be held constant at the receiver threshold, and never varied, you would see data success rates of at least 90%. This is because at receiver threshold, the receiver provides no more than 10% packet error rate. Since the data link layer of the radio software only passes good packets and blocks bad packets, the data success rate would be 100% minus 10%, or 90%. In practice, however, received signal levels vary substantially. Rx signal levels cannot be precisely predicted. In fact, Rx signal levels vary due to such factors as vehicular air traffic, precipitation and air temp changes, wind movement of trees and antennas, tree growth, city growth, and population expansion. Systems are usually designed with an additional margin of safety to overcome these and other variances for the next several years of operation.

Summary

For this example, the link budget is calculated as shown. Note that losses and margin of safety are shown as negative numbers, since they subtract from link budget.

Table 3.3 Example Link Budget Calculation

Item	Description	Value	Unit
Transmitter	Power level	+20	dBm
Transmit antenna	3 dBd, plus 2 dB conversion factor	+5	dBi
Transmitter transmission line loss	Coax loss from radio to antenna, if any	-1.5	dB
Path loss, free space	Ideal conditions, 5 miles distance	-110	dB
Path loss adder	For nominal conditions (not ideal free space)	-10	dB
Receive antenna	3dBd, plus 2 dB conversion factor	+5	dBi
Receiver transmission line loss	Coax loss from radio to antenna, if any	-1.5	dB
Receiver	Nominal sensitivity	-(-107)	dBm
Noise floor factor	Allowance for man-made noise	-1	dB
Multipath	For reliability of 80%	-8	dB
Margin of safety	Allowance for future growth	-5	dB
Link budget:			
= excess (Good, extra dBs)	Algebraic sum of above factors		
=shortage		0	dB

It is apparent that this link of 5 miles distance, under the conditions described, should be very reliable because you were able to include a conservative multipath factor and a margin of safety, and still have the link budget balance. If the end application allows links with less than ideal margin and reliability, much larger distances may be spanned. A large Southern California installation consisting of thousands of UtiliNet Series I radios with 0 dBd antennas was surveyed. The terrain varied from hilly to flat, and the antennas varied from up high to down low. The result was that the distance between radios that were able to communicate was an average of 5.3 miles. The distribution over ± 1 standard deviation was 3 to 11 miles!

The official UtiliNet radio distance record to date (using Series I UtiliNet radios) is between Mt. Vaca (near Sacramento, CA) and Loma Prieta Peak (South of San Jose, CA): a distance of almost 89 miles. Using 3 dB omni-directional antennas, with cavity-type bandpass filters to protect against interference, this line-of-sight link runs with about a 30% data success rate.

Keeping a Check on Interference

Ideally, a radio receiver should be able to process a very weak signal in the simultaneous presence of Megawatt signals within adjacent frequency bands. Such strong adjacent signals would be rejected by the receiver filters. In practice, however, there are practical limitations. The ratio of desired versus undesirable signals is referred to as the Dynamic Range of the receiver. Receiver system design involves the following trade-offs.

- Rx sensitivity versus dynamic range

- Power consumption versus dynamic range
- Size versus dynamic range
- Cost versus dynamic range

Currently, all UtiliNet products have a receive sensitivity of about -107 to -112 dBm, with an allowable single-tone interference level of around -20 dBm before sensitivity reduction takes place. Thus, the dynamic range is about 90 dB. For multi-tone interference, for example several strong paging transmitters in the area, it is recommended that the maximum interference level be limited to -30 dBm. In general, price increases exponentially with dynamic range. For example, specialized direct-sequence spread spectrum transceivers with 130 dB dynamic range have been built, but they sell for \$60,000 each. To make this type of solarpowered radio with battery back-up would probably cost almost as much. The consequences of interference to the radio system will be reduced RF connectivity. This is measurable as reduced tickle success rate and data success rate to another radio. Interference problems can be classified as either in-band or out-of-band. Each is treated differently.

In-Band Interference

This type of interference is from devices within the same frequency range as the desired radio system, and therefore cannot be filtered out. This is encountered if, for example, two or more UtiliNet radios are placed at the same site to increase data handling capacity. Another example would be a UtiliNet radio and another unlicensed Part 15 radio such as a wireless LAN radio at the same site. Usually, this type of interference is corrected by adjusting the antenna configuration of the radios at that site.

Out-of-Band Interference

Out-of-band interference is due to radio systems on other frequencies outside the desired radio system frequency band. These can sometimes be strong enough to cause de-sensitization or generate an excess of significant intermodulation products.

Cellular Base Station Interference

Cellular base stations are usually not a problem unless the radio is within approximately 500 feet line-of-sight to a cellular base station site. If this is a problem, RF filters are available. If you are in doubt, use a spectrum analyzer to check interference levels. A reasonable goal would be to have the highest cellular base station interference signal be no more than -30 dBm. Levels between -20 and -30 dBm will probably be noticeable, but still not a problem. Levels above -20 dBm, especially between 890 to 894 MHz, could cause problems if there is not 10 to 20 dB Safety Factor in the link budget.

Paging System Interference

The Radio Frequency spectrum from approximately 929.5 to 931.5 is used for paging. This application requires transmission of enormous amounts of RF energy to penetrate buildings and houses and still be received by the relatively inefficient antenna of a pager shielded by a person's body. In the frequency domain, this activity takes place just above the highest frequency of UtiliNet operation. With the proliferation of paging systems, these signals are getting more intense and increasing in quantity. Once again, RF filters are available to solve this problem. As with cellular, you can use a spectrum analyzer to check for allowable interference levels. The same limits and goals apply—paging signals should ideally be no more than -30 dBm. Levels between -20 and -30 dBm will probably be noticeable, but not a problem. Levels above -20 dBm could cause problems if there is not a 10 to 20 dB Safety Factor in the link budget.

Performing RF Field Studies

Field surveys are necessary to prove or disprove the path predictions, as well as to provide information as to the potential of interference from other RF transmitters that may also be located at or near any of the

sites. Most UtiliNet surveys are accomplished by temporarily installing a UtiliNet radio at the master site or at a repeater site and testing connectivity from the master or repeater to the remote sites in the predicted coverage area of the master or repeater. One of the advantages to spread spectrum technology is the license-free operation that allows installation anytime and anywhere. A second UtiliNet radio is carried to each remote site in the predicted coverage area and powered to check connectivity. In most cases, the UtiliNet radio's antenna is mounted on a telescoping pole (preferably constructed from nonconductive material) that would place the antenna as near to the final mounting height as possible. Using RadioShop software, data is gathered from the remote radio and the master or repeater radio, assuming the two radios connect. Use the following procedure to collect data that should be recorded for each site:

- 1 Make a rough sketch of the site indicating the antenna location relative to some reference structure.
- 2 Note any additional antennas that may be at the site and include the antenna locations on the sketch.
- 3 If the site is a repeater or master, ensure the master or repeater radio will communicate to the remote radio before leaving for a remote site.
- 4 At the remote site, temporarily mount the antenna, power the radio and use RadioShop software to verify RF connection to the master or repeater
- 5 When the radios acquire, use RadioShop to gather the site data by generating a report on each radio's WAN connectivity data. The WAN Nodes connectivity report provides the received signal strength indication (RSSI), tickle success percentage, and data success percentage. Be sure to request at least 3 or 4 WAN connectivity packets from each radio before moving to the next remote site.
- 6 Perform a quick evaluation of the RSSI, tickle success percentage, and data success percentage numbers to get an indication of the RF connectivity for the site. RSSI values should generally be greater than 100 units for Series I radios and greater than 130 units for radios. Tickle success percentage should exceed 40 percent and data success percentage should exceed 80 percent. In all cases the higher the numbers, the better the connectivity.

Table 3.4 Connectivity Table

	RSSI (Si/SII)	Tickle Success %	Data Success %
Good Connectivity	High (120+/150+)	High (70%+)	High (90%+)
Poor Connectivity	Low (100-/130-)	Low (50%-)	Low (80%-)
Out-of-Band Interference	High	Low	Low
Excessive Traffic	Good	Low	Good

7 Repeat steps 4, 5, and 6 for each remote site in the predicted coverage area. If all of the remote sites connect to the master or repeater, then the survey is complete and the path predictions are valid. If you discover that one or more paths fail to establish connectivity to the master or repeater, then alternate sites must be identified in order to secure the necessary connectivity paths.

Design Considerations

The following concepts pertaining to 900 MHz radio and UtiliNet packet radio should be kept in mind when designing a UtiliNet network:

- Antenna height provides the best investment in terms of radiated coverage at 900 MHz.
- 900 MHz RF energy is absorbed by foliage, especially if the path is directly through an area of concentrated foliage. Paths that angle down through the foliage instead of horizontally through the foliage provide the best penetration.
- UtiliNet radios move packets in a forward direction in an effort to close the distance to the final destination.
- UtiliNet radios operate in a simplex fashion. They may receive packets or transmit packets at any point in time, but they can't receive and transmit at the same time. This implies that multiple paths should exist into and out of data collection/delivery points if possible.

Glossary

Accumulator An accumulator is simply a counter in an RTU that records the number of times a contact opens and closes or in the case of a form C contact, records the number of transitions from one contact to the other (K to Y then K to Z in the meter world). Accumulators are most often used as interfaces into metered values. Each accumulated pulse represents some metered quantity (KWH, gallons, barrels, etc.).

Analog An analog value is typically a measurement value obtained from a transducer. The transducer interfaces to a system point to provide an input signal to an analog to digital converter. Transducers typically output DC current signals in the 0 to 1 mA range or 4 to 20 mA range. The DC output signal of a transducer is directly proportional to the input measurement value to the transducer. The transducer output is the input to an analog to digital converter that transforms the DC signal to a digital count. Most analog values are 11 or 12 bits plus sign. As an example, a typical voltage transducer accepts 0 to 150 volts AC and outputs 0 to 1 mA. An eleven bit A/D converter would output a value of 1706 for an input value of 125 volts ($125 = (1706 / 2047) * 150$).

Bit Oriented Protocol A bit oriented protocol is one that consists of a string of bits, 32 for example, without a start bit, stop bit or parity bit. This type protocol was popular before microprocessors existed. The string of individual bits was shifted using shift registers until 32 bits were captured and then the 32 bits were evaluated for proper message content. Existing asynchronous UART hardware, such as the transparent port, cannot capture bit oriented protocols without the possibility of dropping bits that may have meaning in the definition of the protocol.

Bose Chaudhuri Hocquenghem (BCH)

BCH is another form of cyclic redundancy check used to detect transmission errors in master to RTU and RTU to master communications. BCH checks are most often found in bit oriented protocols. Newer protocols typically implement some form of CRC-16 or CRC-CCITT.

Byte Oriented Protocol A byte oriented protocol is a protocol that uses one or more 8 bit bytes where each individual byte contains a start bit, one or two stop bits, and odd, even or no parity bit. Byte oriented protocols are becoming the **de facto** standard for asynchronous communications. These protocols generally take advantage of UART hardware for communications.

Color The color field distinguishes different addresses at a particular latitude and longitude. A WAN address is composed of a latitude, longitude, and color. Color is used to distinguish multiple radios at the same latitude/ longitude. In a network using domain routing, only color values 0 through 7 denote multiple radios at the same latitude/ longitude. Color values 8 through 30 distinguish different domains, each domain using a different color. A color value of 31 is a wildcard value and an address with a color value of 31 matches any address with the same latitude/longitude regardless of color. Radios are not programmed with color 31. Color 31 is only used in addressing packets to radios.

Connectivity The quality of a radio's communication with another radio.

Core In a network using domain routing, the core is the highway of routing radios that are used to route between domains. There is only one set of core radios in a network.

Core Radio In a network using domain routing, radios are divided into "core" and "domain" radios. Core radios are routing radios that serve as a highway to route packets between domains.

Cyclic Redundance Check (CRC)

CRC calculations provide a greater degree of security over a simple LRC. CRC checks reveal a higher proportion of errors and are typically 16 bit values computed from the bit pattern of each byte of a message. CRC calculations are performed by dividing the entire message by a known polynomial and retaining the remainder as the check value. The same calculation is repeated at the receiving end and compared to the received CRC value. Cellnet uses a CRC-CCITT ($X^{16} + X^{12} + X^5 + 1$) calculation with each packet exchange in the network.

DCW Device control word programming language. The programs execute within devices and provide the ability to control the device.

Domain In a network using domain routing, a domain is a localized region of connectivity. The radios within a particular domain are well connected but do not have good connectivity to other domains. The core is used to route between domains.

Domain Qualifying Radius Qualifying radius in domain routing is used to qualify radios as being in the correct domain as the destination of a packet if there are separate domains with the same color. A domain

radio qualifies as in the same domain of the packet destination if it has the same color and its geographic location lies within the domain qualifying radius of the final destination. During a domain cul-de-sac, a core radio that sees a domain of the same color qualifies as seeing the correct domain if it is within this distance of the final destination.

Domain Radio In a network using domain routing, radios are divided into “core” and “domain” radios. Domain radios are radios that have connectivity among radios in their domain, but are not good routing choices for packets destined to other domains.

Domain Routing Domain routing is an optional routing configuration for radios with 412 or later firmware. It serves to eliminate undesirable routing choices by forcing packets to travel through a core highway of radios and not route through areas of poor connectivity. The network is divided into “core” and “domain” radios.

Domains Seen In domain routing, core radios report information to other core radios of which of the 23 domain colors they have direct connectivity to and how well it can see each one (unlike latency to core, it is not an accumulated value). This information is used by core radios to route packets in a cul-de-sac situation with a packet addressed to a domain. A higher value for domains seen is better. Values range from 0 to 3. A 0 represent no connectivity and a 3 represents good connectivity.

Device Address The combined 10-byte WAN and LAN address of a device.

Forward Closer to the final destination of a packet.

LAN Address The 4-byte address that uniquely identifies a particular device at a radio location. A radio’s LAN address is its serial number.

Latency to Core In domain routing, domain radios pass information among other radios of the same domain to indicate how well they serve as paths to the core network. Latency to core is a value reporting how well a radio has connectivity to a core radio (either directly or through other domain radios reporting their latencies to core – in which case the latency is an accumulated value). The better the connectivity, the lower the latency. Values range from 0 to 255. This provides information for a domain radio to route through radios with lower latency when routing to core. This is necessary because the core radios may not be in the forward direction (the direction of the packet destination). Latency to core is used in route to core mode when geographic routing is not used.

Longitudinal Redundancy Check (LRC)

An LRC is a simple security check applied to each byte of a message string. A typical example is EXCLUSIVE-ORing each byte of a message. The EXCLUSIVE-OR is a common security check but not very robust in terms of detecting bit errors in a multibyte message. Most LRC checks are used in conjunction with parity (even or odd).

Luck A packet parameter that controls the maximum number of “hops” that a packet can travel. Each time the packet is passed off to another radio, the luck parameter in the packet is decremented. If the luck reaches 0 before reaching the destination, then the packet is discarded. This limits packet movement so that packets do not hop around forever. A luck of 255 will not be decremented and will disable this limitation for such a packet.

MAS MAS (multiple address system) is an acronym applied to 928 - 954 MHz radio systems. Specifically, the MAS radios operate on 1 of 40 pairs of 12.5 kHz narrowband channels between 928 and 954 MHz – one transmit frequency and a corresponding receive frequency separated by 10 to 12 MHz. The MAS systems operate with a single master transmitter that transmits continuously and a minimum of 4 slave radios at RTU sites to “hear” the master message and respond if the delivered message belongs or is addressed to the RTU. These systems have fast response times and are generally considered to be direct replacements for dedicated telephone circuits.

Master Station The master station is the intelligence, that is typically centrally located, which orchestrates the system. The Master Station is also the point of MMI (Man/Machine Interface). Other names for master station might include MTU, SCADA host, etc.

Mood A packet parameter that controls the routing of packets. It specifies how a radio with the packet decides which radio to pass the packet on to. Each of four moods can be individually specified, resulting in sixteen combinations. The four mood settings are “persistent,” “quick,” “reliable,” and “scram.” When all settings are off, the mood is called “courteous.” Mood is generally represented as a 4-bit field or nibble quantity with the bits representing the mood settings as follows:

Bit 3: L3_MOOD_PERSISTENT

Bit 2: L3_MOOD_QUICK

Bit 1: L3_MOOD_RELIABLE

Bit 0: L3_MOOD_SCRAM (not supported)

Multipoint Radios Multipoint radios are radios that may initiate data to multiple destination addresses.

Packet Parameters The parameters in a packet that control the routing, processing, and limitations of its transmittal. The four packet parameters are mood, priority, luck, and time-to-live.

Passive Multipoint Radios Passive multipoint radios are radios that may respond with data to multiple destination addresses, but only after being sent a request for data from that address.

Persistent A mood packet parameter that specifies to use only battery backed radios for routing (source and destination need NOT be battery backed).

Point Radios Point radios are radios that always transmit data to the same destination address.

Priority A packet parameter that controls the processing of a packet. A higher priority packet is processed before a lower priority packet. A user packet can have a priority from 0 through 7 (0 being the lowest priority and 7 being the highest priority). It is not recommended that users regularly use high priorities. A few higher priority levels should always be reserved and unused for diagnostics. A non-user priority 8 is used for maintenance packets. Radios with version 413 of the firmware limit the priority of transparent packets to a maximum of 5.

Protocol Protocol is the language used between the MTU and RTUs to communicate. Historically, each SCADA vendor produced his own protocol to prevent competition after the initial purchase decision was made.

Quick A mood packet parameter that specifies to factor in both tickle and data success percentage when creating and ordering the scan lists.

Reliable A mood packet parameter that specifies to limit “hop” distance to that specified by Short Hop Length [916BH] when creating scan lists. Radios farther than this configured distance will not be considered for passing off a packet with this mood setting.

RTU Remote Terminal Unit, the RTU, is the slave or remote device that interfaces with field devices. The RTU is intelligent in that it contains a microprocessor but typically performs few tasks unless instructed to do so by the MTU.

Scan List The list of radios that qualify to route a particular packet to.

Status In the SCADA world, status refers to a digital input point to an RTU. The digital input point is in one of two possible states at any point in time. The point is a one or zero depending on the state of a physical contact that is directly connected to the RTU. For instance, a circuit breaker is either open or closed, a backwater gate is either up or down, or a lift pump is on or off.

Time-To-Live A packet parameter than controls the maximum number of seconds that a packet can exist. The time-to-live counts down and if it reaches 0 before the packet reaches its destination, the packet is discarded.

UART Universal Asynchronous Receiver Transmitter, UART, is an acronym given to an integrated circuit (IC) that relieves a microprocessor from some of the communications overhead involved in receiving and transmitting asynchronous, serial, byte oriented data. Typically UARTs are programmable for multiple baud rates, 7 or 8 data bits, 1 or 2 stop bits, and odd, even or no parity.

WAN Address The 6-byte geographic address of the radio used for routing packets through the radio network. During the configuration process, a radio’s latitude, longitude, and color are converted into the 6-byte address that is actually used for routing.