

# TruAlign Time Recorder

Model 800P

## Installation & User's Guide

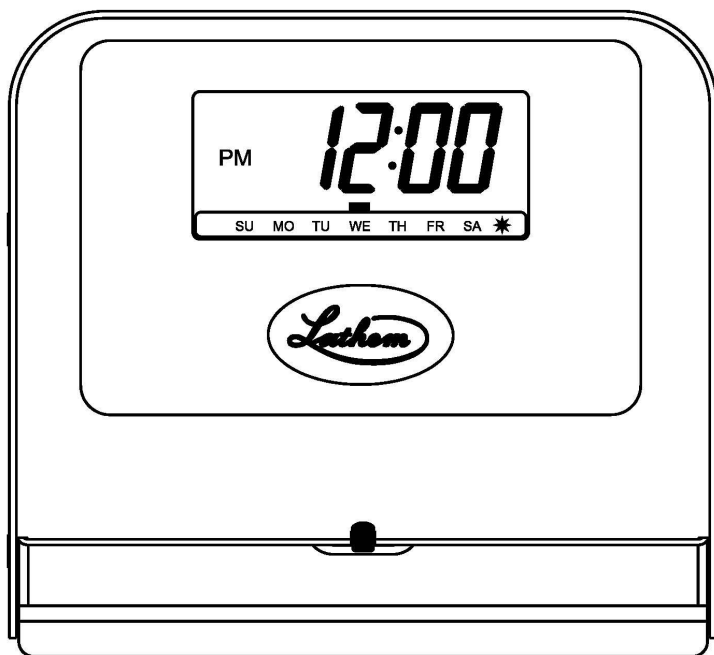

This device complies with Part 15 of the FCC Rules. Operation is subject to the following two conditions: (1) this device may not cause harmful interference, and (2) this device must accept any interference received, including interference that may cause undesired operation.

**WARNING:** Changes or modifications to this product not expressly approved by the party responsible for compliance could void the user's authority to operate this equipment.

**NOTICE:** This equipment has been tested and found to comply with the limits for a Class B digital device, pursuant to Part 15 of the FCC Rules. These limits are designed to provide reasonable protection against harmful interference in a residential installation. This equipment generates, uses, and can radiate radio frequency energy and, if not installed and used in accordance with the instructions, may cause harmful interference to radio communications. However, there is no guarantee that interference will not occur in a particular installation. If this equipment does cause harmful interference to radio or television reception, which can be determined by turning the equipment off and on, the user is encouraged to try to correct the interference by one or more of the following measures:

- Reorient or relocate the receiving antenna.
- Increase the separation between the equipment and receiver.
- Connect the equipment into an outlet on a circuit different from that to which the receiver is connected.
- Consult the dealer or an experienced radio TV technician for help.

This Class B digital apparatus complies with Canadian ICES-003.  
Cet appareil numérique de la classe B est conforme à la norme NMB-003 du Canada.

### **Disclaimer**

The information within this document has been carefully checked and is believed to be entirely reliable. However, no responsibility is assumed for inaccuracies. Lathem Time Corp. reserves the right to make changes to any products herein to improve reliability, function, or design.

### **Trademark**

TruAlign, Lathem and the Lathem logo are registered trademarks of Lathem Time Corporation. Other product names mentioned in this manual may be trademarks of their respective companies and are hereby acknowledged.

**WARNING:** Changes or modifications to this product not expressly approved by the party responsible for compliance could void the user's authority to operate this equipment.

Copyright © 2009 Lathem Time Corporation. All rights reserved.

**Lathem Inc**  
200 Selig Drive SW  
Atlanta, GA 30336  
[www.lathem.com](http://www.lathem.com)

Document Number: USG0077  
Revised 11-03-2009

# Table of Contents

Introduction .....	5
Features.....	5
Caution .....	6
About this Manual .....	6
Optional Accessories .....	6
Packing Contents .....	7
Recommended Installation Tools .....	7
Quick Easy Setup (Wall Mount).....	8
Quick Easy Setup (Table Top Mount).....	9
Setup .....	10
Setting the Time.....	12
Setting the Date and Other Functions .....	13
Factory Settings .....	13
Settings Quick Reference.....	14
Function 1 - Set Month.....	15
Function 2 - Set Date.....	16
Function 3 - Set Year.....	17
Function 4 - Change Factory Default Daylight Savings .....	18
Function 9 - Set 12/24 Hr Display.....	19
Function 10 - Set 12/24 Hr Print .....	20
Function 11 - Set Print Minute Format .....	21
Function 12 - Set Day Print Language .....	22
Function 13 - Set Print Intensity .....	23
Function 14 - Confirmation Beep Disable/Enable .....	24
Function 15 - TruAlign Calibration / Print Head Test .....	25
Wall Mount.....	26
Mounting to a Wall .....	26
Using the Time Recorder.....	28
Appendix A - Changing the Print Intensity .....	29
Appendix B - Calibrating the TruAlign Function.....	30
Appendix C - Testing the Print Head.....	33
Appendix D - Changing the dates for Daylight Savings.....	34
Appendix E - Disable Daylight Savings Correction .....	35
FREQUENTLY ASKED QUESTIONS .....	36
SPECIFICATIONS.....	37
WARRANTY.....	39

## Introduction

Thank you for purchasing our time recorder. For safe and proper operation, please carefully read this manual before using the time recorder and save it for reference.

Lathem's 800P TruAlign Time Recorder is a maintenance-free employee time recorder that uses no ink, ribbon or toner and operates without any loud impact noise to disturb the working environment.

Lathem's 800P TruAlign Time Recorder features the patented "TruAlign" feature, which helps employees align their timecards to ensure a clear registration at the correct position on the timecard.

The employee places the long edge of the timecard on the timecard shelf of the 800P and aligns the timecard to the cell to be printed. When the timecard is aligned correctly an automatic imprint with the day and time will be recorded on the timecard. The indicator turns green when the printing is complete and the timecard can be removed.

The 800P TruAlign Time Recorder uses the Lathem timecard #E8. The time and date programming is protected by an internal lithium battery

## Features

Typical applications: Payroll or job cost recorder.

- Quartz time clock
- Automatic daylight savings time
- 12 or 24 hour format
- Thermal printer
- Digital LCD display (AM/PM, Hour, Minute, Day of week and Daylight Savings indication)
- Perpetual calendar
- Prints in 3 languages
- Regular minute or 1/100 of hour
- Print intensity adjustment
- Automatic imprint on timecard
- Internal lithium battery backup

## Caution

Avoid placing the time recorder in environments that are:

- humid
- dusty
- exposed to direct sunlight
- subject to frequent or continuous vibrations
- affected by chemicals or ozone
- outside the temperature range between +25°F and 113°F

Place the time recorder close to a wall outlet so that it is easy to disconnect.

Do not put a heavy object on the time recorder, or forcefully press the time recorder onto the back-plate. This may cause trouble with the punching mechanism.

Lithium battery contains perchlorate material - special handling may apply. Please go to the web site <http://www.dtsc.ca.gov/hazardouswaste/perchlorate> for information about proper methods of disposal.

## About this Manual

This manual will guide you through the installation, set up and use of your 800P TruAlign Time Recorder.

## Optional Accessories

- E8-100 Weekly timecard for the 800P (pack of 100)
- 25-9EX Expanding timecard rack, 9" cards, 25 pockets

Note: The E8 timecards are sensitive to temperature and should always be stored in a cool dry location preferably out of exposure to direct sun light. Storage temperature should not exceed 150°F (65 °C).

## Packing Contents

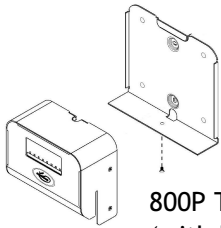

800P Time Recorder  
(with back-plate)

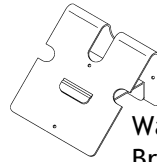

Wall-Mount  
Bracket

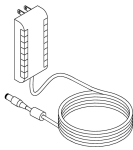

AC Wall  
Adapter

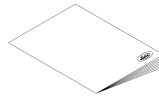

Installation & User's  
Guide

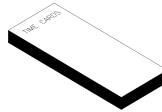

Sample pack of E8  
timecards

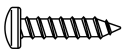

(2) #8 Philips Head screws for Wall-Mount Bracket

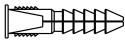

(2) #8 Anchors (use for masonry wall installation  
only)



(2) 8-32 x 1/4 Philips Head screws to install Back-Plate  
to Wall-Mount Bracket

## Recommended Installation Tools



Tape Measure



Pencil



Philips Head  
Screw Driver



*Optional-*  
Power Drill &  
Drill Bits

## Quick Easy Setup (Wall Mount)

To setup your 800P, follow these next steps:

### Step 1

Separate the back-plate from the 800P by removing the Philips head screw. Retain the screw for later.

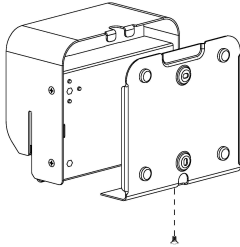

### Step 2

Install the wall-mount bracket to the wall using the supplied wall-mount screws. Note: For best visibility mount the 800P about **48 inches** from the floor.

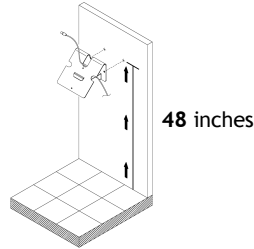

### Step 3

Using the supplied 8-32 x ¼ Philips head screws install the back-plate to the wall-mount bracket.

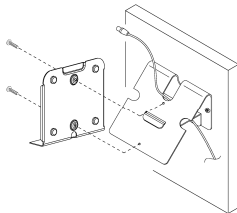

### Step 4

With the back-plate secured to the wall-mount bracket, plug the AC wall adapter into the 800P.

Note: The time, date and other settings are factory set. See “Factory Settings” below. If these settings are acceptable you are ready to begin, otherwise see Page 11 “Programming the 800P”.

### Step 5

Align and place the 800P on the back-plate and secure the two together with the 8-32 x ¼ Philip head screw. Be careful not to pinch the AC cord.

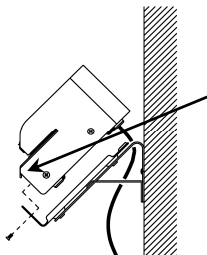

**Note:** Make sure the bottom of the timecard shelf is over the edge of the back-plate before securing the screw.

### Factory Settings

- Time=U.S. Eastern Time
- Daylight Savings=On
- Spring Daylight Savings=Second Sunday in March
- Fall Daylight Savings=First Sunday in November
- Displayed Time Format=AM/PM hours & Minutes
- Printed Time Format=AM/PM hours & Minutes
- Day of Week Language=English
- Confirmation Beep=Disabled

## Quick Easy Setup (Table Top Mount)

To setup your 800P, follow these next steps:

### Step 1

Separate the back-plate from the 800P by removing the Philips head screw. Retain the Philips head screw for later.

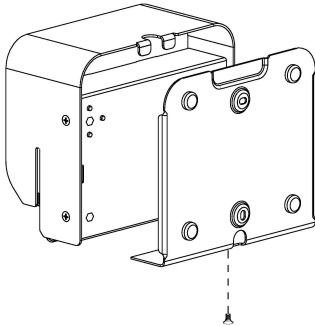

### Step 2

Plug the AC adapter into the 800P and then plug the wall adapter into the AC outlet.

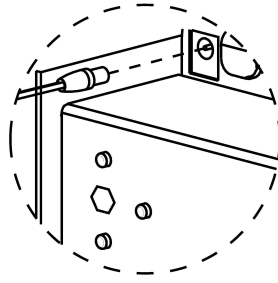

### Step 3

Secure the back-plate to the 800P with the Philips head screw being careful not to pinch the AC cord. Make sure the bottom of the timecard shelf is over the edge of the back-plate before securing the screw. Place the 800P on a solid flat surface. You are ready to begin using the 800P.

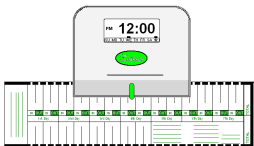

**Note:** The time, date and other settings are factory-set. See “Factory Settings” to the right. If these settings are acceptable you are ready to begin, otherwise see Page 11 “Programming the 800P”.

### Factory Settings

- Time=U.S. Eastern Time
- Daylight Savings=On
- Spring Daylight Savings=Second Sunday in March
- Fall Daylight Savings=First Sunday in November
- Displayed Time Format=AM/PM hours & Minutes
- Printed Time Format=AM/PM hours & Minutes
- Day of Week Language=English
- Confirmation Beep=Disabled



## Setup

To set up your 800Ptime recorder, follow these next steps:

### Remove the Back-Plate

Separate the back-plate from the time recorder by removing the Philips head screw. Retain the Philips head screw for later.

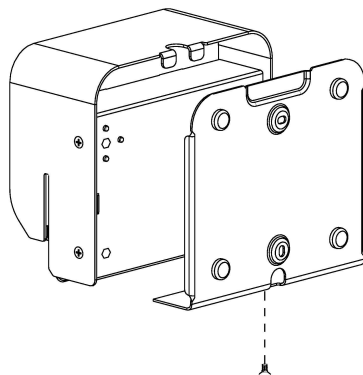

### Connect the AC Power

Plug the AC adapter into the time recorder and then plug the wall adapter into the AC outlet.

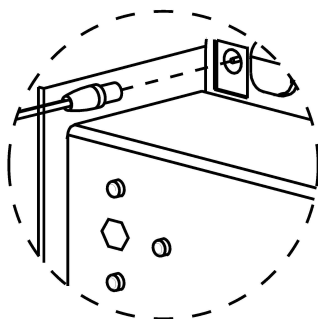

**NOTE:** The time recorder has an internal battery that will retain the programming if the time recorder is unplugged from AC power.

## Programming the 800P

After removing the back-plate and connecting the AC power you will be ready to begin programming the 800P time recorder. Use the three buttons on the back to program the time recorder. Hold the time recorder with both hands with the display facing you. Use your index and middle fingers to press the programming buttons on the back of the time recorder while watching the settings on the display. Note: An undisturbed environment is recommended when programming the timeclock.

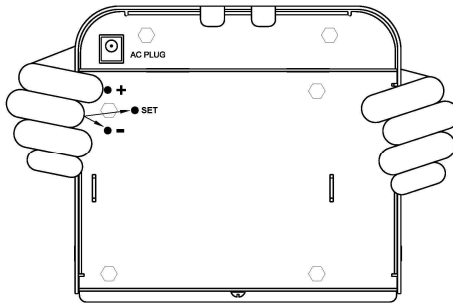

### Using the 3 programming buttons

#### **+** (Plus)

When you press the **+** button, you increment or change the selected setting.

#### **SET**

You can set the value of the selected setting on the display by pressing the **SET** button which also moves you to the next available setting.

#### **-** (Minus)

When you use the **-** button, you decrement or change the selected setting.

### **What if I press the SET button by mistake?**

If you make a programming mistake by pressing the **SET** button too soon, simply unplug the AC power or continue pressing the **SET** button until you have the normal time and date on the display. Then go back into the Set Up Mode and continue your programming.

### Setting the Time

To enter the 'Time Set Up Mode', press the **+** and **SET** buttons at the same time.

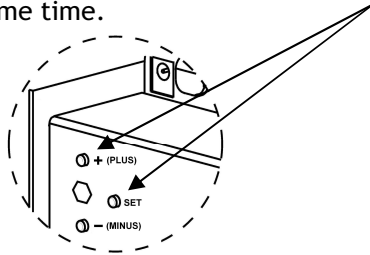

The blue light will turn off and the display will show the hours and minutes, release the **+** and **SET** buttons.

Press the **+** button to move the time forward or press the **-** button to move the time backwards. To move quickly through the time, press and hold down the **+** or **-** button. Holding down either button will increase how quickly you scroll through the time. When you have the desired hours and minutes on the display, press the **SET** button.

**Note:** The seconds will be zeroed when you press the **SET** button, so it's recommended to set the time 1 or 2 minutes ahead of the actual time. Wait until the actual time matches the time recorder, and then press the **SET** button which will synchronize the time recorder time with the actual time.

Example: Set the time from 11:00am to 1:00pm

Hours and Minutes

AM 1 1 0 0

PM 0 1 0 0

#### Step 1

Press the **+** button to scroll forward until the display shows 'PM 0 1 0 0'. Notice while you are scrolling through the hours the AM will change to PM.

#### Step 2

Press the **SET** button when the AM/PM indicator, hour and minutes are correct. The time will be accepted and the time recorder will return to a normal display.

### Setting the Date and Other Functions

To enter the 'Setup Mode', press the **-** and **SET** buttons at the same time.

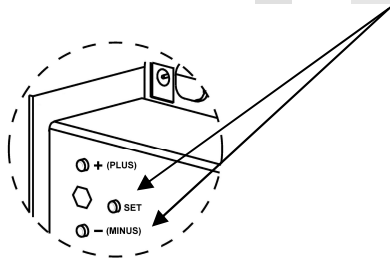

Release the buttons, the blue light will turn off, the 'Set Month' function (1) will display.

Press the **+** or **-** buttons to change the value of the settings. The **+** button moves you forward and the **-** button moves you backwards through the available selections. When you have the desired setting on the display, press the **SET** button.

### Factory Settings

The time recorder has several settings that are pre-set at the factory. The factory default settings include:

- Daylight Savings=**On**
- Spring Daylight Savings=**Second Sunday in March**
- Fall Daylight Savings=**First Sunday in November**
- Displayed Time Format=**AM/PM hours & Minutes**
- Printed Time Format=**AM/PM hours & Minutes**
- Day of Week Language=**English**
- Confirmation Beep=**Disabled**

Simply press the **SET** button to accept these factory settings when you are programming the time recorder.

## Set up Functions

The set up functions of the time recorder are in sequential order from 1 through 15. When in the 'Setup Mode' you **must** pass through each function even if you only need to change a single setting. Simply press the **SET** button to accept the settings that you do not wish to change. **Note:** If you do not pass through each setting your time recorder may not be configured as you desired.

To enter the 'Setup Mode' for date and other functions, press the **-** and **SET** buttons at the same time.

Function	Settings	Selections	Factory Settings
1	Set Month	01 - 12	-
2	Set Date	01 - 31	-
3	Set Year	00 - 99	-
4	Change Factory Default Daylight Savings	y - n	n
5	Set Spring DST Month	00 - 12	03
6	Set Spring DST Sunday	1,2,3,4,Last	02
7	Set Fall DST Month	00 - 12	11
8	Set Fall DST Sunday	1,2,3,4,Last	01
9	Set 12/24 Hr Display	12 / 24	12
10	Set 12/24 Hr Print	12 / 24	12
11	Set Print Minute Format	1-Mins/ 2- 1/100s of Hour	1
12	Set Day of Week Print Language	English, French, Spanish	E
13	Set Print Intensity	1 - 9	5
14	Confirmation Beep	n-Disabled, y-Enabled	n
15	TruAlign Calibration/ Print Head Test	0-No, 1-Yes, 2 - 9 Print Head Test	0

### Function 1 - Set Month

When prompted to set the month, use the **+** button to scroll forward or the **-** button to scroll backwards. With the desired month showing on the display, press the **SET** button. The 'Set Date' function (2) will display next.

Example: Set the month from 01 to 10

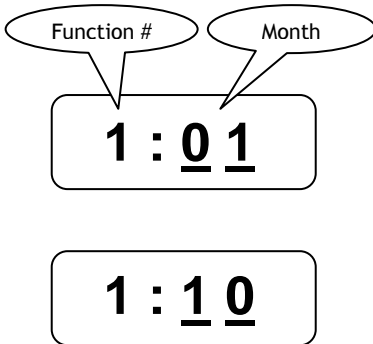

#### Step 1

Press the **+** or **-** button until the display shows '10'.

#### Step 2

Press the **SET** button when the month is correct. The month will be accepted, go to the 'Set Date' function.

**Note:** If you scroll past the month you wish, continue pressing the **+** or **-** button until the desired month displays, then press the **SET** button.

**Important Note:** The set up functions of the time recorder are in sequential order and you must pass through each setting to complete the programming. Simply press the **SET** button to accept the settings that you do not wish to change.

Your time recorder may not be programmed as you desired if you do not pass through each setting.

## Function 2 - Set Date

When prompted to set the date, use the **+** button to scroll forward or the **-** button to scroll backwards. With the desired date showing on the display, press the **SET** button. The 'Set Year' function (3) will display next.

**Note:** If setting the date in February make sure you set the date correctly, for example leap year has 29 days, otherwise the daylight savings may not activate correctly.

Example: Set the date from 21 to 05

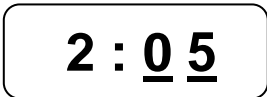
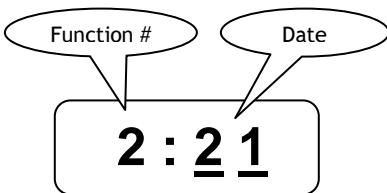

### Step 1

Press the **+** or **-** button until the display shows '05'.

### Step 2

Press the **SET** button when the date is correct. The date will be accepted, go to the 'Set Year' function.

**Note:** If you scroll past the date you wish, continue pressing the **+** or **-** button until the desired date displays, then press the **SET** button.

### Function 3 - Set Year

When prompted to set the year, use the **+** button to scroll forward or the **-** button to scroll backwards. With the desired year showing on the display, press the **SET** button. The 'Set DST' function (4) will display next.

Example: Set the year from 01 to 09

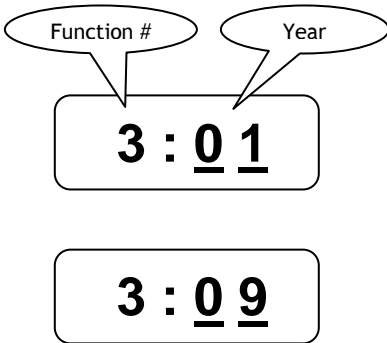

#### Step 1

Press the **+** or **-** button until the display shows '09'.

#### Step 2

Press the **SET** button when the year is correct. The year will be accepted, go to the 'Change Factory Default Daylight Savings' function.

**Note:** If you scroll past the year you wish, continue pressing the **+** or **-** button until the desired date displays, then press the **SET** button.



#### Function 4 - Change Factory Default Daylight Savings

This function allows you to change or modify the factory default daylight savings settings. The daylight savings setting are set at the factory for the **Second Sunday in March** and the **First Sunday in November**.

Most customers should use the factory settings for daylight savings. The daylight savings setting are set at the factory for the **Second Sunday in March** and the **First Sunday in November**.

To use the factory settings for daylight savings, press the **SET** button at Function 4.

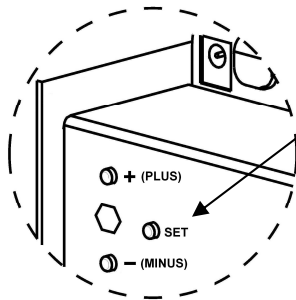

**Note:** Normally you would use the default settings and by pass the Daylight Savings settings by pressing the **SET** button.

For more information see:

**Appendix E - Changing the dates for Daylight Savings**

**Appendix F - Disable Daylight Savings Correction**

### Function 9 - Set 12/24 Hr Display

When prompted to select the format for how hours show on the display, use the **+** button to scroll forward or the **-** button to scroll backwards. With the desired format showing on the display, press the **SET** button. The 'Set 12/24 Hr Print' function (10) will display next.

#### Setting Values

- 12 = Show hours on display as AM / PM (1:00 in the afternoon will show as **PM 1:00**)
- 24 = Show hours on display as 0 - 23 (1:00 in the afternoon will show as **13:00**)

Example: Set the format from 12 to 24

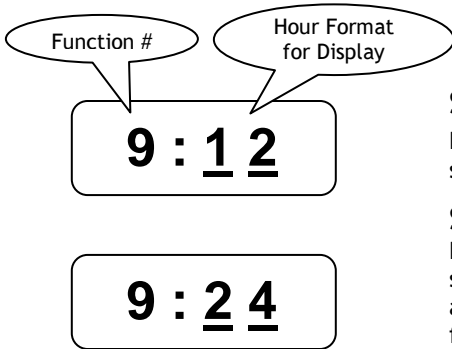

#### Step 1

Press the **+** or **-** button until the display shows '24'.

#### Step 2

Press the **SET** button when the format selection is correct. The format will be accepted, go to the 'Set 12/24 Hr Print' function.

**Note:** If you scroll past the format you wish, continue pressing the **+** or **-** button until the desired format displays, then press the **SET** button.

### Function 10 - Set 12/24 Hr Print

When prompted to select the format for how hours will print on the timecard, use the **+** button to scroll forward or the **-** button to scroll backwards. With the desired format showing on the display, press the **SET** button. The 'Set Print Minute Format' function (11) will display next.

#### Setting Values

**12** = Print hours on the timecard as AM / PM (1:00 in the afternoon will print as 1:00 P)

**24** = Print hours on the timecard as 0 - 23 (1:00 in the afternoon will print as 13:00)

Example: Set the format from 12 to 24

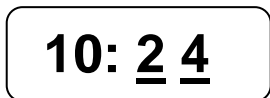
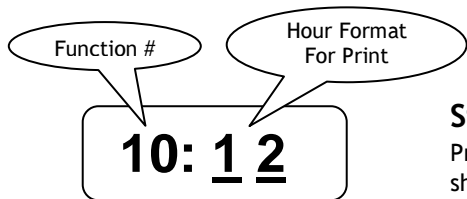

#### Step 1

Press the **+** or **-** button until the display shows '24'.

#### Step 2

Press the **SET** button when the format selection is correct. The format will be accepted, go to the 'Set Print Minute Format' function.

**Note:** If you scroll past the format you wish, continue pressing the **+** or **-** button until the desired format displays, then press the **SET** button.

### Function 11 - Set Print Minute Format

When prompted to select the format for how minutes will print on the timecard, use the **+** button to scroll forward or the **-** button to scroll backwards. With the desired format showing on the display, press the **SET** button. The 'Set Day Print Language' function (12) will display next.

#### Setting Values

1 = Print minutes on the timecard as 00 - 59 (30 minutes will print as :30)

2 = Print minutes on the timecard as hundredths of hour 0 - 99 (30 minutes will print as .50)

**Note:** See page 38 for a "minutes to 1/100s of hour conversion chart".

Example: Set the format from minutes to hundredths of an hour

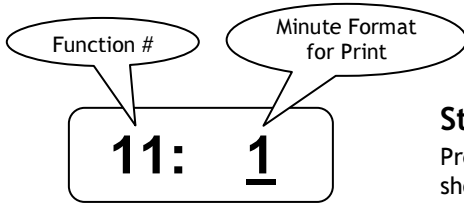

#### Step 1

Press the **+** or **-** button until the display shows '2'.

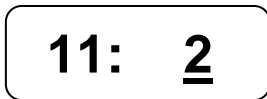

#### Step 2

Press the **SET** button when the format selection is correct. The format will be accepted, go to the 'Set Day Print Language' function.

**Note:** If you scroll past the format you wish, continue pressing the **+** or **-** button until the desired format displays, then press the **SET** button.

## Function 12 - Set Day Print Language

When prompted to select the language the day of the week will print on the timecard, use the **+** button to scroll forward or the **-** button to scroll backwards. With the desired language showing on the display, press the **SET** button. The 'Set Print Intensity' function (13) will display next.

### Setting Values

**E** = Print the day of the week abbreviation in English on the timecard

**S** = Print the day of the week abbreviation in Spanish on the timecard

**F** = Print the day of the week abbreviation in French on the timecard

Example: Set the day of week language from English to French

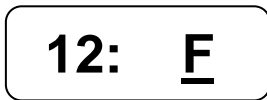
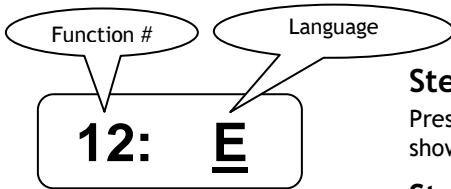

### Step 1

Press the **+** or **-** button until the display shows 'F'.

### Step 2

Press the **SET** button when the language selection is correct. The language will be accepted, go to the 'Set Print Intensity' function.

**Note:** If you scroll past the language you wish, continue pressing the **+** or **-** button until the desired language displays, then press the **SET** button.

### Function 13 - Set Print Intensity

When prompted to select the intensity of the imprint on the timecard, press the **SET** button to accept the factory setting. The 'Confirmation Beep Disable/Enable' function (14) will display next.

**Note:** Normally you would press the **SET** button to by pass the Set Print Intensity function.

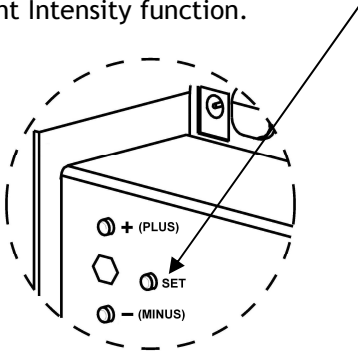

For more information see:

**Appendix B - Changing the Print Intensity**

### Function 14 - Confirmation Beep Disable/Enable

When prompted to select whether the confirmation beep will sound or will be disabled, use the **+** button to scroll forward or the **-** button to scroll backwards. With the desired setting showing on the display, press the **SET** button. The 'TruAlign Calibration' function (15) will display next.

If enabled, a confirmation beep will sound after each imprint on a timecard and also when you press the time recorder programming buttons.

#### Setting Values

**n** = Confirmation beep disabled, this is the factory setting

**y** = Confirmation beep is enabled

Example: Set the confirmation beep to enabled (**y**)

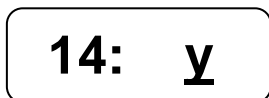
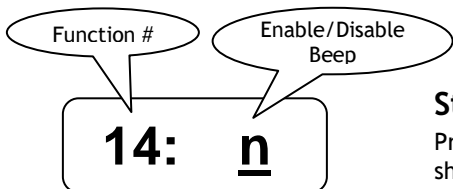

#### Step 1

Press the **+** or **-** button until the display shows 'y'.

#### Step 2

Press the **SET** button when the setting is correct. The setting will be accepted, go to the 'TruAlign Calibration' function.

**Note:** If you scroll past the setting you wish, continue pressing the **+** or **-** button until the desired setting displays, then press the **SET** button.

**Function 15 - TruAlign Calibration / Print Head Test**

When prompted to activate the TruAlign Calibration / Print Head Test, press the **SET** button to accept the factory setting.

After pressing the **SET** button the time recorder will go to the normal time/date display and will be operational.

**Note:** Normally you would press the **SET** button to by pass the TruAlign calibration function.

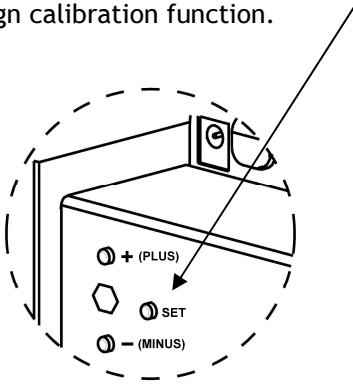

For more information see:

**Appendix C - Calibrating the TruAlign Function**

**Appendix D - Testing the Print Head**



## Wall Mount

Select a site to install the 800P time recorder that will be convenient to employees clocking In and Out. The 800P time recorder can be mounted directly to a wall. When deciding where the time recorder will be installed, keep in mind that 115VAC power outlet should be within 6 feet of the mounting location.

### Mounting to a Wall

**Note:** If you are installing the time recorder on a wall with drywall, it is recommended to use a “Molly Bolt” or Toggle Bolt” type of wall anchor.

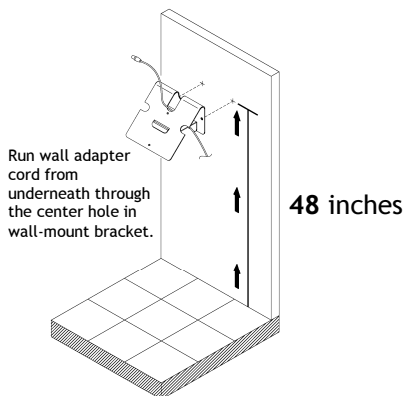

#### Step 1

Using the wall-mount bracket as a guide, mark the location on the wall of where the screws will be installed. Run the AC wall adapter cord through hole in the wall-mount bracket and then install the wall-mount bracket to the wall using the supplied wall-mount screws. **Note:** The time recorder should be mounted for best visibility, about **48 inches** from the floor.

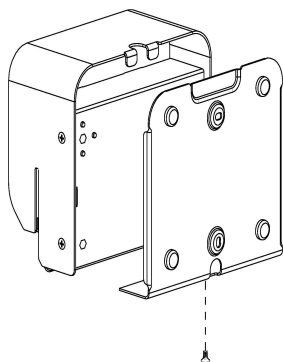

#### Step 2

Remove the Philips head screw holding the back-plate on the time recorder. Be sure to retain the Philips head screw for later.

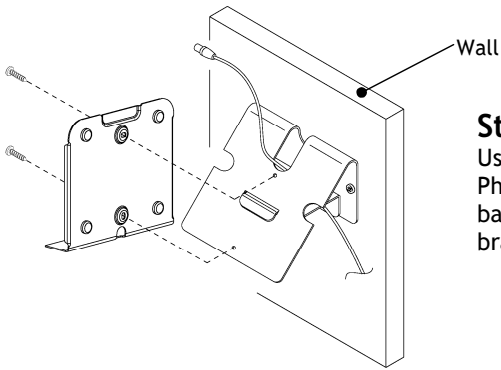

### Step 3

Using the supplied 6/32 x 3/8 Philips head screws install the back-plate to the wall-mount bracket.

### Step 4

With the back-plate secured to the wall-mount bracket, plug the AC wall adapter into the time recorder. Align and place the time recorder on the back-plate and secure the two together with the 8-32 x 1/4 Philips head screw, being careful not to pinch the AC cord. Plug the wall adapter into the AC outlet.

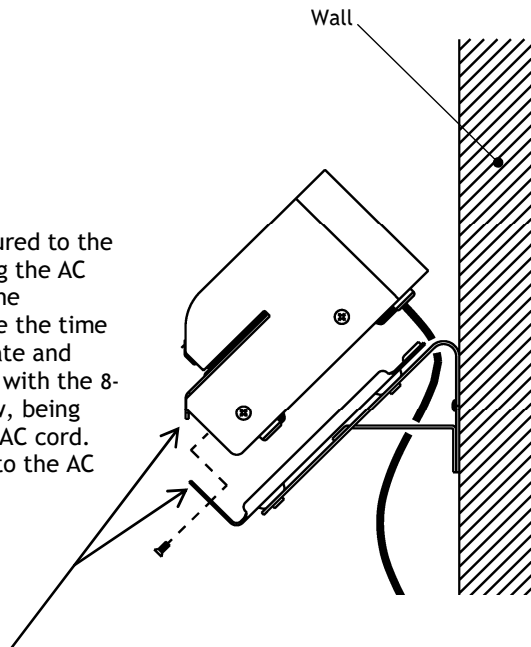

**Note:** Make sure the bottom of the timecard shelf is over the edge of the back-plate before securing the screw.

## Using the Time Recorder

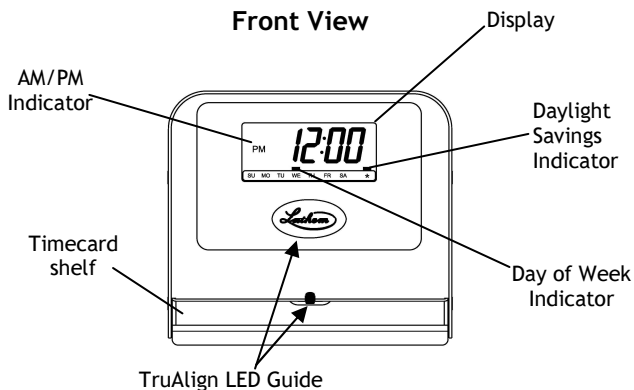

The employee places the long edge of the timecard on the timecard shelf of the 800P and aligns the timecard to the cell to be printed. When the timecard is aligned correctly an automatic imprint with the day and time will be recorded on the timecard.

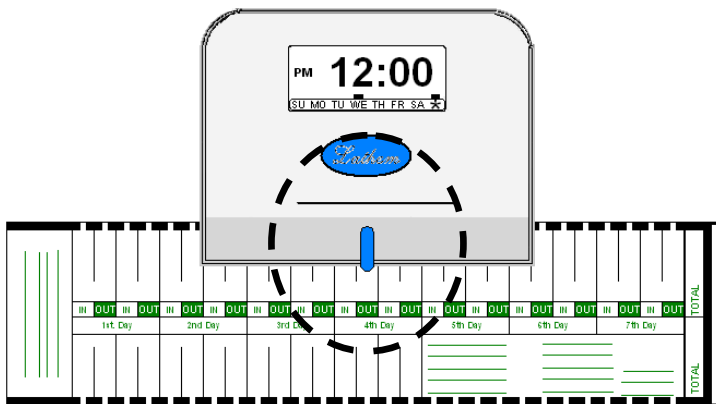

Next, four dashes (- - - -) show on the display and the indicator turns green indicating the printing is complete and the timecard can be removed.

## Appendix A - Changing the Print Intensity

### How to change the print intensity on the timecard

If the imprint on the timecard is getting faint you may wish to increase the print intensity setting from the factory setting of 5. See the instructions below.

- Enter the 'Setup Mode'. See Page 13.
- Press the **SET** button until you get to Function 13
- Use the **+** button to scroll through and set the desired print intensity level.
- Press the **SET** button through Function 14 and 15.
- The time recorder will go to the normal time/date display with the changes to the print intensity applied.

Example: Set the print intensity from 5 to 7

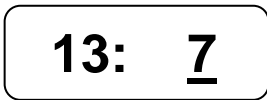
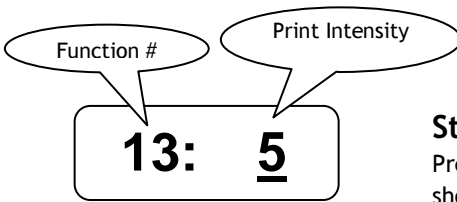

#### Step 1

Press the **+** or **-** button until the display shows '7'.

#### Step 2

Press the **SET** button when the setting is correct. The setting will be accepted, continue pressing the **SET** button through Function 14 and 15.

The time recorder will go to the normal time/date display with the changes to the print intensity applied.

**Note:** If you scroll past the setting you wish, continue pressing the **+** or **-** button until the desired setting displays, then press the **SET** button.

## Appendix B - Calibrating the TruAlign Function

The time recorder was calibrated at the factory but with the passage of time or shifts in temperature you may find it necessary to recalibrate the time recorder.

### When should I calibrate the TruAlign function for the timecard?

Recalibration may be needed if you insert a timecard in the time recorder and the blue LED changes to green when the timecard is not aligned correctly. See below for an example of a timecard when the TruAlign function needs to be recalibrated.

TruAlign function needs to be recalibrated. Imprint is not lined up correctly in timecards print area when the green LED displays.

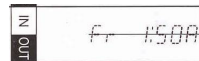
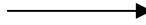

TruAlign function is calibrated correctly. Imprint is lined up correctly in timecards print area when the green LED displays.

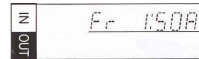
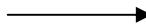

### How to calibrate the TruAlign function

To recalibrate the TruAlign function, see the instructions below. Note: It is recommended when performing the calibration function to be in a sitting position with the timeclock on a stable flat surface in an undisturbed environment.

- Enter the 'Setup Mode'. See Page 13.
- Press the **SET** button until you get to Function 15

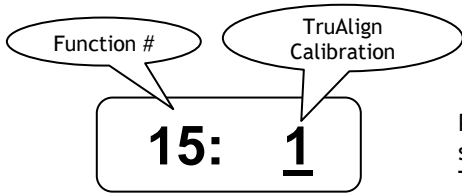

Press the **+** or **-** button until the display shows '1'. Selecting '1' activates the TruAlign calibration mode. Press the **SET** button.



The display will show 'CAL 1', insert and visually align a timecard, see Figure 1.

With the timecard fully inserted and properly aligned, press and hold the **+** button to register the alignment.

Note the value showing on the display. Shift the card slightly left and right, the value will increase or decrease.

When the display is at the smallest value, release the **+** button, the display will show 'CAL2'.

Remove the timecard.

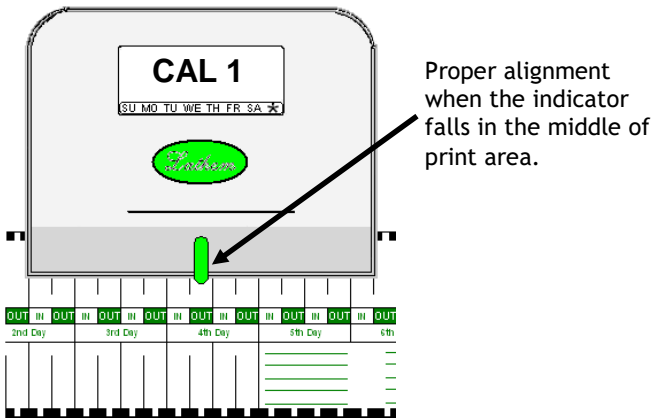

Figure 1

**CAL 2**

With the display showing 'CAL 2', insert and intentionally misalign the timecard, see Figure 2.

With the timecard fully inserted and misaligned, press and hold the **-** button to register the alignment.

Note the value showing on the display. Shift the card slightly left and right, the value will increase or decrease.

**End**

When the display is at the highest value, release the **-** button, the display will show 'END'.

Remove the timecard. Subtract the smaller registration value from the larger; the difference should be greater than 50. If the value is less than 50 you should repeat the TruAlign calibration.

Press the **SET** button to complete the calibration. The time recorder will go to the normal time/date display with the changes to the TruAlign calibration applied.

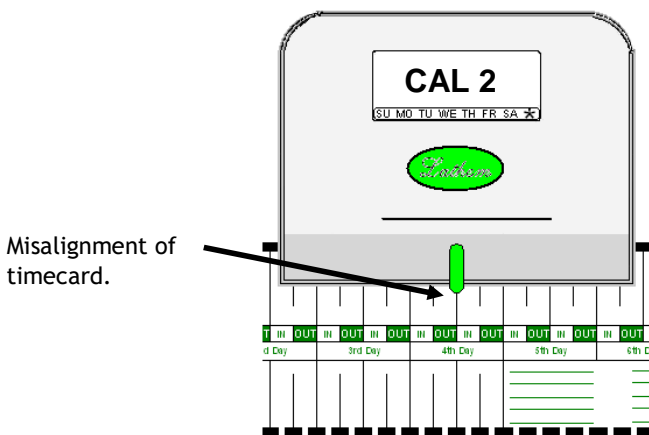

Figure 2

## Appendix C - Testing the Print Head

### When should I run the test on the print head?

If you notice that the imprint on the timecard appears to be missing segments, you can test the print head to make sure it is working correctly.

To test the print head, see the instructions below.

- Enter the 'Setup Mode'. See Page 13.
- Press the **SET** button until you get to Function 15

Example: Set the print test to 4 imprints

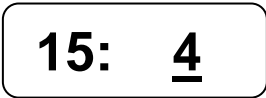
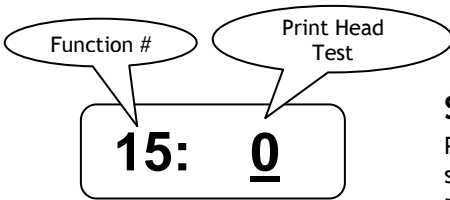

### Step 1

Press the **+** or **-** button until the display shows '4'. Note: Any value between 2 and 9 puts the time recorder into print head test mode.

### Step 2

Press the **SET** button when the setting is correct. The time recorder will be in the print head test mode.

**Note:** If you scroll past the setting you wish, continue pressing the **+** or **-** button until the desired setting displays, then press the **SET** button.

### Step 3

With the time recorder in a normal time/date display. Insert a timecard and make an imprint. The imprint should look similar to the example.



Make 3 additional imprints, after the 4<sup>th</sup> imprint the time recorder will have completed the 'print head test mode' and be ready to imprint on the timecards normally.



## Appendix D - Changing the dates for Daylight Savings

By default, daylight saving time is factory set for the **second** Sunday in **March** and the **first** Sunday in **November**.

To change the factory set daylight savings dates, see the instructions below.

- Enter the 'Setup Mode'. See Page 13.
- Press the **SET** button until you get to Function 4.
- Press the **+** or **-** button until the display shows 'Y'. Then press the **SET** button to go to Function 5.
- Use the **+** or **-** button to scroll through and set the desired month for the spring daylight savings. Then press the **SET** button to go to Function 6.
- Press the **+** or **-** button to scroll through and set the desired Sunday for the spring daylight savings. Then press the **SET** button to go to Function 7.

### Setting Values

1 = First Sunday	4 = Fourth Sunday
2 = Second Sunday	L = Last Sunday
3 = Third Sunday	

- Use the **+** or **-** button to scroll through and set the desired month for the fall daylight savings. Then press the **SET** button to go to Function 8.
- Press the **+** or **-** button to scroll through and set the desired Sunday for the fall daylight savings, and then press the **SET** button.

### Setting Values

1 = First Sunday	4 = Fourth Sunday
2 = Second Sunday	L = Last Sunday
3 = Third Sunday	

- Press the **SET** button through Function. 9, 10, 11, 12, 13, 14 and 15.
- The time recorder will go to the normal time/date display with the changes for daylight savings applied.

## Appendix E - Disable Daylight Savings Correction

By default, daylight saving time is factory set for the **second** Sunday in **March** and the **first** Sunday in **November**.

If you are located in an area that does not recognize daylight saving time, you can disable the automatic correction. To disable the daylight savings correction, see the instructions below.

- Enter the 'Setup Mode'. See Page 13.
- Press the **SET** button until you get to Function 4.
- Press the **+** or **-** button until the display shows 'Y'. Then press the **SET** button to go to Function 5.
- Press the **+** or **-** button until the display shows '00'. Then press the **SET** button to go to Function 9.
- Press the **SET** button through Function 9, 10, 11, 12, 13, 14 and 15.
- The time recorder will go to the normal time/date display with the daylight savings correction disabled.

## FREQUENTLY ASKED QUESTIONS

<p>Why will the 800P not power up?</p>	<ul style="list-style-type: none"> <li>• Check to make sure the AC power connector is plugged in securely on the back of the time recorder.</li> <li>• Make sure the AC wall outlet is supplying power. To check this you could plug in a lamp or radio.</li> <li>• Make sure the wall adapter is securely plugged into the AC wall outlet.</li> </ul>
<p>Why will nothing print on the timecard when it is inserted in the 800P?</p>	<ul style="list-style-type: none"> <li>• Make sure the timecards being used are designed for the 800P time recorder. Not all cards will work with the 800P time recorder. Use timecard # <b>E8</b>.</li> </ul>
<p>Why is the 800P printing on the timecard when it is not aligned in the timecard cell?</p>	<ul style="list-style-type: none"> <li>• You may need to recalibrate the TruAlign function. See page 30 for details.</li> </ul>
<p>When I press the SET button to accept a setting the display shows “Err #”. (# = the function number you are currently configuring.) What does this error mean?</p>	<ul style="list-style-type: none"> <li>• Typically if you see “Err #”, it means you have selected an invalid entry. For example if you see ‘Err 4’, this means you have entered an invalid setting for Function 4.</li> </ul>
<p>Why is it when there is a power failure I have to reset the time and date on the 800P?</p>	<ul style="list-style-type: none"> <li>• You may need to change the internal BR2325 coin-cell lithium battery. Contact Latham’s technical support at 1-800-241-4990, charges may apply.</li> </ul>
<p>Is there a way to reset all of the settings except the time and date to the factory default settings?</p>	<ul style="list-style-type: none"> <li>• Yes, to reset the 800P to the factory settings, press the <b>+</b> and <b>-</b> and <b>SET</b> buttons at the same time. The display will show <b>rESt</b> for 2 seconds and then the normal time / date will show.</li> </ul>
<p>Why does the display show 4 dashes ( - - - - ) after an employee punches the timecard?</p>	<ul style="list-style-type: none"> <li>• This is normal operation; the print head is readying itself for the next imprint.</li> </ul>

## SPECIFICATIONS

<b>Dimensions</b> .....	5 1/3 " H x 6" W x 3" D 13.5cm H x 15.2cm W x 7.6cm D
<b>Weight</b> .....	5.0 lbs (2.3 kg)
<b>Display</b> .....	LCD
<b>Housing</b> .....	Electro-Galvanized Steel with Powder-Paint Coating
<b>Line Power</b> .....	120vAC, 80mA typical 220vAC, 80mA typical 50 / 60 Hz
<b>Memory</b> .....	BR2325 Coin-Cell Lithium Battery <i>(change the battery every 7 years-recommendation)</i>
<b>Environment</b> .....	32° to 140° F (0° to 60° C) 95% Relative Humidity (non-condensing)
<b>Timecard Storage</b> .....	150° F (65° C) maximum temperature Note: The E8 timecards are sensitive to temperature and should always be stored in a cool dry location preferably out of exposure to direct sun light. Storage temperature should <b>not</b> exceed <b>150°F</b> (65°C).

**MINUTE CONVERSION CHART**

Minutes to 1/100s of Hour

Minutes	Decimal Hrs	Minutes	Decimal Hrs	Minutes	Decimal Hrs
1	.01	21	.35	41	.68
2	.03	22	.36	42	.70
3	.05	23	.38	43	.71
4	.06	24	.40	44	.73
5	.08	25	.41	45	.75
6	.10	26	.43	46	.76
7	.11	27	.45	47	.78
8	.13	28	.46	48	.80
9	.15	29	.48	49	.81
10	.16	30	.50	50	.83
11	.18	31	.51	51	.85
12	.20	32	.53	52	.86
13	.21	33	.55	53	.88
14	.23	34	.56	54	.90
15	.25	35	.58	55	.91
16	.26	36	.60	56	.93
17	.28	37	.61	57	.95
18	.30	38	.63	58	.96
19	.31	39	.65	59	.98
20	.33	40	.66	60	1.00

## WARRANTY

### Limited One-Year Limited Warranty

Lathem warrants the hardware products described in this guide against defects in material and workmanship for a period of **one year** from date of original purchase from Lathem or from an authorized Lathem reseller. The conditions of this warranty and the extent of the responsibility of Lathem Time Corporation ("Lathem") under this warranty are listed below.

1. This warranty will become void when service performed by anyone other than an approved Lathem warranty service dealer results in damage to the product.
2. This warranty does not apply to any product which has been subject to abuse, neglect, or accident, or which has had the serial number altered or removed, or which has been connected, installed, adjusted, or repaired other than in accordance with instructions furnished by Lathem.
3. This warranty does not cover dealer labor cost for removing and reinstalling the machine for repair, or any expendable parts that are readily replaced due to normal use.
4. The sole responsibility of Lathem under this warranty shall be limited to repair of this product, or replacement thereof, at the sole discretion of Lathem.
5. If it becomes necessary to send the product or any defective part to Lathem or any authorized service dealer, the product must be shipped in its original carton or equivalent, fully insured with shipping charges prepaid. Lathem will not assume any responsibility for any loss or damage incurred in shipping.
6. **WARRANTY DISCLAIMER AND LIMITATION OF LIABILITY:** Except only the limited express warranty set forth above, the products are sold with no expressed or implied warranties of any kind, and the implied warranties of merchantability and fitness for a particular purpose are hereby expressly disclaimed. No warranties are given with respect to products purchased other than from Lathem or an authorized Lathem reseller and any such products are purchased "as is, with all faults." In no event will Lathem be liable for any direct, indirect, special, incidental or consequential damages arising out of or in connection with the delivery, use or inability to use, or performance of this product. In the event any limited remedy given herein shall be deemed to have failed of its essential purpose, Lathem's maximum liability shall be to refund the purchase price upon return of the product.
7. Proof of date of purchase from Lathem or an authorized Lathem reseller is required for warranty service on this product.
8. This Warranty grants specific legal rights. Additional legal rights, which may vary by locale, may also apply.
9. Should any difficulties arise with the performance of this product during warranty, or with any Lathem authorized service centers, contact Lathem Time at the address below.

Lathem Time  
200 Selig Drive, SW, Atlanta, GA 30336  
**404-691-0405**

[www.lathem.com](http://www.lathem.com)

Copyright © 2009 Lathem Time Corporation. All rights reserved.

- A
- Accessories, 6
- C
- Caution, 6
- Changing the dates for Daylight Savings, 34
- Changing the Print Intensity, 29
- Confirmation Beep
  - Disable/Enable, 24
- D
- Daylight Savings Settings, 18
- Disable Daylight Savings Correction, 35
- F
- Factory Settings, 13
- Features, 5
- Frequently Asked Questions, 36
- I
- Installation Tools, 7
- Introduction, 5
- M
- Minute Conversion Chart, 38
- Mounting to a Wall, 26
- P
- Packing Contents, 7
- Print Head Test, 25
- Print Intensity, 23
- Program the Time Recorder, 11
- programming buttons, 11
- Q
- Quick Easy Setup, 8, 9
- R
- Recalibrating the TruAlign Function., 30
- S
- Set 12/24 Hr Display, 19
- Set 12/24 Hr Print, 20
- Set Date, 16
- Set Day Print Language, 22
- Set Month, 15
- Set Print Minute Format, 21
- Set up Functions, 14
- Set Year, 17
- Setup, 10
- Setup Mode for Date and other Functions, 13
- SPECIFICATIONS, 37
- T
- Testing the Print Head, 33
- Time Set Up Mode, 12
- TruAlign Calibration, 25
- U
- Using the Time Recorder, 28
- W
- WARRANTY, 39
- When to recalibrate TruAlign function, 30
- When to test the print head, 33