

Version: V1.00.000
Revised Time: 12-06-2022

Safety Precautions

The design, manufacturing and detection of this instrument meet the IEC61010 safety standard (safety requirements for electronic measuring products). This manual includes warnings and safety regulations that must be observed by users to ensure the safe use of the instrument and the safe state of the instrument. Please read the following operating instructions carefully before use.

Warning

- Please carefully read and understand this instruction before using the instrument.
- The requirements of this manual must be observed at any time, and the manual shall be kept for reference at any time.
- During instrument test, wrong operations will lead to accidents and instrument damage.

Conventions

The following conventions are used in this manual.

Danger

In order to avoid serious or fatal damage that may be caused under certain conditions and operations.

- Do not measure circuits with AC/DC voltage above 600V.
- Do not test in flammable places because sparks may cause explosion.
- Do not operate the instrument if the surface of the instrument is wet or the operator's hand is wet.
- Do not touch the conductive part of the test pen during measurement.
- When the test line is short circuited to the instrument, do not press the [TEST] button.
- When performing insulation measurement, do not touch the line to be tested.

Warning

It means avoiding the risk of electric shock.

- If the instrument is damaged or exposed, please stop using it.
- After the high resistance measurement, the charge storage in the circuit to be tested must be released.
- Ensure that all test wires are firmly connected to the test ports of the instrument.
- The instrument is a sealed device, and there are no parts that can be repaired by the end user. Do not attempt to disassemble it by yourself. All internal maintenance must be carried out by authorized maintenance organizations or technicians. Attempting to disassemble or modify the device will void the warranty.

Precautions

Helpful information for avoiding damage to the instrument and for accurate measurement

- Before measuring the resistance, the circuit to be tested must be completely discharged and completely isolated from the power supply circuit.
- If the test line or power adaptor is damaged and needs to be replaced, the test line or power adaptor of the same model or electrical specification must be replaced.
- Do not use the instrument if the battery indicator shows that the battery is exhausted.
- Do not store or use this instrument in high temperature, high humidity, flammable, explosive or strong electromagnetic field environment.
- Please use a wet cloth or cleaner to clean the instrument housing. Do not use friction or solvent.
- When the instrument is wet, please dry it before storing it.

FCC Statement

Any Changes or modifications not expressly approved by the party responsible for compliance could void the user's authority to operate the equipment.

This device (FCC ID: XUJES200) complies with part 15 of the FCC Rules. Operation is subject to the following two conditions: (1) This device may not cause harmful interference, and (2) this device must accept any interference received, including interference that may cause undesired operation.

FCC Radiation Exposure Statement:

This equipment complies with FCC radiation exposure limits set forth for an uncontrolled environment .This equipment should be installed and operated with minimum distance 20cm between the radiator& your body.

NOTE: This equipment has been tested and found to comply with the limits for a Class B digital device, pursuant to part 15 of the FCC Rules. These limits are designed to provide reasonable protection against harmful interference in a residential installation. This equipment generates, uses and can radiate radio frequency energy and, if not installed and used in accordance with the instructions, may cause harmful interference to radio communications. However, there is no guarantee that interference will not occur in a particular installation. If this equipment does cause harmful interference to radio or television reception, which can be determined by turning the equipment off and on, the user is encouraged to try to correct the interference by one or more of the following measures:

- Reorient or relocate the receiving antenna.
- Increase the separation between the equipment and receiver.
- Connect the equipment into an outlet on a circuit different from that to which the receiver is connected.
- Consult the dealer or an experienced radio/TV technician for help.

Table of Contents

1. Product Introduction	1
1.1 Brief Introduction	1
1.2 Accessory Included	1
1.3 Components & Controls	2
1.4 Technical Specifications.....	6
2. Operation Instructions	9
2.1 Charging & Power On/Off	9
2.2 LCD Display.....	10
2.3 Measurement.....	11
2.3.1 AC/DC Voltage Measurement	11
2.3.2 Insulation Resistance (IR) Measurement	13
2.3.3 On-board Resistance Single Point Calibration	16
3. Update	18
3.1 Download Update Tool	18
3.2 Update via Bluetooth	18
3.3 Update via USB	20
4. Maintenance	24
5. Warranty	25

1. Product Introduction

1.1 Brief Introduction

The ES 200 insulation resistance tester is designed with microcomputer technology as the core, combined with large-scale integrated circuit and digital circuit, and equipped with powerful measurement and data processing software. It can complete the measurement of insulation resistance, voltage and other parameters, with stable performance and simple operation. It is suitable for users who measure and overhaul on-site power equipment and power supply lines.

It has the following characteristics:

- Automatic voltage release function
- USB interface data transmission
- Backlight function making it easy to work in dark light
- Bar graph showing the measurement results
- High voltage prompt
- Test time setting function
- Support resistance and voltage measurement
- COMP measurement (comparison function measurement)

1.2 Accessory Included

The following packing list is for reference only. In the event you find any missing or damage, please contact the seller immediately.





- ES 200 insulation tester x 1
- Instruction manual x 1
- Black test line (One plug test lead to one alligator clip) x 1
- Green test line (One plug test lead to one alligator clip) x 1
- Red test line (Two plugs test lead to one alligator clip) x 1

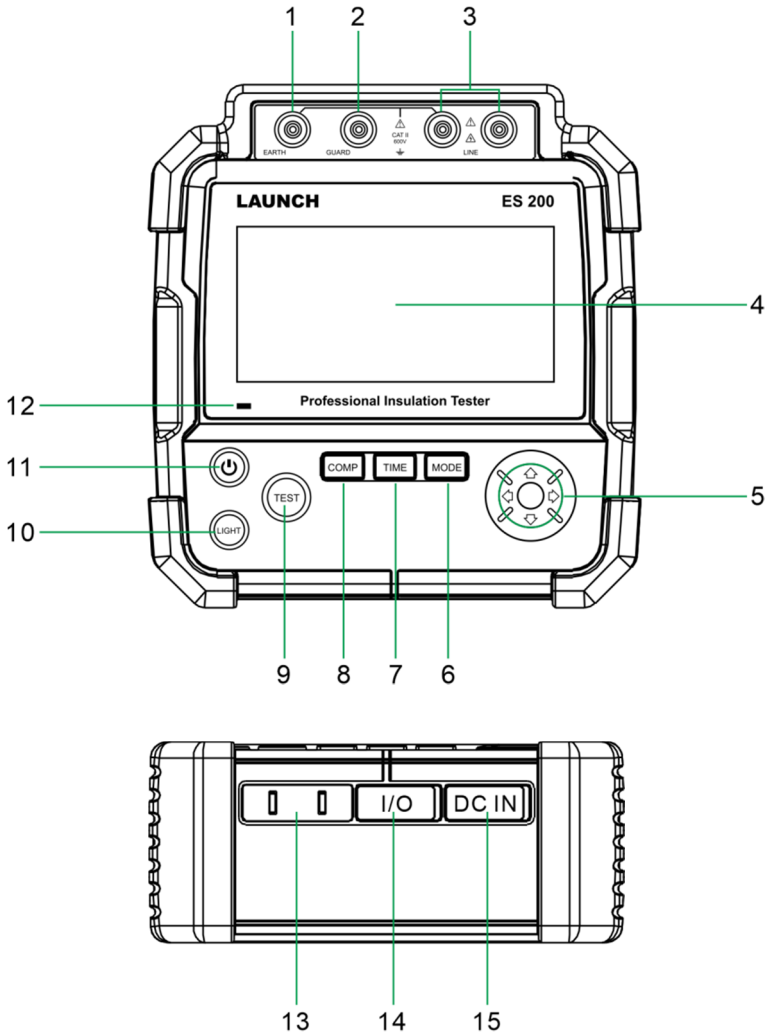

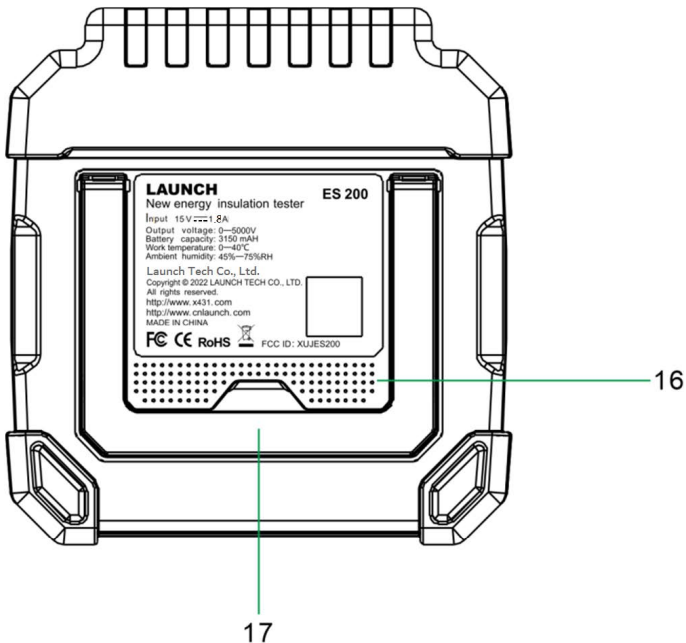

- Power adaptor x 1

1.3 Components & Controls







No.	Name	Remarks
1	Earth: High resistance measurement input terminal	One plug green test lead to one alligator clip
2	GUARD: Grounding protection input terminal	One plug black test lead to one alligator clip
3	LINE & high voltage line shielding input terminal	Two plugs red test lead to one alligator clip
4	LCD	For specific onscreen indicators, please refer to chapter 2.2 "LCD Display".
5	Selection buttons   : test high voltage	  : Used to select the measurement output voltage value when the

	<p>output value selection button</p> <p>: comparison/timing value selection button</p>	<p>insulation resistance measurement is disabled.</p> <p>: When the insulation resistance measurement has no test voltage output,  is the test voltage down selection button.</p> <p>: When the insulation resistance measurement mode is timed measurement, it is used to decrementally set the time; when the insulation resistance measurement mode is comparison measurement, it is used to decrementally set the resistance comparison value.</p> <p>: When the insulation resistance measurement mode is timed measurement, it is used to incrementally set the time; when the insulation resistance measurement mode is comparison measurement, it is used to incrementally set the resistance comparison value.</p>
<p>6</p>	<p>MODE button</p>	<p>Resistance/voltage measurement mode button</p> <p>The default mode is insulation resistance measurement mode (continuous measurement state) when starting up. Press this button to switch to DC voltage measurement mode. Press it</p>

		again to enter the AC voltage mode, press again to exit the voltage measurement mode and return to the insulation resistance measurement mode.
7	TIME (Timer) button	Each time the timer button is pressed, the insulation resistance measurement mode is set cyclically.
8	COMP (Compare) button	Insulation resistance measurement mode - Compare measurement
9	TEST button	Used to turn on and off the insulation resistance test (Attention: In this case, the test leads have high voltage output).
10	LIGHT (backlight) button	Backlight on and off button
11	Power button	<ul style="list-style-type: none"> • In the Off state, press and hold this button until the background LED of the TEST button becomes lit, and the instrument initializes and starts up. • In the On state, press this button for 3 seconds to shut it down. • The instrument will automatically shut down after no operations for more than 15 minutes (When in Voltage Measurement mode, user needs to manually shut it down).
12	Charging indicator	RED – Charging; GREEN – Fully charged.

13	Resistance test terminal	Used to perform the instrument validation test and standard resistance calibration.
14	USB port	Used for firmware update and data transmission.
15	DC IN power jack	<p> Warning: Please use the included power adaptor for charging. No responsibilities can be assumed for any damage and loss caused as result of using power adaptors other than the one supplied.</p> <p> Note: In order to ensure personal safety during charging, the instrument will not work.</p>
16	Heat dissipation outlet	<p>For internal heat exchange.</p> <p> Warning: Prevent it from being blocked or water entering.</p>
17	Rear stand	Flip it out to any angle and work comfortable at your desk when operating the instrument.

1.4 Technical Specifications

- **Insulation resistance test**

Test Voltage	500V	1000V	2500V	5000V
Meas-	0.0MΩ~20GΩ	0.0MΩ~40GΩ	0.0MΩ~100GΩ	0.0MΩ~1000G

Measurement range				Ω
Open circuit voltage	DC500V 0~20%	DC1000V 0~20%	DC2500V 0~20%	DC5000V 0~20%
Measurement accuracy	0.0MΩ~99.9MΩ: ±(3%+5)	0.0MΩ~99.9MΩ: ±(3%+5)	0.0MΩ~99.9MΩ: ±(3%+5)	0.0MΩ~99.9MΩ: ±(3%+5)
	100MΩ~9.99GΩ: ±(5%+5)	100MΩ~9.99GΩ: ±(5%+5)	100MΩ~9.99GΩ: ±(5%+5)	100MΩ~9.99GΩ: ±(5%+5)
	10.0GΩ~20.0GΩ: ±(10%+5)	10.0GΩ~40.0GΩ: ±(10%+5)	10.0GΩ~100.0GΩ: ±(10%+5)	10.0GΩ~99.9GΩ: ±(10%+5)
				>100GΩ: ±(20%+5)
Short-circuit current	<3.0mA			

• **AC/DC voltage test**

Voltage Type	DC voltage	AC voltage
Measurement range	±30~±600V	30~600V(/60Hz)
Resolution	1V	1V
Measurement accuracy	±3%	±3%

 **Note:** Under any test voltage, if the measured resistance is lower than 10MΩ, it shall not be measured continuously for more than 10 seconds.

- Display screen: liquid crystal display, the maximum reading is 9999

- Out-of-limit indicator: "OL" mark appears in the case of over-range or when insulation resistance measurement is stopped.
- Unit display: with display of function and power unit symbol
- Working temperature: 0°C ~ 40°C
- Storage temperature: - 20°C ~ 70°C

2. Operation Instructions

2.1 Charging & Power On/Off

 Note: If the instrument is used for the first time or has not been used for a long time, the instrument may not power on, which may be caused by low battery power. Charge the instrument for a period of time and then turn to on.

In the shutdown state, press and hold the [Power] button on the instrument until the [TEST] button lights up. The instrument enters initialization and starts up, and the system will have a buzzer prompt.

If the battery power is insufficient, please charge it: Insert one end of the power adaptor into the DC IN power jack of the instrument and connect the other end to the AC outlet. If the charging LED on the instrument illuminates red, it indicates that charging is in progress. When the charging LED turns green, it indicates that the charging has been completed. Disconnect the instrument from the power adaptor.

To shut down, press and hold the [Power] button on the instrument for 3 seconds until the screen goes out.

When the instrument is not operated for more than 15 minutes, it will automatically shut down. If in the voltage measurement mode, user needs to shut it down manually to conserve the instrument power.

 Note: In order to ensure personal safety during charging, the instrument will automatically shut down.

2.2 LCD Display

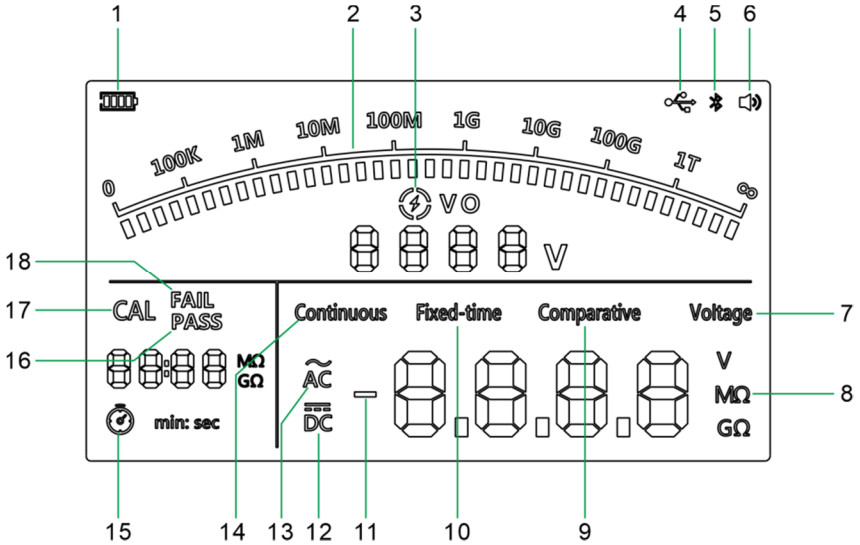

No.	Name	No.	Name
1	Battery life indicator	10	Time measurement indicator
2	Analog bar graph	11	- (Negative) symbol
3	Risk of electric shock	12	Indicator for DC voltage
4	USB connection symbol	13	Indicator for AC voltage
5	Bluetooth prompt	14	Continuous measurement indicator
6	Buzzer symbol	15	(Timer) symbol
7	Voltage measurement indicator	16	PASS (Compare feature passed) character

8	Unit symbols	17	CAL (Calibration) character
9	Compare measurement indicator	18	FAIL (Compare feature failed) character

2.3 Measurement

Please prepare the following before measurement:

1. Press **POWER** button to start up. The preset test voltage is 500V and the insulation resistance is in the continuous measurement gear.
2. Ensure that the instrument is fully charged (if the battery mark is blank, it means that the battery volume is extremely exhausted, please recharge it immediately).

2.3.1 AC/DC Voltage Measurement

- (1) AC/DC voltage measurement needs to be toggled with the **MODE** button on the instrument. During startup, the insulation resistance measurement is in continuous measurement mode by default. Press **MODE** button once to switch to DC voltage measurement mode, and press it again to enter AC voltage measurement mode.

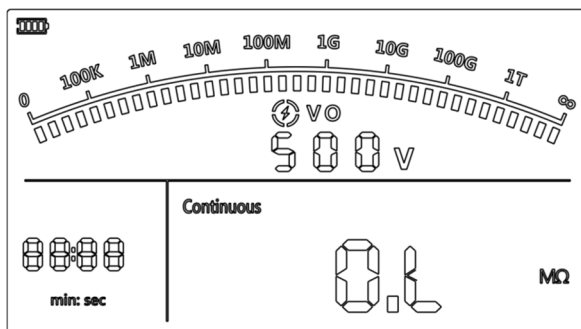

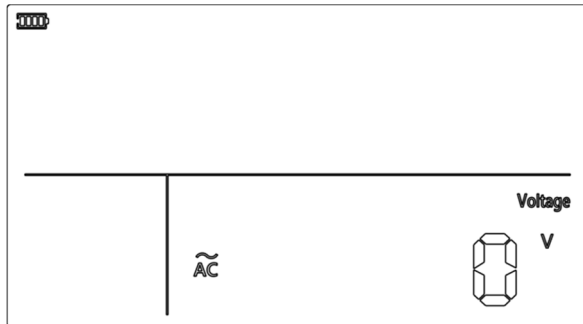

- (2) Insert the red two plugs test lead into the **LINE** & high-voltage line shielding input terminals on the instrument, and the green test lead into the Earth input terminal on the instrument.
- (3) Connect the red and green alligator clips to the tested circuit. When measuring DC voltage, if the red test line is negative voltage, "-" symbol will display on the screen.

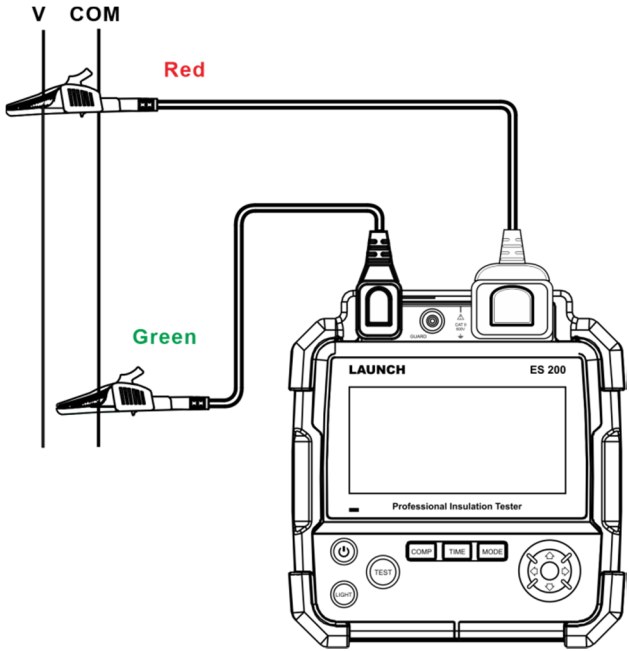

Notes:

- To avoid causing potential harm to you or damage to the instrument, do not attempt to measure voltage higher than 600V or 600Vrms.
- When measuring high voltage, special care should be taken to avoid electric shock.
- After completing all measurements, disconnect the test line from the circuit under test and remove the test leads from the input terminal of the instrument.
- If the measured value of the voltage exceeds the maximum range, the buzzer will sound.





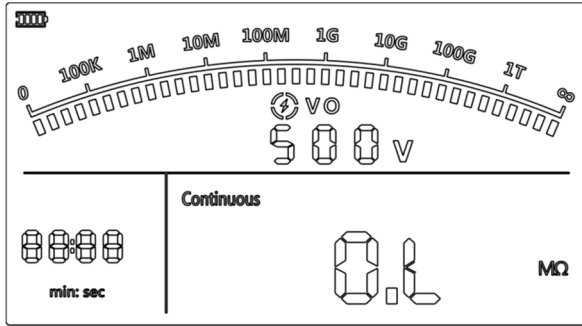

2.3.2 Insulation Resistance (IR) Measurement

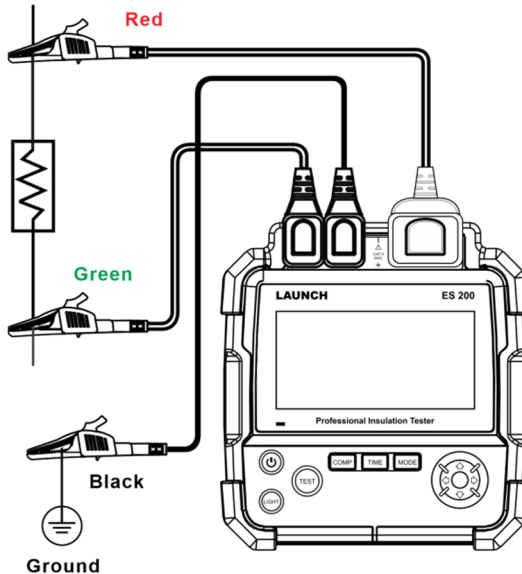
Note: The default measurement mode of insulation resistance is continuous measurement mode when starting up.



- (1) Before measuring the insulation resistance, remove all power from the circuit to be tested and discharge all the power.
- (2) Insert the red test lead into the **LINE** & high voltage line shielding input terminals, the black test lead into the **GUARD** input terminal, and the green test lead into the **EARTH** input terminal respectively.
- (3) Connect the red and green alligator clips to the tested circuit, and the high voltage terminal is output from the **LINE** input terminal.



- (4) Select the following insulation resistance measurement mode:
- After power-on, the system will enter the continuous measurement state of insulation resistance by default. Press the  button to select the output voltage value, press **TEST** button for 1s to start measurement, and the buzzer will sound for a long time. The measured insulation resistance value will be displayed on the LCD.
 - Press **TIME** button to select the timed measurement mode, and the LCD will display the Fixed-time and . Press  button to select the output voltage value, and press  button to set the timing duration (00:10-00:55, in steps of 5 seconds within 1 minute; 01:00-15:00, in steps of 30 seconds over 1 minute). Press **TEST** button for 1 second to start the timed measurement. The timing area starts to display the countdown. When the set time is reached, the system will automatically end the measurement and close the insulation resistance test voltage. The LCD will display the insulation resistance reading.
 - Press **COMP** to enter the compare measurement mode of insulation resistance, and the **COMPARE** character on the screen will light up. Press  button to select the output voltage value. Press  button to set the compare values (in sequence of 10MΩ, 20MΩ, 30MΩ, 40MΩ, 50MΩ, 60MΩ, 70MΩ, 80MΩ, 90MΩ, 100MΩ, 200MΩ, 300MΩ, 400MΩ, 500MΩ, 600MΩ, 700MΩ, 800MΩ, 900MΩ, 1GΩ, 2GΩ, 3GΩ, 4GΩ, 5GΩ, 6GΩ, 7GΩ, 8GΩ, 9GΩ, 10GΩ, 20GΩ, 30GΩ, 40GΩ, 50GΩ, 60GΩ, 70GΩ, 80GΩ, 90GΩ, 100GΩ, 200GΩ, 300GΩ, 400GΩ, 500GΩ, 600GΩ, 700GΩ, 800GΩ, 900GΩ). Press **TEST** button for 1 second to start measurement. If the insulation measurement value is smaller than the resistance comparison value, the **FAIL** indicator will display on the lower left corner of the screen. Otherwise the **PASS** indicator will be displayed.



- When performing insulation resistance tests, remove all power from the circuit to be measured and discharge all the power.
- During measurement, the instrument outputs dangerous voltage output, so be careful to operate. Ensure that the tested object is clamped firmly and hands are away from the test clips, and then press the [TEST] button to output high voltage.
- Do not short circuit the test leads during high voltages output or test insulation resistance after high voltages output. Otherwise, it is easy to generate sparking and cause fire, which will damage the instrument itself and harm to you.
- Do not measure over 10 seconds when: 500V measurement resistance lower than 2M Ω , 1000V measurement resistance lower than 5M Ω , 2500V measurement resistance lower than 10M Ω , and 5000V measurement resistance lower than 20M Ω .
- If the measured value of the resistance exceeds the maximum range, the buzzer will sound.

How to switch the measurement mode?

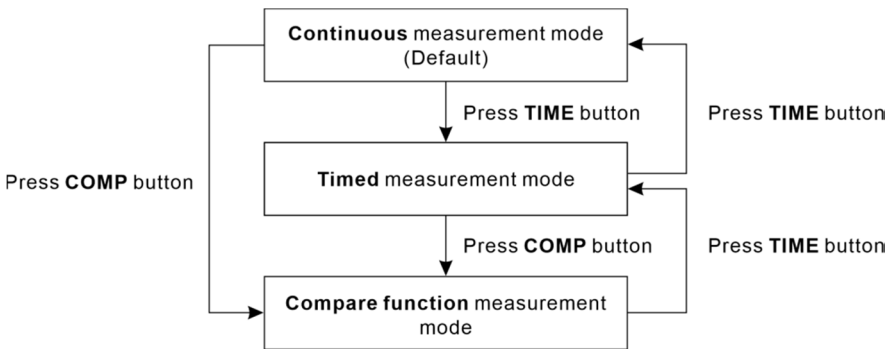

2.3.3 On-board Resistance Single Point Calibration

After the instrument has been used for a period of time, it is recommended that the user conduct an on-board resistance calibration operation. Refer to the following steps:

1. Connect the test lines to the resistance test terminal on the instrument as shown below.

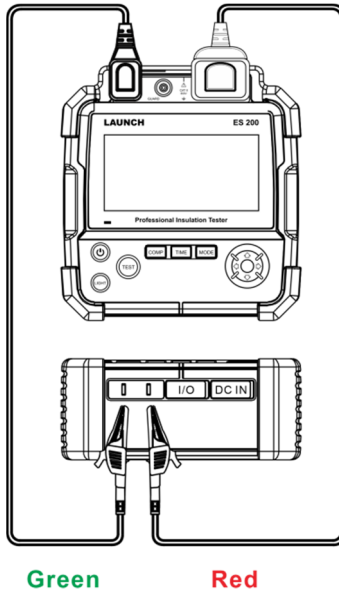

2. In the startup state, press and hold **COMP** button to enter the 200M Ω resistance calibration state, and the screen will display the **CAL** character and the 200M Ω resistance value.
3. Press and hold **TEST** button to start the measurement, and then press the **TEST** button to end the measurement after the value stabilizes.
4. Press and hold **COMP** button for 5 seconds to exit the calibration, and the calibration is completed.

3. Update

The update tool of the insulation tester can be downloaded from the LAUNCH official website (www.x431.com). After downloading and installing it on the diagnostic tool, user can choose either of the following ways (Bluetooth and USB) to upgrade the firmware of the insulation tester. It is recommended to check for updates of the instrument on regular basis.

3.1 Download Update Tool

1. Open the browser and visit www.x431.com, go to Service & Support to download the update tool.
2. After the update tool is successfully downloaded and installed, an icon will be displayed on the Android's home screen.

3.2 Update via Bluetooth

 Note: This method is strongly recommended since it is simple and convenient.

1. Launch the update tool on the diagnostic tool, the following screen will appear.

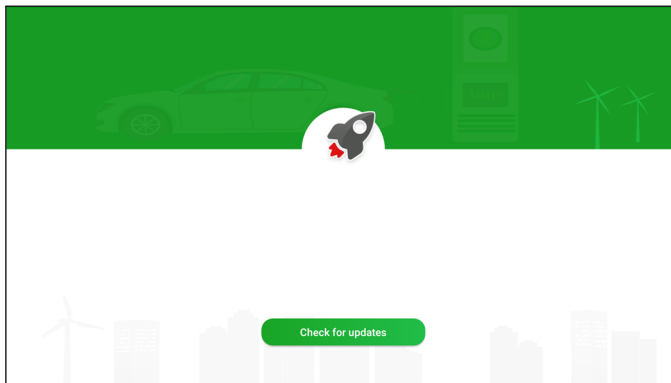

2. Press and hold the [Power] button on the instrument until the [TEST] button lights up. The instrument enters initialization and starts up.
3. Tap **Check for updates**, the following screen will appear.

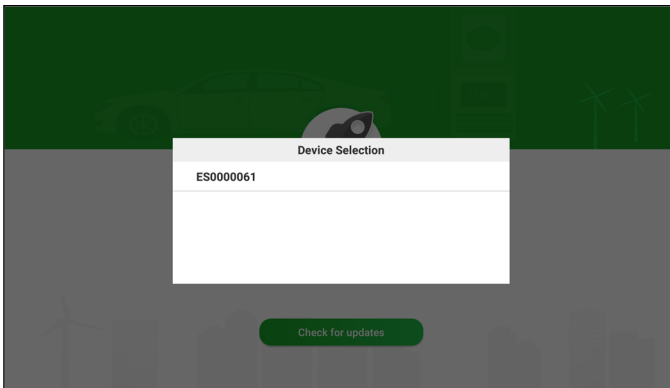

4. Tap the desired Bluetooth ID of the instrument to pair and connect.
5. If a newer hardware update tool is detected, the following popup will appear on the screen.

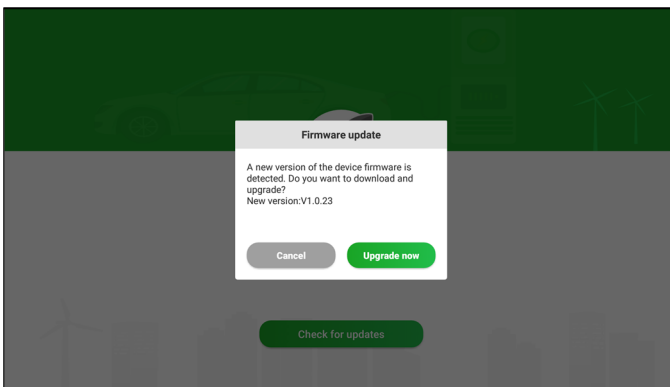

6. Tap **Update now**, the following prompt message will appear.

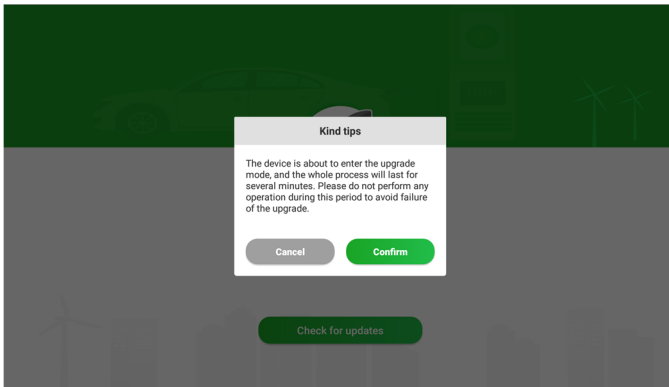

 Note: It may take several minutes to complete the update process. During updating, DO NOT operate the instrument. Failure to do so may cause update failure.

7. Tap **Confirm** to start updating until the following screen appear.

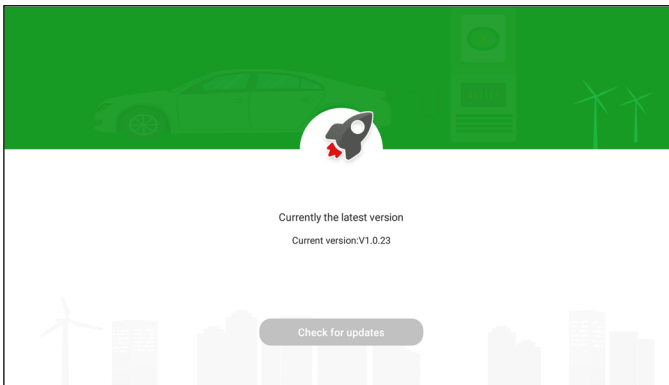

8. Exit the update tool app.

3.3 Update via USB

A Type A to Type C USB cable (optional) is required for this operation. Follow the steps below to proceed.

1. Launch the update tool on the diagnostic tool, the following screen will appear.

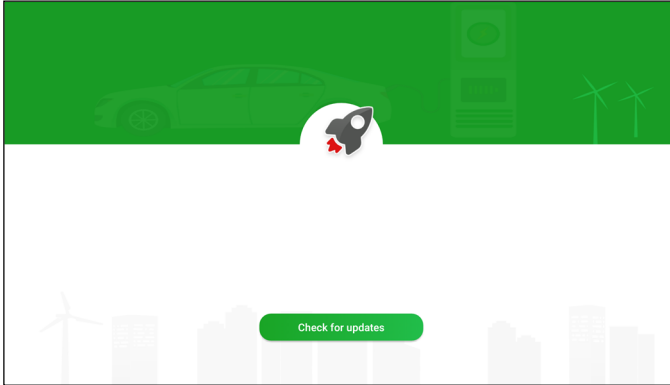

2. Press and hold the [Power] button on the instrument until the [TEST] button lights up. The instrument enters initialization and starts up.
3. Plug one end of the USB cable into the diagnostic tool, and the other end to the USB port of the insulation tester.
4. Tap **Check for Updates**. If a newer hardware update tool is detected, the following popup will appear on the screen.

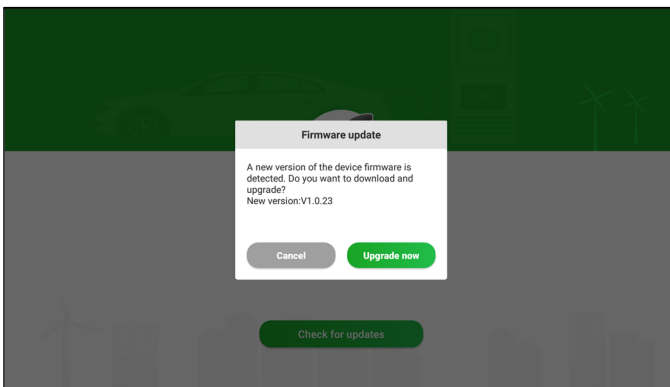

5. Tap **Update immediately**, the following prompt message will appear.

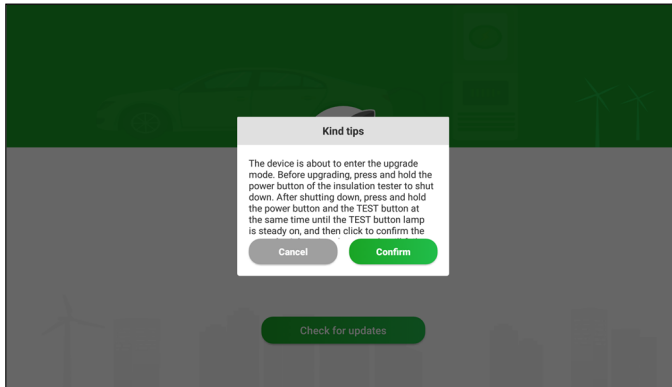

6. Before update, press and hold the [Power] button on the instrument to shut it down. When in OFF mode, press and hold the [Power] and [TEST] button simultaneously until the [TEST] button lights up. The instrument enters initialization and starts up.
7. Tap **Confirm** to start updating, a progress bar will appear on the screen.

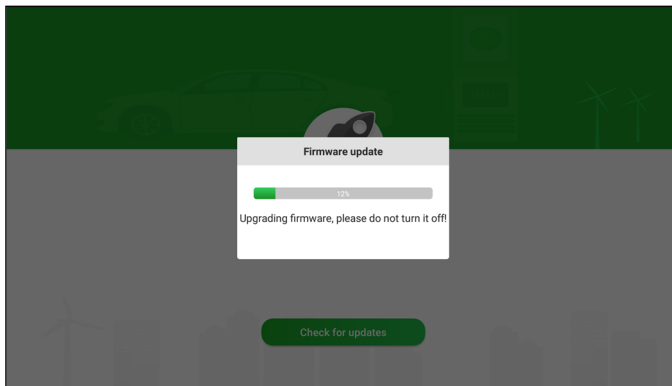

 Note: It may take several minutes to complete the update process. During updating, DO NOT operate the instrument. Failure to do so may cause update failure.

8. After the update is completed, the following screen will appear.

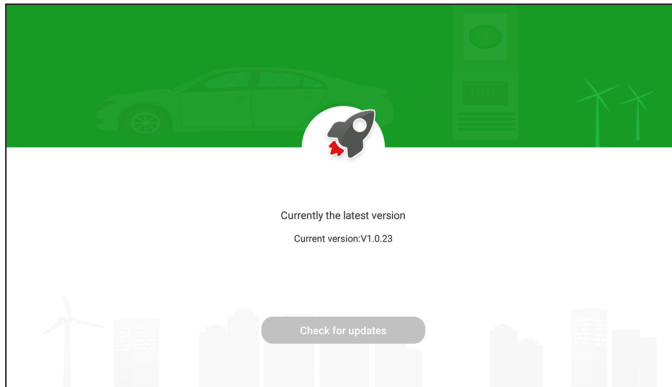

9. Exit the update tool app.

4. Maintenance

- Periodically wipe the case of the instrument with a soft damp cloth or sponge. Do not use abrasives and solvents.
- To avoid damaging the test instrument, do not immerse the instrument in water.
- If the instrument is wet, please dry it before use or storage.
- When it is necessary to calibrate or repair the instrument, hand it over to the qualified professional maintenance personnel or designated maintenance department for repair.

5. Warranty

This warranty is expressly limited to persons who purchase LAUNCH[®] products for purposes of resale or use in the ordinary course of the buyer's business.

LAUNCH[®] electronic product is warranted against defects in materials and workmanship for one year (12 months) from date of delivery to the user.

This warranty does not cover any part that has been abused, altered, used for a purpose other than for which it was intended, or used in a manner inconsistent with instructions regarding use. The exclusive remedy for any automotive meter found to be defective is repair or replacement, and LAUNCH shall not be liable for any consequential or incidental damages.

Final determination of defects shall be made by LAUNCH in accordance with stipulated procedures.

Order Information

Replaceable and optional parts can be ordered directly from your authorized tool supplier. Your order should include the following information:

- Quantity
- Part number
- Item description

Customer Service (LAUNCH HQ)

If you have any questions on the operation of the unit, please contact local dealer, or customer service center:

Tel: 86-755-84557891

E-mail: X431@cnlaunch.com