



Safety Information



CAUTION
ELECTRIC SHOCK DO NOT OPEN



**CAUTION: TO REDUCE THE RISK OF ELECTRIC SHOCK, DO NOT REMOVE COVER (OR BACK).
NO USER SERVICEABLE PARTS INSIDE.REFER SERVICING TO QUALIFIED SERVICE
PERSONNEL.**

CAUTION - RISK OF ELECTRIC SHOCK-DO NOT OPEN

AVIS: RISQUE DE CHOC ÉLECTRIQUE - NE PAS OUVRIR



The lightning flash with arrowhead symbol, within an equilateral triangle is intended to alert the user to the presence of uninsulated dangerous voltage within the product's enclosure that may be of sufficient magnitude to constitute a risk of electric shock.



The exclamation point within an equilateral triangle is intended to alert the user to the presence of important operating and maintenance (servicing) instructions in the literature accompanying the appliance.

**WARNING: TO PREVENT FIRE OR SHOCK HAZARD, DO NOT EXPOSE THIS APPLIANCE TO
RAIN OR MOSTURE.**

**CAUTION: TO PREVENT ELECTRIC SHOCK DO NOT USE THIS POLARIZED PLUG WITH AN
EXTENSION CORD, RECEPTACLE OR OTHER OUTLET UNLESS THE BLADES CAN
BE FULLY INSERTED TO PREVENT BLADE EXPOSURE.**

CAUTION: These servicing instructions are for use by qualified service personnel only. To reduce the risk of electric shock, do not perform any servicing other than that contained in the operating instructions unless you are qualified to do so.

Important Safety Instructions

1. Read these instructions.
2. Keep these instructions.
3. Heed all warnings
4. Follow all instructions.
5. Do not use this apparatus near water.
6. Clean only with dry cloth.
7. Do not block any ventilation openings. Install in accordance with the manufacturer's instructions.

8. Do not install near any heat sources such as radiators, heat registers, stoves, or other apparatus (including amplifiers) that produce heat.
9. Do not defeat the safety purpose of the polarized or grounding-type plug. A polarized plug has two blades with one wider than the other. A grounding type plug has two blades and a third grounding prong. The wide blade or the third prong are provided for your safety. If the provided plug does not fit into your outlet, consult an electrician for replacement of the obsolete outlet.
10. Protect the power cord from being walked on or pinched particularly at plugs, convenience receptacles, and the point where they exit from the apparatus.
11. Only use attachments/accessories specified by the manufacturer.
12. Use only with the cart, stand, tripod, bracket, or table specified by the manufacturer, or sold with the apparatus. When a cart is used, use caution when moving the cart / Apparatus combination to avoid injury from tip-over. 
13. Unplug this apparatus during lightning storms or when unused for long periods of time.
14. Refer all servicing to qualified service personnel. Servicing is required when the apparatus has been damaged in any way, such as power-supply cord or plug is damaged, liquid has been spilled or objects have fallen into the apparatus, the apparatus has been exposed to rain or moisture, does not operate normally, or has been dropped.
15. The apparatus shall not be exposed to dripping or splashing and that no objects filled with liquids, such as vases, shall be placed on the apparatus.
16. The MAINS plug or appliance coupler is used as the disconnect device, the disconnect device shall remain readily operable.
17. The battery shall not be exposed to excessive heat such as sunshine, fire or the like.
18. Excessive sound pressure from earphones and headphones can cause hearing loss.
19. Caution Marking and rating plate are located at rear enclosure of the apparatus.
20. The mains plug of apparatus should not be obstructed and should be easily accessed during intended use. To be completely disconnected from the power input, the apparatus shall be disconnected from the mains.

ATTENTION-Pour réduire le risque d'incendie ou de choc électrique, ne pas exposer cet appareil à la pluie ou à l'humidité.

Les piles (pack de piles ou piles installées) ne doivent pas être exposées à une chaleur excessive comme le soleil, le feu ou similaire.

Les prise d'alimentation ou une entrée d'appareil est utilisé comme dispositif de déconnexion, le restent facilement utilisable lors de l'utilisation normale de l'appareil. marquage Attention et la plaque signalétique sont situés au boîtier arrière de l'appareil.

L'appareil ne doit pas être exposé à des gouttes et éclaboussures et aucun objet rempli de liquide, comme des vases, doivent être placés sur l'appareil.

Certification Information



FCC NOTE:

This device complies with Part 15 of the FCC Rules.

Operation is subject to the following two conditions: (1) this device may not cause harmful interference, and (2) this device must accept any interference received, including interference that may cause undesired operation.

THE MANUFACTURER IS NOT RESPONSIBLE FOR ANY RADIO OR TV INTERFERENCE CAUSED BY UNAUTHORIZED MODIFICATIONS OR CHANGE TO THIS EQUIPMENT. SUCH MODIFICATIONS OR CHANGE COULD VOID THE USER'S AUTHORITY TO OPERATE THE EQUIPMENT.

This equipment has been tested and found to comply with the limits for a Class B digital device, pursuant to part 15 of the FCC Rules. These limits are designed to provide reasonable protection against harmful interference in a residential installation. This equipment generates, uses and can radiate radio frequency energy and, if not installed and used in accordance with the instructions, may cause harmful interference to radio communications. However, there is no guarantee that interference will not occur in a particular installation. If this equipment does cause harmful interference to radio or television reception, which can be determined by turning the equipment off and on, the user is encouraged to try to correct the interference by one or more of the following measures:

- Reorient or relocate the receiving antenna.
- Increase the separation between the equipment and receiver.
- Connect the equipment into an outlet on a circuit different from that to which the receiver is connected.
- Consult the dealer or an experienced radio/TV technician for help.

To maintain compliance with FCC's RF exposure guidelines, this equipment should be installed and operated with a minimum distance of 20cm between the radiator and your body.

For 5150-5250MHz and 5725-5825MHz frequency bands, add below statement for indoor use warning statement on manual,

Operations in the 5150-5250MHz and 5725-5825MHz bands are restricted to indoor usage only.



Dolby and the double-D symbol are registered trademarks of Dolby Laboratories. All other trademarks remain the property of their respective owners.



For DTS patents, see <http://patents.dts.com>. Manufactured under license from DTS Licensing Limited. DTS, the Symbol, & DTS and the Symbol together are registered trademarks, and DTS Premium Sound is a trademark of DTS, Inc. © DTS, Inc. All Rights Reserved.



Mobile High-Definition Link

MHL and the MHL logo are trademarks or registered trademarks or service mark of MHL, LLC in the United States and/or other countries.



The terms HDMI and HDMI High-Definition Multimedia Interface, and the HDMI Logo are trademarks or registered trademarks of HDMI Licensing, LLC in the United States and other countries.

/ Packing Layout

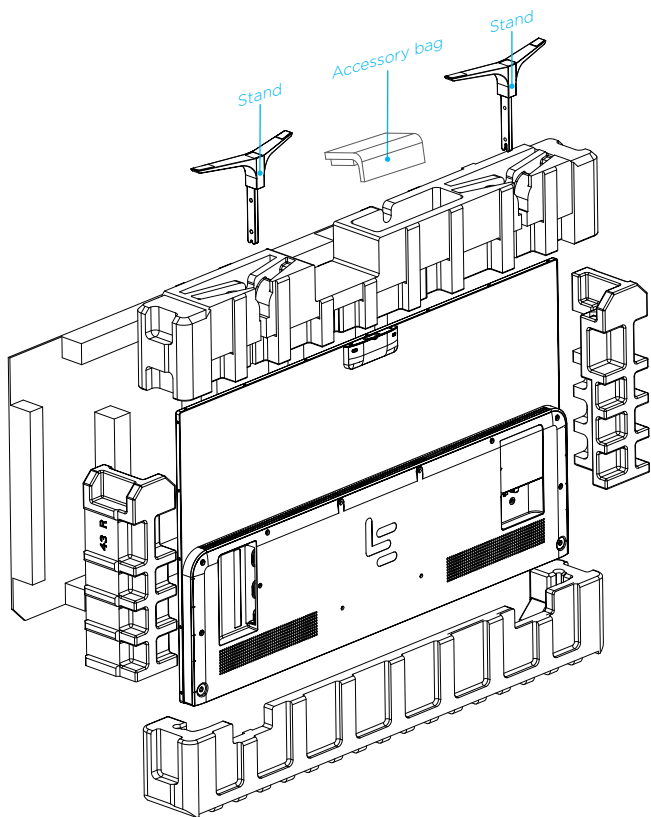

Note: Picture is for reference only.

Accessory List

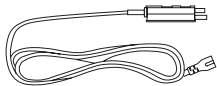

Power cord

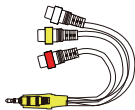

3-in-1 component cable



Product Quick Guide

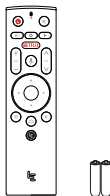

Super Remote AAA Battery x 2

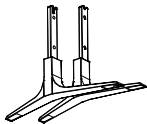

Stand



Screw x 2

Note: Picture is for reference only, please prevail in kind.

Specifications

Product model	L434FCNN
Power supply (voltage, Hz)	120V, 60Hz
Power consumption	73 W
Standby power consumption	0.5 W
Intrinsic resolution	1920x1080
Dimensions (with stand)	960.5x616.3x239.3 mm
Dimensions (without stand)	960.5x560.3x33.7 mm
Weight (with stand)	10.5 kg
Weight (without stand)	9.9 kg
Color system	PAL / NTSC / SECAM
Sound system	DK / I / M / BG
Digital system	DTMB
RF in	75 ohms unbalanced
Supported HDMI resolution	480i 480P 576i 576P 720P - 50Hz 720P - 60Hz 1080i - 50Hz 1080i - 60Hz 1080P - 50Hz 1080P - 60Hz 1080P - 24Hz 1080P - 30Hz
Sound output power	9 W x 2
Environment	Ambient temperature: 0°C - +45°C Ambient humidity: 20% - 80% Storage temperature: - 15°C - +45°C Storage humidity: ≤ 80% Note: If storage temperature is below 0°C, ensure to restore the TV to working temperature at least 2 hours before turning on.

Installation Guide

Installation notes:

- Do not cover ventilation hole or put any object into enclosure, such as newspaper, soft cloth, curtain, etc.
- Reserve adequate ventilation space around Super TV.
- Do not put Super TV in places where there is vibration.
- Do not put Super TV close to air conditioner. Otherwise, moisture condensation may appear on interior panel of display and damage the panel.
- Do not put Super TV in the area with strong electromagnetic field. Otherwise, the TV may be interfered or damaged.

Stand Installation:

Make sure there is enough surrounding space for the Super TV as indicated below.

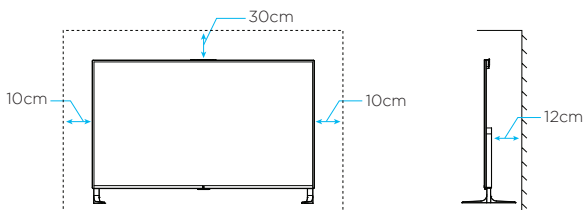

Note: Picture is for reference only.

Wall Mounting

Please reserve enough space as suggested below for proper installation.

Install the wall mount requires at least 4 pieces screws.

Wall mount: It is advised to use suitable wall frame and screws in order to enjoy the premium sound effect.

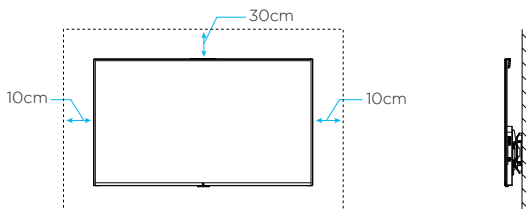

Mounting Hole Pattern: 200 x 200mm

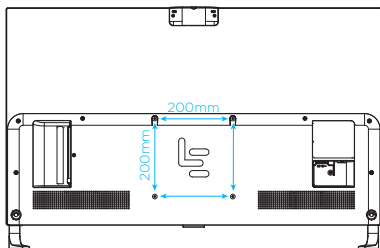

Note:

Contact a professional for assistance when wall mounting your TV. We are not responsible for any damage to the product or injury to yourself, if you mount the TV on your own.

Do not power on the TV when performing wall mount installation. It may cause personal injury due to electric shock.

CONNECTING YOUR TV

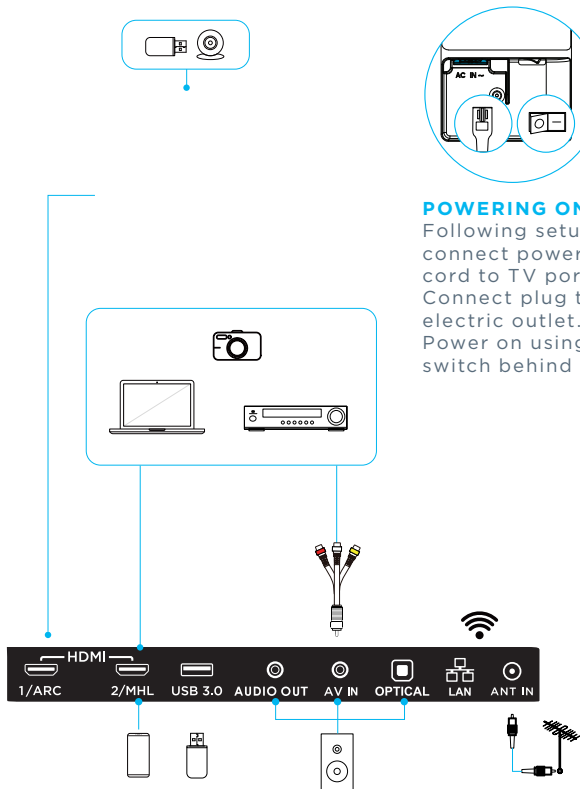

POWERING ON:

Following setup, connect power cord to TV port. Connect plug to electric outlet. Power on using switch behind TV.

CONNECTING YOUR TV

HDMI: Connect external components (such as Blu-ray and game consoles) to your TV using a HDMI cable.

ARC: (Audio Return Channel): Send a digital signal to a compatible device without the need for an additional optical audio connection.

MHL: Use the MHL option for mobile phones and cameras.

A/V (Composite): Connect to an older generation device, such as VCR or DVD player, using the composite cable*.

Digital Optical Audio: Connect to external sound devices using optical audio cable.

Antenna: Connect to antenna by plugging coaxial cable into the ANT IN connector.

Connecting to Internet: Connect TV to the internet using a wired (LAN) or wireless (built in 802.11 b/g/n/ac wifi) connections.

* Male RCA cable not included.

REMOTE SET UP

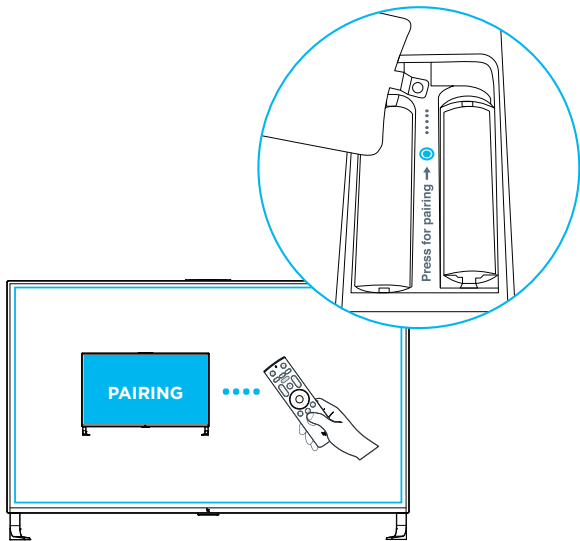







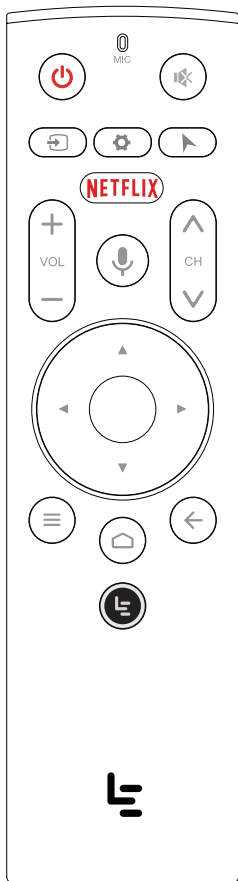







Slide battery cover off of remote and locate pairing button. Insert 2 AA batteries, press and hold button until connection is confirmed on screen.

NOTE: In order to connect, remote must be less than eight inches from lower section of TV.

REMOTE PAIRING



-  Power television on or off
-  Mute sound
-  Display and select input sources
-  Display and select settings
-  Activate screen navigation
-  Access Netflix services
-  Increase or decrease volume
-  Activate voice commands
-  Channel up or down
-  Navigate up, down, left or right
-  Select/Enter
-  Display application menu
-  Display TV home page
-  Return to previous screen
-  Access Le

Troubleshooting

Before seeking repair service, please inspect following items and confirm whether fault symptom encountered can be solved.

Problem	Inspection item
No image or sound (TV, Video, PC)	Check 100-240V power plug is firmly inserted into power socket. Check that signal cable is connected. Check the signal source unit is properly powered on. Check the TV is not in standby mode.
No sound (TV, Video, PC)	Check the TV volume is not muted.
No video or sound, or only noise (TV)	Check the antenna is properly connected. Likely due to poor signal reception.
Poor image(TV)	Check the antenna is properly connected. Likely due to poor signal reception.
Poor image(Video)	Check correct video signal mode is selected.
Image blurring (TV)	Check the antenna connection is not loose. Likely due to poor signal reception.
Double patterning or triple patterning of video (TV)	Check the antenna is pointed to correct direction. There may be reflected signal interference from high mountain or building.
Stripe or thin hue image	Check the TV is not suffering interference from other devices. Keep away from other devices which may cause interference.

After-sales Service Policy

Thank you for purchasing Letv Super TV (the “Product”). If you experience any problems when using the Product and need help, please contact our customer service at any time, and we will provide you with quick, professional and high-quality after-sales service!

Manufacturer’s Warranty

Le Shi Zhi Xin Electronic Technology (Tianjin) Limited (“Letv”) represents and warrants to the original purchaser (“Purchaser”) that Letv’s Super TV Devices and accessories (“Product”) are free from material defects, including improper or inferior workmanship, materials, and design, during the designated warranty period, and subject to the following terms and conditions, when used normally and in accordance with all operating instructions.

This warranty covers only the hardware components of the Product and does not cover any software products, whether or not included with the Product. Purchaser’s rights and obligations with respect to any software is governed by the applicable End User License Agreement.

During the warranty period, Letv will provide repair, replacement or refund in accordance with this Policy. After the expiration of the warranty period, Letv will provide paid repair or paid replacement in lieu of repair in accordance with this Policy.

Seller shall be obligated to:

1. Not sell any Product listed in the sales catalog for which it cannot guarantee the implementation of the warranty policy;
2. Maintain the quality of the sold Product;
3. Implement acceptance inspection of the purchased Product, and not sell any Product that is not properly labeled;
4. Inform consumers of information related to the Product’s use, maintenance, warranty and repair service providers, and provide a valid receipt when selling the Product; and
5. Appropriately handle consumer requests and complaints and provide approximate service.

Repairer shall be obligated to:

1. Provide repair services;
2. Protect the seller's and the manufacturer's reputation, not use any parts or components that are not compliant with the Product's specifications, make detailed records of malfunction and post-repair quality information, and ensure that after repair, the Product can work properly for at least 30 days;
3. Ensure that the repair charges and components are exclusively used for the repair, and accept supervision and inspection from the seller and the manufacturer;
4. Bear liability and losses arising from its own negligence; and
5. Respond to consumer inquiries about repair quality.

Warranty policy:

Product	Warranty Coverage	Part Name	Warranty Month	Notes
Letv Super TV	Whole product	Main board, Power board and Remote controller, etc	12	
	Main Parts	Display Panel	36	
	Software	OTA	12	This only refers to restoring the TV to its factory default conditions
	Other Materials	Accompanying documents (such as user's manual) and packaging	0	

Refund and replacement policy:

Letv will provide replacement or refund for the Super TV in accordance with the laws of the United States:

1. 30-day refund without reasons: Purchaser is entitled to a 30-day refund for any reason by returning the Product purchased from LeMall, as received (including packaging and all accessories), within 30 days starting from the next day after receipt of the Product. Letv will bear the corresponding shipping cost incurred for refund and replacement.

2. Refund within the warranty period: For any material malfunction of the Product confirmed through testing by Letv or an authorized service provider within 30 days starting from the next day after receipt of the Product, Purchaser has the option of having the Product refunded at the purchase price. In case of refund, please provide the original packaging, accessories, user's manual and warranty card, and Letv will bear the corresponding shipping cost.
3. Replacement within the warranty period: In the event of any functional fault of the Product within 30 days starting from the next day after receipt of the Product, subject to the confirmation by Letv or an authorized service provider through testing, Purchaser has the option of having the Product repaired or replaced with a new product of the same model and specifications, and Letv will bear the corresponding shipping cost.

Refund or Replacement	Time Limit	Description	Service Type	Notes
Refund	30 days	Functional faults or quality defects as defined in applicable laws and regulations (as determined by after-sales personnel with corresponding evaluation reports)	Free service	The first day starting from the next day after receipt
		Shipping damages, missing of parts, inconsistency between the Product and its online description, and other issues attributable to Letv USA (shipping damages refer to damages, leakage of liquid, breakizing or functional faults that are caused during shipment subject to verification by Letv USA. Missing of parts refers to absence of original parts of the Product).	Free service	The first day starting from the next day after receipt
		Except for the above-mentioned two reasons, if Purchaser requests a refund, s/he shall ensure that the Product is returned in its original conditions and packaging with all accessories and accompanying documents.	Letv will bear the corresponding shipping cost incurred for refund and replacement.	The first day starting from the next day after receipt
Replacement	30 days	Functional faults or quality defects as defined in applicable laws and regulations (as determined by after-sales personnel with corresponding evaluation reports)	Free service	The first day starting from the next day after receipt

The Product cannot be refunded or replaced in any of the following situations:

1. Any commodities not sold by Letv (wrong serial number);
2. The Product is damaged due to unauthorized repair, misuse, negligence, abuse, accident, modification, improper installation, or improper use;
3. Purchaser cannot provide the valid purchase receipt of the Product, or the receipt provided doesn't match the Product or is obliterated;
4. Pseudo-faults or affected performance attributable to Purchaser's setting of use, where the Product is determined to be free from any faults;
5. Other situations where replacement and refund are not supported by laws.

Cases where free repair is not guaranteed:

1. Abuse, accident, misuse, improper storage, exposure to liquid, moisture, or dampness;
2. External causes such as from collision, fire, flooding, sand, dirt, windstorm, lightning, or earthquake;
3. Exposure to extreme weather conditions, Acts of God, theft, blown fuse, electrical surge, or improper use of any electrical source;
4. Computer or internet viruses, bugs, worms, Trojan Horses, cancelbots;
5. Use with non-Letv USA products or products not recommended for use with Letv USA Products;
6. Normal wear and tear of the equipment;
7. Usage of Product other than its normal and customary manner;
8. Improper testing, operation, maintenance, installation, or any alteration or modification of Product;
9. Consumable parts, such as batteries, unless damage has occurred due to a defect in Letv USA materials and workmanship;
10. Service performed by anyone who is not a Letv representative or an authorized Letv service provider;
11. Other acts which are not the fault of Letv including damage caused by shipping;
12. Cosmetic damages, including but not limited to dents or scratches in decorative, structural, or non-operative parts resulting from normal customer use;
13. Spillage of food or liquid, corrosion, rust or incorrect voltage; and
14. The defective function of the cellular system or inadequate signal reception by the external antenna, or viruses or other software problems introduced into the Product.

Reminders

1. Letv Super TV displays ads upon starting up and this feature cannot be disabled.
2. Purchaser is advised to use the Product on a network with adequate bandwidth. If the Product cannot be used due to network reasons, it is not covered by the after-sales service.

Service quality warranty

1. During the warranty period, Letv TV Technologies' authorized service provider will provide repair using the original manufacturer's parts and components according to the results of diagnosis. The Product that has parts or components replaced with new ones will be covered for the rest of the warranty period or 30 days, whichever is the longer.
2. For accessories experiencing malfunction within the warranty period, Letv TV Technologies' authorized service provider will provide replacement with accessories of the same type and specifications, and those accessories will have a renewed warranty period.
3. Where the Product is beyond its warranty period or its problems are outside the scope of warranty, Letv TV Technologies' authorized service provider will provide paid repair service in an efficient and professional way. The repair service will be carried out using the parts and components from the original manufacturer with a 30-day warranty period.

Statements

1. This limited warranty only applies to products manufactured exclusively by or for Letv and that can be identified by the "Letv" trademark, trade name, or logo affixed to them. The limited warranty does not apply to any non-Letv products or software.
2. The Warranty extends only to Products purchased in the United States of America from a Letv authorized dealer or retailer. During the limited warranty period, Letv will repair or replace, at Letv's sole option, any parts of the Product that are defective or malfunction during normal usage. Letv reserves the right to use new or refurbished replacement parts in repair of the Product.
3. This limited warranty covers only the costs of parts and labor. Other related costs such as shipping and delivery costs may be borne by purchaser at Letv's option.
4. At Letv's request, Purchaser may be required to prove the date of the original purchase of the Product by a dated bill of sale or dated itemized receipt.
5. Letv does not warrant that the operation of this product will be uninterrupted or error-free.

6. This warranty will also be null and void in any of the following events:

- The serial number or warranty seal on the equipment has been altered, defaced or removed;
- Any term contained in this warranty has been altered or modified in any way without prior written consent of Letv;
- Letv has not been notified by Purchaser of the alleged defect or malfunction of the Product during the applicable warranty period.

7. If Product is returned to Letv after the expiration of the warranty period, Letv 's normal service policies shall apply and Purchaser will be charged accordingly.

- The serial number or warranty seal on the equipment has been altered, defaced or removed;
- Any term contained in this warranty has been altered or modified in any way without prior written consent of Letv;
- Letv has not been notified by Purchaser of the alleged defect or malfunction of the Product during the applicable warranty period.

8. This limited warranty provides Purchaser's sole and exclusive remedy to be provided by Letv. The agents, employees, distributors, and dealers of Letv products are not authorized to make modifications to this limited warranty, or make additional warranties binding on Letv.

- LIMIT OF LIABILITY
- Letv 'S LIMIT OF LIABILITY UNDER THIS LIMITED WARRANTY SHALL BE THE ACTUAL CASH VALUE OF THE PRODUCT AT THE TIME PURCHASER RETURNS THE PRODUCT FOR REPAIR, AS DETERMINED BY THE PRICE PAID BY THE PURCHASER FOR THE PRODUCT LESS A REASONABLE AMOUNT OF USAGE. Letv SHALL NOT BE LIABLE FOR ANY OTHER LOSSES OR DAMAGES SUCH AS SPECIAL, INCIDENTAL, CONSEQUENTIAL, OR PUNITIVE DAMAGES (INCLUDING BUT NOT LIMITED TO LOSS OF ANTICIPATED BENEFITS OR PROFITS, LOSS OF SAVINGS OR REVENUE, LOSS OF DATA, LOSS OF USE OF THE PRODUCT OR ANY ASSOCIATED EQUIPMENT, COST OF CAPITAL, COST OF ANY SUBSTITUTE EQUIPMENT OR FACILITIES, DOWNTIME, ANY COSTS OF RECOVERING, REPROGRAMMING, OR REPRODUCING ANY PROGRAM OR DATA, ANY FAILURE TO MAINTAIN THE CONFIDENTIALITY OF DATA STORED ON THE PRODUCT, THE CLAIMS OF ANY THIRD PARTIES, INCLUDING SUBSEQUENT PURCHASERS, AND INJURY TO PROPERTY, RESULTING FROM THE PURCHASE OR USE OF THE PRODUCT OR ARISING FROM BREACH OF THIS WARRANTY, BREACH OF CONTRACT, NEGLIGENCE, STRICT LIABILITY, OR ANY OTHER LEGAL OR EQUITABLE THEORY, EVEN IF LETV KNEW OF THE LIKELIHOOD OF SUCH DAMAGES). LETV SHALL NOT BE LIABLE FOR DELAY IN RENDERING SERVICE UNDER THE LIMITED WARRANTY, OR LOSS OF USE DURING THE PERIOD THAT THE PRODUCT IS BEING REPAIRED.

- DISCLAIMER OF WARRANTY
- LETV'S LIABILITY UNDER EITHER THE IMPLIED WARRANTY OF MERCHANTABILITY OR FITNESS FOR A PARTICULAR PURPOSE, SHALL BE LIMITED TO THE DURATION OF THE FOREGOING LIMITED WRITTEN WARRANTY. OTHERWISE, THE FOREGOING LIMITED WARRANTY IS PURCHASER'S SOLE AND EXCLUSIVE REMEDY AND IS IN LIEU OF ALL OTHER WARRANTIES, EXPRESS OR IMPLIED.
- Some states do not allow exclusion or limitation of incidental, consequential, or punitive damages, or permit limitations on the length of implied warranties, so certain of these warranty limitations may not apply to Purchaser. This limited warranty gives Purchaser specific legal rights; Purchaser may also have other rights which vary from state to state. If any term of this limited warranty is held to be illegal or unenforceable, the legality or enforceability of the remaining terms shall not be affected or impaired.
- This limited warranty allocates risk of Product failure between Purchaser and Letv, and Letv's Product pricing reflects this allocation of risk and the limitations of liability contained in this limited warranty.

End User License Agreement for Software

IMPORTANT. READ CAREFULLY: This End User License Agreement (“EULA”) is a legal agreement between you (either an individual or a single entity) and Letv USA (“Letv”) for software, whether pre-installed or downloaded, owned by Letv and its affiliated companies and its third party suppliers and licensors, that accompanies this EULA, which includes computer software and may include associated media, content and data, printed materials, or electronic documentation in connection with your use of Letv Device, which will be defined below (“Letv Software”). By using this device or any other Letv product running on Android operating system (“Letv Device”), you accept terms of this EULA. If you do not accept these terms, do not use the Letv Device or the Letv Software.

1.GRANT OF LICENSE.

Letv grants you a limited non-exclusive license to install, use, access, display and run one copy of the Letv Software on a single Letv Device, local hard disk(s) or other permanent storage media of one computer, and you may not make Letv Software available over a network where it could be used by multiple computers at the same time. You may make one copy of the Letv Software in machine readable form for backup purposes only; provided that the backup copy must include all copyright or other proprietary notices contained on the original. Certain items of the Letv Software may be subject to open source licenses. The open source license provisions may override some of the terms of this EULA. We make the applicable open source licenses available to you if you so request.

2.RESERVATION OF RIGHTS AND OWNERSHIP.

Letv reserves all rights not expressly granted to you in this EULA. The Software is protected by copyright and other intellectual property laws and treaties. Letv or its suppliers own the title, copyright and other intellectual property rights in the Software. The Software is licensed, not sold.

3.LIMITATIONS ON END USER RIGHTS.

You may not, or enable others to, copy, reverse engineer, decompile, disassemble, or otherwise attempt to discover the source code or algorithms of, the Software (except and only to the extent that such activity is expressly permitted by applicable law notwithstanding this limitation), or modify, or disable any features of, the Software, or create derivative works based on the Software. You may not rent, lease, lend, sublicense or provide commercial hosting services with the Software. You may not transfer this EULA or the rights to the Letv Software granted herein to any third party unless it is in connection with the sale

of the device which the Letv Software accompanied. In such event, the transfer must include all of the Letv Software (including all component parts, the media and printed materials, any upgrades, this EULA) and you may not retain any copies of the Letv Software. The transfer may not be an indirect transfer, such as a consignment. Prior to the transfer, the end user receiving the Letv Software must agree to all the EULA terms.

4.LETV SOFTWARE UPDATES.

Letv may make available to you updates, upgrades, supplements and add on components (if any) of the Letv Software, including bug fixes, service upgrades (parts or whole), and updates, enhancements and feature improvements or deletion to any Letv Software (including entirely new versions), (collectively "Update") after the date you obtain your initial copy of the Letv Software. This EULA applies to all and any component of the Update, unless we provide other terms along with such Update. To use Letv Software provided through Update, you must first be licensed for the Letv Software identified by Letv as eligible for the Update. While the Update will be generally available, in some limited circumstances, the Letv Software updates will only be offered by your network carrier, and such Letv Software updates will be governed by your contractual relationship with your network carrier. With the "Automatic Update" function enabled (as in the default setting in the System Update menu in the Setting), your device downloads certain Updates automatically from time to time. If you have chosen to disable the "Automatic Update" function, then you can check the availability of new Updates by clicking on the "Check Update" menu in the Setting. Given the importance of receiving Updates for security software in a timely manner to defend against new threats, however, security-related Updates may be automatically downloaded and installed without your consent, even if you have disabled the "Automatic Update" function. We recommend that you check availability of any new Updates periodically for optimal use of your device.

5.CONSENT TO USE OF DATA.

You agree that Letv and its third party providers of Letv Software may collect and use technical, non-technical and related information, including but not limited to information about your use of the Letv Software, content viewed and attached peripherals, products or services purchased, that is gathered periodically to facilitate the provision of software updates, product support and other services to you, including additional or different Letv Software and to verify compliance with the terms of this EULA. Letv and its third party providers of Letv Software and/or other providers may use this information, as long as it is in a form that does not personally identify you, to improve our products or to provide services or technologies to you.

6. INTERNET ACCESS.

Some features of the Letv Software may require your device to have access to the internet and may be subject to restrictions imposed by your network or internet provider. Unless your device is connected to the internet through Wi-Fi connection, the Letv Software will access the internet through your mobile network, which may result in additional charges depending on your payment plan. In addition, your enjoyment of some features of the Letv Software may be affected by the suitability and performance of your device hardware or data access.

7. EXPORT RESTRICTIONS.

You acknowledge that the Letv Software is subject to export restrictions of various countries. You agree to comply with all applicable international and national laws that apply to the Letv Software, including all the applicable export restriction laws and regulations.

8. TERMINATION.

This EULA is effective until terminated. Your rights under this License will terminate automatically without notice from Letv if you fail to comply with any of the terms and conditions of this EULA. Upon termination of this EULA, you must cease all use of the Letv Software and destroy all copies, full or partial, of the Letv Software. Section 5, 9,10,13,15, and 16 of this EULA shall survive any such termination.

9. DISCLAIMER OF WARRANTY.

UNLESS SEPARATELY STATED IN A WRITTEN EXPRESS LIMITED WARRANTY ACCOMPANYING YOUR DEVICE, ALL LETV SOFTWARE PROVIDED BY LETV USA WITH THIS DEVICE (WHETHER INCLUDED WITH THE DEVICE, DOWNLOADED, OR OTHERWISE OBTAINED) IS PROVIDED "AS IS" AND ON AN "AS AVAILABLE" BASIS, WITHOUT WARRANTIES OF ANY KIND FROM LETV USA, EITHER EXPRESS OR IMPLIED. TO THE FULLEST EXTENT POSSIBLE PURSUANT TO APPLICABLE LAW, LETV USA DISCLAIMS ALL WARRANTIES EXPRESS, IMPLIED, OR STATUTORY, INCLUDING, BUT NOT LIMITED TO, IMPLIED WARRANTIES OF MERCHANTABILITY, SATISFACTORY QUALITY OR WORKMANLIKE EFFORT, FITNESS FOR A PARTICULAR PURPOSE, RELIABILITY OR AVAILABILITY, ACCURACY, LACK OF VIRUSES, QUIET ENJOYMENT, NON INFRINGEMENT OF THIRD PARTY RIGHTS OR OTHER VIOLATION OF RIGHTS. SOME JURISDICTIONS DO NOT ALLOW EXCLUSIONS OR LIMITATIONS OF IMPLIED WARRANTIES, SO THE ABOVE EXCLUSIONS OR LIMITATIONS MAY NOT APPLY TO YOU. NO ADVICE OR INFORMATION, WHETHER ORAL OR WRITTEN, OBTAINED BY YOU FROM LETV USA OR ITS AFFILIATES SHALL BE DEEMED TO ALTER THIS DISCLAIMER BY LETV USA OF WARRANTY REGARDING LETV SOFTWARE, OR TO CREATE ANY WARRANTY OF ANY SORT FROM LETV USA. YOU EXPRESSLY ACKNOWLEDGE AND AGREE THAT, TO THE EXTENT PERMITTED BY APPLICABLE LAW, USE OF THE LETV SOFTWARE AND ANY SERVICES PERFORMED BY OR ACCESSED THROUGH THE LETV SOFTWARE IS AT YOUR SOLE RISK AND THAT THE ENTIRE RISK AS TO SATISFACTORY QUALITY, PERFORMANCE, ACCURACY AND EFFORT IS WITH YOU.

10. THIRD-PARTY APPLICATIONS.

Certain third party applications or services may be included with, or downloaded to your Letv Device. Such third party applications or services may display, include or make available content, data, information, applications or materials from third parties (“Third Party Materials”) or provide links to certain third party websites. By using the Letv Software, you acknowledge and agree that Letv is not responsible for the availability of such applications and is not responsible or liable for any content, advertising, products, services, or other materials on or available from such applications. You expressly acknowledge and agree that use of third party applications is at your sole risk and that the entire risk of unsatisfactory quality, performance, accuracy and effort is with you. You agree not to modify, rent, lease, loan, sell, distribute, or create derivative works based on the services, in any manner, and you shall not exploit the services in any unauthorized way whatsoever, including but not limited to, using the services to transmit any computer viruses, worms, Trojan horses or other malware, or by trespassing or burdening network capacity. You further agree not to use the services in any manner to harass, abuse, stalk, threaten, defame or otherwise infringe or violate the rights of any other party, and that Letv is not in any way responsible for any such use by you, nor for any harassing, threatening, defamatory, offensive, infringing or illegal messages or transmissions that you may receive as a result of using any of the services. References on this device to any names, marks, products, or services of any third-parties are provided solely as a convenience to you, and do not constitute or imply an endorsement, sponsorship, or recommendation of, or affiliation with the third party or its products and services. You acknowledge and agree that the use of any third-party application is governed by such third party application provider’s terms of use, license agreement, privacy policy, or other such agreement and that any information or personal data you provide, whether knowingly or unknowingly, to such third-party application provider, will be subject to such third party application provider’s privacy policy, if such a policy exists. LETV USA DISCLAIMS ANY RESPONSIBILITY FOR ANY DISCLOSURE OF INFORMATION OR ANY OTHER PRACTICES OF ANY THIRD PARTY APPLICATION PROVIDER. LETV USA EXPRESSLY DISCLAIMS ANY WARRANTY REGARDING WHETHER YOUR PERSONAL INFORMATION IS CAPTURED BY ANY THIRD PARTY APPLICATION PROVIDER OR THE USE TO WHICH SUCH PERSONAL INFORMATION MAY BE PUT BY SUCH THIRD PARTY APPLICATION PROVIDER.

11. LETV SERVICES.

Certain Letv applications and services may be included with, or downloaded to, your Letv Device. The Letv Software may enable access to Letv and third party services and web sites (collectively and individually, “Services”). Some such Services and applications may not be available in all languages or in all countries. Many of them may require Letv Services membership registration (“Letv Account”), and your rights and obligations will be set forth in separate Letv Account Terms and Conditions. There are non-Letv Account applications and

services that may require your consent to their separate terms and conditions as well. You expressly acknowledge and agree that your use of such applications and services will be subject to the applicable terms and conditions. Your use of a Letv Account is subject to the latest Letv Account Terms and Conditions, which will be provided to you separately.

12. DIGITAL CERTIFICATE.

You acknowledge and agree that you are solely responsible for your decision to rely on a digital certificate issued by either Letv USA or a third party and your use of such certificate. Letv USA makes no express or implied warranties or representations as to merchantability or fitness for any particular purpose, accuracy, security, or non-infringement of third party rights with respect to digital certificates.

13. LIMITATION OF LIABILITY.

LETV WILL NOT BE LIABLE FOR ANY DAMAGES OF ANY KIND ARISING OUT OF OR RELATING TO THE USE OR THE INABILITY TO USE THE LETV SOFTWARE OR ANY THIRD PARTY APPLICATION, ITS CONTENT OR FUNCTIONALITY, INCLUDING BUT NOT LIMITED TO DAMAGES CAUSED BY OR RELATED TO ERRORS, OMISSIONS, INTERRUPTIONS, DEFECTS, DELAY IN OPERATION OR TRANSMISSION, COMPUTER VIRUS, FAILURE TO CONNECT, NETWORK CHARGES, IN-APP PURCHASES, AND ALL OTHER DIRECT, INDIRECT, SPECIAL, INCIDENTAL, EXEMPLARY, OR CONSEQUENTIAL DAMAGES EVEN IF LETV HAS BEEN ADVISED OF THE POSSIBILITY OF SUCH DAMAGES. SOME JURISDICTIONS DO NOT ALLOW THE EXCLUSION OR LIMITATION OF INCIDENTAL OR CONSEQUENTIAL DAMAGES, SO THE ABOVE EXCLUSIONS OR LIMITATIONS MAY NOT APPLY TO YOU. NOTWITHSTANDING THE FOREGOING, LETV ELECTRONIC CO.'S TOTAL LIABILITY TO YOU FOR ALL LOSSES, DAMAGES, CAUSES OF ACTION, INCLUDING BUT NOT LIMITED TO THOSE BASED ON CONTRACT, TORT, OR OTHERWISE, ARISING OUT OF YOUR USE OF THE LETV SOFTWARE OR THIRD PARTY APPLICATIONS ON THIS DEVICE, OR ANY OTHER PROVISION OF THIS EULA, SHALL NOT EXCEED THE AMOUNT PURCHASER PAID SPECIFICALLY FOR THIS DEVICE OR ANY SUCH THIRD PARTY APPLICATION THAT WAS INCLUDED WITH THIS DEVICE. THE FOREGOING LIMITATIONS, EXCLUSIONS, AND DISCLAIMERS (INCLUDING SECTIONS 10, 11, 12 AND 13) SHALL APPLY TO THE MAXIMUM EXTENT PERMITTED BY APPLICABLE LAW, EVEN IF ANY REMEDY FAILS ITS ESSENTIAL PURPOSE.

14. U.S. GOVERNMENT END USERS RESTRICTED RIGHTS.

The Letv Software is licensed only with "restricted rights" and as "commercial items" consisting of "commercial software" and "commercial software documentation" with only those rights as are granted to all other end users pursuant to the terms and conditions herein. All products are provided only with "restricted rights" with only those rights as are granted to all other end users pursuant to the terms and conditions herein. All Letv Software and Products are provided subject to Federal Acquisition Regulation (FAR)52.227.19.

15. APPLICABLE LAW.

This EULA is governed by the laws of California, without regard to its conflict of law provisions. This EULA shall not be governed by the UN Convention on Contracts for the International Sale of Goods, the application of which is expressly excluded.

16. DISPUTE RESOLUTION.

(a) Non-United States residents. If a dispute, controversy or difference arising in any way from this EULA or your use of the Letv Software is not amicably settled, it shall be subject to the non-exclusive jurisdiction of the courts of the jurisdiction where you are a resident. Notwithstanding the foregoing, Letv may apply for injunctive remedies (or an equivalent type of urgent legal relief) in any jurisdiction.

(b) United States residents. ALL DISPUTES WITH LETV USA ARISING IN ANY WAY FROM THIS EULA OR YOUR USE OF THE SOFTWARE SHALL BE RESOLVED EXCLUSIVELY THROUGH FINAL AND BINDING ARBITRATION, AND NOT BY A COURT OR JURY. Any such dispute shall not be combined or consolidated with any other person's or entity's claim or dispute, and specifically, without limitation of the foregoing, shall not under any circumstances proceed as part of a class action. The arbitration shall be conducted before a single arbitrator, whose award may not exceed, in form or amount, the relief allowed by the applicable law. The arbitration shall be conducted according to the American Arbitration Association (AAA) Commercial Arbitration Rules applicable to consumer disputes. This arbitration provision is entered pursuant to the Federal Arbitration Act. The laws of the State of California, without reference to its choice of laws principles, shall govern the interpretation of the EULA and all disputes that are subject to this arbitration provision. The arbitrator shall decide all issues of interpretation and application of this arbitration provision and the EULA. Judgment may be entered on the arbitrator's award in any court of competent jurisdiction. This arbitration provision also applies to claims against Letv's employees, representatives and affiliates if any such claim arises from the licensing or use of the Software. You may opt out of this dispute resolution provision by writing to Letv USA within 30 days of the initial purchase of the Letv Device indicating you are opting out. This notice must be sent to [ADDRESS OR EMAIL ADDRESS] and must include: (a) your name and address; (b) a dated bill of sale or dated itemized receipt for the Letv Device; and (c) the Serial Number for the Letv Device. Opting out of this dispute resolution provision will not affect your use of the Letv Device or the Letv Software, or your license to the Letv Software.

17. ENTIRE AGREEMENT; SEVERABILITY.

This EULA is the entire agreement between you and Letv USA relating to the Letv Software and supersedes all prior or contemporaneous oral or written communications, proposals and representations with respect to the Letv Software or any other subject matter covered by this EULA. If any provision of this EULA is held to be void, invalid, unenforceable or illegal, the other provisions shall continue in full force and effect.

Maintenance Card

Tips: Dear customer, this card shall be carefully preserved for the purpose of maintenance and service account identification.

Maintenance Card			
Product Information			
Product Type			
MAC Address			
Dealership			
Date of Sales			
Maintenance Record			
Date	Fault Symptom	Fault Cause	Handling Information

Notes: Please refer to the "Quick Guide" for warranty provisions. The warranty period starts from the date of the valid certificate of purchase.

Customer Service Support

For any faults during use, do not attempt to dismantle the TV on your own. Please contact customer service immediately.

Please contact our authorized special maintenance stations nationwide or the company free hot line service:

Email: Lecare@letv.com

For more customer service info: www.lemall.com

This product contains build-in push ads while power on.