



Owner's Manual

PRECAUTIONS AND NOTICES

■ Important Information

Please Read Carefully Before Using This Product.

This product is intended to provide turn by turn instructions to get you to a desired destination. Please make certain that all persons using this navigation system carefully read these precautions and the following instructions fully.

- 1) This product is not a substitute for your personal judgment. Any route suggestions made by this navigation system may never supersede any local traffic regulations or your personal judgment and/or knowledge of safe driving practices. Do not follow route suggestions if the navigation system instructs you to perform an unsafe or illegal maneuver, places you in an unsafe situation, or routes you into an area which you consider unsafe.
 - 2) Glance at the screen only when necessary and safe to do so. If prolonged viewing of the screen is necessary, pull over in a safe and legal manner and location.
 - 3) Do not input destinations, change settings, or access any functions requiring a prolonged view of the monitor and/or remote control while you are driving. Pull over in a safe and legal manner and location before attempting to access the system.
 - 4) Do not use the navigation system to route you to emergency services. Not all locations of emergency services such as police and fire stations, hospitals and clinics are contained in the database. Please use your own judgment and ask for directions in these situations.
 - 5) The map database used in the navigation system is the most recent map data available at the time of production. Because of changes in streets and neighborhoods, there may be situations where the navigation system is not able to route you to your desired destination. In these cases, use your own judgment.
 - 6) The map database is designed to provide you with route suggestions and does not take into account the relative safety of a suggested route or of factors which may affect the time required to reach your destination. The system does not reflect road closures or construction, road characteristics (i.e. type of road surface, slope or grade, weight or height restrictions, etc.), traffic congestion, weather conditions, or any other factors which may affect the safety or timing of your driving experience. Use your own personal judgment if the navigation system is unable to provide you with an alternate route.
 - 7) There may be situations where the navigation system displays the vehicle's location erroneously.
- Use your own driving judgment in this situation, taking into account current driving conditions. Please be aware that in this situation the navigation system should correct the vehicle's position automatically. However, there may be times where you may have to correct the position yourself. If this is the case, pull over in a safe and legal manner and location before attempting operation.
- 8) Make certain that the volume level of the navigation system is set to a level which still allows you to hear outside traffic and emergency vehicles.

If there is anything in the manual about the operation of the navigation system which you are uncertain about, please contact your local Alpine authorized navigation dealer or Alpine at 1-888-NAV-HELP (1-888-628-4357) before using the navigation system.

FCC Compliance Statement

Blackbird has been tested and found to comply with the limits for a Class B digital device, pursuant to part 15 of the FCC Rules. These limits are designed to provide more reasonable protection against harmful interference in a residential installation, and are more stringent than "outdoor" requirements.

Operation is subject to the following two conditions:

- (1) This device may not cause harmful interference, and
- (2) this device must accept any interference received, including interference that may cause undesired operation.

This equipment generates, uses, and can radiate radio frequency energy and, if not installed and used in accordance with the instructions, may cause harmful interference to radio communications. However, there is no guarantee that interference will not occur in a particular installation. If this equipment does cause harmful interference to radio or television reception, which can be determined by turning the equipment off and on, you are encouraged to try to correct the interference by one of the following measures:

- Reorient or relocate the receiving antenna.
- Increase the separation between the equipment and the receiver.
- Connect the equipment into an outlet on a circuit different from that to which the receiver is connected.
- Consult an experienced radio/TV technician.

WARNINGS

Points to Observe for Safe Usage

Read this manual carefully before using this system. It contains instructions on how to use this product in a safe and effective manner. Alpine cannot be responsible for problems resulting from failure to observe the instructions in this manual.

This manual uses various pictorial displays to show you how to use this product safely and to alert you to potential dangers resulting from improper connections and operation. Following are explanations of these pictorial displays. It is important to fully understand the meanings of these pictorial displays in order to use this manual and the system properly.

WARNING

This symbol means important instructions. Failure to heed them can result in serious injury or death.

DO NOT OPERATE ANY FUNCTION THAT TAKES YOUR ATTENTION AWAY FROM SAFELY DRIVING YOUR VEHICLE.

Any function that requires your prolonged attention should only be performed after coming to a complete stop. Always stop the vehicle in a safe location before performing these functions. Failure to do so may result in an accident.

KEEP THE VOLUME AT A LEVEL WHERE YOU CAN STILL HEAR OUTSIDE NOISE WHILE DRIVING.

Failure to do so may result in an accident.

MINIMIZE DISPLAY VIEWING WHILE DRIVING.

Viewing the display may distract the driver from looking ahead of the vehicle and cause an accident.

DO NOT DISASSEMBLE OR ALTER.

Doing so may result in an accident, fire or electric shock.

USE THIS PRODUCT AS SPECIFIED.

Use for other than its designed application may result in fire, electric shock or other injury.

KEEP SMALL OBJECTS SUCH AS BATTERIES OUT OF THE REACH OF CHILDREN.

Swallowing them may result in serious injury. If swallowed, consult a physician immediately.

DO NOT PLACE HANDS, FINGERS OR FOREIGN OBJECTS IN INSERTION SLOTS OR GAPS.

Doing so may result in personal injury or damage to the product.

USE THE CORRECT AMPERE RATING WHEN REPLACING FUSES.

Failure to do so may result in fire or electric shock.

DO NOT BLOCK VENTS OR RADIATOR PANELS.

Doing so may cause heat to build up inside and may result in fire.

CAUTION

This symbol means important instructions. Failure to heed them can result in injury or material property damage.

HALT USE IMMEDIATELY IF A PROBLEM APPEARS.

Failure to do so may cause personal injury or damage to the product. Return it to your authorized ALPINE dealer or the nearest ALPINE Service Center for repairing.

PRECAUTIONS

Temperature

Be sure the temperature inside the vehicle is between +45°C (+113°F) and -0°C (+32°F) before turning your unit on.

Fuse Replacement

When replacing the fuse(s), the replacement must be of the same amperage as shown on the fuse holder. If the fuse(s) blows more than once, carefully check all electrical connections for shorted circuitry. Also have your vehicle's voltage regulator checked.

Servicing the Unit

If you have problems, do not attempt to repair the unit yourself. Return it to your ALPINE dealer or the nearest ALPINE Service Station for servicing.

Installation Location

Make sure the PMD-B200 will not be exposed to:

- Direct sun and heat
- Excessive dust
- High humidity
- Excessive vibrations

Characteristics of LCD Panel

- After turning the system off, a slight ghost of the image will remain temporarily. This is an effect peculiar to LCD technology and is normal.
- Under cold temperature conditions, the screen may lose contrast temporarily. After a short warm-up period, it will return to normal.
- The LCD panel is manufactured using an extremely high precision manufacturing technology. Its effective pixel ratio is over 99.99%. This means that 0.01% of the pixels could be either always ON or OFF.

Using Headphones

If ACC or the monitor's power source is turned off, a loud noise may be produced through the headphone jack. Be sure to remove the headphones from your ears before you turn the monitor off.

USER AGREEMENT

In using this Blackbird Portable Navigation System (hereinafter referred to as "System"), which includes Alpine Electronics, Inc. ("Alpine") Specifications, Space Machine, Inc. ("Space Machine") Software and NAVTEQ North America, LLC. ("NAVTEQ") Database, you are bound by the terms and conditions set forth below. By breaking the seal on the System and using your copy of the System, you have demonstrated your agreement to the terms and conditions of this Agreement. You should, therefore, make sure that you read and understand the following provisions.

The System may not be copied, duplicated or otherwise modified, in whole or in part, without the express written permission of Alpine, Space Machine and NAVTEQ.

The System may not be transferred or sublicensed to any third party for profit, rent or loan or licensed for reuse in any manner.

The System may not be decompiled, reverse engineered or otherwise disassembled, in whole or in part. The System may not be used in a network or by any other manner of simultaneous use in multiple systems. The System is intended solely for personal use (or internal use where the end-user is a business) by the consumer.

The System is not to be used for commercial purposes.

Neither Alpine, Space Machine nor NAVTEQ guarantees to the customer that the System meet the specific objectives of the user.

Neither Alpine, Space Machine nor NAVTEQ shall be responsible for any damages caused by the use of the System to the actual user and to any third party.

The warranty on the System shall not extend to an exchange or refund due to misspelling, omission of letters, or any other cosmetic discrepancy in layout found in the System.

The right to use the System shall expire either when the user destroys this software, or when any of the terms for use is violated and Alpine, Space Machine and/or NAVTEQ exercise the option to revoke the license to use this software.

The terms and conditions hereof apply to all subsequent users and owners as well as to the original purchaser.

The NAVTEQ Database may include or reflect data of licensors, including Her Majesty The Queen in right of CANADA. Such data is licensed on an "AS IS" basis. The licensors, including Her Majesty The Queen, make no guarantees, representations or warranties respecting such data, either express or implied, arising by law or otherwise, accuracy or fitness for a particular purpose.

The licensors, including Her Majesty The Queen, shall not be liable in respect of any claim, demand or action, irrespective of the nature of the cause of the claim, demand or action alleging any loss, injury or damages, direct or indirect, which may result from the use or possession of the data or the NAVTEQ database. The licensors, including Her Majesty The Queen, shall not be liable in any way for loss of revenues or contracts, or any other consequential loss of any kind resulting from any defect in the data or the NAVTEQ database. End User shall indemnify and save harmless the licensors, including Her Majesty The Queen and the minister, and their officers, employees and agents from and against any claim, demand or action, irrespective of the nature of the cause of the claim, demand or action, alleging loss, costs, expenses, damages or injuries (including injuries resulting in death) arising out of the use or possession of the data or the NAVTEQ database.

TABLE OF CONTENTS

PRECAUTIONS AND NOTICES	2	Recalling the Maneuver List	
WARNINGS	3	during Guidance	23
USER AGREEMENT	4	Finding Alternate Route	23
TABLE OF CONTENTS	5	Finding Detour	23
SYSTEM FEATURES	6	Delete Route	23
INSTALLATION	8	EDIT	24
How to Mount Blackbird	8	Editing Home	24
How to Remove the Navigation System from		Editing Address Book	25
the Cradle	8	Deleting Previously Saved Destinations	25
Docking with IVA-W205	9	TRAFFIC	26
Removing Blackbird from IVA-W205	9	Viewing Traffic Incident List	26
How to Reset Blackbird	9	Viewing Traffic Incident Detail	26
BASIC OPERATIONS	10	Viewing Incident Location	26
To Power On	10	Calculating a Detour	27
To Power Off	10	Viewing Traffic Icon Legend	27
Set a Destination and Go!	10	MOBILE PHONE	28
MAP FUNCTION	12	Placing Calls	28
Setting Estimate Time Display	12	Receiving Calls	29
Setting the Map Orientation	12	Call Option Menu	29
Repeating the Announcement	12	SETUP	30
Zoom In/Out Map	12	Customizing Display	30
GPS Status	12	Customizing Guidance	31
Battery Status	12	Setting up the Clock	31
Setting a Destination Directly		Changing Unit of Measure	31
from Map Display	13	Configuring System Settings	31
Switching Map Display	13	Customizing Traffic Information	32
DESTINATION	14	Bluetooth Setup	34
Setting a Destination by Address	14	INFORMATION	36
Confirm Destination Screen	14	Simulating Navigation	36
Setting a Destination by POI	16	Viewing Trip Information	36
Setting a Destination from the		Viewing GPS Status	37
Address Book	17	Viewing System Information	37
Setting a Destination by Recently		ENTERTAINMENT	38
Entered Destination	18	Playing Music from Your Blackbird	38
Setting a Destination by Coordinates	18	How to Listen to Guidance and	
Setting a Destination by Intersection	19	Music from Your Car Stereo	39
OPTIONS	20	How to Update the New Software and	
Find Local Places	20	Map Database	39
Saving a Destination into		IN CASE OF DIFFICULTY	40
the Address Book	20	IN THE BOX	41
Setting Waypoints	21	Accessories	41
HOME	22	Optional Accessories	41
Set Destination as Home	22	SPECIFICATIONS	42
Finding Alternate Way to Go Home	22	INDEX	43
One-Touch Go Home	22	LIMITED WARRANTY	44
ROUTE	23		

Congratulations and thank you for purchasing the Alpine Blackbird Portable Navigation System. We hope you enjoy using this exciting product and trust that it will make your driving experience more comfortable, stress-free, and entertaining. The Blackbird Portable Navigation System provides an easy-to-use user interface, clear, easy-to-understand spoken driving instructions, and award winning design all in a portable product. Blackbird is built upon Alpine's history of navigation success in North America. Please read this manual carefully. If you have any further questions about Blackbird's operation, feel free to call Alpine at 1-888-NAV-HELP (628-4357) for technical assistance.

SYSTEM FEATURES

Blackbird Portable Navigation System

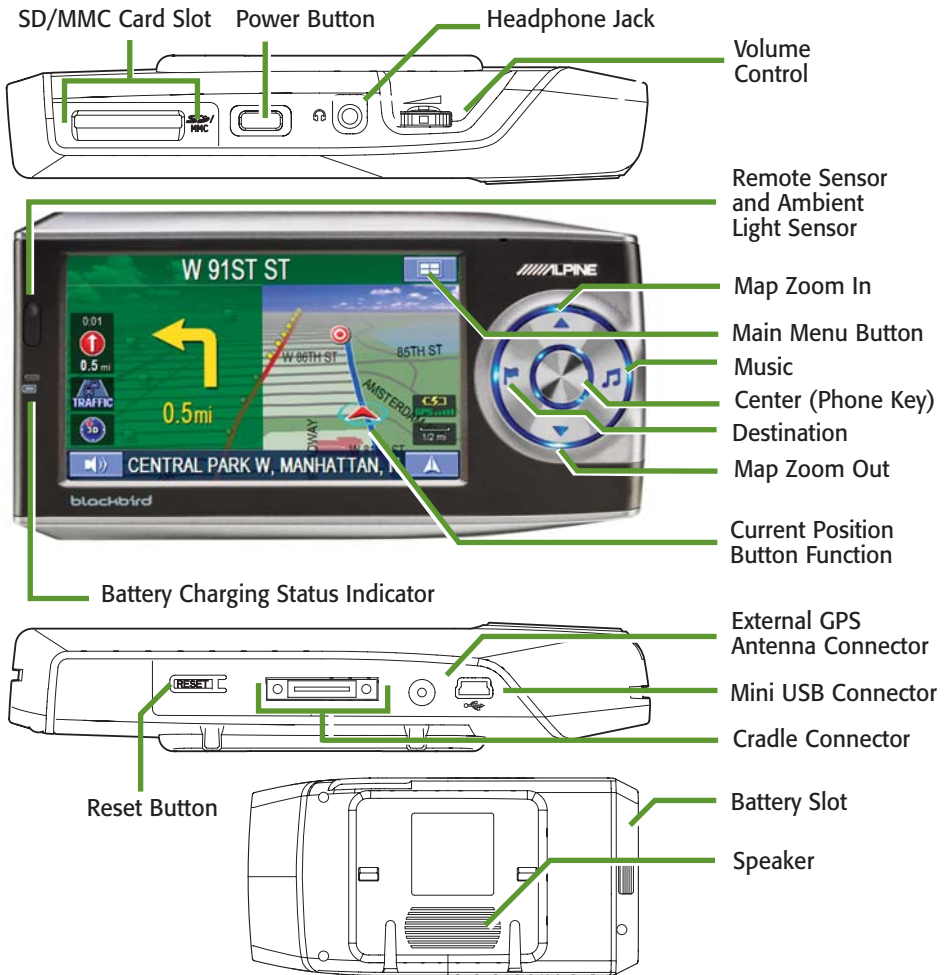

Battery Charging Status Indicator

This illuminates when the system is being charged or requires charging. The battery will be typically charged fully in three hours.

GREEN Battery is fully charged. RED Battery needs charging.
 AMBER Battery is charging.

Main Menu

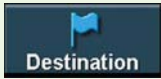

Set and save Destinations.
 → Page 14



Modify or choose alternate routes to a destination.
 → Page 23



Get back home from anywhere.
 → Page 22



Access your Bluetooth paired mobile phone.
 → Page 28



View Navigation Demonstration and system information.
 → Page 36



Play music.
 → Page 38

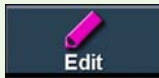

Edit Home and Address Book.
 → Page 24

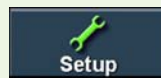

Customize the navigation system.
 → Page 30

Cradle with Cigarette Lighter Charger

• Optional External GPS Antenna Accessory Available (Model # PMD-ANT1)

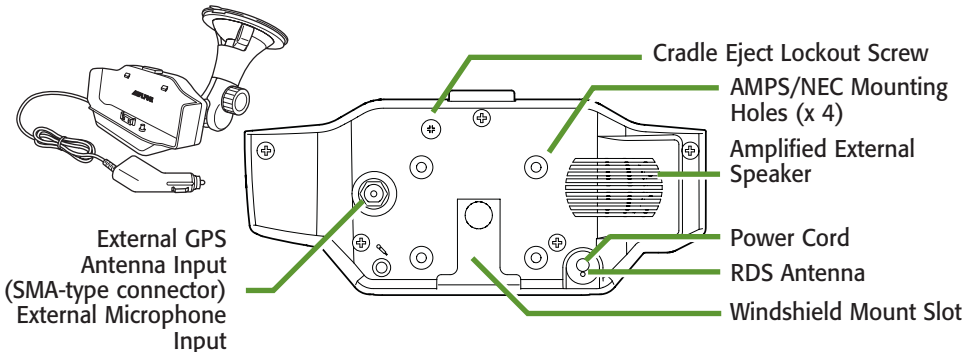

INSTALLATION

■ How to Mount Blackbird

⚠ **WARNING**

Improper installation may make the navigation system fall out from the cradle while driving. Please make sure all locks and knobs are turned tight.

Do not install the navigation while driving.

Note: The cradle consists of 2 separate parts that must be assembled before mounting.

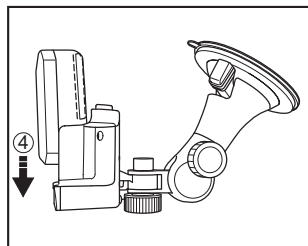
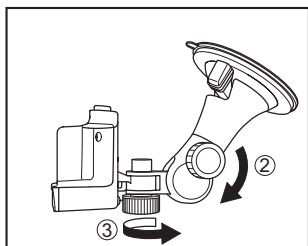
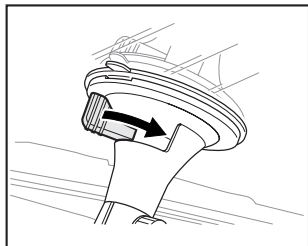

- 1 Find a spot suitable for the navigation system. Ensure that both the suction cup and windshield area are clean and free of dirt and grease before attaching it. Press the suction cup mount against the windshield. Turn the knob to activate the vacuum to lock the position.
- 2 Turn the knob counterclockwise to adjust up/down position. Then turn clockwise to set the position.
- 3 Turn the knob clockwise to adjust right/left position. Then turn counter clockwise to set the position. **DEVICE SHOULD NOT BE INSTALLED SO THAT IT OBSTRUCTS THE DRIVER'S VIEW.**
- 4 Slide the navigation system into the cradle until you hear a click sound.
- 5 Plug the cigarette lighter charger into the cigarette lighter socket.

⚠ **CAUTION**

Remove the navigation system when you are away from the vehicle to prevent theft.

■ How to Remove the Navigation System from the Cradle

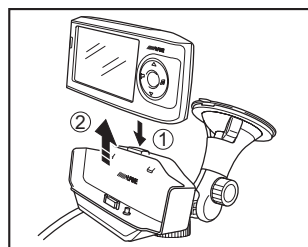

- 1 Press and hold the eject button on the cradle.
- 2 Grasp the navigation system behind the antenna and remove by sliding up and out of the cradle.

NOTE: Local regulations may prohibit the placement of any object on windows or the dash. Refer to your authorized Alpine dealer for other installation options.

■ Docking with IVA-W205

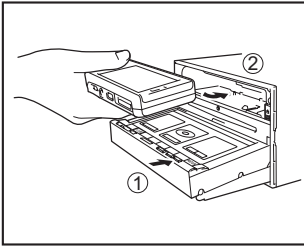

- 1 Open IVA-W205 head unit monitor.
- 2 Insert Blackbird into the unit with the screen facing up and the navigation wheel on the left.
- 3 Press Blackbird firmly into place.
- 4 Touch **Close** to close IVA-W205 face.
- 5 Select **Blackbird** as a source.



Additional On-Screen Buttons

When Blackbird is docked, two additional on-screen buttons allow you to conveniently access additional system features.

 Touching this button will give you access to the A/V Head Unit's display control.

NOTE: If left idle for more than 5 seconds, the system will automatically return to the Blackbird navigation screen.

 Touching this button will display Blackbird's music screen. Refer to page 38 for more information on the music functions.

■ Removing Blackbird from IVA-W205

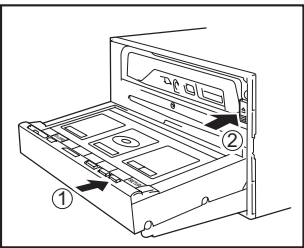

- 1 Touch **Open** on the screen.
- 2 Press the eject button.
- 3 Remove Blackbird from the head unit.

■ How to Reset Blackbird

In the event the system requires a reset, pull over in a safe and legal manner before doing so. Press the reset button on the bottom for at least 1 second. Then, to restart the system, press and hold the power button for 2 seconds. The system will re-start.

BASIC OPERATION

To Power On

Power Button

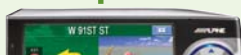

- 1 Press and hold Power Button for 2 seconds.



- 2 Opening screen appears.

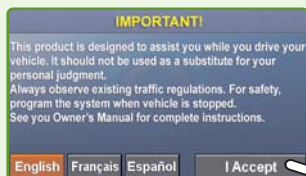

- 3 Read carefully. Touch **I Accept** to display map.



- 4 The last-known current location is indicated on the map.

To Power Off

Press and hold Power Button for 2 seconds.

Set a Destination and Go!



- 1 Touch **Main Menu**. Select **Destination** from Main Menu, or press Destination button.

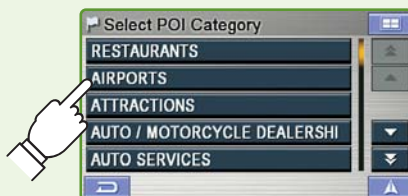

- 4 Scroll the list. Select desired category. (In this example, **AIRPORTS** is selected.)

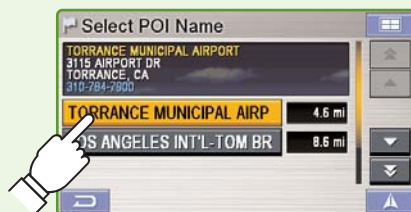

- 7 Select the place with correct address.

For Map Function, see page 12.

The following example briefly describes how to input a destination.

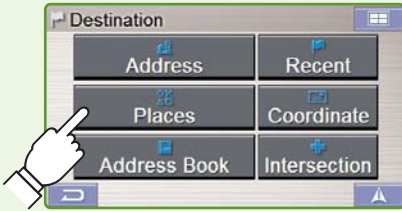

- 2 Select desired method.
(In this example, **Places** is selected.)



- 3 Select a search method.
(In this example, **By POI Category** is selected.)



- 5 Select the search method.
(In this example, **By POI Name** is selected.)

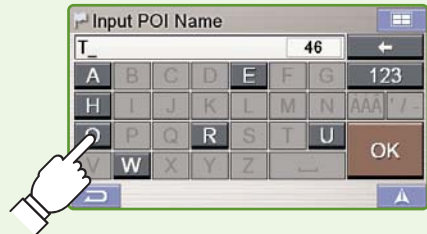

- 6 Type name of a place.
If more than one place with the same name exist, sort method screen appears.

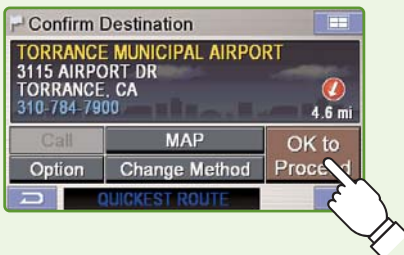

- 8 Select **OK to Proceed** to set the destination.



- 9 Map is displayed.
Follow the navigation.

To Go Home, see page 22.

To Find other routes, see page 23.

MAP FUNCTION



Setting Estimate Time Display



Click this icon to switch between Estimated Time Remaining and Estimated Time of Arrival.

Note: The time estimates are based on the average speed. The estimate time will vary depending on vehicle speed. The arrow always points toward the destination.

Setting the Map Orientation

Click icon to switch between North up, Heading Up and 3D Views.



North Up

In north up view, north is always at the top of the display. This makes it easy to determine your current heading with respect to the map.



Heading Up

In heading-up view, the current direction is always pointing to the top of the display. This makes it easy to see the direction of the next turn on the map.



3D View

The 3D View offers you a more realistic perspective by tilting the map and displaying it with a horizon line. Streets are displayed as you approach them instead of from a birds-eye view.

Repeating the Announcement



Click icon to repeat the guide announcement.

Zoom In/Out Map



Click icon to display scroll bar.



Touch ▲▼ or blue bar to zoom the map in or out. The scroll bar disappears automatically after 2 seconds.

GPS Status



Click icon to view GPS receiving condition information from satellite.

Battery Status



Shows status of the battery. (Lightning bolt) indicates that the battery is currently being charged.



(3 bars) indicates that the battery has more than 60% charge. (2 bars) indicates that the battery has more than 40% charge. (1 bar) indicates that the battery has about 10% charge remaining.



■ Setting a Destination Directly from Map Display

1 Touch anywhere on map screen.
The current location arrow changes to Crosshair Cursor on the screen.

2 Move the cursor to the new desired street.
Note: Use Map Scale Bar to zoom out the map if the destination is far from the current location.

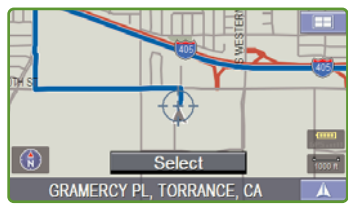

3 Touch **Select**
4 Select **Set as Destination**.

5 Touch **OK to Proceed** on the confirmation screen.
Note: To use other functions on the confirmation screen, see page 14 for details.

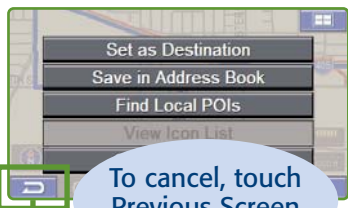

To cancel, touch Previous Screen icon.



Switching Map Display

Touch the Current Position  to switch between Map and Arrow modes.



Map Mode

Shows a full-screen map of the area while providing turn-by-turn guidance prompts.



Arrow Mode

Displays three-successive arrow maneuvers all the way to your destination while providing turn-by-turn guidance prompts.



Split Arrow/Map Mode

Displays a large arrow and larger next-street-name font along side a map screen while providing turn-by-turn guidance prompts.

DESTINATION

■ Setting a Destination by Address

- 1 Go to **Main Menu** 
→ **Destination**  → **Address** 



Finding a Destination by Street Name First

- 2 Select **Input Street Name**.
- 3 Type the first characters of the street name and touch **OK**.
If there are unique matches, the system will automatically display a short list of street names. Type only the name of the street. Prefix and suffix of the street are not necessary. The list of applicable street names appears.
- 4 Select the desired street name from the list.
- 5 Type the address number and touch **OK**.
- 6 Select the desired city.
If there are multiple matches, the system will list cities containing the street name and address number that you keyed in.
- 7 Confirmation screen appears.
See below for details.

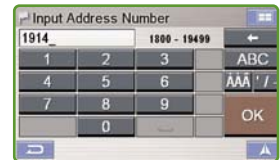

■ Confirm Destination Screen

OK to Proceed

Set the destination and display a map.



Change Method

Find an alternative way. (Refer to page 22.)



Option

Find Local POI → P20
Set as Waypoint → P21
Save in Address Book → P20

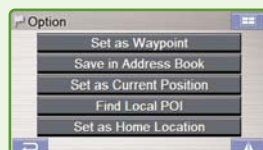

Changing State

If you want to choose a different state from the one shown on the screen, touch **Change** to switch to a different state.



Selecting Letters

Selected characters are displayed.

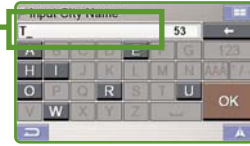

- Delete one letter
- Add one space
- Type numbers
- Type accented characters
- Type punctuation marks

Finding a Destination by City Name First

- 2 Select **Input City Name**.
- 3 Type the first few characters of the city name and press **OK**.

If there are unique matches, the system will automatically display a short list of city names. Select the desired city.

- 4 Type the characters of the street name. Touch **OK**.

The list of applicable street names appears. Select the desired street.

- 5 Type the address number and touch **OK**.
- 6 Confirmation screen appears. See below for details.

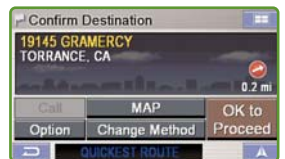
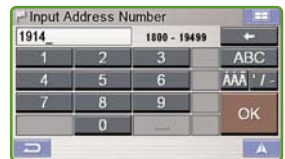

Map

Check the destination on the map. Touch to go back to the confirmation screen.



Call

(Only available on POIs and address book) If the phone number is available, you can call the selected location using your Bluetooth enable mobile phone.

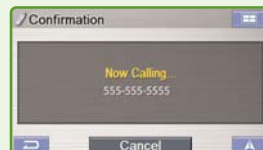

DESTINATION

■ Setting a Destination by POI

You can select from approximately 6 Million Point-of-Interest (POI) locations stored inside your Blackbird Portable Navigation System. These destinations are sorted by POI Name or by POI Category and are listed in order of distance from your current location.

- 1 Go to **Main Menu** 
→ **Destination**  → **Places** 



Finding a Destination by POI Name

- 2 Select **By POI Name**.
- 3 Type the desired place name. Touch **OK**.
A list of place names appears.
Note: You can also perform a Keyword Search by entering a portion of your desired place name. The list of destinations that appears will include all place names containing the keyword you entered.
- 4 Use the arrows to the right of the list to move the yellow highlight.
This will show detailed address information and phone number (if available) for each entry in the Places database.
- 5 Select the place with correct address.
For emergency locations such as Police Stations, Hospitals, etc., please verify availability before proceeding to such locations.
- 6 Confirmation screen appears. Touch **OK to Proceed** to set the destination and start guidance.



Finding a Destination by POI Category

- 2 Select **By POI Category**.
- 3 Select a desired POI Category.
There are 37 POI categories to choose from including ATMs, Banks, Gas Stations, Grocery Stores, Hotels, Parking Lots, Restaurants and more.
- 4 Select Search Method.

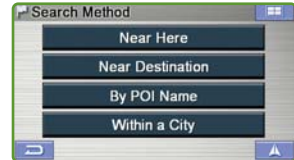

Sort by Distance

- 5 Touch **Near Here** to see the list of place from the current vehicle position or touch **Near Destination** to see the list near your destination.
- 6 Select the place → **OK to Proceed**

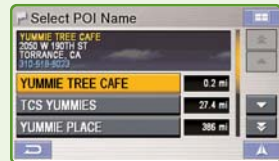

By POI Name



- 5 Follow 3 to 5 in “Finding a Destination by POI Name” on Page 16.

Within a City

- 5 Type the city name and select a city.
- 6 The list of POIs appears in order of the distance from the selected city. Select the desired place.
- 7 Touch **OK to Proceed** on the confirmation screen.



Setting a Destination from the Address Book

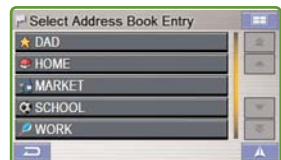

- 1 Go to **Main Menu** 
 - **Destination** 
 - **Address Book**
- 2 Select the desired destination.
- 3 Confirmation screen appears.



Touch **OK to Proceed** to set your destination and start receiving turn-by-turn navigation instructions. To save an address in the address book, see page 20.

DESTINATION



■ Setting a Destination by Recently Entered Destination

- 1 Go to **Main Menu** 
 - **Destination** 
 - **Recent** 



- 2 The list of recent destinations appears.
Select the destination.
- 3 Confirmation screen appears.
Touch **OK to Proceed** to set the destination and start guidance.
Note: To use other functions on the confirmation screen, see page 14 for details.

■ Setting a Destination by Coordinates

- 1 Go to **Main Menu** 
 - **Destination** 
 - **Coordinate** 



- 2 Enter the Latitude of your destination.
Touch **OK**.
- 3 Enter the Longitude of your destination.
Touch **OK**.
- 4 Confirmation screen appears.
Touch **OK to Proceed** to set the destination and start guidance.



■ Setting a Destination by Intersection

- 1 Go to **Main Menu** 
 - **Destination** 
 - **Intersection** 



Finding a Destination by Street Name

- 2 Select **Input Street Name**.
- 3 Type in the street name.
Touch **OK**.
The list of applicable street names appears.
Select the desired street.
- 4 Input the second street name.
If there is only one street crossing with the first street, the name of the street automatically appears.
Confirm City name if there are more than 1 cities with the same intersection.
- 5 Confirmation screen appears.
Touch **OK to Proceed**.

Note: To use other functions on the confirmation screen, see the bottom of page 14 for details.



Finding a Destination by City Name

If you know the city name of the intersection you are searching, select Input City Name. The choice of the street is narrowed down automatically. This saves time in entering the street information.

- 2 Select **Input City Name**.
- 3 Type the city name, then select the city from the list.
- 4 Input the first street name.
- 5 Input the second street name.
- 6 Touch **OK to Proceed** on the confirmation screen.

OPTIONS

■ Find Local Places

The navigation system can display Points of Interest (POI) around the cursor position, when you scroll the map. As with POI categories, with the local places search you can choose from 37 categories including ATMS, Banks, Gas Stations, Grocery Stores, Hotels, Parking Lots, Restaurants and more.

How to Find Local POIs Directly from the Map

- 1 Touch anywhere on map screen.

The current location arrow changes to cross hair cursor on the screen.

- 2 Touch **Select**
- 3 Select **Find Local POIs** and the desired category.
- 4 Select the desired place.



- 5 Touch **OK to Proceed** on the confirmation screen.

Note: To use other functions on the confirmation screen, see page 14 for details.

How to Find Local Places from the Destination Menu

You can also find local places from the Destination Menu.

- 1 Set a destination first from **Destination**
- 2 On the confirmation screen, touch **Option**.
- 3 Follow steps 3 to 5 above in "How to Find Local POIs Directly from the Map".

■ Saving a Destination into the Address Book

Any destination can be saved into the Address Book.

- 1 Select a destination using any method.
- 2 From the confirmation screen, select **Option**.
- 3 Touch **Save in Address Book**.
- 4 "Input Name" screen appears.

Type the desired name and touch **OK**.

Note: For the details of selecting letters, see page 15.

- 5 System returns to the Main Menu screen.

Note: To display the saved destination on the map, see page 17, "Setting a Destination from the Address Book". Address book can hold up to 500 entries.

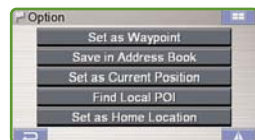

■ Setting Waypoints

You can set up to 10 waypoints between your current location and your destination. The final destination must be set before entering any waypoints.

How to Set a Waypoint Directly from Map

- 1 Touch anywhere on map screen.
The current location arrow changes to cross hair cursor on the screen.
- 2 Move the cursor to the desired waypoint.
- 3 Touch **Select**
- 4 Select **Set as Waypoint** then select **Recalculate**.
- 5 When the route search is complete, the current location is displayed. The map navigates you to the first waypoint.

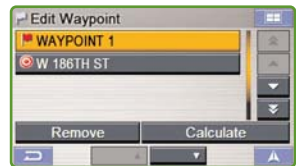
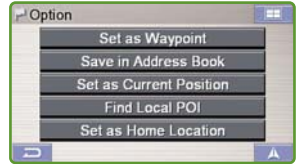

How to Set a Waypoint from the Destination Menu

You can also find local places from Destination Menu.



- 1 Enter your desired destination by using the method on pages 14 through 19 from Destination Menu.
- 2 On the confirmation screen, select **Option**.
- 3 Select **Set as Waypoint** and select **Recalculate**.

How to Set a Waypoint from the Address Book

- 1 Enter in a destination from the Address Book. (see page 17)
- 2 At the confirmation screen, touch **Option** → **Set as Waypoint**.
- 3 Touch **Recalculate** to recalculate a route which includes your waypoint.

■ Set Destination as Home

You can get home from anywhere once the home address is set from Edit Menu.

- 1 Go to **Main Menu**  → **Home** 
- 2 Touch **OK to Proceed** on the confirmation screen.
- 3 Follow the map and go home.



To edit the Home Address, See Page 24.

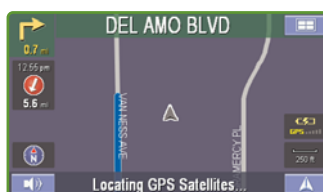

■ Finding Alternate Way to Go Home

Go to **Main Menu**  → **Home**  → **Change Method**

- Quickest Route, Maximize Freeway
- Quickest Route, Minimize Freeway
- Shortest Route
- With/Without Ferry
- With/Without Toll Road



■ One-Touch Go Home

For an even easier way to immediately get guidance instructions to your home, you can press and hold the flag  on the circle key for 2 seconds. This will instantly display the destination confirmation screen and guide you to your home location.



■ Recalling the Maneuver List during Guidance

You can view a list of street names and upcoming turns and streets.

1 Go to **Main Menu**

→ **Route**

2 Touch **Maneuver List**.

3 List of upcoming streets and turns appears on the screen.



To preview a specific point, select a street name/maneuver on the list.

To go back to Route List,

Go to **Main Menu**

→ **Route**

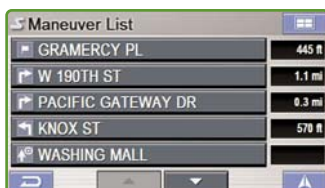

Note: For the details of setting Waypoints, see page 21.

■ Finding Alternate Route

Touch **Main Menu**

→ **Route**

→ **Change Method**

You can choose and re-calculate a different route based on Quickest Route with Maximize/Minimize Freeway, Shortest Route, with/without Ferry and/or Toll Road.

■ Finding Detour

Touch **Main Menu**

→ **Route**

→ **Detour**

The system automatically calculates and displays detour.

■ Delete Route

Go to **Main Menu** → **Route**

→ **Delete** → **Yes**

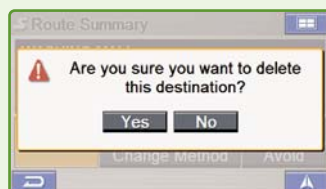

Note: After deleting the destination, you can not select Route Menu until the next destination is set. To set up the destination, see Destination Menu on Page 14.



EDIT

Locations and Home addresses saved in the Address Book can be edited for quick recall. Also information including phone numbers and icons can be modified.

■ Editing Home

- 1 Go to **Main Menu** 
→ **Edit** 
- 2 Touch **Edit Home**.
- 3 “Edit Home” screen appears.
See below for details.

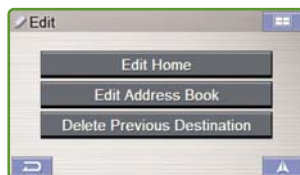

Name Touch **Name** to change the display name of the stored location.

Note: For the details of selecting letters, see page 15.

Tel Touch **Tel** to change the telephone number of the stored location.

Map Touch **Map** to preview the location on the map.

To go back to Edit Menu,

Main Menu  → **Edit** 

Delete Touch **Delete** to delete the stored location.

Icon Touch **Icon** to change the icon of the stored location on the map.

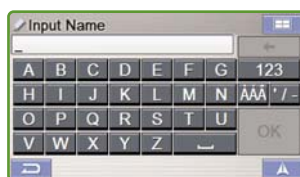

Input Name Screen

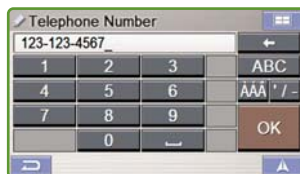

Edit Telephone Screen





Change Icon Screen





Delete Screen

■ Editing Address Book

- 1 Go to **Main Menu**  → **Edit** 
- 2 Touch **Edit Address Book**
- 3 The list of addresses appears.
Select the destination you need to modify.
- 4 “Edit Address Item” screen appears. See below for details.

Note: Select **DELETE ALL** to delete all addresses saved in the address book.

■ Deleting Previously Saved Destinations

- 1 Go to **Main Menu**  → **Edit** 
- 2 Touch **Delete Previous Destination**.
- 3 Select destination you need to delete.
- 4 Touch **YES** to delete the destination on the confirmation screen.



Note: Select **DELETE ALL** to delete all recently entered destinations.

TRAFFIC

■ Viewing Traffic Incident List

If you have an activated subscription to the NAVTEQ traffic service, the Traffic Incident List screen allows you to view traffic information in your current area, or along your current route.

Note: Traffic feature is only available when Blackbird is placed in the supplied cradle or the docking station. (The docking station is sold separately.)

1 To access the Traffic Incident List screen from the Main Menu, touch **Information**  and **Traffic Info**, or from the map screen, touch **Traffic**  located on the left side of the screen.

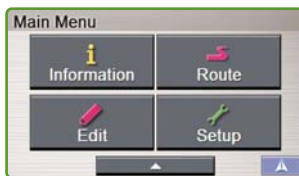

2 Traffic Incident List screen appears and provides a list of traffic incidents in your current area or along your current route. You have a number of ways to use the information on this screen. These options are detailed below:



Touch **By Distance** to view traffic incidents sorted by distance from your current location. To sort the list by the type of traffic incident, select **By Name**. Select **On Route** to display only those incidents occurring along the current route to your destination. When an incident occurs on your route, traffic icon on the Map screen turns to red.



■ Viewing Traffic Incident Detail

To view the details of a traffic incident, touch a specific traffic incident in the list.

Note: The detail information may be identical to the summary information.



■ Viewing Incident Location

You can display the location of a traffic incident on the map by touching the crosshairs icon .



Calculating a Detour

To have the system analyze the traffic data within 30 miles of your current location, touch **Detour** in the route menu. If an incident occurs along your route, a screen will appear where you can choose to detour around either the traffic incident or the next street.

Viewing Traffic Icon Legend

You can view a list of all icons related to a traffic incident by touching **Legend**. A list of icons and their definitions will be displayed.

Note: If you have the system set to display traffic speed and flow icons on the map (see Page 32), both the traffic incident icons and traffic speed and flow icons, with their definitions, will be displayed.



MOBILE PHONE

Most Bluetooth enabled mobile phones can be synchronized to interface with Blackbird. Once you have paired and synchronized your mobile phone with Blackbird (see Setup on page 34) you can place and receive calls in addition to many other convenient functions. Some Bluetooth enabled phones may not be compatible and some features may not be available even after synchronizing and pairing.

Note: It may take a few minutes for information to transfer from your phone to the Blackbird.

■ Placing Calls

- 1 Touch **Main Menu** 
- 2 Touch **Mobile Phone**.

Using the 12 key Dial Pad

- 3 Touch **Dial**.
- 4 Enter the number and touch **Call**.

Using your Phonebook

(If your phone has been synchronized. See setup instructions on page 34.)

- 3 Touch **Phonebook**.
- 4 Begin entering the name of the contact you wish to call.
A list will appear.
- 5 Select the desired contact from the list.
Confirmation screen appears with the contact's detailed information.
- 6 Touch **Dial** to place the call.

Using Dialed, Missed, or Received Calls from your call history

- 3 Touch **Dialed Calls**, **Missed Calls**, or **Received Calls**.
A list of your call history will appear.
- 4 Select the desired contact from the list. Confirmation screen appears with the contact's detailed information if available.
- 5 Touch **Dial** to place the call.

Note: You can continue to use Blackbird during an active call. Touch the icons to jump to the Map or Main Menu screens. Touch the red phone icon to return to the call menu.

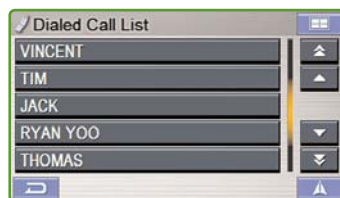
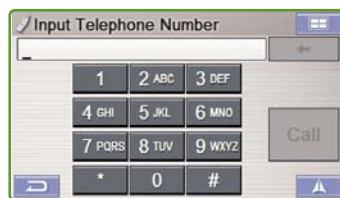

■ Receiving Calls

When your mobile phone is actively paired with Blackbird, a popup window will appear when you have an incoming call. The caller ID number will be displayed when available. Touch **Answer** to accept the call or **Ignore** to ignore it.

■ Call Option Menu

During an active call touch the red phone icon to access the Call Option Menu. This menu displays the Caller ID Name, Phone Number, and Call Duration. The following options are also available from this menu:

Mute

This allows you to temporarily mute the microphone so you can still hear the caller, but the caller cannot hear you.

Transfer Call to Phone

You can transfer the call from the Blackbird to your mobile phone for greater flexibility.



End Call

This ends the current phone call.

Note: After ending a call you will automatically be returned to the previous menu.



SETUP

You can customize Display, Guidance, Clock, Measuring Unit and FM frequency settings from the Setup Menu.

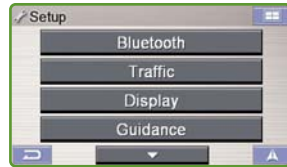
- 1 Go to **Main Menu** 
- 2 Select **Setup** 
- 3 Setup screen appears.



■ Customizing Display

- Go to **Main Menu** 
→ **Setup** 
→ **Display**

Brightness

The brightness of the screen can be adjusted.

Setting the Map Color

- Day - a bright tone screen
- Night - a dark tone screen
- Auto - switches automatically between Day and Night modes

Map Style

- 1 - Geographic features displayed in light colors (Default)
- 2 - Geographic features displayed in dark colors

Displaying and Editing Icons on the Map

POI Icons, the Home Icon and Icons used in the Address Book can be turned on and off from the Display Setup Menu. You can also change these icons.



Trail

The Trail feature allows you to turn on and off trail dots that appear wherever the vehicle icon traverses. This is especially helpful for off-road enthusiasts.

Background Color

You can choose between gray or blue backgrounds for all menu screens.

Display Adjustment

The Adjust button is active only when Blackbird is docked. It will allow you to make minor alignment adjustments (up/down/left/right) to the display of the docked image.

■ Customizing Guidance

Turning Voice On and Off

This allows you to turn ON or OFF guidance voice prompts.

Changing Navi Mix Volume

This allows you to vary the volume of the voice prompts with respect to the music.

Setting Estimate Time Display

Estimated Time of Arrival (ETA) or Estimated Time Remaining (ETR) can be set here. You can also change between ETA and ETR directly in the map screen. See page 12.



■ Setting up the Clock

You can set the Time Zone and Daylight saving setting to fit your region.

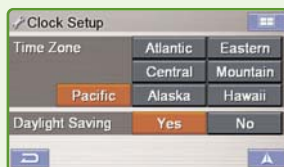

■ Changing Unit of Measure

You can choose the unit of measure between Miles and Kilometers.



■ Configuring System Settings

FM Transmitter Setup

When set to ON, the FM Transmitter broadcasts music and voice prompts (if set to ON) to an available frequency on your FM car radio. See page 39.

Frequency

Allows you to change the frequency to find the best available station for broadcasting audio to your FM radio. See page 39.

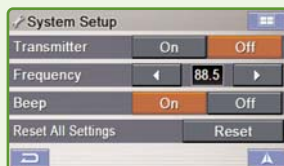

■ Customizing Traffic Information

You can choose the way your traffic and navigation information is displayed using the traffic information setup controls.

1 Go to **Main Menu** 

2 Select **Setup** 

3 Select **Traffic** 

The Traffic Setup menu appears and displays the system status and traffic setup options.

Use the large arrow button at the bottom of the screen to view additional options. All traffic setup options are detailed below:



System Status

System Status displays the strength of the signal being received. To improve the signal strength, please see page 40.

Traffic Reroute

ON: When a traffic incident occurs on the way to the destination, a pop-up window will appear on the screen and ask you if you want to take a different route.

OFF: No action will be taken based upon traffic incidents and the current route will not be effected.



Displaying Traffic Icons

When the system receives traffic incident information it can display the information on the map screen using icons in several shapes and colors. To the right of **Icon**, touch **Show** or **Hide** to make your selection.

Show: The selected traffic incident icons will be displayed on the map.

Hide: No traffic incident icons will be displayed on the map.

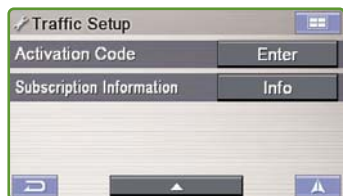

When **Show** is selected, you can choose which types of traffic incident icons are displayed:

- 1 Touch **Edit**.
- 2 An icon list appears. Traffic incident icons shown with a checkmark will be included on the map. You can select (or de-select) the types of traffic icons you wish to display.
- 3 Touch **Done** to save your selections.

Touch **Default** to display all traffic incident icons.

Displaying Traffic Speed and Flow Icons

You can choose whether or not the system displays traffic speed and flow information as icons on the map screen when the information is received. To the right of **Speed Flow**, touch **Show** or **Hide** to make your selection.

Show: Traffic flow icons will be displayed on the map when viewing at a scale of 2 miles/4 kilometers or less.

Hide: No traffic flow icons will be displayed on the map.

Note: Not all area has traffic flow information. Please check <http://www.blackbirdtraffic.com> for more detail.

Activating Subscription

You will receive an activation code when you complete the traffic subscription process. To the right of **Activation Code**, touch **Enter** then input your activation code. To subscribe to NAVTEQ Traffic RDS Services, please visit: <http://www.blackbirdtraffic.com>

Viewing Subscription Information

You can easily view how many days you have remaining on your current traffic subscription. To the right of **Subscription Information**, touch **Info**.

Bluetooth Setup

Bluetooth enabled mobile phones can be paired to interface with Blackbird. You can customize this interface using the Bluetooth Setup controls.

- 1 Go to **Main Menu** 
- 2 Select **Setup** 
- 3 Select **Bluetooth**.

The Bluetooth Setup menu appears and displays the setup options. Use the large arrow button at the bottom of the screen to view additional options. All Bluetooth setup options are detailed below.

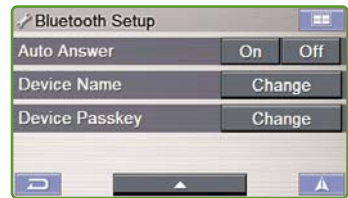

Turning Bluetooth On and Off

This allows you to turn the Bluetooth functionality on or off.

Starting Discover Mode

Discover Mode allows your mobile phone to pair with Blackbird. Start Discover mode to begin the initial pairing process. Follow your individual phone's instructions for pairing.

Auto Connect

Turning Auto Connect on will allow the last connected phone to automatically connect with the Blackbird whenever they are in range and both have Bluetooth turned on.

Auto Answer

This allows Blackbird to automatically answer all incoming calls for you after the first ring.

Changing Device Name

Blackbird's display name can be set here by selecting **Change**.



Changing Device Passkey

The passkey used to pair Blackbird with your mobile phone can be changed here.

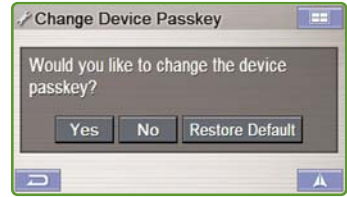

Bluetooth Indicator Light

When Blackbird is seated in its cradle, or is being used in handheld mode, the smaller blue LED light surrounding the inner ring of the navigation wheel will indicate the Bluetooth condition as follows:

Discovery Mode	When Discovery Mode is activated the light will flash for 30 seconds.
Bluetooth Connected	When Bluetooth is on and connected the light will remain on.
Incoming Call	Three quick flashes indicate an incoming call.
Active Call	The light will continue to slowly pulse during an active call.

Pairing Your Bluetooth Enabled Mobile Phone



- 1 Go to Bluetooth Setup and power on Bluetooth.
- 2 Start Discover Mode.
- 3 On your mobile phone, make sure Bluetooth is on, then search for Bluetooth devices.
- 4 Select Blackbird and enter the passkey shown on the Blackbird screen.
- 5 The inner ring of the navigation wheel on your Blackbird should remain on, indicating your mobile phone is connected.

INFORMATION

■ Simulating Navigation



You can watch a demonstration of the navigation system's voice and screen guidance. Note: Set your destination first before using this function.

To Start a Demonstration

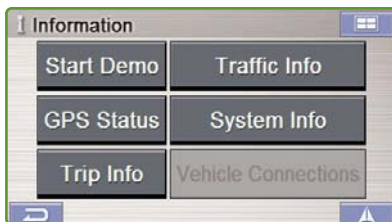
- 1 Setup a route.
- 2 Go to **Main Menu** 
- 3 Select **Information** 
- 4 Select **Start Demo**.
- 5 Demonstration starts.



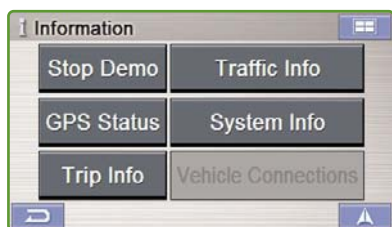

To Stop a Demonstration

- 1 Go to **Main Menu** 
- 2 Select **Information** 
- 3 Select **Stop Demo**.
- 4 The demonstration will end.



■ Viewing Trip Information

The odometer displays the route distance and time traveled.

- 1 Go to **Main Menu** 
→ **Information** 
- 2 Select **Trip Info**.

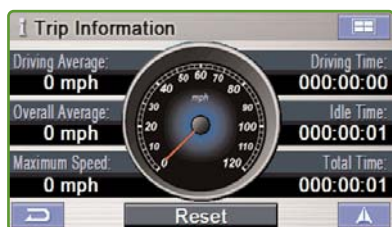



Driving Average	Average speed since Trip Info was reset.
Overall Average	Average speed since start of trip.
Maximum Speed	Maximum speed reached on this trip.
Driving Time	Time vehicle has been moving since the trip was reset.
Idle Time	Time vehicle has been stopped (not moving) since the trip was reset.
Total Time	Total elapsed time on the trip which is always the driving time plus idle time

■ Viewing GPS Status

You can view the dynamic location information received from satellite such as signal strength, compass (direction information), latitude/longitude, approximate altitude, and speed. This feature allows you to view GPS satellite signal information. An explanation of the messages is shown below.



- 1 Go to **Main Menu** 
 - **Information** 
- 2 Select **GPS Status**.

The following messages are displayed while the GPS receiver is tracking satellites:

“Locating GPS Satellites”: Blackbird searches the sky looking for GPS satellites.

“Acquiring GPS Signal”: Blackbird acquires positioning information transmitted from 1 to 3 tracked satellites while searching for more satellites (minimum 4 needed).

“Fixing GPS Position”: Blackbird requires continuous signals from 4 or more tracked satellites (for 30 seconds) in order to accurately fix your position.

“Temporary Poor GPS Coverage”:

Thunderstorms, dense foliage or surrounding tall buildings may cause temporary loss of position fix (acceptable if under 30 seconds).

“Poor GPS Signal, Lost Position Fix”:

You may have entered an area where consistently poor GPS signal (lasting 30 seconds or more) makes it impossible to maintain a position fix.



“No Line of Sight, Lost GPS Tracking”:

You are in an area where line of sight to GPS satellites has been blocked.

■ Viewing System Information

You can check software application, database version, and other information in this screen. Make a note of this information and refer to it whenever you communicate with Alpine Tech Support or your Alpine authorized dealer.



- 1 Go to **Main Menu** 
 - **Information** 
- 2 Select **System Info**.

■ Playing Music from Your Blackbird

You can play MP3 or WMA music files* from your SD or MMC card. Your music can be arranged in sub-folders for easy retrieval when using your Blackbird device.

*Blackbird only supports MP3 and WMA files without DRM.

- 1 Insert an SD or MMC card containing folders with music files in the SD/MMC slot. The system will scan for music.
- 2 Touch **Folder Search**  to search the memory card.
- 3 Select a folder, then select a song to play. The music will start playing the song you selected.

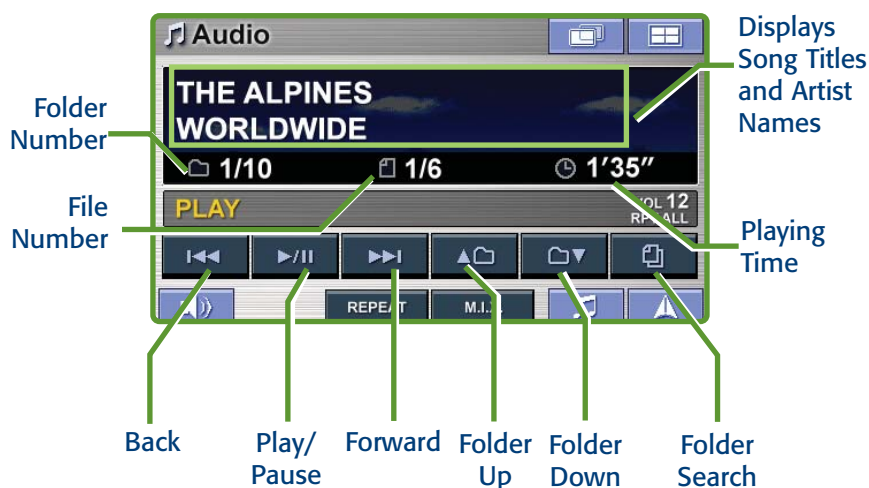

M.I.X.

Touch **M.I.X.** to shuffle songs.
Touch **M.I.X.** again to cancel the shuffle.

REPEAT

Touch **REPEAT** to repeat songs.
Touch **REPEAT** again to cancel the repeat.

■ How to Listen to Guidance and Music from Your Car Stereo

Turning on the Transmitter and Playing Music from Your Radio

You can setup Blackbird to broadcast music and navigation voice guidance directly to an unused FM radio station.

- 1 Plug the cradle into your vehicle's cigarette lighter/power outlet.
- 2 Insert Blackbird into the cradle (See page 8 for details).
- 3 Turn on your radio. Find an FM frequency from the following that is broadcasting nothing but static: 88.3 MHz, 88.5 MHz, 88.7 MHz, 88.9 MHz, 106.7MHz, 106.9 MHz, 107.1 MHz, 107.3 MHz, 107.5 MHz, 107.7 MHz (do this with Blackbird off at first).
- 4 Turn on Blackbird.
- 5 On Blackbird, go to **Main Menu → Setup → System**. The default broadcast frequency is 88.3 MHz.
- 6 Turn the transmitter button ON in System Setup screen.
- 7 Set Blackbird to that frequency and play music files on Blackbird. (Touch **Main Menu → Entertainment**, or simply press Music button) Blackbird provides 12 frequencies to choose from. You may have to try a few frequencies before you find one that works best in your vehicle.

Turning Off the Transmitter

- 1 Turn off or turn down the volume of your radio first to avoid the static noise.
- 2 On Blackbird, go to **Main Menu → Setup → System**.
- 3 Turn the transmitter button OFF in System Setup screen.

■ How to Update the New Software and Map Database

Using your home PC, Blackbird can be updated with the latest mapping and Point of Interest information. Please refer to instructions included with the update software on how to upgrade your Blackbird system. For additional information on the update software, please contact Alpine.

IN CASE OF DIFFICULTY

If you encounter a problem, please review the items in the following checklist. This guide will help you isolate the problem if the unit is at fault. Otherwise make sure the rest of your system is properly connected, batteries are completely charged and contact your authorized Alpine dealer or Alpine directly at 1-888-NAV-HELP (1-888-628-4357).

Unable to play Music from SD card.

Some SD card may be not compatible with Blackbird.

Unable to use Phone feature.

Some Bluetooth enabled phones may not be compatible and some features may not be available even after synchronizing and pairing.

The vehicle's position is erroneous.

Reset the unit and drive the vehicle in an area of good GPS reception to allow the unit to recalibrate itself. Move to a location where strong GPS reception is possible.

No operation

- Moisture condensation → Allow enough time for the condensation to evaporate (about 1 hour).
- Ambient temperature over 113°F (45°C) → Lower the temperature in the vehicle to below 113°F (45°C) by driving with the windows open or air conditioner on.
- Blown fuse → Replace with a fuse of the prescribed rating. (2A glass-type fuse located in the head of the cigarette lighter adapter)

Unit does not work after removing from cradle or dock

*Make sure battery is fully charged. Unit does not charge in cradle or dock while the car is not on.

The unit is taking a long time to acquire GPS signal.

It may take a long time for the unit to acquire GPS signal if it has been powered on in an area that is more than 200 miles from the area where it was last powered off. Following these steps will speed the process by resetting the GPS receiver:

- 1 Go to **GPS Status** screen. (See instructions on page 37)
- 2 Press and hold the Down Arrow (Map Zoom Out Button) for 2 seconds.
- 3 A message appears to indicate that the GPS receiver is resetting.



Low RDS Traffic Signal (for Traffic Service Users)

In order to improve the RDS Traffic signal strength, you may need to separate the RDS antenna away from the power cord on the Cradle. Carefully follow these instructions:

- 1 Power off the unit and unplug the Cigarette Lighter Charger.
- 2 Identify the RDS antenna. It is the thin, black, insulated wire that runs the full length of the thicker power cord. (See diagram on page 7)
- 3 Carefully cut the thin RDS antenna at the point where it enters the connector that attaches it to the Cigarette Lighter Charger. Be careful to ONLY cut the antenna, not the larger main power cable.
- 4 Slowly peel the antenna away from the power cord to leave about 50 inches of the antenna separated and hanging free.
- 5 Place antenna on the vehicle dashboard or for best results, mount the antenna to the windshield using the provided suction cups. (please see suction cup instructions for details)

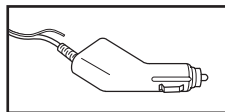

IN THE BOX

■ Accessories

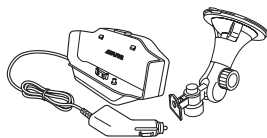

Cradle with Cigarette Lighter Charger

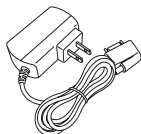

AC Adapter

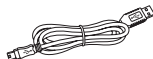

USB Cable

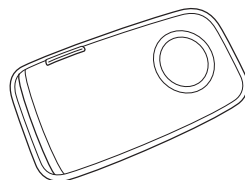

Carrying Case

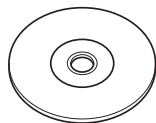

Owner's Manual CD



Quick Reference Guide

- Dummy SD Card (Inside Main Unit)
- Registration Card
- Cradle Mounting Plate
- External GPS Antenna
- External Microphone

■ Optional Accessories

The following accessories are available from your authorized Alpine dealer.

1. **IVA-W205** – An Alpine AV head unit with a built-in dock to integrate your Blackbird as a part of your vehicle.
2. **PMD-DOK2** – A Docking Station that allows you to connect and experience Blackbird navigation and music player from your Alpine Multimedia Station or stand-alone display.
3. **PMD-KIT2** – A second car kit comprised of windshield mount, cradle, and home AC charger.
4. **PMD-ANT1** – An external GPS antenna hard-wired to Blackbird used in instances where you cannot normally receive GPS signals inside the car, due to metallic window tint, etc.
5. **PMD-BAT2** – A 1100 mAh Li-Polymer battery for extra battery power on the go.
6. **RUE-4140** – A combination navigation and audio remote control that allows you to control most of Blackbird's navigation features wirelessly.

SPECIFICATIONS

Main Unit Size	6.1" x 2.9" x 1.2" (145mm x 74mm x 29mm)
Main Unit Weight	8 oz (227 g)
CPU	Centrality Atlas II ARM9 CPU
GPS	Embedded 16 channel GPS, Built-In Main Unit Antenna with Optional External Antenna Connection
Storage Media	Built-In flash memory with Pre-Loaded Maps of US* and Canada and 6 Million Points of Interest Locations
Card Slot	Secure Digital (SD) or Multimedia Card (MMC) for playback of MP3 or WMA music files
Audio	Integrated speaker in main unit, amplified speaker in cradle, stereo headphone jack, optional docking station audio output
FM Transmitter	Built-in cradle, up to 10 selectable frequencies
RDS-TMC Tuner	Built-in main unit w/antenna in cradle power cable
USB Interface	2.0
Power Requirements	
Handheld Mode	5V @ 1A (via 1200 mAh Li-Polymer Battery, approximately 2 hours of continuous use)
Cradle Mode	12 VDC @ 2A (via Cigarette Lighter Adapter)
Fuse	AGC/3AG -2Amp
Operating Temp	32° to 140° F (0° to +60°C)
Storage Temp	-13° F to 158° F (-25° to 70° C)
Display Screen Size	4.0" diagonal
Resolution	QWVGA 480 x 272 pixels
Display Type	Digital TFT display with anti-glare touch screen
Brightness	320 nits (typical)

Note: Due to continuous product improvement, specifications are subject to change without notice.

INDEX

A				
Accessories	41	Editing	24	Simulating Navigation
Address book	20	Finding a Way	22	Specifications
Announcement	12	Finding Alternate Way	22	Subscription
		One-Touch Go Home	22	System
B				Features
Background Color	30	I		Information
Basic Operation	10	Icon	24, 27	Settings
Battery		In Case of Difficulty	40	Status
Status	12	Incident Location	26	
Bluetooth	28, 34	Index	43	T
Setup	34	Information	36	Table of Contents
Brightness	30	GPS Status	37	Traffic
		Simulating Navigation	36	Icon Legend
		System Information	37	Icons
		Trip Information	36	Incident Detail
C		Installation	8	Incident List
Call	28, 29			Reroute
Ending	29	M		Speed and Flow Icons
Muting	29	Maneuver List		Subscription
Placing	28	Recalling during Guidance	23	Trail
Receiving	29	Map Color	30	Trip Information
Clock	31	Map Display	13	Troubleshooting
Confirm Destination Screen	14	Map Function	12	
Coordinates	18	Announcement	12	U
Cradle	7, 8	Battery Status	12	Update
Customizing		Estimate Time Display	12	User Agreement
Display	30	GPS Status	12	
Guidance	31	Map Display	13	V
Traffic Information	32	Map Orientation	12	Voice
		Set a Destination	13	Volume
D		Zoom In/Out Map	12	
Deleting		Map Orientation	12	W
Route	23	Measuring Unit	31	Warnings
Saved Destination	25	Mounting Blackbird	8	Warranty
Destination		O		Waypoints
Setting by Address	14	One-Touch Go Home	22	
Setting by Coordinates	18	P		Z
Setting by Intersection	19	POI	16, 17	Zoom In/Out Map
Setting by POI	16	Local POI	20	
Setting by Previous Destination	18	Power	10	
Setting from the Address Book	17	Precautions And Notices	2	
Setting From Map Display	13	R		
Detour	23	Repeating the Announcement	12	
Calculating	27	Reset	9	
E		Route	23	
Edit	24	Alternate Route	23	
Address Book	25	Delete Route	23	
Deleting Saved Destination	25	Detour	23	
Home	24	Recalling the Maneuver List during		
Entertainment	38	Guidance	23	
Audio	38	S		
Guidance and Music from Car Stereo	39	Saving a Destination into the Address		
Playing Music	38	Book	20	
Estimate Time Display	12, 31	Set a Destination and Go!	10	
F		Setup	30	
FCC Compliance Statement	2	Clock	31	
FM Transmitter Setup	31	Display	30	
Frequency	31	Guidance	31	
G		Measuring Unit	31	
GPS Status	12, 37	System Settings	31	
H				
Home	22			

LIMITED WARRANTY

ALPINE ELECTRONICS OF AMERICA, INC. AND ALPINE OF CANADA INC. ("Alpine"), are dedicated to quality craftsmanship and are pleased to offer this Warranty. We suggest that you read it thoroughly. Should you have any questions, please contact your Dealer or contact Alpine at one of the telephone numbers listed below.

●PRODUCTS COVERED:

This Warranty covers Car Audio, Navigation Products and Related Accessories ("the product"). Products purchased in the Canada are covered only in the Canada. Products purchased in the U.S.A. are covered only in the U.S.A.

●LENGTH OF WARRANTY:

This Warranty is in effect for one year from the date of the first consumer purchase.

●WHO IS COVERED:

This Warranty only covers the original purchaser of the product, who must reside in the United States, Puerto Rico or Canada.

●WHAT IS COVERED:

This Warranty covers defects in materials or workmanship (parts and labor) in the product.

●WHAT IS NOT COVERED:

This Warranty does not cover the following:

- 1 Damage occurring during shipment of the product to Alpine for repair (claims must be presented to the carrier).
- 2 Damage caused by accident or abuse, including burned voice coils caused by over-driving the speaker (amplifier level is turned up and driven into distortion or clipping).
Speaker mechanical failure (e.g. punctures, tears or rips).
Cracked or damaged LCD panels. Dropped or damaged hard drives.
- 3 Damage caused by negligence, misuse, improper operation or failure to follow instructions contained in the Owner's manual.
- 4 Damage caused by act of God, including without limitation, earthquake, fire, flood, storms or other acts of nature.
Any cost or expense related to the removal or reinstallation of the product.
- 5 Service performed by an unauthorized person, company or association.
- 6 Any product which has the serial number defaced, altered or removed.
- 7 Any product which has been adjusted, altered or modified without Alpine's consent.
- 8 Any product not distributed by Alpine within the United States, Puerto Rico or Canada.
- 9 Any product not purchased from an Authorized Alpine Dealer.

●HOW TO OBTAIN WARRANTY SERVICE:

1 You are responsible for delivery of the product to an Authorized Alpine Service Center or Alpine for repair and for payment of any initial shipping charges. Alpine will, at its option, repair or replace the product with a new or reconditioned product without charge. If the repairs are covered by the warranty, and if the product was shipped to an Authorized Alpine Service Center or Alpine, Alpine will pay the return shipping charges.

2 You should provide a detailed description of the problem(s) for which service is required.

3 You must supply proof of your purchase of the product.

4 You must package the product securely to avoid damage during shipment. To prevent lost packages it is recommended to use a carrier that provides a tracking service.

●HOW WE LIMIT IMPLIED WARRANTIES:

ANY IMPLIED WARRANTIES INCLUDING FITNESS FOR USE AND MERCHANTABILITY ARE LIMITED IN DURATION TO THE PERIOD OF THE EXPRESS WARRANTY SET FORTH ABOVE AND NO PERSON IS AUTHORIZED TO ASSUME FOR ALPINE ANY OTHER LIABILITY IN CONNECTION WITH THE SALE OF THE PRODUCT.

●HOW WE EXCLUDE CERTAIN DAMAGES:

ALPINE EXPRESSLY DISCLAIMS LIABILITY FOR INCIDENTAL AND CONSEQUENTIAL DAMAGES CAUSED BY THE PRODUCT. THE TERM "INCIDENTAL DAMAGES" REFERS TO EXPENSES OF TRANSPORTING THE PRODUCT TO THE ALPINE SERVICE CENTER, LOSS OF THE ORIGINAL PURCHASER'S TIME, LOSS OF THE USE OF THE PRODUCT, BUS FARES, CAR RENTALS OR OTHERS COSTS RELATING TO THE CARE AND CUSTODY OF THE PRODUCT. THE TERM "CONSEQUENTIAL DAMAGES" REFERS TO THE COST OF REPAIRING OR REPLACING OTHER PROPERTY WHICH IS DAMAGED WHEN THIS PRODUCT DOES NOT WORK PROPERLY.

THE REMEDIES PROVIDED UNDER THIS WARRANTY ARE EXCLUSIVE AND IN LIEU OF ALL OTHERS.

●HOW STATE/PROVINCIAL LAW RELATES TO THE WARRANTY:

This Warranty gives you specific legal rights, and you may also have other rights which vary from state to state and province to province. In addition, some states/provinces do not allow limitations on how long an implied warranty lasts, and some do not allow the exclusion or limitation of incidental or consequential damages. Accordingly, limitations as to these matters contained herein may not apply to you.

●IN CANADA ONLY:

This Warranty is not valid unless your Alpine car audio product has been installed in your vehicle by an Authorized Installation Center, and this warranty stamped upon installation by the installation center.

●HOW TO CONTACT CUSTOMER SERVICE:

Should the product require service, please call the following number for your nearest Authorized Alpine Service Center.

CAR AUDIO 1-800-ALPINE-1 (1-800-257-4631)
NAVIGATION 1-888-NAV-HELP (1-888-628-4357)

Or visit our website at: <http://www.alpine-usa.com>

ALPINE ELECTRONICS OF AMERICA, INC.,
19145 Gramercy Place, Torrance, California 90501, U.S.A.

ALPINE ELECTRONICS OF CANADA, INC.,
777 Supertest Road, Toronto, Ontario M3J 2M9, Canada Phone 1-416-736-6211
Do not send products to these addresses.

Call the toll free telephone number or visit the website to locate a service center.

© 2006 NAVTEQ. All Rights Reserved.

© 2006 Alpine Electronics of America, Inc. All Rights Reserved.



Recommended by CEA

The WTR Logo is a trademark of the Consumer Electronics Association.

This device complies with part 15 of the FCC rules. Operation is subject to the following two conditions.

- 1) This device may not cause harmful interference, and
- 2) This device must accept any interference received, including interference that may cause undesired operation.

Per FCC 15.21, you are cautioned that changes or modifications not expressly approved by the part responsible for compliance could void the user's authority to operate the equipment.

“Operation is subject to the following two conditions:(1) this device may not cause interference, and (2) this device must accept any interference, including interference that may cause undesired operation of the device.”

This Class B digital apparatus complies with Canada RSS-210. Cet appareil numérique de la classe B est conforme à la norme CNR -210 du Canada

The abbreviation, IC, before the registration number signifies that registration was performed based on a Declaration of Conformity indicating that Industry Canada technical specifications were met. It does not imply that Industry Canada approved the equipment.(DoC) The term “IC:” before the certification/registration number only signifies that the Industry Canada technical specifications were met.