

**DHu**

**Digital Handheld Transmitter**

Follow  
Us On:



# Table of Contents

<b>General Technical Description</b> .....	3
<b>Microphone Capsules:</b> .....	4
<b>Mechanical Assembly</b> .....	4
<b>Battery Installation</b> .....	5
<b>Control Panel</b> .....	5
<b>Setup and Adjustments</b> .....	6
Powering On .....	6
Powering Off .....	6
Standby Mode .....	6
Power Menu .....	6
Battery Condition .....	7
Navigating Menus and Screens .....	7
<b>Menu Map</b> .....	7
<b>Input Gain Adjustment</b> .....	9
<b>Firmware Update</b> .....	10
<b>Parts and Accessories</b> .....	12
<b>Troubleshooting</b> .....	13
<b>Specifications</b> .....	14
<b>Service and Repair</b> .....	15
Returning Units for Repair .....	15

## CAUTION

**Danger of explosion if battery is incorrectly replaced.  
Replace only with the same or equivalent type.**

### Consumer Alert for US Users - FCC Order DA 10-92

Most users do not need a license to operate this wireless microphone system. Nevertheless, operating this microphone system without a license is subject to certain restrictions: the system may not cause harmful interference; it must operate at a low power level (not in excess of 50 milliwatts); and it has no protection from interference received from any other device. Purchasers should also be aware that the FCC is currently evaluating use of wireless microphone systems, and these rules are subject to change. For more information, call the FCC at 1-888- CALL-FCC (TTY: 1-888-TELL-FCC) or visit the FCC's wireless microphone website at [www.fcc.gov/cgb/wirelessmicrophones](http://www.fcc.gov/cgb/wirelessmicrophones). To operate wireless microphone systems at power greater than 50mW, you must qualify as a Part 74 user and be licensed. If you qualify and wish to apply for a license go to: <http://www.fcc.gov/Forms/Form601/601.html>

# General Technical Description

## Introduction

The DHu handheld transmitter delivers superb audio quality and extended operating range in a pure digital architecture. Interchangeable microphone capsules expand the versatility to suit a wide variety of applications and personal preferences. The superb audio performance and highly reliable RF transmission makes it ideally suited for high end stage and studio production.

## Frequency Selection

The transmitter tunes continuously from 470.100 to 607.975 MHz in 25 kHz steps, making it easy to find clear operating frequencies. Operating frequency is normally selected using a receiver or analyzer to assess signals in the local environment to avoid interference. Once an interference-free frequency is identified, the transmitter frequency is set to match the receiver.

## Input Gain Range and Limiter

45 dB range of input gain adjustment allows gain settings to accurately match the user's voice and the varying sensitivity of different microphone capsules. A DSP-controlled analog audio limiter is employed before the A-D converter. The limiter has a range of more than 30 dB for excellent overload protection. A dual release envelope makes the limiter acoustically transparent while maintaining low distortion. It can be thought of as two limiters in series, a fast attack and release limiter followed by a slow attack and release limiter. The limiter recovers quickly from brief transients, with no audible side effects, and also recovers slowly from sustained high levels to keep audio distortion low while preserving short term dynamics.

## Long Battery Life

Switching power supplies throughout the design allow over 5 hours of operation using two alkaline AA batteries. The battery compartment and contacts are designed to prevent "rattle" as the unit is handled.

## Menu-Driven Control

A high-resolution LCD and control panel with membrane switches provide access to the menu-driven setup. Transmitter RF power, low frequency rolloff, frequency selection, backlight timeout settings and programmable switch functions are easily accessed.

## Antenna

A newly designed helical antenna allows the transmitter to be held in any position, since the user's hands have little or no effect on the RF output power.

## Microphone Capsules

The transmitter is available from Lectrosonics with the HHC cardioid condenser capsule. Capsules from several other manufacturers with a 1.25" x 28 thread pitch and three contact rings are also available for use with the transmitter. Condenser or dynamic microphone heads can be used with the transmitter, depending on the user's preference or the application.

## Side Button Functions

A programmable switch on the side of the housing can be configured as a mute/cough switch, a power switch, or be disabled.

## USB Port for Firmware Updates

Firmware updates are enabled by simply downloading a file and utility program from the Lectrosonics web site, connecting the transmitter to a computer via the USB port and running the program.

## Mechanical Assembly



A mic capsule is threaded onto the body of the transmitter in the direction shown. Do not overtighten it.

The threaded interface is a 1.25" diameter opening with 28 threads per inch and three contact rings

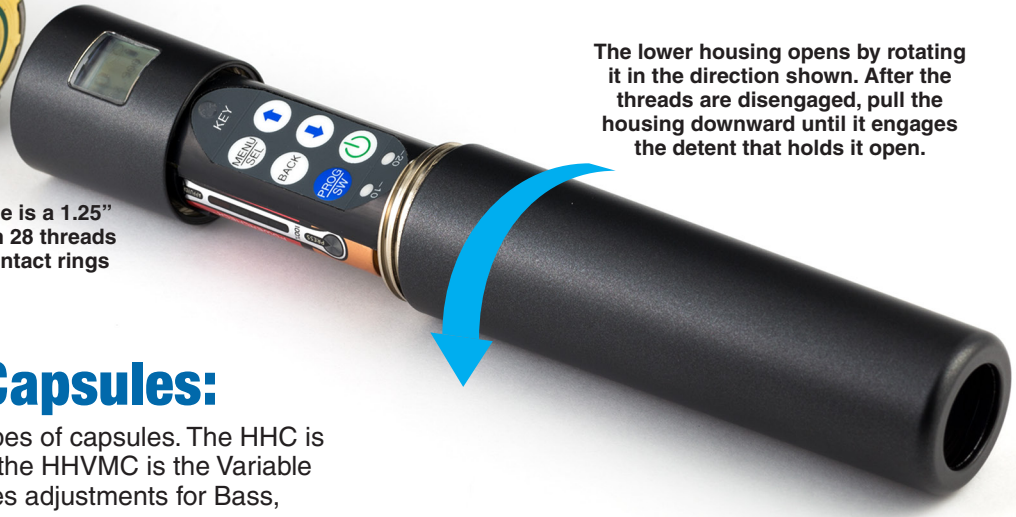

The lower housing opens by rotating it in the direction shown. After the threads are disengaged, pull the housing downward until it engages the detent that holds it open.

## Microphone Capsules:

Lectrosonics offers two types of capsules. The HHC is the standard capsule and the HHVMC is the Variable Mic Capsule which includes adjustments for Bass, Midrange and Treble.



HHC Lectrosonics cardioid electret



HHVMC Lectrosonics cardioid electret with VariMic preamp

Along with these two models from Lectrosonics, a variety of different capsules with the same thread and electrical interface are available from the major microphone manufacturers.

A list of compatible capsules is on the website at [www.lectrosonics.com](http://www.lectrosonics.com) listed on the HH transmitter page.

Do not touch the contacts between the mic capsule and transmitter body. When necessary, the contacts can be cleaned with a cotton swab and alcohol.



## Capsule Installation

Capsules are attached with a right-hand thread.

To remove the windscreen from the mic capsule, line up the blue wrench (included with the capsule head) with the flat notches on the lower threaded area of the mic capsule.

Align flats on the wrench with flats on the capsule.



\*All product names are trademarks of their respective owners, which are in no way affiliated with Lectrosonics.

## Battery Installation

To insert batteries, close the eject lever and insert the upper contacts first (closest to the mic capsule). Polarity is marked on the label in the bottom of the battery compartment.

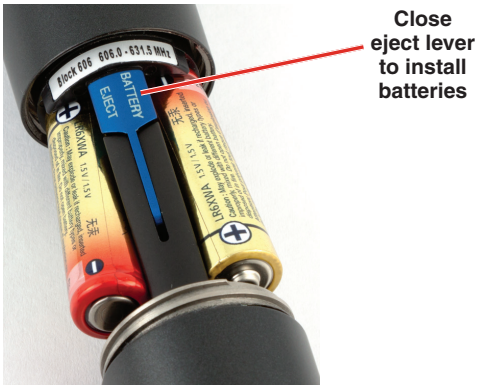

To remove the batteries, pull the eject lever outward. The battery tips will move outward, making them easier to grasp.

**Pull eject lever outward to release batteries from contacts**

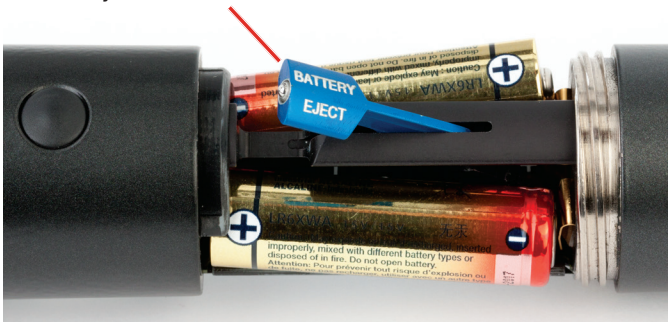

The contacts are very tight to prevent the batteries from “rattling” as the transmitter is being handled.

## Control Panel

Six membrane switches on the control panel are used to set up the transmitter by navigating the menus on the LCD and selecting the desired values.



# Setup and Adjustments

## Powering On

Press and hold the Power Button for several seconds until a countdown on the LCD is completed. The countdown from 1 through 3 will appear on the LCD, followed by a display of the model, firmware version, frequency band and compatibility mode.

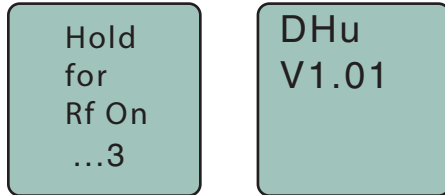

When you release the button, the unit will be operational with the RF output turned ON and the Main Window displayed.

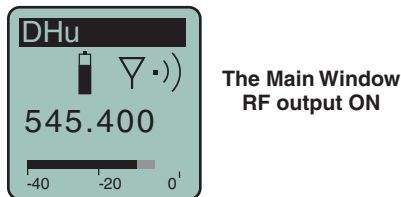

If you release the button before the countdown is complete, the unit will turn on in the Standby mode with the RF output turned OFF and the antenna icon will blink.

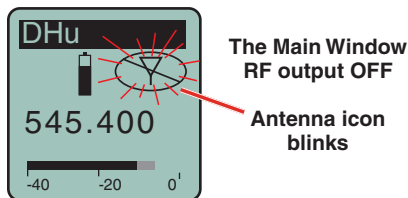

## Powering Off

Press and hold the Power Button (or the programmable button if it is configured for power on/off) for several seconds and observe the LCD countdown progress from 3 to 1. The power will then be turned off. This can be done from any menu or screen.

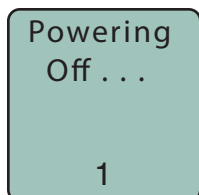

**NOTE:** If the **Power Button** is released before the countdown is completed, the unit will remain turned on and the LCD will return to the same screen or menu that was displayed previously.

## Standby Mode

A brief push of the Power Button turns the unit on and places it into a “standby” mode (not transmitting). This allows the transmitter to be set up without the risk of creating interference for other wireless systems that are operating in the vicinity.

A notice will appear briefly confirming that the RF output of the transmitter is turned off, followed by the Main Window. The antenna symbol will blink as a reminder that the RF output is turned off.

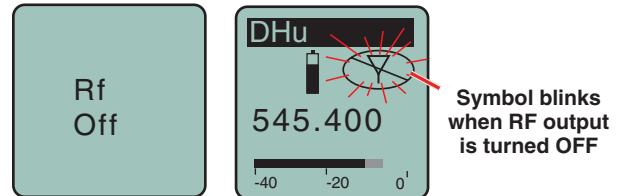

## Power Menu

When the transmitter is turned on, a brief push of the Power Button will reveal a menu allowing you to choose between **Resume**, **Pwr Off**, **Rf On?**, **Backlit** and **About**.

Use the UP/DOWN buttons to select one of the menu items, then press the **MENU/SEL** button to confirm.

- **Resume:** Continue operating in the same condition as before.
- **Pwr Off:** Turns off the transmitter.
- **Rf On?:** Begin transmitting the RF signal, enters another screen prompting a **Yes** or **No** answer.
- **Backlit:** The LCD includes a backlight that illuminates the display for easier viewing. It is set to come on when any button on the control panel is pressed, then stay on for either 30 seconds or 5 minutes, or to stay on all the time.
- **About:** Displays the model and firmware versions of the microcontroller and FPGA.

The unit can also be turned off from any menu or screen on the LCD by holding the power button in for the duration of the countdown.

### Battery Condition

An icon on the Main Window indicates the remaining power of the transmitter batteries. This battery gauge is most accurate with the typical voltage drop across the life of alkaline batteries.

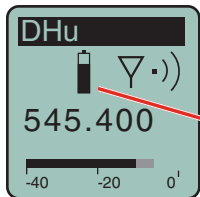

Battery Gauge

### Navigating Menus and Screens

The Main Window displays the following information:

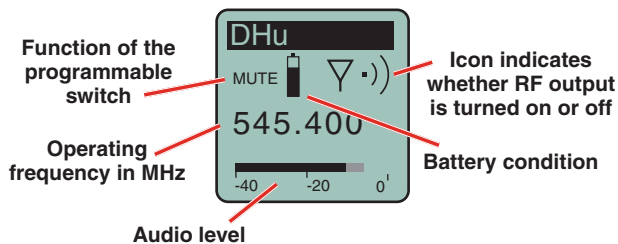

- 1) Press the **MENU/SEL** button to enter the setup menu. Use the UP/DOWN buttons to highlight the menu item.
- 2) Press the **MENU/SEL** button to enter the setup screen for that item. Use the UP/DOWN buttons to select the desired value or mode.

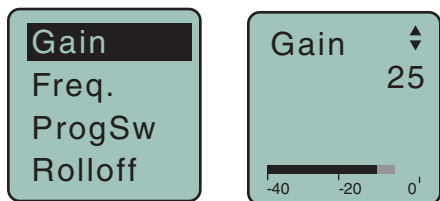

- 3) Press the **MENU/SEL** button to save this setting and return to the previous screen.
- 4) Press the **BACK** button to return to the Main Window.

## Menu Map

The menu is simple and intuitive. A summary of the available settings is shown here, and details of the settings are on the following pages.

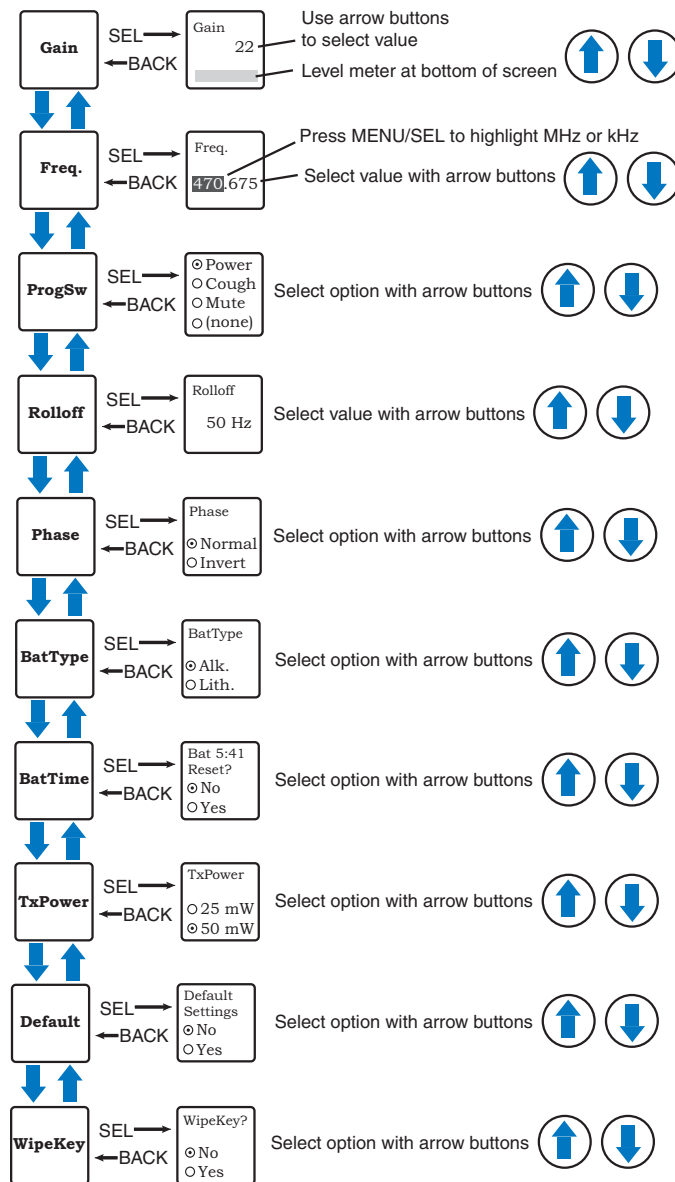

## Gain

This setting is very important since it will affect the dynamic range that the wireless system will deliver. Gain must be set according to the individual voice, the mic capsule in use and the handling technique of the user. LEDs and a bar type indicator in the LCD facilitate accurate gain adjustment.

**IMPORTANT:** See [Input Gain Adjustment on the next page for details.](#)

## Freq.

The operating frequency is normally determined using the scanning function in the receiver or with coordination software. The frequency is shown on the transmitter LCD display in MHz, and is set to match the receiver. Press the MENU/SEL button repeatedly to toggle back and forth between MHz and kHz. Adjustment is made in 25 kHz increments.

## ProgSw

The Programmable Switch on the side of the housing can be set to provide several functions, or it can be bypassed.

- **Power:** Turns the unit on and off. Press and hold until the countdown is completed to turn the unit off. A brief press will turn the unit on with the RF output turned on.
- **Cough:** Enables a brief muting of the audio while the button is held in. Audio is turned back on as soon as the button is released.
- **Mute:** Turns the audio off and it remains muted until the button is pressed again.
- **(none):** Disables the button functions

MUTE will be displayed in the Main Window when Cough or Mute is enabled on the programmable switch

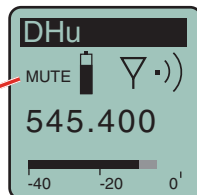

## Rolloff

A low frequency roll-off filter can be set for a -3dB point at 35, 50, 70, 100, 120 or 150 Hz.

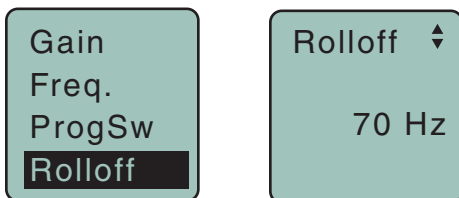

The roll-off frequency is normally adjusted by ear to suit personal preferences.

## Phase

The phase (polarity) of the audio can be inverted to match other microphone capsules as needed. This is normally used when “comb filtering” is heard. Comb filtering is an odd sounding distortion heard when two or more microphones are mixed with different polarities. Switch the transmitter setting back and forth between **Normal** and **Invert** and listen to the audio to determine which one is the better setting.

## BatType

This sets the battery monitoring for Alkaline or Lithium batteries.

## BatTime

Accumulated operating time (runtime) can be tracked in the transmitter. The total runtime appears on the **BatTime** setup screen, displayed in (hrs):(min). The runtime is kept during battery changes, and must be reset manually in the **BatTime** setup screen.

## TxPower

Output power can be set to 25mW or 50mW as needed for the application.

## Default

The default setting simply returns the transmitter back to the factory settings.

## WipeKey

Selecting **Yes** on this setup screen erases the stored encryption key in the transmitter.



# Input Gain Adjustment

The two bicolor Modulation LEDs (located at the bottom of the control panel) provide a visual indication of the audio signal level entering the transmitter.

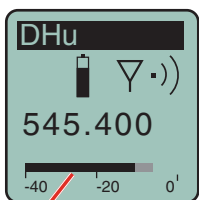
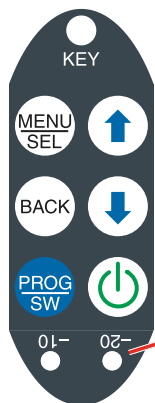

The audio level is shown by LEDs and a bar type indicator on the LCD.

The gain should be set so that the -20 LED just turns red on the loudest peak (the onset of limiting).

The LEDs are marked for viewing when the mic capsule is held up to your mouth. They will glow either red or green to indicate modulation levels as shown in the following table.

Signal Level	-20 LED	-10 LED
Less than -20 dB	● Off	● Off
-20 dB to -10 dB	● Green	● Off
-10 dB to +0 dB	● Green	● Green
+0 dB to +10 dB	● Red	● Green
Greater than +10 dB	● Red	● Red

It is best to go through the following procedure with the transmitter in the “standby” mode so that no audio will enter the sound system, which could cause feedback.

- 1) With fresh batteries in the transmitter, power the unit on into “standby” (no transmission) mode.
- 2) Press the **MENU/SEL** button once to enter the setup menu. Use the UP/DOWN buttons to select **Gain**. Press the **MENU/SEL** button again to enter the setup screen.
- 3) Hold the microphone the way it will be used in actual operation.
- 4) Speak or sing at the same voice level that will actually be used during the program, while observing the modulation LEDs. Use the UP/DOWN buttons to adjust the gain until the **-20 dB** LED starts to flicker red and the **-10 dB** glows green.
- 5) Once the audio gain has been set, the RF output can be turned on and the audio sent through the sound system for overall level adjustments, monitor settings, etc.

**NOTE:** Full modulation is achieved when the -20 LED first turns red. 30 dB of clean limiting is available above this point.

# Firmware Update

Updating the firmware is a simple matter of downloading a utility program and file from the website and running the program on a **Windows operating system** with the transmitter connected to a computer via the USB port.

Go to [www.lectrosonics.com/US](http://www.lectrosonics.com/US). In the top menu, hover the mouse over Support, and click on Wireless Support. On the right-hand-side Wireless Support Menu, choose Wireless Downloads. Choose your product (DHu), then choose Firmware.

## Step 1:

Begin by downloading the USB Firmware Updater Program.

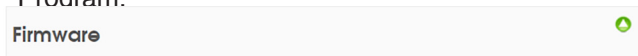

Below are links to the current firmware versions for the HHa transmitter. Note that the HHa and HHa/E01 models require different firmware loads. The HHa is sold in the US and Canada; the HHa/E01 is sold in the European Union. Be sure to download the correct update file and double-check before installing!

These are zip files, after downloading extract it into a temporary folder. Use the **USB Firmware Updater program** to update firmware.

[Click here to see DHu Firmware Revision History](#)

[Click here to see DHu/E01 Firmware Revision History](#)

HHa Firmware Update v1.03

[dhu\\_v1\\_03.zip](#) [DETAILS](#) [DOWNLOAD](#)

HHa/E01 Firmware Update v1.04

[dhu\\_e01\\_v1\\_04.zip](#) [DETAILS](#) [DOWNLOAD](#)

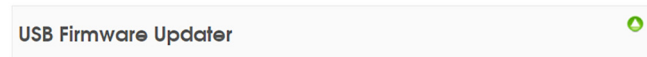

Below is a link to the current USB Firmware Updater installer. This program is used to update firmware on these products:

- DHu transmitter
- LT transmitter
- LR receiver
- SSM transmitter
- HHa transmitter
- HHa transmitter

Instructions for updating firmware is found in the Instruction Manual for these products.

Download into a temporary folder. Uninstall any previous version of USB Firmware Updater before running the downloaded installer.

**Note:** This program requires that the FTDI D2XX Direct USB driver be installed on your PC. This is normally pre-installed but if not you will need to download and run a driver installer from the [official FTDI download page](#). Installers for both 64-bit and 32-bit Windows® PCs are available there.

USB Firmware Updater v1.0.6

[UsbFwUpdater-v1.0.6-setup.exe](#) [DETAILS](#) [DOWNLOAD](#)

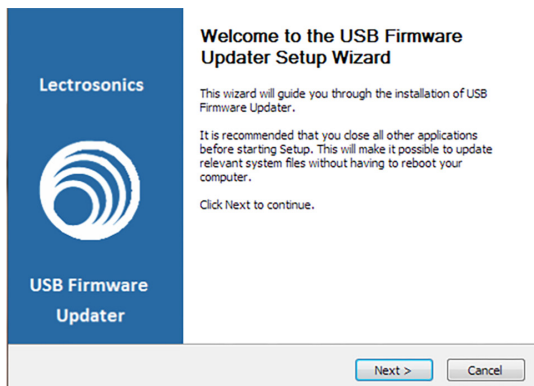

## Step 2:

Next, test the Updater by opening the icon: If the driver opens automatically, proceed to Step 3.

**WARNING: If you receive the following error, the Updater is not installed on your system. Follow the TROUBLESHOOTING steps to fix the error.**

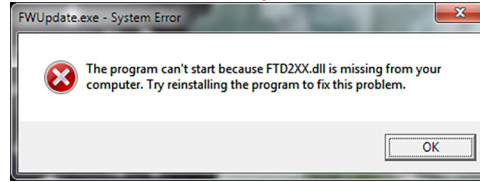

## TROUBLESHOOTING:

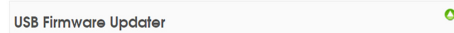

Below is a link to the current USB Firmware Updater installer. This program is used to update firmware on these products:

- DHu transmitter
- LR transmitter
- LR receiver
- SSM transmitter
- HHa transmitter
- HHa transmitter

Instructions for updating firmware is found in the Instruction Manual for these products.

Download into a temporary folder. Uninstall any previous version of USB Firmware Updater before running the downloaded installer.

**Note:** This program requires that the FTDI D2XX Direct USB driver be installed on your PC. This is normally pre-installed but if not you will need to download and run a driver installer from the [official FTDI download page](#). Installers for both 64-bit and 32-bit Windows® PCs are available there.

USB Firmware Updater v1.0.6

[UsbFwUpdater-v1.0.6-setup.exe](#) [DETAILS](#) [DOWNLOAD](#)

If you receive the FTDI D2XX error shown above, download and install the driver by clicking on this link.

Then click here to download.

**NOTE:** This website, <http://www.ftdichip.com/Drivers/D2XX.htm>, is not associated with Lectrosonics.com. It is a third party site used only for D2XX drivers currently available for Lectrosonics' devices' upgrades.

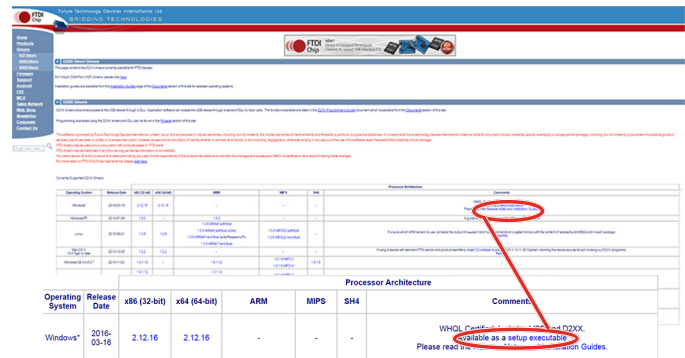

Operating System	Release Date	x86 (32-bit)	x64 (64-bit)	ARM	MIPS	SH4	Comment
Windows*	2016-03-16	2.12.16	2.12.16	-	-	-	WHQL Certified for Windows and D2XX. Available as a setup executable. Please read the Installation Guides.

### Step 3:



Refer to Step 1 to return to Firmware web page. Download Firmware Update and save to a local file on your PC for easy locating when updating.

Firmware 

Below are links to the current firmware versions for the HHa transmitter. Note that the HHa and HHa/E01 models require different firmware loads. The HHa is sold in the US and Canada; the HHa/E01 is sold in the European Union. Be sure to download the correct update file and double-check before installing!

These are zip files, after downloading extract it into a temporary folder. Use the [USB Firmware Updater program](#) to update firmware.

[Click here to see DHu Firmware Revision History](#)  
[Click here to see DHu/E01 Firmware Revision History](#)

HHa Firmware Update v1.03  dhu_v1_03.zip	<a href="#">DETAILS</a>	<a href="#">DOWNLOAD</a>
HHa/E01 Firmware Update v1.04  dhu_e01_v1_04.zip	<a href="#">DETAILS</a>	<a href="#">DOWNLOAD</a>

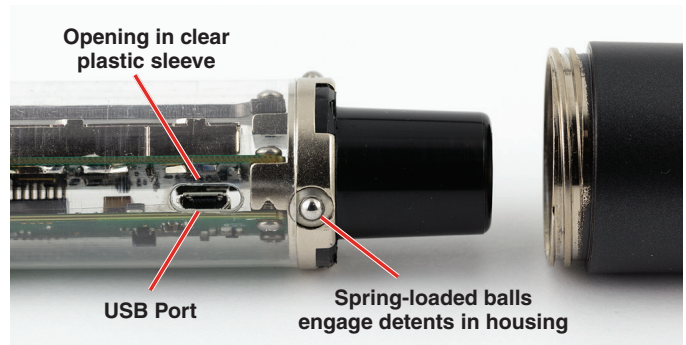

### Step 4:

Open Lectrosionics USB Firmware Updater. 

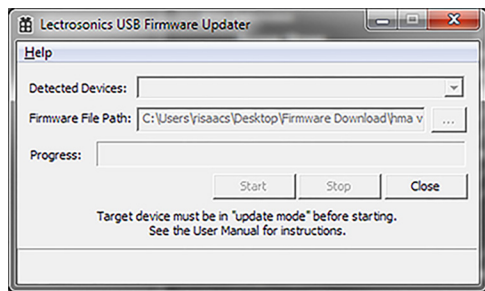

### Step 7:

In Lectrosionics USB Firmware Updater, choose the detected device, browse to local Firmware File and click Start.

**NOTE:** It may take up to a minute or so for the Updater to recognize the transmitter.

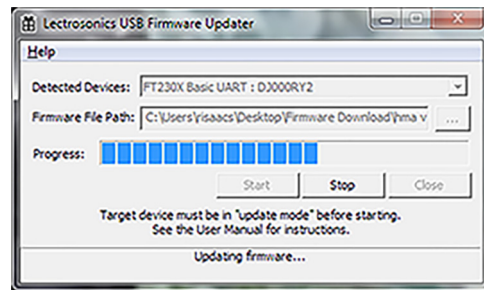

**WARNING:** Do not disrupt the microUSB cable during updating.

### Step 5:



Put the transmitter in UPDATE mode by simultaneously holding down the **BACK** and **UP** arrow buttons on the transmitter control panel while powering it up.

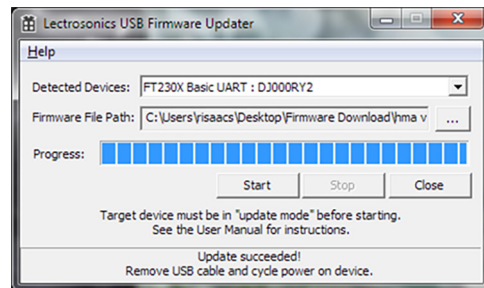

### Step 6:

Using a microUSB cable, connect the transmitter to your PC.

Remove the lower housing of the transmitter by unscrewing it from the housing attached to the capsule and pulling it straight off the body of the transmitter to expose the circuitry. Spring-loaded ball detents provide a “stop” with only the control panel exposed. Continue to pull the lower housing farther to remove it. Simply push the lower housing back onto the transmitter body to re-install it.

The USB port on the transmitter requires a micro-B male plug on the connecting cable. The other end of the cable would normally be a USB A-Type male connector to fit the most common type of USB jack used on computers.

The Updater alerts with progress and completion.

### Step 8:

Once the Updater has completed, turn off the transmitter, then turn it back on while viewing the LCD to verify that the firmware version on the transmitter LCD matches the firmware version shown on the web site.

# Parts and Accessories

## #CCHH - Zippered Pouch

Padded zipper pouch for handheld transmitter



## #26872 Mic Capsule Wrench

Custom wrench for removing windscreen from mic capsule



## #13585 Mic Clip

Screw on mic clip for standard mic stands with 5/8"-27 thread



# Troubleshooting

## SYMPTOM

## POSSIBLE CAUSE

TRANSMITTER WILL NOT POWER ON

- 1) Batteries are inserted backwards.
- 2) Batteries are dead, or too low to be used.

DHu MODULATION LEDs OFF

- 1) Audio Gain set too low.
- 2) Battery is inserted backwards. Check LCD for power indication.
- 3) Mic capsule is damaged or malfunctioning. Contact the factory for repair.

DHu MODULATION LEDs GOOD BUT NO SOUND

- 1) Talkback function is engaged (release multi-function button). See p. 11.
- 2) Receiver on wrong frequency or wrong band.
- 3) Receiver connected incorrectly to sound system.
- 4) Transmitter in standby mode.

RECEIVER RF INDICATOR OFF

- 1) Transmitter not turned on.
- 2) Transmitter is in "standby" (non-transmitting) mode. Check the LCD for the antenna/transmission icon status.
- 3) Batteries are dead or installed backwards.
- 4) Receiver antenna missing, defective or improperly positioned.
- 5) Transmitter and receiver not on same frequency band. Check labels on transmitter and receiver to be sure they are operating on the same frequency band.
- 6) Make sure the transmitter and receiver frequency settings are in agreement.
- 7) Operating range is too great.
- 8) Receiver antenna missing, incorrect frequency or disconnected.

NO SOUND BUT RECEIVER AUDIO LEVEL METER INDICATES SOUND

- 1) Receiver audio is muted. (Unmute receiver.)
- 2) Receiver audio output levels set too low.
- 3) Receiver audio output is disconnected or cable defective or mis-wired.
- 4) Sound system or recorder input level is turned down.

DISTORTED SOUND

- 1) Transmitter Audio Gain set too high. Speak or sing into the transmitter and check the Audio Level LEDs, Audio Level bar graph in the transmitter LCD and corresponding indicators on the receiver.
- 2) Receiver output level may be too high for the sound system or recorder input.
- 3) Excessive wind noise or "breath pops." Microphone may require an additional wind screen.
- 4) Transmitter frequency setting is not correct.
- 5) Mic capsule damaged or defective

HISS AND NOISE -- AUDIBLE DROPOUTS

- 1) Transmitter Audio Gain set too low. See page 9 for proper audio gain setting.
- 2) Receiver antenna missing, defective or obstructed.
- 3) Operating range too great.
- 4) Interference may be present. Turn transmitter off and observe the RF level indicator on the receiver. Change frequency if necessary.
- 5) Return attenuator control back to default setting of "F", then readjust audio gain per instructions on page 9

EXCESSIVE FEEDBACK

- 1) Transmitter Audio Gain set too high. Check level adjustment, reduce receiver output level, or both.
- 2) Microphone too close to speaker system.
- 3) Move microphone closer to the user's mouth and lower the sound system volume.

# Specifications

Frequency range:	470.100 - 607.975 MHz
Frequency selection steps:	25 kHz
RF Power output:	Selectable; 25 or 50 mW
Frequency stability:	± 0.002%
Digital Modulation:	8 psk
Spurious radiation:	Compliant with ETSI EN 300 422-1 v1.4.2
Operating temperature range:	-20° C to +50° C
Input compressor:	Dual envelope compressor, >30 dB range
Gain control range:	45 dB; semi-log menu-driven control; 1 dB steps
Modulation indicators:	Dual bicolor LEDs indicate modulation of -20, -10, 0 and +10 dB referenced to full modulation and LCD bar-type indicator
Frequency response	40 Hz to 20 kHz (+/- 1dB)
Low frequency roll-off:	Selectable -3 dB @35, 50, 70, 100, 120, 150 Hz
Controls:	
External:	Programmable mute/power button
Under battery cover:	Power, menu/select, back, programmable switch and up/down arrow buttons for menu selection and settings
Battery:	2x AA with polarity protection and battery ejector
Battery life:	At 50 mW: 5 hours (Duracell Procell) (The DHu transmits battery status to Lectrosonics receivers.)
Capsule Interface:	1.25" opening and 28 thread pitch Power available: 5V, 25 mA max Input impedance: 1000 Ohms
Weight:	12.1 oz. with batteries and HHC capsule
Dimensions:	9.5" long x 1.97" diameter at largest point

Emission Designator: 200KG1E

Specifications subject to change without notice.

## FCC Compliance:

This device complies with FCC radiation exposure limits as set forth for an uncontrolled environment. This device should be installed and operated so that its antenna(s) are not co-located or operating in conjunction with any other antenna or transmitter.

## FCC Notice to the End User:

The normal condition of using this device is to keep the hand at least 20mm away from the base of the microphone.

## ISED Notice to the End User:

The normal condition of using this device is to keep the hand at least 20mm away from the base of the microphone.

La condition normale d'utilisation de cet appareil est de garder la main à au moins 20 mm de la base du microphone.

## ISED Notices:

### Per RSS-210

This device operates on a no-protection no-interference basis. Should the user seek to obtain protection from other radio services operating in the same TV bands, a radio licence is required. Please consult Industry Canada's document CPC-2-1-28, Optional Licensing for Low-Power Radio Apparatus in the TV Bands, for details.

Ce dispositif fonctionne selon un régime de non-brouillage et de non-protection. Si l'utilisateur devait chercher à obtenir une certaine protection contre d'autres services radio fonctionnant dans les mêmes bandes de télévision, une licence radio serait requise. Pour en savoir plus, veuillez consulter le document CPC-2-1-28 d'Industrie Canada intitulé, Délivrance de licences sur une base volontaire pour les appareils radio de faible puissance exempts de licence et exploités dans les bandes de télévision.

### Per RSS-Gen

This device complies with Industry Canada's license-exempt RSSs. Operation is subject to the following two conditions:

- 1) This device may not cause interference
- 2) This device must accept any interference, including interference that may cause undesired operation of the device.

Le présent appareil est conforme aux CNR d'Industrie Canada applicables aux appareils radio ex-empts de licence. L'exploitation est autorisée aux deux conditions suivantes :

- 1) l'appareil ne doit pas produire de brouillage;
- 2) l'appareil doit accepter tout brouillage radioélectrique subi, même si le brouillage est susceptible d'en compromettre le fonctionnement.

## Service and Repair

If your system malfunctions, you should attempt to correct or isolate the trouble before concluding that the equipment needs repair. Make sure you have followed the setup procedure and operating instructions. Check the inter-connecting cables and then go through the **Troubleshooting** section in this manual.

We strongly recommend that you **do not** try to repair the equipment yourself and **do not** have the local repair shop attempt anything other than the simplest repair. If the repair is more complicated than a broken wire or loose connection, send the unit to the factory for repair and service. Don't attempt to adjust any controls inside the units. Once set at the factory, the various controls and trimmers do not drift with age or vibration and never require readjustment. **There are no adjustments inside that will make a malfunctioning unit start working.**

LECTROSONICS' Service Department is equipped and staffed to quickly repair your equipment. In-warranty repairs are made at no charge in accordance with the terms of the warranty. Out-of-warranty repairs are charged at a modest flat rate plus parts and shipping. Since it takes almost as much time and effort to determine what is wrong as it does to make the repair, there is a charge for an exact quotation. We will be happy to quote approximate charges by phone for out-of-warranty repairs.

## Returning Units for Repair

For timely service, please follow the steps below:

- A. DO NOT return equipment to the factory for repair without first contacting us by letter or by phone. We need to know the nature of the problem, the model number and the serial number of the equipment. We also need a phone number where you can be reached 8 A.M. to 4 P.M. (U.S. Mountain Standard Time).
- B. After receiving your request, we will issue you a return authorization number (R.A.). This number will help speed your repair through our receiving and repair departments. The return authorization number must be clearly shown on the **outside** of the shipping container.
- C. Pack the equipment carefully and ship to us, shipping costs prepaid. If necessary, we can provide you with the proper packing materials. UPS is usually the best way to ship the units. Heavy units should be "double-boxed" for safe transport.
- D. We also strongly recommend that you insure the equipment, since we cannot be responsible for loss of or damage to equipment that you ship. Of course, we insure the equipment when we ship it back to you.

### Mailing address:

Lectrosonics, Inc.  
PO Box 15900  
Rio Rancho, NM 87174  
USA

### Shipping address:

Lectrosonics, Inc.  
581 Laser Rd.  
Rio Rancho, NM 87124  
USA

### Telephone:

(505) 892-4501  
(800) 821-1121 Toll-free  
(505) 892-6243 Fax

### Web:

[www.lectrosonics.com](http://www.lectrosonics.com)

### E-mail:

[sales@lectrosonics.com](mailto:sales@lectrosonics.com)

### Lectrosonics Canada:

#### Mailing Address:

720 Spadina Avenue,  
Suite 600  
Toronto, Ontario M5S 2T9

#### Telephone:

(416) 596-2202  
(877) 753-2876 Toll-free  
(877-7LECTRO)  
(416) 596-6648 Fax

#### E-mail:

Sales: [colinb@lectrosonics.com](mailto:colinb@lectrosonics.com)  
Service: [joeb@lectrosonics.com](mailto:joeb@lectrosonics.com)

## LIMITED ONE YEAR WARRANTY

The equipment is warranted for one year from date of purchase against defects in materials or workmanship provided it was purchased from an authorized dealer. This warranty does not cover equipment which has been abused or damaged by careless handling or shipping. This warranty does not apply to used or demonstrator equipment.

Should any defect develop, Lectrosonics, Inc. will, at our option, repair or replace any defective parts without charge for either parts or labor. If Lectrosonics, Inc. cannot correct the defect in your equipment, it will be replaced at no charge with a similar new item. Lectrosonics, Inc. will pay for the cost of returning your equipment to you.

This warranty applies only to items returned to Lectrosonics, Inc. or an authorized dealer, shipping costs prepaid, within one year from the date of purchase.

This Limited Warranty is governed by the laws of the State of New Mexico. It states the entire liability of Lectrosonics Inc. and the entire remedy of the purchaser for any breach of warranty as outlined above. NEITHER LECTROSONICS, INC. NOR ANYONE INVOLVED IN THE PRODUCTION OR DELIVERY OF THE EQUIPMENT SHALL BE LIABLE FOR ANY INDIRECT, SPECIAL, PUNITIVE, CONSEQUENTIAL, OR INCIDENTAL DAMAGES ARISING OUT OF THE USE OR INABILITY TO USE THIS EQUIPMENT EVEN IF LECTROSONICS, INC. HAS BEEN ADVISED OF THE POSSIBILITY OF SUCH DAMAGES. IN NO EVENT SHALL THE LIABILITY OF LECTROSONICS, INC. EXCEED THE PURCHASE PRICE OF ANY DEFECTIVE EQUIPMENT.

This warranty gives you specific legal rights. You may have additional legal rights which vary from state to state.

