

LMa

Frequency-Agile UHF Belt-Pack Transmitter



**Featuring
Digital Hybrid Wireless™ Technology**

US Patent 7,225,135

Fill in for your records:

Serial Number:

Purchase Date:



Table of Contents

Introduction	4
Digital Hybrid Technology	4
Frequency Agility.....	4
Wide-Band Deviation	4
Long Battery Life.....	4
Servo Bias Input and Wiring	4
Input Limiter	5
No Pre-Emphasis/De-Emphasis	5
Pilot Tone Squelch	5
LMA Block Diagram.....	5
Controls and Functions	6
Input Jack.....	6
Power ON/OFF Switch.....	6
Power LED.....	6
Frequency Select Switches.....	6
Modulation LEDs.....	6
Audio Level	6
Antenna.....	6
Belt Clip.....	6
Battery Installation	7
Operating Instructions	8
Selecting the Compatibility Mode.....	8
Attaching a Microphone or Musical Instrument and Adjusting Audio Levels.....	8
Adjusting the Transmitter Frequency.....	9
5-Pin Input Jack Wiring	10
Microphone RF Bypassing.....	10
Line Level Signals	10
Microphone Cable Termination for Non-Lectrosonics Microphones	11
Wiring Hookups for Different Sources	12
Compatible Wiring for Both Servo Bias Inputs and Earlier Transmitters:	12
Simple Wiring for Servo Bias Inputs Only:	12
Wiring Diagram for MI33A Instrument Cable	13
Troubleshooting	15
Specifications and Features	16
Service and Repair	17
Returning Units for Repair	17

Introduction

The design of the LMA transmitter introduces the advanced technology and features of Digital Hybrid Wireless™ in a Lectrosonics belt-pack transmitter at a modest cost. Digital Hybrid Wireless™ combines a 24-bit digital audio chain with an analog FM radio link to eliminate a compandor and its artifacts, yet preserve the extended operating range and noise rejection of the finest analog wireless systems. DSP “compatibility modes” allow the LMA to be used with a variety of analog receivers in addition to its native hybrid mode by emulating the compandors found in Lectrosonics 100 Series, 200 Series and IFB transmitters, and certain receivers from other manufacturers (contact the factory for details). Changing the compatibility mode is accomplished with a simple procedure using the frequency switches and power switch.

The housing is a rugged, machined aluminum package with removable, stainless steel wire belt clip. The input jack is a standard Lectrosonics 5-pin type for use with electret lavalier mics, dynamic mics, musical instrument pickups and line level signals. The LEDs on the front panel allow quick and accurate level settings without having to view the receiver. The battery compartment accepts any 9 volt battery and makes a positive connection via self-adjusting contacts. The antenna is a super-rugged, permanently attached 1/4 wavelength design made of flexible galvanized steel cable.

The switching power supplies in the LMA provide constant voltages to the transmitter circuits from the beginning (9.3 VDC) to the end (5.5 VDC) of battery life, with output power remaining constant over the life of the battery. The input amplifier uses an ultra low noise op amp for quiet operation. Input gain is adjustable over a 43 dB range, with a DSP controlled dual envelope input limiter to cleanly handle signal peaks over 30 dB above full modulation.

Digital Hybrid Technology

All wireless links suffer from channel noise to some degree, and all wireless microphone systems seek to minimize the impact of that noise on the desired signal. Conventional analog systems use compandors for enhanced dynamic range, at the cost of subtle artifacts (known as “pumping” and “breathing”). Wholly digital systems defeat the noise by sending the audio information in digital form, at the cost of some combination of power, bandwidth, operating range and resistance to interference.

The Lectrosonics Digital Hybrid Wireless™ system overcomes channel noise in a dramatically new way, digitally encoding the audio in the transmitter and decoding it in the receiver, yet still sending the encoded information via an analog FM wireless link. This proprietary algorithm is not a digital implementation of an analog compandor but a technique which can be accomplished only in the digital domain.

Since the RF link between transmitter and receiver is FM, channel noise will increase gradually with increased operating range and weak signal conditions, however, the hybrid system handles this situation elegantly with rarely audible audio artifacts as the receiver approaches its squelch threshold. In contrast, a purely digital system tends to drop the audio suddenly during brief dropouts and weak signal conditions. The Digital Hybrid Wireless™ system simply encodes the signal to use a noisy channel as efficiently and robustly as possible, yielding audio performance that rivals that of purely digital systems, without the power, noise and bandwidth problems inherent in digital transmission. Because it uses an analog FM link, Digital Hybrid Wireless™ enjoys all the benefits of conventional FM wireless systems, such as excellent range, efficient use of RF spectrum, and long battery life.

Frequency Agility

The transmitter section uses a synthesized, frequency selectable main oscillator. The frequency is extremely stable over a wide temperature range and over time.

Two rotary switches, located on the side panel provide 256 frequencies in 100 kHz steps over a 25.6 MHz bandwidth.

Wide-Band Deviation

In the Digital Hybrid and 200 Series modes, the system uses ± 75 kHz deviation to dramatically improve the capture ratio, and signal to noise ratio of the overall wireless system.

Long Battery Life

The use of switching power supplies throughout the design allows over 6 hours of operation using a single 9 volt alkaline battery and over 7 hours of operation with a 9 volt LiPolymer rechargeable battery. The battery contacts are spring loaded to prevent “rattle” as the unit is handled.

Servo Bias Input and Wiring

The LMA input preamp is a radically different design than previous Lectrosonics transmitter inputs. The improvements are audible and make the transmitters easier to use and much harder to overload. It is no longer necessary on some mics to introduce pads to prevent overload of the input stage, divide the bias voltage down for some low voltage mics, or reduce the limiter range at minimum gain settings.

Two different microphone wiring schemes are now available to simplify and standardize the configuration. Simplified 2-wire and 3-wire configurations for the servo bias input only take full advantage of the preamp circuitry to maximize the signal to noise ratio, and several other configurations are available that are compatible with the servo bias input and earlier types.

The input will automatically switch the low frequency roll-off to 35 Hz when the MI33ARA and MI33AST

instrument cables are connected.

Input Limiter

The transmitter employs a digitally-controlled analog audio limiter prior to the analog-to-digital converter. The limiter has a range greater than 30 dB for excellent overload protection. A dual release envelope makes the limiter acoustically transparent while maintaining low distortion. It can be thought of as two limiters in series, connected as a fast attack and release limiter followed by a slow attack and release limiter. The limiter recovers quickly from brief transients, so that its action is hidden from the listener, but recovers slowly from sustained high levels to keep audio distortion low and preserve short term dynamic changes in the audio.

No Pre-Emphasis/De-Emphasis

Because the signal to noise ratio of the hybrid system is so high, there is no need for conventional pre-emphasis (HF boost) in the transmitter and de-emphasis (HF roll off) in the receiver. Thus, the possible distortion problems associated with pre-emphasis and de-emphasis

are eliminated.

Pilot Tone Squelch

The DSP in the transmitter generates one of 256 different ultrasonic tones between 25 and 32 kHz to operate the receiver squelch (audio muting). The benefit of a pilot tone squelch system is that the receiver will remain quiet until it receives the pilot tone from the matching transmitter, even if a strong RF signal is present on the carrier frequency of the system. The pilot tone also eliminates noise (pops, thumps, etc.) from occurring when the transmitter is powered on and off.

The pilot tone frequency is chosen according to which of the 256 channels has been selected by the frequency switch setting. This ensures that all transmitters in a system have different pilot tone frequencies so even spurious RF from the wrong transmitters can't open the receiver squelch.

LMa Block Diagram

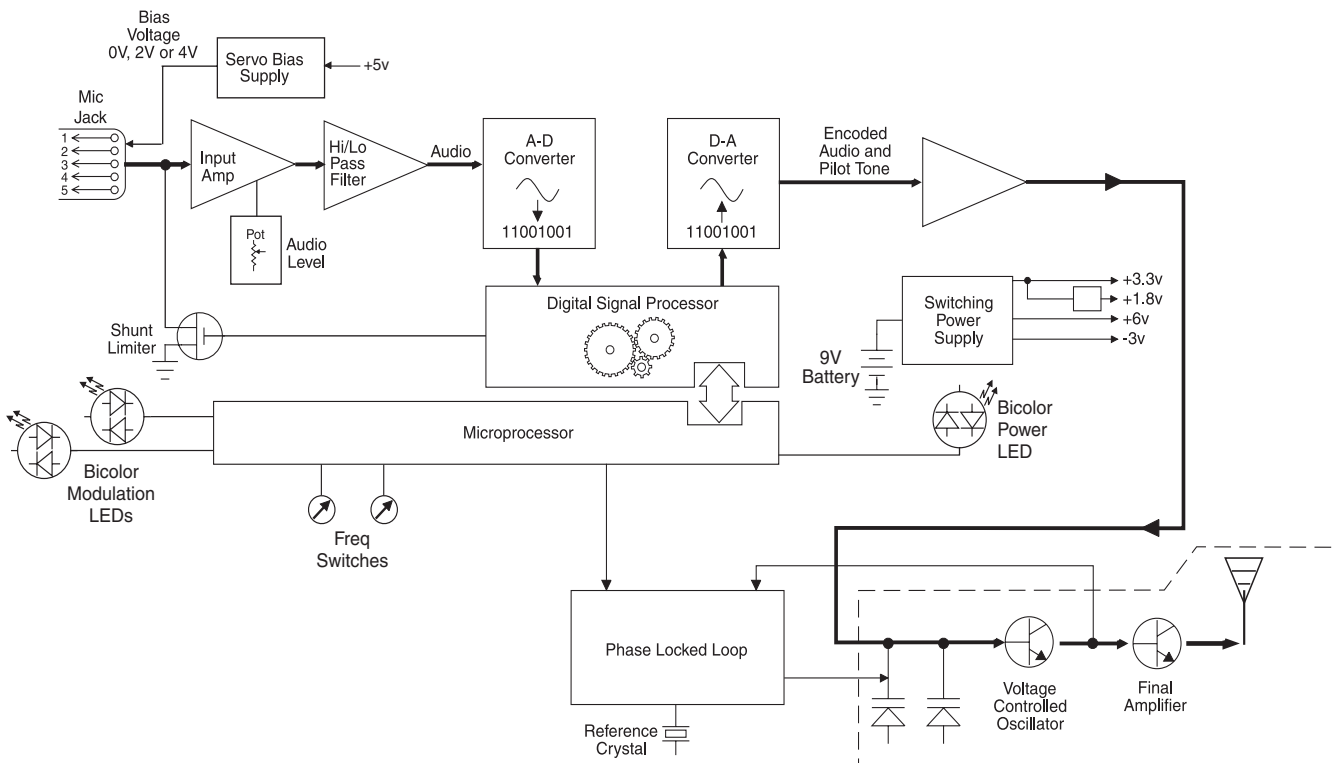

Controls and Functions

Input Jack

The 5-pin (Switchcraft TA5F compatible) input accommodates virtually every lavalier, hand-held or shotgun microphone available, and most musical instrument signals. Line level signals can also be accommodated. (See 5-Pin Input Jack Wiring.)

Power ON/OFF Switch

The Power ON/OFF switch turns the transmitter on and off. The pilot tone muting system prevents transient noise (pops, thumps, etc.) from occurring at the receiver even if the transmitter is abruptly switched on or off.

Power LED

The Power LED glows green when the transmitter is operating and the battery is good. It turns red when the battery voltage drops to 6.1 VDC and starts blinking red when the voltage drops to 5.6 VDC. When using a recommended lithium or alkaline battery, there will be about 30 minutes of operating time remaining when the Power LED first begins blinking red.

Note: A weak battery will sometimes cause the Power LED to glow green, but it will soon discharge to the point where it will turn red or go out completely. If in doubt, replace the battery with a known new battery. If the Power LED fails to glow when the transmitter is turned on, replace the battery.

LiPolymer rechargeable batteries give little or no warning when they are depleted. If you wish to use these batteries in the transmitter, you will need to manually keep track of the operating time to prevent interruptions caused by dead batteries. Start with a fully charged battery, then measure the time it takes for the Power LED to go out completely.

Note: A number of Lectrosonics receivers incorporate a Battery Timer function which tracks the amount of time the transmitter signal is detected. See your receiver manual to determine if this function is available and, if so, the instructions on measuring the actual run time of the battery.

Frequency Select Switches

Two 16-position rotary Frequency Select Switches, accessed through the left side panel, are used to adjust the transmitter's operating frequency. These switches are labeled 1.6M and 100K. The 1.6M switch is used for coarse frequency adjustments and the 100K is used for fine frequency adjustment.

Modulation LEDs

The Modulation LEDs provide a visual indication of the input audio signal level from the microphone or musical instrument. These two bicolor LEDs can glow either red or green to indicate modulation levels.

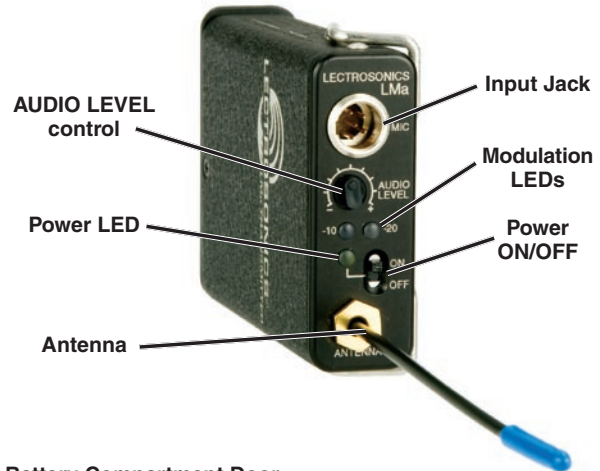

Battery Compartment Door

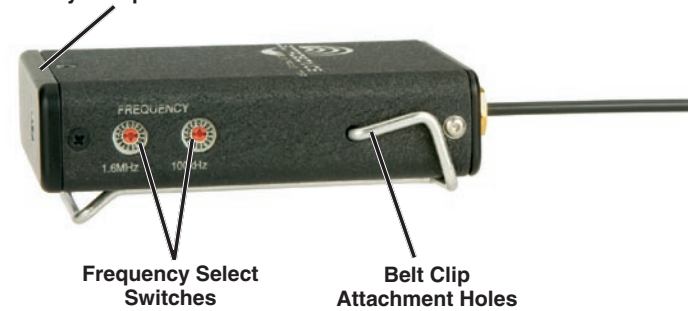

The Modulation LEDs are also used to indicate the Compatibility Mode when the transmitter is initially turned on. The Modulation LEDs will blink simultaneously:

- Once for 100 Series mode
- Two times for 200 Series mode
- Three times for mode 3
- Four times for Digital Hybrid Wireless™ or 400 Series mode
- Five times for IFB mode
- Six times for mode 6

Audio Level

The AUDIO LEVEL control is used to set the input gain for the proper modulation.

Antenna

The flexible, insulated galvanized steel cable antenna supplied with the transmitter is cut to 1/4 wavelength of the center of the frequency block (the frequency range) of the transmitter.

Belt Clip

The belt clip may be removed for special applications by pulling the ends out of the holes in the sides of the case. An optional hinged belt clip (P/N BCHINGED) is also available. Contact a Lectrosonics sales representative, or visit our web site (www.lectrosonics.com) for more details.

Battery Installation

The transmitter is powered by a standard 9 volt battery. We recommend using alkaline, lithium, or rechargeable LiPolymer batteries for longest life. Standard zinc-carbon batteries marked “**heavy-duty**” or “**long-lasting**” are not adequate. Alkaline batteries provide over six hours of operation at room temperature. LiPolymer batteries will last about 7 hours per charge, and Lithium batteries can provide up to 13 hours. The battery status circuitry is designed for the voltage drop over the life of alkaline batteries. Because rechargeable LiPolymer batteries run down quite abruptly, using the Power LED to verify battery status is not reliable with LiPolymer batteries. However, it may be possible to track battery status using the Battery Timer function available in a number of Lectrosonics receivers. (Refer to the associated receiver manual to determine if this function is available in your situation.)

Warning: Care should be taken not to leave a fully discharged lithium battery in the transmitter, as swelling of the battery can make it difficult to remove from the compartment.

To replace the battery, push up on the Battery Compartment Door and rotate it clockwise. (See photo.) Remove the old battery and take note of the polarity marked inside showing the location of the positive (+) and negative (-) terminals. (You can see the large and small contact holes inside the battery compartment with the door open.)

Insert the new battery correctly and rotate the door to snap flush against the housing. If the battery is inserted incorrectly, the door will not fully close. Do not force the door closed.



Operating Instructions

Selecting the Compatibility Mode

The LMA transmitter is capable of working with Lectrosonics 400 Series Digital Hybrid Wireless™, 200 Series analog, 100 Series analog and some non-Lectrosonics analog wireless receivers (contact the factory for details). The transmitter must be set to the operating mode of the matching receiver, which is easily done using the supplied screwdriver and a battery.

NOTE: The unit is supplied from the factory as a 400 series transmitter.

- 1) Ensure the battery is good.
- 2) Turn OFF the transmitter.
- 3) With a small screwdriver (one is included with your unit), set the Frequency Select Switches to CC. (for Change, Change).
- 4) Toggle the power switch ON briefly – just long enough for the LED's to light up and then turn it OFF.
- 5) Change the Frequency Select Switches to one of the following settings:
 - 100 Series mode: 1,1
 - 200 Series mode: 2,2
 - Mode 3: 3,3
 - 400 Series mode: 4,4
 - IFB Series mode: 5,5
 - Mode 6: 6,6
- 6) Toggle the power switch ON, then OFF again.
- 7) Change the Frequency Select Switches to 0,0.
- 8) Turn the transmitter ON to complete the operation.

The LEDs will blink to indicate the selected compatibility mode. Immediately after power up, all LEDs will blink together red, then green, followed by the audio level LEDs (-20 and -10) blinking to indicate the mode.

The LEDs will blink:

- **Once for 100 Series mode**
- **Two times for 200 Series mode**
- **Three times for some other receivers**
- **Four times for 400 Series mode**
- **Five times for IFB mode**
- **Six times for Mode 6**

Note: Each time the transmitter is turned on, the Modulation LEDs will confirm the current operating mode with the number of blinks listed in Step 2. The mode setting will not change until it is reset with the procedure listed above.

Attention: During the procedure to set the compatibility mode, each step between toggles of the power switch must be performed within ten seconds, or the procedure must be started from the beginning.

Frequency Select Switch Settings (C,C)

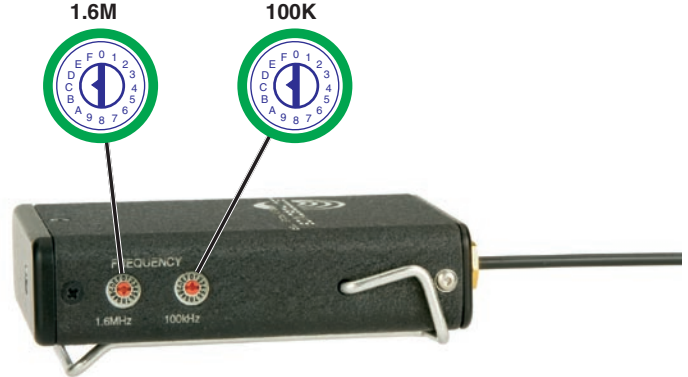

Attaching a Microphone or Musical Instrument and Adjusting Audio Levels

The front panel Modulation LEDs indicate input level and limiter activity. (See Modulation LED Signal Level Table.) Since the distortion introduced by the limiter is minimal and full modulation is assured, occasional red flickering of the -20 LED is desirable.

Different voices or instruments will usually require different settings of the AUDIO LEVEL control, so check this adjustment as each new person uses the system. If several different people will be using the transmitter and there is not time to make the adjustment for each individual, adjust it for the loudest voice.

Musicians also vary their volume depending on the nature of the music. It is suggested that the transmitter be adjusted for the passage with the loudest volume.

- 1) If necessary, install a fresh battery.
- 2) Insert the 5-pin into the input jack. Ensure the pins are aligned and the connector locks in (it will click).
For those using a musical instrument, insert the 1/4 inch plug on the other end of the instrument cable into the appropriate jack on your musical instrument.
- 3) Mute the main sound system or amplifier and rotate the AUDIO LEVEL control on the transmitter to maximum counterclockwise (Off).
- 4) Set the transmitter Power switch to ON.
- 5) For microphone users, position the microphone in the location where it will be used in actual operation.

For musicians, adjust the instrument volume controls to the highest levels that would be used during a performance.

Adjusting the Transmitter Frequency



Frequency Select Switch Settings

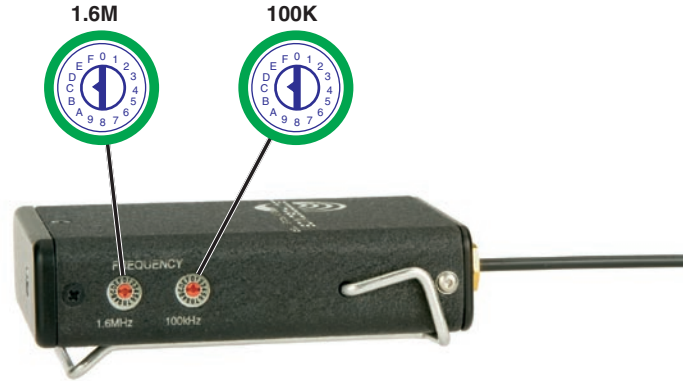

The left switch adjusts the operating frequency of the transmitter up or down in 1.6 MHz steps. The right switch adjusts the operating frequency of the transmitter up or down in 100 kHz steps. It is suggested to use the metering on the associated receiver to find a clear channel. Turn the transmitter off and leave the receiver turned on.

All 400 Series (and a number of earlier receivers) offer front panel LCDs that indicate the correct transmitter switch settings, and built in scanning functions to help locate clear channels. Use the scanning functions on these receivers to find a clear channel, then switch the transmitter to the frequency settings indicated in the receiver's display.

The R400A, Venue Series and other Lectrosonics receivers have an automatic scanning function called SmartTune™ that automatically locates clear operating channels. If your receiver does not have a built in scanning function, manually tune the receiver across its band and find a frequency where little or no RF activity is indicated.

After finding a clear channel, set the transmitter to this new frequency, then turn it on and make sure the RF signal is strongly indicated at the receiver. Be sure the switch settings between the receiver and transmitter are set exactly the same. If, for example, the 100K switch is one click above or below the desired frequency, the receiver will indicate RF, but no audio (or severely distorted audio) will be produced.

Modulation LED Signal Level Table

Signal Level	-20 LED	-10 LED
Less than -20 dB	● Off	● Off
-20 dB to -10 dB	● Green	● Off
-10 dB to +0 dB	● Green	● Green
+0 dB to +10 dB	● Red	● Green
Greater than +10 db	● Red	● Red

6) For microphone users, observe the Modulation LEDs while speaking or singing at the same voice level that will be used during the program. Gradually rotate the AUDIO LEVEL control clockwise until the -10 LED glows green and the -20 dB glows green with occasional red flickers. This indicates full modulation and is the optimum setting for the transmitter's gain.

For musicians, gradually rotate the AUDIO LEVEL control clockwise while playing the loudest notes that will be played during the performance. It is ideal for the -20 LED to briefly flicker red during the loudest passages.

7) Once the transmitter's audio gain has been set, the remaining components of the audio system can be energized and adjusted.

Warning: DO NOT use the audio level control for controlling the volume of your sound system or recorder levels. This gain adjustment matches the transmitter gain with the user's voice level and microphone positioning, or the instrument output level.

5-Pin Input Jack Wiring

The wiring diagrams included in this section represent the basic wiring necessary for the most common types of microphones and other audio inputs. Some microphones may require extra jumpers or a slight variation on the diagrams shown.

It is virtually impossible to keep completely up to date on changes that other manufacturers make to their products, thus you may encounter a microphone that differs from these instructions. If this occurs please call our toll-free number listed under Service and Repair in this manual or visit our web site at:

www.lectrosonics.com

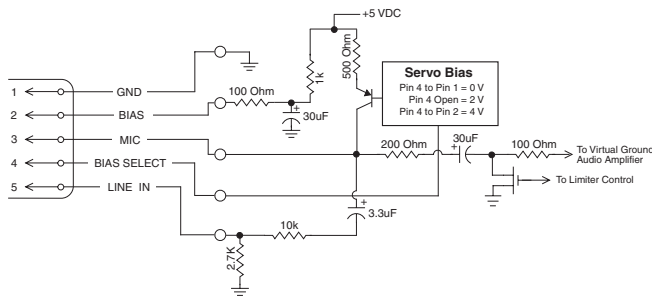

Audio input jack wiring:

- PIN 1** Shield (ground) for positive biased electret lavalier microphones. Shield (ground) for dynamic microphones and line level inputs.
- PIN 2** Bias voltage source for positive biased electret lavalier microphones.
- PIN 3** Low impedance microphone level input for dynamic microphones. Also accepts hand-held electret microphones provided the microphone has its own built-in battery.
- PIN 4** Bias voltage selector for Pin 3. Pin 3 voltage (0, 2 or 4 volts) depends on Pin 4 connection.
 - Pin 4 tied to Pin 1: 0 V
 - Pin 4 Open: 2 V
 - Pin 4 to Pin 2: 4 V
- PIN 5** High impedance, line level input for tape decks, mixer outputs, musical instruments, etc.

Microphone RF Bypassing

When used on a wireless transmitter, the microphone element is in the proximity of the RF coming from the transmitter. The nature of electret microphones makes them sensitive to RF, which can cause problems with the microphone/transmitter compatibility. If the electret microphone is not designed properly for use with wireless transmitters, it may be necessary to install a chip capacitor in the mic capsule or connector to block the RF from entering the electret capsule.

Some mics require RF protection to keep the radio signal from affecting the capsule, even though the transmitter input circuitry is already RF bypassed (see schematic diagram).

If the mic is wired as directed, and you are having difficulty with squealing, high noise, or poor frequency response, RF is likely to be the cause.

The best RF protection is accomplished by installing RF bypass capacitors at the mic capsule. If this is not possible, or if you are still having problems, capacitors can be installed on the mic pins inside the TA5F connector housing.

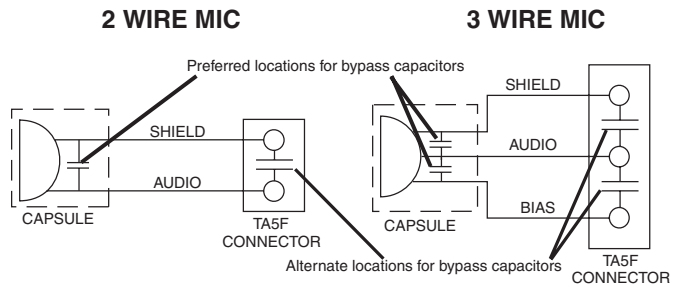

Install the capacitors as follows: Use 330 pF capacitors. Capacitors are available from Lectrosonics. Please specify the part number for the desired lead style.

- Leaded capacitors: P/N 15117
- Leadless capacitors: P/N SCC330P

All Lectrosonics lavalier mics are already bypassed and do not need any additional capacitors installed for proper operation.

Line Level Signals

The normal hookup for line level signals is: Signal Hot to pin 5, Signal Gnd to pin 1 and pin 4 jumped to pin 1. This allows signal levels up to 3V RMS to be applied without limiting.

If more headroom is needed, insert a 20 k resistor in series with pin 5. Put this resistor inside the TA5F connector to minimize noise pickup.

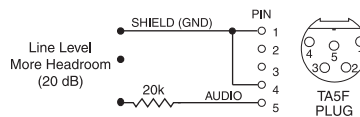
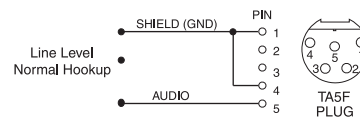

Microphone Cable Termination for Non-Lectrosonics Microphones

TA5F Connector Assembly

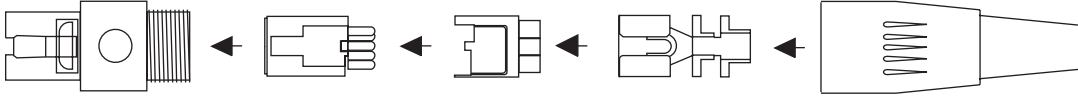

Mic Cord Stripping Instructions

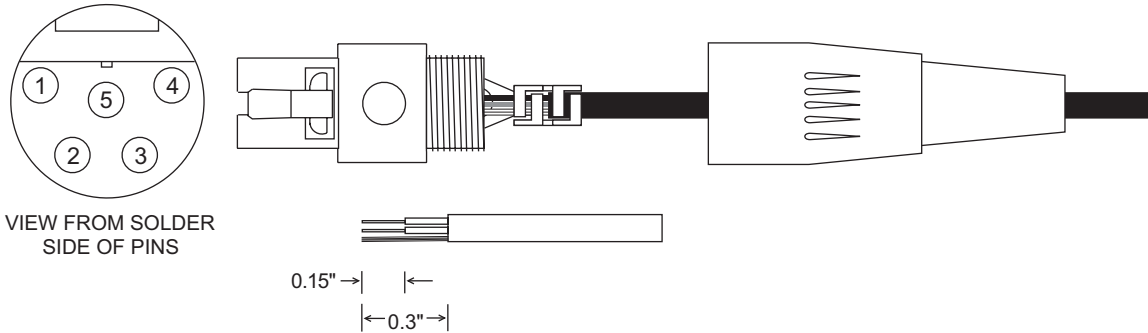

Crimping to Shield and Insulation

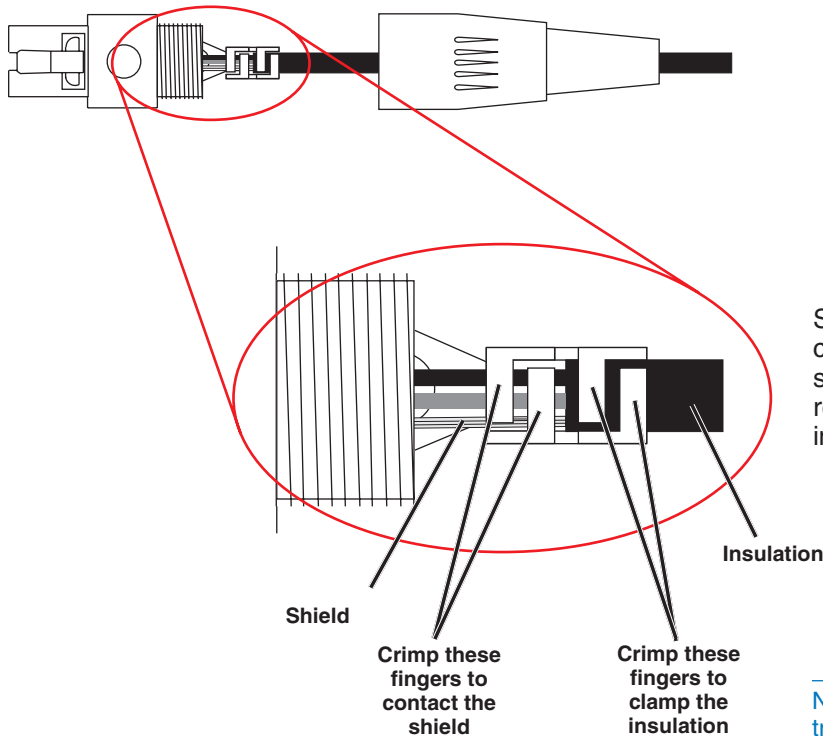

Strip and position the cable so that the clamp can be crimped to contact both the mic cable shield and the insulation. The shield contact reduces noise with some microphones and the insulation clamp increases ruggedness.

NOTE: This termination is intended for UHF transmitters only. VHF transmitters with 5-pin jacks require a different termination. Lectrosonics lavalier microphones are terminated for compatibility with VHF and UHF transmitters, which is different than what is shown here.

Wiring Hookups for Different Sources

In addition to the microphone and line level wiring hookups illustrated below, Lectrosonics makes a number of cables and adapters for other situations such as connecting musical instruments (guitars, bass guitars, etc.) to the transmitter. Visit www.lectrosonics.com and click on Accessories, or download the master catalog.

A lot of information regarding microphone wiring is also available in the FAQ section of the web site at:

<http://www.lectrosonics.com/faq.htm>

Follow the instructions to search by model number or other search options.

Compatible Wiring for Both Servo Bias Inputs and Earlier Transmitters:

2 VOLT POSITIVE BIAS 2-WIRE ELECTRET

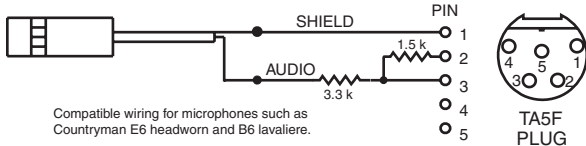

4 VOLT POSITIVE BIAS 2-WIRE ELECTRET

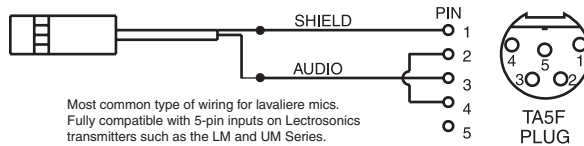

2 VOLT POSITIVE BIAS 2-WIRE ELECTRET - DPA MICROPHONES

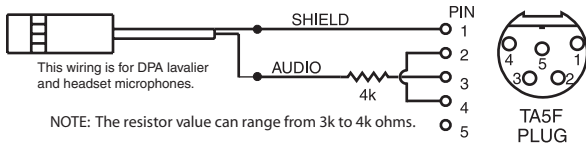

UNBALANCED LINE LEVEL SIGNALS

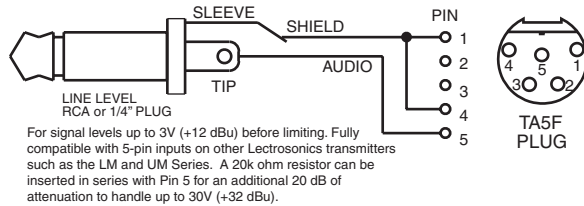

2 VOLT NEGATIVE BIAS 2-WIRE ELECTRET

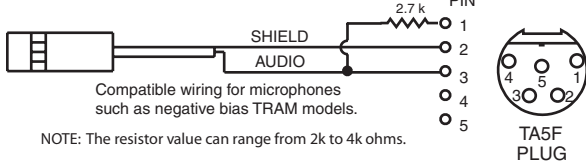

BALANCED AND FLOATING LINE LEVEL SIGNALS

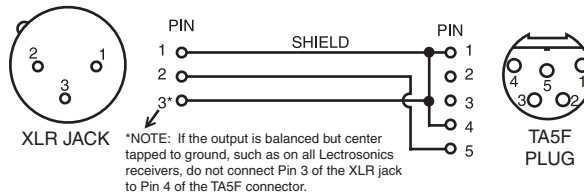

4 VOLT POSITIVE BIAS 3-WIRE ELECTRET WITH EXTERNAL RESISTOR

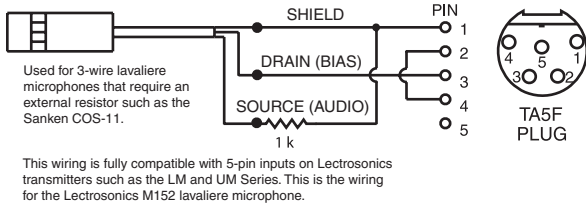

LO-Z MICROPHONE LEVEL SIGNALS

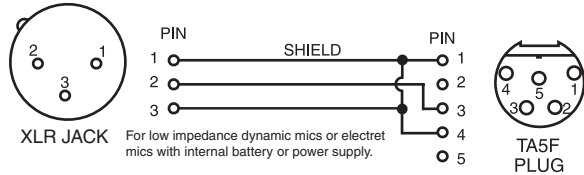

Simple Wiring for Servo Bias Inputs Only:

2 VOLT POSITIVE BIAS 2-WIRE ELECTRET

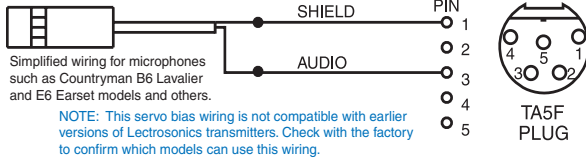

4 VOLT POSITIVE BIAS 3-WIRE ELECTRET

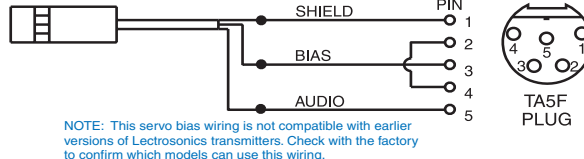

2 VOLT NEGATIVE BIAS 2-WIRE ELECTRET

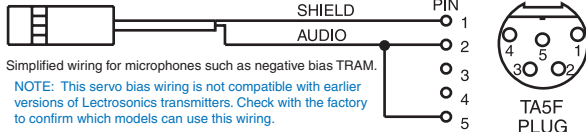

Wiring Diagram for MI33A Instrument Cable

The MI33ARA and MI33AST instrument cable assemblies allow an optimum match between musical instrument pickups and Lectrosonics transmitters with 5-pin input connectors. The low frequency roll-off in the LMA will be set to 35 Hz automatically when these cables are connected.

The active preamp and low noise wire cable provide a “same as wire” experience in a wireless environment.

The 30 inch long cable offers enough cable to comfortably link the instrument to the wireless transmitter without being excessive.

Note: This cable is prewired and cannot be field modified. The cable is available in two configurations, MI33ARA (right angle) and MI33AST (straight).

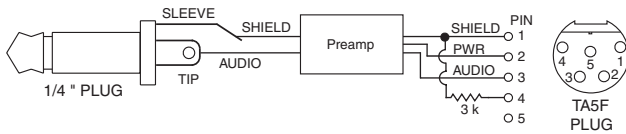

Troubleshooting

It is important that you follow these steps in the sequence listed.

Symptom:

Possible Cause:

Transmitter Battery LED off when Power Switch “ON”

1. Battery is inserted backwards.
2. Battery is dead.

No Transmitter Modulation LEDs when Signal Should be Present

1. Gain control turned all the way down.
2. Battery is in backwards. Check power LED.
3. Mic capsule is damaged or malfunctioning.
4. Mic cable damaged or miswired.
5. Instrument Cable damaged or not plugged in.
6. Musical instrument output level set too low.

Receiver Indicates RF But No Audio

1. Audio source or cable connected to transmitter is defective. Try using an alternate source or cable.
2. Make sure the compatibility mode is the same on transmitter and receiver.
3. Ensure musical instrument volume control is not set to minimum.

Receiver RF Indicator Off

1. Ensure that the transmitter and receiver Frequency Select Switches are set to the same frequency.
2. Transmitter not turned on, or battery is dead.
3. Receiver antenna missing or improperly positioned.
4. Transmitter and receiver not on same frequency. Check switches/display on transmitter and receiver.
5. Operating distance is too great.

No Sound (Or Low Sound Level), Receiver Indicates Proper Audio Modulation

1. Receiver output level set too low.
2. Receiver output is disconnected; cable is defective or miswired.
3. Sound system or recorder input is turned down.

Distorted Sound

1. Transmitter gain (audio level) is too high. Check Modulation LEDs on transmitter and receiver while distortion is being heard.
2. Receiver output level may be mismatched with the sound system or recorder input. Adjust output level on receiver to the correct level for the recorder, mixer or sound system.
3. Transmitter and receiver may not be set to the same compatibility mode. Some mis-matched combinations will pass audio.
4. RF interference. Reset both transmitter and receiver to a clear channel.

Wind Noise or Breath “Pops”

1. Reposition microphone, or use a larger windscreen, or both.
2. Omni-directional mics produce less wind noise and breath pops than directional types.

Hiss and Noise -- Audible Dropouts

1. Transmitter gain (audio level) far too low.
2. Receiver antenna missing or obstructed.
3. Operating distance too great.
4. RF interference. Reset both transmitter and receiver to a clear channel.
5. Musical instrument volume set too low.

Excessive Feedback (With Microphone)

1. Transmitter gain (audio level) too high. Check gain adjustment and/or reduce receiver output level.
2. Microphone too close to speaker system.
3. Microphone is too far from user’s mouth.

Specifications and Features

Operating frequencies:

Block 470	470.100 - 495.600
Block 19	486.400 - 511.900
Block 20	512.000 - 537.500
Block 21	537.600 - 563.100
Block 22	563.200 - 588.700
Block 23	588.800 - 607.900 and 614.100 - 614.300
Block 24	614.400 - 639.900
Block 25	640.000 - 665.500
Block 26	665.600 - 691.100
Block 27	691.200 - 716.700
Block 28	716.800 - 742.300
Block 29	742.400 - 767.900

(Frequency usage varies by country)

Frequency Selection:	256 frequencies in 100 kHz steps
Channel Separation:	100 kHz
Compatibility Modes:	Lectrosonics 400 Series (Digital Hybrid), 200 Series, 100 Series, and IFB. Mode 3, Mode 6 (Other brands).
RF Power output:	Greater than 50 mW
Pilot tone:	25 to 32 kHz frequency; 5 kHz deviation (400 Series only)
Frequency stability:	± 0.002%
Deviation:	± 75 kHz max. (200 & 400 Series Modes)
Spurious radiation:	60 dB below carrier
Equivalent input noise:	-120 dBV, A-weighted
Input level:	
If set for dynamic mic:	0.5 mV to 50 mV before limiting. Greater than 1 V with limiting.
If set for electret lavalier mic:	1.7 uA to 170 uA before limiting. Greater than 5000 uA (5 mA) with limiting.
Line level input:	5.0 mV to 6 V before limiting. Greater than 15 V with limiting.
Input impedance:	
Dynamic mic:	300 Ohms
Electret lavalier:	Input is virtual ground with servo adjusted constant current bias
Line level:	2.7 k Ohms
Input limiter:	Dual envelope, >30 dB range
	(Note: The dual envelope "soft" limiter provides exceptionally good handling of transients using variable attack and release time constraints.)
Gain control range:	43 dB; semi-log rotary control
Modulation indicators:	Dual bicolor LEDs indicate modulation of -20, -10, 0, +10 dB referenced to full modulation.
Low frequency roll-off:	Microphone: -12 dB/octave; -3 dB @ 70 Hz Instrument Cable: -12 dB/octave; -3 dB @ 35 Hz
Audio frequency response (overall system):	Microphone : 90 Hz to 20 kHz (+/- 1 dB) with the 70Hz low frequency roll-off filter. Instrument Cable : 40 Hz to 20 kHz (+/- 1 dB)
Controls:	2 position "OFF-ON" slide switch for noiseless turn on/turn off operation. Front panel audio gain control. Rotary switches on side panel adjust transmitter frequency.
Audio Input Jack:	Switchcraft 5 pin locking (TA5F)
Antenna:	Galvanized steel, flexible wire.
Battery:	Precision compartment auto-adjusts to accept any known alkaline 9 volt battery.
Battery Life:	6 hours (alkaline); 7 hours (LiPolymer); 13 hours continuous (lithium)
Weight:	6.3 ozs. including battery
Dimensions:	3.1 x 2.4 x .75 inches
Emission Designator:	180KF3E

The FCC requires that the following statement be included in this manual:

This device complies with FCC radiation exposure limits as set forth for an uncontrolled environment. This device should be installed and operated so that its antenna(s) are not co-located or operating in conjunction with any other antenna or transmitter.

Specifications subject to change without notice

Service and Repair

If your system malfunctions, you should attempt to correct or isolate the trouble before concluding that the equipment needs repair. Make sure you have followed the setup procedure and operating instructions. Check the interconnecting cables and then go through the **Troubleshooting** section in this manual.

We strongly recommend that you **do not** try to repair the equipment yourself and **do not** have the local repair shop attempt anything other than the simplest repair. If the repair is more complicated than a broken wire or loose connection, send the unit to the factory for repair and service. Don't attempt to adjust any controls inside the units. Once set at the factory, the various controls and trimmers do not drift with age or vibration and never require readjustment. **There are no adjustments inside that will make a malfunctioning unit start working.**

LECTROSONICS' Service Department is equipped and staffed to quickly repair your equipment. In warranty repairs are made at no charge in accordance with the terms of the warranty. Out-of-warranty repairs are charged at a modest flat rate plus parts and shipping. Since it takes almost as much time and effort to determine what is wrong as it does to make the repair, there is a charge for an exact quotation. We will be happy to quote approximate charges by phone for out-of-warranty repairs.

Returning Units for Repair

For timely service, please follow the steps below:

- A.** DO NOT return equipment to the factory for repair without first contacting us by email or by phone. We need to know the nature of the problem, the model number and the serial number of the equipment. We also need a phone number where you can be reached 8 A.M. to 4 P.M. (U.S. Mountain Standard Time).
- B.** After receiving your request, we will issue you a return authorization number (R.A.). This number will help speed your repair through our receiving and repair departments. The return authorization number must be clearly shown on the **outside** of the shipping container.
- C.** Pack the equipment carefully and ship to us, shipping costs prepaid. If necessary, we can provide you with the proper packing materials. UPS is usually the best way to ship the units. Heavy units should be "double-boxed" for safe transport.
- D.** We also strongly recommend that you insure the equipment, since we cannot be responsible for loss of or damage to equipment that you ship. Of course, we insure the equipment when we ship it back to you.

Lectrosonics USA:

Mailing address:

Lectrosonics, Inc.
PO Box 15900
Rio Rancho, NM 87174
USA

Shipping address:

Lectrosonics, Inc.
581 Laser Rd.
Rio Rancho, NM 87124
USA

Telephone:

(505) 892-4501
(800) 821-1121 Toll-free
(505) 892-6243 Fax

Web:

www.lectrosonics.com

E-mail:

sales@lectrosonics.com

Lectrosonics Canada:

Mailing Address:

49 Spadina Avenue,
Suite 303A
Toronto, Ontario M5V 2J1

Telephone:

(416) 596-2202
(877) 753-2876 Toll-free
(877-7LECTRO)
(416) 596-6648 Fax

E-mail:

Sales: colinb@lectrosonics.com
Service: joeb@lectrosonics.com

LIMITED ONE YEAR WARRANTY

The equipment is warranted for one year from date of purchase against defects in materials or workmanship provided it was purchased from an authorized dealer. This warranty does not cover equipment which has been abused or damaged by careless handling or shipping. This warranty does not apply to used or demonstrator equipment.

Should any defect develop, Lectrosonics, Inc. will, at our option, repair or replace any defective parts without charge for either parts or labor. If Lectrosonics, Inc. cannot correct the defect in your equipment, it will be replaced at no charge with a similar new item. Lectrosonics, Inc. will pay for the cost of returning your equipment to you.

This warranty applies only to items returned to Lectrosonics, Inc. or an authorized dealer, shipping costs prepaid, within one year from the date of purchase.

This Limited Warranty is governed by the laws of the State of New Mexico. It states the entire liability of Lectrosonics Inc. and the entire remedy of the purchaser for any breach of warranty as outlined above. NEITHER LECTROSONICS, INC. NOR ANYONE INVOLVED IN THE PRODUCTION OR DELIVERY OF THE EQUIPMENT SHALL BE LIABLE FOR ANY INDIRECT, SPECIAL, PUNITIVE, CONSEQUENTIAL, OR INCIDENTAL DAMAGES ARISING OUT OF THE USE OR INABILITY TO USE THIS EQUIPMENT EVEN IF LECTROSONICS, INC. HAS BEEN ADVISED OF THE POSSIBILITY OF SUCH DAMAGES. IN NO EVENT SHALL THE LIABILITY OF LECTROSONICS, INC. EXCEED THE PURCHASE PRICE OF ANY DEFECTIVE EQUIPMENT.

This warranty gives you specific legal rights. You may have additional legal rights which vary from state to state.

