

SMa Series

Super Miniature Belt-Pack Transmitters

With Digital Hybrid Wireless™ Technology



- SMa** Single battery, 100 mW
- SMDa** Dual battery, 100 mW
- SMQa** Dual battery, 250 mW
- RM** Remote Control for SM Transmitters

**Digital Hybrid Wireless
US Patent 7,225,135**

Fill in for your records:

Serial Number:

Purchase Date:

Thank you for selecting a Lectrosonics SM Series ultra-miniature transmitter. The unique design provides several distinct features for professional applications:

- Outstanding RF operating range
- Superb audio quality
- Ultra-lightweight, corrosion resistant housing
- Water resistant seals for use in damp environments
- Programmable compatibility modes for use with a wide variety of different receivers

The Digital Hybrid Wireless™ design (US Patent 7,225,135) combines 24-bit digital audio with analog FM resulting in a system that has the same operating range as analog systems, the same spectral efficiency as analog systems, the same long battery life as analog systems, plus the excellent audio fidelity typical of pure digital systems.

The SM Series transmitters use a standard Lectrosonics 5-pin type input jack for use with electret lavalier mics, dynamic mics, or line level signals. A water resistant control panel with LCD, membrane switches and multi-color LEDs make input gain adjustments and frequency and compatibility mode selection quick and accurate, without having to view the receiver. The battery compartment accepts AA lithium or rechargeable batteries. The SM is machined from a solid aluminum block to provide an extremely lightweight and rugged package. A special non-corrosive finish resists salt water exposure and perspiration in extreme environments.

The DSP-based design works with all Digital Hybrid receivers, and is backward compatible for use with Lectrosonics 200 and 100 Series and IFB receivers and some other brands of analog wireless receivers. Companion receivers are covered in separate manuals.

Table of Contents

- General Technical Description 4**
- Controls and Functions 6**
 - LCD Screen 6
 - Power LED 6
 - Audio Input Jack..... 6
 - Battery Compartment and Thumb Screw..... 6
 - Modulation LEDs..... 6
 - Audio Button 6
 - Freq Button 6
 - Up/Down Arrows 6
 - Antenna..... 6
- Setup with the LCD..... 7**
 - Audio Screen 7
 - Frequency Screen 7
 - Compatibility Mode Screen 7
 - Turning the Power On 7
 - Turning the Power Off 7
 - Entering the Standby Mode 7
 - Lock/Unlock Screen 7
- Battery Installation 8**
 - Remote Control Operation 8
- Operating Instructions 9**
 - Power Up and Boot Sequence 9
 - Power Down 9
 - Standby Mode..... 9
 - Selecting the Compatibility Mode..... 9
 - Setting Transmitter Operating Frequency..... 10
 - Adjusting the Low Frequency Roll-off 10
 - Attaching a Microphone and Adjusting Gain..... 10
 - Locking or Unlocking the Control Panel 10
 - Attaching and Removing the Microphone 11
 - Locking or Unlocking the Control Panel 11
 - Attaching and Removing the Microphone 11
- 5-Pin Input Jack Wiring 12**
 - Installing the Connector: 12
- Cable Termination for Non-Lectrosonics Microphones 13**
 - Microphone RF Bypassing..... 14
 - Line Level Signals 14
- Wiring Hookups for Different Sources 15**
 - Works with Servo Bias Inputs Only:..... 15
 - Works with Servo Bias Inputs and Earlier Transmitters:..... 15
- RM Remote Control Operating Instructions 16**
 - RM Front Panel Controls..... 16
 - Powering the RM on and off..... 16
 - Principles of Operation..... 16
 - RM Pages 16
 - Operating Notes..... 17
 - RM Quick Reference..... 17
- Troubleshooting..... 18**
 - RM Troubleshooting 19
- Specifications and Features..... 21**
- Service and Repair 22**
 - Returning Units for Repair 22

General Technical Description

Wideband Design

The SM transmitters use ± 75 kHz wide deviation for an excellent signal to noise ratio and wide dynamic range. The DSP controlled input limiter features a wide range dual envelope design which cleanly limits input signal peaks over 30 dB above full modulation. Switching power supplies to provide constant voltages to the transmitter circuits from the beginning (1.5 Volts) to the end (0.85 Volts) of battery life, and an ultra low noise input amplifier for quiet operation.

Servo Input

The SM input is a radically different input system compared to previous Lectrosonics transmitter microphone inputs. It is so superior that this input system will eventually be utilized by all Lectrosonics UHF transmitters. The improvements are audible and make the transmitters easier to use and much harder to overload. It is no longer necessary on some mics to introduce pads to prevent overload of the input stage, divide the bias voltage down for some low voltage mics, or reduce the limiter range at minimum gain settings.

Digital Hybrid Wireless™ Technology*

All wireless links suffer from channel noise to some degree, and all wireless microphone systems seek to minimize the impact of that noise on the desired signal. Conventional analog systems use companders for enhanced dynamic range, at the cost of subtle artifacts (known as “pumping” and “breathing”). Wholly digital systems defeat the noise by sending the audio information in digital form, at the cost of some combination of power, bandwidth and resistance to interference. *US Patent 7,225,135*

Lectrosonics Digital Hybrid Wireless™ systems overcome channel noise in a dramatically new way, digitally encoding the audio in the transmitter and decoding it in the receiver, yet still sending the encoded information via an analog FM wireless link. This proprietary algorithm is not a digital implementation of an analog compander but a technique that can be accomplished only in the digital domain, even though the inputs and outputs are analog.

Channel noise still impacts received signal quality and will eventually overwhelm a receiver. Digital Hybrid Wireless™ simply encodes the signal to use a noisy channel as efficiently and robustly as possible, yielding audio performance that rivals that of wholly digital systems, without the power and bandwidth problems inherent in digital transmission.

Because it uses an analog FM link, Digital Hybrid Wireless™ enjoys all the benefits of conventional FM wireless systems, such as excellent range, efficient use of RF spectrum, and resistance to interference. However, unlike conventional FM systems, it does away with the analog compander and its artifacts.

No Pre-Emphasis/De-Emphasis

The Digital Hybrid Wireless™ design results in a signal-to-noise ratio high enough to preclude the need for conventional pre-emphasis (HF boost) in the transmitter and de-emphasis (HF roll off) in the receiver. This eliminates the potential for extreme distortion on signals with abundant high-frequency information.

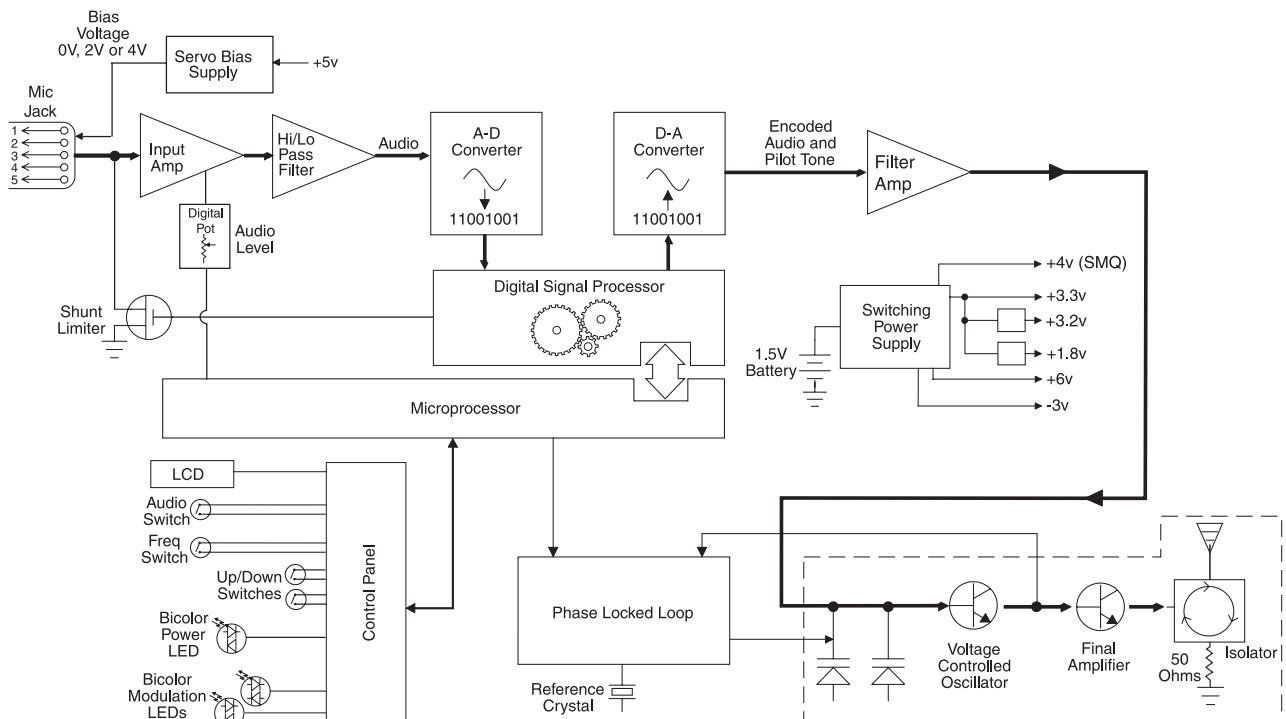

Low Frequency Roll-Off

The low frequency roll-off can be set for a 3 dB down point at 35, 50, 70, 100, 120 and 150 Hz to control sub-sonic and very low frequency audio content in the audio. The actual roll-off frequency will vary slightly depending upon the low frequency response of the microphone.

Excessive low frequency content can drive the transmitter into limiting, or in the case of high level sound systems, can even cause damage to loudspeaker systems. The roll-off is normally adjusted by ear while listening as the system is operating.

Input Limiter

A DSP-controlled analog audio limiter is employed before the analog-to-digital (A-D) converter. The limiter has a range of more than 30 dB for excellent overload protection. A dual release envelope makes the limiter acoustically transparent while maintaining low distortion. It can be thought of as two limiters in series, a fast attack and release limiter followed by a slow attack and release limiter. The limiter recovers quickly from brief transients, with no audible side effects, and also recovers slowly from sustained high levels, to keep audio distortion low and while preserving short term dynamics.

Signal Encoding and Pilot Tone

In addition to controlling the limiter, the DSP also encodes the digitized audio from the A-D converter and adds an ultrasonic pilot tone to control the receiver's squelch. A pilot tone squelch system provides a reliable method of keeping a receiver output muted (squelched) even in the presence of significant interference. When the system is operating in the hybrid mode, a different pilot tone frequency is generated for each carrier frequency to prevent inadvertent squelch problems and simplify multi-channel coordination.

Microprocessor, PLL and VCO Circuits

A microprocessor monitors user command inputs from the control panel buttons and numerous other internal signals. It works intimately with the DSP to ensure the audio is encoded according to the selected Compatibility Mode and that the correct pilot tone is added to the encoded signal.

Compatibility Modes

The SM transmitters were designed to operate with Lectrosonics Digital Hybrid receivers and will yield the best performance when doing so. However, due to the flexibility of digital signal processing, the transmitters can also operate in various compatibility modes for use with Lectrosonics 200 Series, Lectrosonics 100 Series, IFB and certain non-Lectrosonics receivers. Contact the Lectrosonics sales department for a complete list of compatible non-Lectrosonics receivers.

Control Panel

The control panel includes four membrane switches and an LCD screen to adjust the operational settings. Multi-color LEDs are used to indicate audio signal levels for accurate gain adjustment and for battery status.

Wide-Band Deviation

± 75 kHz deviation improves the signal to noise ratio and audio dynamic range of a wireless system dramatically, compared to other designs that use ± 30 kHz to 40 kHz deviation. Wide deviation combined with a high powered transmitters makes a significant improvement in signal to noise ratio and operating range.

Battery Options and Operating Time

Switching power supplies convert regulated battery voltages to operate various circuit stages with maximum efficiency. With the variety of alkaline, lithium and rechargeable NiMH batteries available today in the AA format, there are many choices to maximize operating time or minimize cost as needed for any application.

Frequency Blocks

Lectrosonics established a "block" numbering system years ago to organize the range of frequencies available from the low 500 MHz band to the upper 700 MHz band. Each block includes 256 frequencies in 100 kHz increments. The block number is part of a simple formula to derive the frequency. The block number is multiplied by 25.6 to produce the lowest frequency in the block. For example, block 27 x 25.6 = 691.200.

Circulator/Isolator

The RF output circuit includes a one way circulator/isolator using a magnetically polarized ferrite. This device greatly reduces the RF intermodulation produced when multiple transmitters are used in close proximity to one another (several feet apart). The isolator also provides additional RF output stage protection.

Controls and Functions

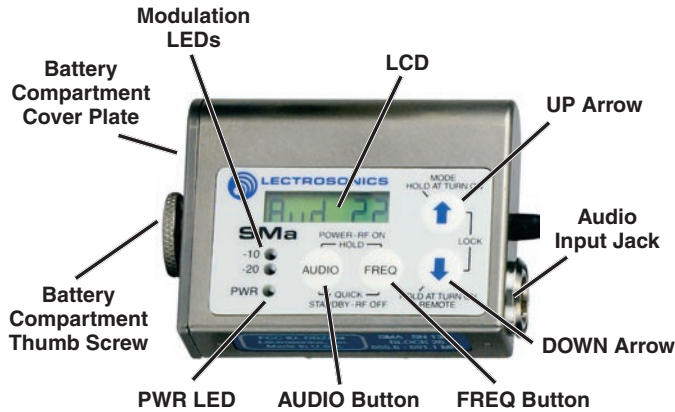

Modulation LEDs

The Modulation LEDs provide a visual indication of the input audio signal level from the microphone. These two bicolor LEDs can glow either red or green to indicate modulation levels. 0 dB in the table below indicates full modulation.

Signal Level	-20 LED	-10 LED
Less than -20 dB	● Off	● Off
-20 dB to -10 dB	● Green	● Off
-10 dB to +0 dB	● Green	● Green
+0 dB to +10 dB	● Red	● Green
Greater than +10 db	● Red	● Red

LCD Screen

The LCD is a numeric-type Liquid Crystal Display with several screens that allow settings to be made with the AUDIO, FREQ, UP and DOWN to configure the transmitter. Turn on and turn off countdowns appear in the LCD allowing the transmitter to be turned on for adjustments without the output stage enabled, and to prevent accidental turn off.

Power LED

The PWR LED glows green when the battery is good. The color changes to red when there is about 30 minutes of operation left with the recommended lithium battery. An alkaline battery will have about 20 minutes of life left. When the LED begins to blink red, there are only a few minutes of life.

Note: A NiMH battery will give little or no warning when it is depleted. If you wish to use NiMH batteries in the SM, we recommend trying fully charged batteries in the unit, noting the length of time that the batteries will run the unit and then using the battery timer feature available on most Digital Hybrid receivers.

A weak battery will sometimes cause the PWR LED to glow green immediately after being put in the unit, but will soon discharge to the point where the LED will go red or shut off completely. When the SM is in SLEEP mode, the LED blinks green every few seconds (See *Sleep Mode*, page 8).

Audio Input Jack

The Servo Bias input on the SM Series transmitters accommodates virtually every lavalier, handheld or shotgun microphone available, plus line level signals.

Battery Compartment and Thumb Screw

The large knurled thumbscrew is used to release or secure the Battery Compartment Cover Plate, allowing access to the battery.

Audio Button

The AUDIO button is used to display the audio level setting and low frequency roll-off. The UP and DOWN arrows adjust the values.

The AUDIO button is also used with the FREQ button to enter standby mode and to power the transmitter on or off.

Freq Button

The FREQ Button displays the selected operating frequency and also toggles the LCD between displaying the actual operating frequency in MHz and a two-digit hexadecimal number that corresponds to the equivalent Lectrosonics Frequency Switch Setting.

The FREQ button is also used with the AUDIO button to enter standby mode and to power the transmitter on or off.

Up/Down Arrows

The Up and Down arrow buttons are used to select the operating frequency, adjust the audio level, or set the Compatibility Mode.

Pressing both arrows simultaneously enters the lock countdown. Holding the two arrow buttons until the countdown completes locks the control panel buttons so they can only be used to display current settings. "Loc" is displayed to indicate the controls are locked.

Once locked, the buttons can be unlocked only by removing the battery, or via the RM remote control (if this function was enabled in the transmitter setup).

Antenna

The flexible antenna is built with woven, galvanized steel mesh cable, cut to the 1/4 wavelength of the center of the frequency block of the transmitter. The antenna is extremely rugged and moisture resistant.

Setup with the LCD

Six screens are used to set up and operate the SM. These screens are used to set the operating frequency, adjust the audio input level, select the Compatibility Mode or lock the control panel and power down the transmitter.

Audio Screen

The Audio screen is used to adjust input gain from 0 to +44 dB, and the low frequency roll-off from 35 to 150 Hz. Repeatedly pressing the AUDIO button toggles back and forth between the two displays. Press and hold the AUDIO button and use the Up and Down arrows to make adjustments.

Frequency Screen

The Frequency Screen displays the operating frequency in MHz or as a two-digit hexadecimal number that corresponds to the equivalent Lectrosonics Frequency Switch Setting. Pressing the FREQ button toggles between the two displays.

Compatibility Mode Screen

Holding down the Up arrow button while powering up the SM opens the Compatibility Mode screen. By using the Up or Down arrow buttons, the user can select one of six compatibility modes:

Note: RF transmission is prevented while selecting Compatibility Modes. Also, the SM exits the Compatibility Mode screen to Standby Mode.

- 400 - This is the factory default setting and works with all Lectrosonics 400 Series Digital Hybrid Wireless™ receivers, including the Venue. This mode offers the best audio quality.
- 200 - This mode works with all Lectrosonics 200 Series compatible receivers.
- 100 - This mode works with all Lectrosonics 100 Series compatible receivers.
- 3 - (Mode 3) This mode works with a number of non-Lectrosonics analog receivers. Contact the company for a list of compatible receivers.
- IFB - This mode works with all Lectrosonics IFB compatible receivers.
- 6 - (Mode 6) This mode works with a number of non-Lectrosonics analog receivers. Contact the company for a list of compatible receivers.

While in the compatibility mode screen, pressing either the AUDIO or FREQ button exits to standby mode. To power off from the compatibility mode screen, press and hold AUDIO and FREQ together.

Turning the Power On

With the power turned off, simultaneously pressing and holding the AUDIO and FREQ buttons displays a timer with numerals on the right. The numerals count up from one and the boot sequence begins when the count reaches three. "LECTro" is displayed as the boot sequence begins. If either button is release prior to the screen reaching numeral three, the unit will enter the Standby Mode with no RF output (see Standby Mode below).

Initial Power On
Timer Screen

Turning the Power Off

With the unit turned on, simultaneously holding the AUDIO and FREQ buttons starts a countdown timer with numerals on the right. The screen counts down from three and the transmitter turns off when it reaches zero. Releasing either button prior to the Power Off Timer screen indicating zero returns the unit to normal operation and displays the previous screen.

Initial Power Off
Timer Screen

Entering the Standby Mode

With the power turned off, pressing the AUDIO and FREQ buttons for about one second places the unit in Standby Mode. In this mode the RF output is turned off so all setup adjustments can be made without interfering with other systems operating in the same location. The screen displays "rf OFF" to remind the user that the unit is not transmitting.

Standby Screen

Holding the FREQ button in Standby Mode displays the current operating frequency of the transmitter. The operating frequency can be changed by holding the FREQ button and pressing either the Up or Down button. Release the FREQ button, then press and hold it again to toggle the display between frequency in MHz and the hex code corresponding to the equivalent Lectrosonics Frequency Switch Setting.

Holding the AUDIO button in Standby Mode displays the current audio input level setting. This level can be changed by holding the AUDIO button and pressing either the Up or Down button.

Quickly pressing both the FREQ and AUDIO buttons simultaneously when the unit is in Standby Mode powers off the transmitter.

Lock/Unlock Screen

Simultaneously pressing and holding both the Up and Down arrow buttons during normal operation starts the Lock timer. The timer starts at three and counts down to zero. When the timer reaches zero, the transmitter's controls are locked.

The LCD will display the locked condition as long as the arrow buttons are held, then revert back to the previous screen when either button is released.

With the controls locked, the AUDIO and FREQ buttons can still be used to display current settings. Any attempt to change a setting by pressing either the Up or Down arrow button will result in an on-screen “Loc” reminder that the controls are locked. Remove the batteries to unlock the control panel.

Important: *Once the transmitter is locked, it cannot be unlocked or powered off using the buttons. The only ways to unlock a locked transmitter are to remove the battery or unlock it via the RM remote control.*

Remote Control Operation

SM Series transmitters may be configured to respond to signals from the RM remote control unit or to ignore them. This setting is accessed by

holding down the Down arrow button while powering the transmitter on. Use the arrow keys to toggle between “rc on” (remote control on) and “rc off” (remote control off). The default setting is “rc on.”

If a remote control signal is detected but the transmitter is set to “rc off”, the message “rc off” will be displayed briefly on the transmitter’s LCD, to confirm that a valid signal was received, but that the transmitter is not configured to respond to it.

Functions available from the remote control are:

- Audio Level
- Frequency
- Lock/Unlock Buttons
- Sleep/Wake (power saving mode)

In sleep mode, the SM uses 20% of the normal amount of current. For example, in sleep mode it will drain the battery as much in five hours as it would do in one hour of normal operation. Sleep mode can only be invoked with the remote control, and can only be revoked with the remote control or by removing the battery. When in sleep mode, the PWR LED blinks green every few seconds to indicate that the SM is asleep and not turned off.

Note: The RM is not included with SM Series transmitters.

“Dweedle tones” can also be downloaded from the web site at: www.lectrosonics.com. Go to the SM Series transmitter page and follow the link.

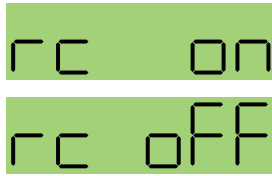

Remote Control Screens

Battery Installation

The SM transmitter is powered by a single standard AA 1.5 volt battery, while the SMD and SMQ use two AA batteries. We recommend using lithium batteries for longest life. In the SM, lithium batteries provide over 4.5 hours of operation at room temperature.

Note: Standard zinc-carbon batteries marked “heavy-duty” or “long-lasting” are not adequate.

The battery status circuitry is designed for the voltage drop over the life of lithium batteries.

To install new batteries:

1. Turn the Battery Cover Plate Thumbscrew counterclockwise, open the battery compartment and remove any old batteries.
2. Insert the new battery (or batteries) into the housing. The positive (+) battery terminal goes into the transmitter first.
3. Replace the Battery Cover Plate and tighten the Battery Cover Plate Thumbscrew.

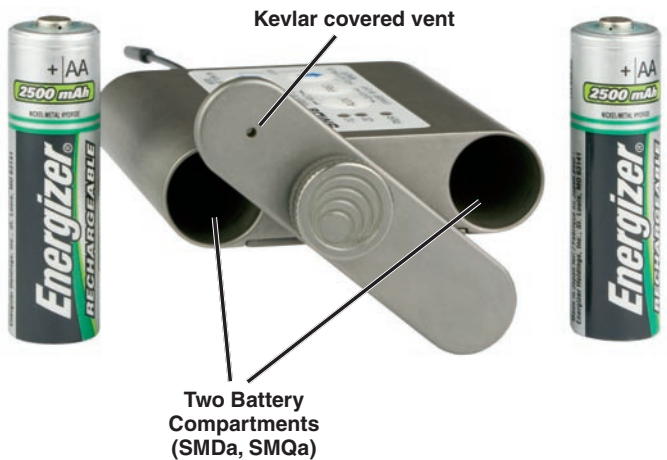
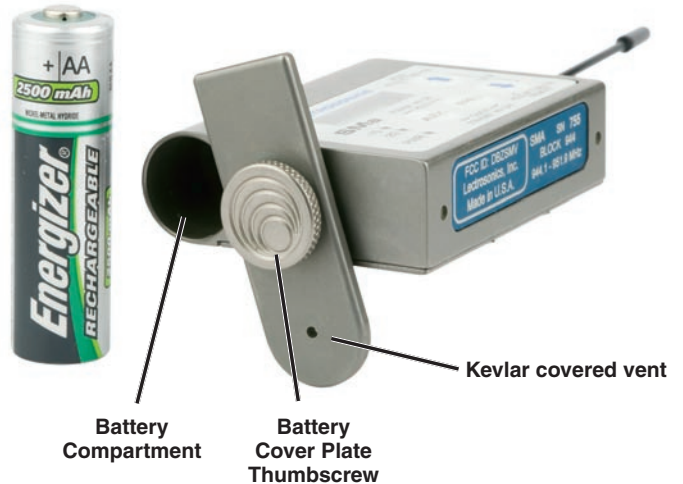

Operating Instructions

Power Up and Boot Sequence

- 1) Ensure that good batteries are installed in the unit. (See *Battery Installation*.)
- 2) Simultaneously press and hold the AUDIO and FREQ buttons until the Power On Boot Sequence is initiated. (See Power On Timer.) As the unit turns on, the Modulation LEDs and PWR LED all glow red, then green, and then they revert to normal operation, i.e., the Modulation LEDs glow according to the audio level present at the Audio Input Jack and the PWR LED glows green (with good batteries).

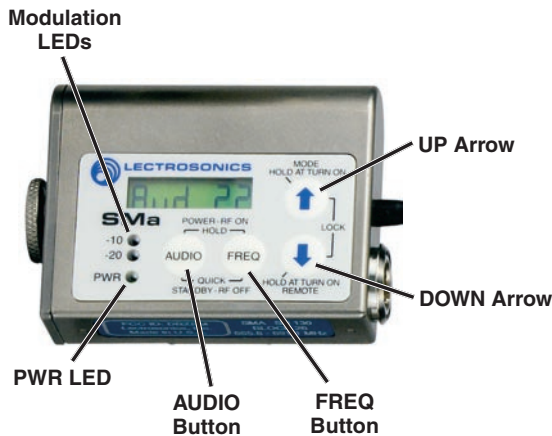

The LCD displays a bootup sequence which consists of four screens:

Company Name:	Lectro
Frequency Block (bXX) and Firmware Version (rX.X):	b21r1.1 (typ)
Compatibility Mode:	CP 400 (typ)
Audio:	Aud 12 (typ)

Power Down

- 1) Simultaneously press and hold the AUDIO and FREQ buttons while observing that the word "Off" appears in the LCD along with a counter.
- 2) When the counter reaches "0", the unit turns off.



Initial Power Off
Timer Screen

Note: If the AUDIO and FREQ buttons are released before the LCD goes blank at the end of the countdown, the unit will not turn off. Instead, it will stay energized and the display will return to the previous screen.

Standby Mode

Standby Mode allows the user to verify or change the transmitter's operating frequency or audio input level without transmitting any signals. Standby Mode can only be invoked from a power off condition.

Quickly press and release both the AUDIO and FREQ buttons simultaneously to enter and exit this mode.

Selecting the Compatibility Mode



400 Series or Digital
Hybrid Wireless™
Compatibility Mode

All Digital Hybrid Wireless™ receivers are capable of working with the Lectrosonics SM transmitter. By selecting the proper compatibility mode, the SM will also work with 200 Series, 100 Series and IFB analog receivers, plus some other analog wireless receivers (contact the factory for details). Setting the Compatibility Mode of the transmitter to match the receiver is easily done via the Control Panel.

Note: RF transmission is prevented while selecting Compatibility Modes. Also, the SM exits the Compatibility Mode screen to Standby Mode. (See Standby Mode, this section.)

Note: The unit comes from the factory configured as a 400 Series transmitter.

- 1) Set the receiver's audio controls to minimum.
- 2) Power up the SM and observe the Boot Sequence. If the Compatibility Mode for the SM does not match the corresponding receiver, then power off the SM transmitter.
- 3) From a power off condition, hold down the Up arrow, then simultaneously press the AUDIO and FREQ buttons.
- 4) The LCD will display the current Compatibility Mode. Use the Up or Down arrow buttons to set the Compatibility Mode to match the corresponding receiver.

The following Compatibility Modes are available:

- | | |
|--|--------|
| • 100 Series mode: | CP 100 |
| • 200 Series mode: | CP 200 |
| • Mode 3 (Contact dealer for details): | CP 3 |
| • 400 Series mode: | CP 400 |
| • IFB Series mode: | CP IFB |
| • Mode 6 (Contact dealer for details): | CP 6 |

- 5) The Compatibility Mode selected in Step 4 will be the current Compatibility Mode until reset using this procedure. Pressing the AUDIO or FREQ exits into Standby Mode. To power off from the compatibility mode screen, press AUDIO and FREQ together.

Setting Transmitter Operating Frequency

The Operating Frequency of the SM can be displayed either in MHz or as a two-digit hexadecimal number. (See *Controls and Functions, FREQ Button.*) The SM's operating frequency can be set with the unit in Standby Mode or powered up for normal operation. Use the following procedure to change the Operating Frequency of the SM transmitter:



Frequency displayed in MHz



Frequency displayed as two-digit hexadecimal number

- 1) If the LCD is displaying something other than the Frequency Screen, press the FREQ button on the SM Control Panel to enter this screen.

Note: The default display is in MHz. Pressing the FREQ button again displays the operating frequency as a two-digit hexadecimal number that corresponds the equivalent Lectrosonics Frequency Switch Setting.
- 2) While holding the FREQ button, use the Up or Down arrow buttons to move the operating frequency up or down in 100 kHz increments from the current setting.

Note: The operating frequency displayed on the LCD wraps as it reaches the upper or lower end of its range. Thus, if you intend to move the operating frequency from the lower end of the range to the upper end, it may be faster to do this by using the Down arrow until the frequency wraps to the upper end.

Most Lectrosonics receivers indicate the operating frequency both in MHz and as a two digit hexadecimal number. This conforms to the Lectrosonics tradition of setting the operating frequency using two 16-position rotary switches. The SM Series units offer the ability to set the operating frequency in a similar manner. Pressing the FREQ button while the LCD displays the operating frequency in MHz will change the display to show the equivalent two-digit hexadecimal frequency select switch setting. Simply use the UP or DOWN arrow to increase or decrease the operating frequency.

Adjusting the Low Frequency Roll-off

Repeatedly press the AUDIO button until the LF roll-off adjustment screen appears. Then press and hold the AUDIO button while selecting the desired roll-off frequency with the UP and DOWN arrows.



The roll-off frequency can be set to 35, 50, 70, 100, 120 and 150 Hz.

Attaching a Microphone and Adjusting Gain

The control panel Modulation LEDs indicate the modulation level and limiter activity. Once set, the transmitter's audio level setting **should not** be used to control the volume of your sound system or recorder levels. This gain adjustment matches the transmitter gain with the microphone's output level, the user's voice level and the position of the microphone. The audio input level can be set with the unit in Standby Mode or while powered up in normal operation.

Signal Level	-20 LED	-10 LED
Less than -20 dB	● Off	● Off
-20 dB to -10 dB	● Green	● Off
-10 dB to +0 dB	● Green	● Green
+0 dB to +10 dB	● Red	● Green
Greater than +10 db	● Red	● Red

Note: Different voices will usually require different settings of the AUDIO control, so check this adjustment as each new person uses the system. If several different people will be using the transmitter and there is not time to make the adjustment for each individual, adjust it for the loudest voice.

- 1) With the SM powered off, insert the microphone plug into the Audio Input Jack, aligning the pins and ensuring that the connector locks.

See the following page for suggestions on using the microphone connector and sleeve
- 2) Place the transmitter in Standby Mode, or if the unit is to be powered up and adjusted, mute the main sound system prior to powering up the transmitter.
- 3) Position the microphone in the location where it will be used in actual operation.
- 4) Observe the audio level LEDs while speaking or singing into the microphone at the same voice level that will be used during the program. While holding the AUDIO button, press the UP or DOWN arrow buttons until the both the -20 and -10 LEDs glow green, with the -20 LED occasionally flickering red. This will maximize the signal to noise ratio of the system with full modulation and provide subtle limiting to prevent overload and audible compression of signal peaks.

Note: Setting the audio level too high reduces the dynamic range of the audio signal. Setting the audio level too low may cause hiss and noise in the audio.
- 5) If the unit was set up in Standby Mode, it will be necessary to turn the transmitter off, then power it up again in normal operation so the RF output will be on. Then the other components in the sound or recording system can be adjusted.

Locking or Unlocking the Control Panel



Control Panel Locked

The Lock mode protects the transmitter from accidental changes to its settings.

- 1) Ensure the SM setup is complete (operating frequency, audio level, Compatibility Mode, sensitivity to remote control).
- 2) Simultaneously press both the Up and Down arrow buttons to start the Lock timer. When the timer reaches zero, "Loc" is displayed and the controls are locked.

Important: Once the transmitter is locked, it cannot be unlocked or powered off using the buttons. The only ways to unlock a locked transmitter are to remove the battery or unlock it via the remote control. The remote control will work only if the transmitter was previously configured to respond to the remote control. The unit will always power up in "unlocked" mode.

Attaching and Removing the Microphone

The flexible sleeve over the 5-pin plug on the microphone helps prevent dust and moisture from getting into the input jack. A flange is machined into the rim of the connector on the transmitter to help retain the sleeve after it is installed.

The following procedure simplifies the attachment and removal of the microphone to assure the sleeve is seated securely.



1 Pull the sleeve over the connector so the ends of the connector and sleeve are almost flush.



2 Align the pins on the plug and jack and insert the connector.

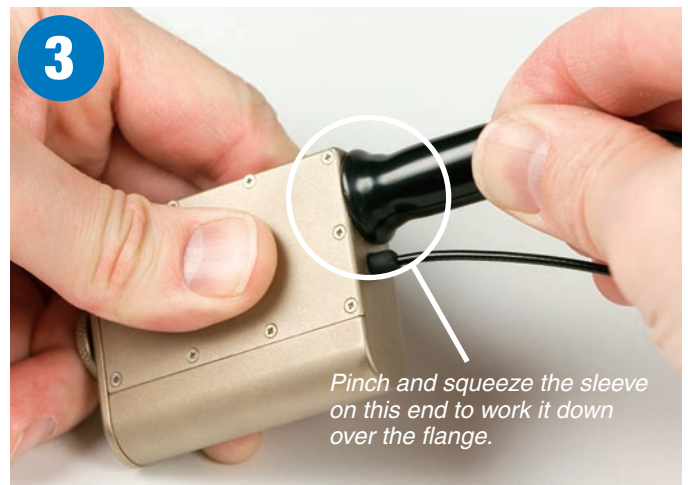

3 Pinch and squeeze the sleeve on this end to work it down over the flange.

Squeeze the end of the sleeve so you can feel the connector inside and press it into the jack until it latches. Pinch and squeeze the sleeve near the flange and work it down with a kneading motion over the flange all the way around until it stays in place flush with the housing. Pull on the connector to make sure it is firmly latched.

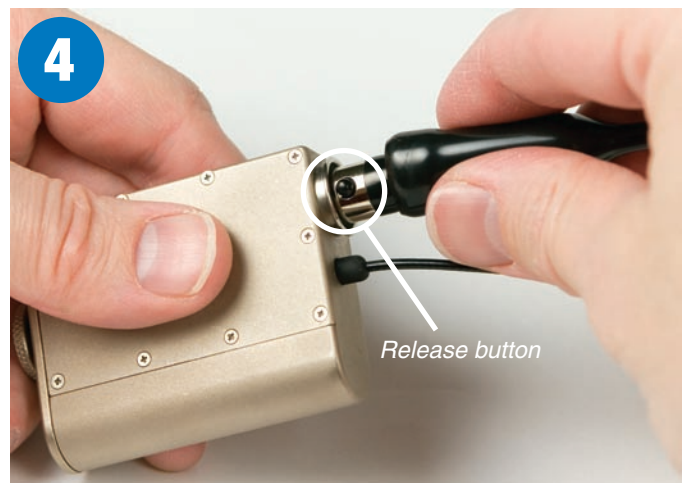

4 Release button

To remove the connector, pull the sleeve back to expose the black release button. Press the button to unlatch the plug.

5-Pin Input Jack Wiring

The wiring diagrams included in this section represent the basic wiring necessary for the most common types of microphones and other audio inputs. Some microphones may require extra jumpers or a slight variation on the diagrams shown.

It is virtually impossible to keep completely up to date on changes that other manufacturers make to their products, thus you may encounter a microphone that differs from these instructions. If this occurs please call our toll-free number listed under Service and Repair in this manual or visit our web site at:

www.lectrosonics.com

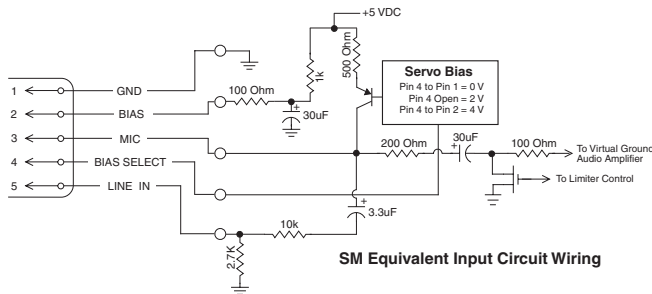

Audio input jack wiring:

- PIN 1** Shield (ground) for positive biased electret lavalier microphones. Shield (ground) for dynamic microphones and line level inputs.
- PIN 2** Bias voltage source for positive biased electret lavalier microphones.
- PIN 3** Low impedance microphone level input for dynamic microphones. Also accepts hand-held electret microphones provided the microphone has its own built-in battery.
- PIN 4** Bias voltage selector for Pin 3. Pin 3 voltage (0, 2 or 4 volts) depends on Pin 4 connection.
 - Pin 4 tied to Pin 1: 0 V
 - Pin 4 Open: 2 V
 - Pin 4 to Pin 2: 4 V
- PIN 5** High impedance, line level input for tape decks, mixer outputs, musical instruments, etc.

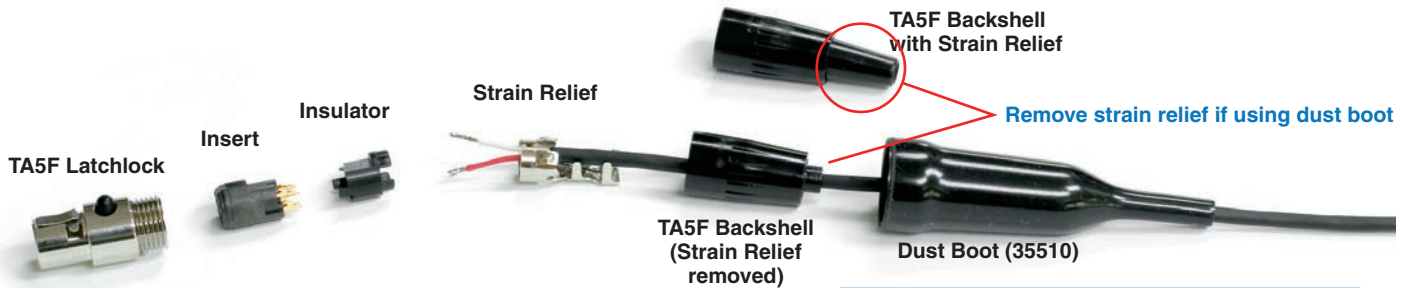

Note: If you use the dust boot, remove the rubber strain relief that is attached to the TA5F cap, or the boot will not fit over the assembly.

Installing the Connector:

- 1) If necessary, remove old connector from microphone cable.
- 2) Slide Rubber Boot onto microphone cable with the large end facing away from the microphone. (See illustration above.)
- 3) If necessary, slide the 1/8-inch black shrink tubing onto the microphone cable. (This tubing is needed for some cables to ensure the cable fits snugly in the rubber boot.)
- 4) Use the resistors and connector included with this kit to configure the TA5F to your particular microphone. (See Wiring Diagrams below.) A length of .065 OD clear tubing is included if insulating the resistor leads or shield wire is necessary. (Remove rubber strain relief from connector backshell by pulling it out of the backshell.)
- 5) Slide the Strain Relief over the TA5F Insert and crimp as shown to the right. Then insert the TA5F Insert and Strain Relief in the TA5F Latchlock. Screw the TA5F Flex Relief onto the TA5F Latchlock.
- 6) If needed, position and shrink the 1/8-inch shrink tubing on the microphone cable, then slide the Rubber Boot down over the TA5F connector.

Microphone Cable Termination for Non-Lectrosonics Microphones

TA5F Connector Assembly

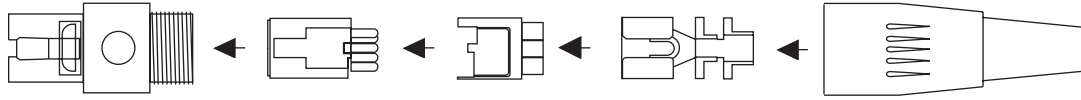

Mic Cord Stripping Instructions

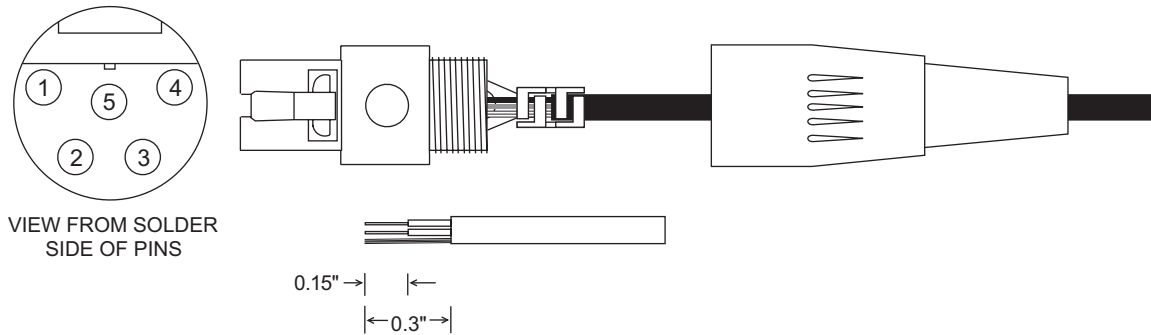

Crimping to Shield and Insulation

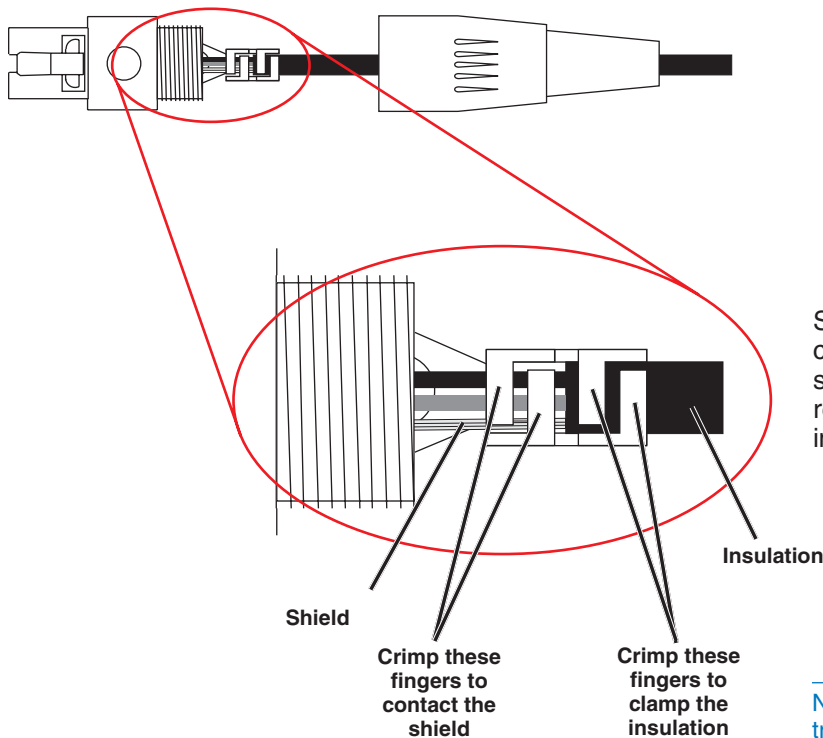

Strip and position the cable so that the clamp can be crimped to contact both the mic cable shield and the insulation. The shield contact reduces noise with some microphones and the insulation clamp increases ruggedness.

NOTE: This termination is intended for UHF transmitters only. VHF transmitters with 5-pin jacks require a different termination. Lectrosonics lavalier microphones are terminated for compatibility with VHF and UHF transmitters, which is different than what is shown here.

Microphone RF Bypassing

When used on a wireless transmitter, the microphone element is in the proximity of the RF coming from the transmitter. The nature of electret microphones makes them sensitive to RF, which can cause problems with the microphone/transmitter compatibility. If the electret microphone is not designed properly for use with wireless transmitters, it may be necessary to install a chip capacitor in the mic capsule or connector to block the RF from entering the electret capsule.

Some mics require RF protection to keep the radio signal from affecting the capsule, even though the transmitter input circuitry is already RF bypassed (see schematic diagram).

If the mic is wired as directed, and you are having difficulty with squealing, high noise, or poor frequency response, RF is likely to be the cause.

The best RF protection is accomplished by installing RF bypass capacitors at the mic capsule. If this is not possible, or if you are still having problems, capacitors can be installed on the mic pins inside the TA5F connector housing.

2 WIRE MIC

3 WIRE MIC

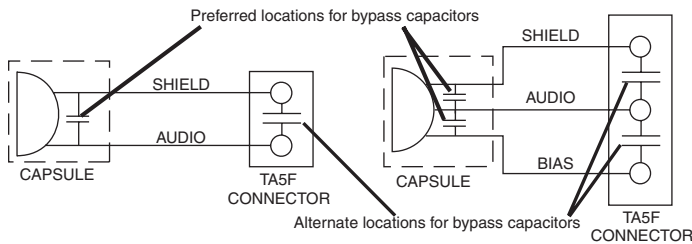

Install the capacitors as follows: Use 330 pF capacitors. Capacitors are available from Lectrosonics. Please specify the part number for the desired lead style.

Leaded capacitors: P/N 15117

Leadless capacitors: P/N SCC330P

All Lectrosonics lavalier mics are already bypassed and do not need any additional capacitors installed for proper operation.

Line Level Signals

The normal hookup for line level signals is: Signal Hot to pin 5, Signal Gnd to pin 1 and pin 4 jumped to pin 1. This allows signal levels up to 3V RMS to be applied without limiting.

If more headroom is needed, insert a 20 k resistor in series with pin 5. Put this resistor inside the TA5F connector to minimize noise pickup.

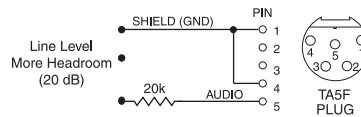
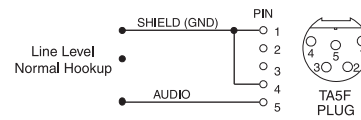

Wiring Hookups for Different Sources

In addition to the microphone and line level wiring hookups illustrated below, Lectrosonics makes a number of cables and adapters for other situations such as connecting musical instruments (guitars, bass guitars, etc.) to the transmitter. Visit www.lectrosonics.com and click on Accessories, or download the master catalog.

A lot of information regarding microphone wiring is also available in the FAQ section of the web site at:

<http://www.lectrosonics.com/faq.htm>

Follow the instructions to search by model number or other search options.

Compatible Wiring for Both Servo Bias Inputs and Earlier Transmitters:

2 VOLT POSITIVE BIAS 2-WIRE ELECTRET

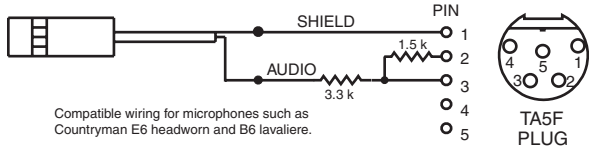

4 VOLT POSITIVE BIAS 2-WIRE ELECTRET

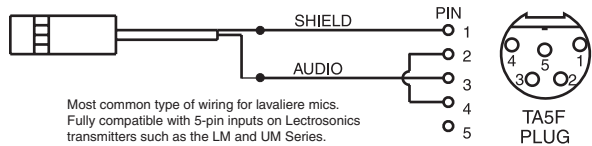

2 VOLT POSITIVE BIAS 2-WIRE ELECTRET - DPA MICROPHONES

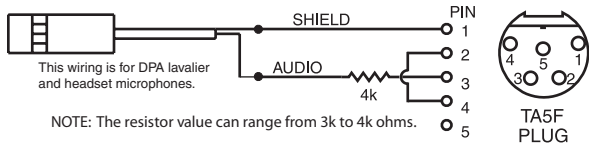

UNBALANCED LINE LEVEL SIGNALS

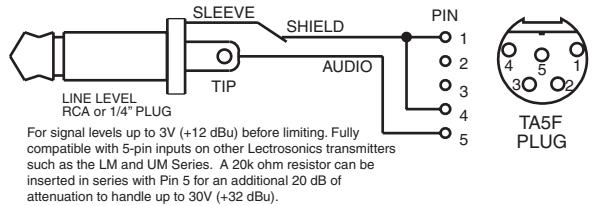

2 VOLT NEGATIVE BIAS 2-WIRE ELECTRET

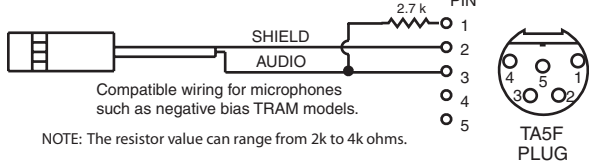

BALANCED AND FLOATING LINE LEVEL SIGNALS

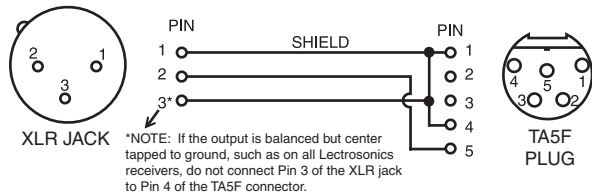

4 VOLT POSITIVE BIAS 3-WIRE ELECTRET WITH EXTERNAL RESISTOR

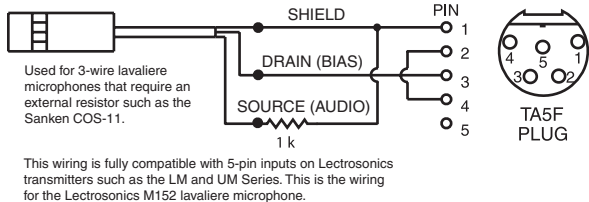

LO-Z MICROPHONE LEVEL SIGNALS

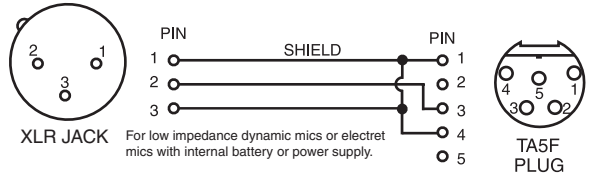

Simple Wiring for Servo Bias Inputs Only:

2 VOLT POSITIVE BIAS 2-WIRE ELECTRET

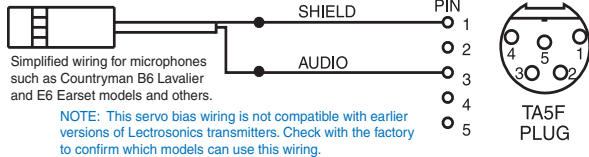

4 VOLT POSITIVE BIAS 3-WIRE ELECTRET

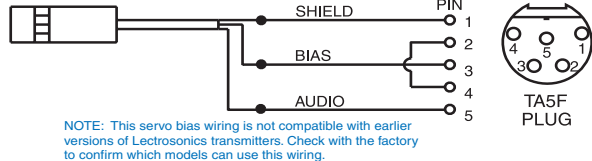

2 VOLT NEGATIVE BIAS 2-WIRE ELECTRET

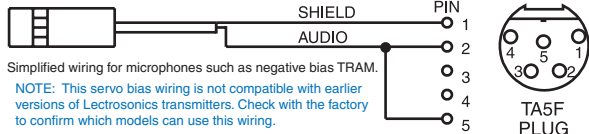

RM Remote Control Operating Instructions

RM Front Panel Controls



A single AA Lithium battery will operate the RM for up to several years.

The RM unit gives you remote control of SM Series transmitters using an audible tone delivered to the transmitter's microphone. Operating parameters on the transmitter can be set by holding the speaker on the RM close to the microphone and pressing the pushbutton. A "dweedle" tone will play from the RM speaker into the microphone and the parameter on the transmitter will be set immediately.

Available adjustments:

- Audio input gain
- Frequency
- Lock or Unlock Modes
- Sleep Mode ON/OFF

When an SM Series Transmitter is in the power saving sleep mode, it uses only 20% of the normal battery drain, so battery life will be 5 times longer. This is especially useful in situations where the transmitter is buried deep inside costuming and there are waiting periods between use. The transmitter can "sleep" for several hours and then be awakened and adjusted when the production is about to begin.

Powering the RM on and off

To turn the RM on or off, press the AUDIO and FREQ buttons together briefly. The unit powers up on the page that was displayed when the unit was powered off last.

Principles of Operation

The RM user interface is organized into pages which are accessible via the AUDIO and FREQ buttons. Once on a page, settings can be adjusted with the UP and DOWN arrow buttons.

To change a transmitter's setting via the RM, it is necessary to dial in the new setting on the appropriate page on the RM, and then press the SEND button (on the side, near the speaker). The speaker should be uncovered and held within a few inches of the transmitter's microphone. (The longest usable range is about 6 feet, depending on the microphone and volume settings used.)

NOTE: Only the specific function displayed is altered. For example, if the remote control is on the CH (channel) screen, pressing the send button will set the transmitter's channel but will not affect any other setting on the transmitter at that time.

RM Pages

The AUDIO button cycles through 4 pages:

- 1) Aud - set transmitter's audio level
- 2) SLEEP/unSLP - cause transmitter to sleep or wake up
- 3) Loc/unLoc - lock or unlock transmitter's buttons
- 4) Loud - adjust RM speaker volume (press SEND button for a sample tone)

The FREQ button cycles through 2 or 3 pages, depending on the settings:

- 1) CH - set transmitter's channel (using block-independent hex code)
- 2) b - select a block number (optional — uncovers next page)
- 3) 000.000 - set transmitter's frequency in MHz (avail. if a block is selected)



When the SEND button is pressed, the selected RM setting is transmitted via the RM speaker to the microphone attached to the SM Transmitter.

Operating Notes

- The sensitivity to the remote control varies with the transmitter’s audio level setting and the microphone used, but it is always possible to make it work with a sufficiently loud remote signal at close range.
- If the SM is configured to respond to the remote control, it will do so even if the buttons are locked.
- When the SM is asleep, it can only be awakened by the remote control, or by removing and reinserting the battery.
- When the SM is asleep, the PWR led blinks green every few seconds.
- If a remote command is sent that would result in the same display being shown again on the SM (for example tuning to the channel already displayed), a row of dashes is displayed briefly, as a signal that the command was received, but it didn’t change anything.
- If you are having trouble getting the SM to respond, make sure you aren’t covering the RM’s speaker with your thumb, and/or turn up the RM’s speaker volume on the “Loud” page.
- If the RM is set to a different block number than the transmitter and an attempt is made to set the transmitter’s frequency in MHz, the command will still work. The transmitter is simply set to the corresponding channel in the correct block, with a matching hex code.
- Since all SM transmitters respond to the same signals, take care that the remote control is presented only to the desired transmitter, with the minimum speaker volume necessary to do the job reliably.



The RM should be held close enough to the microphone to change the settings on the intended transmitter, but not be so loud as to affect other transmitters nearby.

RM Quick Reference

Power On/Off	AUDIO+FREQ
Set SM audio level	Aud page (via AUDIO)
Sleep or Wake SM	SLEEP/unSLP page (via AUDIO)
Lock or Unlock SM	Loc/unLoc page (via AUDIO)
Adjust RM volume	Loud page (via AUDIO)
Set SM channel (hex)	CH page (via FREQ)
Enable MHz display	b (block) page (via FREQ)
Set SM channel (MHz)	000.000 page (via FREQ)

Note: The audio signal from the RM will change the settings of all transmitters within range. Experiment with this to prevent accidental changes on another transmitter during production.

Troubleshooting

Before going through the following chart, be sure that you have a good battery in the transmitter. It is important that you follow these steps in the sequence listed.

SYMPTOM

POSSIBLE CAUSE

TRANSMITTER PWR LED OFF

- 1) Battery is inserted backwards or dead.
- 2) Transmitter not powered up. (See *Operating Instructions, Power UP and Boot Sequence.*)

TRANSMITTER PWR LED BLINKS GREEN EVERY FEW SECONDS, TRANSMITTER DOES NOT RESPOND OTHERWISE

- 1) Transmitter has been put to sleep by the remote control. Either use the remote control to wake it up again or remove and reinsert the transmitter's battery.

AUDIO LEVEL LEDs NOT LIGHTING

- 1) Gain control set to minimum.
- 2) Battery is dead or installed backwards. Check PWR LED.
- 3) Mic capsule is damaged or malfunctioning.
- 4) Mic cable damaged or mis-wired.

RECEIVER RF INDICATOR OFF

- 1) Transmitter not turned on, or is in Standby Mode.
- 2) Transmitter battery is dead.
- 3) Receiver antenna missing or improperly positioned.
- 4) Transmitter and receiver not on same frequency. Check switches/display on transmitter and receiver.
- 5) Transmitter and receiver not on same frequency block.
- 6) Operating range is too great.
- 7) Defective transmitter antenna - unit needs repair.

NO SOUND (OR LOW SOUND LEVEL), RECEIVER INDICATES PROPER AUDIO MODULATION

- 1) Receiver output level set too low.
- 2) Receiver output disconnected, or cable defective or mis-wired.
- 3) Sound system or recorder input is turned down.

DISTORTED SOUND

- 1) Transmitter gain (audio level) is far too high. Check SM LEDs and receiver audio levels as SM is being used.
- 2) Receiver output may be mismatched with the sound system or recorder input. Adjust output level on receiver to the correct level for the recorder, mixer or sound system. (Use the receiver's Tone function to check level.)
- 3) Excessive wind noise or breath "pops." Reposition microphone and/or use a larger windscreen.
- 4) Transmitter is not set to same frequency as receiver. Check that operating frequency on receiver and transmitter match.
- 5) Receiver/Transmitter Compatibility Mode mismatched.

EXCESSIVE FEEDBACK

- 1) Transmitter gain (audio level) too high. Check gain adjustment and/or reduce receiver output level.
- 2) Talent standing too close to speaker system.
- 3) Mic is too far from user's mouth.

SYMPTOM**POSSIBLE CAUSE****HISS AND NOISE -- AUDIBLE DROPOUTS**

- 1) Transmitter gain (audio level) far too low.
- 2) Receiver antenna missing or obstructed.
- 3) Transmitter antenna broken or missing.
- 4) Operating range too great.
- 5) Signal interference. Turn off transmitter. If receiver's signal strength indicator does not drop to nearly zero, this indicates an interfering signal may be the problem. Try a different operating frequency.

“Loc” APPEARS IN DISPLAY WHEN ANY BUTTON IS PRESSED

- 1) Control Panel is locked. (See *Operating Instructions, Locking and Unlocking the Control Panel.*)

“Hold” APPEARS IN DISPLAY WHEN ARROW BUTTONS ARE PRESSED

- 1) Reminder that it is necessary to hold down the AUDIO or FREQ button to make adjustments to the audio gain or frequency settings.

“PLL” APPEARS IN DISPLAY

- 1) Indication that the PLL is not locked. This is a serious condition that requires factory repair. It may be possible to operate on another frequency far removed from the one that was selected when the unlocked condition was indicated.

TRANSMITTER WON'T RESPOND TO REMOTE CONTROL

1. If LCD blinks “rc oFF”, transmitter has not be configured to respond to the remote control. See “Remote Control Operation” on page 16 for instructions on how to configure.
2. If LCD blinks “- - - - -”, transmitter is already set as requested by the remote control.
3. If transmitter doesn't not respond at all, try moving the remote control closer to the microphone or increasing the remote control's loudness setting, or increasing audio level on transmitter.
4. SM, SMD and SMQ transmitters must have firmware ver. 1.5 or higher to work with the RM. All “a” versions of the SM Series will work from firmware ver. 1.0 and up. The firmware version will flash briefly on the right side of the LCD during power up.

RM Troubleshooting**SM FREQUENCY CHANGES, BUT NOT TO DESIRED FREQUENCY**

- 1) RM set on different block than transmitter in question. RM uses hex code to set frequency - set RM to proper frequency block, or use hex code method to change frequency.

RM FAILS TO CHANGE SETTINGS ON TRANSMITTER

- 1) Make sure volume of RM and proximity of microphone are sufficient to engage transmitter.
- 2) Make sure transmitter is not in Sleep mode.

Specifications and Features

Operating frequencies:

- Block 470 470.100 - 495.600
- Block 19 486.400 - 511.900
- Block 20 512.000 - 537.500
- Block 21 537.600 - 563.100
- Block 22 563.200 - 588.700
- Block 23 588.800 - 607.900 and 614.100 - 614.300
- Block 24 614.400 - 639.900
- Block 25 640.000 - 665.500
- Block 26 665.600 - 691.100
- Block 27 691.200 - 716.700
- Block 28 716.800 - 742.300
- Block 29 742.400 - 767.900
- Block 944 944.100 - 951.900

(Frequency usage varies by country)

- Frequency range:** 256 frequencies in 100 kHz steps for one 25.5 MHz wide block
- Channel Spacing:** 100 kHz
- Frequency selection:** Control panel mounted membrane switches
- RF Power output:** SMA: 100 mW (nominal)
SMDa: 100 mW (nominal)
SMQa: 250 mW (nominal)
- Compatibility Modes (6)** Digital Hybrid Wireless™ (400 Series), 200 Series, 100 Series, Mode 3 (other analog), Mode 6, and IFB
- Pilot tone:** 25 to 32 kHz; 5 kHz deviation (in 400 Series Mode)
- Frequency stability:** ± 0.002%
- Deviation:** ± 75 kHz max. (in 400 Series Mode)
- Spurious radiation:** 60 dB below carrier
- Equivalent input noise:** -125 dBV, A-weighted
- Input level:**
 - If set for dynamic mic:** 0.5 mV to 50 mV before limiting. Greater than 1 V with limiting.
 - If set for electret lavalier mic:** 1.7 uA to 170 uA before limiting. Greater than 5000 uA (5 mA) with limiting.
 - Line level input:** 5.0 mV to 6 V before limiting. Greater than 15 V with limiting.
- Input impedance:**
 - Dynamic mic:** 300 Ohms
 - Electret lavalier:** Input is virtual ground with servo adjusted constant current bias
 - Line level:** 2.7 k Ohms
- Input limiter:** Soft limiter, 30 dB range

- Bias voltages:** Fixed 5 V at up to 5 mA
Selectable 2 V or 4 V servo bias for any electret lavalier.
- Gain control range:** 40 dB; panel mounted membrane switches
- Modulation indicators:** Dual bicolor LEDs indicate modulation of -20, -10, 0, +10 dB referenced to full modulation.
- Controls:** Control panel with LCD and four membrane switches.
- Low frequency roll-off:** Adjustable from 35 to 150 Hz.

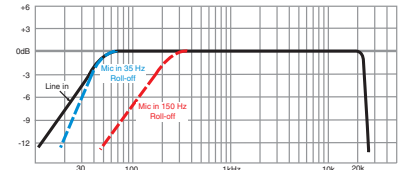

Audio Frequency Response: 35 Hz to 20 kHz, +/-1 dB (The low frequency roll-off is adjustable - see graph above)

Signal to Noise Ratio (dB): (overall system, 400 Series mode)

	SmartNR	No Limiting	w/Limiting
OFF		103.5	108.0
NORMAL		107.0	111.5
FULL		108.5	113.0

(Note: the dual envelope "soft" limiter provides exceptionally good handling of transients using variable attack and release time constants. The gradual onset of limiting in the design begins below full modulation, which reduces the measured figure for SNR without limiting by 4.5 dB)

- Total Harmonic Distortion:** 0.2% typical (400 Series mode)
- Audio Input Jack:** Switchcraft 5-pin locking (TA5F)
- Antenna:** Flexible, unbreakable steel cable.
- Batteries:** 1.5 Volt AA lithium or rechargeable NiMH recommended
- Battery Life:**
 - SM: 1.5 hours (alkaline); 5.5 hours (lithium), 4 hours with 2500mAh NiMH
 - SMD: 5.75 hours (alkaline); 14.25 hours (lithium), 8.5 hours with 2500mAh NiMH
 - SMQ: 1.75 hours (alkaline); 7.5 hours (lithium), 5 hours with 2500mAh NiMH
- Weight:**
 - RM: 2.3 oz.. (65.8 grams) with lithium battery
 - SM: 2.7 oz.. (75.9 grams) with lithium battery
 - SMD/Q: 3.7 oz.. (105 grams) with lithium batteries
- Overall Dimensions:**
 - SM/RM: 2.3 x 1.8 x 0.64 inches (not including microphone/lanyard)
58 x 46 x 16 mm (not including microphone/lanyard)
 - SMD/Q: 2.3 x 2.4 x 0.64 inches (not including microphone)
58 x 60 x 16 mm (not including microphone)

Emission Designator: 180KF3E

Specifications subject to change without notice.

The FCC requires that the following statements be included in this manual for SM Series transmitters:

For body worn operation, this SM Belt-Pack Transmitter has been tested and meets the FCC RF exposure guidelines when used with the Lectrosonics accessories supplied or designated for this product. Use of other accessories may not ensure compliance with FCC RF exposure guidelines. Contact Lectrosonics if you have any questions or need more information about RF exposure using this product..

This device complies with FCC radiation exposure limits as set forth for an uncontrolled environment. This device should be installed and operated so that its antenna(s) are not co-located or operating in conjunction with any other antenna or transmitter.

The FCC requires that the following statement be included in this manual for the RM:

This device complies with Part 15 of the FCC Rules. Operation is subject to the following two conditions: (1) This device may not cause harmful interference, and (2) this device must accept any interference received, including interference that may cause undesired operation.

Service and Repair

If your system malfunctions, you should attempt to correct or isolate the trouble before concluding that the equipment needs repair. Make sure you have followed the setup procedure and operating instructions. Check the interconnecting cables and then go through the **Troubleshooting** section in this manual.

We strongly recommend that you **do not** try to repair the equipment yourself and **do not** have the local repair shop attempt anything other than the simplest repair. If the repair is more complicated than a broken wire or loose connection, send the unit to the factory for repair and service. Don't attempt to adjust any controls inside the units. Once set at the factory, the various controls and trimmers do not drift with age or vibration and never require readjustment. **There are no adjustments inside that will make a malfunctioning unit start working.**

LECTROSONICS' Service Department is equipped and staffed to quickly repair your equipment. In warranty repairs are made at no charge in accordance with the terms of the warranty. Out-of-warranty repairs are charged at a modest flat rate plus parts and shipping. Since it takes almost as much time and effort to determine what is wrong as it does to make the repair, there is a charge for an exact quotation. We will be happy to quote approximate charges by phone for out-of-warranty repairs.

Returning Units for Repair

For timely service, please follow the steps below:

- A.** DO NOT return equipment to the factory for repair without first contacting us by email or by phone. We need to know the nature of the problem, the model number and the serial number of the equipment. We also need a phone number where you can be reached 8 A.M. to 4 P.M. (U.S. Mountain Standard Time).
- B.** After receiving your request, we will issue you a return authorization number (R.A.). This number will help speed your repair through our receiving and repair departments. The return authorization number must be clearly shown on the **outside** of the shipping container.
- C.** Pack the equipment carefully and ship to us, shipping costs prepaid. If necessary, we can provide you with the proper packing materials. UPS is usually the best way to ship the units. Heavy units should be "double-boxed" for safe transport.
- D.** We also strongly recommend that you insure the equipment, since we cannot be responsible for loss of or damage to equipment that you ship. Of course, we insure the equipment when we ship it back to you.

Lectrosonics USA:

Mailing address:

Lectrosonics, Inc.
PO Box 15900
Rio Rancho, NM 87174
USA

Shipping address:

Lectrosonics, Inc.
581 Laser Rd.
Rio Rancho, NM 87124
USA

Telephone:

(505) 892-4501
(800) 821-1121 Toll-free
(505) 892-6243 Fax

Web:

www.lectrosonics.com

E-mail:

sales@lectrosonics.com

Lectrosonics Canada:

Mailing Address:

49 Spadina Avenue,
Suite 303A
Toronto, Ontario M5V 2J1

Telephone:

(416) 596-2202
(877) 753-2876 Toll-free
(877-7LECTRO)
(416) 596-6648 Fax

E-mail:

Sales: colinb@lectrosonics.com
Service: joeb@lectrosonics.com

LIMITED ONE YEAR WARRANTY

The equipment is warranted for one year from date of purchase against defects in materials or workmanship provided it was purchased from an authorized dealer. This warranty does not cover equipment which has been abused or damaged by careless handling or shipping. This warranty does not apply to used or demonstrator equipment.

Should any defect develop, Lectrosonics, Inc. will, at our option, repair or replace any defective parts without charge for either parts or labor. If Lectrosonics, Inc. cannot correct the defect in your equipment, it will be replaced at no charge with a similar new item. Lectrosonics, Inc. will pay for the cost of returning your equipment to you.

This warranty applies only to items returned to Lectrosonics, Inc. or an authorized dealer, shipping costs prepaid, within one year from the date of purchase.

This Limited Warranty is governed by the laws of the State of New Mexico. It states the entire liability of Lectrosonics Inc. and the entire remedy of the purchaser for any breach of warranty as outlined above. NEITHER LECTROSONICS, INC. NOR ANYONE INVOLVED IN THE PRODUCTION OR DELIVERY OF THE EQUIPMENT SHALL BE LIABLE FOR ANY INDIRECT, SPECIAL, PUNITIVE, CONSEQUENTIAL, OR INCIDENTAL DAMAGES ARISING OUT OF THE USE OR INABILITY TO USE THIS EQUIPMENT EVEN IF LECTROSONICS, INC. HAS BEEN ADVISED OF THE POSSIBILITY OF SUCH DAMAGES. IN NO EVENT SHALL THE LIABILITY OF LECTROSONICS, INC. EXCEED THE PURCHASE PRICE OF ANY DEFECTIVE EQUIPMENT.

This warranty gives you specific legal rights. You may have additional legal rights which vary from state to state.

