



# Watertight Transmitter and Remote Controls

With Digital Hybrid Wireless® Technology  
US Patent 7,225,135



Fill in for your records:

Serial Number:

Purchase Date:





## Introduction

The WM transmitter is designed to resist damage when used in wet or dusty conditions and also offer a comprehensive feature set that makes it equally at home in film and television production and on stage.

A solid machined aluminum housing with a corrosion resistant finish hosts dual battery compartments, a moisture sealed control panel with backlit LCD and enlarged membrane switches. Recessed seats for the O-rings in the battery caps and input jack allow the caps and mic connector to be tightened securely without excessive deformation of the O-rings.

The antenna is made of an extremely durable, multi-strand alloy that will withstand heavy abuse. It is mounted with a compression sealed strain relief that prevents dust and moisture from entering the housing.

As the first stage in the signal processing chain, the input preamp section includes very high quality, low noise components with a wide range of gain adjustment in 1 dB increments and a DSP-controlled input limiter. Dual color LEDs on the control panel accurately indicate audio input level for precise gain adjustment. Easily accessed screens on the LCD simplify setup and adjustments.

Output power is adjustable to provide either extended operating range or extended battery life as needed for the application.

The Digital Hybrid Wireless® design (US Patent 7,225,135) combines 24-bit digital audio with analog FM resulting in a system that has the same operating range as analog systems, the same spectral efficiency as analog systems, the same long battery life as analog systems, plus the excellent audio fidelity typical of pure digital systems.

The DSP-based design works with all Digital Hybrid receivers, and is backward compatible for use with Lectrosonics 200 Series, 100 Series, IFB receivers and some other brands of analog wireless receivers.

## Table of Contents

<b>Introduction</b> .....	<b>3</b>
<b>General Technical Description</b> .....	<b>4</b>
Servo Bias Input.....	4
No Pre-Emphasis/De-Emphasis .....	4
Low Frequency Roll-Off .....	4
Input Limiter .....	4
Signal Encoding and Pilot Tone .....	5
Microprocessor Control.....	5
Compatibility Modes.....	5
Control Panel .....	5
Wide-Band Deviation .....	5
Variable Power Output .....	5
Battery Operation.....	5
Frequency Blocks.....	5
Circulator/Isolator.....	5
<b>Controls and Functions</b> .....	<b>6</b>
LCD Screen .....	6
Power LED .....	6
Audio Input Jack.....	6
Battery Compartment and Thumb Screw.....	6
Modulation LEDs.....	6
AUDIO Button .....	6
FREQ Button.....	6
Up/Down Arrows .....	6
Antenna.....	6
<b>About Batteries</b> .....	<b>7</b>
<b>Battery Compartments</b> .....	<b>7</b>
<b>Attaching and Removing the Microphone</b> .....	<b>7</b>
<b>Operating Instructions</b> .....	<b>8</b>
Power Up and Boot Sequence .....	8
Power Down .....	8
Standby Mode.....	8
Compatibility, Output Power, Bias Voltage (phantom power) and LCD Backlight .....	8
Audio LF Roll-off and Gain.....	9
Frequency Selection .....	10
Lock/Unlock Screens .....	10
Remote Control Enable/Disable and Configuring Power Restore .....	10
<b>Preventing Corrosion</b> .....	<b>11</b>
<b>Optional RM Remote Control</b> .....	<b>12</b>
Powering the RM on and off.....	12
Setup Screens .....	12
Operating Notes.....	13
RM Quick Reference.....	13
<b>RM2 Remote Control</b> .....	<b>13</b>
<b>Troubleshooting</b> .....	<b>14</b>
RM Troubleshooting .....	15
<b>Accessories and Replacement Parts</b> .....	<b>16</b>
<b>Antenna Length by Block</b> .....	<b>17</b>
Specifications.....	18
<b>Service and Repair</b> .....	<b>20</b>
Returning Units for Repair .....	20

### Consumer Alert for US Users - FCC Order DA 10-92

Most users do not need a license to operate this wireless microphone system. Nevertheless, operating this microphone system without a license is subject to certain restrictions: the system may not cause harmful interference; it must operate at a low power level (not in excess of 50 milliwatts); and it has no protection from interference received from any other device. Purchasers should also be aware that the FCC is currently evaluating use of wireless microphone systems, and these rules are subject to change. For more information, call the FCC at 1-888- CALL-FCC (TTY: 1-888-TELL-FCC) or visit the FCC's wireless microphone website at [www.fcc.gov/cgb/wirelessmicrophones](http://www.fcc.gov/cgb/wirelessmicrophones). To operate wireless microphone systems at power greater than 50mW, you must qualify as a Part 74 user and be licensed. If you qualify and wish to apply for a license go to: <http://www.fcc.gov/Forms/Form601/601.html>

# General Technical Description

## Servo Bias Input

The voltage and current requirements of the wide variety of electret microphones used in professional applications has caused confusion and compromises in the wiring needed for wireless transmitters. To address this problem, the unique Servo Bias input circuit provides an automatically regulated voltage over a very wide range of current for compatibility with all microphones.

## Digital Hybrid Wireless® Technology

All wireless links suffer from channel noise to some degree, and all wireless microphone systems seek to minimize the impact of that noise on the desired signal. Conventional analog systems use companders for enhanced dynamic range, at the cost of subtle artifacts (typically “pumping” and “breathing”). Wholly digital systems defeat the noise by sending the audio information in digital form, at the cost of some combination of power, bandwidth and resistance to interference.

Digital Hybrid systems overcome channel noise in a dramatically new way, digitally encoding the audio in the transmitter and decoding it in the receiver, yet still sending the encoded information via an analog FM wireless link. This proprietary algorithm is not a digital implementation of an analog compandor but a technique that can be accomplished only in the digital domain, even though the inputs and outputs are analog.

Because it uses an analog FM link, the Digital Hybrid system enjoys all the benefits of conventional FM wireless systems and it does away with the analog compandor and its artifacts.

## No Pre-Emphasis/De-Emphasis

The Digital Hybrid design results in a signal-to-noise ratio high enough to preclude the need for conventional pre-emphasis (HF boost) in the transmitter and de-emphasis (HF roll off) in the receiver. This eliminates the potential for distortion of signals with abundant high-frequency information.

## Low Frequency Roll-Off

The low frequency roll-off can be set for a 3 dB down point at 35, 50, 70, 100, 120 and 150 Hz to control subsonic and very low frequency audio content in the audio. The actual roll-off frequency will vary slightly depending upon the low frequency response of the microphone.

Excessive low frequency content can drive the transmitter into limiting, or in the case of high output sound systems, it can even cause damage to loudspeaker systems. The roll-off is normally adjusted by ear while listening as the system is operating.

## Input Limiter

A DSP-controlled analog audio limiter is employed before the A-D converter. The limiter has a range of more than 30 dB for excellent overload protection. A dual release envelope makes the limiter acoustically transparent while maintaining low distortion. It can be thought of as two limiters in series, a fast attack and release limiter followed by a slow attack and release limiter. The limiter recovers quickly from brief transients, with no audible side effects, and also recovers slowly from sustained high levels to keep audio distortion low while preserving short term dynamics.

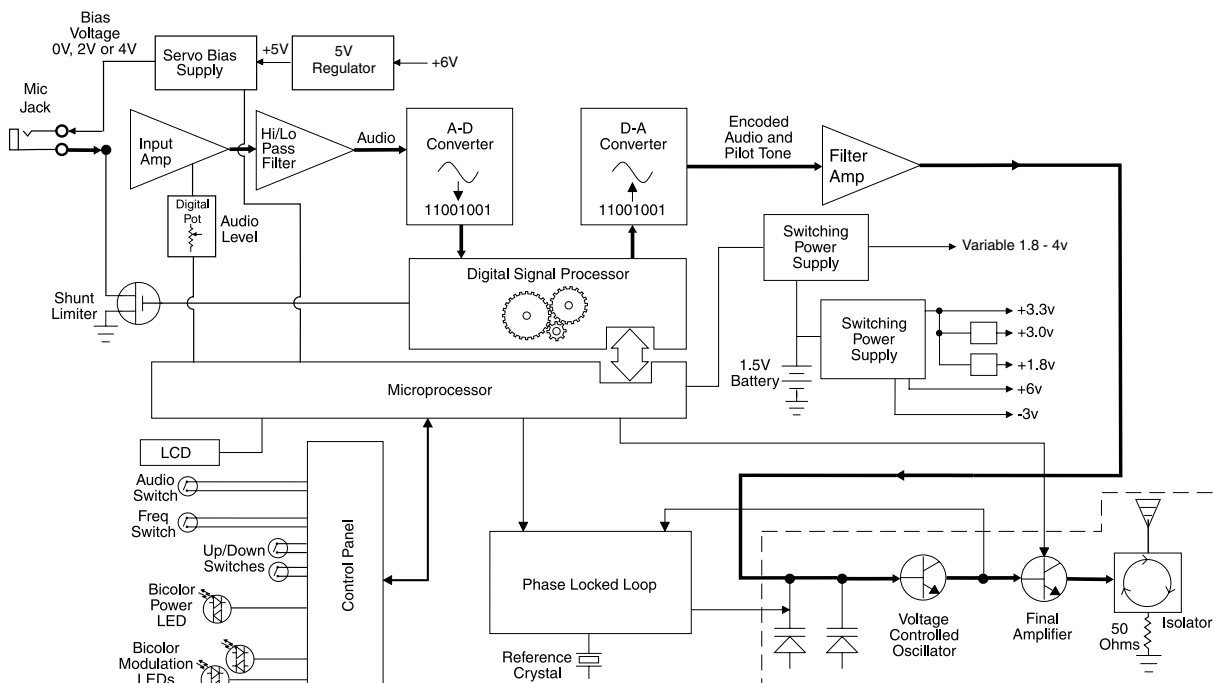

## Signal Encoding and Pilot Tone

In addition to controlling the limiter, the DSP also encodes the digitized audio from the A/D converter and adds an ultrasonic pilot tone to control the squelch in the receiver. A pilot tone squelch system provides a reliable method of keeping a receiver output muted (audio mute) even in the presence of significant interference. When the system is operating in the hybrid mode, a different pilot tone frequency is generated for each carrier frequency to prevent inadvertent squelch problems in multi-channel systems.

## Microprocessor Control

A microprocessor monitors user command inputs from the control panel buttons and numerous other internal signals. It works intimately with the DSP to ensure the audio is encoded according to the selected Compatibility Mode and that the correct pilot tone is added to the encoded signal.

## Compatibility Modes

The transmitter operates with Lectrosonics Digital Hybrid receivers and will yield the best performance when doing so, however, due to the flexibility of digital signal processing, the transmitter can also operate in various compatibility modes for use with Lectrosonics 200 Series, Lectrosonics 100 Series, IFB and certain non-Lectrosonics receivers. Contact the Lectrosonics sales department for more information about non-Lectrosonics receivers.

## Control Panel

The control panel includes four membrane switches and an LCD screen to adjust the operational settings. Multi-color LEDs are used to indicate audio signal levels for accurate gain adjustment and for battery status.

## Wide-Band Deviation

$\pm 75$  kHz deviation improves the signal to noise ratio and audio dynamic range of a wireless system dramatically, compared to other designs that use  $\pm 30$  kHz to 40 kHz deviation. Wide deviation combined with a high powered transmitters makes a significant improvement in signal to noise ratio and operating range.

## Variable Power Output

This advanced feature allows the operator to optimize the transmitter for maximum battery life, or for maximum operating range. Power output is selected using the LCD in a setup mode while the RF output of the transmitter is turned off.

## Battery Operation

Switching power supplies convert battery voltages to operate various circuit stages with maximum efficiency.

The firmware “remembers” the settings when the batteries are exhausted. After new batteries are installed, a quick press of the AUDIO and FREQ buttons will turn the power back on and return to the previous settings. This is a unique behavior that takes place only when the batteries fail during operation. If the unit is turned off manually, a quick press of the buttons will turn it on in the “standby” mode instead.

Because the battery caps make contact with the battery before the cap is seated, the power does not turn back on automatically. This allows both batteries to be installed and the caps tightened before power is restored.

## Frequency Blocks

Lectrosonics established a “block” numbering system years ago to organize the range of frequencies available from the low end at 470.1 MHz band to the upper end at 691.1 MHz. Each block includes 256 frequencies in 100 kHz steps, which is the maximum switching range of the transmitters.

## Circulator/Isolator

The RF output circuit includes a magnetically polarized ferrite called an *isolator* that blocks RF signals entering the transmitter antenna from external sources from traveling back into the final amplifier. This greatly reduces RF intermodulation produced when multiple transmitters are used in close proximity to one another (several feet apart). The isolator also provides additional RF output stage protection against static shock.

# Controls and Functions

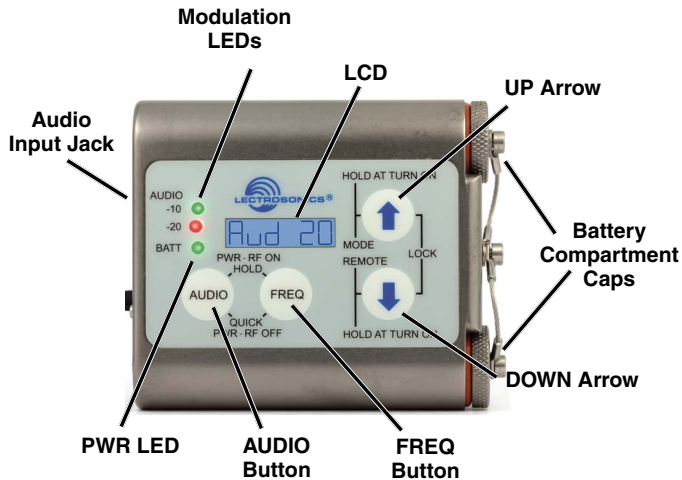

## LCD Screen

The display is a highly visible backlit LCD with screens for making all setup and level adjustments. The transmitter can be powered up with or without the RF output turned on. With the RF output turned off, all adjustments can be made without creating interference for other wireless systems in the vicinity.

For normal powering up and down, a countdown appears in the LCD. The buttons must be held in for the duration of the countdown, which helps to prevent accidentally turning the transmitter on or off.

## Power LED

The PWR LED glows green when the battery is good. The color changes to red when there is about 30 minutes of operation left with the recommended lithium battery. When the LED begins to blink red, there are only a few minutes of life.

A weak battery will sometimes cause the PWR LED to glow green immediately after the unit is turned on, but will soon discharge to the point where the LED will turn red or the unit will turn off completely. When the transmitter is in SLEEP mode, the LED blinks green every few seconds.

## Audio Input Jack

This is a threaded locking connector that accepts the Lectrosonics watertight WP connector.

## Battery Compartment and Thumb Screw

The large knurled thumbscrews are retained to maintain solid battery contact. The lanyard keeps the battery caps attached, but it can be removed if desired using a 1/16 inch hex key (Allen wrench).

## Modulation LEDs

Proper input gain adjustment is critical to ensure the best audio quality. Two red/green LEDs will glow to accurately indicate modulation levels. The input circuitry includes a wide range DSP-controlled limiter to prevent distortion during high peak levels.

It is important to set the gain (audio level) high enough to achieve full modulation during louder peaks in the audio. The DSP-controlled limiter can handle peaks over 30 dB above full modulation, so with an optimum setting, the LEDs will flash red during use. If the LEDs never flash red, the gain is too low. The **-20 LED** turns red at 0 dB (full modulation).

Signal Level	-20 LED	-10 LED
Less than -20 dB	● Off	● Off
-20 dB to -10 dB	● Green	● Off
-10 dB to +0 dB	● Green	● Green
+0 dB to +10 dB	● Red	● Green
Greater than +10 dB	● Red	● Red

## AUDIO Button

The AUDIO button is used to display the gain and low frequency roll-off settings. The UP and DOWN arrows adjust the values. This button is also used with the FREQ button to enter standby mode and to power the transmitter on or off.

## FREQ Button

The FREQ Button displays the selected operating frequency and also toggles the LCD between displaying the actual operating frequency in MHz and a two-digit hexadecimal number that corresponds to the equivalent Lectrosonics Frequency Switch Setting. This button is also used with the AUDIO button to enter standby mode and to power the transmitter on or off.

## Up/Down Arrows

The Up and Down arrow buttons are used to select the values on the various setup screens and to lock out the control panel. Pressing both arrows simultaneously enters the lock countdown. When an attempt is made to change a setting while the control panel is locked, a message will flash on the LCD as a reminder that the unit is locked. Once locked, the buttons can only be unlocked by removing the battery, or with the RM remote control.

## Antenna

The fixed whip antenna is constructed with a flexible, woven, galvanized steel mesh cable.

## About Batteries

The transmitter is powered by two AA batteries. Lithium batteries are recommended for longest life, which typically provides over 7.5 hours of operation at room temperature with the output set to 250 mW. At 50 mW, the runtime is typically over 14 hours with lithium batteries.

The PWR LED glows green when the battery is good. The color changes to red at a mid-point of operating life, and will continue to glow red until the battery gets close to the end of its life. When the LED begins to blink red, there are only a few minutes remaining.

The exact point at which the LED turns red will vary with battery brand and condition, temperature and current drain. The LED is simply a reminder intended to catch your attention, not an exact indicator of remaining time.

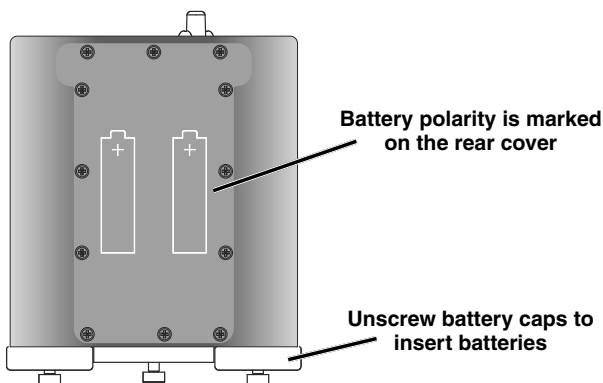
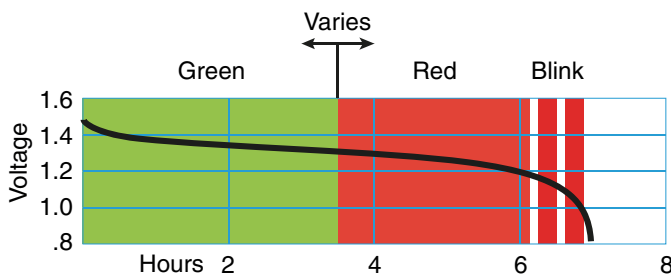

## Battery Compartments

The battery compartments are a rugged, straight-forward design with a recessed entry that captures the O-ring on the cap. The spring contact on the cap maintains solid contact on the battery regardless of its exact length.



The O-rings should be kept clean and dry, and coated with petroleum jelly on a regular basis. See page 11 for more information on preventing corrosion.

## Attaching and Removing the Microphone

The threaded WP watertight plug on the microphone cable fits into a recessed jack on the top panel. The recess in the opening retains the O-ring when the plug is tightened. The Lectrosonics M152WP lavalier microphone is supplied with the WP plug already installed. Other microphones can also be terminated with this plug by following the instructions included with the WP connector kits.



Treat O-ring with petroleum jelly before connecting (see below)

# Operating Instructions

## Power Up and Boot Sequence

Simultaneously press and hold the AUDIO and FREQ buttons until the startup count is completed. The screen will display a count from 1 to 3 as the unit boots up, then it switches to the Audio screen. As the unit turns on, the Modulation LEDs and PWR LED all glow red, then green, and then revert to normal operation.



The LCD displays a boot sequence which consists of four screens ending with the audio screen similar to this example:

- Company name: Lectro
- Frequency block/Firmware Ver.: b21r1.1
- Power level: Pr 100
- Compatibility mode: CP 400
- Audio (Input gain): Aud 22

## Power Down



Simultaneously press and hold the AUDIO and FREQ buttons while observing that the word “OFF” appears in the LCD along with a counter. The screen will display a countdown from 3 to 1 and the unit will then turn off.

**Note:** If the AUDIO and FREQ buttons are released before the LCD goes blank at the end of the countdown, the unit will not turn off. Instead, it will stay energized and the display will return to the previous screen.

## Standby Mode



Quickly press both AUDIO and FREQ buttons to enter the “standby” mode. In this mode the RF output is turned off so adjustments can be made without interfering with other systems operating in the same location. The LCD displays **rf OFF** to remind you that the unit is not transmitting.

Use the AUDIO and FREQ buttons to access the various setup screens. When the adjustments are complete, press both the AUDIO and FREQ buttons briefly to save the settings and turn the unit off.

## Compatibility, Output Power, Bias Voltage (phantom power) and LCD Backlight

Four different setup screens are accessed in a setup mode that is accessed with a special button sequence.

- Compatibility Mode
- Output Power
- Bias Voltage (phantom power)
- LCD Backlight Settings

Hold the UP arrow button and simultaneously press the AUDIO and FREQ buttons. The compatibility setup screen will appear. Each successive press of the AUDIO button will step through the other three setup screens.

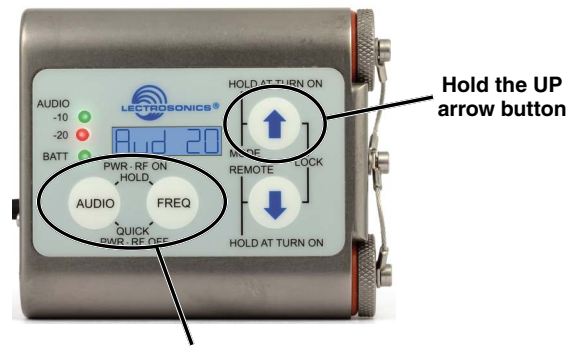

Then press the AUDIO and FREQ buttons at the same time

**Note:** The unit is automatically set to “standby” in this setup mode, however, the **rf OFF** reminder will not be displayed.

## Compatibility Mode

In addition to its native Digital Hybrid mode, the transmitter will operate with Lectrosnocs 100 Series, 200 Series and IFB receivers, as well as several analog receivers from other manufacturers.



From this screen, use the UP and DOWN arrows to select the desired mode.

- **CP 100:** 100 Series mode
- **CP 200:** 200 Series mode
- **CP 3:** Mode 3 (contact the factory for details)
- **CP 400:** 400 Series mode
- **CP IFB:** IFB Series mode
- **CP 6:** Mode 6 (contact the factory for details)



### Output Power



Extended operating range and increased immunity to dropouts can be selected at the expense of shorter battery life by setting the output power to 250 mW. Reduced output power will decrease power consumption and extend battery life at the expense of operating range and immunity to dropouts. Use the UP and DOWN arrows to select the desired output power.

**NOTE:** See the specifications for typical operating times for each power level.

### Bias Voltage (phantom power)

The transmitter features unique Servo Bias input circuitry that automatically adjusts the current to maintain a selected bias voltage for the microphone. This effectively overcomes a traditional problem with variations in output levels and power supply currents of different microphones.

Hold the UP arrow button, then press the **Audio** and **Freq** buttons together to enter the setup screen with the RF output turned off.



Press the UP and DOWN arrows to select the desired setting:

- **PH 2** Bias at 2 volts for electret mics
- **PH 4** Bias at 4 volts for electret mics
- **PH OFF** Bias turned off for dynamic mics
- **L InE** Bias turned off; live level impedance

The correct bias voltage will be specified by the microphone manufacturer. 4 volts is typical for most electret lavalier microphones. 2 volts is preferred by some mic manufacturers such as Countryman for the models B6 and E6.

### LCD Backlight Settings



The backlight on the display can be set to stay on all the time or to turn off after either 30 seconds or 5 minutes of inactivity on the panel switches. The backlight will turn on and the timer will start over when a button is pressed. Use the UP and DOWN arrow buttons to select the desired setting.

### Audio LF Roll-off and Gain

The Audio screen will appear after the boot sequence into the normal mode. When turned on into the “standby” mode, **rf OFF** will appear on the display and pressing the AUDIO button will switch to the Audio screen.

The Audio screen is used to adjust input gain from 0 to +44 dB, and the low frequency roll-off from 35 to 150 Hz. Each time the AUDIO button is pressed, the display will switch back and forth between the two screens. Press and hold the AUDIO button and use the UP and DOWN arrows to make adjustments.

#### Adjusting the Low Frequency Roll-off



It is possible that the low frequency roll-off point could affect the gain setting, so it's generally good practice to make this adjustment before adjusting the input gain. Press and hold the AUDIO button while selecting the desired roll-off frequency with the UP and DOWN arrows. The roll-off frequency can be set to 35, 50, 70, 100, 120 and 150 Hz.

#### Adjusting Audio Level (Gain)



The audio input level (gain) can be adjusted with the unit in the “standby” mode or while powered up in normal operation. The control panel Modulation LEDs indicate the audio level and limiter activity. Once set, the transmitter's audio level setting **should not** be used to control the volume of your sound system or recorder levels. This gain adjustment matches the transmitter gain with the microphone's output level, the user's voice level and the position of the microphone.

It is desirable to set the gain so that some limiting occurs on louder peaks. The limiter is very transparent and its effect is not audible until the system is close to overload. In other words, don't be shy about turning up the gain. In fact, it is a good idea to turn the gain up to maximum and listen for distortion or compression to get a feel for how much headroom the system actually has.

Signal Level	-20 LED	-10 LED
Less than -20 dB	● Off	● Off
-20 dB to -10 dB	● Green	● Off
-10 dB to +0 dB	● Green	● Green
+0 dB to +10 dB	● Red	● Green
Greater than +10 db	● Red	● Red

**Note:** Different voices will usually require different gain settings, so check this adjustment as each new person uses the system. If several different people will be using the transmitter and there is not time to make the adjustment for each individual, adjust it for the loudest voice.

**Warning:** If the wireless system is connected to a live sound system, turn the sound system level down first to avoid severe feedback.

- 1) Position the microphone in the location where it will be used in actual operation.
- 2) Place the transmitter in the “standby” mode or turn it on for normal use.
- 3) While speaking or singing into the microphone at the same voice level that will be used, observe the LEDs on the control panel. Hold the AUDIO button and press the UP or DOWN arrow buttons to adjust the gain until the -20 LED flickers red on louder peaks. This LED turns red at the instant full modulation takes place and the very onset of limiting. The red color does not indicate overload or clipping.



This will maximize the audio signal to noise ratio of the system and provide plenty of headroom (limiter range) to handle even louder peaks that could occur.

If the unit was set up in “standby” mode, it will be necessary to turn the transmitter off, then power it up again in normal operation so the RF output will be on. Then the other components in the sound or recording system can be adjusted.

## Frequency Selection

The frequency can be displayed either in MHz or as a two-digit hexadecimal number and can be set in the Standby Mode or when the transmitter is powered up in the normal operating mode.



The hexadecimal numbering system is unique to Lectrosonics where two alphanumeric characters correspond to the left and right switch settings on earlier analog transmitters that had mechanical rotary switches to adjust frequency.

- 1) Press the FREQ button to select either the MHZ screen or the hexadecimal screen.
- 2) While holding the FREQ button, use the Up or Down arrow buttons to move the operating frequency up or down in 100 kHz increments from the current setting.

## Lock/Unlock Screens

The control panel buttons can be locked out to avoid inadvertent changes in the settings or turning the unit off unintentionally. Simultaneously pressing and holding both the UP and DOWN arrow buttons during normal operation starts a countdown timer.



The timer starts at three and counts down to zero. When the timer reaches zero, the transmitter’s controls are locked.

With the controls locked, the AUDIO and FREQ buttons can still be used to display current settings. Any attempt to change a setting by pressing either the Up or Down arrow button will result in an on-screen **Loc** reminder that the controls are locked.



Once the transmitter is locked, it cannot be unlocked or powered off using the buttons. The only ways to unlock a locked transmitter are to remove the battery or unlock it via the RM remote control.

## Remote Control Enable/Disable and Configuring Power Restore

These two settings are made with a screen that is accessed with a special button sequence.

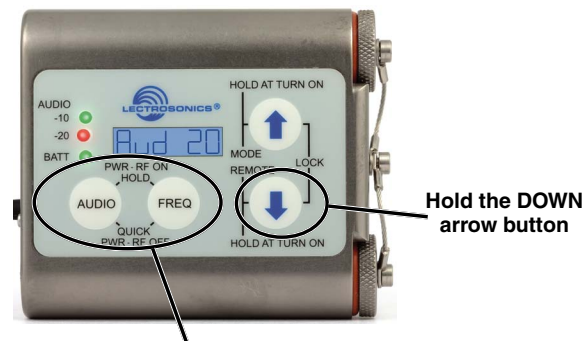

Then press the AUDIO and FREQ buttons at the same time

The remote control screen setup will appear first. When either the AUDIO or FREQ button is pressed, the screen will switch to the power restore setup screen. Pressing either button again will return the unit to the “standby” mode with the RF output turned off.

To access these screens again, turn the unit off and press the three buttons as shown above to start over.

## Enable/Disable Remote Control Functions

To enable the transmitter to respond to signals from the RM remote control unit, use the UP and DOWN arrow buttons to select **rc on** on the setup screen. To disable this function, select **rc off**.



If a remote control signal is detected but the function is turned off, the message **rc off** will be displayed briefly on the transmitter's LCD to confirm that a valid signal was received, but that the transmitter is not configured to respond to it.

Refer to the section of this manual entitled *Optional RM Remote Control* for details on the features and operation of the remote control.

## Configuring for Power Restore

The second setup screen in this mode determines how the transmitter is powered up again after the batteries have become exhausted in normal operation the unit has shut down. **PbAC 0** turns the power restore function off and **PbAC 1** turns it on.



When this function is turned on, the unit will power up to normal operation with a brief press of the AUDIO and FREQ buttons after the batteries have been replaced.

When this function is turned off, the AUDIO and FREQ buttons need to be held in for the completion of the count to turn the unit back on for normal operation.

This is a unique behavior that takes place only when the batteries fail during operation. If the unit is turned off manually, a quick press of the buttons will turn it on in the "standby" mode instead.

The firmware is written this way because the battery caps make contact with the battery before the cap is seated, and the fact that there are two separate battery caps to tighten. This allows both batteries to be installed and the caps tightened before power is restored. It also makes turning the unit back on easier when wearing gloves since the buttons do not need to be held in.

## Preventing Corrosion

Whenever the transmitter has been exposed to moisture or perspiration, follow the instructions below to minimize the risk of corrosion.

**DRY THE UNIT BEFORE REMOVING THE MICROPHONE CONNECTOR OR BATTERY CAPS.**

If the transmitter has been exposed to salt water, rinse it with fresh water and then dry it thoroughly with a clean paper towel or cloth.

Dry the exterior of the transmitter with a clean paper towel or cloth. Remove all moisture around the battery caps and microphone cable connector.

After removing the battery caps and microphone connector, wipe off any residual moisture around the battery compartment and microphone jack openings and on the battery caps and microphone connector.

The O-rings should be coated with Vaseline® or an equivalent petroleum jelly\* before each use to ensure the seals are watertight.

**DO NOT USE ANYTHING OTHER THAN PURE PETROLEUM JELLY TO LUBRICATE THE O-RINGS. Silicon-based lubricants will dissolve the O-rings.**

Store the unit with no batteries installed, battery caps removed and the microphone disconnected. This will allow any buildup of humidity and moisture to evaporate.

\*Vaseline is a registered trademark of Conopco, Inc

# Optional RM Remote Control

The RM unit gives you remote control of SM Series transmitters using an audible tone delivered to the microphone. The panel layout is the same as the transmitters. Simply set the desired value or mode on the LCD, then press the send button to set the transmitter to the same setting or mode.



Hold the speaker on the RM close to the microphone when pressing the pushbutton. A “dweedle” tone will play from the RM speaker into the microphone and the parameter on the transmitter will be set immediately.

Available adjustments:

- Audio input gain
- Frequency
- Lock or Unlock Modes
- Sleep Mode ON/OFF

Speaker



When the transmitter is in the power saving sleep mode, it uses only 20% of the normal battery drain, so battery life will be approximately 4 times longer. This is especially useful in situations where the transmitter is buried deep inside costuming and there are waiting periods between use. The transmitter can “sleep” for several hours and then be awakened and adjusted when the production is about to begin.

Several “Dweedle tones” can also be downloaded from the web site at:

<http://www.lectrosonics.com/Transmitters/rm.html>

The dweedle tones can be played back through an MP3 player, SmartPhone, etc., and in most cases, will even work with walkie talkies. The tones will not work through the loudspeakers of a sound system because the reflections and reverberation in the room will alter the tones.

## Powering the RM on and off

To turn the RM on or off, press the AUDIO and FREQ buttons together briefly. The unit powers up on the page that was displayed when the unit was powered off last.

The setup screens are accessed with the AUDIO and FREQ buttons. Once on the desired screen, the value is adjusted with the UP and DOWN arrow buttons.

To change a transmitter’s setting via the RM, select the screen and value, then press the SEND button while holding the speaker close to the microphone. The speaker should be uncovered and held within a few inches of the transmitter’s microphone. The longest usable range is about 6 feet, depending on the microphone and volume settings used.

Only the specific function displayed is altered. For example, if the remote control is on the Aud (audio level/gain) screen, pressing the send button will set the gain on the transmitter but will not affect any other setting.

## Setup Screens

The AUDIO button cycles through 4 screens:

- 1) Aud - set transmitter’s audio level
- 2) SLEEP/unSLP - cause transmitter to sleep or wake up
- 3) Loc/unLoc - lock or unlock transmitter’s buttons
- 4) Loud - adjust RM speaker volume (press SEND button for a sample tone)
- 5) Pr - Transmit output power (only in SM & SMVs)

The FREQ button cycles through 2 or 3 screens, depending on the settings:

- 1) CH - set transmitter’s channel (using block-independent hex code)
- 2) b - select a block number (optional — uncovers next page)
- 3) 000.000 - set transmitter’s frequency in MHz (avail. if a block is selected)



*A single AA Lithium battery will operate the RM for up to several years. Unscrew the knurled knob for access to the battery compartment.*

## Operating Notes

- The sensitivity to the remote control varies with the transmitter's audio level setting and the microphone used, but it is always possible to make it work with a sufficiently loud remote signal at close range.
- If the transmitter is configured to respond to the remote control, it will do so even if the buttons are locked.
- When the transmitter is asleep, it can only be awakened by the remote control, or by removing and reinserting the battery.
- When the transmitter is asleep, the PWR led blinks green every few seconds.
- If a remote command is sent that would result in the same display being shown again on the transmitter (for example tuning to the channel already displayed), a row of dashes is displayed briefly, as a signal that the command was received, but it didn't change anything.
- If you are having trouble getting the transmitter to respond, make sure you aren't covering the speaker with your thumb, and/or turn up the speaker volume on the *Loud* page.
- If the RM is set to a different block number than the transmitter and an attempt is made to set the transmitter's frequency in MHz, the command will still work. The transmitter is simply set to the corresponding channel in the correct block, with a matching hexadecimal number.
- The audio signal from the RM will change the settings of all transmitters within range. Experiment with this to prevent accidental changes to another transmitter during a production.



The RM should be held close enough to the microphone to change the settings on the intended transmitter, and not be loud enough to affect other transmitters nearby.

## RM2 Remote Control



## RM Quick Reference

Power On/Off	AUDIO+FREQ
Set WM audio level	Aud page (via AUDIO)
Sleep or Wake SMV	SLEEP/unSLP page (via AUDIO)
Lock or Unlock SMV	Loc/unLoc page (via AUDIO)
Adjust RM volume	Loud page (via AUDIO)
Set WM channel (hex)	CH page (via FREQ)
Enable MHz display	b (block) page (via FREQ)
Set WM channel (MHz)	000.000 page (via FREQ)

A lower cost alternative to the RM, this model provides remote control of:

- Sleep/Unsleep
- Lock/Unlock
- Audio Level (gain)

This model operates on a "button cell" battery with a recessed trim pot (screwdriver adjusted) for the speaker level control.

**Important:** The remote control (RC) mode must be enabled on your SM Series transmitter for the RM to function with it. For instructions, refer to page 7 of this publication.

# Troubleshooting

Before going through the following chart, be sure that you have a good battery in the transmitter. It is important that you follow these steps in the sequence listed.

## SYMPTOM

## POSSIBLE CAUSE

### TRANSMITTER PWR LED OFF

- 1) Battery is inserted backwards or dead.
- 2) Transmitter not powered up. (See *Operating Instructions, Power UP and Boot Sequence.*)

### TRANSMITTER PWR LED BLINKS GREEN EVERY FEW SECONDS, TRANSMITTER DOES NOT RESPOND OTHERWISE

- 1) Transmitter has been put to sleep by the remote control. Either use the remote control to wake it up again or remove and reinsert the transmitter's battery.

### AUDIO LEVEL LEDs NOT LIGHTING

- 1) Gain control set to minimum.
- 2) Battery is dead or installed backwards. Check PWR LED.
- 3) Mic capsule is damaged or malfunctioning.
- 4) Mic cable damaged or mis-wired.
- 5) Phantom Power not set!

### RECEIVER RF INDICATOR OFF

- 1) Transmitter not turned on, or is in Standby Mode.
- 2) Transmitter battery is dead.
- 3) Receiver antenna missing or improperly positioned.
- 4) Transmitter and receiver not on same frequency. Check switches/display on transmitter and receiver.
- 5) Transmitter and receiver not on same frequency block.
- 6) Operating range is too great.
- 7) Defective transmitter antenna.

### NO SOUND (OR LOW SOUND LEVEL), RECEIVER INDICATES PROPER AUDIO MODULATION

- 1) Receiver output level set too low.
- 2) Receiver output disconnected, or cable defective or mis-wired.
- 3) Sound system or recorder input is turned down.

### DISTORTED SOUND

- 1) Transmitter gain (audio level) is far too high. Check audio level LEDs and receiver audio levels during use.
- 2) Receiver output may be mismatched with the sound system or recorder input. Adjust output level on receiver to the correct level for the recorder, mixer or sound system. (Use the receiver's Tone function to check level.)
- 3) Transmitter is not set to same frequency as receiver. Check that operating frequency on receiver and transmitter match.
- 4) Receiver/Transmitter Compatibility Mode mismatched.

### EXCESSIVE FEEDBACK

- 1) Transmitter gain (audio level) too high. Check gain adjustment and/or reduce receiver output level.
- 2) Talent standing too close to speaker system.
- 3) Mic is too far from user's mouth.

**SYMPTOM****POSSIBLE CAUSE****HISS AND NOISE -- AUDIBLE DROPOUTS**

- 1) Transmitter gain (audio level) far too low.
- 2) Receiver antenna missing or obstructed.
- 3) Transmitter antenna broken or missing.
- 4) Operating range too great.
- 5) Signal interference. Turn off transmitter. If receiver's signal strength indicator does not drop to nearly zero, this indicates an interfering signal may be the problem. Try a different operating frequency.

**“Loc” APPEARS IN DISPLAY WHEN ANY BUTTON IS PRESSED**

- 1) Control Panel is locked. (See *Operating Instructions, Locking and Unlocking the Control Panel.*)

**“Hold” APPEARS IN DISPLAY WHEN ARROW BUTTONS ARE PRESSED**

- 1) Reminder that it is necessary to hold down the AUDIO or FREQ button to make adjustments to the audio gain or frequency settings.

**“PLL” APPEARS IN DISPLAY**

- 1) Indication that the PLL is not locked. This is a serious condition that requires factory repair. It may be possible to operate on another frequency far removed from the one that was selected when the condition was indicated.

**TRANSMITTER WON'T RESPOND TO REMOTE CONTROL**

- 1) If LCD blinks “rc oFF”, transmitter has not been configured to respond to the remote control. See “Remote Control Operation” on page 8 for instructions on how to configure.
- 2) If LCD blinks “- - - - -”, transmitter is already set as requested by the remote control.
- 3) If transmitter does not respond at all, try moving the remote control closer to the microphone or increasing the remote control's loudness setting, or increasing the audio level on the transmitter.
- 4) Make sure volume of RM and proximity of microphone are sufficient to engage transmitter.
- 5) Make sure transmitter is not in Sleep mode.

**RM Troubleshooting****FREQUENCY CHANGES, BUT NOT TO DESIRED FREQUENCY**

- 1) RM set on different block than transmitter in question. RM uses hex code to set frequency - set RM to proper frequency block, or use hex code method to change frequency.

# Accessories and Replacement Parts

## Belt Clip

TBA

## WPMC-3

Watertight connector kit, 3 piece, to terminate lavalier microphones for use with the WM transmitter.



## WPMC-10

Watertight connector kit, 10 piece, to terminate lavalier microphones for use with the WM transmitter.



## Battery Cap

TBA

## Battery Cap Lanyard

TBA

## O-ring for Battery Cap

TBA



## Antenna Length by Block

Lectrosonics UHF transmitter antennas follow the color code specifications in the chart below to identify operating frequency block range. (The frequency block range is engraved on the outside housing for each individual transmitter.) If a situation exists whereby the antenna is defective and the antenna cap is missing, refer to the following chart to determine the correct replacement antenna.

BLOCK	FREQUENCY RANGE	CAP COLOR	ANTENNA WHIP LENGTH
470	470.100 - 495.600	Black	5.48"
19	486.400 - 511.900	Black	5.20"
20	512.000 - 537.500	Black	4.95"
21	537.600 - 563.100	Brown	4.74"
22	563.200 - 588.700	Red	4.48"
23	588.800 - 614.300	Orange	4.24"
24	614.400 - 639.900	Yellow	4.01"
25	640.000 - 665.500	Green	3.81"
26	665.600 - 691.100	Blue	3.62"

## Specifications

### Operating frequencies:

Block 470	470.100 - 495.600	Block 23	588.800 - 607.900
Block 19	486.400 - 511.900		614.100 - 614.300
Block 20	512.000 - 537.500	Block 24	614.400 - 639.900
Block 21	537.600 - 563.100	Block 25	640.000 - 665.500
Block 22	563.200 - 588.700	Block 26	665.600 - 691.100

<b>Channel Spacing:</b>	100 kHz
<b>Frequency selection:</b>	Control panel mounted membrane switches
<b>RF Power output:</b>	Switchable; 50, 100 or 250 mW
<b>Compatibility Modes (6)</b>	Digital Hybrid Wireless® (400 Series), 200 Series, 100 Series, Mode 3, Mode 6, IFB
<b>Pilot tone:</b>	25 to 32 kHz; 5 kHz deviation (in 400 Series Hybrid Mode)
<b>Frequency stability:</b>	± 0.002%
<b>Deviation:</b>	± 75 kHz max. (in 400 Series Mode)
<b>Spurious radiation:</b>	60 dB below carrier
<b>Equivalent input noise:</b>	-125 dBV, A-weighted
<b>Input level:</b>	
<b>Dynamic mic:</b>	0.5 mV to 50 mV before limiting. Greater than 1 V with limiting.
<b>Electret lavaliere mic:</b>	1.7 uA to 170 uA before limiting. Greater than 5000 uA (5 mA) with limiting.
<b>Line level input:</b>	17 mV to 1.7 V before limiting. Greater than 5 V with limiting.
<b>Input impedance:</b>	
<b>Dynamic mic:</b>	300 Ohms
<b>Electret lavaliere:</b>	Input is virtual ground with servo adjusted constant current bias > 2.7 k Ohms
<b>Line level:</b>	
<b>Input limiter:</b>	Soft limiter, 30 dB range
<b>Bias voltages:</b>	Selectable; 2V, 4V and Off
<b>Gain control range:</b>	44 dB; panel mounted membrane switches
<b>Modulation indicators:</b>	Dual bicolor LEDs indicate modulation of -20, -10, 0, +10 dB referenced to full modulation
<b>Controls:</b>	Control panel with LCD and four membrane switches

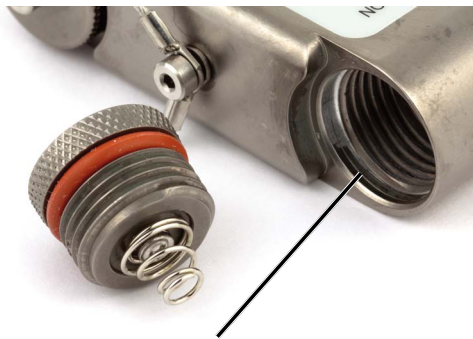

The recess in the battery compartment traps the O-ring for a tight seal.



AA battery compartments are O-ring sealed

### Low frequency roll-off:

Adjustable from 35 to 150 Hz

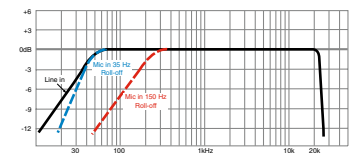

### Audio Frequency Response:

35 Hz to 20 kHz, ±1 dB (The low frequency roll-off is adjustable - see graph above)

### Signal to Noise Ratio (dB): (overall system, 400 Series mode)

	SmartNR	No Limiting	w/Limiting
OFF		103.5	108.0
NORMAL		107.0	111.5
FULL		108.5	113.0

(Note: the dual envelope "soft" limiter provides exceptionally good handling of transients using variable attack and release time constants. The gradual onset of limiting in the design begins below full modulation, which reduces the measured figure for SNR without limiting by 4.5 dB)

### Total Harmonic Distortion:

0.2% typical (400 Series mode)

### Audio Input Jack:

2.5 mm locking micro; threaded for stainless sleeve on WP connector

### Antenna: Flexible, unbreakable steel cable.

### Batteries:

1.5 Volt AA lithium

Battery Life:	Lithium
50 mW (2 AA):	14.5 hrs
100 mW (2 AA):	14 hrs
250 mW (2 AA):	7.5 hrs

### Weight:

5.33 oz.. (151 grams) with lithium batteries

### Housing Dimensions:

2.98 x 2.55 x 0.77 inches  
75.7 x 64.8 x 19.6 mm  
(including battery caps)

### Emission Designator:

180KF3E

Specifications subject to change without notice.

The FCC requires that the following statements be included in this manual for the WM transmitter:

*For body worn operation, this transmitter models has been tested and meets the FCC RF exposure guidelines when used with the Lectrosonics accessories supplied or designated for this product. Use of other accessories may not ensure compliance with FCC RF exposure guidelines. Contact Lectrosonics if you have any questions or need more information about RF exposure using this product..*

*This device complies with FCC radiation exposure limits as set forth for an uncontrolled environment. This device should be installed and operated so that its antenna(s) are not co-located or operating in conjunction with any other antenna or transmitter.*

*This device complies with Industry Canada radiation exposure limits as set forth for a controlled "professional" use only.*

The FCC requires that the following statement be included in this manual for the RM:

*This device complies with Part 15 of the FCC Rules. Operation is subject to the following two conditions: (1) This device may not cause harmful interference, and (2) this device must accept any interference received, including interference that may cause undesired operation.*

## Service and Repair

If your system malfunctions, you should attempt to correct or isolate the trouble before concluding that the equipment needs repair. Make sure you have followed the setup procedure and operating instructions. Check the inter-connecting cables and then go through the **Troubleshooting** section in this manual.

We strongly recommend that you **do not** try to repair the equipment yourself and **do not** have the local repair shop attempt anything other than the simplest repair. If the repair is more complicated than a broken wire or loose connection, send the unit to the factory for repair and service. Don't attempt to adjust any controls inside the units. Once set at the factory, the various controls and trimmers do not drift with age or vibration and never require readjustment. **There are no adjustments inside that will make a malfunctioning unit start working.**

LECTROSONICS' Service Department is equipped and staffed to quickly repair your equipment. In warranty repairs are made at no charge in accordance with the terms of the warranty. Out-of-warranty repairs are charged at a modest flat rate plus parts and shipping. Since it takes almost as much time and effort to determine what is wrong as it does to make the repair, there is a charge for an exact quotation. We will be happy to quote approximate charges by phone for out-of-warranty repairs.

### Returning Units for Repair

For timely service, please follow the steps below:

- A.** DO NOT return equipment to the factory for repair without first contacting us by email or by phone. We need to know the nature of the problem, the model number and the serial number of the equipment. We also need a phone number where you can be reached 8 A.M. to 4 P.M. (U.S. Mountain Standard Time).
- B.** After receiving your request, we will issue you a return authorization number (R.A.). This number will help speed your repair through our receiving and repair departments. The return authorization number must be clearly shown on the **outside** of the shipping container.
- C.** Pack the equipment carefully and ship to us, shipping costs prepaid. If necessary, we can provide you with the proper packing materials. UPS is usually the best way to ship the units. Heavy units should be "double-boxed" for safe transport.
- D.** We also strongly recommend that you insure the equipment, since we cannot be responsible for loss of or damage to equipment that you ship. Of course, we insure the equipment when we ship it back to you.

#### Lectrosonics USA:

**Mailing address:**

Lectrosonics, Inc.  
PO Box 15900  
Rio Rancho, NM 87174  
USA

**Shipping address:**

Lectrosonics, Inc.  
561 Laser Rd. Ste. 102  
Rio Rancho, NM 87124  
USA

**Telephone:**

(505) 892-4501  
(800) 821-1121 Toll-free  
(505) 892-6243 Fax

**Web:**

www.lectrosonics.com

**E-mail:**

sales@lectrosonics.com

#### Lectrosonics Canada:

**Mailing Address:**

49 Spadina Avenue,  
Suite 303A  
Toronto, Ontario M5V 2J1

**Telephone:**

(416) 596-2202  
(877) 753-2876 Toll-free  
(877-7LECTRO)  
(416) 596-6648 Fax

**E-mail:**

Sales: colinb@lectrosonics.com  
Service: joeb@lectrosonics.com







## LIMITED ONE YEAR WARRANTY

The equipment is warranted for one year from date of purchase against defects in materials or workmanship provided it was purchased from an authorized dealer. This warranty does not cover equipment which has been abused or damaged by careless handling or shipping. This warranty does not apply to used or demonstrator equipment.

Should any defect develop, Lectrosonics, Inc. will, at our option, repair or replace any defective parts without charge for either parts or labor. If Lectrosonics, Inc. cannot correct the defect in your equipment, it will be replaced at no charge with a similar new item. Lectrosonics, Inc. will pay for the cost of returning your equipment to you.

This warranty applies only to items returned to Lectrosonics, Inc. or an authorized dealer, shipping costs prepaid, within one year from the date of purchase.

This Limited Warranty is governed by the laws of the State of New Mexico. It states the entire liability of Lectrosonics Inc. and the entire remedy of the purchaser for any breach of warranty as outlined above. **NEITHER LECTROSONICS, INC. NOR ANYONE INVOLVED IN THE PRODUCTION OR DELIVERY OF THE EQUIPMENT SHALL BE LIABLE FOR ANY INDIRECT, SPECIAL, PUNITIVE, CONSEQUENTIAL, OR INCIDENTAL DAMAGES ARISING OUT OF THE USE OR INABILITY TO USE THIS EQUIPMENT EVEN IF LECTROSONICS, INC. HAS BEEN ADVISED OF THE POSSIBILITY OF SUCH DAMAGES. IN NO EVENT SHALL THE LIABILITY OF LECTROSONICS, INC. EXCEED THE PURCHASE PRICE OF ANY DEFECTIVE EQUIPMENT.**

This warranty gives you specific legal rights. You may have additional legal rights which vary from state to state.

