

Leica Jasset

User Reference Manual

Software v2.07

Jigsaw 



Leica Jasset User Reference Manual

This document and any information or descriptive matter contained therein is communicated in confidence and is the copyright property of Leica Geosystems. Neither the whole, nor any extract may be disclosed, loaned, copied, or used in manufacturing or tendering purposes without their written consent.

© Copyright [2014-2016] Leica Geosystems Pty Ltd. All rights reserved. Leica Geosystems Pty Ltd is part of **Hexagon**. Leica Geosystems and the Leica Geosystems logo are the registered trademarks of Leica Geosystems. All trademarks or service marks used herein are property of their respective owners. Leica Geosystems makes no representation or warranty regarding the accuracy of the information in this publication. This document gives only a general description of the product(s) or service(s) offered by Leica Geosystems and, except where expressly provided otherwise, shall not form part of any contract. Such information, the products and conditions of supply is subject to change without notice.

Disclaimer: Illustrations, descriptions, and technical specifications in this document are not binding and are subject to change without notice.

Printing is optimized for A4 paper.

Revision History

Date	Document Version	Software Version	Author	Revision
24 Nov 2014	1	2.05	Dwayne Martine, M.A. Martin	Initial Document Release
16 Jan 2015	1	2.06	Dwayne Martine, M.A. Martin	Jasset Release Update
30 March 2015	1.2	2.06	M.A.Martin	Jasset update. Corporate format change.
21 Aug 2015	1.3	2.06	M.A. Martin	Revised Cellular Antenna distance from humans from 20 cm to 30 cm.
20 Jan 2016	3.0	2.07	P.Brighthouse	Revised procedures for maintaining an asset's attributes and managing a stationary asset, added engine hours support, and made minor corrections. Issued as v3.0 for consistency with internal URM.
25 Jul 2016	4.0	2.07	M.A. Martin	Add US FCC compliance labels and updated safety information in sections: 2.3 Labels: Updated FCC certification label. 2.3.3 Jasset Serial Number Labels: Added United States (US)-specific serial number labels. 4.4 Antenna Installations: Added Installation Warning. 4.4.3 Wi-Fi Antenna Installation: Updated antenna distance from human statement. 4.4.3 Cellular Antenna Installation: Updated antenna distance from human statement. 9.4.3 Persons in Charge of the Product: Added antenna safety information Added Chapter 13: Appendix C Jasset FCC Maximum Personal Exposure (MPE) Calculations Updated inside front cover to corporate requirements.

Table Of Contents

1	Document Introduction	1
1.1	System Installation	1
1.2	Contacting Support	1
1.3	Document Conventions.....	1
2	Jasset Overview	2
2.1	System Information	2
2.1.1	Jasset W (Single Wi-Fi).....	3
2.1.1.1	Jasset W Components	3
2.1.1.2	Jasset W Hardware	3
2.1.1.3	Jasset W Features and Specifications	4
2.1.2	Jasset WW (Dual Wi-Fi).....	5
2.1.2.1	Jasset WW Components.....	5
2.1.2.2	Jasset WW Hardware	5
2.1.2.3	Jasset WW Features and Specifications	6
2.1.3	Jasset G (Cellular Communication – No Wi-Fi)	7
2.1.3.1	Jasset G Components.....	7
2.1.3.2	Jasset G Hardware.....	7
2.1.3.3	Jasset G Features and Specifications	8
2.1.4	Jasset WG (Single Wi-Fi and Cellular Communication)	9
2.1.4.1	Jasset WG Components	9
2.1.4.2	Jasset WG Hardware	9
2.1.4.3	Jasset WG Features and Specifications	10
2.1.5	Jasset WWG (Dual Wi-Fi and Cellular Communication).....	11
2.1.5.1	Jasset WWG Components	11
2.1.5.2	Jasset WWG Hardware.....	11
2.1.5.3	Jasset WWG Features and Specifications.....	12
2.2	Product Faceplate Description	13
2.2.1	Faceplate Decals.....	13
2.2.2	LEDs.....	14
2.2.3	Connector Icons	15
2.3	Labels.....	16
2.3.1	Label Locations	16
2.3.2	Jasset FCC Certification Label.....	16
2.3.3	Jasset Serial Number Labels	17
3	Jasset Commissioning	18
3.1	Commissioning Workflow.....	18
4	Hardware Installation	19
4.1	Before Installation	19
4.2	Jasset Module Installation.....	19
4.2.1	Jasset Mounting Accessories.....	19
4.2.1.1	Mounting Plates.....	19
4.2.1.2	Pole Mount	20
4.2.1.3	Vertical Mount	20
4.2.1.4	Flat Mount	20
4.2.1.5	Mojo Adapter Plate.....	21
4.2.2	Magnetic Mounting.....	21
4.2.2.1	Magnetic Installation	22
4.2.2.2	Magnetic Mount Removal	23
4.3	Power Cable Installation	23
4.4	Antenna Installations	24
4.4.1	Antenna Application	24

4.4.2	GNSS Antenna Installation	24
4.4.3	Wi-Fi Antenna Installation	25
4.4.4	Cellular Antenna Installation	26
4.5	SIM Card Installation – Jasset G, WG, and WWG	26
5	Software Installation.....	28
5.1	Update Leica Jasset Software using USB Flash Drive	28
5.2	Configure Leica Jasset	29
5.3	Installation and Configuration Verification	31
6	Leica Jmineops Jasset Office Administration	32
6.1	Asset Icon	32
6.1.1	Available Asset Icons.....	32
6.1.2	Asset Proximity Ring.....	32
6.1.3	Leica Jasset Representation on the Mine Map	33
6.2	Jmineops Asset View.....	33
6.2.1	Access Asset View from Jmineops.....	34
6.2.2	Change an Asset’s Attributes	35
6.2.2.1	Change Asset Type	35
6.2.3	Change Status and Activity	36
6.3	Leica Jmineops Equipment Operations.....	37
6.4	Leica Jasset on the Mine Map Application	38
6.4.1	Enable Jasset Layer on Mine Map	38
6.4.2	Find a Jasset on the Jmineops Mine Map	39
6.4.3	Filter Assets on Mine Map by Asset Type	40
6.4.4	Access Jmineops Asset View from Mine Map.....	41
6.5	Update an Asset’s Equipment Attributes	42
6.6	Create and Maintain a Stationary Asset	42
6.6.1	Create a Stationary Asset.....	43
6.6.2	Change Position of a Stationary Asset on Mine Map	43
6.7	View Jasset using Shift State View	44
6.7.1	View Jasset by Shift Status	45
6.8	Set Update Timing (Low Power Mode).....	48
6.9	Manage Engine Hours	48
6.10	Monitor Asset Overspeed Alerts	48
6.11	Jasset on Jsplayback.....	49
6.12	Jmineops Asset Status and Activity History Gantt Chart View.....	50
6.12.1	Access Status and Activity Gantt View	50
6.12.1.1	Status and Activity Gantt View	51
6.12.2	Load Data to Gantt View.....	54
6.12.3	View Gantt Details	57
6.12.4	Vertical Time Gridlines.....	57
6.12.5	Gantt Legend	58
6.12.6	View, Edit, or Delete Data Detail on the Gantt View	58
6.12.6.1	View Data Detail	58
6.12.6.2	Data Detail View	59
6.12.6.3	Edit Data Detail.....	62
6.12.6.4	Insert Data	63
6.12.6.5	Delete Data.....	64
6.13	Asset Alarms.....	64
7	Leica Jview Jasset Reports	65
7.1	Jasset Inventory Report.....	65
7.2	Jasset Status Report	67

7.2.1	Duration Bar Graph	68
7.2.2	Pie Chart	68
7.3	Jasset Dashboard	69
8	Care and Transport	70
8.1	Transport	70
8.2	Storage	70
8.3	Cleaning and Drying	70
8.3.1.1	Product and Accessories	70
8.3.1.2	Connectors and Plugs	70
9	Safety Directions	71
9.1	General Introduction	71
9.2	Intended Use	71
9.2.1	Permitted Uses	71
9.2.2	Adverse Use	71
9.3	Limits of Use	71
9.3.1	Environment	71
9.4	Responsibilities	72
9.4.1	Manufacturer of the Product	72
9.4.2	Manufacturers of Non-Leica Geosystems Mining Accessories	72
9.4.3	Persons in Charge of the Product	72
9.5	Hazards of Use	72
9.5.1	General Hazards	72
9.5.2	Mechanical Hazards	72
9.5.3	Lightning Hazards	73
9.5.3.1	Lightning Conductors	73
9.5.4	Disposal	74
9.6	Electromagnetic Compatibility (EMC)	74
10	Technical Data	75
10.1	Jasset W (Single Wi-Fi) Technical Data	75
10.1.1	Design	75
10.1.1.1	User Interface	75
10.1.1.2	Dimensions	75
10.1.1.3	Weight	75
10.1.1.4	Power	75
10.1.2	Environmental Specifications	75
10.1.2.1	Temperature	75
10.1.2.2	Protection Against Water, Dust, and Sand	75
10.1.2.3	Humidity	75
10.1.3	Interfaces	75
10.1.4	Wireless Module Technical Data	76
10.1.4.1	Wi-Fi Module Technical Data	76
10.1.5	Antenna Technical Data	76
10.1.5.1	Wi-Fi Antenna	76
10.1.5.2	GNSS Antenna	76
10.1.6	FCC Statement (Applicable for U.S.)	76
10.2	Jasset WW (Dual Wi-Fi) Technical Data	76
10.2.1	Design	76
10.2.1.1	User Interface	76
10.2.1.2	Dimensions	76
10.2.1.3	Weight	77
10.2.1.4	Power	77
10.2.2	Environmental Specifications	77

10.2.2.1	Temperature	77
10.2.2.2	Protection Against Water, Dust, and Sand	77
10.2.2.3	Humidity	77
10.2.3	Interfaces	77
10.2.4	Wireless Module Technical Data	78
10.2.4.1	Wi-Fi Module Technical Data	78
10.2.5	Antenna Technical Data	78
10.2.5.1	Wi-Fi Antenna	78
10.2.5.2	GNSS Antenna	78
10.2.6	FCC Statement (Applicable for U.S.).....	78
10.3	Jasset G (Cellular) Technical Data.....	78
10.3.1	Design.....	78
10.3.1.1	User Interface	78
10.3.1.2	Dimensions	78
10.3.1.3	Weight.....	79
10.3.1.4	Power.....	79
10.3.2	Environmental Specifications	79
10.3.2.1	Temperature	79
10.3.2.2	Protection Against Water, Dust, and Sand	79
10.3.2.3	Humidity	79
10.3.3	Interfaces	79
10.3.4	Wireless Module Technical Data	79
10.3.4.1	LTE/HSPA+/GPRS Wireless Module Technical Data	79
10.3.5	Antenna Technical Data	80
10.3.5.1	Cellular Antenna Technical Data	80
10.3.5.2	GNSS Antenna	80
10.3.6	Conformity to National Regulations for Jasset G Variant	80
10.3.7	FCC Statement (Applicable for U.S.).....	80
10.4	Jasset WG (Single Wi-Fi and Cellular) Technical Data.....	80
10.4.1	Design.....	80
10.4.1.1	User Interface	80
10.4.1.2	Dimensions	81
10.4.1.3	Weight.....	81
10.4.1.4	Power.....	81
10.4.2	Environmental Specifications	81
10.4.2.1	Temperature	81
10.4.2.2	Protection Against Water, Dust, and Sand	81
10.4.2.3	Humidity	81
10.4.3	Interfaces	81
10.4.4	Wireless Module Technical Data	81
10.4.4.1	Wi-Fi Module Technical Data	81
10.4.4.2	LTE/HSPA+/GPRS Wireless Module Technical Data	82
10.4.5	Antenna Technical Data	82
10.4.5.1	Wi-Fi Antenna	82
10.4.5.2	Cellular Antenna Technical Data	82
10.4.5.3	GNSS Antenna	82
10.4.6	Conformity to National Regulations for Jasset G Variant	82
10.4.7	FCC Statement (Applicable for U.S.).....	82
10.5	Jasset WWG (Dual Wi-Fi and Cellular) Technical Data.....	83
10.5.1	Design.....	83
10.5.1.1	User Interface	83
10.5.1.2	Dimensions	83
10.5.1.3	Weight.....	83
10.5.1.4	Power.....	83
10.5.2	Environmental Specifications	83
10.5.2.1	Temperature	83

10.5.2.2	Protection Against Water, Dust, and Sand	83
10.5.2.3	Humidity	83
10.5.3	Interfaces.....	84
10.5.4	Wireless Module Technical Data.....	84
10.5.4.1	Wi-Fi Module Technical Data	84
10.5.4.2	LTE/HSPA+/GPRS Wireless Module Technical Data.....	84
10.5.5	Antenna Technical Data.....	84
10.5.5.1	Wi-Fi Antenna.....	84
10.5.5.2	Cellular Antenna Technical Data.....	84
10.5.5.3	GNSS Antenna.....	84
10.5.6	Conformity to National Regulations for Jasset G Variant	84
10.5.7	FCC Statement (Applicable for U.S.)	85
11	Appendix A – Universal Antenna Bracket	86
12	Appendix B – Back Up Power Supply	87
12.1	Solar Panel Calculations - Using BP Solar Application	88
12.1.1	Battery Size	88
13	Appendix C - Jasset FCC Maximum Personal Exposure (MPE) Calculations	90
13.1	Jasset Intentional Radiators.....	90
13.1.1	Wi-Fi.....	90
13.1.2	4G.....	90
13.2	MPE Calculations	90
13.2.1	WiFi MPE Calculations.....	90
13.2.2	4G MPE Calculations	90
14	Glossary	92

1 Document Introduction

The Leica Jasset User Reference Manual is part of Leica's Fleet Management System (FMS) Documentation Suite. This manual is intended to serve as a guide to the hardware and components of the Jasset module. This manual provides all instructions required in order to operate the Jasset product to a basic level. This manual provides an overview of the system together with technical data and safety directions.

WARNING:

Operators must be aware of the physical surroundings of their equipment and drive to conditions and mine requirements at all times.

It is assumed a user using this manual is familiar with:

- Site-specific safety procedures, Safe Work Procedures (SWPs) and Standard Operating Procedures (SOPs).
- Mine operations.

Note:

The document uses generic images to show general layout and generic information for various procedures. The site-specific screen layout, menu, and procedure information may vary from what is displayed in the manual.

1.1 System Installation

WARNING:

This is a Class A product. In a domestic environment this product may cause radio interference in which case the user may be required to take adequate measures.

Leica Jasset must be professionally installed by Hexagon Mining trained installers. For installation information see [Hardware Installation](#).

1.2 Contacting Support

For all Leica Jigsaw product support:

Contact Method	Details
Web portal	http://www.hexagonmining.com/customer-portal.htm and select OPERATIONS SUPPORT .

1.3 Document Conventions

This document uses basic conventions to indicate actions:

Convention Example	Description
Select FILE > PRINT	Menu selections, buttons, and icons appear in bold text. In this case, select the FILE menu and the PRINT option. Location and capitalization of menu items may vary by mine site.
Ctrl+P	Keyboard shortcut keys. The example indicates to select and hold down the Ctrl key and select the P key.
See xxx Refer to	“See” indicates a reference to another section of this document. “Refer to” indicates reference to another document.
WARNING	Warnings alert the user to dangerous procedures which could cause injury or death.
CAUTION	Cautions alert the user to dangerous procedures which could cause damage to equipment.
Note	Notes supply important information about a procedure which is not covered in the procedure text.

2 Jasset Overview

Leica Jasset is a rugged solution used to track mobile or semi-mobile assets. The Leica Jasset family includes:

- Leica Jasset W – Jasset with single Wi-Fi for monitoring semi mobile assets.
- Leica Jasset WW – Jasset with dual Wi-Fi for monitoring mobile assets.
- Leica Jasset G – Jasset with cellular modem for monitoring semi mobile assets.
- Leica Jasset WG – Jasset with single Wi-Fi and Cellular modem for monitoring semi mobile assets.
- Leica Jasset WWG – Jasset with dual Wi-Fi and Cellular modem for monitoring mobile assets.

2.1 System Information

Caution

This product is intended for Professional Use only.

Note:

The images used in this manual are for reference purposes only; individual screens and icons may differ from the actual items.

Leica Jasset is a telematics product suited to the tracking of mining assets, including:

- Mobile lighting trailers
- Communication trailers
- Mobile water pumping stations
- Moderate size vehicles
- Water Pumps

Jasset G, WG, and WWG can also be used as a cellular link for the UHP product (in this configuration Jasset G, WG, or WWG communicates to the UHP via Ethernet).

Caution:

The SIM card used in Jasset G, WG, and WWG must be a data SIM, and data must be activated on the carrier's network. Voice-only networks will not carry the Jasset data.

Note

Data charges may apply. Due to the activity on the networks, unlimited data contracts are suggested to avoid extra data charges.

Leica Jasset software provides:

- Intuitive set up and operation.
- Command line configuration
- Upgrade through USB

See [Software Installation](#) for more information.

2.1.1 Jasset W (Single Wi-Fi)

2.1.1.1 Jasset W Components

Jasset W Front View



2.1.1.2 Jasset W Hardware

- One L1 GNSS antenna
- One Wi-Fi antenna
- One Power breakout cable
- One power extension cable
- Optional: CAN, GPIO, Ethernet breakout cable
- Optional: CAN, GPIO extension cable
- Optional: CAN, GPIO Ethernet extension cable

Leica Jasset W without Input/Output

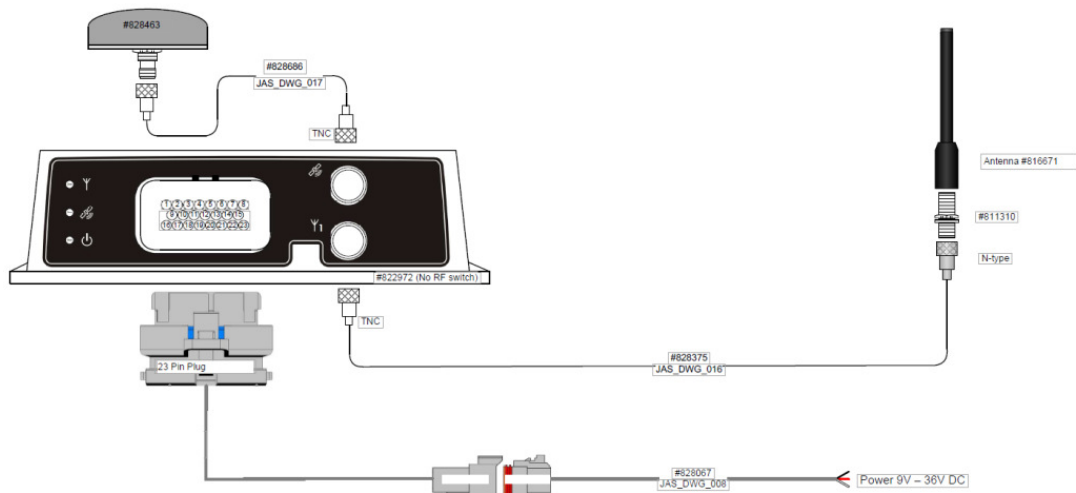

Leica Jasset W with Optional Input/Output

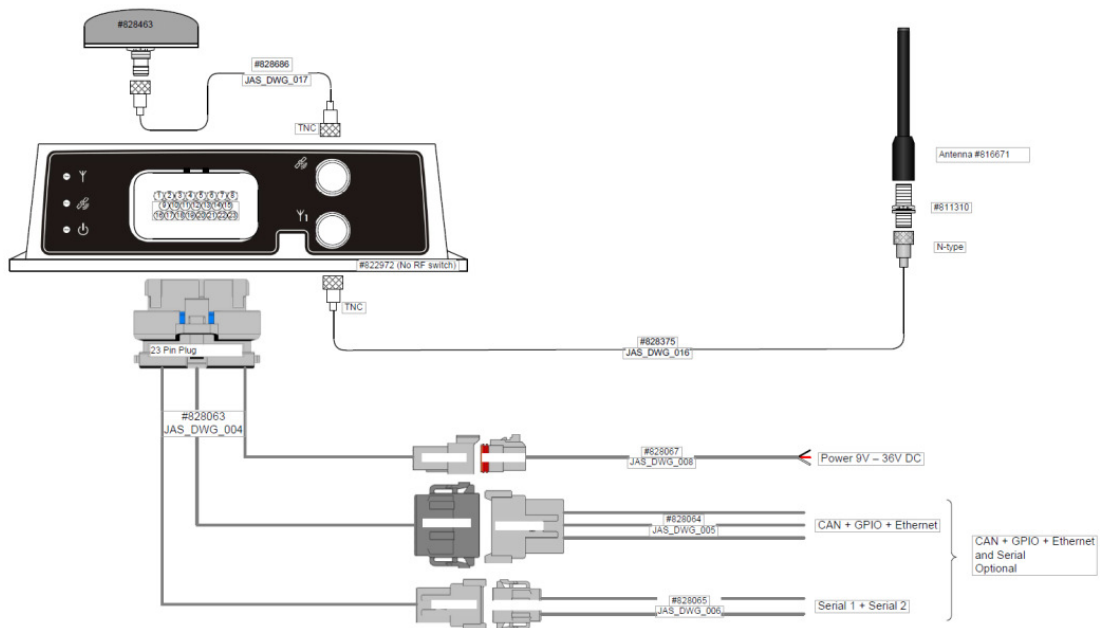

2.1.1.3 Jasset W Features and Specifications

- One external Wi-Fi antenna port
- One internal Wi-Fi module (2.4 GHz b/g/n 200 mW)
- One internal GNSS module (L1 GPS/GLONASS)
- One internal 3-axis accelerometer
- Two digital inputs
- One digital output
- Two Serial Ports
- Two CAN ports
- Industrial metal housing
- USB upgrade (back bay)
- One Ethernet Port
- Ignition controlled available for power saving in vehicles

2.1.2 Jasset WW (Dual Wi-Fi)

2.1.2.1 Jasset WW Components

Jasset WW Front View



2.1.2.2 Jasset WW Hardware

- One L1 GNSS antenna
- Two Wi-Fi antennas
- One power breakout cable
- One power extension cable
- Optional: CAN, GPIO, Ethernet breakout cable
- Optional: CAN, GPIO extension cable
- Optional: CAN, GPIO, Ethernet extension cable
- Optional: Mojo screen

Leica Jasset WW Hardware Setup

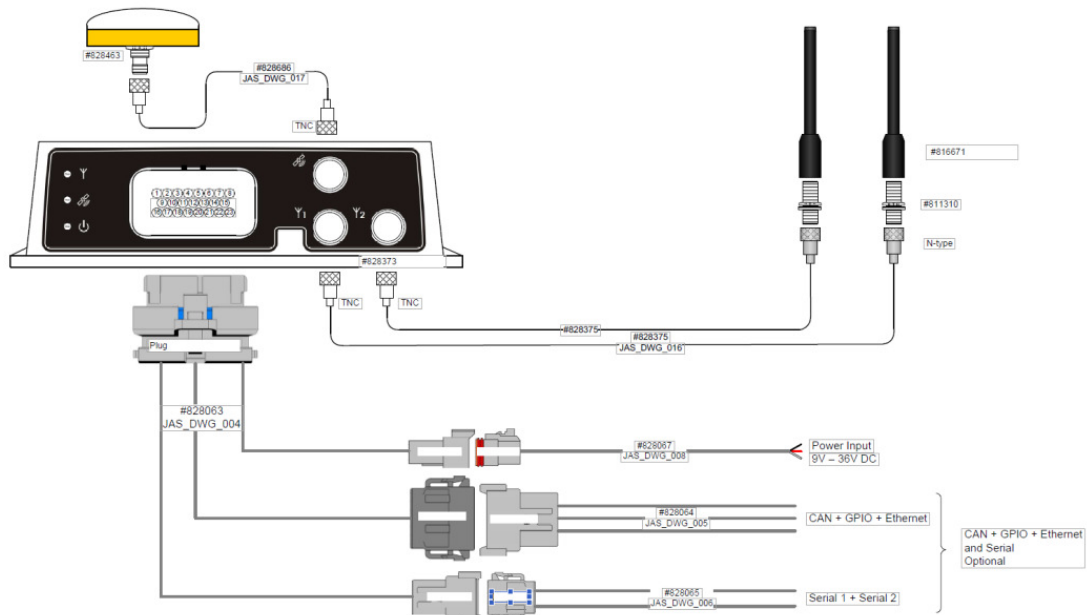

2.1.2.3 Jasset WW Features and Specifications

- Two external Wi-Fi antenna ports
- One internal Wi-Fi module (2.4 GHz b/g/n 200 mW)
- One internal GNSS module (L1 GPS/GLONASS)
- One internal 3-axis accelerometer
- Two digital inputs
- One digital output
- Two Serial ports
- Two CAN ports
- Industrial Metal Housing
- USB upgrade (back bay)
- One Ethernet Port
- Ignition control available for power saving in vehicles

2.1.3 Jasset G (Cellular Communication – No Wi-Fi)

2.1.3.1 Jasset G Components

Jasset G Front View



2.1.3.2 Jasset G Hardware

- One cellular antenna
- One L1 GNSS antenna
- One power breakout cable
- One power extension cable
- Optional: CAN, GPIO, Ethernet breakout cable
- Optional: CAN, GPIO extension cable
- Optional: CAN, GPIO, Ethernet extension cable

Leica Jasset G without Input/Output

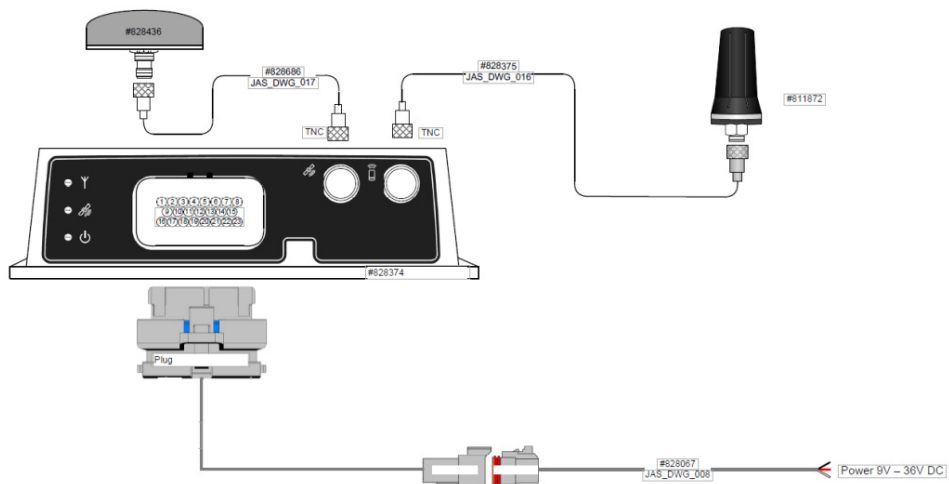

Leica Jasset G with Optional Input/Output

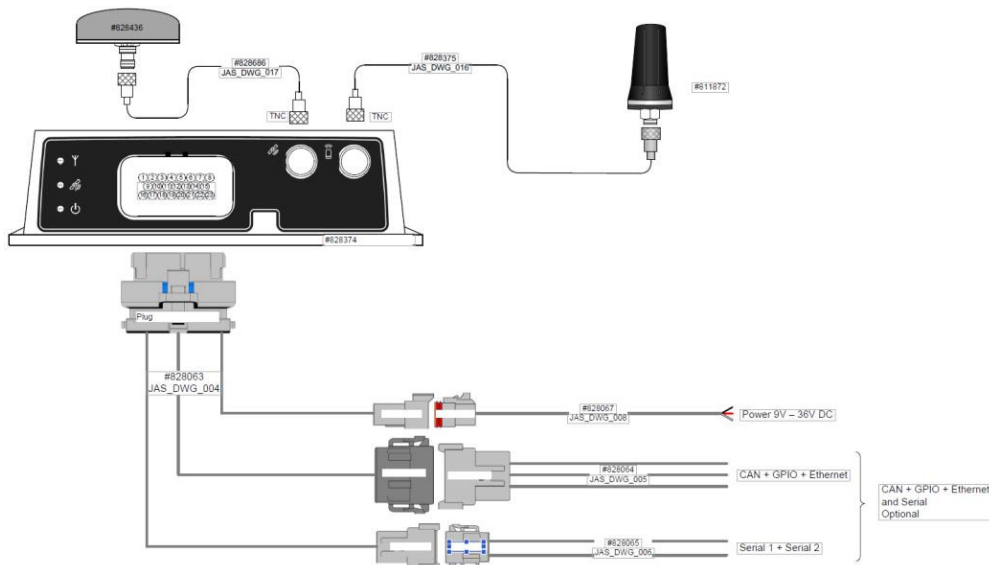

2.1.3.3 Jasset G Features and Specifications

- One internal GNSS module (L1 GPS/GLONASS)
- One internal 3-axis accelerometer
- Two digital inputs
- One digital output
- Two Serial ports
- Two CAN ports
- Internal 4G/3G/2G modem
- Industrial metal housing
- USB upgrade (back bay)
- SIM card access (back bay) (SIM card must be a data SIM. Data must be enabled on the network.)
- One Ethernet Port
- Ignition controlled available for power saving in vehicles

2.1.4 Jasset WG (Single Wi-Fi and Cellular Communication)

2.1.4.1 Jasset WG Components

Jasset WG Front View



2.1.4.2 Jasset WG Hardware

- One L1 GNSS antenna
- One Wi-Fi antenna
- One Cellular antenna
- One power breakout cable.
- One power extension cable
- Optional: CAN, GPIO, Ethernet breakout cable
- Optional: CAN, GPIO extension cable.
- Optional: CAN, GPIO, Ethernet extension cable

Leica Jasset WG without Input/Output

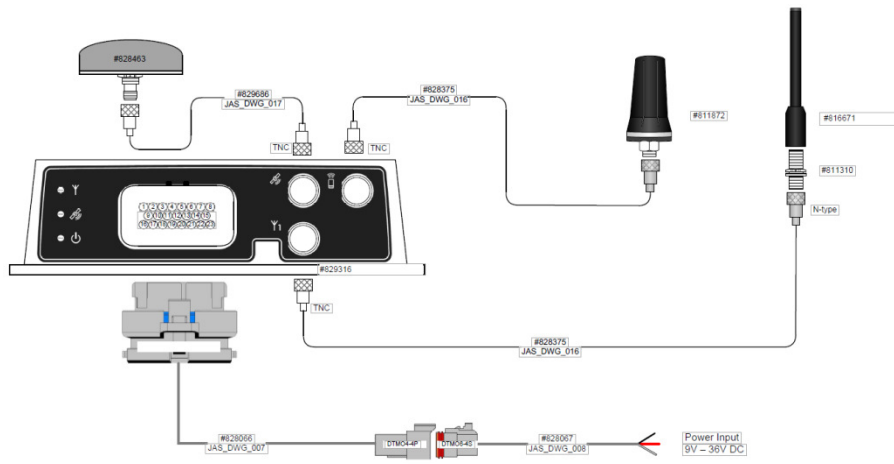

Leica Jasset WG with Optional Input/Output

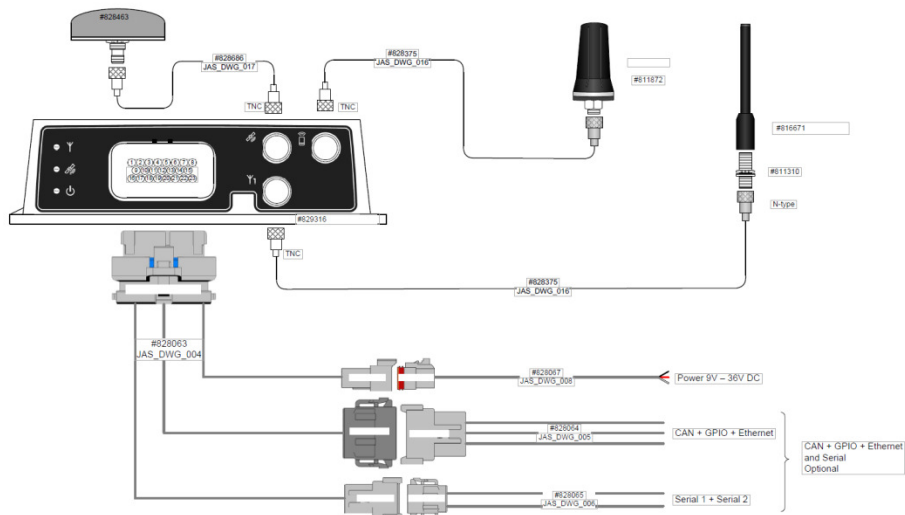

2.1.4.3 Jasset WG Features and Specifications

- One external Wi-Fi antenna port
- One internal Wi-Fi module (2.4 GHz b/g/n 200 mW)
- Internal 4G/3G/2G modem
- One internal GNSS module (L1 GPS/GLONASS)
- One internal 3-axis accelerometer
- Two digital inputs
- One digital output
- Two Serial Ports
- Two CAN ports
- Industrial metal housing
- USB upgrade (back bay)
- Ethernet connection to UHP or other products (front AMP connector)
- Ignition controlled available for power saving in vehicles
- SIM card access (back bay) (SIM card must be a data SIM. Data must be enabled on the network.)

2.1.5 Jasset WWG (Dual Wi-Fi and Cellular Communication)

2.1.5.1 Jasset WWG Components

Jasset WWG Front View



2.1.5.2 Jasset WWG Hardware

- One L1 GNSS antenna
- One Cellular antenna
- Two Wi-Fi antennas
- One power breakout cable.
- One power extension cable
- Optional: CAN, GPIO, Ethernet breakout cable
- Optional: CAN, GPIO extension cable.
- Optional: CAN, GPIO, Ethernet extension cable
- Optional Mojo screen

Leica Jasset WVG with Optional Input/Output

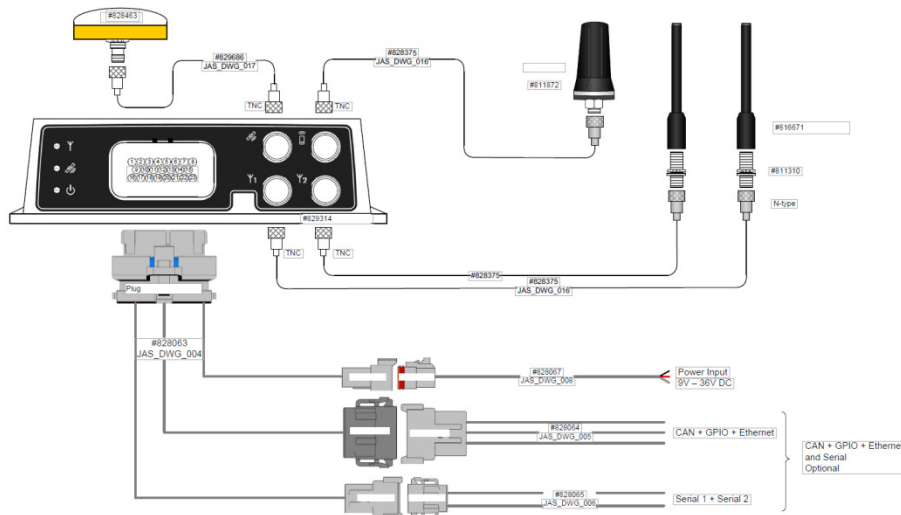

2.1.5.3 Jasset WVG Features and Specifications

- Two external Wi-Fi antenna ports
- One internal Wi-Fi module (2.4G Hz b/g/n 200 mW)
- Internal 4G/3G/2G modem
- One internal GNSS module (L1 GPS/GLONASS)
- One internal 3-axis accelerometer
- Two digital inputs
- One digital output
- Two Serial ports
- Two CAN ports
- Industrial metal housing
- USB upgrade (back bay)
- Ethernet connection to UHP or other products (front AMP connector)
- Ignition controlled available for power saving in vehicles
- SIM card access (back bay) (SIM card must be a data SIM. Data must be enabled on the network.)

2.2 Product Faceplate Description

2.2.1 Faceplate Decals

Each variation of the Jasset product has a different faceplate due to functionality available.

Two RF Connector Decal – Jasset W



Two RF Connector Decal – Jasset G



Three RF Connector Decal – Jasset WW



Three RF Connector Decal – Jasset WG



Four RF Connector Decal – Jasset WWG



2.2.2 LEDs

All Leica Jasset modules have three LEDs. In normal operation, all three LEDs are on.

Example Jasset LEDs



Example Jasset LEDs





LED	Icon	Function
Green LED	Y	Green LED lights when Leica Jasset W, WW, WG, and WWG are communicating over a network. <ul style="list-style-type: none"> ▪ Solid (Wi-Fi connection to or Cellular connection to server) ▪ Flashing (Wi-Fi or Cellular initializing communication) <p>Note: For Jasset WW and WWG, with two Wi-Fi antennas installed, the LED displays the status of the current signal.</p>
Green LED	(Ⓜ)	Green LED lights when Leica Jasset G, WG, and WWG are communicating over a network. <ul style="list-style-type: none"> ▪ Solid (Cellular connection to server) ▪ Flashing (Cellular initializing communication)
Orange LED	GPS	Orange LED lights when the Leica Jasset has GPS communication. <ul style="list-style-type: none"> ▪ Solid (Differential GPS) ▪ Flashing (autonomous GPS)
Red LED	⏻	Red LED lights when the Leica Jasset has power. Power is on all the time unit is operating.

2.2.3 Connector Icons

Each Leica Jasset module has connector function marked on the faceplate.

Example Faceplate with Connector Icons



Symbol	Connector Function
	Cellular Modem
	GPS Antenna
Y ₁	Wi-Fi 1 Antenna
Y ₂	Wi-Fi 2 Antenna

2.3 Labels

2.3.1 Label Locations

Compliance labels are located on all Jasset modules in the following locations:

FCC Certification Label and Serial Number Label Locations



























2.3.2 Jasset FCC Certification Label

FCC ID: 2AFYJ-JASSET

This device complies with part 15 of the FCC Rules. Operation is subject to the following two conditions: (1) This Device may not cause harmful interference, and (2) this device must accept any interference received, including interference that may cause undesired operation.

2.3.3 Jasset Serial Number Labels

Jasset Serial Number Labels	
<p>Jasset W (Single Wi-Fi) Serial Number Label: All Markets</p>  <p>Product: Jasset W Power: 12-24V DC, 1A (max)</p> <p>Leica Geosystems AG CH-9435 Heerbrugg</p> <p>Made in Australia</p> <p>Article No:  822972</p> <p>Serial No:  000001 Manuf date: 2016</p>	<p>Jasset WW (Dual Wi-Fi) Serial Number Label: All Markets</p>  <p>Product: Jasset WW Power: 12-24V DC, 1A (max)</p> <p>Leica Geosystems AG CH-9435 Heerbrugg</p> <p>Made in Australia</p> <p>Article No:  828373</p> <p>Serial No:  000001 Manuf date: 2016</p>
<p>Jasset G (Cellular) Serial Number Label: All Markets Outside US</p>  <p>Product: Jasset G Power: 12-24V DC, 1A (max)</p> <p>Leica Geosystems AG CH-9435 Heerbrugg</p> <p>Made in Australia</p> <p>Article No:  828374</p> <p>Serial No:  000001 Manuf date: 2016</p>	<p>Jasset G (Cellular) Serial Number Label: US</p>  <p>Product: Jasset G Power: 12-24V DC, 1A (max)</p> <p>Leica Geosystems AG CH-9435 Heerbrugg</p> <p>Made in Australia</p> <p>Article No:  834650</p> <p>Serial No:  000001 Manuf date: 2016</p>
<p>Jasset WG (Single Wi-Fi and Cellular) Serial Number Label: All markets outside US</p>  <p>Product: Jasset WG Power: 12-24V DC, 1A (max)</p> <p>Leica Geosystems AG CH-9435 Heerbrugg</p> <p>Made in Australia</p> <p>Article No:  829316</p> <p>Serial No:  000001 Manuf date: 2016</p>	<p>Jasset WG (Single Wi-Fi and Cellular) Serial Number Label: US</p>  <p>Product: Jasset WG Power: 12-24V DC, 1A (max)</p> <p>Leica Geosystems AG CH-9435 Heerbrugg</p> <p>Made in Australia</p> <p>Article No:  834651</p> <p>Serial No:  000001 Manuf date: 2016</p>
<p>Jasset WWG (Dual Wi-Fi and Cellular) Serial Number Label: All Markets outside US</p>  <p>Product: Jasset WWG Power: 12-24V DC, 1A (max)</p> <p>Leica Geosystems AG CH-9435 Heerbrugg</p> <p>Made in Australia</p> <p>Article No:  829314</p> <p>Serial No:  000001 Manuf date: 2016</p>	<p>Jasset WWG (Dual Wi-Fi and Cellular) Serial Number Label: US</p>  <p>Product: Jasset WWG Power: 12-24V DC, 1A (max)</p> <p>Leica Geosystems AG CH-9435 Heerbrugg</p> <p>Made in Australia</p> <p>Article No:  834652</p> <p>Serial No:  000001 Manuf date: 2016</p>

3 Jasset Commissioning

3.1 Commissioning Workflow

1. See [Chapter 4 Hardware Installation](#).
2. See [Section 5.1 Update Leica Jasset Software Using USB Flash Drive](#).
3. See [Section 5.2 Configure Leica Jasset](#).
4. See [Section 5.3 Installations and Configuration Verification](#).
5. See [Section 6.3 Leica Jmineops Equipment Operations](#).
6. See [Section 6.4 Leica Jasset On the Mine Map Application](#).

4 Hardware Installation

4.1 Before Installation

Installation requires specialized knowledge and must be installed by a Leica Geosystems Mining Authorized Installer. Leica Geosystems Mining recommends that installation of the Jasset equipment be performed by a qualified technician because installation requires making electrical connections.

- Install the system in a clean and dry workshop environment. Failure to do so may cause the system to short or promote product malfunction.
- Route and secure all cables and wiring to ensure that they do not chafe or rub causing premature failure.
- The average installation time varies, but should take approximately one hour per asset. The time of installation may be more, or less, based on asset type and options purchased.

4.2 Jasset Module Installation

- Select an appropriate place to mount the Jasset module.
- Four mount holes are provided in the metal housing. These must be used to firmly mount the module to the asset using the supplied mounts.

4.2.1 Jasset Mounting Accessories

WARNING:

Do not mount the module where it may obscure the driver's view of the road.

WARNING:

Do not mount the module where it may be struck by a deploying airbag.

4.2.1.1 Mounting Plates

Mounting Plate Specifications

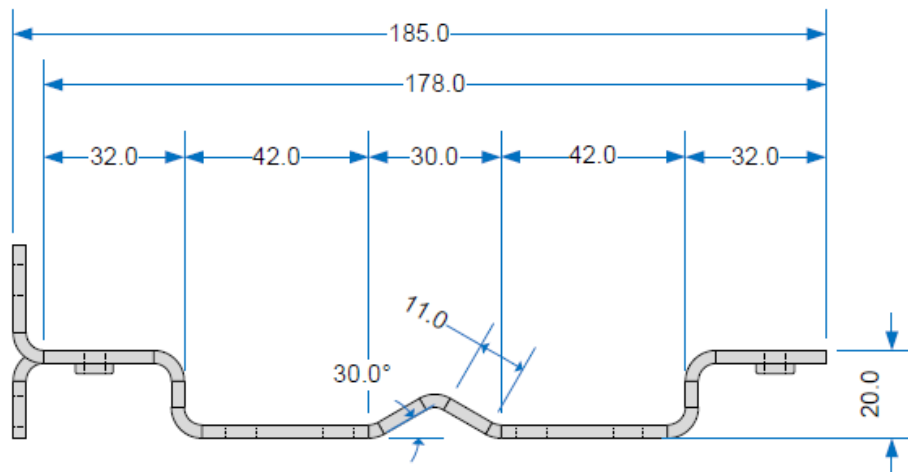

4.2.1.2 Pole Mount

Note:

RF Connectors face downward to help prevent water pooling around the connectors and possible corrosion.

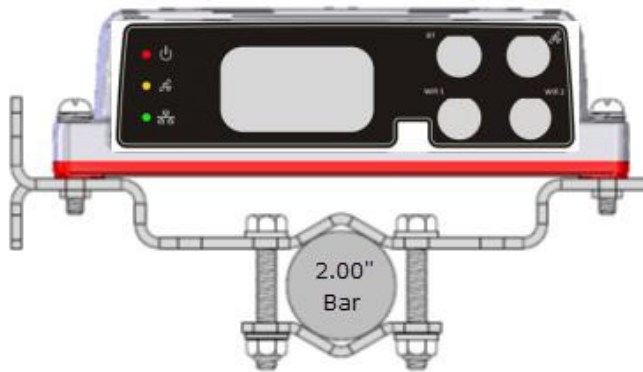

4.2.1.3 Vertical Mount

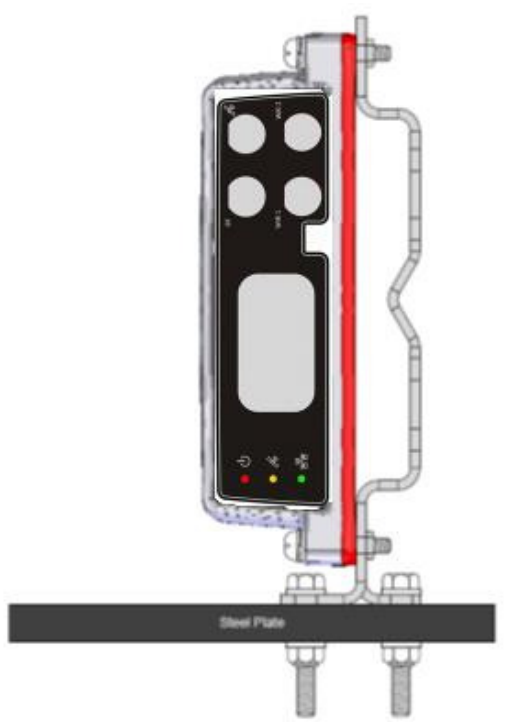

4.2.1.4 Flat Mount

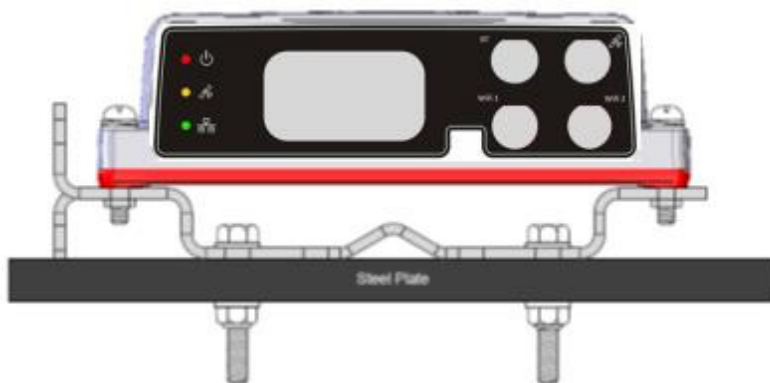

4.2.1.5 Mojo Adapter Plate

An adapter plate is available to install the Jasset module in former Mojo Coms box installations.

4.2.2 Magnetic Mounting

Warning:

Each magnet supplied by Leica has a rated holding force of 40kg. The magnets have the capability of snapping to any steel structure, trapping any objects, including fingers, between the steel structure and the magnet face.

- Magnetic mounts are rare-earth magnets attached with a short post to a mounting bracket.
- Only the bracket is used when mounting using magnets (similar to the flat or vertical mounting).
- The magnets have an attractive force from the face opposite the mounting stud.
- The magnets have strength proportional to the relative thickness of the metal to which they are attached, meaning the thicker the metal the stronger the magnet's holding force.

Magnetic Mount

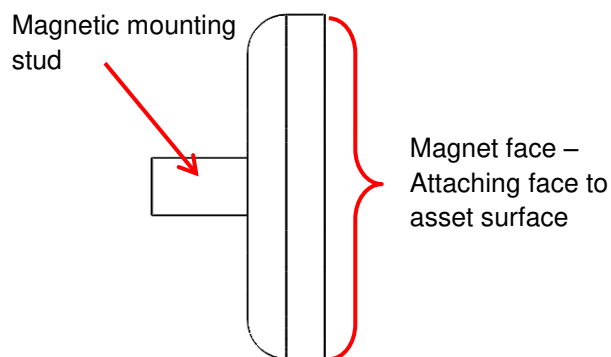

4.2.2.1 Magnetic Installation

Caution:

Magnets may cause possible damage to painted surfaces.

1. Place the bracket and magnets on a workbench or other non-metallic surface.
2. Attach the four (4) magnets using four (4) M6 flat washers and four (4) M6 nyloc nuts to the bracket assembly as indicated in the illustration.

Bracket Assembly

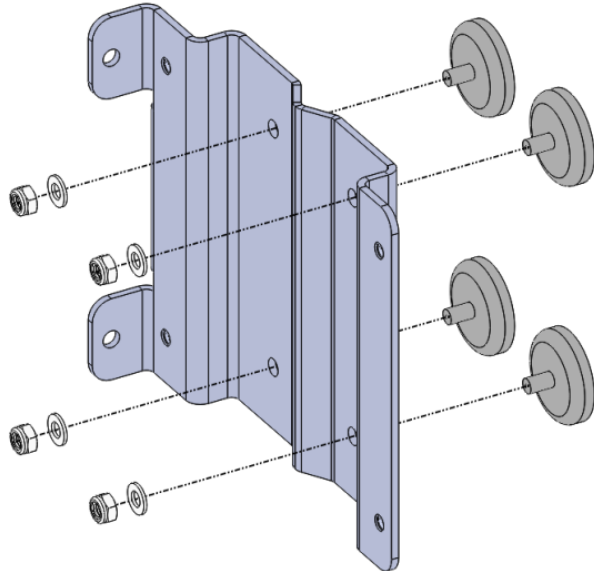

3. Mount the mounting bracket assembly in the agreed upon location.

Warning:

Four magnets have the holding force of 160kg. The bracket has the capability of snapping to any steel structure, trapping any objects, including fingers, between the steel structure and the magnet faces.

4. Attach the bracket assembly to the steel structure, gripping the bracket where hands and fingers are away from potential pinch points. See the illustration for example finger positioning.

Module Assembly



5. Mount the module to the mounting bracket with the connectors facing down.
6. Ensure adequate space is allowed for connecting external cables to the module.

4.2.2.2 Magnetic Mount Removal

Warning:

Four magnets have the holding force of 160kg. The bracket has the capability of snapping to any steel structure, trapping any objects, including fingers, between the steel structure and the magnet faces.

Removal of assembly is done by carefully prying the bracket, with the Jasset module still attached, from the steel structure using a large flat bladed screwdriver.

1. Wedge the screwdriver under one magnet post and lift the entire bracket module assembly and remove.

Remove Magnetic Mount

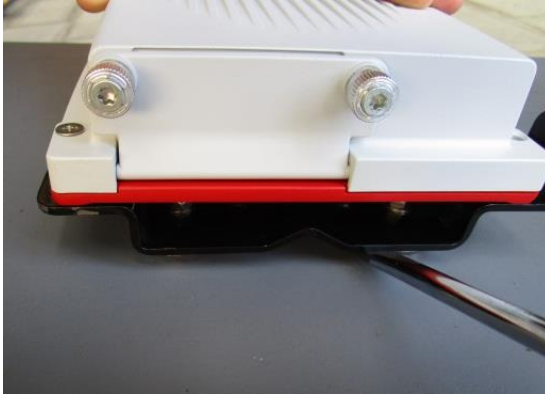

2. Remove the magnetic mount.

4.3 Power Cable Installation

CAUTION:

The Jasset module is a 12 or 24-volt DC (negative-to-earth) system only. Connecting to a positive-to-earth system will cause damage which is not covered by warranty.

1. Connect the supplied power cable to a reliable power source, for example, the vehicle's main power system.
 - a. Connect the unit to a 12 or 24-volt positive source capable of delivering a constant 3 A.
 - b. Connect the black wire to the vehicle's earth ground.
2. Route and secure all cables and wiring to ensure that there is no rubbing, which can cause premature failure.
3. Connect the power cable to the power connector on the front of the module.

4.4 Antenna Installations

4.4.1 Antenna Application

To ensure correct antenna application for mobile or fixed assets, refer to the Antenna Application table.

Warning

- Only antenna listed in the Antenna Application table are permitted to be used.
- The Jasset Wi-Fi and Cellular antennas must be mounted more than 30cm away from the operator.
- Only antenna cables provided with the Jasset equipment for installation as identified in Jasset installation diagrams in section 2.1 for the appropriate Jasset variant are to be used in Jasset antenna installations.

Antenna Application

Asset Type	Required Antenna : Leica Part Number
Semi Mobile Asset: <ul style="list-style-type: none"> ▪ Portable Toilet ▪ Communications Wi-Fi Trailer ▪ Generator ▪ Water Pumps ▪ Mobile Lighting Trailers 	<ul style="list-style-type: none"> ▪ GNSS: 828463 ▪ Wi-Fi: 816671 ▪ 3G Cellular: 811872
Mobile Asset: <ul style="list-style-type: none"> ▪ Light mining vehicles 	<ul style="list-style-type: none"> ▪ GNSS: 828463 ▪ Wi-Fi: 816671 ▪ 3G Cellular: 811872

4.4.2 GNSS Antenna Installation

Note:

Read all instructions prior to assembly and installation.

The Jasset module's GNSS Antenna must be mounted with a clear view of the sky and free from any obstruction from machine components, and must meet the following criteria:

1. The Jasset module GNSS Antenna must be on the flat level part of the machine or mast.
2. The Jasset module GNSS Antenna must not be obstructed by exhausts, flashing lights, masts, trays, or any other objects. It must be mounted such that it has an unobstructed view of the sky and is as high on the equipment as possible.
3. The Jasset module GNSS Antenna must not be mounted within 20 cm of any other antenna.
4. Route the cables through bulkheads using the existing grommets if possible; if not, modification may be required to route the cables to the required location. If creating a new entry point, use a grommet to protect the cables.
5. The cables must not be cut, kinked, or bent tightly, as their performance degrades and a system failure may result.
6. Route the cables back to the Jasset module.
7. If cables are not terminated, terminate the cable and check connectivity before connecting to the antenna
8. A universal antenna mounting bracket is supplied to secure the GPS antenna.
9. Mount the GNSS Antennas through the 18 mm holes in the universal antenna bracket and secure the antennas using a lock nut.

10. Mount the universal bracket onto the equipment location using the bolts provided.
11. Connect the TNC cable connector to the antenna and route the cable to the Jasset module and connect TNC to the Jasset GPS port.

4.4.3 Wi-Fi Antenna Installation

For the Jasset module communication is transmitted using Wi-Fi. The Wi-Fi antennas and cabling are installed using the following hardware:

Warning:

Antennas must be mounted more than 30 cm away from the human body.

Caution:

Antennas must be mounted more than 20 cm away from any other antenna.

Note:

Wi-Fi connectivity is dependent on network infrastructure which is outside the scope of this manual.

1. One or two 2.4 GHz antennas are used depending on version requirements.
2. Route the cables through existing grommets if possible; if not, modification may be required to route the cables to the required location. If creating a new entry point, use a grommet to protect the cables.
3. The cables must not be cut, kinked, or bent tightly, as their performance degrades and a system failure may result.
4. Route the cables back to the Jasset module.
5. If cables are not terminated, terminate the cable and check connectivity before connecting to the antenna
6. Wi-Fi antenna must be installed at a fixed offset of multiple 2.4 GHz wavelengths for reasons of diversity.
7. A universal antenna mounting bracket is supplied to secure the Wi-Fi antenna.
8. Mount the N-type adapter through the 16 mm hole in the universal bracket and secure the antenna using a lock nut.
9. Mount the Wi-Fi antenna to the N-type adapter.
10. Mount the universal antenna bracket onto the equipment in a location more than 30 cm away from the human body and more than 20 cm from other aerials and equipment structure.
11. Secure universal mounting bracket to the equipment using the provided bolts.
12. Connect the N-male connector to N-type adapter and route the cable to the Jasset module and connect the TNC connector to the Wi-Fi port.

4.4.4 Cellular Antenna Installation

Warning:

Antennas must be mounted more than 30 cm away from the human body.

Caution:

Antennas must be mounted more than 20 cm away from any other antenna.

Caution:

The SIM card used in Jasset G must be a data SIM, and data must be activated on the network. Voice-only networks will not carry the Jasset data.

Note:

Cellular data connectivity is dependent on network infrastructure which is outside the scope of this manual.

For the Jasset module (G, WG, WWG) communication is transmitted using cellular data networks. The cellular antenna and cabling is installed using the following hardware:

1. One Cellular antenna is used.
2. Route the cable through the existing grommets if possible; if not, modification may be required to route the cables to the required location. If creating a new entry point, use a grommet to protect the cables.
3. The cable must not be cut, kinked, or bent tightly, as their performance degrades and a system failure may result
4. If cables are not terminated, terminate the cable and check connectivity before connecting to the antenna
5. Route the cable back to the Jasset module.
6. A universal antenna mounting bracket is supplied to secure the Cellular antenna.
7. Mount the N-type adapter through the 16 mm hole in the universal bracket and secure the antenna using a lock nut.
8. Mount the 4G antenna to the N-type adapter.
9. Mount the universal antenna bracket onto the equipment in a location more than 30 cm away from the human body and more than 20 cm from other aerials and equipment structure.
10. Secure universal mounting bracket to the equipment using the provided bolts.
11. Connect the N-male connector to N-type adapter and route the cable to the Jasset module and connect the TNC connector to the 4G port.

4.5 SIM Card Installation – Jasset G, WG, and WWG

Caution:

The SIM card used in Jasset G, WG, and WWG must be a data SIM, and data must be activated on the network. Voice-only networks will not carry the Jasset data.

Note

Data charges may apply. Due to the activity on the networks, unlimited data contracts are suggested to avoid extra data charges.

To enable cellular support on systems equipped with a 2/3/4G internal modem a data SIM card from a suitable service provider is required

1. Place the unit on a workbench.
2. Unscrew the two captive thumb screws by hand and open the cover for the SIM card slot.
3. Use a pointed instrument to press the release mechanism.
4. Slide out the SIM card holder.
5. Place data SIM card into SIM card holder with the chip facing up.

Note:

Ensure that the SIM card is securely seated in the holder.

6. Insert the SIM card holder back into the SIM card slot.

CAUTION:

Ensure that the black rubber seal is fitted correctly into the groove in the access panel door to keep water and dust out to prevent damage to the internal circuitry.

7. Replace the cover, and replace screws to secure.
8. When the unit is turned on, ensure the wireless connection LED appears.

5 Software Installation

Leica Jasset is provided with a low level configuration before it is shipped from Leica Geosystems Mining. Each unit requires a site-specific software update on site. The following procedure is also used for software upgrades.

Note:

Contact Support for the required files.

5.1 Update Leica Jasset Software using USB Flash Drive

CAUTION

Do not turn off the unit, or remove the USB Flash Drive (key) while the software upgrade is under way.

The software is installed from a USB Flash Drive (key). Installation files are provided by Leica Geosystems Mining support and are specific for each installation site.

Procedure Requirements:

- A Computer connected to the mine Ethernet
- Clean USB key.



1. Using the computer, extract the provided files and copy onto the clean USB key:

```
leica\autorun
uhp-mojo-?.sqfs
```

2. Copy the site setup.sqfs to the USB key (this is the same setup.sqfs as used on the site's other Jigsaw USB flash keys).

```
setup.sqfs
```

3. The files on the USB key appear as in the graphic:

Name	Date modified	Type	Size
 leica	9/01/2015 9:40 AM	File folder	
 setup.sqfs	12/12/2014 2:04 PM	SQFS File	224 KB
 uhp-mojo-2.21-rc3.2.sqfs	8/01/2015 12:17 PM	SQFS File	72,144 KB

4. To start the unit, connect the service cable to the Leica Jasset and supply power.
5. Configure the computer's local ethernet to a static IP address of 192.168.200.10 and a netmask of 255.255.255.0 and connect to the Jasset using the Ethernet extension cable.
6. Unfasten two captive thumb screws and open the USB port access panel.
7. If the Jasset module is powered off, power on the unit.
8. After approximately 30 seconds ping the unit on the address 192.168.200.1 continually until there is a response.
9. Open up the web browser and enter the following <http://192.168.200.1/platform-setup> to verify the unit has completed its start-up sequence and it is safe to plug in the USB key.

CAUTION

Do not turn off the unit, or remove the USB Flash Drive (key) while the software upgrade is under way.

10. Insert the USB key into Leica Jasset module USB port after the unit has powered on.

Note:

LED status prior to the software update may vary.

The format process can take between three to five minutes to complete, once the process is complete all three LEDs on the Leica Jasset start to flash for approximately 10 seconds and then remain on permanently.

11. In updating the unit, whether the module is configured or not configured, any installed software is overwritten and an update is forced.
12. During the software upgrade the following is observed:
 - a. At the beginning of the upgrade all LEDs are momentarily off. The red power LED then flashes on and off three times.
 - b. All LEDs are on permanently while the firmware upgrade progresses.
 - c. The process completes when all three LEDs on the Leica Jasset start to flash on and off indefinitely, indicating the upgrade is complete and that the Jasset module is in an unconfigured state.
13. When the process is complete, remove the USB key from the unit and start the configuration process. See [Configure Leica Jasset](#).

CAUTION

Ensure that the black rubber seal is fitted correctly into the groove in the access panel door to keep water and dust out to prevent damage to the internal circuitry.

14. Close the USB access panel and fasten the thumb screws hand tight. Ensure the access panel is secured to retain the weather-resistance rating of the Jasset module.

5.2 Configure Leica Jasset

CAUTION

Ensure the USB key is removed before performing configuration.

1. Make sure the software is upgraded and the USB key removed before performing this procedure.

Note:
One or two cables are required for the technician to connect a computer over ethernet to the Jasset.

 - Part No 828063, Drawing number JAS_DWG_004, Jasset Breakout cable
 - Part No 832053, Drawing number JAS_DWG_020, Jasset Ethernet Extension RJ45 cable
2. Connect the service cable to the Leica Jasset and supply power so that the unit is operating.
3. Once Jasset has booted up and is operating, configure the computer's local ethernet to a static IP address of 192.168.200.10 and netmask of 255.255.255.0
4. Ping 192.168.200.40 (Jasset's local Ethernet IP address) before proceeding.

- Open a web browser and enter the following:

<http://192.168.200.40/platform-setup>

The following dialog appears:

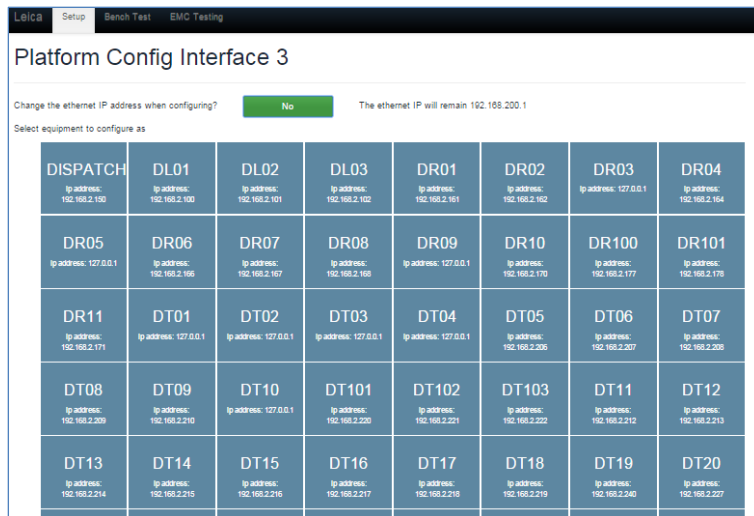

- The system prompts to change the ethernet IP address when configuring. The ethernet address is set to the default 192.168.200.1.
- Select **No** to keep the default ethernet IP address.
- Select the equipment to configure the unit. The unit reboots and starts to operate within two minutes. See [LEDs](#) for information on LED status indication.
- Web Windows shows a **Done** status after loading when reboot is complete.

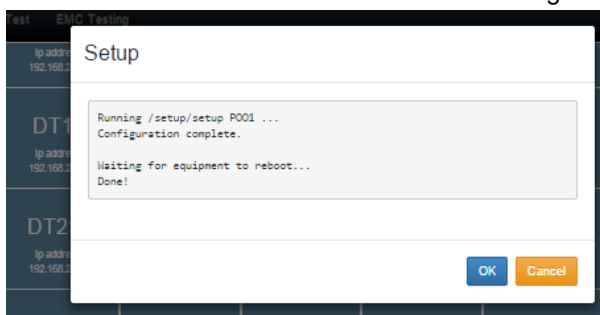

- The unit can be reconfigured as a different unit by accessing the web interface and selecting the reconfigure button to select different equipment as shown.



5.3 Installation and Configuration Verification

1. Ensure the unit is powered as indicated by the Jasset LED status for power.
2. Ensure the GPS and Wi-Fi is correct. Refer to [Section 2.2.2](#).
3. Use Jmineops Equipment Operations to verify Jmineops server can see the Jasset module. See Leica Jmineops Equipment Operations on page 37.
4. Use Jmineops Mine Map to verify the Jasset is present in the expected location on the Mine Map. See Find a Jasset on the Jmineops Mine Map on page 39.

6 Leica Jmineops Jasset Office Administration

The Leica Jasset product is administered using the Leica Jmineops application. These procedures cover only Leica Jasset-specific Leica Jmineops functionality. For regular Leica Jmineops processes please see the Jmineops documentation.

Note:

To interact with Jmineops, the Jasset must be configured in the Jmineops system.

6.1 Asset Icon





The asset icon represents the equipment and the equipment position in relation to the Mine Map and other equipment on the Mine Map both in Jmineops and on the Jpanel.

6.1.1 Available Asset Icons

Note:

Asset icons are based on specific asset types. The icons shown may differ from the icons on the screen. If other asset icons are required, contact Leica Geosystems Mining support.

Asset Icons

Asset Type	Appearance
Generator	 A yellow and black icon of a generator with a lightning bolt symbol on the front panel.
Lighting Plant	 A yellow and black icon of a lighting plant with two blue light fixtures on a tall pole.
Portable Toilet	 A blue icon of a portable toilet with a white door.
Pump	 A yellow and black icon of a pump with a blue water drop symbol on the front.
Communications Wi-Fi Trailer	 A yellow and black icon of a trailer with a large black antenna on top.

6.1.2 Asset Proximity Ring

The proximity radius ring displays on the Jpanel GPS tab to allow equipment users to see the acceptable proximity to an asset. The radius ring's night and day color, thickness, and radius are configured. If changes are required, please contact Leica Geosystems Mining support. The asset proximity ring is shown in all field device Jpanels and is for visual indication only.

6.1.3 Leica Jasset Representation on the Mine Map

Assets are displayed with the Asset Name and Asset Icon on the mine map.

Example Asset with Asset Name

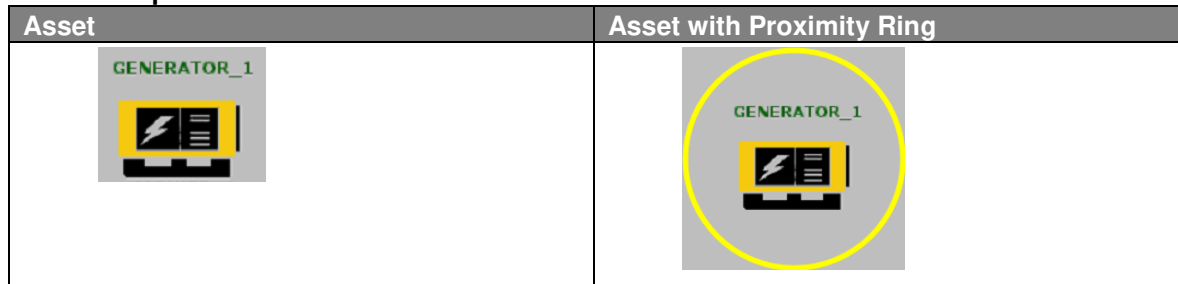

6.2 Jmineops Asset View

The Asset view allows the user to view and edit information for configured assets in the Jmineops system. The Assets view is accessible from the Mine Map or from the Assets menu item.

The Jmineops Asset view has two tabs:

- Asset: details a single asset.
- All: details all assets in the system.

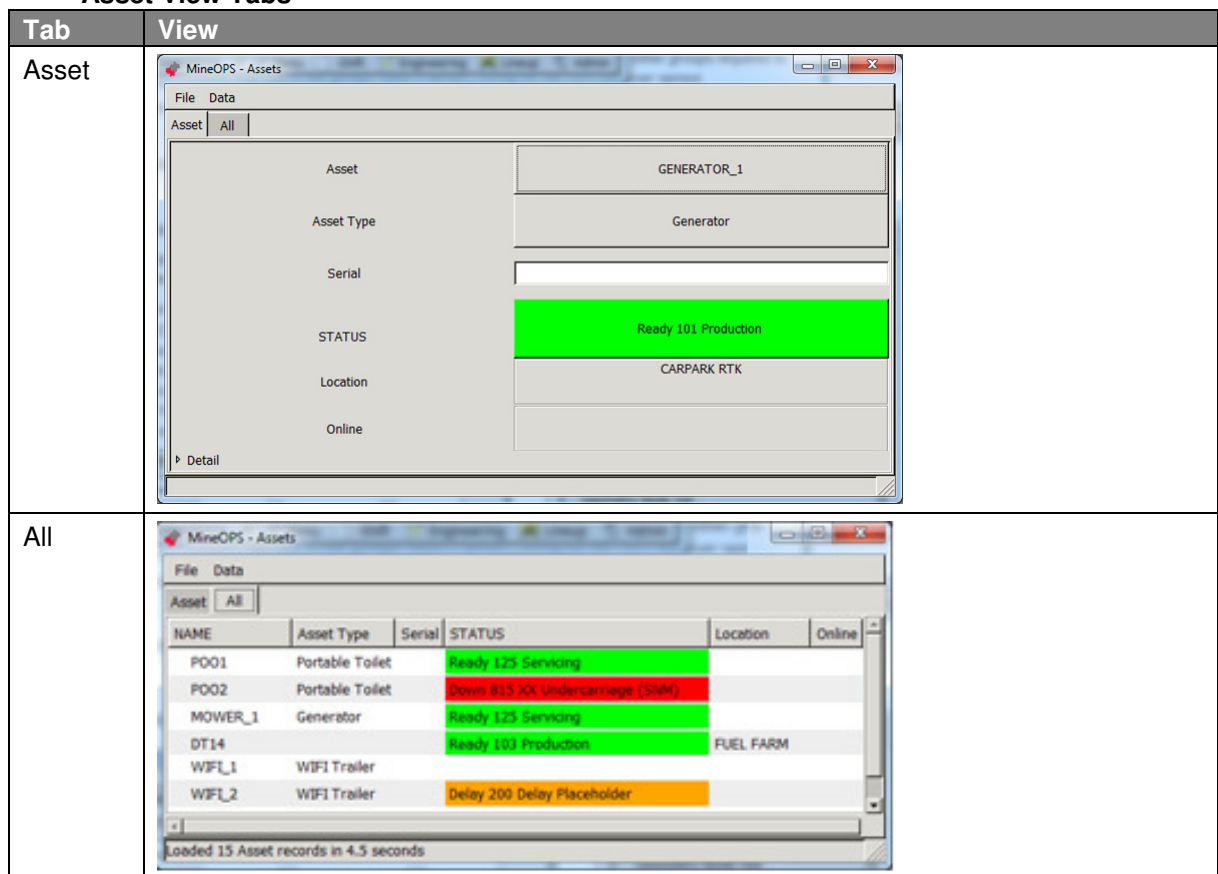

Asset View Tabs



Asset information displayed in the view includes:

Field	Description
Asset, Name	Name of the asset.
Asset Type	Type of asset. Asset types must be configured.
Serial	Serial number of the asset selected.
Status	The asset's current status and reason. For more information on Status and Reason setting, see Change Status and Activity .
Location	The current location of the asset.

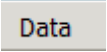
Buttons, tabs, and commands available in this view are:

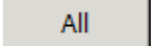
Field	Display	Description
FILE		The configurable menu usually provides Save As, Print PDF, and Close options.
Data		The configurable menu usually provides data handling options e.g. Refresh and Filter options.
Asset		Asset tab allows the viewing of details of a single asset from a list.
All		All tab allows the viewing of a detail list of all assets in the system.

6.2.1 Access Asset View from Jmineops

An asset's attributes can be changed using Leica Jmineops Asset view.

Note:

Leica Jmineops menus are configurable; the Asset menu item location may vary.

1. To access the Asset view, select **Operations > Assets**.

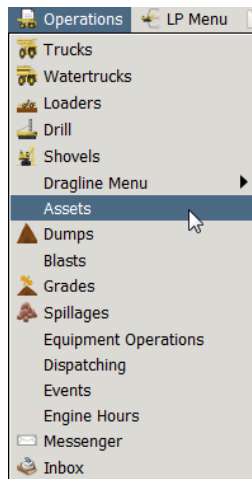

The Asset view appears.

- To display all assets on the mine site, select **All**.

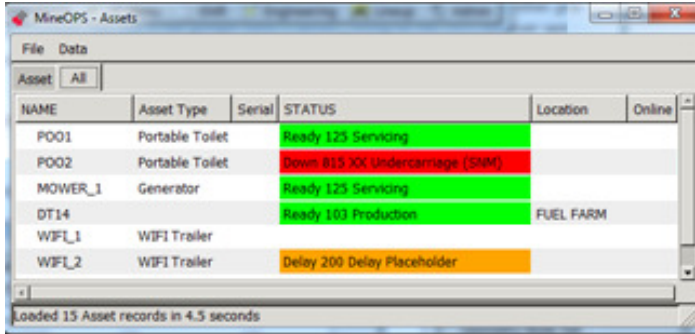

6.2.2 Change an Asset's Attributes

Assets have direct attributes (e.g. status) that are accessible only through the asset object and indirect attributes (e.g. length) inherited from the underlying equipment object.

To update:

- Direct attributes, use the Asset view (particular fields are shown in following sections).
- Equipment length etc, see Update an Asset's Equipment Attributes on page 42.
- Location, but only for a stationary asset, see Change Position of a Stationary Asset on Mine Map on page 43.

6.2.2.1 Change Asset Type

To change the asset type:

- Select **Operations > Assets**, select **All**. The Assets view appears.
- Select the row of the asset. The asset's row is highlighted.
- Select the **Asset Type** field of the asset's row. A drop-down menu of asset types appears.

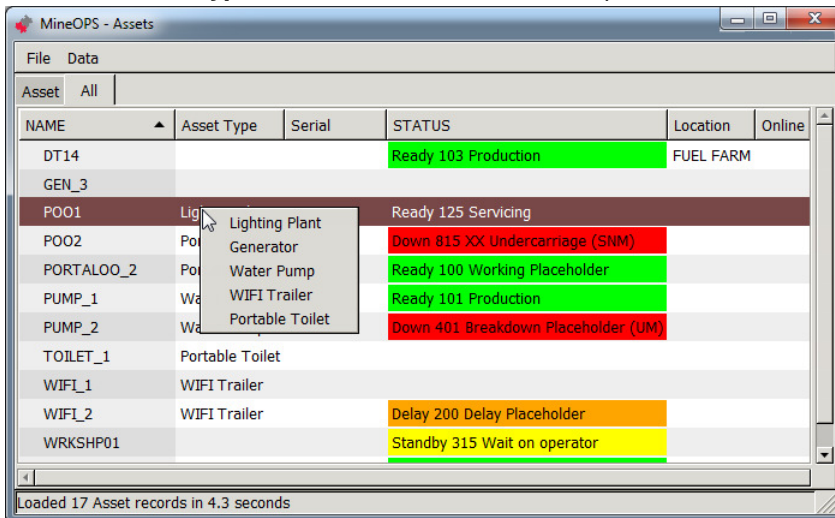

- Select the required asset type. The asset type is applied to the asset.

6.2.3 Change Status and Activity

Note

Status and activities changes can be automated if Jasset is connected to a switch or a PLC. Contact Leica Geosystems Mining support for more information.

Use the STATUS option to change the equipment status to match the current activity. At each status change, the Mine Controller is notified and the status changes are recorded throughout the day which assists in the monitoring of mine scheduling. When the system is running, the equipment is always in a status state. Follow the mine site's requirements for changing equipment status.

Note

The status options in the system may vary from those presented in this manual. Status options are configured in accordance with equipment and mine site requirements.

Status options are

- Ready—the asset is ready for work.
- Delay—the asset is delayed.
- Down—the asset is unavailable for work.
- Standby—the asset is waiting.

After selecting the equipment status, select a reason or state for that status. Each status has a menu of reasons (or states) that are configured for each mine site.

To set the asset's status:

1. Select **Operations > Assets**. The Assets view appears. Select **All**.
2. Select the row of the asset. The asset's row is highlighted.
3. Select the **STATUS** field of the asset's row. A drop-down menu of statuses appears.
4. Select the required status. A drop-down menu of reasons appears.

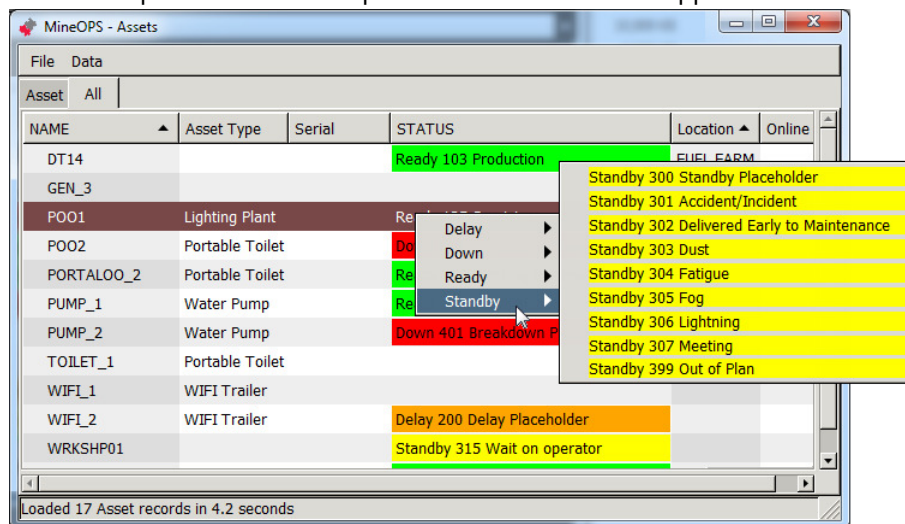

5. Select the required reason. The status and reason is applied to the asset.

6.3 Leica Jmineops Equipment Operations

The Leica Jmineops Equipment Operations view provides a similar view to Asset view, but provides Wi-Fi and GPS connectivity information, which can be used to validate communications between the asset and the Jmineops server, and verify the Asset GPS is working.

1. To open the Equipment Operations view, select **Operations > Equipment Operations** as shown.

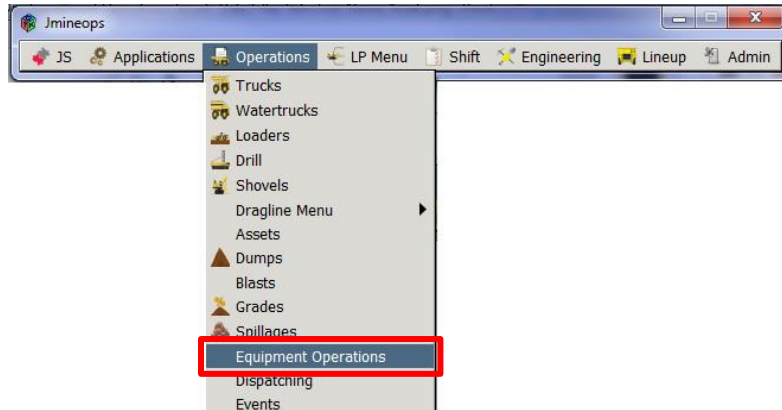

The Equipment Operations view appears.

2. Select **Data > Filter** from the Equipment Operations menu.

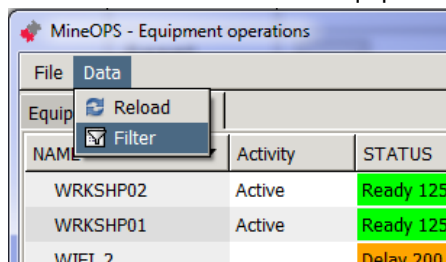

The equipment operations filter dialog box appears.

3. Select the **NAME** button. The NAME menu options appear. Select the Asset check box and then select **OK** to display assets only.

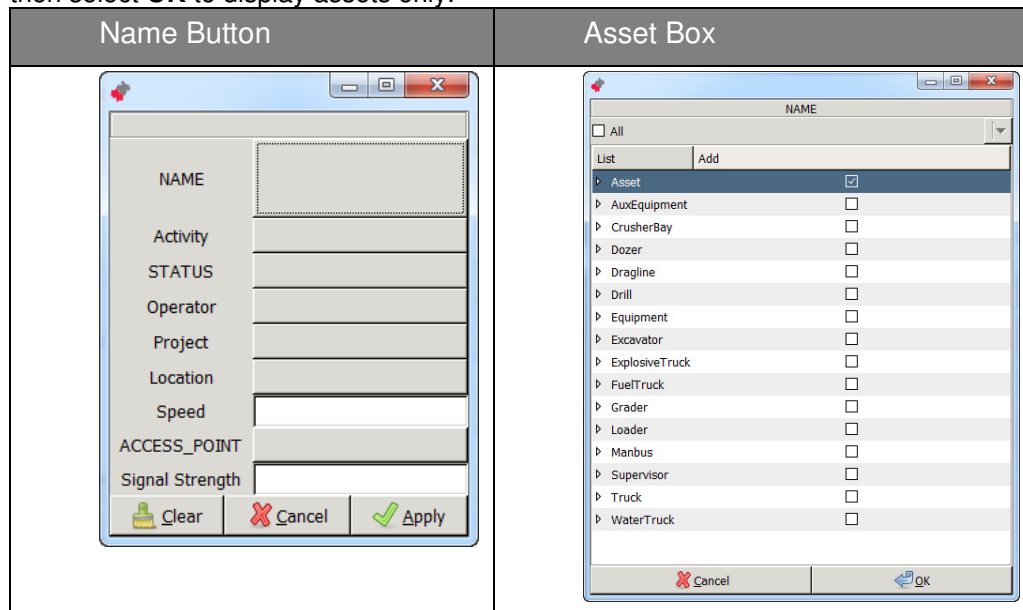

4. Select the **Apply** button to show the filtered (i.e. Asset) item.

- To verify the Wi-Fi communications between the Jmineops server and the Jasset module is working, check the value in the signal strength column. The received signal strength indication (RSSI) range is -93 for OK to -53 for Excellent. If the value is outside that range, signal strength is marginal to poor.

NAME	Activity	STATUS	Operator	Project	Location	traveling.coordinate.tog	Speed	ACCESSPOINT	Signal Strength
WRKSHPO2	Active	Ready 125 Servicing		Asset		5058.19E 5005.69N 506.96	0	PD BENCH WIFI	-62
WRKSHPO1	Active	Ready 125 Servicing		Asset		5022.26E 5031.03N 507.69	0		
WIFI_2		Delay 200 Delay Placeholder		Asset		none			
WIFI_1						none			
TOILET_1						none			
PUMP_2		Down 401 Breakdown Placeholder (UM)		Asset		none			
PUMP_1		Ready 101 Production				none			
PORTALOO_2		Ready 100 Working Placeholder		Asset		none			
POO2	Active	Ready 101 Production		Asset		5025.01E 5026.58N 512.50	0	PD BENCH WIFI	-38
POO1	Active	Ready 125 Servicing		Asset		5026.82E 5025.01N 509.89	0		
MOWER_1	Active	Ready 125 Servicing		Asset		5029.10E 5025.33N 506.39	0	PD BENCH WIFI 2	-53
LIGHTING_1						none		PD BENCH WIFI 2	-46
GENERATOR_2		Standby 300 Standby Placeholder		Asset		none			
GENERATOR_1	Active	Ready 101 Production			CARPARK RTK	5027.06E 5128.75N 517.09	0		-56
DT14	Traveling	Ready 103 Production		Truck	FUEL FARM	5012.02E 5030.74N 501.71	0		-67

6.4 Leica Jasset on the Mine Map Application

The Leica Jmineops Mine Map can be configured with a Jasset layer. Any Jasset configured in Leica Jmineops can be displayed on the Mine Map Jasset layer.

6.4.1 Enable Jasset Layer on Mine Map

- To access the Mine Map, open Jmineops, select **Applications > Mine Map**, the Mine Map view appears.

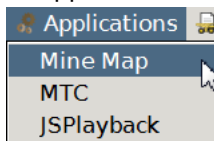

- If the Asset layer is enabled, Jassets are displayed by asset name and asset icon.

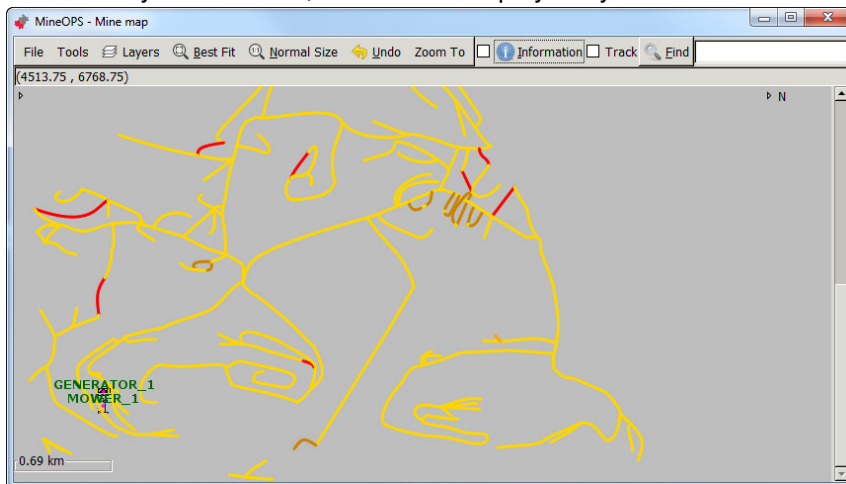

- To enable the Asset layer, select **Layers > Asset > Enable**.

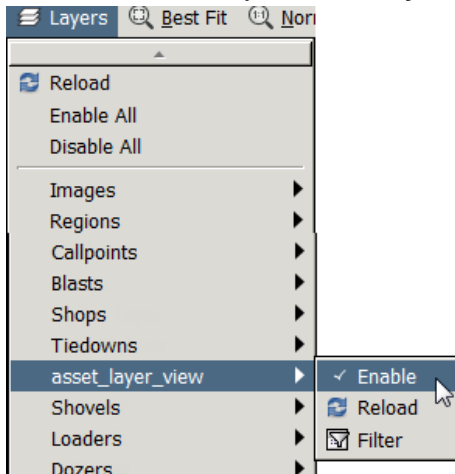

Note:

The Jasset Layer menu options are:

- Enable—Enables the Jasset layer which displays the assets in their last known location.
- Reload—Reloads available Jassets on the Mine Map.
- Filter—Filters Jassets by selected criteria.

6.4.2 Find a Jasset on the Jmineops Mine Map

When the Jasset layer is enabled, Jassets can be found on the Mine Map.

- To access the Mine Map in Leica Jmineops, select **Applications > Mine Map**, the Mine Map view appears.

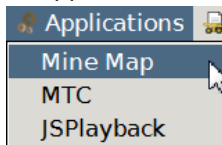

- Select the Mine Map **Find** button, a menu of all items on the map appears.

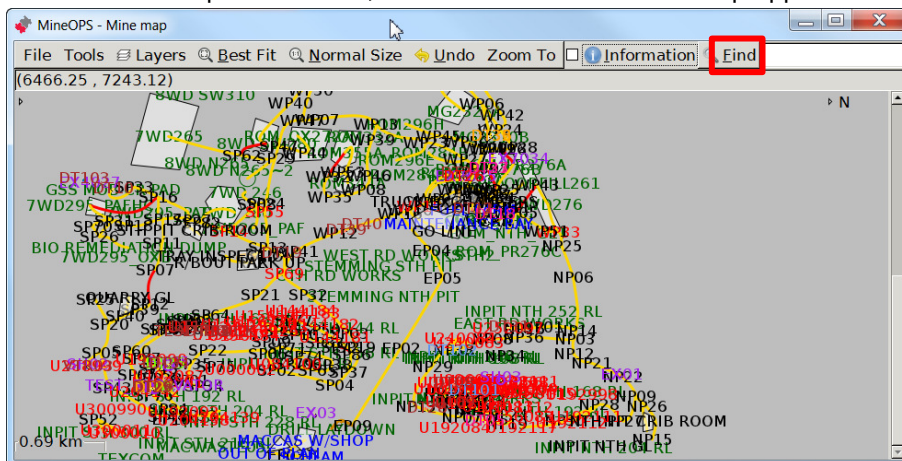

3. Select **Asset**, a menu of configured assets appears. Select the required asset.

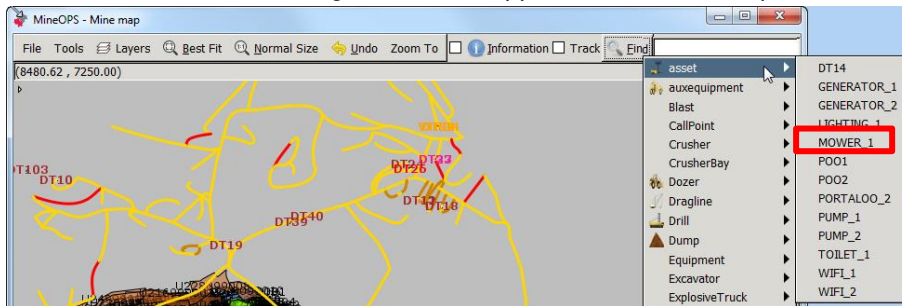

4. The callout and asset proximity radius flashes on the Mine Map display. Hover the cursor over the flashing callout and the asset is circled on the map.

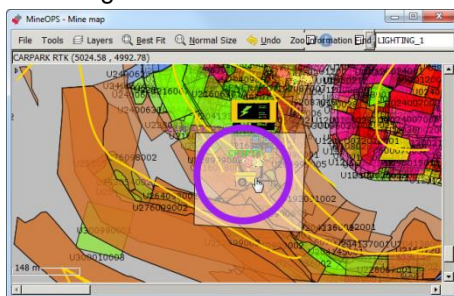

6.4.3 Filter Assets on Mine Map by Asset Type

1. To filter assets on the Mine Map by activity, select **Layers > Asset > Filter**. The filter option dialog box appears.

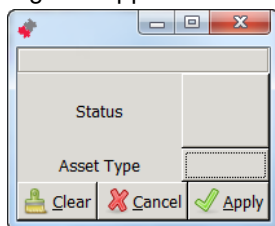

2. Select **Asset Type**. The Asset Type dialog box appears.

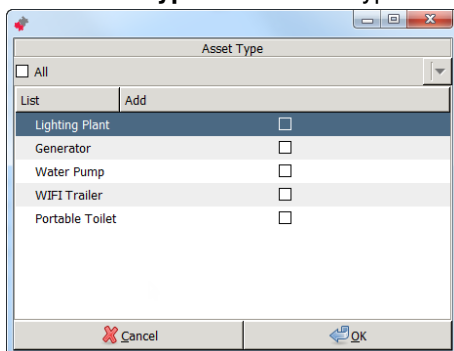

Note:

More than one asset type may be selected. Selecting a specific asset displays only the assets which are available on the Mine Map. If no asset type is selected, all assets are displayed.

3. Select the check box for the asset types to display, select **OK**.
4. The Filter Option dialog box appears with the Asset Type populated with the asset types selected. Select **Apply**. The Mine Map displays only the assets of the selected type.

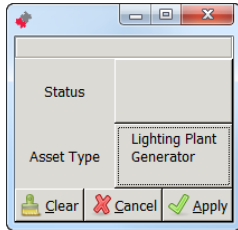

6.4.4 Access Jmineops Asset View from Mine Map

1. To access the Asset view from the Mine Map, locate the asset on the mine map.

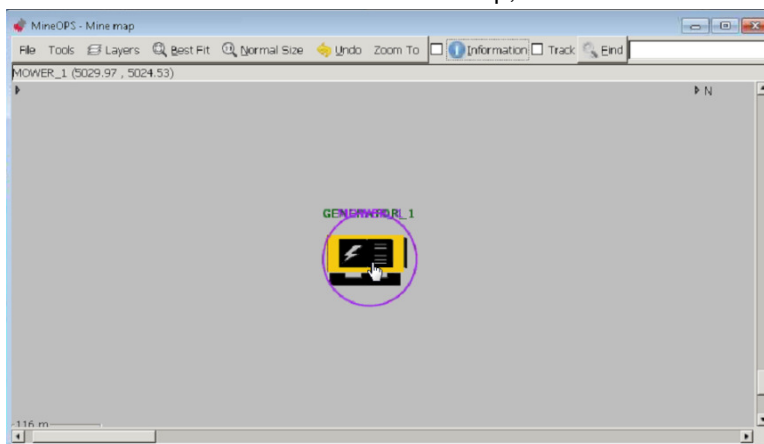

2. Double-click on the asset. The Asset view appears with the asset's details.

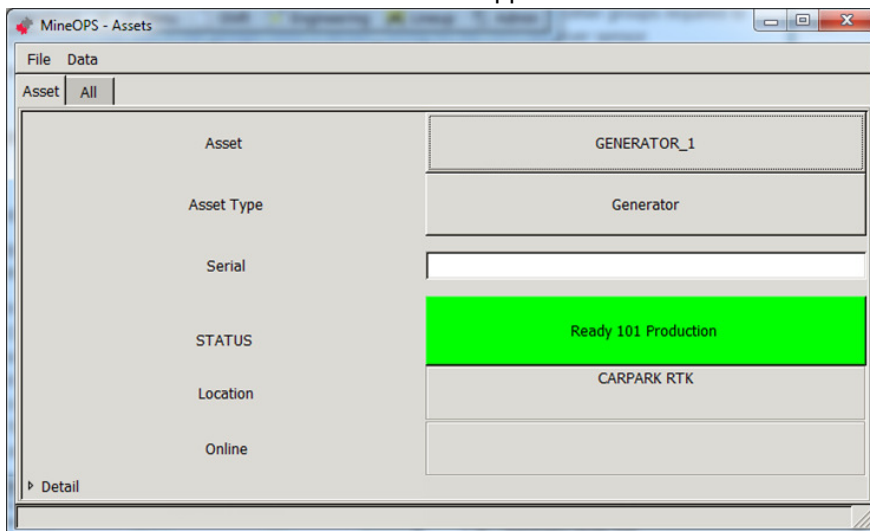

6.5 Update an Asset's Equipment Attributes

CAUTION

Do not change an asset equipment's NAME or create a non-stationary asset: these actions can make the specified asset unmanageable.

To update an asset's equipment attributes:

1. Select **Engineering > Equipment**. The Equipment view appears.
2. Select the **Equipment** tab.
3. Select the **Equipment** field. A drop-down menu of equipment types appears. Select **asset**. A drop-down menu of assets appears.

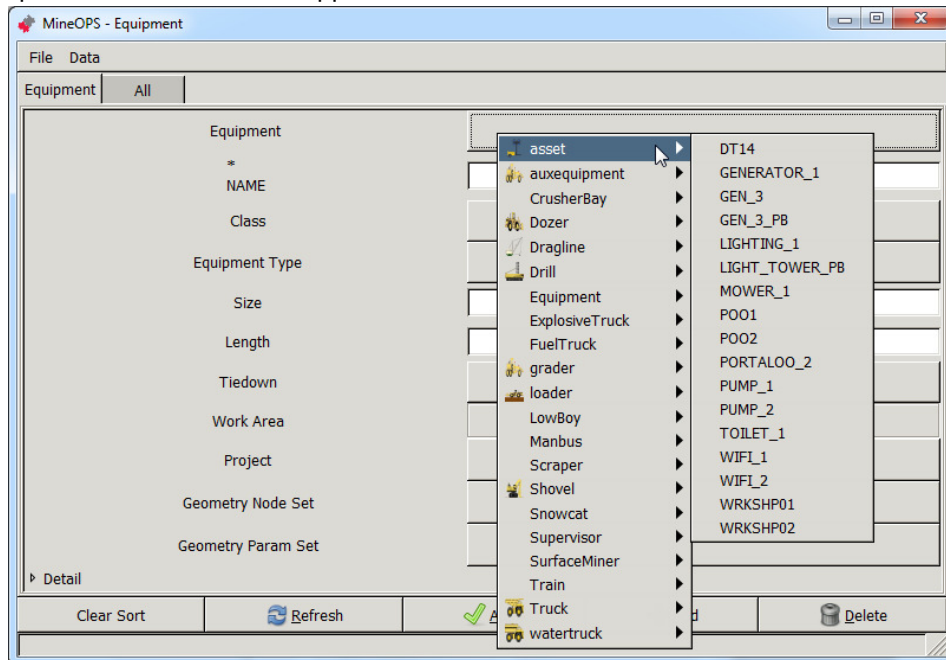

4. Select the required asset.
5. Update fields.

Note

Set the Length field because that value is used to scale the asset's icon on the Mine Map. A recommended minimum value is 10.

The Geometry Node Set and Geometry Param Set fields are not applicable.

Enter values for the fields as required.

6. Select the **Apply** button. The attributes are applied.

6.6 Create and Maintain a Stationary Asset

CAUTION

Do not create an asset other than a stationary asset: non-stationary assets require additional configuration to make them operational.

Use a stationary asset to track an asset that must appear on the Mine Map but that never moves and therefore doesn't need an attached GNSS locator.

Use the following procedures to create a stationary asset and to set the asset's position. To set the asset's status etc see Change an Asset's Attributes on page 35.

6.6.1 Create a Stationary Asset

To create a stationary asset:

1. Select **Engineering** > **Equipment**. The Equipment view appears.
2. Select the **Equipment** tab.
3. Select **Add**. The Equipment Class drop-down menu appears.

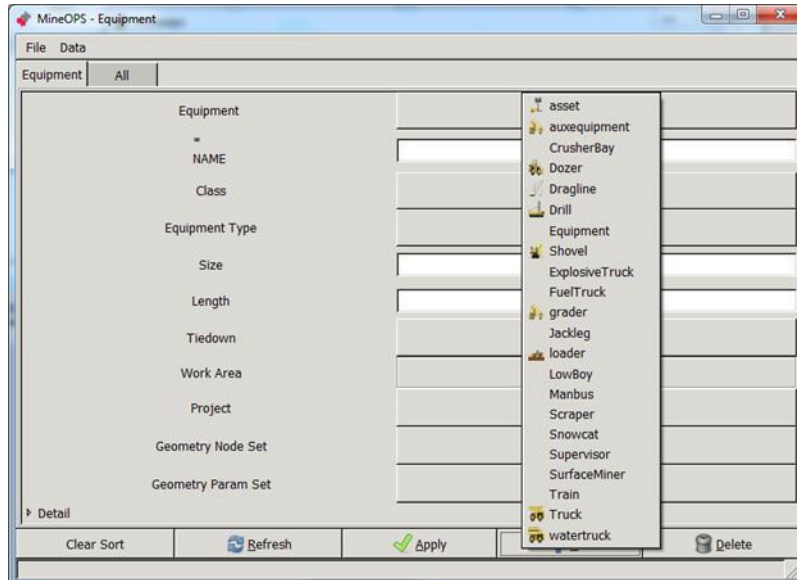

Select **asset**. The Equipment field is auto-populated with a name and the Class is set.

4. Select the **NAME** field, enter the asset's unique name.

Note

Set the Length field because that value is used to scale the asset's icon on the Mine Map. A recommended minimum value is 10.

5. Enter the Length field.

Note

The Geometry Node Set and Geometry Param Set fields are not applicable.

6. If required, enter values for the remaining fields.
7. Select the **Apply** button. The asset equipment is created.
8. Set the asset's position—see Change Position of a Stationary Asset on Mine Map below.
9. Set the asset's attributes, especially asset type and status—see Change an Asset's Attributes on page 35.

6.6.2 Change Position of a Stationary Asset on Mine Map

Use this procedure if an asset location is incorrect, or requires adjustment from the office.

Note:

This procedure only applies to stationary assets

1. Select **Engineering** > **Equipment Positioning**. The Equipment Positioning view appears.
2. Select **Equipment**.

3. Select the **Equipment** field. A drop-down menu of equipment classes appears. Select **asset**. A drop-down menu of assets appears.

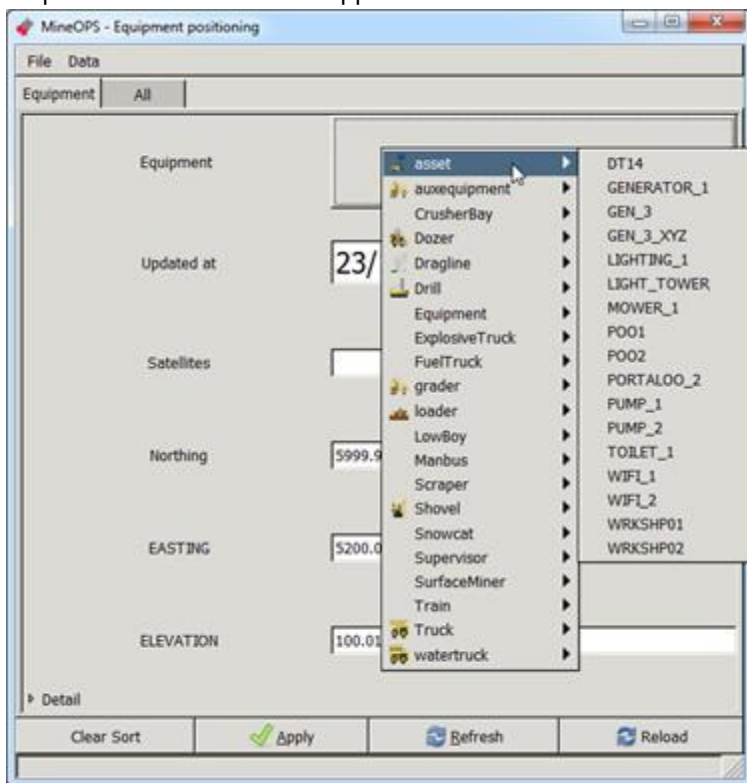

4. Select the required asset.
5. Edit the location fields.
6. Select **Apply**.

6.7 View Jasset using Shift State View

1. Select **Shift > Shift States**, the shift States view appears.

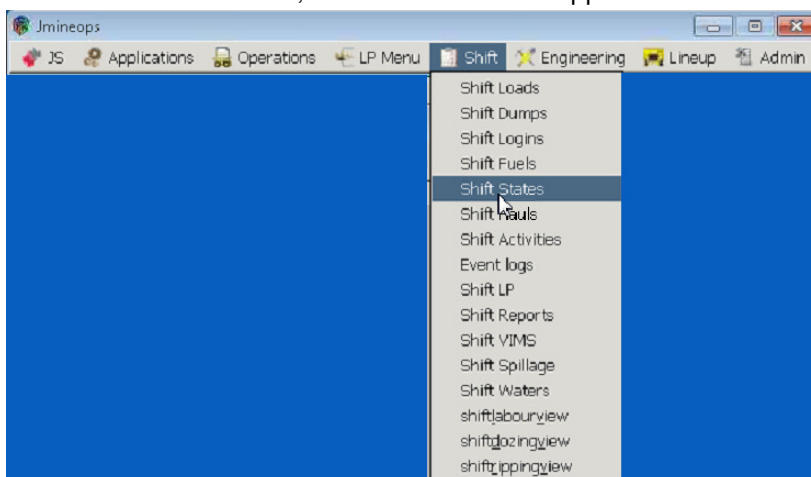

2. Select the **Initial Date**, **Initial Shift**, **Final Date**, and **Final Shift**. Select **Load**.

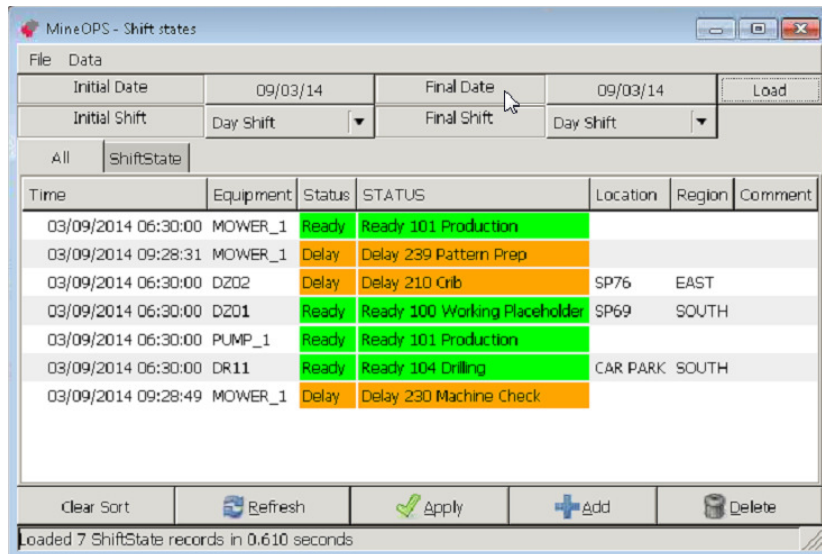

Note:

Asset Status can be changed in the Shift State view.

3. The shift states view is populated with the asset status during the selected shifts.
Information displayed in the view includes:

Field	Description
Time	Time that the state record was created.
Equipment	Equipment name—same as the asset name.
Status	The equipment's status. Status values are configurable but typically include Ready, Delay, Down, Standby.
STATUS	The equipment's status and reason. Status and reason values are configurable.

6.7.1 View Jasset by Shift Status

Assets may be filtered by status (e.g. Ready) or by status and activity (e.g. Standby - Accident/Incident).

To filter assets on the Shift States view by status or status and activity:

1. Select **Data > Filter**. The filter option dialog box appears.

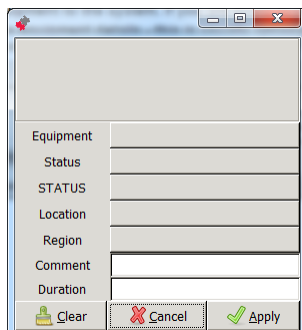

- To filter by status, select **Status**. To filter by status and activity, select **STATUS**. The relevant dialog box appears.

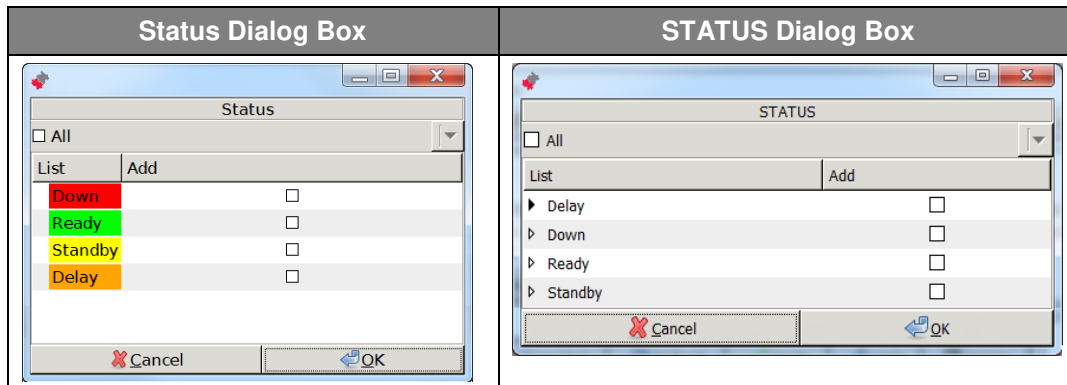

To filter by status only:

- Select **Data > Filter > Status**. The Status dialog box appears.

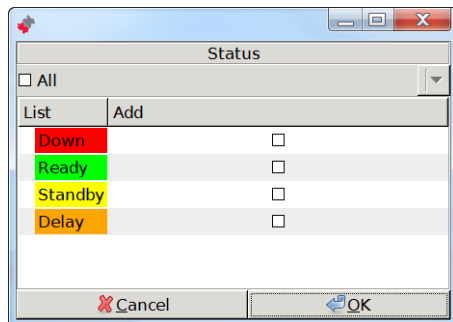

Note:

More than one status may be selected.

- Select the check box for the status to display, select **OK**. The filter option dialog box appears with the Status field set to the selected value(s).
- Select **Apply**. The assets with the selected status are displayed in the Shift States view.

Note:

Selecting a specific status displays only the assets that have the selected status. If no status is selected, all assets of any status are displayed.

To filter by status and reason:

1. Select **Data > Filter > STATUS**. The STATUS dialog box appears.

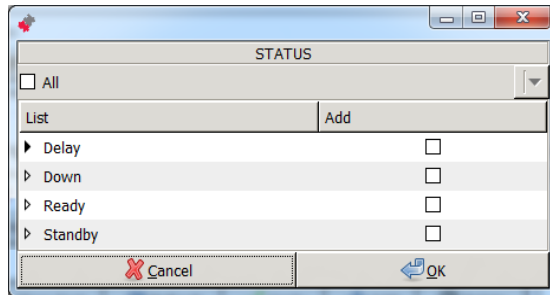

Note

More than one status may be selected.
All reasons or individual reasons for a status may be selected.

2. To select all reasons for a status, select the check box for the status.
3. To select a specific status and reason:
 - a. Select the drop-down button beside the status.

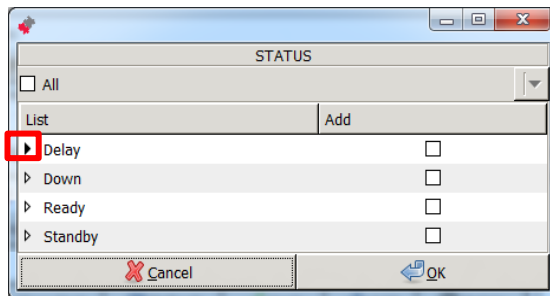

The drop-down menu displays the reasons assigned to the status.

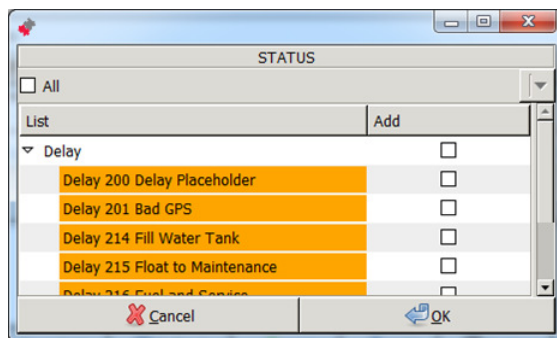

- b. Select the check box for a reason to display.
4. Select **OK**. The filter option dialog box appears with the STATUS field set to the selected value(s).
 5. Select **Apply**. The assets with the selected status and reason are displayed in the Shift States view.

Note

Selecting a specific status and reason displays only the assets which have the selected status and reason. If no status and reason is selected, all assets of any status/reason are displayed.

6.8 Set Update Timing (Low Power Mode)

If the Jasset is running on battery power it can operate in low power mode. In the low power mode, the Jasset module is configured to shut down and to operate at timed intervals. Jmineops is configured to update during these time intervals to conserve battery power.

- The wakeup timeout is calculated using the system up time and not the clock.
- The default wakeup interval is 3600 seconds (60 minutes). This means the unit starts up at approximately the same time each hour.
- The default timeout is 900 seconds (15 minutes), giving the unit a maximum of 45 minutes in every hour spent off. If the system can connect and complete a replication cycle in less than 15 minutes, the unit spends more time asleep.
- In low power mode, battery power can last up to ten days.

To change Jmineops update timing, please contact Leica Geosystems Mining support.

6.9 Manage Engine Hours

The Jasset product can track engine (operational) hours. Available tracking methods are manual input and switch sensor input.

To enable the engine hours option, please contact Leica Geosystems Mining support.

6.10 Monitor Asset Overspeed Alerts

Overspeed alerts on mobile assets are monitored in the same manner as other alerts in the Jmineops system. To configure over speed alerts, please contact Leica Geosystems Mining support.

6.11 Jasset on Jsplayback

The historic location of the Jasset can be tracked on Jsplayback.

Note:

Ensure the Jasset layer is enabled in the Jsplayback application. If the Jasset layer is not enabled on Jsplayback, contact Leica Geosystems Mining support.

1. Select **Applications > JSPlayback**.

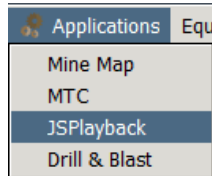

2. The mine map appears with roads and the asset icons visible.



3. If asset icons are not visible, to show assets on the view, select **Layers > Asset > enable**.
4. Set the date range for playback.
 - a. Select the **From Date** button, the date calendar appears, Double click the date to select.
 - b. Select the **From Hour, Minute, Second** as required.
 - c. Select the **To Date** button, the date calendar appears. Double click the date to select.
 - d. Select the **To Hour, Minute, Second** as required.

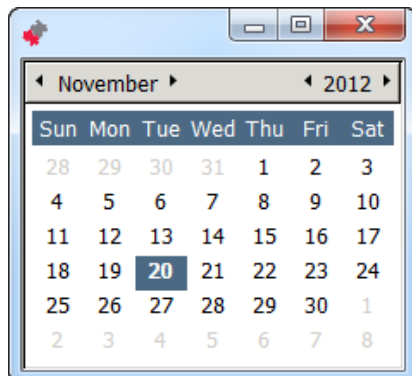

5. Select **Load**. The data loads.

Note

Loading data for Jsplayback may take time depending on the length of the date range selected. The system displays Processing GPS Data in the status bar while the data loads.

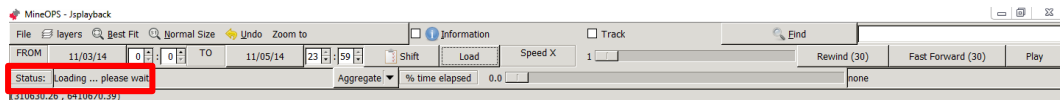

6. The status bar displays Press Play, select **Play**. The playback begins.

Note

- The playback time is displayed in the status bar.
- The speed of playback is controlled using the Speed X Slide Bar

7. The Play button toggles between Play and Pause. To pause the playback, select the **Pause/Play** button.

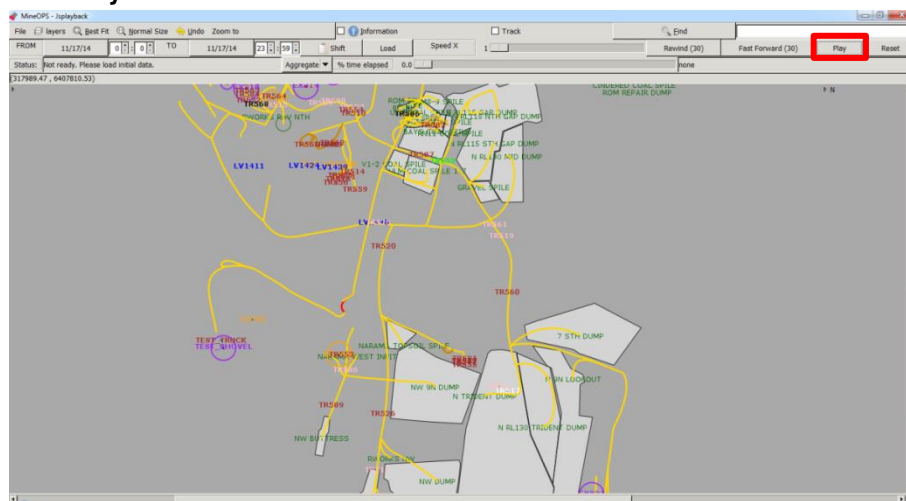

6.12 Jmineops Asset Status and Activity History Gantt Chart View

The Status and Activity Gantt view provides a visual representation of equipment status, activities, and login history data over a specified time range. This provides the user with a clear visualization of machine time utilization in an easy to interpret manner saving time and highlighting areas for operational improvement. The tools also provide a quick and easy mechanism to modify dates.

The view contains one series of rows for each machine. The expandable sub-rows indicate user login, machine status, and activity types. The timeline shows blocks of color for each activity type. Data details can be viewed, edited, and deleted.

The colors displayed on the activity row are defined in the Activity and Activity Category editors in Jmineops. To quickly determine the meaning of a section of color, place the cursor over the section. This displays a tool tip of the data.

6.12.1 Access Status and Activity Gantt View

1. To access the Gantt view, select **Shift > Status and Activity Gantt** view. The Status and Activity Gantt view appears.

Example Initial Status and Activity Gantt view

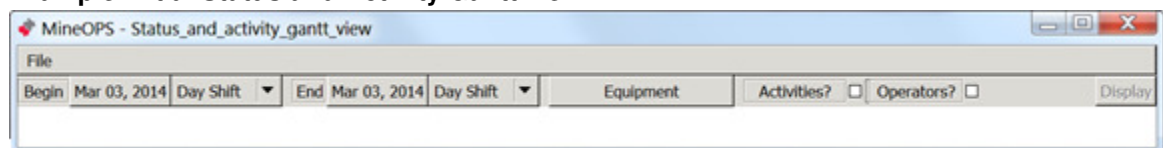

6.12.1.1 Status and Activity Gantt View

Example Status and Activity Gantt Chart View

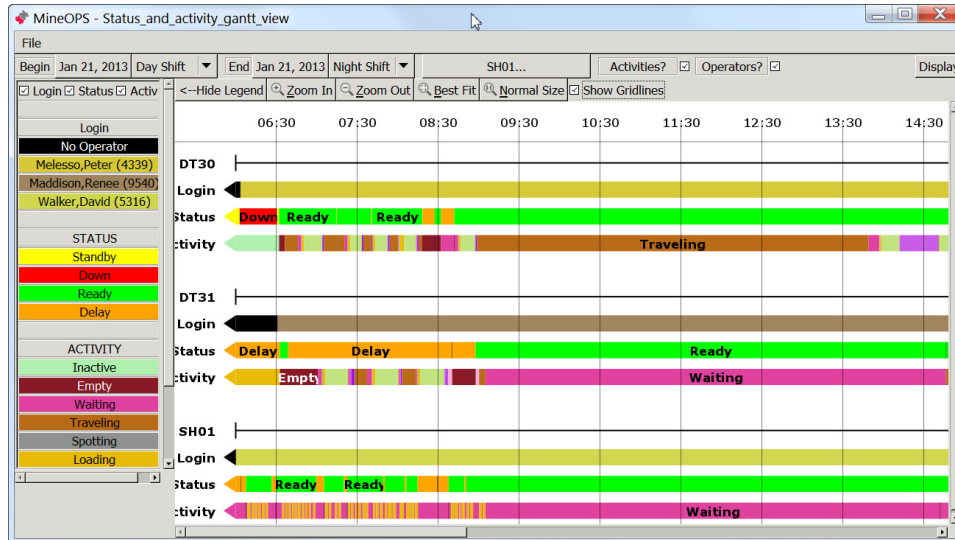

Controls and Information displayed in the Status and Activity Gantt view includes:

Field	Display	Description
File		Provides the Close option to close the view.
Begin		Buttons and drop-down menu to select the start date and time. Selection of the Begin date and shift is required.
End		Buttons and drop-down menu to select the end date and time. Selection of the end date and shift is required.
Equipment		Launches the equipment selection view to allow the user to sort what equipment history to view. Selection of the equipment is required.
Activities Checkbox		Displays a Gantt view of activities for the selected equipment over the selected date and time. View the activity entries by grouping them according to Activity category or by the user-defined time usage model.
Display Button		Loads the data requested into the Gantt chart view. The display button is inactive until a time frame and equipment are selected.

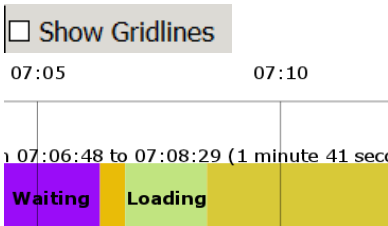
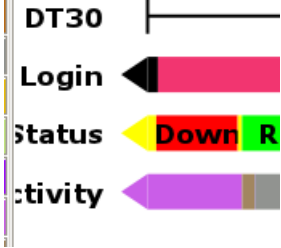
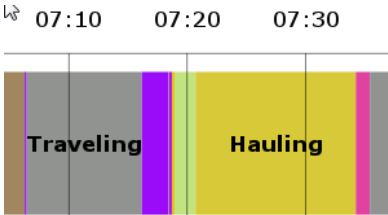
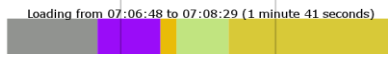
Field	Display	Description
Show Gridlines	<input type="checkbox"/> Show Gridlines 	Displays time label gridlines.
Gantt chart Equipment Data		<p>Gantt chart view of equipment can include four rows:</p> <ul style="list-style-type: none"> Equipment – Equipment name. The black line displays the extent of the data available for that equipment for that time range. Login – A series of adjacent boxes representing the user logged in to the equipment. If no user is logged in, the representative box is black. Status – A series of adjacent boxes representing the status of the machine. Activity – A series of adjacent boxes representing the activities of the equipment. <p>Note: If login, status, or activity data is available beyond the time range included in the chart, the row starts or ends with an arrow shape pointing in the direction of the additional data.</p>
Gantt chart data block element		A Gantt chart data block extends from its start time, to the start time of the next data item. If the data blocks are large enough, they display a label.
Gantt Element Information		<p>Move the cursor over the Gantt element to view detail of the Gantt chart time chunk. Information includes:</p> <ul style="list-style-type: none"> Element Start time End time Duration <p>Note: If there is no end time, the element information does not display.</p>

6.12.2 Load Data to Gantt View

1. Access the view. See [Access Status and Activity Gantt View](#).
2. To load a range of data:
 - a. Select the **Begin** date field, the date calendar appears.

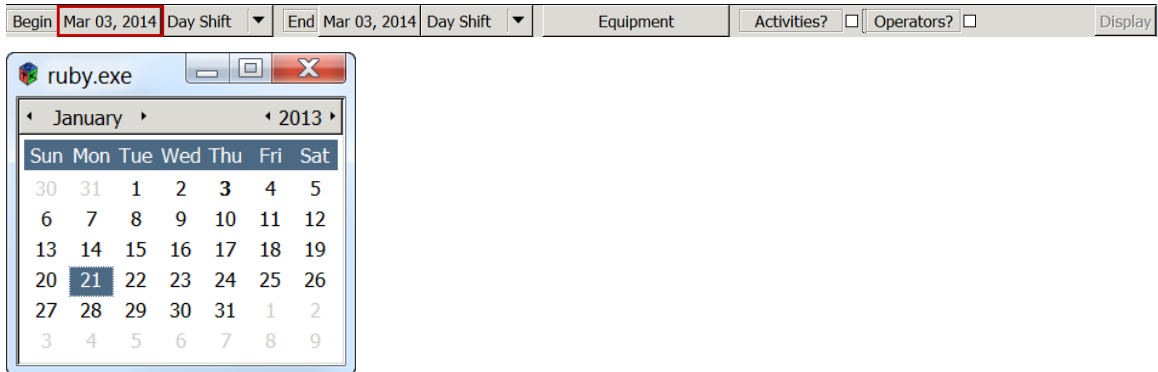

- b. Use the arrows on each side of the month and year to select the required month and year. Double-click on the day required. The Begin date is populated using the required date.

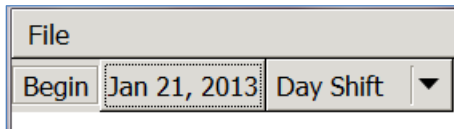

- c. To select the Begin shift, select the required starting shift from the Begin Shift drop-down menu.

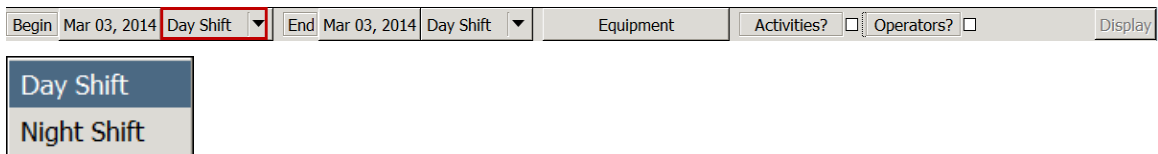

- d. Select the **End** date field, the date calendar appears.

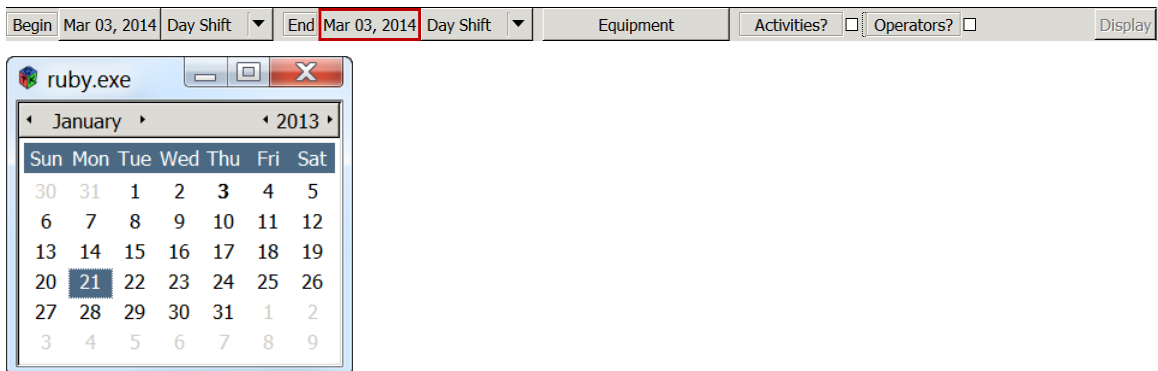

- e. Use the arrows on each side of the month and year to select the required month and year. Double-click on the day required. The End date is populated using the required date.

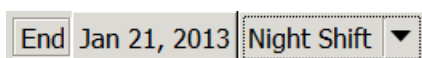

f. To select the ending shift, select the End Shift from the End Shift drop-down menu.

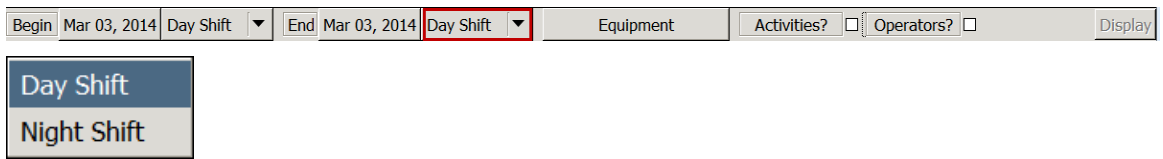

Note:

To view the activities or users' log ins, ensure the Activities and/or Operators check boxes are selected.

g. To select the equipment to view for the date range, select the Equipment button. The Equipment view appears.

Note:

Only equipment for which data exists in the specified time range is included in the equipment selection. Equipment with no data in the time range is not displayed.

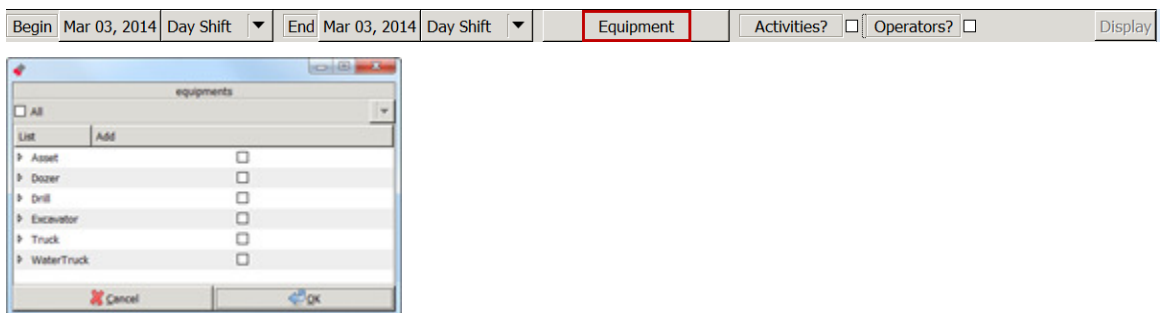

h. Select the appropriate check box:

- All check box – load all equipment data
- Equipment Type check box – load all equipment of that type's data
- Use the arrow to the left of the equipment type to open the dropdown menu of equipment to load data for individual equipment selected.

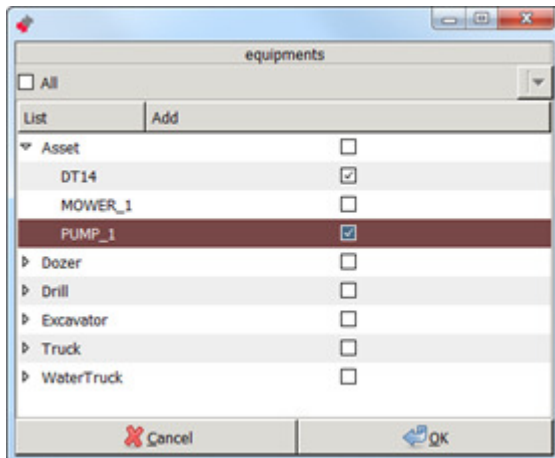

i. Select **OK**. The Display button on the Status and Activity Gantt view is enabled.

Note:

Viewing Activities and user log ins is optional. If neither Activities nor Operators check boxes are selected, only machine data activity and Status is displayed on the Gantt chart.

j. To view Activities or User data in the Gantt chart, select the Activities or Operators check box as required.



- k. Select **Display**. The data loads and a set of view manipulation buttons and time stamps appear across the top of the view.



Status and Activity Gantt View showing Equipment and Status

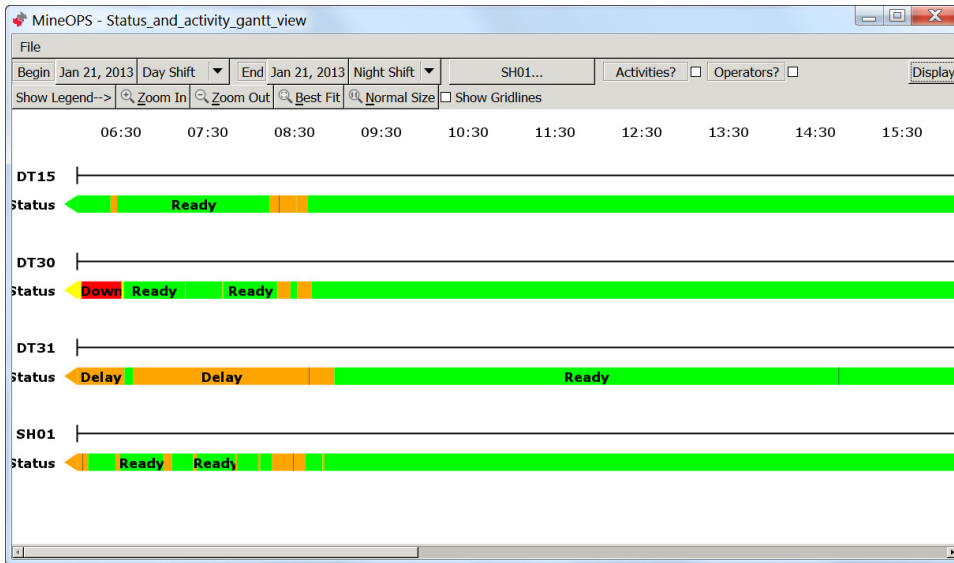

Status and Activity Gantt View showing Equipment, Status, Activities, and User data

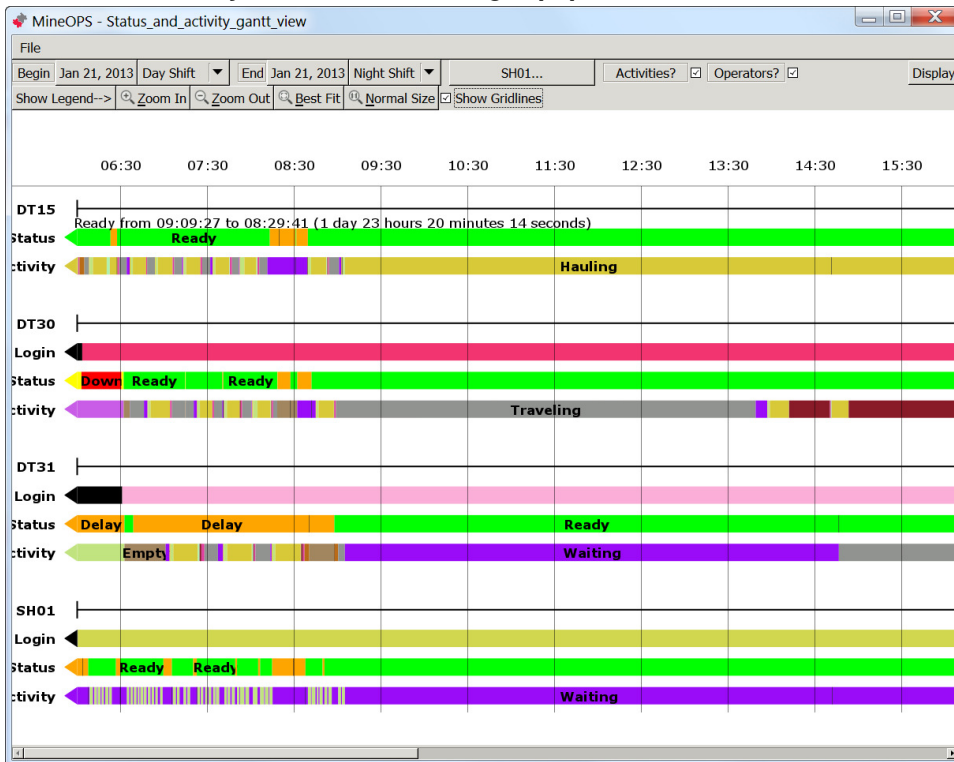

6.12.3 View Gantt Details

When the Gantt chart is populated with data, there may be sections of data in the chart that are short or difficult to read. At the top left side of the chart are a number of controls associated with viewing the chart.

- Zoom In – Zooms in by a factor of 50%. The time labels at the top of the screen scale down to fit the appropriate time range, to a minimum of 5 minutes.
- Zoom Out – Zooms out by a factor of 50%.
- Best Fit – Zooms in to view the selected area.
- Normal Size – Zooms all the way back out to the original zoom level when the chart loaded.

6.12.4 Vertical Time Gridlines

Vertical time gridlines are aligned with each time label to provide visual approximation of event timing. Time labels resolve to appropriate time spans (largest one hour, smallest 5 minutes) when zooming in and zooming out of the Gantt view.

1. To view vertical gridlines select the Show Gridlines check box at the top of the chart.

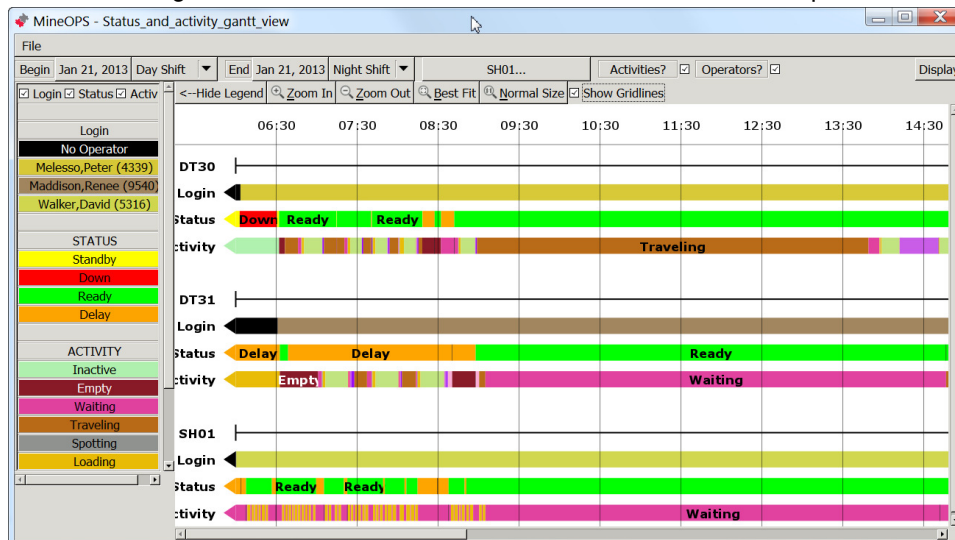

6.12.5 Gantt Legend

The legend panel is not visible when the data loads. The legend displays a list of statuses and activities in assigned colors. The colors in the legend correspond to the boxes in the chart itself and display the label for the item.

1. To view the legend, select Show Legend on the left hand side of the chart.
2. Logins are disabled in the legend by default. To view logins select the Login check box.
3. Hide any of the three legends (logins, statuses, and activities) from the legend panel by unchecking the corresponding check box.
4. To hide the legend, select Hide Legend.

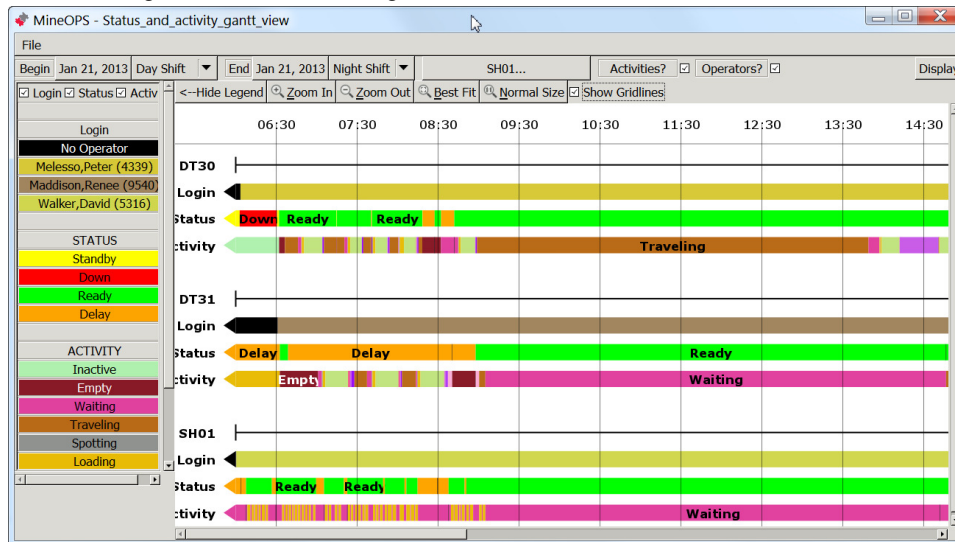

6.12.6 View, Edit, or Delete Data Detail on the Gantt View

Data appearing on the Gantt view can be viewed or modified.

Note:

While certain fields appear editable in the Status and Activity Gantt Data Detail view, it is not recommended to change the Expected Time, Latitude, Longitude, or Elevation of a data item. Please use standard Jmineops views for revising database information.

6.12.6.1 View Data Detail

1. Load data into the Gantt view. See [Load Data to Gantt View](#).
2. Data block details can be viewed by:
 - a. Left click on the block. The Data Detail view appears.

Caution:

Deleting an item cannot be undone.

- b. Right-click on the data block to open the edit menu. Three options appear:
 - View This Item – the Data Detail view appears.
 - Insert New Item – the Data Detail view appears.
 - Delete This Item – the Delete confirmation dialog box appears.

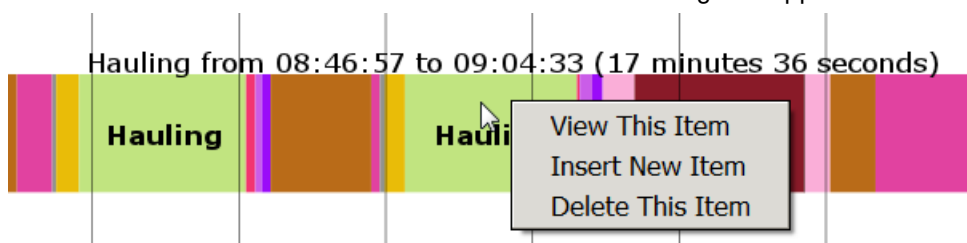

6.12.6.2 Data Detail View

Data detail views pull detail information from the database, therefore the contents of each detail view may vary. Each view has common fields which are the same for each type of data, and data-type specific fields. It is not recommended to assign an activity to a different piece of equipment, or change equipment in the Gantt chart data detail views.

To change the content of a field, right-click on the value to open the drop-down menu for that field.

Note:

Data appearing in this view is pulled from the database.

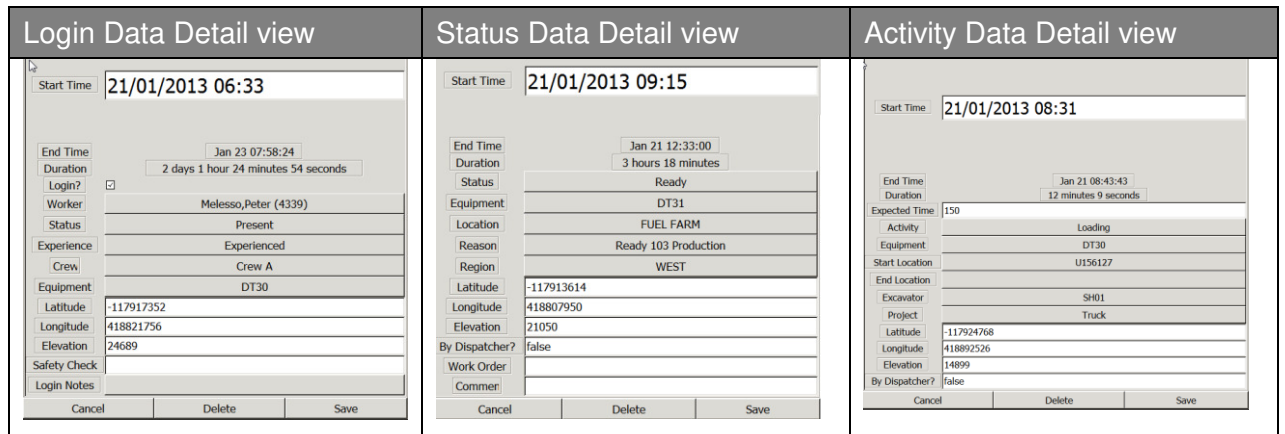

Common Data Detail View Fields

Field	Display	Description
Start Time	<input type="text" value="Start Time"/> 21/01/2013 08:12	Start time of the data block.
End Time	<input type="text" value="End Time"/> Jan 21 08:13:31	End time of the data block.
Duration	<input type="text" value="Duration"/> 1 minute 31 seconds	Duration of the data.
Equipment	<input type="text" value="Equipment"/> DT30	Applicable equipment.
Save button	<input type="button" value="Save"/>	Saves the data changes to the database. Data changes must be saved before doing other work or the changes are lost.
Delete button	<input type="button" value="Delete"/>	Deletes the data block from the database. Data block deletion is permanent.
Cancel button	<input type="button" value="Cancel"/>	Cancels the changes and closes the Data Detail view.
Latitude	<input type="text" value="Latitude"/> -117924768	Recorded equipment location longitude at the specified point in time.
Longitude	<input type="text" value="Longitude"/> 418892526	Recorded equipment location latitude at the specified point in time.
Elevation	<input type="text" value="Elevation"/> 14899	Recorded equipment location elevation at the specified point in time.

Login-Specific Data Detail Fields

Field	Display	Description
Login Check box	Login? <input checked="" type="checkbox"/>	Notes that there is a login for that time.
Worker	Worker Melesso, Peter (4339)	Worker logged into the system at that moment in time.
Status	Status Present	Worker status.
Experience	Experience Experienced	Worker experience.
Crew		Crew the worker belongs to.
Safety Check		
Login Notes		

Activity-Specific Data Detail Fields

Field	Display	Description
Expected Time	Expected Time 142	Leica Jmineops Optimizer expected time for the activity in seconds. Don't change the expected time.
Activity	Activity Moving with Water	Activity listed in the database. To change the activity, right-click on the activity to open the Activity menu.
Start Location	Start Location GO LINE	Equipment location at the start of the detail block. To change the Start location, left-click on the location to open the location menu.
End Location	End Location FUEL FARM	Equipment Location at the end of the detail block. To change the End location, left-click on the location to open the location menu.
Excavator	Excavator SH01	Excavator ID if the equipment is associated with an excavator. To change the excavator, left-click on the excavator to open the equipment menu.
Project	Project Truck	Project to which the equipment is associated. To change the project, left-click on the project to open the project menu.
By Dispatcher?	By Dispatcher? false	If the assignment was made by the Mine Controller.

Status-Specific Data Detail Fields

Field	Display	Description
Status	Status Ready	Status reports the applicable configured status for the data item.
Location	Location GO LINE	Equipment location at the start of the detail block. To change the Start location, left-click on the location to open the location menu.
Reason	Reason Ready 103 Production	Status reason at the start of the detail block. To change the reason, left-click on the reason to open the reason menu.
Region	Region WEST	Equipment location at the start of the detail block. To change the region location, left-click on the region to open the location menu.
By Dispatcher?	By Dispatcher? false	
Work Order	Work Order 4569	
Comment	Comment flat tire	

6.12.6.3 Edit Data Detail

1. Right-click on the data block, select View This Item. The item is highlighted and the Data Detail view appears.

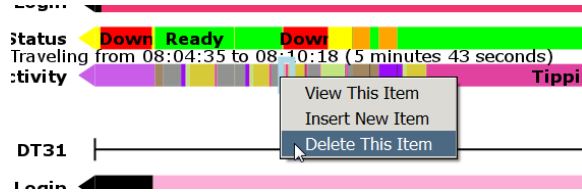

Note:

If Save is not selected before doing other work, all changes are lost.

2. To change the data detail, left-click on the information to open the related menu. Select the required information.

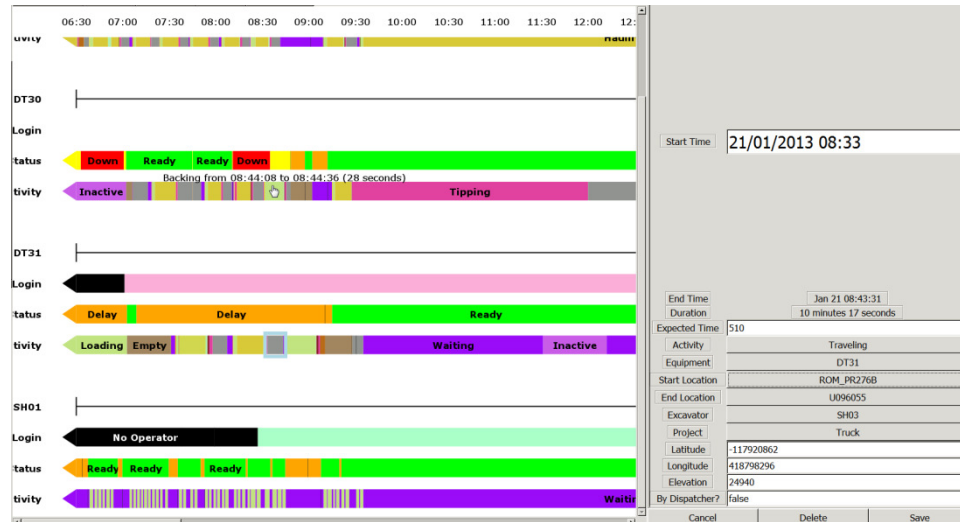

3. Select **Save**.

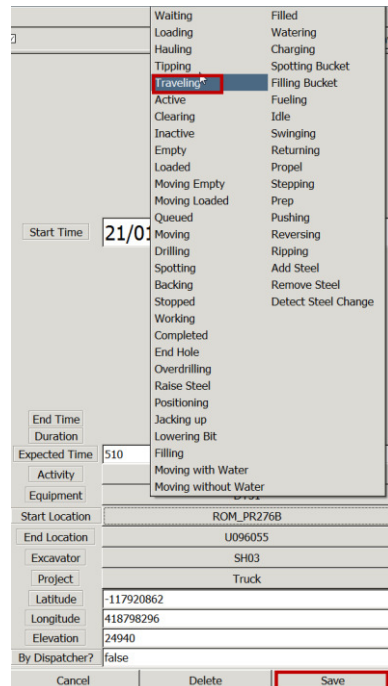

6.12.6.4 Insert Data

A data block extends from its own start time, to the start time of the next data item.

To insert a limited time item in the middle of another data item, insert the end time to split the current block and insert the start time of the new item to start the new item. To insert a new item from a certain time to the end time of a current item, only one start time must be added.

1. Select the place on the Gantt view to insert the new item. The data detail view appears. The data listed on the view is an exact copy of the item selected. The time is populated with the time indicated by the mouse cursor when the item was selected.
2. Right click on the data block, select Insert New Item. The item which is having an item inserted into it is highlighted and the Data Detail view appears with the exact information for the data block selected. The Start time is the time where the Gantt item was selected using the mouse.

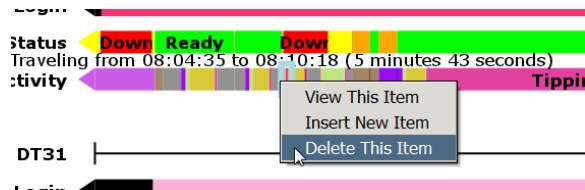

Note:

If Save is not selected before doing other work, all changes are lost.

3. Change the data detail as required, left-click on the information to open the related menu. Select the required information.

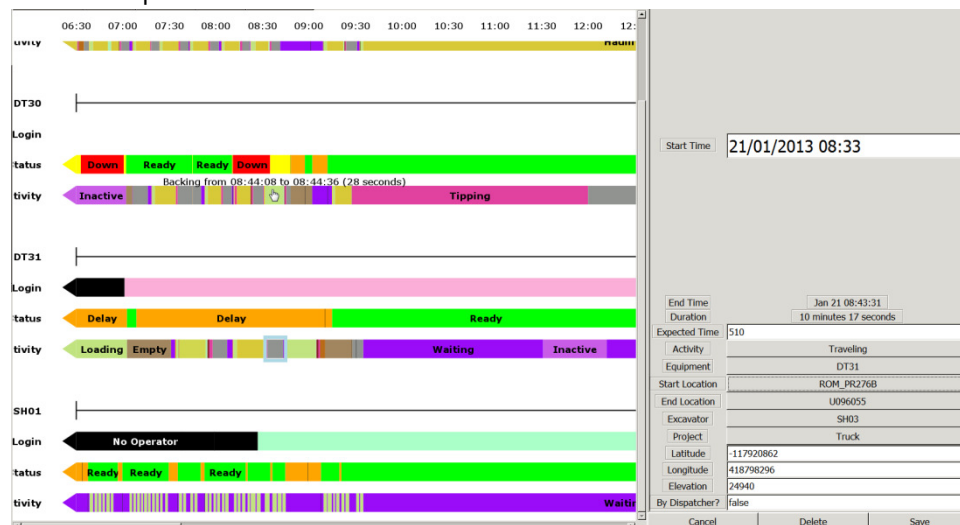

4. Select Save. The new item is inserted

6.12.6.5 Delete Data

Caution:

Data block deletion is permanent. To reinstate a deleted data block, the entry must be recreated using Insert New Item.

A data block extends from its own start time, to the start time of the next data item. Data blocks may be deleted by viewing the item and selecting Delete from the Data view, or from the Gantt chart view as follows:

1. Right click on the data block, select Delete This Item. The data item is highlighted and the Delete item confirmation dialog box appears.

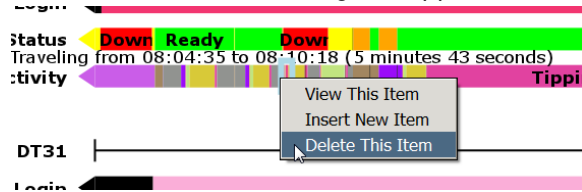

2. Select Yes. The item is deleted from the database. The earlier data block fills the space to the start of the next data block.

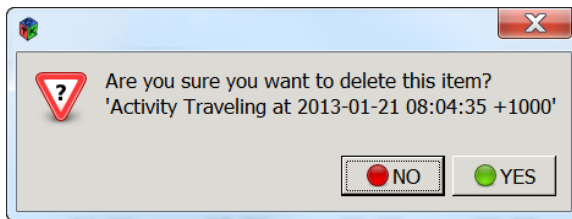

6.13 Asset Alarms

If an asset alarm is configured, asset alarms are reported in the same manner as other Jmineops equipment warnings and alarms.

- Alarms are activated by sensor activity on the asset.
- Sensors on the asset are activated when the sensor threshold levels change.
- Asset thresholds can be configured to the following levels:
 - Minor – A low level alarm.
 - Urgent – A high level alarm
 - Critical – A very high level alarm
- The Jasset alarm activates and sends a message to the user's email inbox.

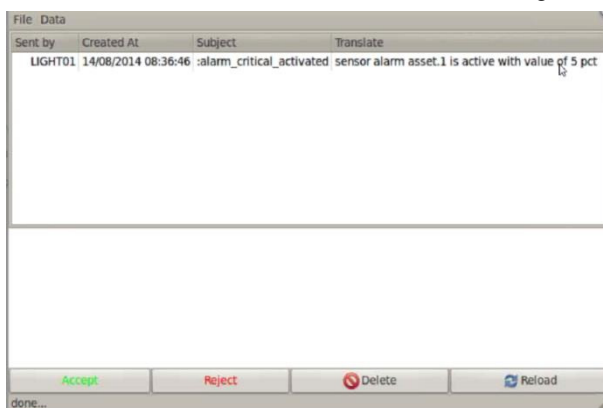

7 Leica Jview Jasset Reports

Leica Jview provides business intelligence reports on the assets in the Leica Jmineops system.

7.1 Jasset Inventory Report

The Jasset Inventory Report is a grid like report with a list of available assets and each asset's current status.

- The report is navigable by type of asset and by individual asset.
- The Last Updated (Since) field is shown in Red if when the report was executed, more than 30 minutes had passed since the asset's record was last updated.

Example Jasset Inventory Report



Asset Inventory

Date: 2015-01-13 Shift: Night Last Updated: 2015-01-13 14:09:59



Asset	Serial Number	Status	Reason	Name	Activity				Last Known Location				Last Updated		
					Since	Easting	Northing	Elevation	Location	Date	Time	Since			
AX020		Ready	Production	Active	2014-11-15 16:37:54	125,767.44	260,532.55	1,215.00	T&E_WORK_SH OP	2014-11-21	23:34:38	52 Days, 14:35:21			
LastComment															
GR030		Ready	Production	Active	2014-11-01 08:46:32	123,970.68	258,473.51	1,212.11	SK03	2014-11-21	23:30:05	52 Days, 14:39:54			
LastComment															
LD001		Standby	Not Required	Inactive	2014-11-14 19:43:48	123,925.58	258,015.94	1,152.00	SK1152	2014-11-21	23:30:05	52 Days, 14:39:54			
LastComment															
LPL003		Ready	Dewatering	Active	2014-11-20 04:53:38	0.00	0.00	0.00		2014-11-21	23:34:38	52 Days, 14:35:21			
LastComment															
LPL008		Ready	Production	Active	2014-11-20 10:47:48	0.00	0.00	0.00		2014-11-21	23:34:38	52 Days, 14:35:21			
LastComment															
LPL010		Ready	Production	Active	2014-11-12 20:39:50	0.00	0.00	0.00		2014-11-21	23:34:38	52 Days, 14:35:21			
LastComment															
LPL015		Ready	Production	Active	2014-11-19 17:00:40	0.00	0.00	0.00		2014-11-21	23:34:38	52 Days, 14:35:21			
LastComment															
LPL1070		Ready	Production	Active	2014-11-21 22:35:25	0.00	0.00	0.00		2014-11-21	23:34:38	52 Days, 14:35:21			
LastComment															
PMP0017		Ready	Dewatering	Active	2014-11-17 04:08:46	0.00	0.00	0.00		2014-11-21	23:34:38	52 Days, 14:35:21			

Page: 1 Of 3 - Asset Inventory



Date: 2015-01-13 14:09:59

Field	Description
Asset	The unique ID of the asset.
Serial Number	Optional serial number associated with the asset.
Status	The asset status: <ul style="list-style-type: none"> ▪ Down. ▪ Ready. ▪ Standby. ▪ Delay.
Reason	The function of the asset
Activity	The status of the asset and the time since the asset has been active. <ul style="list-style-type: none"> ▪ Name - Whether the status of the asset is active or inactive. ▪ Since - The time since the asset has been active.

Field	Description
Last Known Location	<p>The location the asset was last logged as active in mine site coordinates.</p> <ul style="list-style-type: none"> ▪ Easting - Easting Coordinate of asset in meters to five decimal places. ▪ Northing - Northing Coordinate of asset in meters to five decimal places. ▪ Elevation - Elevation of asset at time logged as active. ▪ Location - Location of active asset at logged coordinate.
Last Updated	<p>The date time and last logged active status of the asset:</p> <ul style="list-style-type: none"> ▪ Date - The date the asset was last updated. ▪ Time - The time the asset was last updated. ▪ Since - The last time the asset was logged with an active status. The entry color denotes the time since the last record update compared to when the report was run. <ul style="list-style-type: none"> ▪ Black – the asset record was updated within 30 minutes of when the report was run. ▪ Red- when the report was executed, more than 30 minutes had passed since the asset's record was updated.

7.2 Jasset Status Report

The Jasset Status report provides asset status information aggregated for Asset, Day, and Shift data fields. The report displays content in List, Bar Graph, and Pie Chart form.

Jasset Status Report Example



JAssetStatus

Start Date:	2014-11-01, Day	AssetType:	Generator, Lighting Plant, UnknownAssetType, Water Pump, WIFI Trailer	Asset:	AX011, AX020, AX021, CM002, LPL003, LPL005, LPL006, LPL007, LPL008, LPL010, LPL014, LPL015, LPL018, LPL019, LPL020, LPL1064, LPL1068, LPL1070, LPL1088, LPL1090, LPL1100, PMP0007, PMP0012, PMP0015, PMP0017, PMP0019, PMP0020, PMP0022, PMP0023, PMP0024, PMP0025, UnknownAsset
End Date:	2014-11-10, Night	AssetModel:	ALLIGHT, ALLMAND, Cat 330, CATCS683, HH220, UnknownAssetModel		

	Duration
Count: 13	3120:00:00
LPL1064 - Generator	240:00:00
LPL1090 - Generator	240:00:00
LPL1100 - Generator	240:00:00
PMP0007 - Lighting Plant	240:00:00
PMP0012 - Lighting Plant	240:00:00
PMP0015 - Lighting Plant	240:00:00
PMP0023 - Lighting Plant	240:00:00
PMP0024 - Lighting Plant	240:00:00
LPL005 - Water Pump	240:00:00
LPL007 - Water Pump	240:00:00
LPL018 - Water Pump	240:00:00
LPL019 - Water Pump	240:00:00
CM002 - WIFI Trailer	240:00:00

Field	Description
Asset	The ID of the asset
Day	The day the asset was logged
Status	The Down, Ready, Standby, Delay status
Reason	The function of the asset at the time of the report

7.2.1 Duration Bar Graph

The Duration Bar graph charts the percent status events per asset for the given time period. It is color coded with the default status display styles of the asset.

Duration Bar Graph

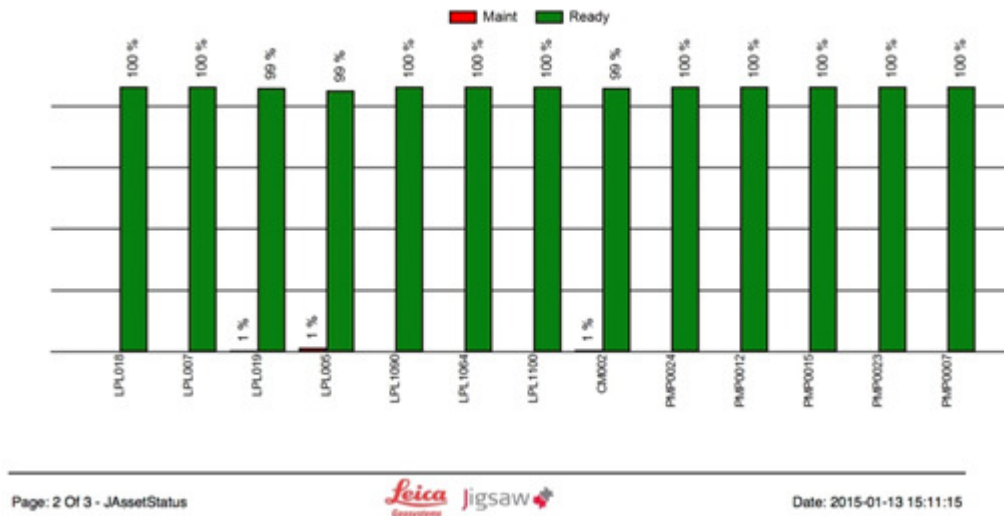

7.2.2 Pie Chart

The pie chart provides a chart of the reason codes and descriptions for all applicable assets selected for the report's parameters. The outline of each reason slice is color coded to the asset status color to which the reasons belong.

If certain reasons combine to less than 4% of all reasons, they are displayed as one slice called Other Reasons.

Note:

Default display styles configuration is part of the system's standard installation process. To change configuration, contact Leica Active Customer Care.

Pie Chart

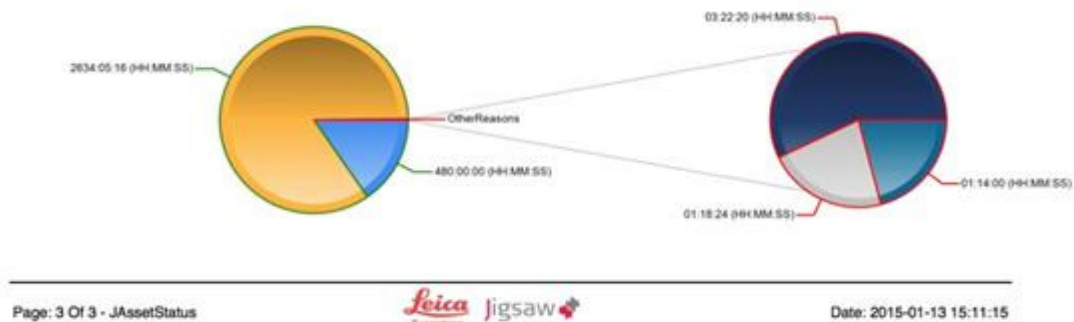

7.3 Jasset Dashboard

The Jasset dashboard provides general current event information about the asset. The Pie Chart: charts reason codes and descriptions for all assets for the current shift. The outline of each slice is color coded with the default status display color to which the reasons belong.

Note:

Default display styles configuration is part of the system's standard installation process. To change configuration, contact Leica Active Customer Care.

Jasset Dashboard

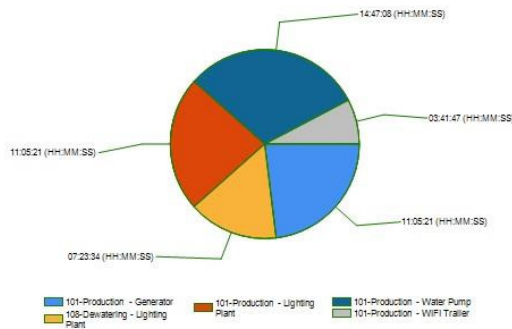

	Availability	Utilization
Generator	100 % ✓	100 % ✓
⊞ ALLMAND	100 % ✓	100 % ✓
Lighting Plant	100 % ✓	100 % ✓
⊞ HH220	100 % ✓	100 % ✓
UnknownAssetType	90 % ⚠	90 % ✓
⊞ ALLLIGHT	100 % ✓	100 % ✓
⊞ ALLMAND	100 % ✓	100 % ✓
⊞ Cat 330	100 % ✓	100 % ✓
AX020 (BC2735)	100 % ✓	100 % ✓
T&E_WORK_SHOP	125767.44	260532.55
⊞ HH220	75 % ✖	75 % ✓
Water Pump	100 % ✓	100 % ✓
⊞ ALLLIGHT	100 % ✓	100 % ✓
WIFI Trailer	100 % ✓	100 % ✓
⊞ CATCS683	100 % ✓	100 % ✓

Ready	Down	Delay	Standby
GR030 () 101 - Production : Active (12:55:07)	Lighting Plant PMP0007 (SYKES3301) 101 - Production : Active (17:11:32)	Water Pump LPL007 (AL4443324) 101 - Production : Active (06:48:41)	LD001 () 309 - Not Required : Inactive (01:57:51)
RD001 () 101 - Production : Traveling (04:00:12)	PMP0012 (SYKES3307) 101 - Production : Inactive (20:34:34)	LPL018 (AL4443331) 101 - Production : Active (05:53:48)	Generator
Generator LPL1090 (ALL5453338) 101 - Production : Inactive (00:36:58)	PMP0015 (SYKES3310) 101 - Production : Active (17:28:11)		LPL1064 (ALL5453333) 101 - Production : Active (06:42:26)
LPL1100 (ALL5453340) 101 - Production : Active (05:57:33)	UnknownAssetType		Water Pump
Lighting Plant PMP0023 (SYKES6056) 108 - Dewatering : Active (18:00:05)	PMP0022 (SYKES6055) 510 - UNM-Frame & Body/Bed System : Inactive (12:58:24)		LPL019 (AL4443332) 101 - Production : Active (01:36:31)
PMP0024 (SYKES6060) 101 - Production : Active (09:21:38)	Water Pump LPL005 (AL4443322) 101 - Production : Active (10:26:44)		
UnknownAssetType			
AX020 (BC2735) 101 - Production : Active (05:03:45)			
LPL003 (AL4443321) 108 - Dewatering : Active (16:46:01)			
LPL008 (AL4443325) 101 - Production : Active (10:53:51)			

Field	Description
Asset	The unique ID of the asset
Serial Number	Optional serial number associated with the asset
Status	The asset status: <ul style="list-style-type: none"> Down Ready Standby Delay
Reason	The function of the asset
Reason Code	The code associated with the function of the asset
Activity	The status of the asset and the time since it has been active
Activity Duration	The period the asset has been active
Last Known Location	The location the asset was last logged as active Coordinates and Name

8 Care and Transport

8.1 Transport

When transporting the product by rail, air, or sea, always use the complete original Leica Geosystems Mining packaging, cardboard box, or an equivalent, in order to protect the product against shock and vibration.

8.2 Storage

Ensure the temperature limits are followed when storing the equipment, particularly in summer if the equipment is inside a vehicle. Please reference the Technical Data section for information about temperature limits.

8.3 Cleaning and Drying

8.3.1.1 Product and Accessories

Use only clean, soft, lint-free cloth for cleaning. If necessary, moisten the cloth with water or pure alcohol. Do not use other liquids; these may attack the polymer components.

8.3.1.2 Connectors and Plugs

Keep plugs clean and dry. Blow away any dirt lodged in the plugs of the connecting cables.

9 Safety Directions

9.1 General Introduction

WARNING:

This is a Class A product. In a domestic environment this product may cause radio interference in which case the user may be required to take adequate measures.

- The following directions should enable the person responsible for the product, and the person who actually uses the equipment, to anticipate and avoid operational hazards.
- The person responsible for the product must ensure that all users understand these directions and adhere to them.

9.2 Intended Use

9.2.1 Permitted Uses

- Jasset is intended for Mining use only.
- Jasset is intended to be fitted to Mining assets only.
- Data communication with external appliances as part of a Leica Jigsaw Mining Solution.

9.2.2 Adverse Use

Adverse use can lead to injury, malfunction, and damage. It is the task of the person responsible for the equipment to inform the user about hazards and how to counteract them. The product is not to be operated until the user has been instructed on how to work with it.

WARNINGS:

Unauthorized modification of Mining machinery by mounting or installing the product may alter the function and safety of that mining machinery.

WARNING:

Follow the instructions of the machinery manufacturer. If no appropriate instruction is available, ask the machinery manufacturer for instructions prior to mounting or installing the product.

The following items result in adverse use.

- Use of the product without instruction.
- Use outside of the intended limits.
- Disabling safety systems.
- Removal of hazard notices.
- Opening the product using tools, for example a screwdriver, unless this is specifically permitted for certain functions.
- Modification or conversion of the product.
- Use after misappropriation.
- Use of products with obviously recognizable damages or defects.
- Use with accessories from other manufacturers without the prior explicit approval of Leica Geosystems Mining.
- Inadequate safeguards at the working site, for example when using on the intended site.

9.3 Limits of Use

9.3.1 Environment

Warning:

Not to be used on planes or any aircraft.

Warning:

Local safety authorities and safety experts must be contacted before working in hazardous areas, or in close proximity to electrical installations or similar situations by the person in charge of the product.

This product is suitable for use in an atmosphere appropriate for permanent human habitation.

9.4 Responsibilities

9.4.1 Manufacturer of the Product

Leica Geosystems Mining is responsible for supplying the product, including the User Manual and original accessories, in a completely safe condition.

9.4.2 Manufacturers of Non-Leica Geosystems Mining Accessories

The manufacturers of non-Leica Geosystems Mining accessories for the product are responsible for developing, implementing, and communicating safety concepts for their products, and are also responsible for the effectiveness of those safety concepts in combination with the Leica Geosystems Mining product.

9.4.3 Persons in Charge of the Product

WARNING:

The person responsible for the product must ensure that it is used in accordance with the instructions. This person is also accountable for the training and the deployment of personnel who use the product and for the safety of the equipment in use.

The person in charge of the product has the following duties:

- To understand the safety instructions on the product and the instruction in the User Manual.
- To be familiar with local regulations relating to safety and accident prevention.
- To ensure operators do not work within 30cm of the Cellular or Wi-Fi antennas.
- To inform Leica Geosystems Mining immediately if the product and the application becomes unsafe.

9.5 Hazards of Use

9.5.1 General Hazards

- The absence of instruction, or the inadequate imparting of instruction, can lead to incorrect or adverse use, and can give rise to accidents with far-reaching human, material, financial, and environmental consequences.
- All users must follow the safety directions given by the manufacturer and the directions of the person responsible for the product.
- Only Leica Geosystems Mining authorized service workshops are entitled to repair these products.
- Inadequate securing of the working site can lead to dangerous situations, for example in traffic, on building sites, and at industrial installations.
- Always ensure that the working site is adequately secured. Adhere to the regulations governing safety and accident prevention and road traffic.
- The user assures that the machine is operated, guided, and monitored by a qualified user (e.g., a licensed driver). The user has been able to take emergency measures, for example an emergency stop.
- While providing information to the user of the machine, accidents may occur due to
 - The user not paying attention to the surroundings (people, ditches, traffic, etc.).
 - Malfunctions (of a system component interface, etc.).

9.5.2 Mechanical Hazards

- Incorrect fastening of the equipment to vehicles or transporters poses the risk of the equipment being broken by mechanical influence, vibration, or airstream. This may result in accident and injury.
- Periodically carry out test measurements and perform the field adjustments, particularly after the product has been subjected to abnormal use and before and after important measurements.

- When setting up the product, ensure that the accessories are correctly adapted, fitted, secured, and locked in position. Avoid subjecting the product to mechanical stress.
- Attach the external antennae in accordance with installation instructions and applicable local legal electrical installation code.
- The external antennae must be secured additionally, for example by use of a safety cord. Ensure that the mounting device is correctly attached and able to carry the weight of the external antenna (> 1kg) safely.
- Deflect the mechanically moving machine components as far as possible and define a safe installation zone.
- If the accessories used with the product are not properly secured and the product is subjected to mechanical shock, for example, by blows or falling objects, the product may be damaged or people may sustain injury.

9.5.3 Lightning Hazards

WARNING:

If the product is used with accessories, for example, masts, staffs, or poles, you may increase the risk of being struck by lightning. Danger from high voltages also exists near power lines. Lightning, voltage peaks, or the touching of power lines can cause damage, injury, and death.

- Be sure to remain at a safe distance from electrical installations. Do not use the product directly under or in close proximity to power lines. If it is essential to work in such an environment contact the safety authorities responsible for electrical installations and follow their instructions.
- To prevent damages due to indirect lightning strikes (voltage spikes) cables, for example for antenna, power source or modem must be protected using appropriate protection elements, like a lightning arrester. These instructions must be carried out by an authorized specialist.
- If there is a risk of a thunderstorm, or if the equipment is to remain unused and unattended for a long period, protect your product additionally by unplugging all systems components and disconnecting all connecting cable and supply cables.
- If the product has to be permanently mounted in an exposed location, it is advisable to provide a lightning conductor for the product is given below. Always follow the regulations in force by your country regarding grounding antennas and mast. These installations must be carried out by an authorized specialist.

9.5.3.1 Lightning Conductors

Suggestions for design of a lightning conductor for a GNSS system follow:

9.5.3.1.1 On Non-Metallic Structures:

On Non-Metallic Structures, protection by air terminals is recommended.

1. An air terminal is a pointed solid or tubular rod of conducting material with mounting and connection to a conductor.
2. The position of four air terminals must be uniformly distributed around the antenna at a distance equal to the height of the air terminal. The air terminal diameter must be 12 mm for copper or 15 mm for aluminum. The height of the air terminals must be 25 cm to 50 cm.
3. All air terminals must be connected to the down conductors. The diameter of the air terminal must be kept to a minimum to reduce GNSS signal shading.

9.5.3.1.2 On Metallic Structures:

Protection is as described for non-metallic structures, but the air terminals can be connected directly to the conducting structure without the need for down conductors.

9.5.4 Disposal

If the product is improperly disposed of, the following can happen:

- If polymer parts are burnt, poisonous gases are produced, which may impair health.
- By disposing of the product irresponsibly, unauthorized persons may use it in contravention of the regulations, exposing themselves and third parties to the risk of severe injury and rendering the environment liable to contamination.

Caution:



The product must not be disposed of with household waste. Dispose of the product appropriately in accordance with the national regulations in force in your country.

Always prevent access to the product by unauthorized personnel. Product Specific treatment and waste management information can be downloaded from the Leica Geosystems Mining home page at <http://www.leica-geosystems.com/treatment> or obtained from your Leica Geosystems Mining dealer.

9.6 Electromagnetic Compatibility (EMC)

The term Electromagnetic Compatibility is taken to mean the capability of the product to function smoothly in an environment where electromagnetic radiation and electrostatic discharges are present, and without causing electromagnetic disturbances to other equipment.

- Electromagnetic radiation can cause disturbances in other equipment. Although the product meets the strict regulations and standards that are enforced in this respect, Leica Geosystems Mining cannot completely exclude the possibility that other equipment may be disturbed.
- There is risk that disturbances may be caused in other equipment if the product is used in conjunction with accessories from other manufacturers, for example field computers, personal computers, two-way radios, non-standard cables, or external batteries.
- Use only the equipment and accessories recommended by Leica Geosystems Mining. When combined with the product, they meet the strict requirements stipulated by the guidelines and standards. When using computers and two-way radios, pay attention to the information about electromagnetic compatibility provided by the manufacturer.
- Disturbances caused by electromagnetic radiation can result in erroneous measurements. Although the product meets the strict regulations and standards which are enforced in this respect, Leica Geosystems Mining cannot completely exclude the possibility that the product may be disturbed by very intense electromagnetic radiation produced by, for example, nearby transmitters, two-way radios, or diesel generators.
- Check the plausibility of results obtained under these conditions.
- If the product is operated with connecting cables attached at only one of their two ends, the permitted level of electromagnetic radiation may be exceeded and the correct functioning of other products may be impaired.
- While the product is in use, connecting cables must be connected at both ends.

10 Technical Data

10.1 Jasset W (Single Wi-Fi) Technical Data

10.1.1 Design

Industrial metal housing with a polymer top decal.

10.1.1.1 User Interface

- Three LEDs
- External display can be connected using ethernet

10.1.1.2 Dimensions

Length (cm)	Width (cm)	Height (cm)
15.1	16.6	4.8

10.1.1.3 Weight

Weight (kg)
1.0

10.1.1.4 Power

Consumption (W)	External Supply Voltage
7.2	Normal Voltage 24 VDC Voltage Range 9 to 32 VDC

10.1.2 Environmental Specifications

10.1.2.1 Temperature

Operating Temperature (°C)	Storage Temperature (°C)
-30 to +65	-40 to +85

10.1.2.2 Protection Against Water, Dust, and Sand

Protection
IP66, IP 67 with fitted AMP connector

10.1.2.3 Humidity

Protection
Up to 95% The effects of condensation are to be effectively counteracted by periodically drying out the Jasset module.

10.1.3 Interfaces

- RS232 Serial: 2x
- CAN: 2x
- Ethernet: 1x
- USB: 1x
- Digital Inputs: 2x
- Switched Output: 1x

10.1.4 Wireless Module Technical Data

10.1.4.1 Wi-Fi Module Technical Data

The Jasset Wi-Fi has the following Wi-Fi component.

- 2.4 GHz radio b/g/n compliant
- Avg. TX Power 23 dBm
- Receive Sensitivity -94 dBm @ 11 Mbps

10.1.5 Antenna Technical Data

10.1.5.1 Wi-Fi Antenna

- Frequency: 2400-2483.5 MHz
- Gain: 4.5 dBi

10.1.5.2 GNSS Antenna

- GPS/GLONASS
- Frequency: 1575.42-1606 MHz
- LNA Gain: 28 dB min.

10.1.6 FCC Statement (Applicable for U.S.)

This equipment has been tested and found to comply with the limits for a Class A digital device, pursuant to Part 15 of the FCC Rules. These limits are designed to provide reasonable protection against harmful interference when the equipment is operated in a commercial environment. This equipment generates, uses, and can radiate radio frequency energy and, if not installed and used in accordance with the instruction manual, may cause harmful interference to radio communications. Operation of this equipment in a residential area is likely to cause harmful interference, in which case the user will be required to correct the interference at their own expense.

This equipment generates, uses, and can radiate frequency energy and, if not installed and used in accordance with the instructions, may cause harmful interference to radio communication. However, there is no guarantee that interference will not occur in a particular installation. If this equipment does cause harmful interference to radio or television reception, which can be determined by turning the equipment off and on, the user is encouraged to try to correct the interference by one or more of the following measures:

- Reorient or relocate the receiving antenna (adhering to stated personal safety limits).
- Increase the separation between the equipment and the receiver.
- Connect the equipment into an outlet on a circuit different from that to which the receiver is connected.
- Consult the dealer or an experienced radio/TV technician for help.

Changes or modifications not expressly approved by Leica Geosystems for compliance could void the user's authority to operate the equipment.

10.2 Jasset WW (Dual Wi-Fi) Technical Data

10.2.1 Design

Industrial metal housing with a polymer top decal.

10.2.1.1 User Interface

- Three LEDs.
- External display can be connected using ethernet

10.2.1.2 Dimensions

Length (cm)	Width (cm)	Height (cm)
15.1	16.6	4.8

10.2.1.3 Weight

Weight (kg)
1.0

10.2.1.4 Power

Consumption (W)	External Supply Voltage
7.2	Normal Voltage 24 VDC Voltage Range 9 to 32 VDC

10.2.2 Environmental Specifications

10.2.2.1 Temperature

Operating Temperature (°C)	Storage Temperature (°C)
-30 to +65	-40 to +85

10.2.2.2 Protection Against Water, Dust, and Sand

Protection
IP66, IP 67 with fitted AMP connector

10.2.2.3 Humidity

Protection
Up to 95% The effects of condensation are to be effectively counteracted by periodically drying out the Jasset module.

10.2.3 Interfaces

- RS232 Serial: 2x
- CAN: 2x
- Ethernet: 1x
- USB: 1x
- Digital Inputs: 2x
- Switched Output: 1x

10.2.4 Wireless Module Technical Data

10.2.4.1 Wi-Fi Module Technical Data

The Jasset Wi-Fi has the following Wi-Fi component.

- 2.4 GHz radio b/g/n compliant
- Avg. TX Power 23 dBm
- Receive Sensitivity -94 dBm @ 11 Mbps

10.2.5 Antenna Technical Data

10.2.5.1 Wi-Fi Antenna

- Frequency: 2400-2483.5 MHz
- Gain: 4.5 dBi

10.2.5.2 GNSS Antenna

- GPS/GLONASS
- Frequency: 1575.42-1606 MHz
- LNA Gain: 28 dB min.

10.2.6 FCC Statement (Applicable for U.S.)

This equipment has been tested and found to comply with the limits for a Class A digital device, pursuant to Part 15 of the FCC Rules. These limits are designed to provide reasonable protection against harmful interference when the equipment is operated in a commercial environment. This equipment generates, uses, and can radiate radio frequency energy and, if not installed and used in accordance with the instruction manual, may cause harmful interference to radio communications. Operation of this equipment in a residential area is likely to cause harmful interference, in which case the user will be required to correct the interference at their own expense.

This equipment generates, uses, and can radiate frequency energy and, if not installed and used in accordance with the instructions, may cause harmful interference to radio communication. However, there is no guarantee that interference will not occur in a particular installation. If this equipment does cause harmful interference to radio or television reception, which can be determined by turning the equipment off and on, the user is encouraged to try to correct the interference by one or more of the following measures:

- Reorient or relocate the receiving antenna (adhering to stated personal safety limits).
- Increase the separation between the equipment and the receiver.
- Connect the equipment into an outlet on a circuit different from that to which the receiver is connected.
- Consult the dealer or an experienced radio/TV technician for help.

Changes or modifications not expressly approved by Leica Geosystems for compliance could void the user's authority to operate the equipment.

10.3 Jasset G (Cellular) Technical Data

10.3.1 Design

Industrial metal housing with a polymer top decal.

10.3.1.1 User Interface

- Three LEDs.
- External display can be connected using ethernet

10.3.1.2 Dimensions

Length (cm)	Width (cm)	Height (cm)
15.1	16.6	4.8

10.3.1.3 Weight

Weight (kg)
1.0

10.3.1.4 Power

Consumption (W)	External Supply Voltage
7.2	Normal Voltage 24 Vdc Voltage Range 9 to 32 Vdc

10.3.2 Environmental Specifications

10.3.2.1 Temperature

Operating Temperature (°C)	Storage Temperature (°C)
-30 to +65	-40 to +85

10.3.2.2 Protection Against Water, Dust, and Sand

Protection
IP66, IP 67 with fitted AMP connector

10.3.2.3 Humidity

Protection
Up to 95% The effects of condensation are to be effectively counteracted by periodically drying out the Jasset module.

10.3.3 Interfaces

- RS232 Serial: 2x
- CAN: 2x
- Ethernet: 1x
- USB: 1x
- Digital Inputs: 2x
- Switched Output: 1x

10.3.4 Wireless Module Technical Data

10.3.4.1 LTE/HSPA+/GPRS Wireless Module Technical Data

Type	Description
Technology	<ul style="list-style-type: none"> ▪ LTE Category 3 (100 Mbps downlink, 50 Mbps uplink) ▪ UMTS with DC-HSPA+ Category 24 (42 Mbps downlink, 5.76 Mbps uplink) ▪ EDGE/GPRS (up to 236 kbps)
Bands	<ul style="list-style-type: none"> ▪ 800/900/1800/2100/2600 MHz LTE ▪ 800/850/900/1900/2100 MHz HSPA+ (Power Class 3 (+24 dBm)) ▪ 850/900 MHz GSM/GPRS/EDGE (GSM Power Class 4/EDGE E2) ▪ 1800/1900 MHz GSM/GPRS/EDGE (GSM Power Class 1/EDGE E2) ▪ GPS/1575.42 MHz GLONASS/1602 MHz
Data Services	<ul style="list-style-type: none"> ▪ LTE Category 3 (100 Mbps downlink, 50 Mbps uplink) ▪ UMTS/HSPA+/DC-HSPA+ Category 24 (42 Mbps downlink, 5.76 Mbps uplink) ▪ GSM/GPRS/EDGE (Downlink up to 236 kbps)

10.3.5 Antenna Technical Data

10.3.5.1 Cellular Antenna Technical Data

- Frequency: 750-1250, 1650-2700 MHz
- Peak Gain:
 - 3 dBi @ 750-1250 MHz
 - 5 dBi @ 1650-2000 MHz
 - 3 dBi @ 2100-2700 MHz

10.3.5.2 GNSS Antenna

- GPS/Glonass
- Frequency: 1575.42-1606 MHz
- LNA Gain: 28 dB min.

10.3.6 Conformity to National Regulations for Jasset G Variant

Hereby, Leica Geosystems Mining declares that Jasset is in compliance with the essential requirements and other relevant provisions of Directive 1999/5/EC. The declaration of conformity may be consulted at <http://www.leica-geosystems.com/ce>.



Class 1 equipment according to European Directive 1999/5/EC (R&TTE) can be placed on the market and be put into service without restrictions in any EEA Member state.

10.3.7 FCC Statement (Applicable for U.S.)

This equipment has been tested and found to comply with the limits for a Class A digital device, pursuant to Part 15 of the FCC Rules. These limits are designed to provide reasonable protection against harmful interference when the equipment is operated in a commercial environment. This equipment generates, uses, and can radiate radio frequency energy and, if not installed and used in accordance with the instruction manual, may cause harmful interference to radio communications. Operation of this equipment in a residential area is likely to cause harmful interference, in which case the user will be required to correct the interference at their own expense.

This equipment generates, uses, and can radiate frequency energy and, if not installed and used in accordance with the instructions, may cause harmful interference to radio communication. However, there is no guarantee that interference will not occur in a particular installation. If this equipment does cause harmful interference to radio or television reception, which can be determined by turning the equipment off and on, the user is encouraged to try to correct the interference by one or more of the following measures:

- Reorient or relocate the receiving antenna (adhering to stated personal safety limits).
- Increase the separation between the equipment and the receiver.
- Connect the equipment into an outlet on a circuit different from that to which the receiver is connected.
- Consult the dealer or an experienced radio/TV technician for help.

Changes or modifications not expressly approved by Leica Geosystems for compliance could void the user's authority to operate the equipment.

10.4 Jasset WG (Single Wi-Fi and Cellular) Technical Data

10.4.1 Design

Industrial metal housing with a polymer top decal.

10.4.1.1 User Interface

- Three LEDs.
- External display can be connected via ethernet

10.4.1.2 Dimensions

Length (cm)	Width (cm)	Height (cm)
15.1	16.6	4.8

10.4.1.3 Weight

Weight (kg)
1.0

10.4.1.4 Power

Consumption (W)	External Supply Voltage
7.2	Normal Voltage 24 Vdc Voltage Range 9 to 32 Vdc

10.4.2 Environmental Specifications

10.4.2.1 Temperature

Operating Temperature (°C)	Storage Temperature (°C)
-30 to +65	-40 to +85

10.4.2.2 Protection Against Water, Dust, and Sand

Protection
IP66, IP 67 with fitted AMP connector

10.4.2.3 Humidity

Protection
Up to 95% The effects of condensation are to be effectively counteracted by periodically drying out the Jasset module.

10.4.3 Interfaces

- RS232 Serial: 2x
- CAN: 2x
- Ethernet: 1x
- USB: 1x
- Digital Inputs: 2x
- Switched Output: 1x

10.4.4 Wireless Module Technical Data

10.4.4.1 Wi-Fi Module Technical Data

The Jasset Wi-Fi has the following Wi-Fi components

- 2.4 GHz radio b/g/n compliant
- Avg. TX Power 23 dBm
- Receive Sensitivity -94 dBm @ 11 Mbps

10.4.4.2 LTE/HSPA+/GPRS Wireless Module Technical Data

Type	Description
Technology	<ul style="list-style-type: none"> ▪ LTE Category 3 (100 Mbps downlink, 50 Mbps uplink) ▪ UMTS with DC-HSPA+ Category 24 (42 Mbps downlink, 5.76 Mbps uplink) ▪ EDGE/GPRS (up to 236 kbps)
Bands	<ul style="list-style-type: none"> ▪ 800/900/1800/2100/2600 MHz LTE ▪ 800/850/900/1900/2100 MHz HSPA+ (Power Class 3 (+24 dBm)) ▪ 850/900 MHz GSM/GPRS/EDGE (GSM Power Class 4/EDGE E2) ▪ 1800/1900 MHz GSM/GPRS/EDGE (GSM Power Class 1/EDGE E2) ▪ GPS/1575.42 MHz GLONASS/1602 MHz
Data Services	<ul style="list-style-type: none"> ▪ LTE Category 3 (100 Mbps downlink, 50 Mbps uplink) ▪ UMTS/HSPA+/DC-HSPA+ Category 24 (42 Mbps downlink, 5.76 Mbps uplink) ▪ GSM/GPRS/EDGE (Downlink up to 236 kbps)

10.4.5 Antenna Technical Data

10.4.5.1 Wi-Fi Antenna

- Frequency: 2400-2483.5 MHz
- Gain: 4.5 dBi

10.4.5.2 Cellular Antenna Technical Data

- Frequency: 750-1250, 1650-2700 MHz
- Peak Gain:
 - 3 dBi @ 750-1250 MHz
 - 5 dBi @ 1650-2000 MHz
 - 3 dBi @ 2100-2700 MHz

10.4.5.3 GNSS Antenna

- GPS/Glonass
- Frequency: 1575.42-1606 MHz
- LNA Gain: 28 dB min.

10.4.6 Conformity to National Regulations for Jasset G Variant

Hereby, Leica Geosystems Mining declares that Jasset is in compliance with the essential requirements and other relevant provisions of Directive 1999/5/EC. The declaration of conformity may be consulted at <http://www.leica-geosystems.com/ce>.



Class 1 equipment according to European Directive 1999/5/EC (R&TTE) can be placed on the market and be put into service without restrictions in any EEA Member state.

10.4.7 FCC Statement (Applicable for U.S.)

This equipment has been tested and found to comply with the limits for a Class A digital device, pursuant to Part 15 of the FCC Rules. These limits are designed to provide reasonable protection against harmful interference when the equipment is operated in a commercial environment. This equipment generates, uses, and can radiate radio frequency energy and, if not installed and used in accordance with the instruction manual, may cause harmful interference to radio communications. Operation of this equipment in a residential area is likely to cause harmful interference, in which case the user will be required to correct the interference at their own expense.

This equipment generates, uses, and can radiate frequency energy and, if not installed and used in accordance with the instructions, may cause harmful interference to radio communication. However, there is no guarantee that interference will not occur in a particular installation. If this

equipment does cause harmful interference to radio or television reception, which can be determined by turning the equipment off and on, the user is encouraged to try to correct the interference by one or more of the following measures:

- Reorient or relocate the receiving antenna (adhering to stated personal safety limits).
- Increase the separation between the equipment and the receiver.
- Connect the equipment into an outlet on a circuit different from that to which the receiver is connected.
- Consult the dealer or an experienced radio/TV technician for help.

Changes or modifications not expressly approved by Leica Geosystems for compliance could void the user's authority to operate the equipment.

10.5 Jasset WWG (Dual Wi-Fi and Cellular) Technical Data

10.5.1 Design

Industrial metal housing with a polymer top decal.

10.5.1.1 User Interface

- Three LEDs.
- External display can be connected via ethernet

10.5.1.2 Dimensions

Length (cm)	Width (cm)	Height (cm)
15.1	16.6	4.8

10.5.1.3 Weight

Weight (kg)
1.0

10.5.1.4 Power

Consumption (W)	External Supply Voltage
7.2	Normal Voltage 24 Vdc Voltage Range 9 to 32 Vdc

10.5.2 Environmental Specifications

10.5.2.1 Temperature

Operating Temperature (°C)	Storage Temperature (°C)
-30 to +65	-40 to +85

10.5.2.2 Protection Against Water, Dust, and Sand

Protection
IP66, IP 67 with fitted AMP connector

10.5.2.3 Humidity

Protection
Up to 95% The effects of condensation are to be effectively counteracted by periodically drying out the Jasset module.

10.5.3 Interfaces

- RS232 Serial: 2x
- CAN: 2x
- Ethernet: 1x
- USB: 1x
- Digital Inputs: 2x
- Switched Output: 1x

10.5.4 Wireless Module Technical Data

10.5.4.1 Wi-Fi Module Technical Data

The Jasset Wi-Fi has the following Wi-Fi components:

- 2.4 GHz radio b/g/n compliant
- Avg. TX Power 23 dBm
- Receive Sensitivity -94 dBm @ 11 Mbps

10.5.4.2 LTE/HSPA+/GPRS Wireless Module Technical Data

Type	Description
Technology	<ul style="list-style-type: none">▪ LTE Category 3 (100 Mbps downlink, 50 Mbps uplink)▪ UMTS with DC-HSPA+ Category 24 (42 Mbps downlink, 5.76 Mbps uplink)▪ EDGE/GPRS (up to 236 kbps)
Bands	<ul style="list-style-type: none">▪ 800/900/1800/2100/2600 MHz LTE▪ 800/850/900/1900/2100 MHz HSPA+ (Power Class 3 (+24 dBm))▪ 850/900 MHz GSM/GPRS/EDGE (GSM Power Class 4/EDGE E2)▪ 1800/1900 MHz GSM/GPRS/EDGE (GSM Power Class 1/EDGE E2)▪ GPS/1575.42 MHz GLONASS/1602 MHz
Data Services	<ul style="list-style-type: none">▪ LTE Category 3 (100 Mbps downlink, 50 Mbps uplink)▪ UMTS/HSPA+/DC-HSPA+ Category 24 (42 Mbps downlink, 5.76 Mbps uplink)▪ GSM/GPRS/EDGE (Downlink up to 236 kbps)

10.5.5 Antenna Technical Data

10.5.5.1 Wi-Fi Antenna

- Frequency: 2400-2483.5 MHz
- Gain: 4.5 dBi

10.5.5.2 Cellular Antenna Technical Data

- Frequency: 750-1250, 1650-2700 MHz
- Peak Gain:
 - 3 dBi @ 750-1250 MHz
 - 5 dBi @ 1650-2000 MHz
 - 3 dBi @ 2100-2700 MHz

10.5.5.3 GNSS Antenna

- GPS/Glonass
- Frequency: 1575.42-1606 MHz
- LNA Gain: 28 dB min.

10.5.6 Conformity to National Regulations for Jasset G Variant

Hereby, Leica Geosystems Mining declares that Jasset is in compliance with the essential requirements and other relevant provisions of Directive 1999/5/EC. The declaration of conformity may be consulted at <http://www.leica-geosystems.com/ce>.



Class 1 equipment according to European Directive 1999/5/EC (R&TTE) can be placed on the market and be put into service without restrictions in any EEA Member state.

10.5.7 FCC Statement (Applicable for U.S.)

This equipment has been tested and found to comply with the limits for a Class A digital device, pursuant to Part 15 of the FCC Rules. These limits are designed to provide reasonable protection against harmful interference when the equipment is operated in a commercial environment. This equipment generates, uses, and can radiate radio frequency energy and, if not installed and used in accordance with the instruction manual, may cause harmful interference to radio communications. Operation of this equipment in a residential area is likely to cause harmful interference, in which case the user will be required to correct the interference at their own expense.

This equipment generates, uses, and can radiate frequency energy and, if not installed and used in accordance with the instructions, may cause harmful interference to radio communication. However, there is no guarantee that interference will not occur in a particular installation. If this equipment does cause harmful interference to radio or television reception, which can be determined by turning the equipment off and on, the user is encouraged to try to correct the interference by one or more of the following measures:

- Reorient or relocate the receiving antenna (adhering to stated personal safety limits).
- Increase the separation between the equipment and the receiver.
- Connect the equipment into an outlet on a circuit different from that to which the receiver is connected.
- Consult the dealer or an experienced radio/TV technician for help.

Changes or modifications not expressly approved by Leica Geosystems for compliance could void the user's authority to operate the equipment.

11 Appendix A – Universal Antenna Bracket

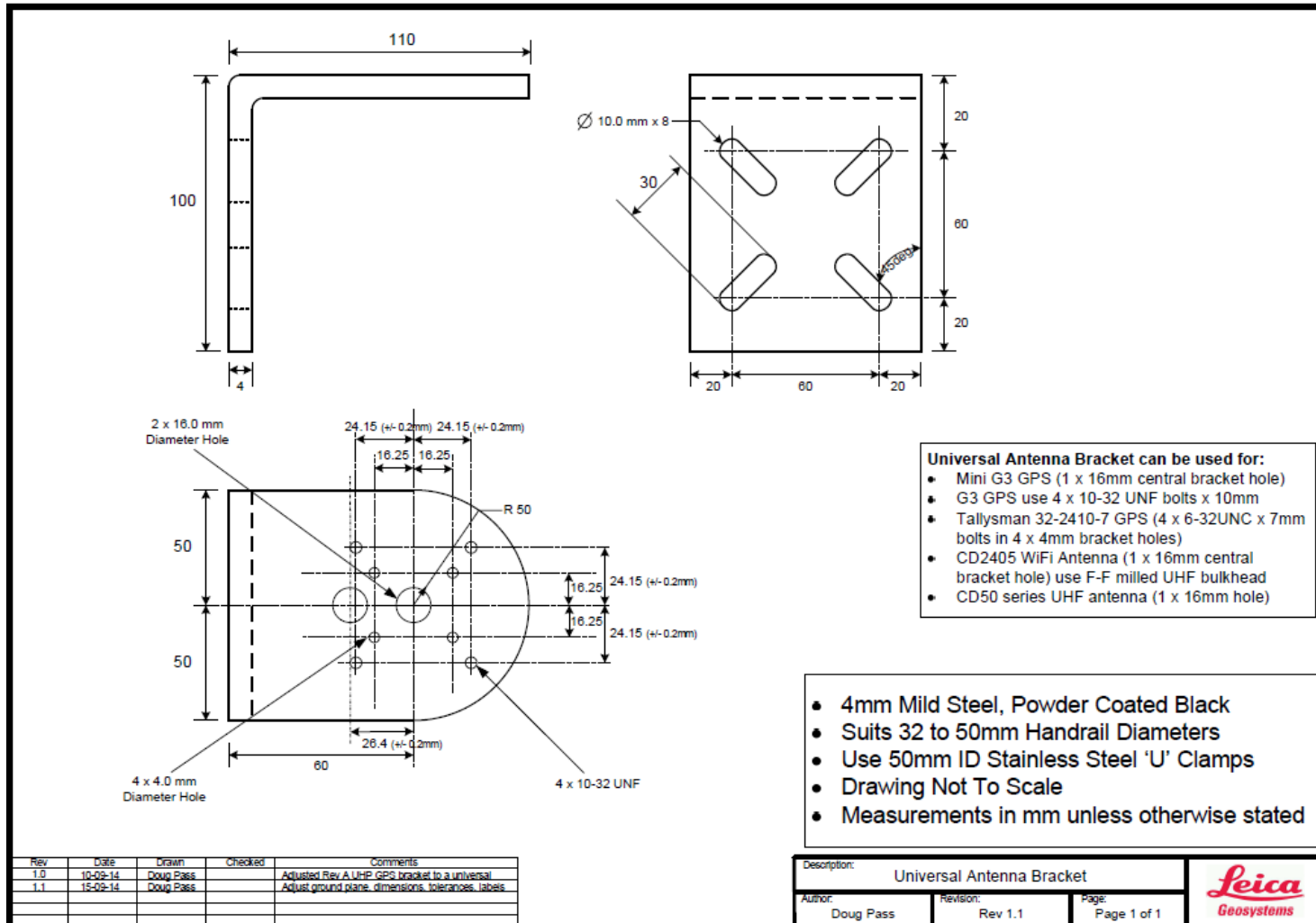

12 Appendix B – Back Up Power Supply

The requirement for the Battery Back-up is 48 hours min (up to 10 days in power saving mode).

Battery Requirements				Solar Panel Requirements		
Required Jasset battery on time = 48 Hrs				Australia Worse case hours sunshine / day (Melbourne) =	3	hrs
Recommended maximum battery discharge = 50% (Lead Acid)				Full Power Mode		
Recommended maximum battery discharge = 100% (Lithium Ion)				Daily consumed Amp hours = 24 hrs x 600 mA =	14.4	Ahrs
Full Power Mode				Hourly charge rate = Daily consumed Amp hours / No of charge hours =	4.8	A
Estimated/Measured nominal power = 600 mA @ 12 V, 300 mA at 24 V				Solar Panel Power rating = Minimum hourly charge rate x Battery Voltage =	57.6	W
Battery Requirement (Amp Hours) = $48 \times 0.6 / 0.5 =$	57.6	Ahrs	(Lead Acid)	Low Power Mode		
Low Power Mode				Daily consumed Amp hours = 24 hrs x 100 mA =	2.4	Ahrs
Estimated/Measured average power = 100 mA @ 12 V, 50 mA at 24 V				Hourly charge rate = Daily consumed Amp hours / No of charge hours =	0.8	A
Battery Requirement (Amp Hours) = $48 \times 0.1 / 0.5 =$	9.6	Ahrs	(Lead Acid)	Solar Panel Power rating = Minimum hourly charge rate x Battery Voltage =	9.6	W

12.1 Solar Panel Calculations - Using BP Solar Application

The BP Solar application incorporates local weather patterns in addition to the expected latitude and longitude to determine the hours of sun and day, and the sun's intensity during those hours. The application also calculates the efficiency of the solar panel dependent on the sun's intensity, and the tilt angle of the solar panel.

The calculations below demonstrate the differences for locations in Australia and North America using this application. LOLP stands for Loss Of Load Probability. For our application this should ideally be 0%, to ensure 24hour power 365 days a year. The calculations for determining the optimum Solar Panel size have therefore set the minimum power for obtaining this 0% LOLP.

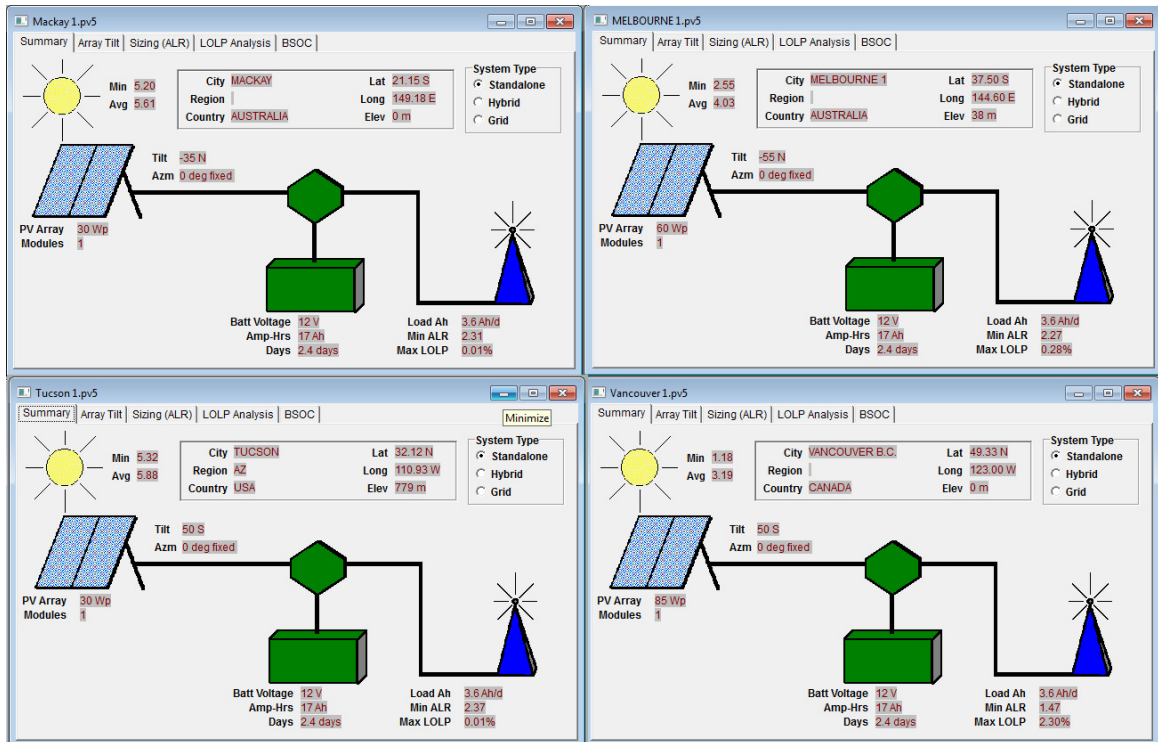

12.1.1 Battery Size

Full Power Mode Capacity:

Referring to calculations above, battery capacity has been determined to be 57.6 AHrs, @ 12 V.

Low Power Mode Capacity:

Referring to calculations above, battery capacity has been determined to be 9.6 AHrs, @ 12 V.

Physical size:

Approx. 0.1x0.1x0.15 m

Full Power Battery Size:

12 V, 57.6 AHrs equates to a battery size of approx. 240 mm x 180 mm x 185 mm, with a weight of approx. 20 kg

Low Power Battery Size:

12 V, 9.6 AHrs equates to a battery size of approx. 151 mm x 98 mm x 97.5 mm, with a weight of approx. 4 kg (The Yuasa NP12-12 used on the test systems)

Power-saving mode:

- Jasset is designed to run in low-power mode constantly for anything that uses solar panels (portable toilets, etc.). For other use cases where power is available for a portion of the time (lighting plants running on generators at night and off during the day), it needs to connect to a switch from the power source to know when it is on or off. It is run in full power mode when the power source is connected and run in low-power mode when it is disconnected.
- There are requirements for some functions, e.g. turning on/off lights, monitoring input and sensing movement that are not be available during power-saving (standby) mode. The only way to perform these functions is to operate Jasset in full-power mode in order to run the business logic.
- For monitoring inputs, this can be done in power-saving mode on a planned schedule. For example, it can run in standby mode for 50 minutes, and then turn on the CPU for full power mode to get position update, orientation, monitor inputs and switch outputs. Once these operations are complete, it goes back into standby mode for another 50 minutes.
- In Low power mode the functionality is not available or is only available during the Power-up time.

13 Appendix C - Jasset FCC Maximum Personal Exposure (MPE) Calculations

The following appendix is provided for reference.

Reference: FCC document 'Evaluating Compliance with FCC Guidelines for Human Exposure to Radiofrequency Electromagnetic Fields. From here in this document will be referred to as the FCC Guideline to MPE document.

13.1 Jasset Intentional Radiators

The Jasset WWG comprises the following RF interfaces

13.1.1 Wi-Fi

Radio : Zcomax ZCN-722M 802.11b/g/n USB module

Antenna: RFI CD2405 collinear, 4.5dBi, 2400GHz to 2500MHz.

Refer documents ZCN-722M Technical Specification and the CD2405 data sheet for further information.

13.1.2 4G

Radio: Sierra Wireless MC7354 PCI Express 4G module

Antenna: RM-WLF-DN-BLK; antenna gain 3dBi, 694MHz to 894MHz and 1.7GHz to 2.7GHz.

Refer documents AirPrime MC7354 Technical Specification and RM-WLF Antenna Specification for further information.

13.2 MPE Calculations

MPE Formula

The FCC Guide to MPE document section 3 'Methods of Predicting Human Exposure' page 17, advises to use the following formula

$$S = P \cdot G / 4 \cdot \pi \cdot R^2$$

$$\Rightarrow R = (P \cdot G / 4 \cdot \pi \cdot S)^{0.5}$$

Where

S = Power Density (MPE) mW/cm²

P = Power input to antenna (power output from radio) (mW)

G = Power gain of antenna relative to isotropic radiator (dBi)

R = Distance from antenna (cm)

13.2.1 WiFi MPE Calculations

Referring to The FCC Guide to MPE document, Appendix A, Table 1 (B) Limits for General Population/Uncontrolled exposure (1.5GHz to 100GHz).

$$S = 1.0 \text{ mW/cm}^2$$

$$P = 23\text{dB} = 200\text{mW (ref ZCN-722M data sheet)}$$

$$G = 4.5\text{dBi (ref RFI CD2405 data sheet)}$$

$$\Rightarrow R = (P \cdot G / 4 \cdot \pi \cdot S)^{0.5}$$

$$\Rightarrow R = (200 \times 4.5 / 4 \cdot \pi \cdot 1)^{0.5}$$

$$\Rightarrow R = 8.5 \text{ cm}$$

13.2.2 4G MPE Calculations

The MC7354 transmits at different power levels dependant on its transmit frequency. The calculations shown here are for the worst case scenario (Maximum required R)

Referring to The FCC Guide to MPE document, Appendix A, Table 1 (B) Limits for General Population/Uncontrolled exposure (300MHz to 1500MHz).

$$S = f/1500 = 850/1500 = 0.57 \text{ mW/cm}^2$$

$$P = 32\text{dBm} = 1585\text{mW} \text{ (ref MC7354 data sheet, Table 4-10 Conducted Tx power tolerances.)}$$

$$G = 3\text{dBi} \text{ (ref RM-WLF-DN-BLK data sheet)}$$

$$\Rightarrow R = (P \cdot G / 4 \cdot \pi \cdot S)^{0.5}$$

$$\Rightarrow R = (1585 \times 3 / 4 \cdot \pi \cdot 0.57)^{0.5}$$

$$\Rightarrow R = 25.76 \text{ cm}$$

14 Glossary

Term	Definition
CAN	Controller Area Network
GNSS	Global Navigation Satellite System
GPIO	General Purpose Input/Output
GPS	Global Positioning System
HSPA	High Speed Packet Access
IP	Internet Protocol

Life of Mine **Measurement**

Leica Geosystems' next-generation Leica Jigsaw monitoring and GPS guidance solution unearths site productivity with a revolutionary product range for draglines, blast-hole drills, electric shovels, dozers, excavators, haul trucks, loaders and auxiliary assets.

State-of-the-art real-time analysis and reporting software gives entire sites the tools that they need to stay on top by efficiently controlling resources and equipment. The result? Informed decision making, optimized productivity and unparalleled performance for maximum site output.

Backed up by a reliable global service and support network, Leica Geosystems Mining provides you with one seamlessly integrated and efficient Mine Management Solution.

When it has to be right.

United States, Canada & Mexico

Leica Geosystems Mining
Tucson, USA
Ph: +1 520 529 8729

Latin America

Leica Geosystems Mining
Santiago, Chile
Ph: +56 2 224 9512

Australia & South-East Asia

Leica Geosystems Mining
Brisbane, Australia
Ph: +61 7 3117 8900

Africa

Leica Geosystems Mining
Johannesburg, South Africa
Ph: +27 11 594 3900

China

Leica Geosystems Mining
Beijing, China
Ph: +86 10 8569 1819

India

Leica Geosystems Mining
Gurgaon, India
Ph: +91 124 412 2222

Indonesia

PT Leica Geosystems
Balikpapan, Indonesia
Ph: +62 811 544 1258

Email:

miningsales@leica-geosystems.com
www.leica-geosystems.com/mining

- when it has to be **right**

Leica
Geosystems