



LEICA D-LUX 2

## Operating Instructions

## Dear Customer,

We would like to take this opportunity to thank you for purchasing this LEICA D-LUX2. Please read these Operating Instructions carefully and keep them handy for future reference.

## Information for Your Safety

**WARNING**  
**TO REDUCE THE RISK OF FIRE OR SHOCK HAZARD AND ANNOYING INTERFERENCE, USE ONLY THE RECOMMENDED ACCESSORIES AND DO NOT EXPOSE THIS EQUIPMENT TO RAIN OR MOISTURE. DO NOT REMOVE THE COVER (OR BACK); THERE ARE NO USER SERVICEABLE PARTS INSIDE. REFER SERVICING TO QUALIFIED SERVICE PERSONNEL.**

**Carefully observe copyright laws. Recording of pre-recorded tapes or discs or other published or broadcast material for purposes other than your own private use may infringe copyright laws. Even for the purpose of private use, recording of certain material may be restricted.**

- Please note that the actual controls and components, menu items, etc. of your Digital Camera may look somewhat different from those shown in the illustrations in these Operating Instructions.
- SD Logo is a trademark.
- Other names, company names, and product names printed in these instructions are trademarks or registered trademarks of the companies concerned.

**THE SOCKET OUTLET SHALL BE INSTALLED NEAR THE EQUIPMENT AND SHALL BE EASILY ACCESSIBLE.**

### **CAUTION**

Danger of explosion if battery is incorrectly replaced. Replace only with the same or equivalent type recommended by the manufacturer. Dispose of used batteries according to the manufacturer's instructions.

A lithium ion/polymer battery that is recyclable powers the product you have purchased. Please call the Leica agency/distributor in your country for information on how to recycle this battery.



QuickTime and the QuickTime logo are trademarks or registered trademarks of Apple Computer, Inc., used under license.

**FCC Note: (U.S. only)**

This equipment has been tested and found to comply with the limits for a Class B digital device, pursuant to Part 15 of the FCC Rules. These limits are designed to provide reasonable protection against harmful interference in a residential installation. This equipment generates, uses, and can radiate radio frequency energy and, if not installed and used in accordance with the instructions, may cause harmful interference to radio communications. However, there is no guarantee that interference will not occur in a particular installation. If this equipment does cause harmful interference to radio or television reception, which can be determined by turning the equipment off and on, the user is encouraged to try to correct the interference by one or more of the following measures:

- Reorient or relocate the receiving antenna.
- Increase the separation between the equipment and receiver.
- Connect the equipment into an outlet on a circuit different from that to which the receiver is connected.
- Consult the dealer or an experienced radio/TV technician for help.

**FCC Caution:** To assure continued compliance, follow the attached installation instructions and use only shielded interface cables with ferrite core when connecting to computer or peripheral devices.

Any changes or modifications not expressly approved by the party responsible for compliance could void the user's authority to operate this equipment.

Trade Name: LEICA  
Model No.: D-LUX2

Responsible party / Support Contact:  
Leica Camera Inc.  
1 Pearl Court, Unit A  
Allendale, New Jersey 07401  
Tel.: +1 201 995 0051 232  
Fax: +1 201 995 1684  
e-mail: repair@leicacamerausa.com

This device complies with Part 15 of the FCC Rules. Operation is subject to the following two conditions: (1) This device may not cause harmful interference, and (2) this device must accept any interference received, including interference that may cause undesired operation.

This Class B digital apparatus complies with Canadian ICES-003



LEICA  
D-LUX2

## Only for Great Britain Digital Camera



The rating plate is on the underside of the Digital Camera.

## Caution for AC mains lead

For your safety, please read the following text carefully.

This appliance is supplied with a moulded three-pin mains plug for your safety and convenience. A 5-ampere fuse is fitted in this plug.

Should the fuse need to be replaced, please ensure that the replacement fuse has a rating of 5-amperes and it is approved by ASTA or BSI to BS1362.

Check for the ASTA mark  or the BSI mark  on the body of the fuse.

If the plug contains a removable fuse cover you must ensure that it is refitted when the fuse is replaced. If you lose the fuse cover, the plug must not be used until a replacement cover is obtained. A replacement fuse cover can be purchased from your local Leica Dealer.

**IF THE FITTED MOULDED PLUG IS UNSUITABLE FOR THE SOCKET OUTLET IN YOUR HOME THEN THE FUSE SHOULD BE REMOVED AND THE PLUG CUT OFF AND DISPOSED OF SAFELY.**

**THERE IS A DANGER OF SEVERE ELECTRICAL SHOCK IF THE CUT OFF PLUG IS INSERTED INTO ANY 13- AMPERE SOCKET.**

If a new plug is to be fitted, please observe the wiring code as shown below. If in any doubt, please consult a qualified electrician.

## ■ IMPORTANT

The wires in this mains lead are coloured in accordance with the following code:

Blue: Neutral  
Brown: Live

As the colours of the wires in the mains lead of this appliance may not correspond with the coloured markings identifying the terminals in your plug, proceed as follows:

The wire which is coloured **BLUE** must be connected to the terminal in the plug which is marked with the letter **N** or coloured **BLACK**.

The wire which is coloured **BROWN** must be connected to the terminal in the plug which is marked with the letter **L** or coloured **RED**.

Under no circumstances should either of these wires be connected to the earth terminal of the three-pin plug, marked with the letter **E** or the Earth Symbol. ⚡

## ■ Before Use

Remove the Connector Cover.

## ■ How to replace the Fuse

The location of the fuse differ according to the type of AC mains plug (figures A and B). Confirm the AC mains plug fitted and follow the instructions below. Illustrations may differ from actual AC mains plug.

- 1) Open the fuse cover with a screwdriver.

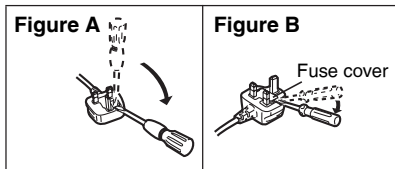

- 2) Replace the fuse and close or attach the fuse cover.

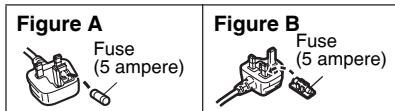

### ■ Care for the camera

- **Do not shake or cause impact to the camera.** The camera may not be operated normally or recording of pictures may be disabled, or the lens may be damaged.
- **Sand or dust may cause a malfunction of the camera. When you use the camera on a beach etc., take care so that sand or dust does not get into the camera.**
- When you use the camera on a rainy day or on a beach, take care so that water does not get into the camera.
- **If seawater splashes onto the camera, wet a soft cloth with tap water, wring it well, and use it to wipe the camera body carefully. Then, wipe it again with a dry cloth.**

### ■ About the LCD monitor

- **Do not press the LCD monitor strongly. It may cause uneven colours on the LCD monitor or a malfunction of the LCD monitor.**
- In a place with drastic temperature changes, condensation may form on the LCD monitor. Wipe it with a soft, dry cloth.
- If the camera is extremely cold when you turn the camera on, the image on the LCD monitor is slightly darker than usual at first. However, as the internal temperature increases, it goes back to the normal brightness.

Extremely high precision technology is employed to produce the LCD monitor screen. The result is more than 99.99% effective pixels with a mere 0.01% of the pixels inactive or always lit. However, this will not be recorded on the pictures in the card.

### ■ About the Lens

- Do not direct the lens to the sun or strong light sources. It may cause not only a malfunction of the camera but irreversible damage to your eye.
- Do not press the lens strongly.
- Leaving the camera with the lens facing the sun may cause a malfunction. Be careful when you put the camera outside or near a window.

### ■ About Condensation (When the lens is fogged up)

Condensation takes place when the ambient temperature or humidity is changed as follows:

Be careful of condensation since it causes stains on the lens, fungus or malfunction.

- When the camera is brought inside from the cold to a warm room.
- When the camera is moved from outside to an air-conditioned car.
- When cool wind from an air conditioner or other is directly blown onto the camera.
- In humid places

Put the camera into plastic bag until the temperature of the camera is close to the ambient temperature to avoid condensation. In case of condensation, turn the camera off and then leave it for about 2 hours.

When the camera becomes close to the ambient temperature, the fog disappears naturally.

■ **If you will not be using the camera for a long time**

- Store the battery in a cool and dry place with a relatively stable temperature. [Recommended temperature: 15°C to 25°C, Recommended humidity: 40% to 60%]
- Be sure to remove the battery and the card from the camera.
- When the battery is left inserted in the camera for a long time, discharge takes place even if the camera is turned off. If you leave the battery inserted for an extended period of time, it will be excessively discharged and it may become unusable even after it is charged.
- To store the battery for a long period of time, we recommend charging it once every year and storing it again after you completely use up the charged capacity.
- When you keep the camera in a closet or a cabinet, we recommend storing it with the desiccant (silica gel).

-If you see this symbol-

**Information on Disposal for Users of Waste Electrical & Electronic Equipment (private households)**



This symbol on the products and/or accompanying documents means that used electrical and electronic products should not be mixed with general household waste.

For proper treatment,

recovery and recycling, please take these products to designated collection points, where they will be accepted on a free of charge basis. Alternatively, in some countries you may be able to return your products to your local retailer upon the purchase of an equivalent new product.

Disposing of this product correctly will help to save valuable resources and prevent any potential negative effects on human health and the environment which could otherwise arise from inappropriate waste handling. Please contact your local authority for further details of your nearest designated collection point.

Penalties may be applicable for incorrect disposal of this waste, in accordance with national legislation.

**For business users in the European Union**

If you wish to discard electrical and electronic equipment, please contact your dealer or supplier for further information.

**Information on Disposal in other Countries outside the European Union**

This symbol is only valid in the European Union.

If you wish to discard this product, please contact your local authorities or dealer and ask for the correct method of disposal.

# About These Operating Instructions

Please note that the description on this page is a sample and all pages are not described in this manner.



Modes indicated here allow you to use the functions or settings described on this page. Set the Mode dial to any of the modes to use the functions or settings.

## Using the Optical Zoom



You can make people and subjects appear closer with the 4 times optical zoom, and landscapes can be recorded in wide angle.



- The picture may have some distortion (typical example: vertical straight line bent outwards).

Convenient or helpful information for use of this camera is described.

### ■ About illustrations in these operating instructions

Please note that the appearance of the product, the illustration or the menu screen are a little different from those in actual use.

### ■ About illustrations of the cursor button and the joystick

In those operating instructions, the operations on the cursor button are described as illustrated below.

For example: Pressing the ▼ cursor button

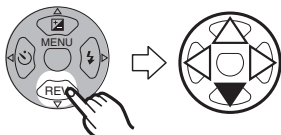

For example: Moving the joystick to the right



For example: Pressing the joystick



# Contents

---

---

## Before Use

---

---

Information for Your Safety .....	2
About These Operating Instructions .....	7

---

---

## Preparation

---

---

Scope of delivery .....	9
Names of the Components .....	10
Quick Guide .....	12
Charging the Battery with the Charger ..	13
About the Battery .....	14
Inserting/Removing the Battery .....	15
Inserting/Removing the Card .....	16
About the Card .....	17
Approximate number of recordable pictures and the size .....	18
Attaching the Lens Cap/Strap .....	21
Setting Date/Time (Clock Set) .....	22
Setup Menu .....	23
About the LCD Monitor .....	27

---

---

## Recording pictures (basic)

---

---

Taking Pictures .....	30
Taking Pictures in Auto Mode .....	35
Checking the Recorded Picture (Review) .....	37
Using the Optical Zoom .....	38
Taking Pictures using the Built-in Flash .....	40
Taking Pictures with the Self-timer .....	44
Compensating the Exposure .....	45
Taking Pictures using Auto Bracket .....	46
Optical Image Stabilizer [STABILIZER] .....	47
Taking Pictures using Burst Mode .....	48

---

---

## Playback (basic)

---

---

Playing Back Pictures .....	49
9/16/25 Pictures Multi Playback .....	50
Using the Playback Zoom .....	51
Deleting Pictures .....	52

---

---

## Recording pictures (advanced)

---

---

Using the Mode Dial .....	54
• Aperture-priority AE .....	54
• Shutter-priority AE .....	55
• Manual exposure .....	56
• Motion picture mode .....	59
• Scene mode .....	61
– Portrait mode .....	62
– Sports mode .....	62
– Food mode .....	63
– Scenery mode .....	63
– Night portrait mode .....	64
– Night scenery mode .....	64
– Baby mode .....	65
– Soft skin mode .....	66
– Candle light mode .....	66
– Party mode .....	67
– Fireworks mode .....	67
– Snow mode .....	68
– Starry sky mode .....	68
– Self portrait mode .....	69
Using the [REC] mode menu .....	70
• White Balance [W.BALANCE] .....	71
• ISO Sensitivity [SENSITIVITY] .....	73
• Picture Size [PICT.SIZE] .....	73
• Quality [QUALITY] .....	74
• Audio Recording [AUDIO REC.] .....	75
• Metering Mode [METERING MODE] .....	75
• AF Mode [AF MODE] .....	76
• Continuous AF [CONT.AF] .....	77
• AF Assist Lamp [AF ASSIST LAMP] .....	77
• Digital Zoom [D.ZOOM] .....	78
• Colour Effect [COL.EFFECT] .....	78
• Picture Adjustment [PICT.ADJ.] .....	79
• Flip Animation [FLIP ANIM.] .....	79
Using the Quick setting .....	82
Taking Pictures with Manual Focus .....	83
AF/AE Lock (AF: Auto focus/AE: Auto exposure) .....	85
AF Macro mode .....	86
Setting the aspect ratio .....	87



---



---

## Playback (advanced)

---



---

Playing Back Pictures with Audio/Motion pictures . . . . .	89
Using the [PLAY] mode menu . . . . .	90
• Playing Back with Slide Show [SLIDE SHOW] . . . . .	91
• Favorites setting [FAVORITE] . . . . .	92
• Displaying pictures in a direction at the time of recording [ROTATE DISP.] . . . . .	93
• Rotating the Picture [ROTATE] . . . . .	94
• Setting the Picture to be Printed and the Number of Prints [DPOF PRINT] . . . . .	95
• Preventing Accidental Erasure of the Picture [PROTECT] . . . . .	97
• Adding Audio to Recorded Pictures [AUDIO DUB.] . . . . .	98
• Resizing the Pictures [RESIZE] . . . . .	99
• Trimming the Pictures [TRIMMING] . . . . .	100
• Changing the Aspect Ratio [ASPECT CONV.] . . . . .	102
• Clean up the Card [CLEAN UP] . . . . .	103
• Initializing the Card [FORMAT] . . . . .	103
Playing Back Pictures with a TV Screen . . . . .	104

---



---

## Connecting to a PC or Printer

---



---

Before Connecting with USB Connection Cable [USB] : USB MODE] . . . . .	105
Connecting to a PC . . . . .	106
Connecting to a PictBridge-compliant Printer . . . . .	108

---



---

## Others

---



---

Screen Display . . . . .	112
Cautions for Use . . . . .	114
Message Display . . . . .	116
Troubleshooting . . . . .	118
Specifications . . . . .	124

# Scope of delivery

Before using your camera, check the contents of the package.

## ■ Standard Accessories

### • SD Memory Card (64 MB)

423-056.020-045

(In the text, it is indicated as “Card”)

### • Battery Pack

BP-DC4-U/J/E

18645/18646/18644

(In the text, it is indicated as “Battery”)

### • Battery Charger

BC-DC4-U/J/E

423-068.801-007/-008/-006

(In the text, it is indicated as “Charger”)

### • AC Mains Lead

423-068.801-019/EU

423-068.801-020/GB

423-068.801-021/USA

423-068.801-022/Jap

423-068.801-023/AUS

### • AV Cable

423-068.801-016

### • USB Connection Cable

423-068.801-017

### • CD-ROM

423-068.801-014

### • Strap

423-068.801-015

### • Battery Carrying Case

423-068.801-012

### • Lens Cap

423-068.801-013

### • Lens Cap String

423-068.801-018

# Names of the Components

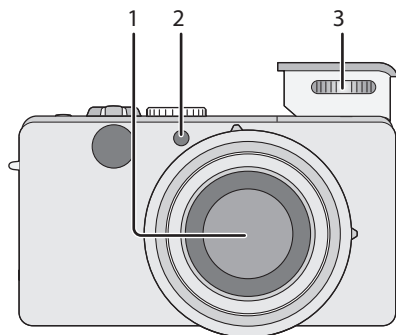

- 1 Lens part
- 2 Self-timer Indicator (P44)  
AF Assist Lamp (P77)
- 3 Flash (P32, 40)

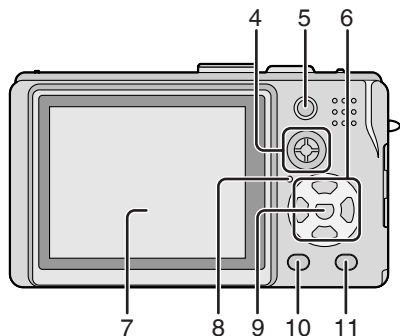

- 4 Joystick (P34, 49, 83)
- 5 AF/AE Lock Button (P85)
- 6 Cursor buttons
  - ◀/Self-timer Button (P44)
  - ▼/[REV] Button (P37)
  - ▶/Flash Mode Button (P40)
  - ▲/Backlight Compensation in Auto Mode (P36)/Exposure Compensation (P45)/Auto Bracket (P46)/White Balance Fine Adjustment (P72) Button
- 7 LCD Monitor (P27, 112)
- 8 Status Indicator
- 9 [MENU] Button (P23, 61, 90)
- 10 [DISPLAY/PWR LCD] Button (P27)
- 11 Single/Burst Mode (P48)/Delete Button (P37, 52, 92)

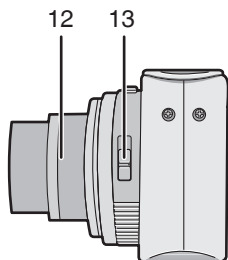

- 12 Lens barrel
- 13 Focus switch (P31, 83, 86)

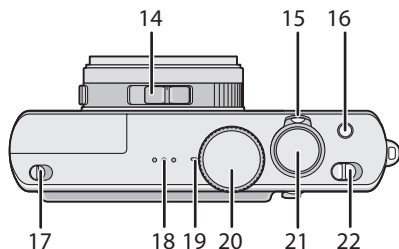

- 14 Aspect ratio switch (P87)
- 15 Zoom Lever (P37, 38, 50, 51)
- 16 Optical Image Stabilizer Button (P47)
- 17 Flash Open Switch (P40)
- 18 Speaker (P89)
- 19 Microphone (P59, 75)
- 20 Mode Dial (P30)
- 21 Shutter Button (P31)
- 22 Camera Switch (P23)

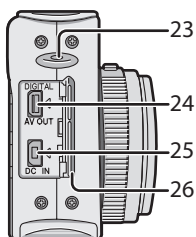

- 23 Lens Cap/Strap Eyelet (P21)
- 24 [DIGITAL/AV OUT] Socket (P104, 106, 108)
- 25 [DC IN] Socket (P106, 108)
  - Please be sure to use genuine Leica AC adaptor (ACA-DC4-U/J/E; optional).
  - This camera cannot charge the battery even when the AC adaptor (ACA-DC4-U/J/E; optional) is connected to it.
- 26 Terminal Cover

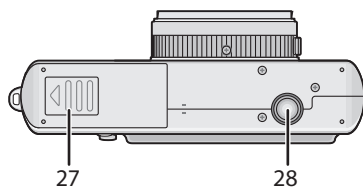

- 27 Card/Battery Door (P15, 16)
- 28 Tripod thread
  - When you use a tripod, make sure the tripod is stable with the camera attached to it.

# Quick Guide

This is the overview of the procedure to record pictures with this camera. For each operation, be sure to refer to the corresponding pages.

## 1 Charge the battery. (P13)

- When the camera is shipped, the battery is not charged. Charge the battery before use.

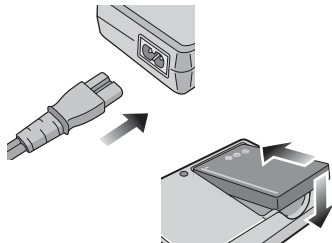

## 2 Insert the battery and the card. (P15, 16)

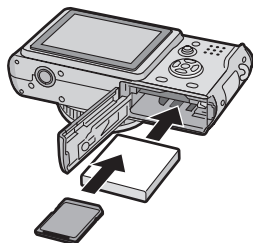

## 3 Turn the camera on to take pictures.

- Set the clock. (P22)

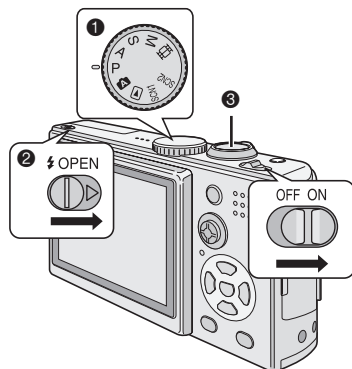

- 1 Set the mode dial to **[P]**.
- 2 Open the flash. (When using the flash) (P40)
- 3 Press the shutter button to take pictures. (P31)

## 4 Play back the pictures.

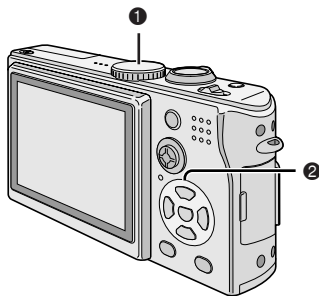

- 1 Set the mode dial to **[<img alt="playback icon" data-bbox="814 814 838 838] ]**.
- 2 Select the picture you want to view. (P49)

# Charging the Battery with the Charger

When the camera is shipped, the battery is not charged. Charge the battery before use.

## 1 Attach the battery with attention to the direction of the battery.

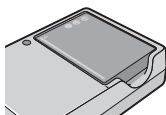
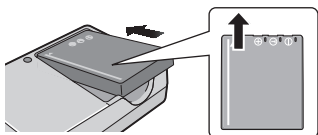

## 2 Connect the AC mains lead.

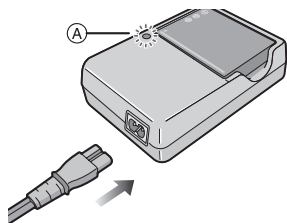

- The AC mains lead does not fit entirely into the AC input terminal. A gap will remain as shown below.

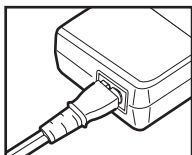

- When the [CHARGE] indicator **A** lights in green, charging starts.
- When the [CHARGE] indicator **A** turns off (in about 130 minutes), charging is completed.

## 3 Detach the battery.



- After charging is completed, be sure to disconnect the AC mains lead from the electrical outlet.
- The battery becomes warm after use/charge or during charge. The camera also becomes warm during use. However, this is not a malfunction with the camera.
- The battery will discharge if left for a long time after charging. Recharge it.
- **Use the dedicated charger and battery.**
- **Charge the battery with the charger indoors.**
- **Do not disassemble or modify the charger.**

# About the Battery

## ■ Battery indication

The remaining battery power appears on the screen. [It does not appear when you use the camera along with the AC adaptor (ACA-DC4-U/J/E; optional).]



The indication turns red and blinks:  
Recharge or replace the battery.

## ■ The lifetime of the battery

### The number of recordable pictures by CIPA standards (In Programme AE mode)

- CIPA is an abbreviation of [Camera & Imaging Products Association].

<b>Number of recordable pictures</b>	<b>Approx. 480 pictures (Approx. 240 min.)</b>
--------------------------------------	--

(Recording conditions by CIPA standards)

- Temperature: 23°C/  
Humidity: 50% when LCD monitor is on.
- Using SD Memory Card (supplied: 64 MB).
- Using the supplied battery.
- Recording starts 30 seconds after the camera is turned on.
- **Record once every 30 seconds**, with full flash every other recording.
- Rotating the zoom lever towards Tele to Wide and vice versa in every recording.
- Turn the camera off every 10 recordings./  
Leaving the camera until the battery is cooled down.

Note: When the Power LCD function (P28) is used, the number of recordable pictures decreases.

**The actual number of pictures you can take depends on the interval you leave between shooting. The number of shots reduces proportionately to the interval you leave.**

- So for example if you leave 2 minutes between each shot instead of the 30-seconds given in the conditions above, then the number of shots reduce to a quarter (Approx. 60 pictures).

## ■ Playback time

<b>Playback time</b>	<b>Approx. 300 min.</b>
----------------------	-------------------------

The number of recordable pictures and playback time will vary depending on the operating conditions and storing condition of the battery.

## ■ Charging

<b>Charging time</b>	<b>Approx. 130 min.</b>
----------------------	-------------------------

- When charging starts, the [CHARGE] indicator lights.

## ■ Charging error

- If the [CHARGE] indicator blinks at approximately 1-second intervals during charging, a charging error has occurred. In this case, disconnect the AC mains lead from the electrical outlet, detach the battery and then make sure both room and battery temperature are not too low or high. If the room temperature is between 10°C to 35°C, recharge the battery. If the [CHARGE] indicator still blinks even if you charge the battery for a while, consult your Leica dealer.
- When the operating time of the camera becomes extremely short even if the battery is properly charged, the life of the battery may have expired. Buy a new battery.

## ■ Charging conditions

- Charge the battery under temperature of 10°C to 35°C.
- The performance of the battery may be temporarily deteriorated and the operating time may become shorter in low temperature conditions (e.g. skiing/snowboarding).

# Inserting/Removing the Battery

- Check that the camera is turned off and that the lens is retracted.
- Close the flash.

## 1 Slide the card/battery door to open it.

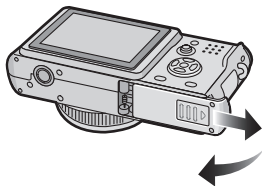

- Please be sure to use genuine LEICA batteries (BP-DC4-U/J/E).

## 2 Insert: Insert the charged battery paying attention to the direction of the battery.

**Remove:**  
Slide the lock ① to remove the battery.

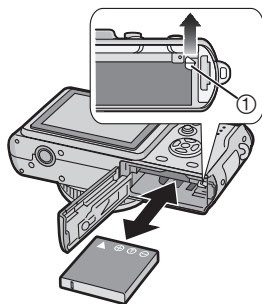

- ## 3
- ① Close the card/battery door.
  - ② Slide the card/battery door to the end and then close it firmly.

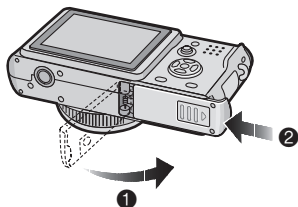

- If you will not be using the camera for a long time, remove the battery. Store the removed battery in the battery carrying case (supplied). (P115)
- When fully charged battery has been inserted for more than 24 hours, the clock setting is stored (in the camera) for at least 3 months even if the battery is removed. (The storing may be shorter if the battery is not charged sufficiently.) If more than 3 months has passed, the clock setting will be lost. In this case, set the clock again. (P22)
- Do not remove the card and the battery while the card is being accessed (P17). The data on the card may be damaged.
- The supplied battery is designed only for use with this camera. Do not use it with any other equipment.
- Ensure the camera is off before removing the battery. Camera settings may be lost if you remove the battery while it is on.

# Inserting/Removing the Card

- Check that the camera is turned off and that the lens is retracted.
- Close the flash.

## 1 Slide the card/battery door to open it.

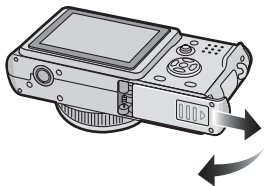

## 2 Insert:

Insert the card with the label side facing the back of the camera until it clicks.

**Remove:**

Push the card until it clicks, then pull the card out upright.

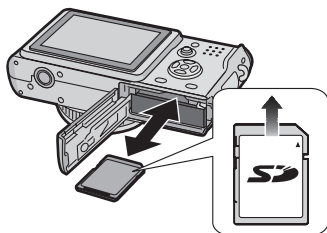

- Check the direction of the card.



- The card and the data may be damaged if it is inserted or removed while the camera is on.
- Use only the genuine SD card with SD Logo.
- Do not touch the connection terminals on the back side of the card.
- The card may be damaged if it is not fully inserted.

- ## 3
- 1 Close the card/battery door.
  - 2 Slide the card/battery door to the end and then close it firmly.

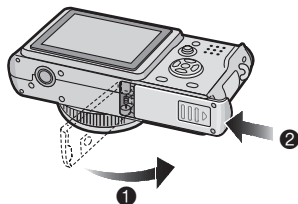

- If the card/battery door cannot be completely closed, remove the card and insert it again.



# About the Card

## ■ Access to the card

When pictures are being recorded onto the card, the card access indication ① lights red.

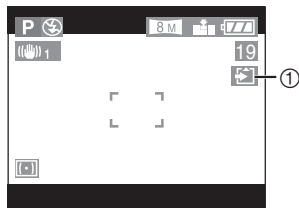

When the card access indication lights, pictures are being read or deleted, or the card is cleaned up (P103) or formatted, do not:

- turn the camera off.
  - remove the battery or the card.
  - shake or impact the camera.
- The card and the data may be damaged and the camera may not operate normally.

## ■ About handling a card

Store precious data to your PC (P106). The data on the card may be damaged or lost due to electromagnetic wave, static electricity, breakdown of this camera or a defective card.

- If you have formatted the card on a computer or other equipment, reformat it with this camera. (P103)

## ■ SD Memory Card (supplied) and MultiMediaCard

The SD Memory Card and MultiMediaCard are small, lightweight, removable external memory cards. The reading/writing speed of an SD Memory Card is fast. The SD Memory Card is equipped with a Write-Protect switch ② that can inhibit writing and formatting a card. (When the switch is slid to the [LOCK] side, it is not possible to write or delete data on the card and format it. When the switch is unlocked, these functions become available.)

### SD Memory Card



You can use SD Memory Cards with the following capacities (from 8 MB to 2 GB).





<b>8 MB, 16 MB, 32 MB, 64 MB, 128 MB, 256 MB, 512 MB, 1 GB, 2 GB (Maximum)</b>
--





- This unit supports SD Memory Cards formatted in FAT12 system and FAT16 system based on SD Memory Card Specifications.
- This camera cannot take motion pictures if you are using a MultiMediaCard.











- The reading/writing speed of a MultiMediaCard is slower than an SD Memory Card. When a MultiMediaCard is used, the performance of certain features may be slightly slower than advertised.
- Keep the Memory Card out of reach of children to prevent swallowing.





# Approximate number of recordable pictures and the size



Aspect ratio	16:9						
Picture size	8M (3840×2160 pixels)				5.5M EZ (3072×1728 pixels)		
Quality	TIFF			RAW	TIFF		
16 MB	0	3	6	0	0	5	10
32 MB	1	7	14	1	1	11	22
64 MB	2	15	29	3	3	23	46
128 MB	4	30	60	6	7	47	93
256 MB	9	59	115	13	14	92	180
512 MB	18	115	230	26	28	180	350
1 GB	36	230	460	52	57	360	710
2 GB	74	470	930	105	115	740	1420

Aspect ratio	16:9			3:2			
Picture size	2M EZ (1920×1080 pixels)			7M (3248×2160 pixels)			
Quality	TIFF			TIFF			RAW
16 MB	2	13	25	0	4	8	0
32 MB	4	28	54	1	8	17	1
64 MB	9	58	110	2	17	35	3
128 MB	18	115	220	5	36	71	6
256 MB	36	230	430	10	70	135	13
512 MB	72	450	860	21	135	270	26
1 GB	145	910	1720	43	270	540	53
2 GB	290	1800	3410	87	560	1090	105

Aspect ratio	<b>3:2</b>					
Picture size	<b>4.5M EZ</b> (2560×1712 pixels)			<b>2.5M EZ</b> (2048×1360 pixels)		
Quality	TIFF			TIFF		
16 MB	1	6	12	1	10	19
32 MB	2	13	27	3	21	41
64 MB	4	28	55	6	44	84
128 MB	8	57	110	14	89	170
256 MB	17	110	210	27	170	330
512 MB	34	220	430	54	340	650
1 GB	69	440	860	105	680	1310
2 GB	140	890	1700	210	1360	2560

Aspect ratio	<b>4:3</b>						
Picture size	<b>6M</b> (2880×2160 pixels)				<b>4M EZ</b> (2304×1728 pixels)		
Quality	TIFF			RAW	TIFF		
16 MB	0	4	9	0	1	7	14
32 MB	1	9	19	1	2	15	29
64 MB	3	20	39	3	4	31	60
128 MB	6	40	79	6	9	62	120
256 MB	12	79	155	13	19	120	230
512 MB	24	155	300	26	38	240	470
1 GB	48	310	610	53	76	480	940
2 GB	98	630	1220	105	150	970	1860

Aspect ratio	4:3					
Picture size	3M EZ (2048×1536 pixels)			2M EZ (1600×1200 pixels)		
Quality	TIFF			TIFF		
16 MB	1	9	17	2	14	28
32 MB	3	19	37	4	30	59
64 MB	6	39	75	10	62	120
128 MB	12	79	150	20	125	240
256 MB	24	150	290	39	240	470
512 MB	48	300	590	78	480	940
1 GB	96	610	1180	155	970	1880
2 GB	195	1220	2360	310	1920	3610

Aspect ratio	4:3		
Picture size	1M EZ (1280×960 pixels)		
Quality	TIFF		
16 MB	3	22	41
32 MB	7	46	86
64 MB	15	94	175
128 MB	31	190	350
256 MB	61	370	690
512 MB	120	730	1370
1 GB	240	1470	2740
2 GB	490	2920	5120



- Aspect ratio is the ratio of the width and the height of the picture. For aspect ratio settings, see page 87.
- If you select a larger picture size, you can print pictures clearly. When you select a smaller picture size, you can store more pictures on a card though the picture quality is deteriorated. (P73)
- EZ is an abbreviation for Extra Optical Zoom. (P88)
- For details about quality, see page 74.
- The numbers are approximations. (The numbers vary depending on the recording condition and the type of the card.)
- The number of recordable pictures may vary depending on subjects.
- The remaining number of recordable pictures displayed on the screen is an approximation.

# Attaching the Lens Cap/Strap

## ■ Lens Cap

- 1 Pass the string through the hole on the lens cap.



- 2 Pass the string through the hole on the camera.

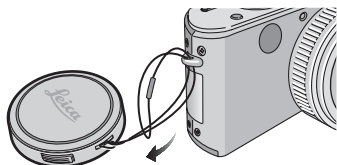

- 3 Attach the lens cap.

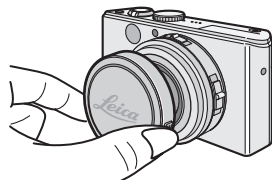

## ■ Strap

- 1 Pass the strap through the hole at the Strap Eyelet.

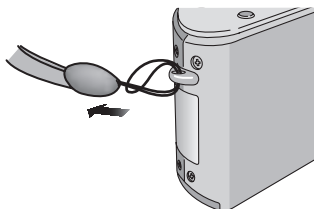

- Check that the strap is firmly attached to the camera.



- When you turn the camera off, carry the camera or play back the pictures, attach the lens cap to protect the surface of the lens.
- Detach the lens cap before turning on the camera in the recording mode.
- When the mode dial is set to one of the recording modes and the camera is turned on with the lens cap attached, the message [REMOVE LENS CAP AND PRESS ► BUTTON] appears. After removing the lens cap, press the ► cursor button.
- Be careful not to lose the lens cap.

# Setting Date/Time (Clock Set)

## ■ Initial setting

The clock is not set when the camera is shipped. When you turn the camera on, the following screen appears.



- Take the lens cap off before setting the date and time.
- Press the [MENU] button, the screen shown in step 1 appears.
- The setting screen disappears in about 5 seconds. Switch the unit back on to show the above screen again. Alternatively, press the [MENU] button to show the menu screen (P23), select [CLOCK SET] on page 2/4 of the setup menu, and do steps 1 and 2.

## 1 Set date and time.

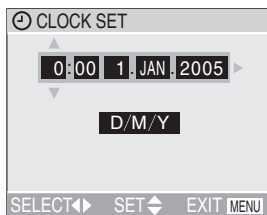

- ◀/▶ : Select the desired item.
- ▲/▼ : Set date and time.

## 2 Select [D/M/Y], [M/D/Y] or [Y/M/D].

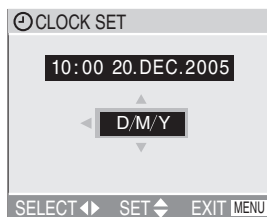

- Close the menu by pressing the [MENU] button 2 times after finishing the setting.
- Check if the clock setting is correct, after turning the camera off and on.



- When a fully charged battery has been inserted for more than 24 hours, the clock setting is stored (in the camera) for at least 3 months even if the battery is removed. (The storing time may be shorter if the battery is not charged sufficiently.)  
If more than 3 months has passed, the clock setting will be lost. In this case, set the clock again.
- You can set the year from 2000 to 2099. The 24-hour system is used.
- If you do not set the date, the date cannot be printed when you go to a photo studio for digital printing.
- For the date print setting, refer to P96.

# Setup Menu

Change the settings if necessary. (See pages 24 to 26 for details about the settings.)

## 1 Remove the lens cap and turn the camera on.

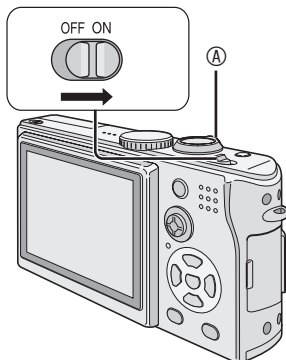

- The menu items depend on the mode selected with the mode dial (P30). In this page, the items in Programme AE mode [P] are indicated.

## 2 Press the [MENU] button.

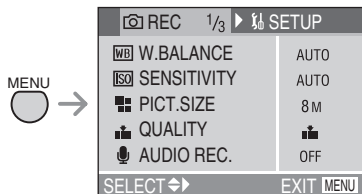

## 3 Select the [SETUP] Menu.

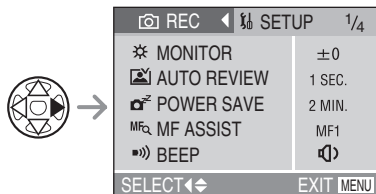

- When rotating the zoom lever (A) toward T, the page of the menu screen can be forwarded. (vice versa)

## 4 Select the desired item.

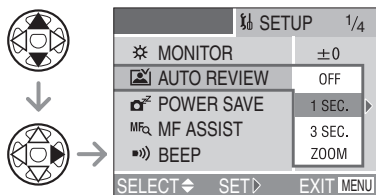



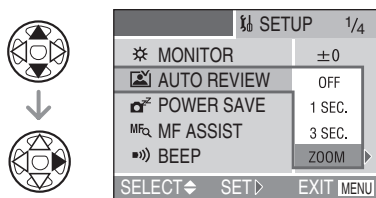





## 5 Set the desired value.



**Be sure to press ► at the end to determine the setting.**









- Press [MENU] to exit the menu. If you are in recording mode, you can exit the setup menu by pressing the shutter button halfway.

For setting, see page 23.





Menu	Functions
 MONITOR	Adjust the brightness of the LCD monitor in 7 steps.
 AUTO REVIEW	<p><b>[OFF]:</b> The recorded picture does not automatically appear.</p> <p><b>[1 SEC.]:</b>The recorded picture automatically appears on the screen for about 1 second.</p> <p><b>[3 SEC.]:</b>The recorded picture automatically appears on the screen for about 3 seconds.</p> <p><b>[ZOOM]:</b> The recorded picture automatically appears on the screen for about 1 second. Then it is enlarged 4 times and appears for about 1 second. This mode is useful for confirming focus. Pictures in burst mode, auto bracket, pictures with audio are not enlarged even if [ZOOM] is selected.</p> <ul style="list-style-type: none"> <li>• In motion picture mode [,], auto review function is not activated.</li> <li>• Auto review activates if you shoot with auto bracket [] (P46) or burst modes [,], [,], and [] (P48), irrespective of the auto review setting. (But the picture is not enlarged.)</li> <li>• When the quality is set to [TIFF] or [RAW], the auto review function works until the end of recording onto the card. (The picture is not enlarged.)</li> <li>• When using pictures with audio, the auto review function works while recording the audio or the data into the card regardless of the setting on the auto review function. (The picture is not enlarged.)</li> <li>• You cannot change the auto review setting when using auto bracket, burst modes, shooting motion pictures, [SELF PORTRAIT] in scene mode, and recording sound.</li> </ul>
 POWER SAVE	<p><b>[1 MIN.]/[2 MIN.]/[5 MIN.]/[10 MIN.]:</b> If you perform no operations, the camera turns off automatically after the interval you set to save the battery.</p> <p><b>[OFF]:</b> The camera is not automatically turned off.</p> <ul style="list-style-type: none"> <li>• Press the shutter button halfway or turn the camera off and on to recover from the power save mode.</li> <li>• When using the AC adaptor (ACA-DC4-U/J/E; opt.)/connecting to a PC or a printer/recording motion pictures/playing back motion pictures/during Slide Show, the power save mode is not activated. (Note that when you are using the Slide Show manually, the power saving feature will switch the unit off after 10 minutes.)</li> </ul>
 MF ASSIST	<p>In manual focus, assistance screen appears on the centre of the screen to facilitate focusing on the subject. (P84)</p> <p><b>[OFF]:</b> No MF ASSIST</p> <p><b>[MF1]:</b> MF ASSIST appears in the centre of the screen</p> <p><b>[MF2]:</b> MF ASSIST takes up the whole screen</p>



For setting, see page 23.

Menu	Functions
 BEEP	Set to select the volume of operational sound. [🔇]: No operational sound [🔊]: Soft operational sound [🔊🔊]: Loud operational sound
 SHUTTER	Set to select the volume of shutter sound. [🔇]: No shutter sound [🔊]: Soft shutter sound [🔊🔊]: Loud shutter sound
 VOLUME	The volume of speakers can be adjusted in 7 steps. (LEVEL6 to 0) • When you connect the camera to a TV, the volume of the speakers of the TV is not changed.
 CLOCK SET	Change date and time. (P22)
 NO.RESET	Set this when you want to start the file number of the picture from 0001 on the next recording. (The folder number is updated, and the file number starts from 0001.) • The folder number can be assigned from 100 to 999. When the folder number reaches 999, it cannot be reset. We recommend formatting the card after saving the data on a PC or elsewhere. • To reset the folder number to 100, you must first reformat the card (P103). After this perform [NO.RESET] to reset the file number, after which a screen appears asking whether you want to reset the folder number. Select [YES]. • For details about file and folder numbers, see page 107.
 RESET	The settings on the recording or the [SETUP] menu are reset to the initial settings. • The folder number and the clock setting are not changed. • Your baby's birthday (set in [BABY] scene mode (P65)) is cleared. [ROTATE DISP.] (P93) is reset to [ON].
 USB MODE	Set the USB communication system. Set before connecting to a PC or a printer. (P105)
 HIGHLIGHT	When the auto review or review function is activated, a white saturated area appears blinking in black and white. (P28)

For setting, see page 23.

Menu	Functions
 VIDEO OUT (Playback mode only)	<p><b>[NTSC]:</b> Video output is set to NTSC system.</p> <p><b>[PAL]:</b> Video output is set to PAL system. (P104)</p>
 TV ASPECT (Playback mode only)	<p><b>[16:9]:</b> Select if your television has a 16:9 aspect ratio.</p> <ul style="list-style-type: none"> <li>This mode is best for showing [16:9] aspect ratio images on a 16:9 aspect ratio television. Pictures shot in the [4:3] aspect ratio have black bands added to either side.</li> </ul> <p><b>[4:3]:</b> Select if your television has a 4:3 aspect ratio.</p> <ul style="list-style-type: none"> <li>This mode is best for showing [4:3] aspect ratio images on a 4:3 aspect ratio television. Images with a [16:9] aspect ratio are shown with black bands at the top and bottom (letterbox).</li> </ul> <p>• Note that when you select [16:9] and output to a television (P104), the picture on the camera's LCD will be stretched vertically.</p>
 MF m/ft	<p><b>[m]:</b> The focal distance is indicated in meters in manual focusing.</p> <p><b>[ft]:</b> The focal distance is indicated by feet in manual focusing.</p>
 SCENE MENU	<p><b>[OFF]:</b> [SCENE MODE] menu does not appear when setting the mode dial to [SCN1] or [SCN2] and the camera is operated in the scene mode currently selected. If you change the scene mode, press the [MENU] button to display the [SCENE MODE] menu and then select the desired scene mode.</p> <p><b>[AUTO]:</b> [SCENE MODE] menu appears automatically when setting the mode dial to [SCN1] or [SCN2]. Select the desired scene mode.</p>
 LANGUAGE	<p>Set to the language on the menu screen from the following 6 languages.</p> <p>Set to the desired language with ▲/▼ and determine it with ►.</p> <p><b>[ENGLISH]:</b> English      <b>[DEUTSCH]:</b> German  <b>[FRANÇAIS]:</b> French      <b>[ESPAÑOL]:</b> Spanish  <b>[ITALIANO]:</b> Italian      <b>[日本語]:</b> Japanese</p> <p>• When you set to other language by mistake, select [Q0] from the menu icons to set the desired language.</p>

# About the LCD Monitor

## ■ Selecting the screen to be used

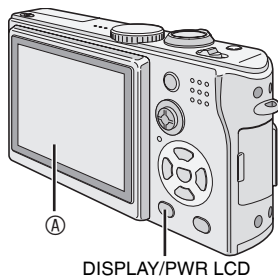

### Ⓐ LCD monitor (LCD)

Press the [DISPLAY/PWR LCD] button to switch to the screen to be used.

- When the menu screen appears, the [DISPLAY] button is not activated. During multi playback (P50) or playback zoom (P51), the indications on the screen can be turned on and off.

## In recording mode (P30)

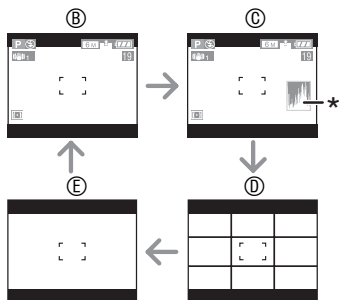

- Ⓑ Display
  - Ⓒ Display with histogram
  - Ⓓ Non-display (Recording guide line)
  - Ⓔ Non-display
- \*Histogram

## In playback mode (P49)

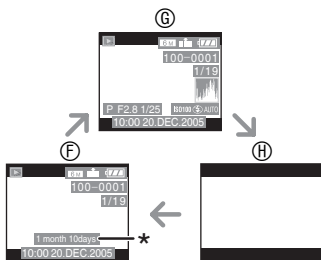

- Ⓕ Display
  - Ⓖ Display with recording information and histogram
  - Ⓗ Non-display
- \* Displayed when you set birthday setting for [BABY] in scene mode (P65), and [WITH AGE] is selected at taking pictures.

## ■ To view the LCD monitor outdoors on a bright sunny day (Power LCD function)

When you press and hold the [DISPLAY/PWR LCD] button for 1 second, the power LCD function is activated, the LCD monitor becomes brighter than usual and easier to see outdoors.

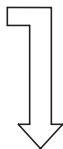

- A**: Power LCD indication
- When you take pictures, the LCD monitor automatically reverts back to the normal brightness 30 seconds after the [DISPLAY/PWR LCD] button is pressed. If you press any button, the LCD monitor turns on brightly again.
  - If you press and hold [DISPLAY/PWR LCD] button for 1 second again, the power LCD function is cancelled and the LCD monitor reverts back to its usual brightness.
  - In the power LCD function, the brightness and colour tone are emphatically displayed on the LCD monitor. Therefore, the brightness and the colour tone may look different from those in real life depending on the subject. However, this function does not affect recorded pictures.

## ■ Recording guide line

When you align the subject on the horizontal and vertical guide lines or the cross point of these lines, you can take pictures with well-designed composition by viewing the size, the slope and the balance of the subject.

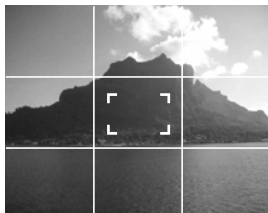

## ■ Highlight display

When setting [HIGHLIGHT] to [ON] on the [SETUP] menu (P25) while the auto review or review function is activated, any white saturated area (extremely bright or glistening part) on the picture appears blinking in black and white.

- If you adjust the exposure to minus, referring to the histogram and then take a picture again, it may result in a good picture.

### No highlight display



### With highlight display



## ■ Histogram

- A histogram is a graph that displays brightness along the horizontal axis (black to white) and the number of pixels at each brightness level on the vertical axis.
- It allows the camera user to easily check the way a picture is being exposed.
- When the values are concentrated to the left ①, the picture is under exposed. Pictures that are mostly black, such as night scenery, forms this type of histogram.
- When the values in the histogram are distributed evenly ②, the exposure is adequate and the brightness is well-balanced.
- When the values are concentrated to the right ③, the picture is over exposed. Pictures that are mostly white, forms this type of histogram.

### Example of histogram

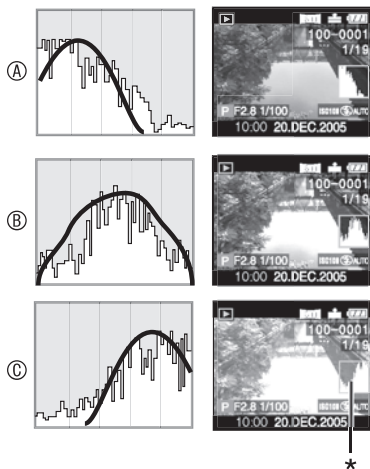

- ① Under Exposed  
 ② Properly Exposed  
 ③ Over Exposed  
 \*Histogram



- **When the recorded picture and the histogram do not match each other under the following conditions, the histogram is displayed in orange.**
  - When the flash is activated
  - When the flash is closed
    - ① When the brightness of the screen is not correct in dark places
    - ② When the exposure is not adequately adjusted
- The histogram does not appear when in motion picture mode [M], during multi playback and playback zoom.
- The histogram in the recording mode is an approximation.
- The histogram in recording and playback may not match each other.
- The histogram in this camera does not match the one displayed in image editing software used with a PC, etc.
- Check white saturated areas with the highlight display in the auto review function or the review function. (P28)

# Taking Pictures

## ■ The Mode Dial

This camera has a mode dial to suit for recording of many kinds of scenes. Select the desired mode and enjoy the variety of recording. Rotate the mode dial slowly and securely.

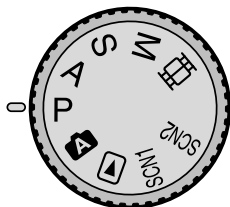

### **P** : Programme AE mode (P31)

The exposure is automatically adjusted by the camera.

### **A** : Aperture-priority AE (P54)

The shutter speed is automatically determined by the aperture value you set.

### **S** : Shutter-priority AE (P55)

The aperture value is automatically determined by the shutter speed you set.

### **M** : Manual exposure (P56)

The exposure is adjusted by the aperture value and the shutter speed which are manually adjusted.

### : Motion picture mode (P59)

This mode allows you to record motion pictures with audio.

### **SCN1** : Scene mode 1 (P61)

### **SCN2** : Scene mode 2 (P61)

This mode allows you to take pictures depending on the recording scenes.

This mode also allows you to set [SCENE MENU] (P26) on the [SETUP] menu to [OFF] and set the scene modes which are frequently used to [SCN1] and [SCN2] on the mode dial.

It is convenient because you can select the scene mode quickly and minimize the operation.

### : Auto mode (P35)

This is the recommended mode for beginners.

### : Playback mode (P49)

This mode allows you to play back recorded pictures.

## ■ Programme AE

**P**

The camera automatically sets the shutter speed and the aperture value according to the brightness of the subject.

- 1 **Remove the lens cap.**
- 2 **Turn the camera on.**
- 3 **Set the mode dial to programme AE mode [P].**
- 4 **Slide the focus switch to [AF].**

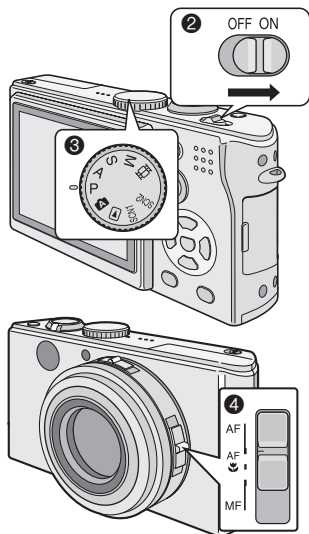

- 2 **Aim the AF area ① to the point you want to focus and then press the shutter button halfway.**

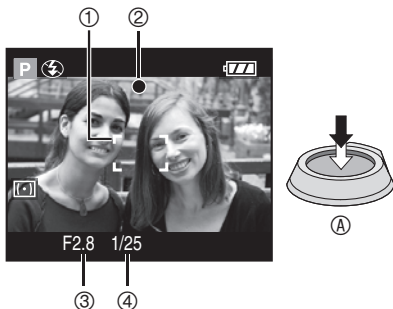

- **A** : Press the shutter button halfway to focus.
- The focus indication **②** is lit and then the aperture value **③** and the shutter speed **④** are displayed.
- You can change the shutter speed and aperture value with programme shift (P34).

- 3 **Take a picture.**



- **B** : Press the shutter button fully to take the picture.

	When the subject is not focused	When the subject is focused
Focus indication	Blink (green)	On (green)
AF area	Turns from white to red	Turns from white to green
Sound	Beeps 4 times	Beeps 2 times

## ■ Correct posture for taking good pictures

To take pictures without blurring:

- Hold the camera gently with both hands, keep arms stationary at your side and stand with your feet slightly apart.
- Be careful not to move the camera when you press the shutter button.
- Do not cover the microphone or the AF assist lamp with your fingers or other objects.
- Do not touch the lens part.
- Do not cover the photo flash with your finger or other objects.

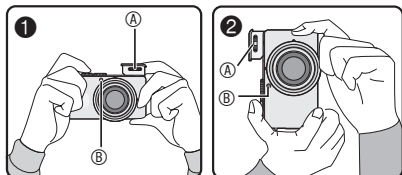

① : When holding the camera sideways

② : When holding the camera vertically

Ⓐ : Photo flash

Ⓑ : AF assist lamp

- For the following modes and methods, keep the camera steady. Use a tripod for best results. By combining the use of a tripod with the self-timer (P44), you can avoid blurring caused when you press the shutter button.

–Slow sync./Red-eye reduction [**⚡S**Ⓞ] (P41)

–[NIGHT PORTRAIT] (P64), [NIGHT SCENERY] (P64), [CANDLE LIGHT] (P66), [FIREWORKS] (P67), [PARTY] (P67), [STARRY SKY] (P68) in scene mode (P61)

–When you have reduced shutter speed (P55, 56)

## ■ Focusing

- The focus range is 50 cm to ∞ (Wide), 1.2 m to ∞ (Tele).
  - If you press the shutter button fully without prefocusing, pictures may be blurry or unfocused.
  - When the focus indication is blinking, the subject is not focused. Press the shutter button halfway and focus on the subject again.
  - If the camera will not focus after a few tries, turn it off and on and try again.
  - In the following cases, the camera cannot focus on subjects properly.
    - When including both near and distant subjects in a scene.
    - When there is dirt or dust on the glass between the lens and the subject.
    - When there are illuminated or glittering objects around the subject.
    - When taking a picture in a dark place.
    - When the subject is moving fast.
    - When the scene has low contrast.
    - When jitter occurs.
    - When recording a very bright subject.
- We recommend taking pictures using manual focus (P83), prefocus (P84) or AF/AE lock (P85). In dark places, the AF assist lamp (P77) may turn on to focus on the subject.
- Even if the focus indication appears and the subject is focused, it is cancelled when you release the shutter button. Press the shutter button halfway again.



### ■ Jitter (camera shake)

- Be careful of jittering when pressing the shutter button.
- The jitter alert ① appears when the shutter speed is slow and the chances of blurring are greater.



- When the jitter alert appears, take special care with the shooting methods described on P32, or use a tripod for best results. By combining the use of a tripod with the self-timer (P44), you can avoid blurring caused when you press the shutter button.

### ■ Format detection function

- If you take pictures by holding the camera vertically, the information of the rotation on the pictures are automatically added and recorded to the pictures. When [ROTATE DISP.] (P93) is set to [ON], you can rotate and display pictures on the screen or the TV according to the information of the rotation on the pictures.
- When you take pictures by holding the camera vertically, read “Correct posture for taking good pictures” on P32 carefully.
- This function may not work properly on pictures recorded by aiming the camera up or down.
- In motion picture mode [ ] or [FLIP ANIM.], you cannot use the Format detection function.

### ■ Exposure

- If you press the shutter button halfway when the exposure is not adequate, the indication of the aperture value and the shutter speed turns red. (However, the aperture value and the shutter speed do not turn red when the flash is activated.)
- The brightness of the screen may differ from that of recorded pictures. Even though the subject appears dark on the screen, the actual picture will be bright.
- When most of the subjects in the screen are bright (e.g. blue sky on a clear day, snowy field, etc.), the recorded pictures may become dark. In this case, compensate the exposure value on the camera. (P45)



- When you press the shutter button, the screen may become bright or dark for a moment. This function allows easy adjustment of focus and the recorded picture will not be affected.
- We recommend setting the clock again before taking pictures. (P22)
- When the time for power save is set (P24), the camera is automatically turned off if you do not operate it within the set time. When operating the camera again, press the shutter button halfway or turn the camera off and on.
- In some cases, if the distance between the camera and the subject is beyond the recordable range when you use the camera, the picture may not be properly focused even if the focus indication is lit.

## ■ Programme shift

In Programme AE mode, you can change the preset aperture value and the shutter speed under the same exposure. This is called Programme shift.

By this function, you can make the background more blurred (by decreasing the aperture value) or record the moving subject more dynamically (by setting to slow shutter speed) in Programme AE mode.

- While the aperture and shutter speed are shown on the LCD (about 10 seconds), move the joystick to activate Programme shift.

(e.g.: When the focus switch is set to [AF])



- ▼: When the focus switch is set to [AF] or [AF] (P86)
- ◀: When the focus switch is set to [MF] (P83)



①



- When the Programme shift is activated, the Programme shift indication ① appears on the screen.

## ■ Example of Programme shift

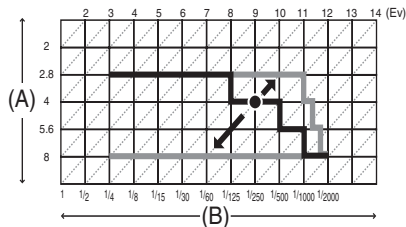

(A): Aperture value

(B): Shutter speed



- If the exposure is not adequate when pressing the shutter button halfway, the shutter speed turns red.
- When 10 or more seconds have passed after the Programme shift becomes effective, the status to activate the Programme shift is cancelled and returned to the Programme AE mode. However, the setting on the Programme shift is memorized.
- Programme shift is cancelled when turning the camera off.
- The Programme shift may not be activated depending on the brightness of the subject.

# Taking Pictures in Auto Mode



Auto mode makes it easy for inexperienced users. It displays only simple menu settings and allows you to take pictures without error.

## 1 Select the desired item and set the desired value.

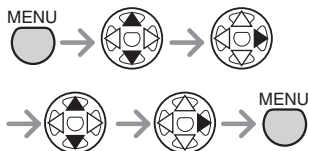
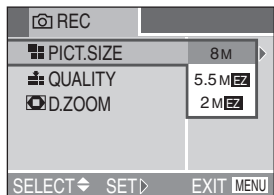

## Other Settings in Auto mode

In Auto mode, other settings are fixed as follows. For details, refer to the pages corresponding to each item.

Focus range ([AF]/[AF ]/[MF])	30 cm to ∞ (Tele) 5 cm to ∞ (Wide)	
White balance	[AUTO]	P71
ISO sensitivity	[AUTO]	P73
Picture Adjustment	[STD.]	P79
Audio Recording	[OFF]	P75
Metering Mode	[] (Multiple)	P75
AF mode	[] (1-area-focusing)	P76
Continuous AF	[OFF]	P77
AF assist lamp	[ON]	P77
AF/AE Lock	Not possible	P85
Flip Animation	Not possible	P79

## Settings in Auto mode

- For details, refer to the pages corresponding to each item.

[PICT.SIZE] : P73

[QUALITY] : P74

[D.ZOOM] : P78

## ■ The Backlight Compensation

Backlight is a situation where light comes from behind the subject. Subjects such as people become dark when pictures are recorded in the backlight. If you press ▲, [B.] (compensating backlight ON indication) appears and the backlight compensation function is activated. This function compensates the backlight by brightening the whole of the picture.

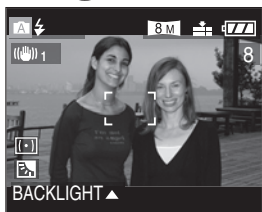
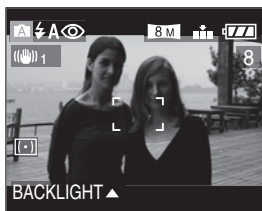

- If you press ▲ while [B.] is displayed, [B.] disappears and the backlight compensation function is cancelled.
- When you use the backlight compensation function, we recommend using the flash.



- You cannot set the following items in the Auto mode.
  - [VIDEO OUT]
  - [TV ASPECT]
- The settings [PICT.SIZE], [QUALITY] and [D.ZOOM] on the Auto mode are applied to other recording modes.
- You cannot use the following functions in the Auto mode.
  - Exposure compensation
  - Auto bracket
  - [COL.EFFECT]

# Checking the Recorded Picture (Review)



## 1 Press ▼.



- The last recorded picture appears for about 10 seconds.
- Press ▼ again to cancel the review.
- You can check the previous or following picture with ◀/▶.
- When the recorded pictures are too bright or dim, compensate the exposure. (P45)

## 2 Enlarge and shift the picture.



- : 1x → 4x → 8x
- : 8x → 4x → 1x
- When you change the magnification or the position to be displayed, the zoom position indication **A** appears for about 1 second to check where is enlarged.

## ■ Recorded pictures can be deleted during the review (Quick Deletion)



- Once deleted, pictures cannot be recovered.
- Multi pictures or all pictures can be deleted. Read P52 or P53 to operate them.

# Using the Optical Zoom



You can make people and subjects appear closer with the 4 times optical zoom, and landscapes can be recorded in wide angle.

1X



2X



3X



4X



- To make subjects appear further away use (Wide)

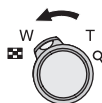

- To make subjects appear closer use (Tele)

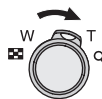
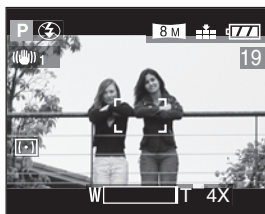

- To further increase the zoom
  - Use the extra optical zoom. (P88)
  - Use the digital zoom (P78).



- The optical zoom is set to Wide (1×) when the camera is turned on.
- If you use the zoom function after focusing on the subject, focus on the subject again.
- The lens barrel (P10) is ejected or retracted according to the zoom position.
- Take care not to obstruct the motion of the lens while the zoom lever is rotated.
- When you record motion pictures [, the zoom magnification is fixed to the value set at the start of recording.
- The picture may have some distortion (typical example: vertical straight line bent outwards). This is due to aberrations, which is common to some extent with all photographic lenses. Distortion may be more visible when using a wider area of the zoom lens as you get closer to the subject.
- The zoom rate is a guide only.

# Taking Pictures using the Built-in Flash



When you set the flash, you can take pictures using the built-in flash according to the recording condition.

## ■ To open the flash

Slide the [⚡ OPEN] switch (A).

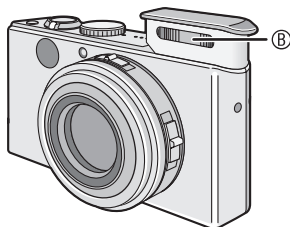
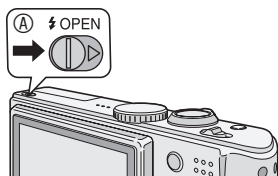

### (B) Photo flash

- Do not cover the photo flash with your fingers or any other items.

## ■ To close the flash

Press the flash until it clicks.

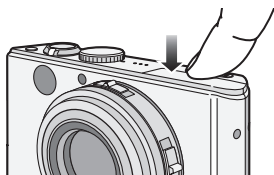

- Be sure to close the flash when not in use.
- The flash setting is fixed to Forced OFF [⚡ OFF] while the flash closes.

## ■ Switching to the appropriate flash setting

Set the flash setting of the built-in flash according to the scene to be recorded.



For the selectable flash settings, refer to “Available flash settings by recording mode” on P42.



**⚡A** : AUTO

The flash is automatically activated according to the recording condition.

**⚡A👁** : AUTO/Red-eye reduction

The flash is automatically activated according to the recording condition. It reduces the red-eye phenomenon (eyes of the subject appear red in a flash photo) by triggering the flash before actually recording the picture.

After that, the flash is activated for actual recording again.

The flash goes off twice if you are using AUTO/Red-eye reduction [**⚡A👁**], Forced ON/Red-eye reduction [**⚡👁**], and Slow-sync./Red-eye reduction [**⚡S👁**]. The first flash is preparatory. Do not move until after the second flash.

- **Use this when you take pictures of people in low lighting conditions.**

**⚡** : Forced ON

The flash is activated every time regardless of the recording condition.

- **Use this when your subject is backlit or under fluorescent light.**

**⚡👁** : Forced ON/Red-eye reduction

- **In [PARTY] (P67) or [CANDLE LIGHT] (P66) in scene mode, the flash mode is set to Forced ON/Red-eye reduction.**

**⚡S👁** : Slow sync./Red-eye reduction

When you take a picture with a dark background landscape, this feature makes the shutter speed slow when the flash is activated, so that the dark background landscape will become bright. Simultaneously it reduces the red-eye phenomenon.

- **Use this when taking pictures of people in front of a dark background.**

**👁** : Forced OFF

The flash is not activated in any recording condition.

- **Use this when taking pictures in places where the use of the flash is not permitted.**

## ■ Available flash settings by recording mode

The available flash settings depend on the recording mode.

(○ : Available, —: Not available)

	<b>A</b>	<b>P</b>	<b>A</b>	<b>S</b>	<b>M</b>															
	—	○	○	○	○	—	○	○	○	—	—	—	○	○	—	—	—	○	—	○
	○*	○	○	○	○	—	○	○	—	—	—	—	○	○	—	—	—	—	—	○
	○	○	○	○	○	—	○	○	○	—	—	—	○	○	—	—	—	○	—	○
	—	—	—	—	—	—	—	—	—	—	—	—	—	○	○	—	—	—	—	—
	—	○	○	—	—	—	—	—	—	○	—	—	—	○	○	—	—	—	—	—

\*Not available in backlight compensation

## ■ The available flash range to take pictures







ISO sensitivity	Available flash control range
AUTO	60 cm to 4.1 m (Wide) 30 cm to 2.3 m (Tele)
ISO80	60 cm to 1.8 m (Wide) 30 cm to 1.0 m (Tele)
ISO100	60 cm to 2.0 m (Wide) 30 cm to 1.1 m (Tele)
ISO200	60 cm to 2.9 m (Wide) 30 cm to 1.6 m (Tele)
ISO400	60 cm to 4.1 m (Wide) 40 cm to 2.3 m (Tele)

- The available flash range is an approximation.
- Refer to P32 for the focus range.
- Refer to P73 for the ISO sensitivity.



- If the ISO sensitivity is set to [AUTO] (P73), it is automatically adjusted from [ISO100] to [ISO400] when you use the flash.
- If picture noise becomes noticeable, reduce the ISO sensitivity (P73) or set [NOISE REDUCTION] in [PICT.ADJ.] to [HIGH] (P79).





## ■ Shutter speed for each flash mode

Flash mode	Shutter speed (sec.)
 : AUTO	1/30 to 1/2000
 : AUTO/Red-eye reduction	1/30 to 1/2000
 : Forced ON	1/30 to 1/2000
 : Forced ON/Red-eye reduction	1 to 1/2000
 : Slow sync./Red-eye reduction	1 to 1/2000
 : Forced OFF	1/4 to 1/2000 (In Auto mode [ <b>A</b> ])
	1 to 1/2000 (In Programme AE mode [ <b>P</b> ])

- The settings may be different from those shown here if you are using scene modes.
  - [NIGHT SCENERY] : 8 to 1/2000 (sec.)
  - [STARRY SKY] : 15, 30 or 60 (sec.)



- **Do not stare at the photo flash from close proximity.**
- **If you bring the flash too close to the subjects, they may appear distorted or discoloured by its heat and lighting.**
- **Do not cover the photo flash with your fingers or any other items.**
- When you take a picture beyond the flash control range, the exposure may not be adjusted properly and the picture may become bright or dark.
- When you repeat taking a picture, recording may be disabled even if the flash is activated. Take a picture after the card access indication disappears.
- When the jitter alert appears, we recommend using the flash.
- When you set to burst mode or auto bracket, only 1 picture is recorded for every flash activated.

- The flash icon turns red when activating the flash and pressing the shutter button halfway.
- When the flash is being charged, the flash icon blinks red, and you cannot take a picture even when you press the shutter button fully.
- When taking a picture with the flash, the white balance will be automatically adjusted [except for  (Daylight)], but the white balance may not be properly adjusted if the photo flash is insufficient.
- When the shutter speed is fast, the flash effect may not be sufficient.
- Do not close the flash immediately after using a secondary light source, for example AUTO/Red-eye reduction []. Doing so can damage the camera.
- In motion picture mode [, [SCENERY], [NIGHT SCENERY], [FIREWORKS] or [STARRY SKY] in scene mode (P61), the flash mode is fixed to Forced OFF [] even if the flash is open.
- You can extend the shutter speed by up to 1/8 by using exposure compensation.

# Taking Pictures with the Self-timer



## 1 Switch the self-timer setting.

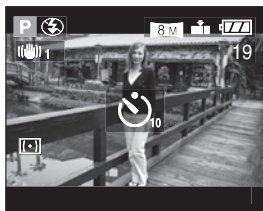

: Self-timer set to 10 seconds



: Self-timer set to 2 seconds



No display (cancelled)

## 2 Focus on the subject to take the picture.

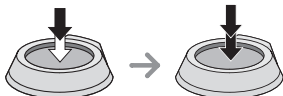

- The self-timer indicator

① blinks and the shutter is activated after 10 seconds (or 2 seconds).

- If you press the [MENU] button when the self-timer is set, the self-timer setting is cancelled.

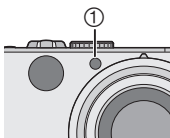

- When you press the button fully with one stroke, the subject is automatically focused just before the recording. In dark places, the self-timer indicator blinks and then it may turn on brightly to work as the AF assist lamp (P77) for focusing on the subject.
- The self-timer is fixed at 2 seconds when you are using [SELF PORTRAIT] in scene mode (P69).
- When you set the self-timer in the burst mode, the number of pictures taken at one time is fixed to 3.
- When using a tripod or in other cases, setting the self-timer to 2 seconds is a convenient way to stabilize the jitter caused by pressing the shutter button.
- We recommend using a tripod when setting the self-timer. (When using a tripod, be sure to confirm that the tripod is stable when this unit is attached.)

# Compensating the Exposure

**PAS**  **SCN1** **SCN2**

Use this function when you cannot achieve appropriate exposure due to the difference of brightness between the subject and the background.

**Over exposed**



Compensate the exposure toward negative.



**Properly Exposed**



**Under exposed**



Compensate the exposure toward positive.

- 1 Press **▲** several times until **[EXPOSURE]** appears and then compensate the exposure.



- You can compensate from  $-2$  EV to  $+2$  EV in steps of  $1/3$  EV.



- EV is an abbreviation of Exposure Value, and it is the amount of light given to the CCD by the aperture value and the shutter speed.
- The compensation range of the exposure will be limited depending on the brightness of the subject.
- The exposure compensation value appears on the lower left of the screen.
- The exposure value is memorized even if the camera is turned off.
- You cannot compensate the exposure with **[STARRY SKY]** in scene mode (P68).

# Taking Pictures using Auto Bracket



In this mode, 3 pictures are automatically recorded by each press of the shutter button according to the compensation range of the exposure.

You can select the desired exposure among the 3 types of pictures.

- 1 Press **▲** several times until **[] AUTO BRACKET** appears and then set the compensation range of the exposure.

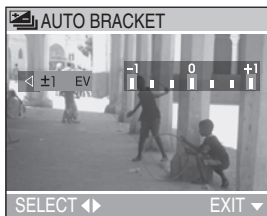

- You can select the exposure from  $-1$  EV to  $+1$  EV in steps of  $1/3$  EV.
- When you do not use auto bracket, select [OFF].
- When setting the auto bracket, the auto bracket icon appears on the lower left of the screen.



- You cannot use auto bracket when there are only one or two pictures remaining.
- When taking pictures using auto bracket after the exposure compensation, the pictures are based on the compensated exposure.  
When the exposure is compensated, the compensated exposure value appears on the screen.
- When the flash is activated, you can take only 1 picture.
- When setting auto bracket, you cannot use the audio recording function.
- When setting auto bracket and the burst mode simultaneously, auto bracket will be performed.
- The exposure may not be compensated with auto bracket depending on the brightness of the subject.
- Auto review works if you activate auto bracket, irrespective of the auto review setting. (But the picture is not enlarged.) You cannot change the auto review setting in the setup menu.
- Setting ISO sensitivity to [ISO400] increases the time lapse between pictures to allow for the noise reduction process.
- You cannot use auto bracket if you have set quality to [TIFF] or [RAW].
- You cannot use auto bracket with [STARRY SKY] in scene mode.
- When using Shutter-priority AE [**S**] or Manual exposure [**M**] mode and you have set the shutter speed to more than 1.3 second, auto bracket does not work.

# Optical Image Stabilizer [STABILIZER]





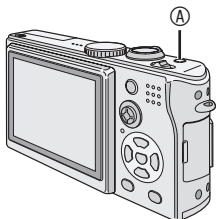

This mode recognizes and compensates jitter. You can reduce blurring caused by jitter especially when you take pictures with the optical zoom set to Tele or when you take pictures indoors where the shutter speed is slowed down.

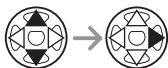
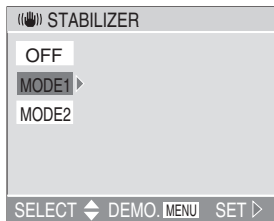

Ⓐ Optical Image Stabilizer button

- 1 Keep pressing the stabilizer button until [STABILIZER] appears and then select the stabilizer function mode.



MODE1 (  1)	The stabilizer operates continuously and can assist during photocomposition.
MODE2 (  2)	The stabilizer function is in standby and activates at the moment the shutter captures the image.
OFF (  OFF)	When image stabilization is not desired.

## ■ Demonstration of the optical image stabilizer (Demonstration Mode)

When you press the [MENU] button, the demonstration appears. After the demonstration ends, the screen returns to the stabilizer function mode selection menu. If you want to exit the demonstration halfway through, press the [MENU] button again.

While the demonstration is displayed, the optical zoom is fixed to Wide (1x) and the zoom function cannot be activated. Moreover, you cannot take pictures.



- The stabilizer function may not work in the following cases so take special care not to move the camera when pressing the shutter button.
  - When too much jitter occurs.
  - In digital zoom range.
  - When taking pictures while following subjects in motion.
  - When the shutter speed is extremely slow due to dark conditions or other reasons.
- In [SELF PORTRAIT] in scene mode (P69), the stabilizer function mode is fixed to [MODE2] and the stabilizer function menu does not appear.
- In motion picture mode () [MODE2] cannot be set.
- This is fixed to [OFF] if you have selected [STARRY SKY] in scene mode (P68) and Optical Image Stabilizer menu will not appear.

# Taking Pictures using Burst Mode



- 1 Press the Single/Burst Mode Button to switch the burst mode setting and then take pictures.

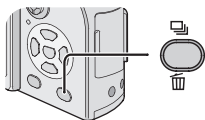
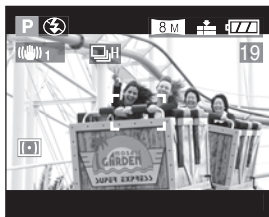

: High speed

: Low speed

: Unlimited

No display (cancelled)

- Hold down the shutter button fully to activate the burst mode.

## ■ Number of pictures recorded in burst mode

	Burst speed (pictures/second)	Number of recordable pictures (pictures)	
	3*	max. 5	max. 9
	2*	max. 5	max. 9
	2	Depends on the card capacity	Depends on the card capacity

\*The transfer speed of the card has no effect on the burst speed.

- When the shutter speed is faster than 1/60 and the flash is not activated



- When the burst mode setting is set to Unlimited:
  - You can take pictures until the capacity of the card becomes full.
  - The shutter speed becomes slower during operation. The point at which the speed becomes slower depends on the [PICT.SIZE] setting or the type of the memory card.
- The focus is fixed in the first picture.
- When the self-timer is used, the number of recordable pictures in burst mode is fixed to 3.
- When the burst mode is activated, the audio recording function cannot be used.
- If the flash is activated, you can record only 1 picture.
- When setting auto bracket and the burst mode simultaneously, auto bracket will be performed.
- The ways to control the exposure and the white balance vary depending on the burst mode setting. When the burst mode is set to , they are fixed to the values set for the first picture. When the burst speed is set to or , they are adjusted each time you take a picture.
- In Burst mode, auto review is activated even the setting is off. (The picture is not enlarged.)
- You cannot change the auto review setting in the setup menu.
- You cannot use burst mode if you have set quality to [TIFF] or [RAW].
- You cannot use burst mode with [STARRY SKY] in scene mode.
- Burst mode will not perform as described if a MultiMediaCard is used in place of an SD Memory Card. The reading/writing speed of a MultiMediaCard is slower than that of an SD Memory Card.



# Playing Back Pictures



## 1 Select the picture.



or



- ◀ : Play back the previous picture.
- ▶ : Play back the next picture.
- The picture following the last one is the first picture.
- When [ROTATE DISP.] (P93) is set to [ON], pictures recorded by holding the camera vertically are played back vertically.

### ■ Fast forwarding/Fast rewinding

When you keep pressing ◀/▶ during playback, the file number and the page number are updated. If you release ◀/▶ when the number of the desired picture appears, you can play back the picture.

▶ : Fast forward

◀ : Fast rewind

- The number of files forwarded/rewound at a time depends on how long you hold down ◀/▶. It also varies depending on the number of the recorded pictures.
- If you release ◀/▶ and press them again, the files will be forwarded/rewound one by one.

- In review playback in the recording mode or multi playback, the picture can only be forwarded or rewound one by one.
- When you forward or rewind a large number of pictures, release ◀/▶ once before reaching the picture to be played back, then press ◀/▶ to forward/rewind pictures little by little.



- This camera is based on the DCF standards (Design rule for Camera File system) which was established by the Japan Electronics and Information Technology Industries Association (JEITA).
- When changing the folder name or file name on a PC, the pictures will not be played back.
- The file format that can be played back with this camera is JPEG. (There are also pictures that on some occasions cannot be played back in JPEG format.)
- When playing back pictures that have been recorded with other equipment, the picture quality may be deteriorated and pictures may not be played back.
- When playing back a file out of standard, the folder/file number is indicated by [—] and the screen may turn black.
- An interference fringe may appear on the screen depending on the subject. This is called moire. This is not a malfunction.

# 9/16/25 Pictures Multi Playback



## 1 Switch to multi screen.

For example: When you have chosen to show 9 pictures

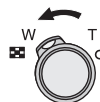

1 picture → 9 pictures →  
16 pictures → 25 pictures

- When you select multi playback, the scroll bar **A** appears so you can check the position of the selected picture in the total pictures.

## 2 Select the pictures.

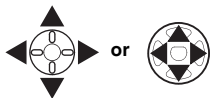
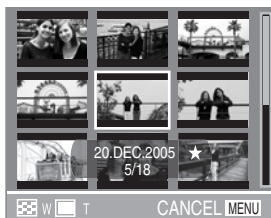

- The following information is displayed: the shooting date, the number of the selected picture in the total pictures, the [FAVORITE] setting [**★**] (Only if the [FAVORITE] setting is set to [ON]), the motion picture setting [**MP**], the [BABY] setting [**BB**] and age settings.

## ■ 16/25 pictures multi screen

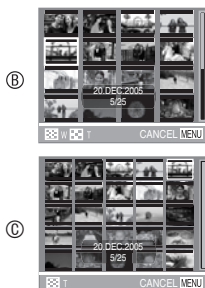

- B** 16 pictures
- C** 25 pictures

## ■ To return to the normal playback

- Rotate the zoom lever towards T, or press the [MENU] button or joystick.
- The picture framed in an orange box appears.

## ■ To delete a picture during a multi playback

Press the [**DEL**] button.

When the confirmation screen appears, press **▼** to select [YES], and press **▶**. (P52)



- Pictures will not be displayed in the rotated direction even if [ROTATE DISP.] is set to [ON] (P93).
- You can switch the display on or off by pressing the [DISPLAY] button.

# Using the Playback Zoom



## 1 Enlarge the picture.

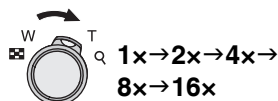

- When you rotate the zoom lever towards W after the picture is enlarged, the magnification becomes lower.
- When you change the magnification, the zoom position indication **A** appears for about 1 second to check the position of the section enlarged.
- When you press the [MENU] button, the magnification reverts to 1x.

## 2 Shift the picture.



- When you move the position to be displayed, the zoom position indication is displayed for about 1 second.

### ■ To delete a picture during the playback zoom

Press the [DELETE] button.

When the confirmation screen appears, press ▼ to select [YES], and press ►. (P52)



- The more the picture is enlarged, the more its quality deteriorates.
- The playback zoom may not operate if pictures have been recorded with other equipment.
- Even if the indication on the LCD monitor are turned off in normal playback mode (P27), the magnification and enabled operations appear on the LCD monitor when the playback zoom is activated. You can switch the display on or off by pressing the [DISPLAY] button. When you set the magnification to 1x, the indication on the LCD monitor are displayed as in normal playback mode.

# Deleting Pictures



## ■ To delete a single picture

### 1 Select the picture to be deleted.



- ◀: Play back the previous picture.
- ▶: Play back the next picture.

### 2 Delete the picture.



- While deleting the picture, appears on the screen.

## ■ To delete multiple pictures

### 1 Select [MULTI DELETE].

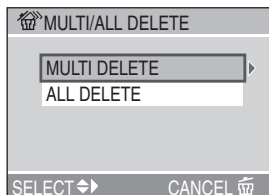

2 times

### 2 Select the pictures to be deleted.

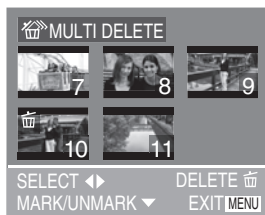

- Repeat the above procedure.
- The selected pictures appear with . When ▼ is pressed again, the setting is cancelled.
- After selecting pictures, press to confirm your selection.
- The icon blinks red if the selected picture cannot be deleted. Cancel the protect setting. (P97)

### 3 Delete the pictures.

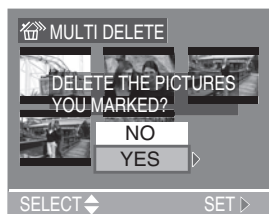

- It is possible to delete up to 50 pictures all at once.

### ■ To delete all pictures

#### 1 Select [ALL DELETE].

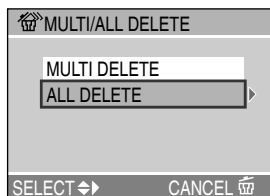

#### 2 Delete all of the pictures.

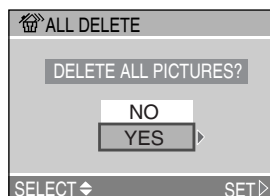

- Once deleted, pictures cannot be recovered. Please double-check before deleting pictures.
- Do not turn off the camera while deleting.
- Pictures that are protected (P97) or that do not conform to DCF standards (P49) will not be deleted.
- When you delete pictures, use a battery with sufficient battery power (P14) or use with the AC adaptor (ACA-DC4-U/J/E; optional).
- The more pictures there are to delete, the more time it takes.

# Using the Mode Dial

## A Aperture-priority AE



When you want the background to be in sharp focus, set the aperture value to a higher number. The higher the aperture value is the smaller the aperture opening will be. For a soft focus background, set the aperture value to a lower number which corresponds to a larger aperture opening.

### 1 Set the aperture value and take the picture.

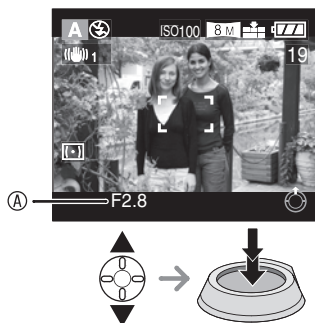

Ⓐ Aperture value

▲ : Increase

▼ : Decrease



- Refer to P58 for the available range of the aperture value and the shutter speed.
- The brightness of the screen may differ from that of the actual pictures. Check it using review function or setting to the playback mode.
- The ISO sensitivity cannot be set to [AUTO]. (P73) (When the recording mode is switched to Aperture-priority AE, the ISO sensitivity is automatically set to [ISO100].)
- When the exposure is not adequate, the aperture value and the shutter speed on the screen turn red.

## S Shutter-priority AE



When you want to take a sharp picture of a fast moving subject, set to a faster shutter speed. When you want to create a trail effect, set to a slower shutter speed.

### 1 Set the shutter speed and take the picture.

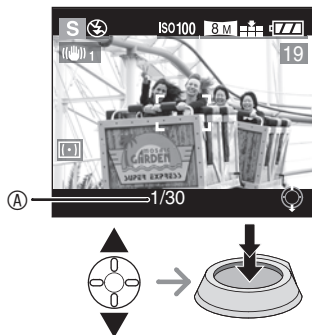

Ⓐ Shutter speed

▲ : Faster

▼ : Slower



- Refer to P58 for the available range of the aperture value and the shutter speed.
- The brightness of the screen may differ from that of the actual pictures. Check it using review function or setting to the playback mode.
- You cannot set the following items in Shutter-priority AE.
  - Slow sync./Red-eye reduction [ ] (P41)
  - [AUTO] in ISO sensitivity (P73) (When the recording mode is switched to Shutter-priority AE, the ISO sensitivity is automatically set to [ISO100] even though it was set to [AUTO] beforehand.)
- When the exposure is not adequate, the aperture value and the shutter speed on the screen turn red.
- When the shutter speed is slow, we recommend using a tripod.

**M** Manual exposure

Decide the exposure by setting the aperture value and the shutter speed manually.

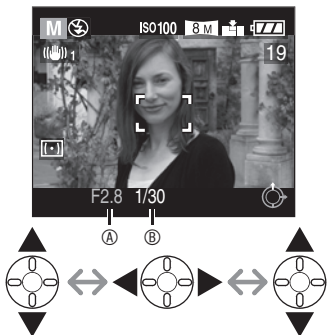
**1 Set the aperture value and the shutter speed.**

- ▲/▼: Set the aperture value **A** and the shutter speed **B**.
- ◀/▶: Select the aperture value and the shutter speed.

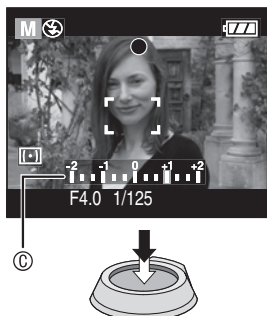
**2 Press the shutter button halfway.**

- Indication for the condition of exposure **C** (manual exposure assistance) appears for about 10 seconds.
- When the exposure is not adequate, set the aperture value and the shutter speed again.

**3 Take the picture.****Manual Exposure Assistance**

	The exposure is adequate.
	Set to faster shutter speed or larger aperture value.
	Set to slower shutter speed or smaller aperture value.

- The manual exposure assistance is an approximation. We recommend taking pictures and then checking them using the review function.





- Refer to P58 for the available range of the aperture value and the shutter speed.
- You cannot set the following items in manual exposure.
  - Slow sync./Red-eye reduction [] (P41)
  - [AUTO] in ISO sensitivity (P73) (When the recording mode is switched to Manual exposure, the ISO sensitivity is automatically set to [ISO100] even though it was set to [AUTO] beforehand.)
  - Compensating the Exposure (P45)
- The brightness of the LCD may differ from the brightness of pictures you take. Check the picture with review or play mode.
- If the exposure is not adequate, the aperture value and the shutter speed turn red when pressing the shutter button halfway.
- When the shutter speed is slow, we recommend using a tripod.

## ■ Aperture Value and Shutter Speed

### Aperture-priority AE

Available Aperture Value (Per 1/3 EV)			Shutter Speed (Sec.)
F8.0			8 to 1/2000
F7.1	F6.3	F5.6	8 to 1/1600
F4.9	F4.5	F4.0	8 to 1/1300
F3.6	F3.2	F2.8	8 to 1/1000

### Shutter-priority AE

Available Shutter Speed (Sec.) (Per 1/3 EV)				Aperture Value
8	6	5	4	F2.8 to F8.0
3.2	2.5	2	1.6	
1.3	1	1/1.3	1/1.6	
1/2	1/2.5	1/3.2	1/4	
1/5	1/6	1/8	1/10	
1/13	1/15	1/20	1/25	
1/30	1/40	1/50	1/60	
1/80	1/100	1/125	1/160	
1/200	1/250	1/320	1/400	
1/500	1/640	1/800	1/1000	
1/1300				F4.0 to F8.0
1/1600				F5.6 to F8.0
1/2000				F8.0

### Manual exposure

Available Aperture Value (Per 1/3 EV)	Available Shutter Speed (Sec.) (Per 1/3 EV)
F2.8 to F3.6	60 to 1/1000
F4.0 to F4.9	60 to 1/1300
F5.6 to F7.1	60 to 1/1600
F8.0	60 to 1/2000



- The aperture values in the table above are the values, that are available when the zoom lever is rotated to Wide at maximum.
- Some of the aperture values cannot be selected depending on the zoom magnification.

## Motion picture mode



You can record motion pictures with audio.

### 1 Select [PICT.MODE].

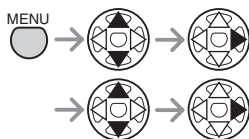
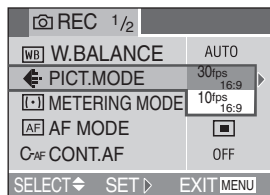

- Close the menu by pressing the shutter button halfway or the [MENU] button after finishing the setting.
- Select either [**16:9**] or [**4:3**]. (P87)  
You cannot shoot motion pictures in the [**3:2**] aspect ratio.

#### ■ In [**16:9**] aspect

<b>30fps16:9</b>	848×480pixels	30fps
<b>10fps16:9</b>	848×480pixels	10fps

#### ■ In [**4:3**] aspect

<b>30fpsVGA</b>	640×480pixels	30fps
<b>10fpsVGA</b>	640×480pixels	10fps
<b>30fpsQVGA</b>	320×240pixels	30fps
<b>10fpsQVGA</b>	320×240pixels	10fps

- [30fpsVGA][30fpsQVGA][30fps16:9]:  
The motion of the recorded picture is smooth, but the file size is large.
- [10fpsVGA][10fpsQVGA][10fps16:9]:  
Recording motion pictures for a longer time is available though the quality will be lower.
- [10fpsQVGA]:  
The file size is smaller, so the files are suitable to be attached to e-mails.

- fps (frame per second); This refers to the number of frames used in 1 second.

### 2 Press the shutter button halfway.

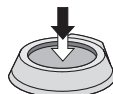
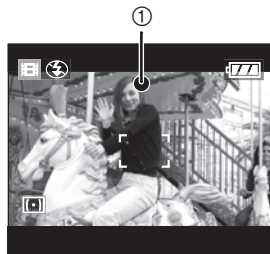

- When the subject is focused, the focus indication ① lights.

### 3 Press the shutter button fully to start the recording.

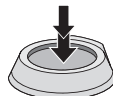

- The remaining recording time (approximation) appears on the screen.
- The audio recording starts simultaneously from the built-in microphone of the camera.
- By pressing the shutter button fully again, the recording stops.
- If the memory card becomes full during recording, the camera stops automatically.

## ■ Available recording time (seconds)

SD Memory Card Capacity	Motion rate					
	30fps VGA	10fps VGA	30fps QVGA	10fps QVGA	30fps 16:9	10fps 16:9
16 MB	6	26	26	83	5	22
32 MB	17	59	59	175	14	50
64 MB	39	120	120	360	33	106
128 MB	83	250	250	740	71	215
256 MB	165	490	490	1440	140	420
512 MB	330	980	980	2870	280	840
1 GB	660	1970	1970	5700	560	1690
2 GB	1350	4020	4020	11700	1160	3450

- The recordable time is an approximation. (Actual times depend on recording conditions and the type of SD card.)
- Recording time depends on the subject.
- The remaining recordable time shown on the LCD may not reduce regularly.
- This camera cannot take motion pictures if you are using a MultiMediaCard.



- The motion pictures cannot be recorded without audio.
- The settings of auto focus/zoom/aperture values are fixed to what they are when recording starts (in the first frame).
- Depending on the type of card you are using, the card access indication may appear for a while after shooting motion pictures. This is normal.
- When you set the [PICT.MODE] to [30fpsVGA] or [30fps16:9], use cards that have a speed of 10 MB/second or better (shown on the card packaging) for best results.
- **Shooting may stop unexpectedly with some types of card or if you use a card whose memory has been fragmented by repeated shooting and erasure. Clean up the card with this unit beforehand for best results (P103).**
- **Use only the genuine SD card with SD Logo.**
- When motion pictures recorded with this camera are played back on other equipment, the quality of pictures and sounds may be deteriorated or it may not be possible to play them back.
- Motion pictures you have recorded at [30fpsVGA], [30fpsQVGA], [30fps16:9], and [10fpsVGA] can only be shown on compatible players.
- In motion picture mode [, you cannot use the direction detection function and the review function.
- You cannot set [MODE2] on the Optical Image Stabilizer function.

## SCN1 SCN2 Scene mode



Set the mode dial to [SCN1] or [SCN2] to display the [SCENE MODE] menu. When [SCENE MENU] (P26) is set to [OFF] in the [SETUP] menu, press the [MENU] button to display the [SCENE MODE] menu.

### Menu items

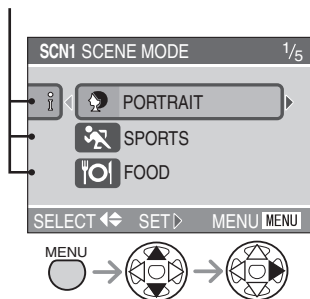

- Press ◀ to see explanations of the scene modes. (Press ▶ to return to the menu.)
- When rotating the zoom lever toward T, the page of the menu screen can be forwarded. (vice versa)
- If you press the [MENU] button while the [SCENE MODE] menu is displayed, you can set the [SETUP] menu (P23) and the [REC] mode menu (P70).

: [PORTRAIT] (P62)

: [SPORTS] (P62)

: [FOOD] (P63)

: [SCENERY] (P63)

: [NIGHT PORTRAIT] (P64)

: [NIGHT SCENERY] (P64)

: [BABY] (P65)

: [SOFT SKIN] (P66)

: [CANDLE LIGHT] (P66)

: [PARTY] (P67)

: [FIREWORKS] (P67)

: [SNOW] (P68)

: [STARRY SKY] (P68)

: [SELF PORTRAIT] (P69)



- The following functions cannot be set in scene mode.
  - White balance (P71)
  - ISO sensitivity (P73)
  - Metering mode (P75)
  - Colour effect (P78)
  - Picture adjustment (P79)
  - AF/AE Lock (P85)
- Use exposure compensation to adjust the brightness of pictures you take.
- The colour of the picture may seem strange if you use a scene mode that is unsuitable for the shot.



## Portrait mode

This mode allows you to make the subject stand out from an unfocused background and adjust the exposure and the hue to achieve a healthy complexion on the subject.

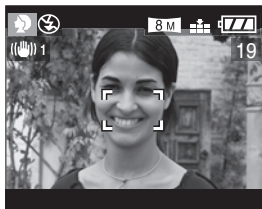

### ■ Technique for Portrait mode

To make this mode more effective:

- 1 Rotate the zoom lever to Tele as far as possible.
- 2 Be close to the subject.
- 3 Select a background which is far from the camera.



- This mode is suitable for outdoors in the daytime.
- The ISO sensitivity is automatically adjusted to the optimal value.



## Sports mode

This mode allows you to take pictures of a fast moving subject. (e.g. When taking pictures of outdoor sports.)



### ■ Technique for Sports mode

To record actions of the subject as if it were still, the shutter speed becomes faster than usual. This mode is more effective when taking pictures in the daytime on a clear day.



- This mode is suitable for outdoors in the daytime, keeping 5 m or more away from the subject.
- The ISO sensitivity is automatically adjusted to the optimal value.

## Food mode

Use this mode to take pictures of food in restaurants, irrespective of the lighting, so that the natural colours of the subject come out.



- The ISO sensitivity is automatically adjusted to the optimal value.

## Scenery mode

This mode allows you to take a picture of a wide landscape. The camera focuses on a distant subject preferentially.



- The focus range is 5 m to  $\infty$ .
- The ISO sensitivity is automatically adjusted to the optimal value.
- The Flash setting is fixed to Forced OFF [].
- The setting on the AF assist lamp is disabled.

## Night portrait mode

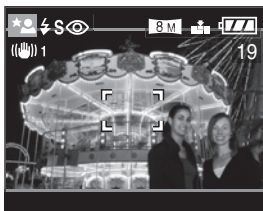

This mode allows you to take pictures against a night landscape. The subject can be recorded with brightness in real life by using the flash and the slow shutter speed.



### ■ Technique for Night portrait mode

- Open the flash. (P40)
- Due to the slow shutter speed, use a tripod and the self-timer (P44) for best results.
- Keep the subject still for about 1 second after taking a picture.
- We recommend taking pictures by rotating the zoom lever to Wide (1x), and being at a distance about 1.5 m from the subject.



- The focus range is 1.2 m to 5 m. (See page 42 for details about the flash control range.)
- The shutter may be kept closed (max. about 1 sec.) after taking a picture with slow shutter speed, but this is not a malfunction.
- When you take pictures in dark places, noises may become visible.
- The flash is set to Slow sync./Red-eye reduction [ S ] and always functions in this mode.
- The ISO sensitivity is automatically adjusted to the optimal value.
- You cannot use [CONT.AF] while in this mode.
- [PLEASE OPEN THE FLASH] appears when the flash is closed.

## Night scenery mode

This mode allows you to take a picture of a nightscape. The landscape can be recorded vividly by using the slow shutter speed.



### ■ Technique for Night scenery mode

- Use a tripod as the shutter may be open for as long as 8 seconds. Use the self-timer for best results. (P44)



- The focus range is 5 m to  $\infty$ .
- The shutter may be kept closed (max. about 8 seconds) after taking a picture with slow shutter speed, but it is not a malfunction.
- When you take pictures in dark places, noise may become visible.
- The Flash setting is fixed to Forced OFF [].
- The ISO sensitivity is fixed to [ISO80].
- The settings on the AF assist lamp is disabled.
- You cannot use [CONT.AF] while in this mode.



## Baby mode

This mode adjusts the exposure and tone to bring out the healthy colour of your baby's skin. The flash will be weaker than normal if you choose to use it.

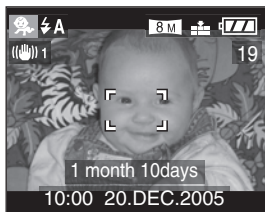

- You can also enter your baby's age so that it appears when you are showing the picture later.



### ■ Age display setting

- To show age, first enter the birthday, select [WITH AGE], and press **▶**.
- To not show age, select [WITHOUT AGE], and press **▶**.

### ■ Birthday setting

- Select [BIRTHDAY SET.] and press **▶**.
  - [PLEASE SET THE BIRTHDAY OF THE BABY] appears on the display. Select year/month/day with **◀/▶**, then change the date with **▲/▼**.
  - Press [MENU] to exit.
- If you select [WITH AGE] but you haven't set the birthday, a message appears. Press [MENU] and follow steps ② and ③ to enter the birthday.



- The ISO sensitivity is automatically adjusted to the optimal value.
- Whenever you turn the camera on in Baby mode or switch to Baby mode from any other scene mode, your baby's age and the current date and time appear on the display for about 5 seconds.
- Actual age displays depend on the [LANGUAGE] setting.
- The display on the actual day of your baby's birth will be 0 months 0 days.
- Check the clock and birthday settings if the age shown is incorrect.
- Note that if you have selected [WITHOUT AGE], age information will not be recorded for any pictures you take. The information will not appear even if you select [WITH AGE] after taking pictures.
- For resetting the birthday setting, use [RESET] in the [SETUP] menu. (P25)

### **Soft skin mode**

This mode helps you take pictures that make the skin of your subject appear smoother. Use this mode when taking portraits from the chest up.

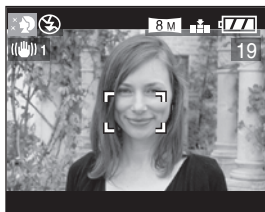

#### ■ **Technique for Soft skin mode**

To make this mode more effective:

- 1 Rotate the zoom lever to Tele as far as possible.
- 2 Be close to the subject.
- 3 Select a background which is far from the camera.



- This mode is suitable for outdoors in the daytime.
- The ISO sensitivity is automatically adjusted to the optimal value.
- If there are other flesh-coloured elements in the shot, they will also be softened.
- The effect may not be as obvious if there isn't enough light.

### **Candle light mode**





Use this mode to get the most from the mood created by candlelight.



#### ■ **Technique for Candle light mode**

- This is most effective if you don't use the flash.
- Use a tripod and the self-timer (P44) for best results.
- Shoot with the zoom lever at W (wide) for best results.



- The flash mode can be set to Forced ON/ Red-eye reduction [ ] or Slow sync./ Red-eye reduction [  ].
- The ISO sensitivity is automatically adjusted to the optimal value.

## Party mode

Select this mode when you want to take pictures at wedding receptions, indoor parties, etc.





Both the people and the background can be recorded with brightness in real life by using the flash and slowing down the shutter speed.



### ■ Technique for Party mode

- Open the flash. (P40)
- Due to the slow shutter speed, use a tripod and the self-timer (P44) for best results.
- We recommend taking pictures by rotating the zoom lever to Wide (1×), and being at a distance about 1.5 m from the subject.



- The flash mode can be set to Forced ON/ Red-eye reduction [ ] or Slow sync./ Red-eye reduction [  ].
- The ISO sensitivity is automatically adjusted to the optimal value.

## Fireworks mode

This mode allows you to take beautiful pictures of fireworks exploding in the night sky. The shutter speed or the exposure is automatically adjusted for taking pictures of fireworks.

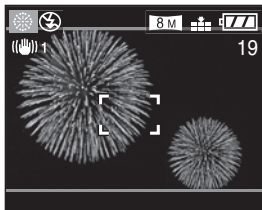

### ■ Technique for Fireworks mode

- We recommend using a tripod.



- This mode is most effective on subjects that are 10 m or more from the camera.
- The Flash setting is fixed to Forced OFF [].
- The settings on the AF assist lamp is disabled.
- You cannot change the AF mode setting.
- The ISO sensitivity is automatically adjusted to the optimal value.
- You cannot use [CONT.AF] while in this mode.

## Snow mode

This mode allows you to take a picture in locations such as skiing resorts and locations near snowy mountains. The exposure and the white balance are adjusted to make the white colour of the snow stand out.



- The ISO sensitivity is automatically adjusted to the optimal value.

## Starry sky mode

Choose this setting to take clear pictures of the night sky. The slow shutter speed makes the stars sparkle. You can choose a shutter speed of 15, 30, or 60 seconds.



### ■ Technique for Starry sky mode

- Due to the slow shutter speed, use a tripod and the self-timer (P44) for best results.

## ■ Setting the shutter speed

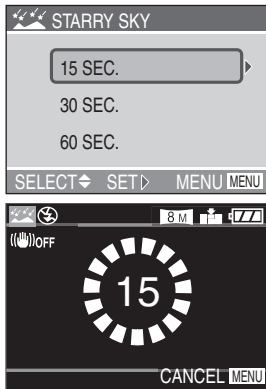

- Press ▲/▼ to select the shutter speed, then press ►.
- The countdown screen appears when you press the shutter button. Do not move the camera. After the countdown is finished, [PLEASE WAIT...] is displayed for the same amount of time as the shutter speed you used. This is to process the signals.
- The shooting is cancelled when you press the [MENU] button while the countdown screen is displayed.



- The Flash setting is fixed to Forced OFF .
- The stabilizer function is fixed to [OFF]. (P47)
- The ISO sensitivity is fixed to [ISO80].
- You cannot use [CONT.AF] while in this mode.
- You cannot use exposure compensation, auto bracket mode, burst mode, or recording audio.
- The histogram is always orange. (P29)

## Self portrait mode

This mode allows you to take a picture of yourself.



### ■ Technique for Self-portrait mode

- When you are focused by pressing the shutter button halfway, the self-timer indicator lights up. Fix the camera firmly and then press the shutter button fully.

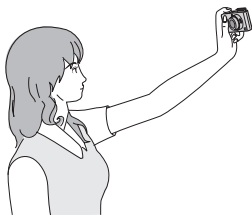

- A blinking self-timer lamp indicates that the camera has not focused. Press the shutter button halfway again to focus.
- The captured picture automatically appears on the LCD monitor for reviewing. Refer to P37 for operations on the review function.
- When the picture may be blurred by slow shutter speed, we recommend using the 2 seconds self-timer. (P44)



- The available focus range is 30 cm to 70 cm.
- You can take a picture of yourself with audio (P75). In this time, the self-timer indicator lights up while recording the audio.
- When you select self-portrait mode [], the zoom lever is automatically moved to Wide (1 $\times$ ).
- The self-timer can be set to [OFF] or [2SEC.]. (P44) When you set to [2SEC.], it is kept until the camera is turned [OFF] or you switch the mode.
- The stabilizer function is fixed to [MODE2]. (P47)
- The setting on the AF assist lamp is disabled.
- The AF mode is fixed to 9-area-focusing. (P76)
- The ISO sensitivity is automatically adjusted to the optimal value.

# Using the [REC] mode menu



Setting the hue, picture quality adjustment, etc. allows you to create wide variations on taking pictures.

- Set the mode dial to the desired recording mode.

## Menu items

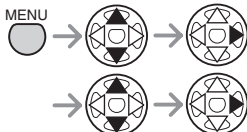
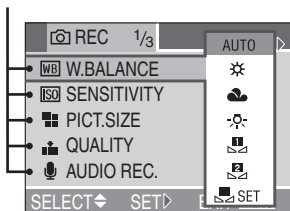

- The menu items depend on the selected recording mode.
- When rotating the zoom lever toward T or W, the page of the menu screen can be forwarded or reversed.
- Close the menu by pressing the shutter button halfway or the [MENU] button after finishing the setting.

**[WB]** : [W.BALANCE] (P71)

**[ISO]** : [SENSITIVITY] (P73)

**[PICT.SIZE]** (P73)

**[QUALITY]** (P74)

**[AUDIO REC.]** (P75)

**[METERING MODE]** (P75)

**[AF MODE]** (P76)

**[CONT.AF]** (P77)

**[AF ASSIST LAMP]** (P77)

**[AF/AE LOCK]** (P85)

**[D.ZOOM]** (P78)

**[COL.EFFECT]** (P78)

**[PICT.ADJ.]** (P79)







**[FLIP ANIM.]** (P79)

For setting, see page 70.

## [WB] White Balance [W.BALANCE]

### P A S M

This function allows you to reproduce a white colour closer to the tone in real life on the pictures recorded under sunlight, halogen lighting, etc. in which the white colour may appear reddish or bluish.

AUTO	for auto setting (auto white balance)
 (Daylight)	for recording outdoors on a bright day
 (Cloudy)	for recording under a cloudy or shaded area sky
 (Halogen)	for recording under halogen lighting
 (White set 1)	for using the preset white balance
 (White set 2)	for using the preset white balance
 SET (White set)	for using set mode 1 or 2 with a different white balance setting (P72)

- When setting the white balance to the mode except [AUTO], you can finely adjust the white balance. (P72)
- This is fixed to [AUTO] in Auto mode [A].

## ■ Auto White Balance

Use of auto white balance adjustment in inappropriate lighting conditions may result in reddish or bluish pictures. Where the subject is surrounded by many light sources, auto white balance adjustment may not operate properly.

In this case, set the white balance to a mode except [AUTO] manually.



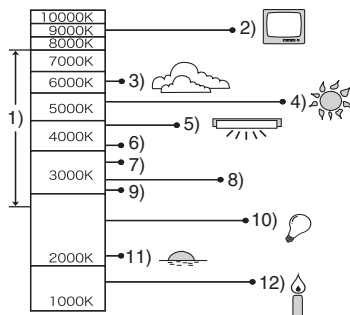



- 1 The range that is controlled by the auto white balance adjustment mode of this camera
- 2 TV screen
- 3 Cloudy sky (Rain)
- 4 Sunlight
- 5 White fluorescent light
- 6 2 hours after dawn and before sunset
- 7 1 hour after dawn and before sunset
- 8 Halogen lamp
- 9 30 minutes after dawn and before sunset
- 10 Incandescent light bulb
- 11 Sunrise and sunset
- 12 Candlelight



K=Kelvin Colour Temperature

## ■ Setting the White Balance manually (White set SET)







Use this mode when you want to set the white balance manually.

- 1 Set to [ SET] (White Set) and then press .
- 2 Select [] (White set 1) or [] (White set 2) and then press .
- 3 Aim the camera at a sheet of white paper or a similar white object so that the frame on the centre of the screen turns white and then press .





## ■ Finely Adjusting the White Balance (White Balance Fine Adjustment WB+)

When you cannot acquire the desired hue by setting the white balance, you can adjust the white balance finely.

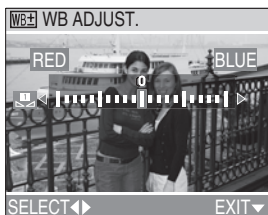

- 1 Set the white balance to [] / [] / [] / [] / []. (P71)
- 2 Press  several times until [ WB ADJUST.] appears.





- 3 Finely adjust the white balance.
  -  [BLUE]: Press when the hue is reddish.
  -  [RED]: Press when the hue is bluish.



## About the white balance

- This is fixed to [AUTO] in Auto mode [].
- When taking a picture with the flash, the white balance will be automatically adjusted [except for [] (Daylight)], but the white balance may not be properly adjusted if the photo flash is insufficient.

## About the white balance fine adjustment

- The white balance icon on the screen turns red or blue if you have performed white balance fine adjustment.
- You can set the value independently for each of the modes in white balance.
- The setting on the fine adjustment of the white balance is reflected to the picture when taking a picture with the flash.
- If you change the white balance setting for set mode [ SET], the white balance fine adjustment values for [] and [] return to "0".
- When the colour effect is set to any of [COOL], [WARM], [B/W] or [SEPIA] (P78), you cannot finely adjust the white balance.

## About the white set

- After starting white set, do not move the camera or the subject until you return to the menu.



For setting, see page 70.

## ISO Sensitivity [SENSITIVITY]

### PASM

ISO sensitivity represents the sensitivity to light in values. If you set the ISO sensitivity higher, the camera becomes more suitable for recording in dark places.

- When setting to [AUTO], the ISO sensitivity is automatically adjusted from [ISO80] to [ISO200] according to the brightness. (It can be adjusted from [ISO100] to [ISO400] when using the flash.)

ISO sensitivity	80 ←————→ 400	
Use in bright places (e.g. outdoors)	Suitable	Not suitable
Use in dark places	Not suitable	Suitable
Shutter speed	Slow	Fast
Noise	Less	Increased



- In Auto mode [A], motion picture mode [M] or scene mode (P61), ISO sensitivity is fixed to [AUTO]. (In [NIGHT SCENERY], [SOFT SKIN] and [STARRY SKY] in scene mode, it is fixed to [ISO80].)
- To avoid picture noises, we recommend reducing the ISO sensitivity or setting [NOISE REDUCTION] in [PICT.ADJ.] to [HIGH] to take pictures. (P79)

For setting, see page 70.

## Picture Size [PICT.SIZE]

### APASM SCN1 SCN2

Select a higher number of pixels for clearer pictures when printing.

Select a lower number of pixels to store more pictures on the card. Fewer pixels also means it is easier to send pictures by e-mail or use them on a homepage.

#### When the aspect ratio setting is [16:9]

8M	3840×2160 pixels
5.5M <b>EZ</b>	3072×1728 pixels
2M <b>EZ</b>	1920×1080 pixels

#### When the aspect ratio setting is [3:2]

7M	3248×2160 pixels
4.5M <b>EZ</b>	2560×1712 pixels
2.5M <b>EZ</b>	2048×1360 pixels

#### When the aspect ratio setting is [4:3]

6M	2880×2160 pixels
4M <b>EZ</b>	2304×1728 pixels
3M <b>EZ</b>	2048×1536 pixels
2M <b>EZ</b>	1600×1200 pixels
1M <b>EZ</b>	1280×960 pixels

- Refer to P59 when using motion picture mode [M].



- EZ is an abbreviation for Extra Optical Zoom. (P88)
- Pictures may appear like a mosaic depending on the subject or the recording condition.
- The number of recordable pictures depends on the subject.
- The number of remaining pictures may not correspond with recorded frames.
- Refer to P18 to 20 for the number of recordable pictures.

For setting, see page 70.





## Quality [QUALITY]



## A P A S M SCN1 SCN2

You can select 4 types of quality (compression rate) according to the usage of the picture.

<b>TIFF</b>	<p>TIFF (Uncompressed): This type is suitable when editing and processing pictures with retouch software.</p>
	<p>Fine (Low compression): This type gives priority to picture quality. Picture quality will be high.</p>
	<p>Standard (High compression): This type gives priority to the number of recordable pictures and records standard quality pictures.</p>
<b>RAW</b>	<p>RAW (Uncompressed): This type is suitable when editing and processing pictures with a computer.</p>



- When the quality is set to [TIFF] or [RAW], a JPEG picture with the quality equal to the Standard [] is created at the same time. The JPEG file is also erased if you erase the associated TIFF/RAW file.
- The maximum resolution (P73) for each aspect ratio is fixed if you select [RAW].
- You cannot use the digital zoom if you have selected [RAW].
- Pictures may have a mosaic-like appearance depending on the subject or the recording condition.
- The number of recordable pictures depends on the subject.
- The number of remaining pictures may not correspond with recorded frames.
- The following functions cannot be used for pictures recorded in [TIFF] or [RAW].
  - Auto bracket
  - Burst mode
  - [AUDIO REC.]
  - [AUDIO DUB.]
  - [RESIZE]
  - [TRIMMING]
- Refer to P18 to 20 for the number of recordable pictures.
- You can process [RAW] format files with [Photoshop Elements 3] (on the included CD-ROM). Use your computer to do processing beyond what this camera is able.
- For advanced photograph processing, use software compatible with the LEICA D-LUX 2's RAW format, such as Adobe Photoshop CS (with RAW plugin). For more information about Adobe products, visit <http://www.adobe.com/>.

For setting, see page 70.

## Audio Recording [AUDIO REC.]

### P A S M

You can take a picture with audio.





- When you set [AUDIO REC.] to [ON],  appears on the screen.
- When you start recording by focusing on the subject and pressing the shutter button, the audio recording will be automatically stopped in 5 seconds. There is no need to keep pressing the shutter button.
- Audio is recorded from the built-in microphone of the camera.
- If you press the [MENU] button during the audio recording, the audio recording will be cancelled. The audio cannot be recorded.
- You cannot record pictures with audio in auto bracket, burst mode, when the quality is set to [TIFF] or [RAW], or [STARRY SKY] in scene mode (P68).



For setting, see page 70.

## Metering Mode [METERING MODE]

### P A S M

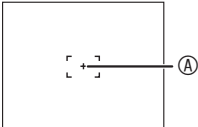
You can switch to the following metering modes.









	<p><b>Multiple:</b> This is the method in which the camera measures the most suitable exposure by judging the allocation of brightness on the whole screen automatically. Usually, we recommend using this method.</p>
	<p><b>Centre weighted:</b> This is the method used to focus on the subject on the centre of the screen and measure the whole screen evenly.</p>
	<p><b>Spot:</b> This is the method to measure the subject in the spot metering target .</p> 

- This is fixed to Multiple  in Auto mode .

For setting, see page 70.

**AF** AF Mode [AF MODE]

**PASM**  SCN1 

	<p><b>9-area-focusing:</b> The camera focuses on any of 9 focus areas. You can record a picture in free composition without limiting the position of the subject.</p> 
	<p><b>3-area-focusing (high speed):</b> The camera focuses on any of the left, centre or right areas of the screen.</p> 
	<p><b>1-area-focusing (high speed):</b> The camera focuses on the subject in AF area on the centre of the screen.</p> 
	<p><b>1-area-focusing:</b> The camera focuses on the subject in AF area on the centre of the screen.</p> 



**Spot-focusing:**

The camera focuses on the limited and narrow area in the screen.

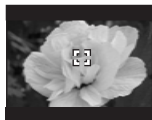

### ■ High speed AF (H) mode

- When you select 3-area-focusing (high speed) or 1-area-focusing (high speed), the auto focus is activated in high speed and you can focus on the subject more quickly.
- Pictures may become still in the condition they were in before the subject was focused when you press the shutter button halfway. However, it is not a malfunction. If you do not want to make pictures still during the auto focus, use the AF mode other than 3-area-focusing (high speed) mode and 1-area-focusing (high speed) mode.



- When using the digital zoom or when you take pictures in dark places, the AF area is displayed on the centre of the screen with a size wider than usual.
- When multiple AF areas (max. 9 areas) light at the same time, the camera is focusing on all the AF areas.  
The focus position is not predetermined because it is set to the position the camera automatically determines at the time of focusing. If you want to determine the focus position to take pictures, switch the AF mode to 1-area-focusing, 1-area-focusing (high speed) or Spot-focusing mode.
- You cannot change the AF mode setting when using [FIREWORKS] or [SELF PORTRAIT] in scene mode (P61).
- This is fixed to 1-area-focusing in Auto mode [**A**].

For setting, see page 70.

## CAF Continuous AF [CONT.AF]

### PASM [SCN1] [SCN2]

This mode allows you to compose a picture more easily by always focusing on the subject.

When the AF mode is set to 1-area-focusing, 1-area-focusing (high speed) or spot-focusing, the time required for focusing when pressing the shutter button halfway will be reduced.

- When it is set to [ON], the [CAF] indication appears.



- The battery may be consumed faster than usual.
- It may take time to focus on the subject after rotating the zoom lever from Wide to Tele or suddenly changing the subject from a distant one to a nearby one.
- Press the shutter button halfway again when it is difficult to focus on the subject.
- You cannot use this with the scene modes (P61) [STARRY SKY], [FIREWORKS], [NIGHT PORTRAIT], or [NIGHT SCENERY].
- If the focus switch is set to [AF], the time to focus will not be shorter.

For setting, see page 70.

## AF\* AF Assist Lamp [AF ASSIST LAMP]

### PASM [SCN1] [SCN2]

Illuminating the subject with the AF assist lamp allows the camera to focus on the subject in low light conditions.

When you press the shutter button halfway in dark places or other situations, an AF area wider than usual appears and the AF assist lamp ① turns on.

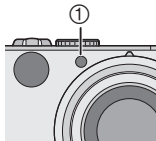

ON	The AF assist lamp turns on under low light conditions. In this time, the AF assist lamp icon [AF*] appears on the screen. The effective range of the AF assist lamp is 1.5 m.
OFF	The AF assist lamp does not turn on.



- Be sure of the following points when the AF assist lamp is in use.
  - Do not look into the AF assist lamp closely.
  - Do not cover the AF assist lamp with your fingers or other objects.
- AF assist lamp is fixed to [ON] in Auto mode [A].
- You cannot use the AF assist lamp in [SCENERY], [NIGHT SCENERY], [FIREWORKS] and [SELF PORTRAIT] in scene mode. (P61)
- When you do not want to use the AF assist lamp (e.g. when you take a picture of a subject in a dark place), set the [AF ASSIST LAMP] to [OFF]. In this case, it becomes difficult to focus on the subject.
- The AF area (P76) is set only to a point on the centre of the screen when the AF assist lamp is turned on.

For setting, see page 70.

## Digital Zoom [D.ZOOM]



It is possible to further magnify a subject already magnified 4 times with the optical zoom 4 more times with the digital zoom, thereby reaching a maximum of 16 times. (You can still use the extra optical zoom.) For details about the extra optical zoom, see page 88.

### ■ Entering the digital zoom range

When you rotate the zoom lever to the extreme Tele position, the on-screen zoom indication may momentarily pause. You can enter the digital zoom range to continuously rotate the zoom lever to Tele or to release the zoom lever once and then rotate it to Tele again.

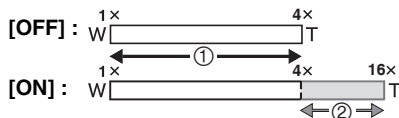

- ① Optical zoom
- ② Digital zoom



- When using the digital zoom, the picture quality becomes deteriorated.
- In the digital zoom range, the stabilizer function may not be effective.
- When using the digital zoom, use a tripod and the self-timer (P44) for best results.
- The AF area is displayed with a size wider than usual and set only to a point on the centre of the screen in the digital zoom range.
- If you set the [QUALITY] to [RAW] (P74), the digital zoom turns off. When you switch to a different [QUALITY] setting, the digital zoom setting before you selected [RAW] is restored.

For setting, see page 70.

## Colour Effect [COL.EFFECT]



You can use 4 types of colour effects depending on the image of the picture.

COOL	The picture becomes bluish.
WARM	The picture becomes reddish.
B/W	The picture becomes black and white.
SEPIA	The picture becomes sepia.

For setting, see page 70.

 **Picture Adjustment [PICT.ADJ.]**

**P A S M**

Use this function according to the recording situation and the atmosphere of the picture.

CONTRAST	HIGH	Increases the difference between the brightness and the darkness in the picture.
	LOW	Decreases the difference between the brightness and the darkness in the picture.
SHARPNESS	HIGH	The picture is sharply defined.
	LOW	The picture is softly focused.
SATURATION	HIGH	The colours in the picture become vivid.
	LOW	The colours in the picture become natural.
NOISE REDUCTION	HIGH	The noise reduction effect is enhanced. The resolution of the picture may be slightly deteriorated.
	LOW	The noise reduction effect is reduced. You can obtain pictures with higher resolution.



- When you take pictures in dark places, noise may become visible. To avoid picture noise, we recommend setting [NOISE REDUCTION] in [PICT.ADJ.] to [HIGH] or setting the items except [NOISE REDUCTION] to [LOW] to take pictures.
- In Auto mode [**A**], you cannot use [PICT.ADJ.].

For setting, see page 70.

 **Flip Animation [FLIP ANIM.]**

**P A S M** **SCN1** **SCN2**

This camera allows you to create motion picture files up to 20 seconds long by connecting pictures recorded in flip animation mode.

Example:

When capturing pictures of the subject in sequence moving the camera little by little and aligning the pictures, the subject looks as if it is moving.

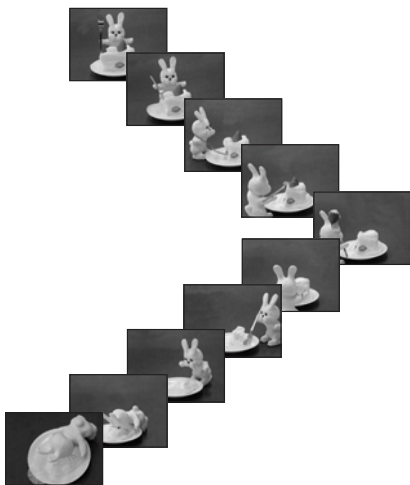

## 1 Select [FLIP ANIM.].

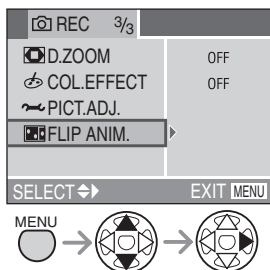

- A motion picture file is created by putting pictures recorded in [PICTURE CAPTURE] together by [CREATE MOTION PICTURE].
- Audio cannot be recorded.
- You cannot record audio using the audio dubbing. (P98)

## 2 Select [PICTURE CAPTURE].

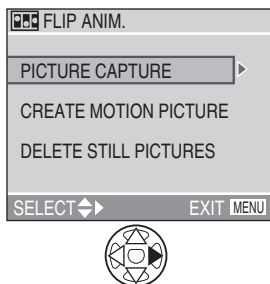

- The picture size is 320x240 pixels.

## 3 Capture pictures for flip animation.

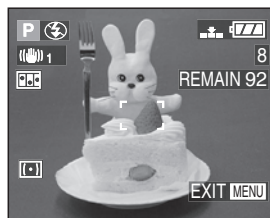

- You can check the recorded picture with ▼ and the previous or following picture with ◀▶.
- Delete unnecessary pictures with [🗑️] button.
- You can record up to 100 pictures. The number of recordable pictures displayed is an approximation.

## 4 Select [CREATE MOTION PICTURE].

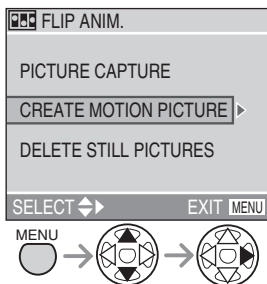



## 5 Select [FRAME RATE] and set the number of frames.

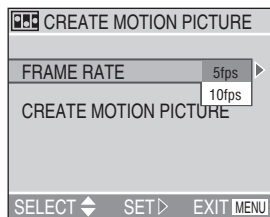

5fps	5 frames/sec.
10fps	10 frames/sec. (The motion pictures become smoother.)

## 6 Select [CREATE MOTION PICTURE] and create a flip animation.

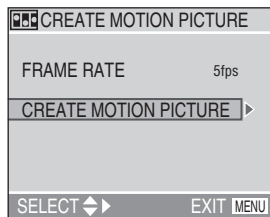

3 times

- The file number appears after creating a flip animation.

## ■ Playing back created flip animations

- You can play back created flip animations with the same method used to play back motion pictures. (P89)

## ■ Deleting all still pictures used to create flip animation

When selecting [DELETE STILL PICTURES] in [FLIP ANIM.] menu, a confirmation screen appears. Select [YES] with  $\blacktriangledown$  and then press  $\blacktriangleright$ .



- You cannot use pictures with audio, burst mode and auto bracket and the direction detection function.
- The pictures in each frame do not appear in normal review. (P37)
- If you execute [CREATE MOTION PICTURE], flip animation is made from all pictures recorded for flip animation. Delete unnecessary pictures.
- Flip animations may not be played back by other equipment.
- The audio is not recorded on flip animations, however, you may hear varying levels of noises when you play back flip animations with other equipment which does not have a mute function.

# Using the Quick setting



You can change the following with the joystick when recording.

- [W.BALANCE] (P71)
- [SENSITIVITY] (P73)
- [PICT.SIZE] (P73)
- [QUALITY] (P74)
- [PICT.MODE] (P59)



- The menu items depend on the selected recording mode.

- 1 Press and hold the joystick to show the shortcut menu in recording mode.

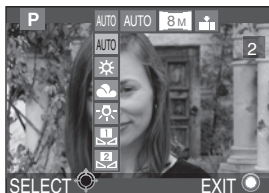

- The Quick setting menu appears.

- 2 Select the menu and press to enter.

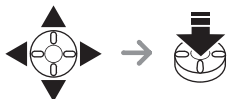
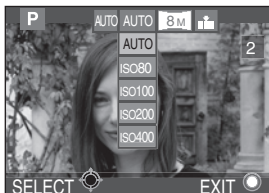

# Taking Pictures with Manual Focus

## 1 Slide the focus switch to [MF].

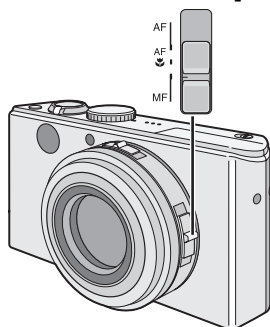

- AF: Auto focus
- AF : Macro mode
- MF: Manual focus

## 2 Move the joystick ◀/▶ to select [MF], then move the joystick ▲/▼ to focus.

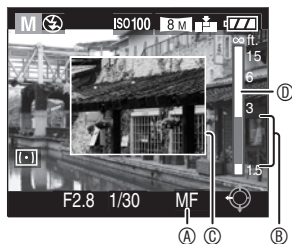

- Ⓐ : MF indication
- Ⓑ : Focal distance
- ▲ : Further
- ▼ : Closer
- The manual focusing assistant Ⓒ appears.
- The MF assistant disappears 2 seconds after you stop operating the joystick.
- The moving focus indication Ⓓ disappears 5 seconds after you stop operating the joystick.

## 3 Take the picture.

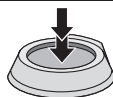

## MF assistance

Move the joystick ▲/▼ while [MF ASSIST] is set to [MF1] or [MF2] to enlarge the picture to help focusing. (P24)

- [MF1]: The centre area of the picture is enlarged. You can focus while considering the overall composition of the picture.



- [MF2]: The whole picture is enlarged. You can easily focus when you are not sure of the focus at Wide.



- You can set the MF assistant to [OFF] in the [SETUP] menu (in the recording mode). (P24)

## Technique for Manual focus



- 1 Move the joystick ▲/▼.
- 2 Even if the subject is focused, move it a little more.
- 3 Return to the centre to make fine adjustments.

## Prefocus

This is a technique to focus on the point to take pictures in advance when it is difficult to focus on the subject with auto focus due to its quick motion.

This function is suitable when the distance between the camera and the subject is certain.



- You can also record with manual focus in motion picture mode [M]. When starting the recording, the focus is fixed.
- When you focus on the subject in Wide, the focus may not be adequate in Tele. In this case, focus on the subject again.
- When setting the manual focus, you cannot set the continuous AF (P77).
- The MF assistance does not appear in digital zoom range.
- The distance shown shows roughly how far away the point of focus is.
- Use the MF assistant to make final adjustments to the focus.
- The AF lock is released when you select manual focus.

# AF/AE Lock (AF: Auto focus/AE: Auto exposure)

Locking the focus is useful when the subject is outside of the AF area of the shot you want to take. Locking the exposure is useful if there is extreme contrast in the shot and you cannot get the best exposure.

- 1 Select [AF/AE LOCK] from the [REC] menu to select [AF], [AE] or [AF/AE].

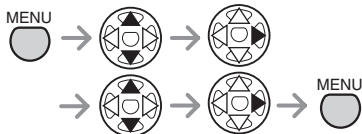
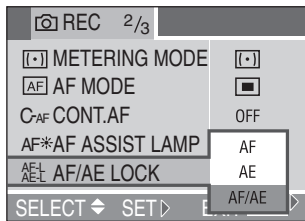

- AF : Auto focus locked
- AE : Auto exposure locked
- AF/AE : Both locked

- 2 Press [AF/AE LOCK] button .

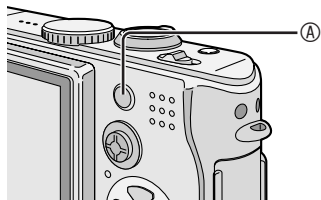

- [AF-L], [AE-L] or [ $\frac{AF-L}{AE-L}$ ] appears on the LCD.

## ■ AF/AE Lock

- 1 Aim the AF area at the subject.
- 2 Press the [AF/AE LOCK] button to fix the focus and exposure. (To cancel, press the [AF/AE LOCK] button again.)
  - The focus and exposure indicators light if they are correct.
- 3 Move the camera back to the shot you want to take and press the shutter button fully.

## ■ AF Lock

- 1 Aim the AF area at the subject.
- 2 Press the [AF/AE LOCK] button to fix the focus. (To cancel, press the [AF/AE LOCK] button again.)
  - The focus indicator lights if it is correct.
- 3 Move the camera back to the shot you want to take and press the shutter button fully.

## ■ AE Lock

- 1 Aim the AF area at the subject.
- 2 Press the [AF/AE LOCK] button to fix the exposure. (To cancel, press the [AF/AE LOCK] button again.)
  - The exposure indicator lights if it is correct.
- 3 Move the camera back to the shot you want to take and press the shutter button fully.



- Only the AE lock is effective when you are using manual focus.

# AF Macro mode

This mode allows you to take close-up pictures of the subject, e.g. When taking pictures of flowers.

You can take pictures approaching the subject at a distance up to 5 cm from the lens by rotating the zoom lever upmost to Wide (1x).

## 1 Select [AF ] with the focus switch.

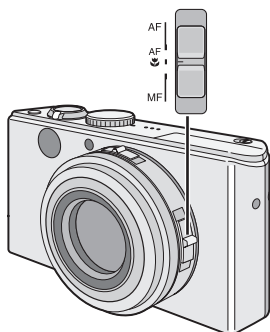

- AF: Auto focus
- AF : AF Macro mode
- MF: Manual focus

## ■ Focus range

- Normal

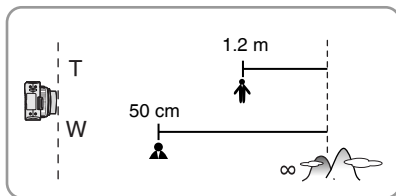

- [AF ]

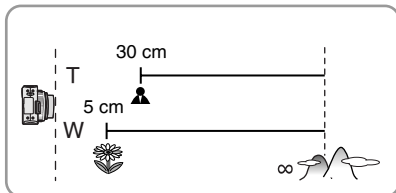

- Use a tripod and the self-timer (P44) for best results.
- When the subject is close to the camera, the effective focus range (depth of field) is significantly narrowed. Therefore, you will have difficulty in focusing on the subject if the distance between the camera and the subject is changed after focusing on the subject.
- When the camera lens is at a distance beyond the available range from the subject, the subject may not be focused even if the focus indicator lights.
- The available flash range is about 60 cm to 4.1 m (Wide). (This is applied when you set the ISO sensitivity to [AUTO].)
- It is normal for the resolution of the edges of pictures taken with [AF ] at short distances to be lower.

## Setting the aspect ratio

Aspect ratio is the ratio of the width and the height of the picture. This camera gives you three aspect ratios to choose from.

- **16:9**
- **3:2**
- **4:3**

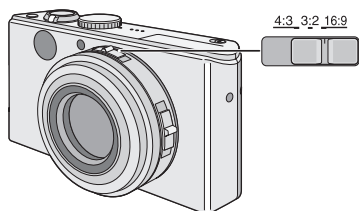

- You cannot shoot motion pictures in the **[ 3:2 ]** aspect ratio.
- Depending on the aspect ratio setting, the edges of the picture may be cut off when printing. Try the following to see whether you can print without cutting the edges off.
  - Some photography shops can handle pictures shot in the **[ 16:9 ]** aspect ratio. Enquire before sending them for printing.
  - If your printer has trimming and border settings, change the settings so that there is no trimming and no border. (Read your printer's operating instructions.)

# Shooting with the extra optical zoom

The camera's optical zoom can normally give you a telephoto zoom of 4 times, but by choosing a resolution that has an EZ suffix, for example 5.5M **EZ**, the extra optical zoom starts functioning and zoom extends as follows. (The example uses [16:9] aspect ratio.)

- Set the resolution. (P73)

## 1 Move the zoom lever toward T.



### ■ When the extra optical zoom isn't working

For example: Resolution is 8M



### ■ When the extra zoom is working

For example: Resolution is 5.5M **EZ**



### ■ Resolution and maximum zoom

Aspect ratio	Pixels	Maximum zoom
16:9	8M	4x
	5.5M <b>EZ</b> /2M <b>EZ</b>	5x
3:2	7M	4x
	4.5M <b>EZ</b> /2.5M <b>EZ</b>	5.1x
4:3	6M	4x
	4M <b>EZ</b>	5x
	3M <b>EZ</b> /2M <b>EZ</b> / 1M <b>EZ</b>	5.6x

### ■ How the extra optical zoom works

- The extra optical zoom works by extracting the centre of the picture and expanding it for a higher telephoto effect. So, for example, if you choose [5.5M **EZ**], 5.5 million pixels (out of the total [8M], 8 million possible with the CCD) are taken in your shot.



- The extra optical zoom allows you to increase the zoom ratio without the reduction in picture quality you get with digital zoom.
- The [**EZ**] icon appears when you zoom while using a resolution that can use the extra optical zoom.
- You can zoom in even further by using this in combination with the digital zoom. In the [REC] mode menu, set digital zoom to ON. (P78)
- The extra optical zoom does not work in the motion picture mode [**MOV**].



# Playing Back Pictures with Audio/Motion pictures



## ■ Pictures with audio

Select the picture with audio icon 





Ⓐ and play back the audio.





## ■ Motion pictures

Select the picture with the motion picture icon Ⓑ and play back the motion pictures.



- The cursor displayed during playback corresponds to   .
- Motion picture playback stops and the normal playback is restored by pressing .

## ■ Fast forwarding/Fast rewinding

During motion picture playback, keep pressing  .

: Fast forward

: Fast rewind

- When releasing the button, it turns to normal motion picture playback.

## ■ To pause

Press  during motion picture playback.

- Press  again to cancel pause.



## • You can hear audio from the speaker.

To adjust the sound volume, refer to P25.

- You cannot use the zoom function while playing back or pausing motion pictures.
- The file format that can be played back with this camera is QuickTime Motion JPEG.
- Some QuickTime Motion JPEG files recorded by a PC or other equipment may not be played back with this camera.
- When playing back motion pictures that have been recorded with other equipment, the quality of pictures may be deteriorated or it may not be possible to play them back.
- When using a high capacity card, it is possible that fast rewinding may be slower than usual.

## Using the [PLAY] mode menu



The play mode menu offers you various ways to play and edit your pictures.

### Menu items

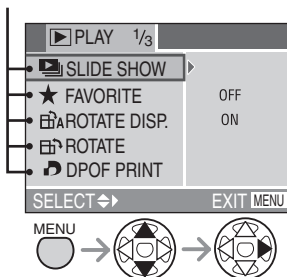

- When rotating the zoom lever toward T, the page of the menu screen can be forwarded. (vice versa)
- After selecting the item, change the settings as described on the following pages.

: [SLIDE SHOW] (P91)

: [FAVORITE] (P92)

: [ROTATE DISP.] (P93)

: [ROTATE] (P94)

: [DPOF PRINT] (P95)

: [PROTECT] (P97)

: [AUDIO DUB.] (P98)

: [RESIZE] (P99)

: [TRIMMING] (P100)

: [ASPECT CONV.] (P102)

: [CLEAN UP] (P103)

: [FORMAT] (P103)

For menu operations, see page 90.

## Playing Back with Slide Show [SLIDE SHOW]

### 1 Select [ALL] or [★].

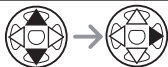
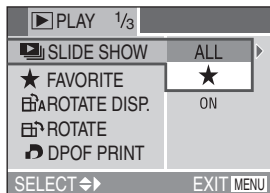

ALL	For playing back all pictures
★	For showing pictures in your favorites list

- See page 92 for instructions on how to add pictures to your favorites list.
- Start from step 2 if [FAVORITE] is set to [OFF].

### 2 Set the items of the Slide Show.

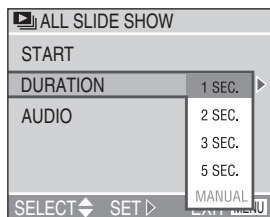

DURATION	Select intervals of 1, 2, 3, 5 seconds or MANUAL.
AUDIO	By setting it to [ON], the audio from pictures recorded with audio can be played back during Slide Show.

- You can select [MANUAL] if you have selected [★] in step 1.

### 3 Select [START].

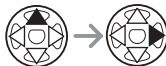
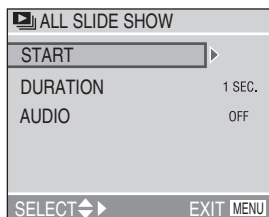

Move between pictures with ◀/▶ if you have chosen [MANUAL]. You can also use the joystick to check the picture.

- ◀: The previous picture
- ▶: The next picture

### 4 By pressing the [MENU] button, the Slide Show stops.



- In motion picture playback, Slide Show is not available.
- When you set [AUDIO] to [ON] and then play back a picture with audio, the picture changes when the audio finishes.

For menu operations, see page 90.

## ★ Favorites setting [FAVORITE]

### 1 Select [ON] to set it.

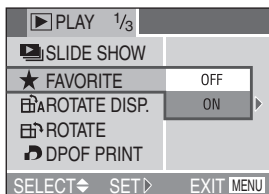

### 2 Press ▲ during playback to place the picture in your favorites list.



#### (A) Favorites indicator

- To cancel the favorite setting, press ▲ to clear [★].

■ For details about using the Slide Show feature with your favorites list, see page 91.

■ To delete all pictures except those in your favorites list

### 1 During playback, select [ALL DELETE EXCEPT ★].

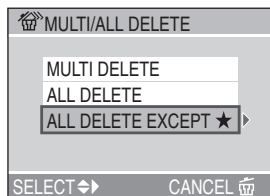

2 times

### 2 Delete the pictures.





- You can place up to 999 pictures in your favorites list.
- Once deleted, pictures cannot be recovered. Please double-check before deleting pictures.
- Do not turn off the camera while deleting.
- Pictures that are protected (P97) or that do not conform to DCF standards (P49) will not be deleted.
- When you delete pictures, use a battery with sufficient battery power (P14) or use with the AC adaptor (ACA-DC4-U/J/E; optional).
- The more pictures there are to delete, the more time it takes.
- You may not be able to put pictures you have shot on other equipment into your favorites list.

For menu operations, see page 90.



### Displaying pictures in a direction at the time of recording [ROTATE DISP.]

This mode allows you to display pictures recorded by holding the camera vertically or pictures rotated in [ROTATE] function in the rotated direction.

#### 1 Select [ON] to set it.

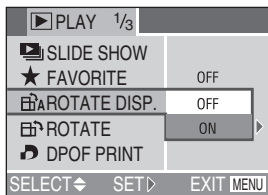

- When you select [OFF], the pictures are displayed without being rotated.
- Refer to P49 for how to play back pictures.



- When you take pictures by holding the camera vertically, read "Correct posture for taking good pictures" on P32 carefully.
- The format detection function (P33) may not work properly on pictures recorded by aiming the camera up or down.
- Only still pictures in normal playback can be rotated. When playing back rotated pictures in multi playback, pictures appear in original orientation.
- You can rotate and display pictures by using [ROTATE] (P94) function even if you do not take pictures by holding the camera vertically.
- Images might be slightly blurred if you show them vertically on a television (connected with the included AV cable).

For menu operations, see page 90.

## Rotating the Picture [ROTATE]

You can rotate and display the recorded pictures in increments of 90°.

### ■ Example

When rotating clockwise ()

Original picture

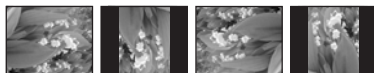

0°

90°

180°

270°

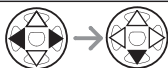
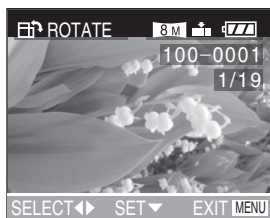

## 1 Select the picture to be rotated and set it.

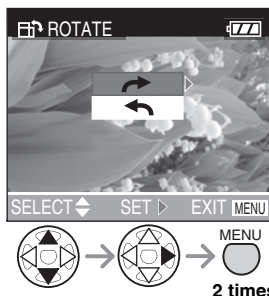

- You cannot rotate motion pictures, flip animations, or protected images.

## 2 Select the direction to rotate the picture.



	The picture rotates clockwise in increments of 90°.
	The picture rotates counter-clockwise in increments of 90°.



- When you play the picture on a PC, you cannot play rotated pictures without an OS or a software compatible with Exif.
- Exif is the file format for still pictures, to which recording information and other can be added, established by JEITA [Japan Electronics and Information Technology Industries Association].
- When [ROTATE DISP.] is set to [OFF], [ROTATE] function is disabled.
- When pictures are recorded by holding the camera vertically, the pictures are played back vertically (the pictures are rotated).
- You may not be able to rotate images shot on other equipment.

For menu operations, see page 90.

## Setting the Picture to be Printed and the Number of Prints [DPOF PRINT]

DPOF (Digital Print Order Format) is a system that allows the user to select which pictures are to be printed on compatible photo printers. DPOF also allows the user to set how many copies of each picture will be printed. Many commercial photo printing services now use DPOF.

### 1 Select [SINGLE], [MULTI] or [CANCEL].

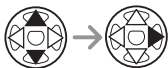
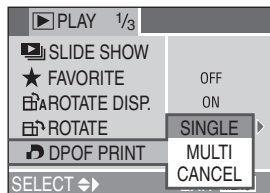

### Single setting

Select the picture and set the number of prints.



- The number of prints can be set from 0 to 999.
- The number of prints icon [  ] appears.
- When the number of prints is set to "0", DPOF print setting is cancelled.

### Multi setting

Select the pictures and set the number of prints.

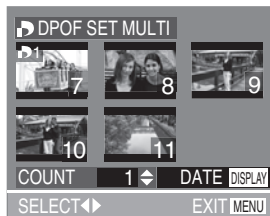

- Repeat the above procedure.
- The number of prints can be set from 0 to 999.
- The number of prints icon [  ] appears.
- When the number of prints is set to "0", DPOF print setting is cancelled.

## ■ To cancel all settings

Select [YES] to cancel all settings.



## ■ To print the date

You can set/cancel the printing with the recorded date each press of the [DISPLAY] button when setting the number of prints.



- The date print icon [DATE] appears.
- When you go to a photo studio for digital printing, be sure to order the printing of the date additionally if required.
- The date may not be printed depending on photo studios or printers even if you set the date print. For further information, ask the photo studio for details or refer to the operating instructions of the printer.



- DPOF print setting is a convenient function when you print pictures with printers supporting PictBridge. (P108)
- DPOF is the abbreviation for Digital Print Order Format. This feature allows you to write print information or other into the images on the card and to use such information on the DPOF-compliant system.
- If the file is not based on the DCF standard, the DPOF print setting cannot be set. DCF is an abbreviation of [Design rule for Camera File system], stipulated by JEITA [Japan Electronics and Information Technology Industries Association].
- When setting the DPOF print, delete any previous DPOF print settings made by other equipment.



For menu operations, see page 90.

## Preventing Accidental Erasure of the Picture [PROTECT]

You can set the protection to the pictures which you do not want to delete for preventing them from accidental erasure.

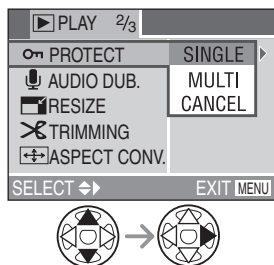

### 1 Select [SINGLE], [MULTI] or [CANCEL].

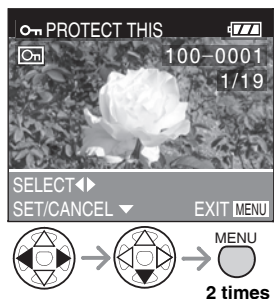

### ■ Protecting a single picture/ Cancelling protection

Select the picture and set/cancel the protection.



SET	The protect icon  appears.
CANCEL	The protect icon  disappears.

### ■ Multi setting/To cancel all settings

Perform the same operation as in [Setting the Picture to be Printed and the Number of Prints [DPOF PRINT]]. (P95 and 96)



- If you want to delete protected pictures, cancel the protect setting first.
- While this feature protects the pictures from accidental erasure, formatting the card will permanently delete all data. (P103)
- The protect setting may not be effective in other equipment.
- Sliding the Card Write-Protect switch  to [LOCK] prevents the picture from deletion even if the protection is not set.



- The following functions cannot be used with protected pictures.
  - [ROTATE] (P94)
  - [AUDIO DUB.] (P98)

For menu operations, see page 90.



## Adding Audio to Recorded Pictures [AUDIO DUB.]

You can record the audio after taking a picture.

### 1 Select the picture and start audio recording.

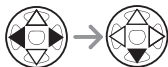
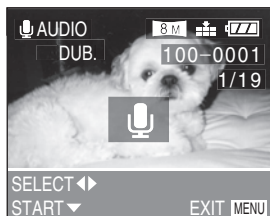

- When audio has already been recorded, the confirmation screen appears. Press **<v>** to select [YES], and press **<=>** to start audio recording. (The original audio is overwritten.)

### 2 Stop audio recording.

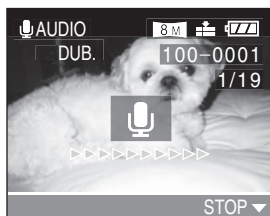

- Press **<v>** to stop recording.
- Even if you do not press **<v>**, after about 10 seconds the audio recording stops automatically.



- You cannot record audio on motion pictures, flip animations, protected images, or images recorded as [TIFF] or [RAW].
- You may not be able to record audio on images shot on other equipment.

For menu operations, see page 90.

## Resizing the Pictures [RESIZE]

This function is useful if you want to reduce the file size of the picture in cases when it needs to be attached to an e-mail or uploaded to a website.

### 1 Select the picture and set it.

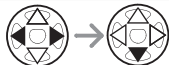

- The following pictures cannot be resized.
  - When the aspect ratio setting is [ 16:9 ]  
Pictures recorded in the [2M EZ] resolution
  - When the aspect ratio setting is [ 3:2 ]  
Pictures recorded in the [2.5M EZ] resolution
  - Pictures recorded as [TIFF] or [RAW]
  - Motion pictures
  - Flip animation
  - Pictures with audio

### 2 Select the size and set it.



- Sizes smaller than the recorded picture are displayed.

#### ■ When the aspect ratio setting is [ 16:9 ]

[5.5M]	3072×1728 pixels
[2M]	1920×1080 pixels

#### ■ When the aspect ratio setting is [ 3:2 ]

[4.5M]	2560×1712 pixels
[2.5M]	2048×1360 pixels

#### ■ When the aspect ratio setting is [ 4:3 ]

[4M]	2304×1728 pixels
[3M]	2048×1536 pixels
[2M]	1600×1200 pixels
[1M]	1280×960 pixels
[0.3M]	640×480 pixels

### 3 Select [YES] or [NO] and set it.

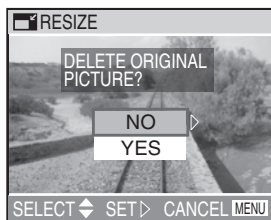

- When you select [YES], the picture is overwritten. When resized pictures are overwritten, they cannot be restored.
- When the original picture is protected, you cannot overwrite the resized picture. When you select [NO], a resized picture is newly created.
- You may not be able to resize pictures you have shot on other equipment.

For menu operations, see page 90.

### **Trimming the Pictures** [TRIMMING]

Use this function when you trim unnecessary parts of the recorded picture.

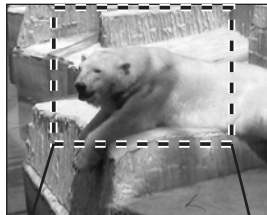

### 1 Select the picture to trim and set it.



- The following pictures cannot be trimmed.
  - Motion pictures
  - Flip animation
  - Pictures with audio
  - Images recorded as [TIFF] or [RAW]

## 2 Enlarge or decrease the picture.



## 3 Shift the picture and press the shutter button fully to set.

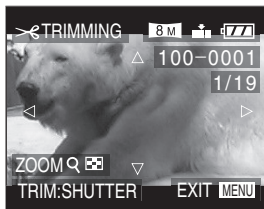

## 4 Select [YES] or [NO] and set it.

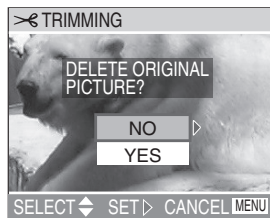

- When you select [YES], the picture is overwritten.  
When trimmed pictures are overwritten, they cannot be restored.
- When the original picture is protected, you cannot overwrite the trimmed picture.  
When you select [NO], a trimmed picture is newly created.



- It may not be possible to trim pictures recorded with other equipment.
- The picture quality of the trimmed picture may be deteriorated.
- If you trim a picture, the number of pixels may be fewer in the trimmed picture than in the original.

For menu operations, see page 90.

## **Changing the Aspect Ratio** [ASPECT CONV.]

Resize pictures taken in 16:9 aspect ratio for printing to 3:2 or 4:3.

### 1 Select [3:2] or [4:3] and set it.

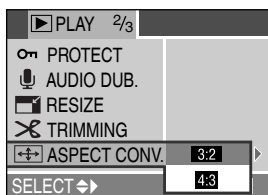

### 2 Select the picture.



### 3 Move the frame to trim the picture.

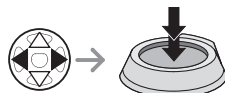

### 4 Select [YES] or [NO] and set it.

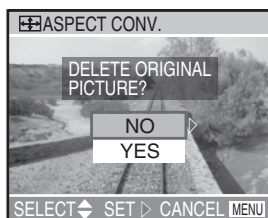

- When you select [YES], the picture is overwritten.  
When pictures with changed aspect ratio are overwritten, they cannot be restored.
- When the original picture is protected, you cannot overwrite the pictures with the changed aspect ratio. When you select [NO], a picture with the changed aspect ratio is newly created.



- You cannot change the aspect ratio of pictures taken as [TIFF] or [RAW], motion pictures, or still pictures with audio.

For menu operations, see page 90.

### **Clean up the Card [CLEAN UP]**

Use this to speed up you SD card's transfer speed if it becomes noticeably slower.

This normally happens after shooting and erasing repeatedly. Reduced transfer speed can especially effect the recording of motion pictures, where recording can be interrupted. Clean up the card beforehand for best results.

#### 1 **Select [YES] to clean up.**

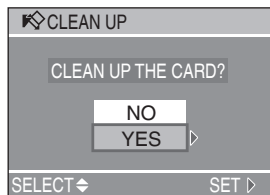

- Cleanup increases the transfer speed of the available memory on the card and does not erase any of your images or other data.
- Cleanup can take some time to complete.
- Cleanup may have no noticeable effect on some kinds of card.
- Cleanup cannot be used on MultiMedia Cards.
- Do not turn the camera off during cleanup.
- When you cleanup the card, use a battery with sufficient battery power (P14) or AC adaptor (ACA-DC4-U/J/E; optional).
- Make sure the SD memory card's write-protect switch is not engaged.

For menu operations, see page 90.

### **Initializing the Card [FORMAT]**

#### 1 **Select [YES] to format.**

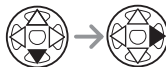
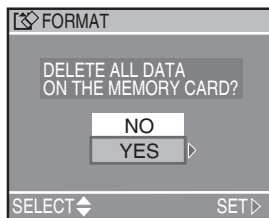

- Usually, it is not necessary to format the card. Format the card when the message [MEMORY CARD ERROR] appears.
- Do not format the card on a computer. Always format on the camera.
- Once the card is formatted, all data including protected images are irretrievably erased. Please confirm that all data is transferred to your PC before proceeding with format function.
- During formatting, do not turn the camera off.
- When you format the card, use a battery with sufficient battery power (P14) or AC adaptor (ACA-DC4-U/J/E; optional).
- When the SD Memory Card Write-Protect switch is slid to [LOCK], you cannot format the card.
- If the card cannot be formatted, consult your Leica photo dealer.

# Playing Back Pictures with a TV Screen



## ■ Playing back pictures with the supplied cable

- Turn the camera and the TV off.
- Set the [TV ASPECT]. (P26)

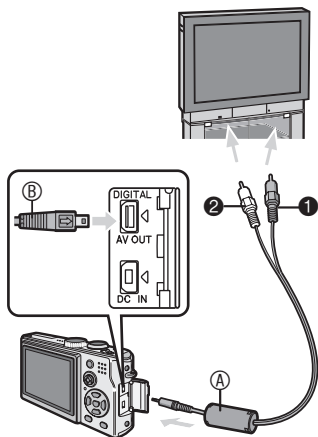

### 1 Connect the AV cable **(A)** (supplied) to the [AV OUT] socket of the camera.

- Connect the AV cable with the [➡] mark facing the [◀] mark on the [AV OUT] socket.
- Hold **(B)** and then insert or pull the AV cable straight.

### 2 Connect the AV cable to the video input and the audio input sockets of the TV.

- **(1)** Yellow: to the video input socket
- **(2)** White: to the audio input socket

### 3 Turn the TV on and select external input.

### 4 Turn the camera on and then set the mode dial to playback mode [▶].

- You can display pictures on a TV only when the mode dial is set to playback mode [▶].

## ■ Viewing pictures in other countries

When setting [VIDEO OUT] on the menu, you can view pictures on a TV in other countries (regions) which use the NTSC or PAL system.

## ■ Playback pictures on TV with SD Memory Card slot

You can put your SD Memory Card in a television with an SD Memory Card slot to show still images. (Depending on the television, some pictures may not take up the whole screen).

- You cannot play motion pictures. Use the included AV cable when playing motion pictures. (See left)
- You may be unable to play MultiMedia Cards, even if the television has an SD Memory Card slot.



- Do not use any other AV cables except the supplied one.
- Read the TV operating instructions too.
- Audio playback is in monaural.
- Pictures might be slightly blurred if you show them vertically on a television (connected with the included AV cable).



# Before Connecting with USB Connection Cable

[USB] : USB MODE]

Select the USB system before connecting a computer or printer to the camera with the USB connection cable (supplied).

Set the items on [USB MODE] in the [SETUP] menu. (P25)

## 1 Select [USB MODE].

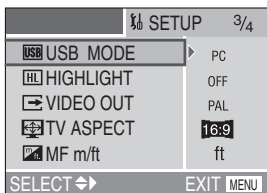

- When [PC] is selected, the camera is connected via USB Mass Storage communication system.
- When [PictBridge (PTP)] is selected, the camera is connected via PTP (Picture Transfer Protocol) communication system.
- If you have connected with a USB connection cable, [PICTURE IS DISPLAYED FOR 16:9 TV FOR 4:3 SETUP ► TV ASPECT] or similar may be shown but this is normal.

## 2 Select [PC] or [PictBridge (PTP)].

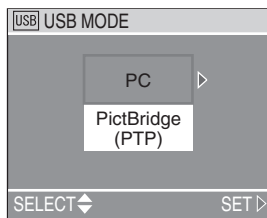

- If you connect the camera to a PC, select [PC]. (P106)
- If you connect the camera to a printer supporting PictBridge, select [PictBridge (PTP)]. (P108)

# Connecting to a PC

- By connecting the camera to a computer, you can upload your pictures, then use the software on the included CD-ROM to print or send your images by e-mail.
- **If you use Windows 98/98SE, install the USB driver and then connect it to the computer.**

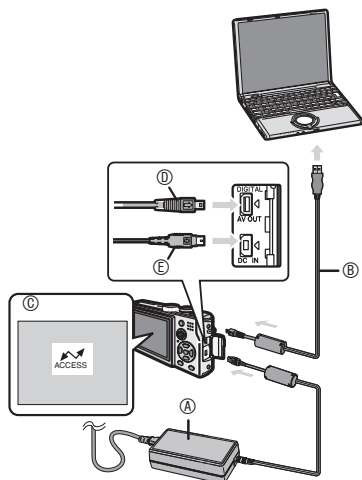

- (A) : AC adaptor (ACA-DC4-U/J/E; optional)
- Make sure this unit is off before connecting or disconnecting the AC adaptor (ACA-DC4-U/J/E, optional).
- (B) : USB connection cable (supplied)
- (C) : This message appears during data transfer.
- (D)(E) : Check the facing of the connector and push straight in.

## 1 Switch the camera on and set [USB MODE] to [PC] in the setup menu (P105).

- If you have set [USB MODE] to [PictBridge (PTP)], the computer may show an error message. Click [Cancel] to close the dialog and disconnect the cable from the computer. Change the setting to [PC] and reconnect the cable.

## 2 Connect the camera to a PC via the USB connection cable (B) (supplied).

- Connect the USB connection cable with the [➔] mark facing the [◀] mark on the [DIGITAL] socket.
- Hold (D) and then insert or pull the USB connection cable straight. Do not try to force the connector in backwards or sideways. This can damage this unit and the equipment you are connecting.

### [Windows]

The drive appears on the [My Computer] folder.

- If it is the first time you are connecting the camera to a PC, the required driver is installed automatically so that the camera can be recognized by the Windows Plug and Play, then it appears on the [My Computer] folder.

### [Macintosh]

The drive appears as [NO\_NAME] or [Untitled].

## ■ Folder Composition

Folders appear as follows.

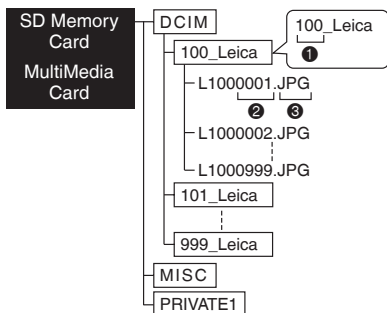

- ❶ Folder number
- ❷ File number
- ❸ JPG : Pictures  
MOV : Motion pictures

The contents of each folder are:

DCIM	100_Leica to 999_Leica
100_Leica	Pictures/Motion pictures
MISC	File with DPOF or favorite setting
PRIVATE1	Flip animation files

- This unit stores up to 999 picture files in each folder. A new folder is created after this maximum is reached.
- To reset file and folder numbers, use [NO.RESET] in the setup menu. (P25)

### ■ Folder numbers are updated when:

- The folder containing the picture you just shot had a file numbered 999 in it.
- You insert a card you had been using on another manufacturer's camera that has a file number 100 (e.g. 100\_XXXXX, XXXXX is the manufacturer's name, etc.) immediately after using a card that had a folder numbered 100. (That is, you insert a card with the same number, irrespective of the manufacturer.)

- You start shooting again after using [NO.RESET] in the setup menus (P25). (It is recorded to a new folder that has a number following on from the one previous. You can also reset the folder number to 100 by using [NO.RESET] immediately after formatting the card when there are no folders or pictures on the card.)



- If the remaining battery power is exhausted during communication, the recorded data may be damaged. When you connect the camera to the PC, use a battery with sufficient battery power (P14) or the AC adaptor (ACA-DC4-U/J/E; opt.).
- If the remaining battery power becomes low during communication, the alarm beeps. In this case, stop the communication immediately.
- While [ACCESS] is being displayed, do not disconnect the USB connection cable.
- **For Windows 2000 users: Disconnect the USB cable before changing the card. Changing the card while the cable is still connected can damage the data on the card.**
- Do not use any other USB connection cables except the supplied one.
- Refer to the operating instructions of the PC, too.
- You can process [RAW] format files with [Photoshop Elements 3] (on the included CD-ROM).
- **About PictBridge (PTP) setting**
  - With Windows XP Home Edition/ Professional and Mac OS X, you can leave the USB mode setting as [PictBridge (PTP)].
  - You can only load pictures from the camera and cannot write them on the card or delete them.
  - When there are 1000 or more pictures on a card, the pictures may not be imported.

# Connecting to a PictBridge-compliant Printer

By connecting the camera directly to a printer supporting PictBridge via the USB connection cable (supplied), you can select the pictures to be printed or start printing on the LCD monitor.

Make the necessary settings on your printer beforehand. (Read your printer's operating instructions.)

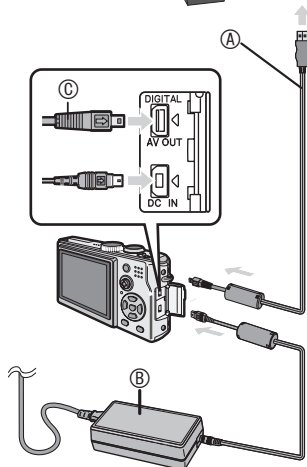
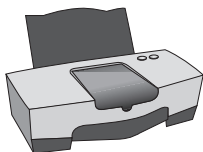

- Ⓐ : USB connection cable (supplied)  
 Ⓑ : AC adaptor (ACA-DC4-U/J/E; optional)

- Make sure this unit is off before connecting or disconnecting the AC adaptor (ACA-DC4-U/J/E, optional).

**1 Turn the camera on and then set the USB mode to [PictBridge (PTP)]. (P105)**

**2 Turn on the printer.**

**3 Connect the camera to a printer via the USB connection cable Ⓐ (supplied).**

- Connect the USB connection cable with the [➡] mark facing the [◀] mark on the [DIGITAL] socket.
- Hold Ⓞ and then insert or pull the USB connection cable straight.

When the DPOF Print is set. (P95)	Select [DPOF PICTURE]. (P110)
When the DPOF Print is not set.	Select [SINGLE PICTURE]. (P109)



- If the remaining battery power becomes low during communication, the alarm beeps. In this case, stop the communication immediately.
- It may take time to print some pictures. Therefore, we recommend using a battery with sufficient power (P14) or the AC adaptor (ACA-DC4-U/J/E; optional) when you connect to a printer.
- Disconnect the USB connection cable after printing.
- Do not use any other USB connection cables except the supplied one.

## ■ Single picture

### 1 Select a picture to be printed.

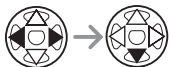
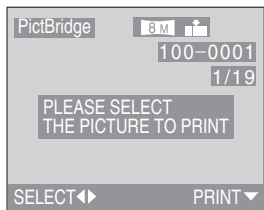

- A message displays for about 2 seconds.

### 2 Set the print settings.

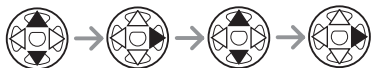
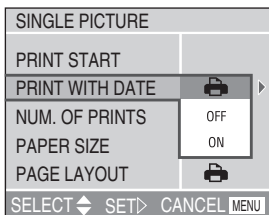

- The items which are not supported by the printer are displayed in gray and cannot be selected.
- When you want to print pictures in a paper size or a layout which is not supported by the camera, set [PAPER SIZE] and [PAGE LAYOUT] to [ ] and then set the paper size or the layout on the printer. (For details, refer to the operating instructions of the printer.)

## ■ [PRINT WITH DATE]

	Settings on the printer are prioritized.
OFF	Date is not printed.
ON	Date is printed.

- If the printer does not support date printing, the date cannot be printed on the picture.

## ■ [NUM. OF PRINTS]

Set the number of prints.

## ■ [PAPER SIZE]





(Possible paper sizes on the camera)  
The items are listed on 1/2 and 2/2.  
Press ▼ to select the desired item.

1/2	
	Settings on the printer are prioritized.
L/3.5"×5"	89 mm×127 mm
2L/5"×7"	127 mm×178 mm
POSTCARD	100 mm×148 mm
A4	210 mm×297 mm
2/2*	
CARD SIZE	54 mm×85.6 mm
10×15cm	100 mm×150 mm
4"×6"	101.6 mm×152.4 mm
8"×10"	203.2 mm×254 mm
LETTER	216 mm×279.4 mm

\*These items cannot be displayed when the printer does not support the paper sizes.

## ■ [PAGE LAYOUT]

(Possible layouts on the camera)

	Settings on the printer are prioritized.
	1 page with no frame print
	1 page with frame print
	2 pages print
	4 pages print

### 3 Select [PRINT START] and then print out the picture.

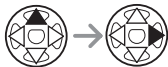
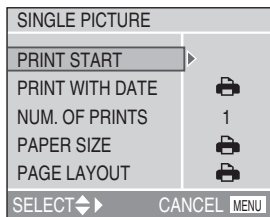

- Press the [MENU] button to cancel printing.

## ■ DPOF picture

- Set the DPOF print with this camera in advance. (P95)

### 1 Select [DPOF PICTURE].

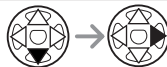
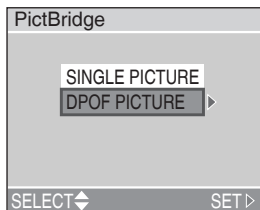

- When printing under the new settings, disconnect the USB connection cable and connect it to the printer again.
- You can change the DPOF print setting by pressing the [MENU] button. (P95)

### 2 Select [PRINT START] and then print out the picture.

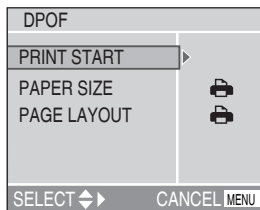

- Refer to P109 for print setting.
- Press the [MENU] button to cancel printing.

### ■ Setting the date printing with the DPOF print in advance

When the printer supports the date printing by DPOF setting, we recommend setting the date printing with the DPOF print in advance. (P96)

The recording date can be printed by selecting [DPOF PICTURE] to start printing.



- Do not disconnect the USB connection cable when the cable disconnection warning icon [ ] is indicated.
- When the [●] indication lights in orange during printing, make sure there is no malfunction on the printer.
- In DPOF print, if the total number of prints or the number of printed pictures is high, pictures are printed several times. (The indication of the remaining number of prints is different from the setting, however, this is not a malfunction.)
- The setting on the printer may have priority over the setting on the camera in the date print. Also check the date print setting on the printer.
- If the printer does not support date printing, the date cannot be printed on the picture.
- If your printer is not compatible with [TIFF] or [RAW], the JPEG pictures associated with them will be printed. (If there is no associated JPEG, the printing may not be possible.)

### ■ Layout printing

#### • When printing a picture several times on 1 sheet of paper

For example, if you want to print a picture 4 times on 1 sheet of paper, set [PAGE LAYOUT] to [ ] and then set the number of prints to 4 for the picture on [NUM. OF PRINTS].

#### • When printing different pictures on 1 sheet of paper (only in DPOF printing)

For example, if you want to print 4 different pictures on 1 sheet of paper, set [PAGE LAYOUT] to [ ] and then set the number of prints to 1 on [COUNT] in DPOF print setting (P95) for each of the 4 pictures.

# Screen Display

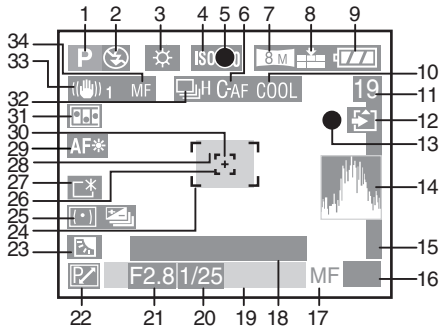

## ■ In recording

- 1 Recording mode (P30)
- 2 Flash (P40)
- 3 White balance (P71)
- 4 ISO sensitivity (P73)
- 5 Focus indication (P31)
- 6 Continuous AF (P77)
- 7 Picture size (P73)
- 8 Quality (P74)
  - 30fps / 10fps / 30fps / 10fps / 30fps / 10fps :  
VGA / VGA / OVGA / OVGA / 16:9 / 16:9
- 9 Battery indication (P14)
- 10 Colour effect (P78)
- 11 Picture/Time remain  
In Motion picture mode: e.g. 11S
- 12 Card access indication (P17)
- 13 Recording indication
- 14 Histogram (P29)
- 15 Moving focus (P83)
- 16 Joystick operations
- 17 MF indication (P83)
- 18 Age display (P65)
  - Whenever you turn the camera on in Baby mode, switch to Baby mode from any other scene mode, or after setting the birthday or clock, your baby's age and the current date and time appear on the display for about 5 seconds.
- 19 Current date and time
  - It is displayed for about 5 seconds when turning the camera on, setting the clock and after switching from the playback mode to the recording mode.
- 20 Shutter speed indication (P31)
- 21 Aperture value indication (P31)
- 22 Programme shift indication (P34)
- 23 Backlight compensation (P36)
  - ☀ : Exposure compensation (P45)
- 24 AF area (P31)
- 25 Metering mode (P75)
  - ☀ : Auto bracket (P46)
- 26 Spot AF area (P76)
- 27 Power LCD indication (P28)
- 28 Self-timer (P44)
  - ⌚
- 29 AF assist lamp (P77)
- 30 Spot metering target (P75)
- 31 Flip animation (P79)
- 32 Burst (P48)
  - ⏸ : Audio recording (P59, 75)
- 33 Optical image stabilizer (P47)
- 34 MF indication (P83)/  
AF indication (P86)



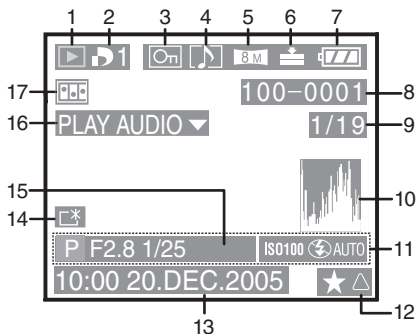

## ■ In playback

- |  |  |
|--|--|
| <p>1 Playback mode</p> <p>2 Number of DPOF [  ] prints (P95)</p> <p>3 Protected picture (P97)</p> <p>4  : Still or motion pictures with audio (P89)</p> <p>5 Picture size (P73)</p> <p>6 Quality (P74)</p> <p> /  /  /  /  /  :<br/>In Motion picture mode (P59)</p> <p>7 Battery indication (P14)</p> <p>8 Folder/File number</p> <p>9 Page number/Total pictures</p> <p>10 Histogram (P29)</p> | <p>11 Recording information</p> <p>12 Favorites setting (P92)</p> <p>13 Recorded date and time</p> <p>14 Power LCD indication (P28)</p> <p>15 Age display (P65)</p> <p>16 Audio playback (P89)</p> <p><b>PLAY MOTION</b></p> <p><b>PICTURE ▾</b> : In Motion picture mode</p> <p>17 Flip animation (P79)</p> <p> : Favorites indicator (P92)</p> |
|--|--|

# Cautions for Use

## ■ Optimal Use of the Camera

**When carrying the camera, take care not to drop or cause impact to it.**

- The lens or the outer case may be destroyed by the strong shock, and it causes a malfunction of the camera.

**Keep the camera away from magnetised equipment (such as a microwave oven, TV, video game equipment, etc.).**

- If you use the camera on or near a TV, pictures and sounds may be disrupted due to electromagnetic wave radiation.
- Do not use the camera near a cell phone because doing so may cause noise to adversely affect the pictures and sounds.
- Recorded data may be damaged, or pictures may be distorted by strong magnetic fields created by speakers or large motors.
- Electromagnetic wave radiation generated by a microprocessor may adversely affect the camera, causing the disturbance of pictures and sounds.
- If the camera is affected by magnetically charged equipment and does not function properly, turn the camera off and remove the battery or disconnect the AC adaptor (ACA-DC4-U/J/E; optional) and then insert the battery or connect the AC adaptor again. Thereafter, turn the camera on.

**Do not use the camera near radio transmitters or high-voltage lines.**

- If you record near radio transmitters or high-voltage lines, recorded pictures or sounds may be adversely affected.

**Make sure to use the supplied cords and cables. If you use optional accessories, use the cords and the cables supplied with them.**

**Do not extend the cords and the cables.**

**Do not spray insecticides or volatile chemicals onto the camera.**

- If the camera is sprayed with such chemicals, the camera body may be damaged and the surface finish may peel off.
- Do not keep rubber or plastic products in contact with the camera for a long period of time.

**Do not use benzine, thinner or alcohol for cleaning the camera.**

- Before cleaning the camera, remove the battery or disconnect the AC adaptor (ACA-DC4-U/J/E; optional) from the electrical outlet.
- The camera body may be deformed and the surface finish may peel off.
- Wipe the camera with a soft, dry cloth. To remove stubborn stains, wipe with a cloth that is soaked in a detergent diluted with water and afterward finish wiping with a dry cloth.
- If you use a chemical cloth, follow the instructions that come with the cloth.
- In case rain or other sources of water splash onto the camera, wet a soft cloth with tap water, wring it well, and use it to wipe the camera body carefully. Then wipe it again with a dry cloth.

### ■ Card

**Do not leave the card in places where there is high temperature or direct sunlight, or where electromagnetic waves or static electricity are easily generated.**

**Do not bend or drop the card.**

- The card may be damaged or the recorded content may be damaged or erased.
- Store the card in the card case or the storage bag after use and when you store or carry the card.
- Do not allow dirt, dust or water to enter the terminals on the back of the card and do not touch the terminals with your fingers.

### ■ Battery

**The battery is a rechargeable lithium ion battery. Its ability to generate power is based upon the chemical reaction that takes place inside it. This reaction is susceptible to the surrounding temperature and humidity, and, if the temperature is too high or too low, the operating time of the battery will be shorter.**

**After use, be sure to remove the battery.**

Store the removed battery in the battery carrying case (supplied).

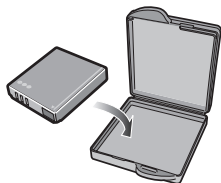

**If you drop the battery accidentally, check to see if the battery body and terminals are damaged.**

- Inserting a damaged battery in the camera will damage the camera.

**When you go out, bring charged spare batteries.**

- Be aware that the operating time of the battery will become shorter in low temperatures such as outdoors at a ski resort.
- When you travel, be sure to prepare the supplied charger to charge the battery on the spot.

**Dispose of an unusable battery.**

- The battery has a limited life.
- Do not throw the battery into fire because it may cause an explosion.

**Do not allow the battery terminals to come in contact with metal objects (such as necklaces, hairpins, etc.).**

- This can result in a short circuit or heat generation and, if you touch the battery in this condition, you may be badly burned.

### ■ Charger

- If you use the charger near a radio, radio reception may be disturbed. Keep the charger 1 m or more away from radio.
- When the charger is in use, it may generate whirring sounds. However, this is not a malfunction.
- After use, be sure to disconnect the AC mains lead from the electrical outlet. (If it is left connected, a minute amount of current is consumed.)
- Keep the terminals of the charger and battery clean.

# Message Display

---

## **[THIS MEMORY CARD IS PROTECTED]**

Cancel the card lock.

## **[NO VALID PICTURE TO PLAY]**

Play back after recording or after inserting a card with a recorded picture.

## **[THIS PICTURE IS PROTECTED]**

After cancelling the protect setting, you can delete or overwrite the picture.

## **[THIS PICTURE CANNOT BE DELETED]/ [SOME PICTURES CANNOT BE DELETED]**

The pictures not based on the DCF standard cannot be deleted.

- To delete this kind of picture, first save your data to your computer, then use this unit to reformat the card.

## **[NO ADDITIONAL DELETE SELECTIONS CAN BE MADE]**

You have exceeded the number of pictures that can be set at once with multi-delete setting.

You have placed more than 999 pictures in your favorites list.

## **[CANNOT BE SET ON THIS PICTURE]/ [CANNOT BE SET ON SOME PICTURES]**

If the pictures are not based on the DCF standard, the DPOF print cannot be set.

## **[MEMORY CARD ERROR FORMAT THIS CARD?]**

The format of the card cannot be recognized by this camera. Format the card again with this camera.

Save your data to your computer, then use this unit to reformat the card.

## **[PLEASE TURN CAMERA OFF AND THEN ON AGAIN]**

This message appears when the camera does not operate properly. Turn the camera off and on. If the message persists, contact the dealer or your nearest servicentre.

## **[MEMORY CARD ERROR]**

Failed access to the card.  
Insert the card again.

## **[READ ERROR PLEASE CHECK THE CARD]**

Data reading error.

Check that the card is inserted correctly and play it again.

## **[WRITE ERROR PLEASE CHECK THE CARD]**

Data writing error.

Turn the camera off and remove the card. Then insert the card and turn the camera on again. Be sure that the camera is turned off before removing or inserting the card to avoid damage. This error may also indicate that the card is damaged.

**[MOTION RECORDING WAS CANCELLED DUE TO THE LIMITATION OF THE WRITING SPEED OF THE CARD]**

When you set the [PICT.MODE] to [30fpsVGA] or [30fps16:9], use cards that have a speed of 10 MB/second or better (shown on the card packaging) for best results.

Shooting may stop unexpectedly with some types of card or if you use a card whose memory has been fragmented by repeated shooting and erasure. Clean up the card with this unit beforehand for best results (P103).

**[A FOLDER CANNOT BE CREATED]**

The card is full so you cannot create a folder.

Save your data to your computer, then use this unit to reformat the card.

**[MOTION MODE IS NOT AVAILABLE IN 3:2 ASPECT. SET THE ASPECT SWITCH IN 4:3 OR 16:9.]**

You cannot shoot motion pictures if you have set the aspect ratio to [3:2]. Set the aspect ratio to either [16:9] or [4:3]. (P87)

# Troubleshooting

If you put the menu back to the settings at the time of purchase, the conditions may be improved. **Carry out the [RESET] in the setup menu. (P25)**

## ■ Battery and power supply

Conditions	Causes
The camera will not turn on.	Is the battery inserted correctly? Check the direction of the battery.
	Is the battery sufficiently charged? Use a battery that has been sufficiently charged.
The camera turns off soon after turning it on.	The battery is out of charge. Recharge the battery or use one that has sufficient charge.





## ■ Shooting

Conditions	Causes
The picture cannot be recorded.	Is the card inserted?
	Is the mode dial correctly set?
	Is there any memory capacity left on the card? Before recording, delete some pictures.
The subject is not focused properly.	The focus range varies depending on the recording mode. Rotate the mode dial to set to the proper mode for the distance to the subject.
	Is the subject out of the focus range? (P32)
	When you cannot focus on the subject even if you tried many times, turn the camera off once and turn it on again.
The recorded picture is blurred.	When taking a picture in shaded areas or indoors, the shutter speed becomes slow and the Optical Image Stabilizer function may not work properly. In this case, we recommend holding the camera with both hands firmly to take pictures (P32).
The recorded pictures are pale. There is dirt on the lens.	Stains, such as fingerprints, may be on the lens. If the surface of the lens is dirty, turn on the camera and clean it with a soft cloth.
Shooting of motion pictures stops unexpectedly.	This camera is not compatible with motion picture recording on MultiMediaCards.
	When you set the [PICT.MODE] to [30fpsVGA] or [30fps16:9], use cards that have a speed of 10 MB/second or better (shown on the card packaging) for best results. Shooting may stop unexpectedly with some types of card or if you use a card whose memory has been fragmented by repeated shooting and erasure. Clean up the card with this unit beforehand for best results (P103).

## ■ LCD

Conditions	Causes
<b>The picture is not displayed on the LCD monitor.</b>	Is the power save mode (P24) activated? Press the shutter button halfway to disactive these modes.
	Is the battery charge insufficient to operate the camera? Use a battery that has been sufficiently charged.
<b>The brightness of the screen becomes dark or bright for a moment.</b>	This phenomenon appears when pressing the shutter button halfway to set the aperture value and does not affect the recorded pictures.
<b>The screen is too bright or dark.</b>	Adjust the brightness of the screen. (P24)
	Is the Power LCD function activated? (P28)
<b>Some pixels are inactive or always lit on the LCD monitor.</b>	This is not a malfunction. These pixels do not affect the recorded pictures.
<b>Noise appears on the LCD monitor.</b>	In dark places, noise may appear to maintain the brightness of the LCD monitor. This does not affect the pictures you are recording.
<b>A vertical red spectrum appears on the LCD monitor.</b>	This is called smear. It is specific to CCD, not a malfunction. It appears when the subject has a bright part. It is recorded on motion pictures, but not recorded on still pictures.

## ■ Flash

Conditions	Causes
Flash is not activated.	Make sure the flash is open. Slide the [  OPEN] switch. (P40)
	The flash is not activated when motion picture mode [  ], [SCENERY], [NIGHT SCENERY], [FIREWORKS] or [STARRY SKY] in scene mode (P61) is selected.
The flash is activated 2 times.	With AUTO/Red-eye reduction [  ], Forced ON/Red-eye reduction [  ], and Slow-sync./Red-eye reduction [  ], the first flash is preparatory in order to reduce the redeye effect. The flash for shooting goes off after that.



## ■ Playback

Conditions	Causes
<b>The picture is not played back.</b>	<p>Is the card inserted?</p> <p>Is there a picture in the card?</p> <p>Is the mode dial set to playback []?</p>
<b>Pictures rotate unexpectedly.</b>	<p>One of the features of this unit can automatically detect when you have turned the camera side on to take a picture, then rotate that picture for you when you play it back.</p> <p>In some cases, the unit may detect that you have turned the camera side on, when in fact you are facing it up or down.</p> <ul style="list-style-type: none"> <li>• Set [ROTATE DISP.] (P93) to [OFF] so that the camera does not rotate these kinds of pictures for you.</li> <li>• You can use [ROTATE] (P94) to rotate the pictures when necessary.</li> </ul>
<b>Images are grainy or noisy.</b>	<p>Check that ISO sensitivity isn't too high or that shutter speed isn't too slow.</p> <ul style="list-style-type: none"> <li>• Reduce ISO sensitivity. (P73)</li> <li>• In [PICT.ADJ.], set [NOISE REDUCTION] to [HIGH]. (P79)</li> <li>• Improve the ambient light.</li> </ul>
<b>Folder or file name appears as [-] and the display goes black.</b>	<p>The picture may have been changed on a computer or taken on a different manufacturer's camera.</p> <p>This problem can also occur if you remove the battery immediately after taking a picture or if the battery had very little charge left.</p> <ul style="list-style-type: none"> <li>• You will need to reformat the card to delete this type of picture. (P103) (Remember that all data will be irretrievably erased when you format the card, so save your data and check the card before proceeding.)</li> </ul>

## ■ Connecting to a TV, computer or printer

Conditions	Causes
The picture does not appear on the television. The TV screen is disturbed or displayed in monochrome.	Is the camera connected to the TV correctly? Check it.
	Set the TV to video input mode.
Cannot play motion pictures on a television.	You cannot play motion pictures if you have inserted the card into a card slot on a television. Connect the camera to the television with the included AV cable and play the pictures on this unit. (P104)
The pictures cannot be printed with printers.	Does the printer support PictBridge? You cannot print pictures with printers which do not support PictBridge. (P108) Set the USB mode to [PictBridge (PTP)]. (P105)
The sides of printed images are cut off.	<ul style="list-style-type: none"> <li>Some photography shops can handle pictures shot in the [16:9] aspect ratio (P87). Enquire before sending them for printing.</li> <li>If your printer has trimming and border settings, change the settings so that there is no trimming and no border. (Read your printer's operating instructions.)</li> </ul>
Cannot upload pictures to your computer.	Check the connections.
	Check that the computer has correctly recognized the camera.
	Change the camera's USB mode to [PC]. (P105)
The picture size does not fit the TV screen.	Check the [TV ASPECT] setting on this unit. (P26)
The relative area taken up by pictures shown on the television and on this unit's LCD is different.	The actual area shown may be different with some types of television. Pictures may appear with the sides or top and bottom cut off. This is normal.
The computer does not recognize the card.	Disconnect the USB connection cable, then insert the card and reconnect the cable.

## ■ Others

Conditions	Causes
<b>Unreadable language was selected by mistake.</b>	Select [  ] icon on the [SETUP] menu to set the desired language. (P26)
<b>When the shutter button is pressed halfway, a red lamp turns on sometimes.</b>	In dark places, the AF assist lamp (P77) lights red to make it easier to focus on a subject.
<b>The AF assist lamp does not turn on.</b>	Is [AF ASSIST LAMP] on the [REC] mode menu set to [ON]? Are you taking pictures in bright places? The AF assist lamp does not turn on in bright places. The AF assist lamp does not turn on when [SCENERY], [NIGHT SCENERY], [FIREWORKS] or [SELF PORTRAIT] in scene mode (P61) is selected.
<b>The clock setting is reset.</b>	If you do not use the camera for a long time, the clock setting may be reset. When the message [PLEASE SET THE CLOCK] appears, set the clock again. When you take a picture before setting the clock, [0:00 0. 0. 0] is recorded.
<b>The lens clicks.</b>	When brightness has changed due to the zoom or the movement of the camera or other, the lens may click and the picture on the screen may be drastically changed, however, the pictures are not affected. The sound is caused by automatic adjustment of the aperture. It is not a malfunction.
<b>The camera gets hot.</b>	The camera may get a little warm while you are using it, but this is normal.
<b>Cannot change the auto review setting.</b>	You cannot change the auto review setting in the setup menu if you are; shooting with auto bracket (P46) or burst mode (P48): shooting motion pictures (P59): using the self portrait scene mode (P69): or, recording audio. (P75)
<b>File numbers are not created in order.</b>	Certain operations cause pictures to be saved in folders with different numbers. (P107)

# Specifications

<b>Digital Camera:</b>	Information for your safety
<b>Power Source:</b>	DC 5.1 V
<b>Power Consumption:</b>	2.1 W (When recording) 1.0 W (When playing back)
<b>Camera Effective pixels:</b>	8,400,000 pixels
<b>Image sensor:</b>	1/1.65" CCD, total pixel number 8,610,000 pixels Primary colour filter
<b>Lens:</b>	Optical 4× zoom, f=6.3 to 25.2 mm [35 mm film camera equivalent: 28 to 112 mm (aspect ratio [16:9])]/F2.8 to F4.9
<b>Digital zoom:</b>	Max. 4×
<b>Extra optical zoom:</b>	In [16:9] aspect : Up to 5× In [3:2] aspect : Up to 5.1× In [4:3] aspect : Up to 5.6× (Any resolution except the maximum for the selected aspect ratio)
<b>Focus:</b>	Normal/Macro/Manual 9-area-focusing/3-area-focusing (high speed)/1-area-focusing (high speed)/1-area-focusing/Spot-focusing
<b>Focus range:</b>	Normal AF: 50 cm (Wide)/120 cm (Tele) to ∞ Macro: 5 cm (Wide)/30 cm (Tele) to ∞
<b>Shutter system:</b>	Electronic shutter+Mechanical shutter
<b>Shutter speed:</b>	60 to 1/2,000th
<b>Burst recording</b>	
<b>Burst speed (max.):</b>	3 frames/second (high speed), 2 frames/second (low speed), 2 frames/second (unlimited)
<b>Number of recordable pictures (max.):</b>	9 frames (standard), 5 frames (fine), Depends on the capacity of the card. (unlimited) (Performance in burst recording is only with SD Memory Card. MultiMediaCard performance will be less.)
<b>Motion picture recording:</b>	Aspect ratio [16:9]:848×480 pixels (30 or 10 frames/second with audio) Aspect ratio [4:3]:320×240 pixels, 640×480 pixels (30 or 10 frames/second with audio) (The maximum recording time depends on the capacity of the card.)
<b>ISO sensitivity:</b>	AUTO/80/100/200/400
<b>White balance:</b>	AUTO/Daylight/Cloudy/Halogen/White set 1/White set 2
<b>Exposure (AE):</b>	Programme AE Exposure compensation (1/3 EV Step, -2 to +2 EV)
<b>Metering mode:</b>	Multiple/Centre weighted/Spot
<b>LCD monitor:</b>	Low-temperature polycrystalline TFT LCD 2.5" (Approx. 207,000 pixels) (field of view ratio about 100%)
<b>Flash:</b>	Flash range: (ISO AUTO) Approx. 60 cm to 4.1 m AUTO, AUTO/Red-eye reduction, Forced ON (Forced ON/Red-eye reduction), Slow sync./Red-eye reduction, Forced OFF

<b>Microphone:</b>	Monaural
<b>Speaker:</b>	Monaural
<b>Recording media:</b>	SD Memory Card/MultiMediaCard
<b>Picture size:</b>	
<b>Still picture:</b>	Aspect ratio [16:9]: 3840×2160 pixels, 3072×1728 pixels, 1920×1080 pixels Aspect ratio [3:2]: 3248×2160 pixels, 2560×1712 pixels, 2048×1360 pixels Aspect ratio [4:3]: 2880×2160 pixels, 2304×1728 pixels, 2048×1536 pixels, 1600×1200 pixels, 1280×960 pixels
<b>Motion picture:</b>	Aspect ratio [16:9]: 848×480 pixels Aspect ratio [4:3]: 640×480 pixels, 320×240 pixels
<b>Quality:</b>	TIFF/Fine/Standard/RAW
<b>Recording file format</b>	
<b>Still Picture:</b>	JPEG (Design rule for Camera File system, based on Exif 2.2 standard)/DPOF compliant
<b>Picture with audio:</b>	JPEG (Design rule for Camera File system, based on Exif 2.2 standard)+QuickTime (picture with audio)
<b>Motion pictures:</b>	QuickTime Motion JPEG (audio recordable)
<b>Interface</b>	
<b>Digital:</b>	USB 2.0 (Full Speed)
<b>Analog video/audio:</b>	NTSC/PAL Composite (Switched by menu), Audio line output (monaural)
<b>Terminal</b>	
<b>AV OUT/DIGITAL:</b>	AV/USB Dedicated jack (8 pin)
<b>DC IN:</b>	Dedicated jack (2 pin)
<b>Dimensions:</b>	105.7 mm (W)×58.3 mm (H)×25.6 mm (D) (excluding projecting parts)
<b>Weight:</b>	Approx. 185 g (excluding Memory Card, battery and Lens Cap) Approx. 220 g (with Memory Card, battery and Lens Cap)
<b>Operating Temperature:</b>	0 °C to 40 °C
<b>Operating Humidity:</b>	10 % to 80 %
<b>Battery Charger (BC-DC4-U/J/E):</b>	Information for your safety
<b>Input:</b>	110 to 240 V ~ 50/60 Hz, 0.2 A
<b>Output:</b>	CHARGE 4.2 V---0.8 A
<b>Equipment mobility:</b>	Movable
<b>Battery Pack (lithium-ion) (BP-DC4-U/J/E):</b>	Information for your safety
<b>Voltage/capacity:</b>	3.7 V, 1150 mAh

## **Leica Academy**

As well as outstanding high-performance products for taking, reproducing and viewing photographs, for many years we have also been offering the special services of the Leica Akademie, with practical seminars and training courses, which are intended to share our knowledge about the world of photography, projection and magnification with both beginners and advanced photographic enthusiasts.

The contents of the courses, which are run by a trained team of experts in the modern, well-equipped training suite at our Solms factory and in the Hofgut Altenberg, vary from general photography to areas of special interest and offer a range of suggestions, information and advice for your own work.

You can obtain the current Leica Akademie brochure from:

Leica Camera AG

Leica Akademie

Oskar-Barnack-Straße 11

D-35606 Solms

Tel: +49 (0) 6442-208-421

Fax: +49 (0) 6442-208-425

E-mail: [la@leica-camera.com](mailto:la@leica-camera.com)

## **Leica on the Internet**

Current information about products, news, events and the Leica company is available on our homepage on the Internet at:

<http://www.leica-camera.com>

## **Leica information service**

The Leica information service can provide you with an answer to any technical questions relating to the Leica range either in writing, on the telephone or by e-mail.

Leica Camera AG

Informations-Service

Postfach 1180

D-35599 Solms

Tel: +49 (0) 6442-208-111

Fax: +49 (0) 6442-208-339

e-mail: [info@leica-camera.com](mailto:info@leica-camera.com)

## **Leica Customer Service**

Leica AG's Customer Service center, or the repair service of the Leica national offices, is available to assist you in maintaining your Leica equipment or in case of damage. Please contact your nearest authorized Leica dealer.

Leica Camera AG

Customer Service

Solmser Gewerbepark 8

D-35606 Solms

Tel: +49 (0) 6442-208-189

Fax: +49 (0) 6442-208-339

E-Mail: [customer.service@leica-camera.com](mailto:customer.service@leica-camera.com)



QuickTime and the QuickTime logo are trademarks or registered trademarks of Apple Computer, Inc., used under license.



my point of view

Leica Camera AG / Oskar-Barnack-Str. 11 / D-35606 Solms  
[www.leica-camera.com](http://www.leica-camera.com) / [info@leica-camera.com](mailto:info@leica-camera.com)  
Telefon +49 (0) 64 42-208-0 / Telefax +49 (0) 64 42-208-333