



# NORMARC 7033

## INSTRUMENT LANDING SYSTEM

# Operating Manual



NAVIA AVIATION



# OPERATING MANUAL

## NORMARC 7033

### TABLE OF CONTENTS

<b>PART I DESCRIPTION.....</b>	<b>1-1</b>
1 SYSTEM DESCRIPTION.....	1-1
1.1 System Overview .....	1-1
1.2 Abbreviations.....	1-2
2 TECHNICAL SPECIFICATIONS.....	2-1
2.1 Signal Minimum Performance GP .....	2-1
2.2 Environmental characteristics .....	2-2
2.3 EMC characteristics .....	2-2
2.4 Mechanical characteristics .....	2-2
2.5 Power supply.....	2-3
<b>PART II OPERATION .....</b>	<b>3-1</b>
3 MAIN CABINET .....	3-1
3.1 Power on/off .....	3-1
3.2 Local Control Operation .....	3-2
3.2.1 Glossary.....	3-2
3.2.2 Pushbuttons.....	3-3
3.2.3 Switches/Switchlocks.....	3-3
3.2.4 System Status Indications .....	3-4
3.3 Local Keyboard/Display Operation.....	3-7
3.3.1 The menu structure.....	3-7
3.3.2 Handling the different menuscreens.....	3-8
3.3.3 The access levels.....	3-9
3.3.4 Function listing.....	3-10
3.3.5 The menu tree .....	3-11
4 TOWER EQUIPMENT .....	4-1
4.1 Remote Control Operation .....	4-1
4.1.1 Glossary.....	4-1
4.1.2 Pushbuttons.....	4-1
4.1.3 Switches/Switchlocks.....	4-2
4.1.4 System Status Indications .....	4-2
4.2 Remote Slave Operation.....	4-4
4.2.1 Glossary.....	4-4

4.2.2	Pushbuttons .....	4-4
4.2.3	System Status Indications .....	4-5
4.3	Interlock Switch Operation .....	4-5
<b>5</b>	<b>REMOTE MAINTENANCE AND MONITORING SOFTWARE .....</b>	<b>5-1</b>
5.1	Introduction.....	5-1
5.1.1	Description.....	5-1
5.1.2	Available versions.....	5-1
5.1.3	System requirements.....	5-1
5.1.4	Running under Microsoft Windows 3.xx .....	5-2
5.1.5	How to use this manual .....	5-2
5.1.6	Starting the RMM software .....	5-2
5.2	User interface components .....	5-2
5.2.1	The menu bar and menus.....	5-2
5.3	Shortcuts .....	5-3
5.3.1	The desktop area.....	5-3
5.3.2	The status line .....	5-5
5.3.3	Dialog boxes .....	5-5
5.4	Configuring the RMM system.....	5-7
5.4.1	Communications setup .....	5-7
5.4.2	IRQ setup.....	5-9
5.4.3	Printer setup .....	5-9
5.4.4	Preferences .....	5-10
5.4.5	Toggle video mode .....	5-11
5.4.6	Set date/time.....	5-11
5.5	Setting up ILS stations .....	5-11
5.6	Connecting to an ILS station .....	5-13
5.6.1	Shutting down the connection to an ILS .....	5-15
5.6.2	Baud rate recommendations.....	5-15
5.7	Monitor measurements and status.....	5-15
5.7.1	General .....	5-15
5.7.2	Monitor window.....	5-15
5.7.3	Additional monitor parameters window .....	5-16
5.7.4	External parameters window .....	5-17
5.7.5	Maintenance monitor window .....	5-17
5.7.6	User parameters window .....	5-20
5.8	Monitor settings.....	5-21
5.8.1	Limits Monitor 1&2.....	5-21
5.8.2	Limits Standby monitor .....	5-23
5.8.3	Delays.....	5-23
5.8.4	Limits Maintenance monitor.....	5-24
5.8.5	Delays Maintenance monitor .....	5-26
5.8.6	Analog user parameters .....	5-26
5.8.7	Digital user parameters.....	5-27
5.9	TX settings .....	5-28
5.9.1	TX Adjustments .....	5-28
5.9.2	Ident. and modulation switches .....	5-29
5.9.3	CLR mod. and DME settings .....	5-29
5.10	Power scaling.....	5-30
5.11	Front panel operation .....	5-31

5.12	Get historical data .....	5-31
5.12.1	General .....	5-31
5.12.2	Alarm storage specific .....	5-32
5.13	Continuous data logging.....	5-32
5.14	Events .....	5-33
5.15	Test DDM .....	5-34
5.16	Set ILS date/time.....	5-35
5.17	User administration .....	5-36
5.18	ILS Modem settings.....	5-37
5.19	Upload configuration to ILS.....	5-37
5.20	Write configuration to file.....	5-38
5.21	Lamp mappings.....	5-39
5.22	Medium storage sample interval .....	5-39
5.23	Displaying stored measurements .....	5-40
5.23.1	General .....	5-40
5.23.2	Medium time periodic (MED) .....	5-41
5.23.3	Alarm storage (ALA) .....	5-41
5.23.4	Continuous data log (CNT) .....	5-42
5.24	DIAGNOSTICS.....	5-42
5.24.1	General description of the diagnostic functions .....	5-42
5.24.2	Current data diagnostics.....	5-42
5.24.3	Alarm Event diagnostics .....	5-42
5.25	Exporting data .....	5-42
5.26	Printing reports .....	5-43
5.27	Print screen .....	5-43
5.28	Technical note - Leased line SETUP (USRobotics).....	5-44
5.28.1	Definitions .....	5-44
5.28.2	Configuring the remote modem .....	5-44
5.28.3	Configuring the local modem .....	5-44
5.29	Technical note - Dial up connection SETUP (USRobotics).....	5-45
5.29.1	Definitions .....	5-45
5.29.2	Configuring the remote modem .....	5-45
5.29.3	Configuring the local modem .....	5-46
5.30	Technical note - Leased line SETUP (WESTERMO).....	5-47
5.30.1	DIP switch settings. ....	5-47
5.30.2	Connecting the modem to the cabinet. ....	5-47
5.30.3	Connecting the modem to the PC.....	5-47
5.31	Technical note - dial up SETUP (WESTERMO).....	5-48
5.31.1	DIP switch settings. ....	5-48
5.31.2	Connecting the modem to the cabinet. ....	5-48
5.31.3	Connecting the modem to the PC.....	5-48
<b>PART III</b>	<b>MAINTENANCE .....</b>	<b>6-1</b>
<b>6</b>	<b>PERIODIC MAINTENANCE CAT I AND II.....</b>	<b>6-1</b>
6.1	Weekly inspections.....	6-1
6.1.1	Monitor Parameters recordings .....	6-1
6.2	Monthly inspections.....	6-1
6.3	Quarterly inspections.....	6-1

6.3.1 Tx Parameters and DC Power supply recordings.....	6-1
6.3.2 Monitor Integrity Check (Alternative 1) .....	6-2
6.3.3 Monitor Integrity Check (Alternative 2) .....	6-2
6.4 Annual inspections .....	6-3
6.4.1 RF Frequency check.....	6-3
6.4.2 LF Frequency check. ....	6-4
6.4.3 Transmitter waveforms checks. ....	6-4
6.4.4 (Not in use)CSB output power. ....	6-6
6.4.5 Monitor Alarm Limit checks.....	6-6
6.4.6 Near Field Monitor delay.....	6-10
6.4.7 20 seconds inhibit .....	6-10
6.4.8 Battery maintenance .....	6-10
6.4.9 Final check GP .....	6-10
<b>7 CORRECTIVE MAINTENANCE .....</b>	<b>7-1</b>
7.1 Overview .....	7-1
7.2 Diagnostic functions .....	7-1
7.2.1 General description.....	7-1
7.2.2 Current data diagnostics.....	7-1
7.2.3 Alarm event diagnostics.....	7-1
7.2.4 Manual fault diagnosis .....	7-2
7.3 LRU change procedures .....	7-2
7.3.1 Replacing units .....	7-2
7.3.2 MF1211/MF1219 replacement.....	7-3
7.3.3 PS1227 replacement .....	7-4
7.3.4 OS1221 replacement.....	7-4
7.3.5 MO1212 replacement .....	7-5
7.3.6 TCA1218 replacement.....	7-5
7.3.7 RMA1215 replacement .....	7-6
7.3.8 LF1223 replacement.....	7-6
7.3.9 COA1207 replacement .....	7-6
7.3.10LPA1230/GPA1231/GPA1232 replacement .....	7-7
7.4 Detailed description of the automatic diagnostic algorithms .....	7-7
7.4.1 Overview .....	7-7
7.4.2 Possible diagnostic solutions.....	7-7
7.4.3 Current data diagnostics.....	7-8
7.4.4 Alarm event diagnostics.....	7-11
<b>PART IV APPENDIX.....</b>	<b>A-1</b>
A Monitor and Maintenance Parameters .....	A-1
A.1 Monitor Alarm Parameters .....	A-1
A.2 Maintenance Parameters .....	A-2
B Factory default configuration settings.....	B-1
B.1 Cat I monitor LIMIT configuration .....	B-1
B.2 Cat II monitor LIMIT configuration.....	B-3
B.3 Cat III monitor LIMIT configuration.....	B-3
B.4 Executive Monitor delay configuration.....	B-3

B.5	Maintenance parameter configuration.....	B-4
B.6	Oscillator 1 and 2 (OS 1221).....	B-4
B.7	Maintenance delay configuration.....	B-7
B.8	Morse code configuration.....	B-7
B.9	Typical TX Adjustments values.....	B-7
B.10	User administration configuration.....	B-8
B.11	Frequency configuration strap settings.....	B-8
C	Maintenance Procedures.....	C-1





## LIST OF FIGURES

Figure 1-1	GP block diagram .....	1-1
Figure 3-1	Power ON/OFF and GND Sockets Location .....	3-1
Figure 3-2	LC1217A front panel .....	3-2
Figure 3-3	The local keyboard/display .....	3-7
Figure 3-4	The top level main menu screen. ....	3-8
Figure 3-5	A typical readout screen: CL DDM. ....	3-8
Figure 3-6	A typical toggle screen: TX1 90Hz on/off. ....	3-9
Figure 3-7	A typical input/store screen: CL DDM .....	3-9
Figure 3-8	A typical quick read screen: CL. ....	3-9
Figure 3-9	An access denial screen: Switch in REMOTE position. ....	3-10
Figure 3-10	Level 3 access screen. ....	3-10
Figure 3-11	The top level main menu screen: User in level 3 access. ....	3-10
Figure 3-12	The menu tree: The top levels .....	3-12
Figure 4-1	RF1242A front panel. ....	4-1
Figure 4-2	SF1344A front panel. ....	4-4
Figure 5-1	A sample dialog box. ....	5-6
Figure 5-2	Com port setup dialog .....	5-8
Figure 5-3	Channel setup dialog .....	5-8
Figure 5-4	IRQ setup dialog .....	5-9
Figure 5-5	Print setup dialog .....	5-10
Figure 5-6	Preferences dialog .....	5-11
Figure 5-7	Set date/time dialog .....	5-11
Figure 5-8	Station list dialog. ....	5-12
Figure 5-9	ILS Station setup dialog .....	5-13
Figure 5-10	Login dialog box .....	5-14
Figure 5-11	A typical Link window .....	5-15
Figure 5-12	Monitor window .....	5-16
Figure 5-13	Additional monitor parameters window .....	5-17
Figure 5-14	External parameters window .....	5-17
Figure 5-15	Maintenance monitor window .....	5-18
Figure 5-16	Monitor maintenance parameters .....	5-19
Figure 5-17	TX maintenance parameters .....	5-19
Figure 5-18	PA maintenance parameters .....	5-20
Figure 5-19	DC-Supplies maintenance parameters .....	5-20
Figure 5-20	RMS maintenance parameters .....	5-20
Figure 5-21	TX Control maintenance parameters .....	5-20
Figure 5-22	User parameters window (sample configuration). ....	5-21
Figure 5-23	Monitor 1&2 limits window .....	5-22
Figure 5-24	Monitor parameter input dialog .....	5-23
Figure 5-25	Monitor delays window .....	5-24
Figure 5-26	Delay input dialog .....	5-24
Figure 5-27	Analog maintenance monitor limits window .....	5-25
Figure 5-28	Digital maintenance monitor limits window .....	5-25
Figure 5-29	Input dialog for digital maintenance parameters .....	5-26
Figure 5-30	Input dialog for analog maintenance parameters .....	5-26
Figure 5-31	Maintenance delay window .....	5-26

Figure 5-32	Analog user parameters definitions .....	5-27
Figure 5-33	Analog user parameter settings dialog .....	5-27
Figure 5-34	Digital user parameters definitions .....	5-27
Figure 5-35	Digital user parameters settings dialog .....	5-28
Figure 5-36	TX adjustments window .....	5-28
Figure 5-37	TX Adjustment input dialog .....	5-29
Figure 5-38	Ident. and modulation switches window .....	5-29
Figure 5-39	CLR mod. and DME settings dialog .....	5-30
Figure 5-40	Power scaling settings .....	5-30
Figure 5-41	Front panel window .....	5-31
Figure 5-42	Storage download window .....	5-32
Figure 5-43	Continuous logging dialog .....	5-33
Figure 5-44	Events window .....	5-34
Figure 5-45	Test DDM window .....	5-35
Figure 5-46	ILS date/time window. ....	5-35
Figure 5-47	User administration window .....	5-36
Figure 5-48	User configuration dialog .....	5-37
Figure 5-49	ILS Modem settings window. ....	5-37
Figure 5-50	Configuration upload .....	5-38
Figure 5-51	Write configuration to file. ....	5-39
Figure 5-52	Lamp mappings HBK1142 .....	5-39
Figure 5-53	Medium storage interval setting dialog .....	5-40
Figure 5-54	Open log file dialog .....	5-40
Figure 5-55	MED file log window .....	5-41
Figure 5-56	ALA file log window .....	5-41
Figure 5-57	CNT file log window. ....	5-42
Figure 5-58	Export data dialog .....	5-43
Figure 5-59	Print Report dialog .....	5-43
Figure 5-60	ILS port settings for leased-line connections .....	5-44
Figure 5-61	RMM channel setup for USR leased-line connections .....	5-45
Figure 5-62	ILS port settings for USRobotics dial up connection .....	5-46
Figure 5-63	Local modem configuration .....	5-46
Figure 7-1	Flow diagram for Monitor warning tests. ....	7-11
Figure 7-2	Flow diagram for diagnosing a changeover-only alarm. ....	7-12
Figure 7-3	Flow diagram for diagnosing changeover/shutdown alarms. ....	7-13

## LIST OF TABLES

Table 5-1	Shortcut commands. ....	5-3
Table 5-2	Quick window operations. ....	5-5
Table 5-3	Channel setup operations. ....	5-9
Table 5-4	Print setup operations. ....	5-10
Table 5-5	Station list operations. ....	5-12
Table 5-6	ILS station setup operations. ....	5-13
Table 5-7	Login access rights. ....	5-14
Table 5-8	Monitor codes. ....	5-15
Table 5-9	Status codes. ....	5-18
Table 5-10	Morse code settings. ....	5-29
Table 5-11	CLR modulation and DME settings. ....	5-30
Table 5-12	Filename extensions. ....	5-32
Table 5-13	Master user available operations. ....	5-36
Table 5-14	Master user operations. ....	5-36
Table 5-15	Medium time storage interval settings ....	5-40
Table 5-16	Alarm storage operations. ....	5-41
Table 6-1	Monitor 1 window (Tx 1 to Air) ....	6-11
Table 6-2	Monitor 1 window (Tx 2 to Air) ....	6-11
Table 6-3	Monitor 1 window ....	6-12
Table 6-4	Front panel window (displays Tx1 to air) ....	6-12
Table 6-5	Monitor 1 window ....	6-13
Table 6-6	Front panel window (Displays Tx2 to air) ....	6-13
Table 6-7	(Not for recordings, make a "print screen copy") ....	6-14
Table 6-8	Transmitter waveform checks ....	6-14
Table 6-9	Monitor Integrity Test (Alternative 1) ....	6-15
Table 6-10	Monitor Integrity Test (Alternative 2) ....	6-15
Table 6-11	RF Frequency check ....	6-15
Table 6-12	LF Frequency check ....	6-15
Table 6-13	CSB output power ....	6-15
Table 6-14	Monitor Alarm Limits check ....	6-16
Table 6-15	Near Field Monitor Delay and 20 seconds inhibit ....	6-16
Table 6-16	Battery maintenance ....	6-16
Table A-1	Monitor Alarm Parameters - Monitor Window 1. ....	A-1
Table A-2	Monitor Alarm Parameters - Monitor Window 2. ....	A-1
Table A-3	Logical Maintenance Parameters.....	A-3
Table A-4	Analog Maintenance Parameters.....	A-3
Table A-5	DC Supplies Maintenance Parameters.....	A-4
Table A-6	User Defined Analog Inputs Maintenance Parameters.....	A-4
Table A-7	User Defined Logical Inputs/Outputs Maintenance Parameters. ....	A-4
Table B-1	CAT I alarm and warning limits. ....	B-2
Table B-2	Alarm and warning limits for Cat II equipment. ....	B-3
Table B-3	Alarm and warning limits for Cat III equipment. ....	B-3
Table B-4	Factory default delay values. ....	B-4
Table B-5	Typical TX adjustment values ....	B-8
Table B-6	OS1221B Course frequency settings for 2-freq. GP.....	B-9
Table B-7	OS1221B Clearance frequency settings for 2-freq. GP.....	B-10

---

Table C-1 CEGS Monitor Reference Data.....C-9  
Table C-2 All Glide Slopes Normal Radiated Parameters .....C-9

## PART I DESCRIPTION

### 1 SYSTEM DESCRIPTION

#### 1.1 System Overview

The NM 7000-series Glidepaths comprises the following units or sub-systems:

- Glidepath Cabinet
- Power Supply
- Remote Control
- RMM System (Optional)

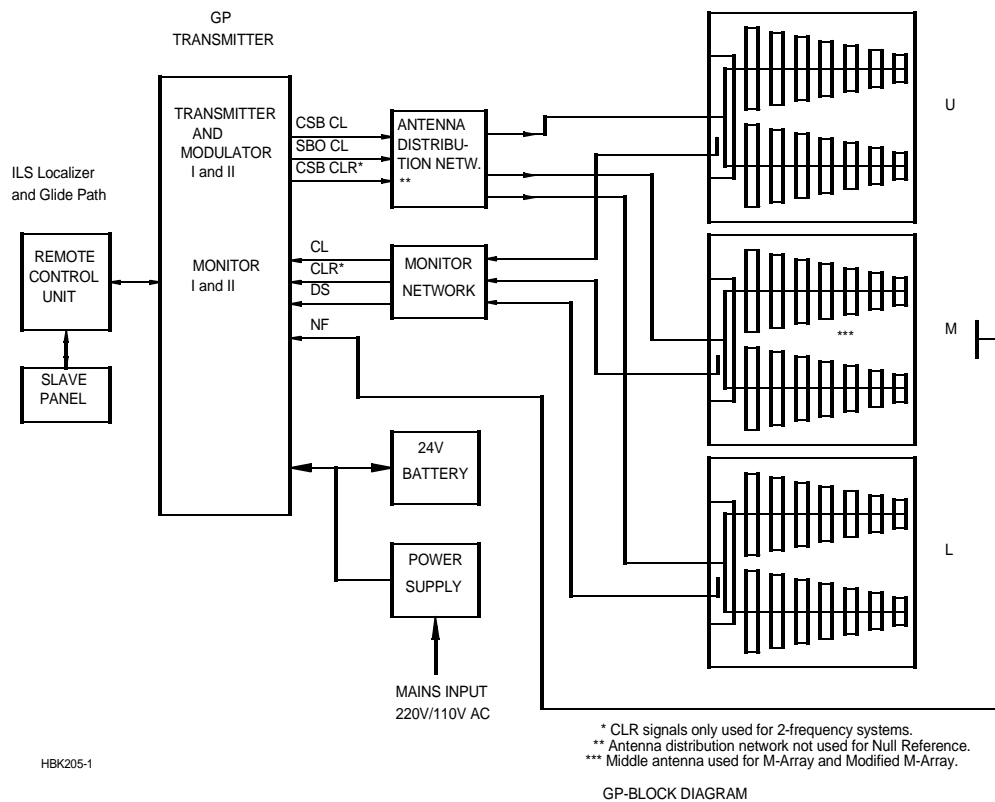

Figure 1-1 GP block diagram

The Antenna System with distribution and monitor networks are described in a separate manual.

The Glidepath cabinet comprises:

- Dual transmitter/modulators
- Dual monitors in "2 out of 2" voting
- Priority and change-over system with local control panel
- Remote monitoring system with local display and RS-232 ports for local and remote PC connections.

The Power supply is a separate, wall mounted unit. Back-up batteries are float charged, and are connected to the GP cabinet.

The Remote Control unit is intended for installation in the tower or a technical room to give remote control and status indication. An optional Remote Slave panel can be used if control and status indication is required in additional positions.

The RMM system comprises the built-in RMS system in the GP cabinet, and a data program running on a standard PC. The PC can be connected directly to the cabinet, or by modems through leased or switched telephone lines.

## 1.2 Abbreviations

AC	Alternating Current
ADC	Analog to Digital Converter
AGC	Automatic Gain Control
CL	Course Line
CLR	Clearance
COU	Course
CPU	Central Processing Unit
CS	Course Sector
DAC	Digital to Analog Converter
DC	Direct Current
DDM	Difference in Depth of Modulation
DF	Difference Frequency
DL	DC Loop
DS	Displacement Sensitivity
DSP	Digital Signal Processor
EEPROM	Electrically Erasable Programmable Read Only Memory
EMC	ElectroMagnetic Compatibility
EMI	ElectroMagnetic Interference
EPROM	Erasable Programmable Read Only Memory
FFT	Fast Fourier Transform
FIFO	First-In-First-Out
FPGA	Field Programmable Gate Array
GPA	Glidepath Power amplifier Assembly
I/F	InterFace
I <sup>2</sup> C	Inter Integrated Circuit
IIC	Same as I <sup>2</sup> C
ILS	Instrument Landing System
LED	Light Emitting Diode
LF	Low Frequency
LLZ	Localizer
LPA	Localizer Power amplifier Assembly
LRU	Line Replacable Unit
MCU	Monitor Combiner Unit
NAV	NAVigation signals
NF	Near Field
PC	Personal Computer
RAM	Random Access Memory

RF	Radio Frequency
RMM	Remote Maintenance Monitor
RMS	Remote Monitoring System
ROM	Read Only Memory
RTC	Real Time Clock
SC	Station Control
SDM	Sum in Depth of Modulation
SPA	Same Parameter Alarm
SRAM	Static Random Access Memory
STB	Standby
SW	SoftWare
TRM	TeRMinator
TX	Transmitter
UART	Universal Asynchronous Receiver Transmitter





## 2 Technical specifications

NM 7033 Two-Frequency Glidepath Cabinet.

### 2.1 Signal Minimum Performance GP

#### Transmitter

Frequency range	328.6-335.4 MHz
Frequency tolerance	± 0.002%
Output power (CSB + SBO) course	3-7 W adjustable
Output power (CSB) clearance	0.3-1 W adjustable
Harmonic radiation	2.5 uW maximum
RF difference frequency (2-freq. only)	15 kHz ± 5 kHz
Spurious	25 uW maximum
Output power stability	± 0.2 dB
CSB/SBO stability	± 0.3 dB

#### Modulator - course line

Modulation depth 90/150 Hz	40%
Adjustable range	10-44%
SDM stability	± 0.8% SDM
DDM stability	± 0.2% DDM
Frequency tolerance	± 0.05 Hz
Total harmonic distortion (90/150 Hz)	1% maximum
Phase locking (90 Hz to 150 Hz)	5° maximum ref 150 Hz
SBO phaser adjustment range	± 30°

#### Modulator - clearance

Modulation depth	80%
90 Hz component	20%
150 Hz component	60%
Adjustable range DDM	20-100% 150Hz dominance
Adjustable range SDM	20-90%
Stability	± 0.2 dB
Frequency tolerance	± 0.05 Hz
Total harmonic dist. (90/150 Hz)	1% maximum
Phase locking (90 Hz to 150 Hz)	5° maximum ref 150 Hz

#### Monitoring

Alarm functions	Adjustable range (*)
RF power reduction	1-5 dB
Change of nominal CL	± 10-60 uA
Change of nominal DS from nominal value	± 10-60 uA
Change of nominal CLR (2-freq. only)	± 10-60 uA
Change of nominal NF	± 10-60 uA
Change of nominal SDM	± 2-8% SDM
Difference frequency (2-freq. only)	± 2-5 kHz
Total period of radiation out of tolerance	1-6 sec

Additional NF delay	0-20 sec
Line break, ILS-remote control (disable optional).	
Monitor input levels	
Adjustment range, nominal level:	-5 to -34 dBm
AGC range for less than 1% change in SDM	5 dB
Monitor stability at nominal levels:	
RF power values	$\pm 0,3$ dB
DDM values	$\pm 1$ $\mu$ A
SDM values	$\pm 1\%$ SDM
Warning functions:	
RF power reduction	40-75% of alarm limit
Change of nominal CL	40-75% of alarm limit
Change of nominal DS	40-75% of alarm limit
Change of nominal CLR	40-75% of alarm limit
Change of nominal NF	40-75% of alarm limit
Change of nominal SDM	40-75% of alarm limit
Difference frequency	40-75% of alarm limit
Mains failure	
Remote control	
Data transmission medium	2-wire line, 600 ohm
Data modulation	serial, FSK
Transmitter level	-10dBm $\pm 2$ dB
Receiver dynamic range	-10dBm to -34dBm

(\*): Asymmetrical limits are possible

## 2.2 *Environmental characteristics*

Operating temperature:	-10 to +55 °
Storage temperature	-30 to +60 °

## 2.3 *EMC characteristics*

EMR:	EN 55022 class B
Spurious and harmonics:	CISPR 22

## 2.4 *Mechanical characteristics*

Dimensions: (HxBxW)	
ILS Rack:	1020x600x500 mm
Remote control:	129x71x170 mm
Slave panels:	129x41x170 mm
Weight:	85 kg - 95 kg depending on model

The ILS rack is wall mounted. The remote control and slave panels fit a standard 3U (132mm)

high 19" subrack.

## **2.5 Power supply**

External supply:

Input voltage:	230V +15%/-20%,45-65 Hz or 120V +15%/-20%, 45-65 Hz
Output voltage:	27,6V
Output current:	20A max

ILS cabinet:

Input voltage:	22-28V DC
Current consumption:	8A – 14A depending on configuration
Stand-by battery	24V DC nominal, 85 Ah-110Ah valve regulated lead-acid battery recommended



## PART II OPERATION

### 3 Main cabinet

#### 3.1 Power on/off

The power ON/OFF switches are located on front of the main cabinet. Adjacent to the switches are GND sockets for connecting wrist strap to ensure ESD-protected environment when performing maintenance operations.

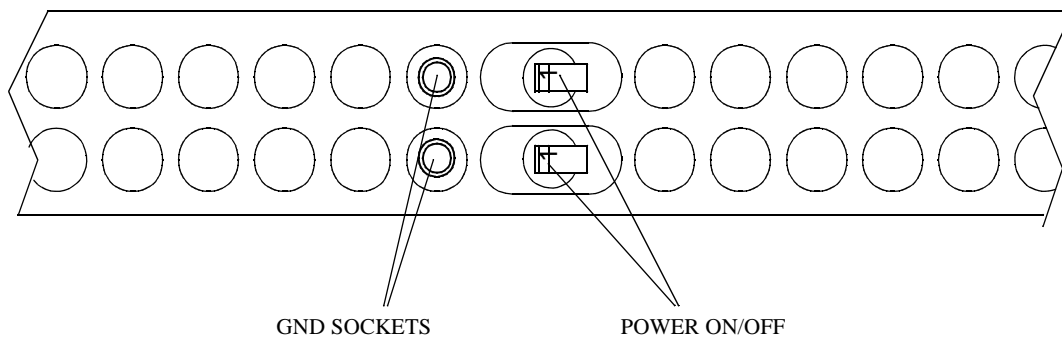

HBK548-1

*Figure 3-1 Power ON/OFF and GND Sockets Location*

**3.2 Local Control Operation**

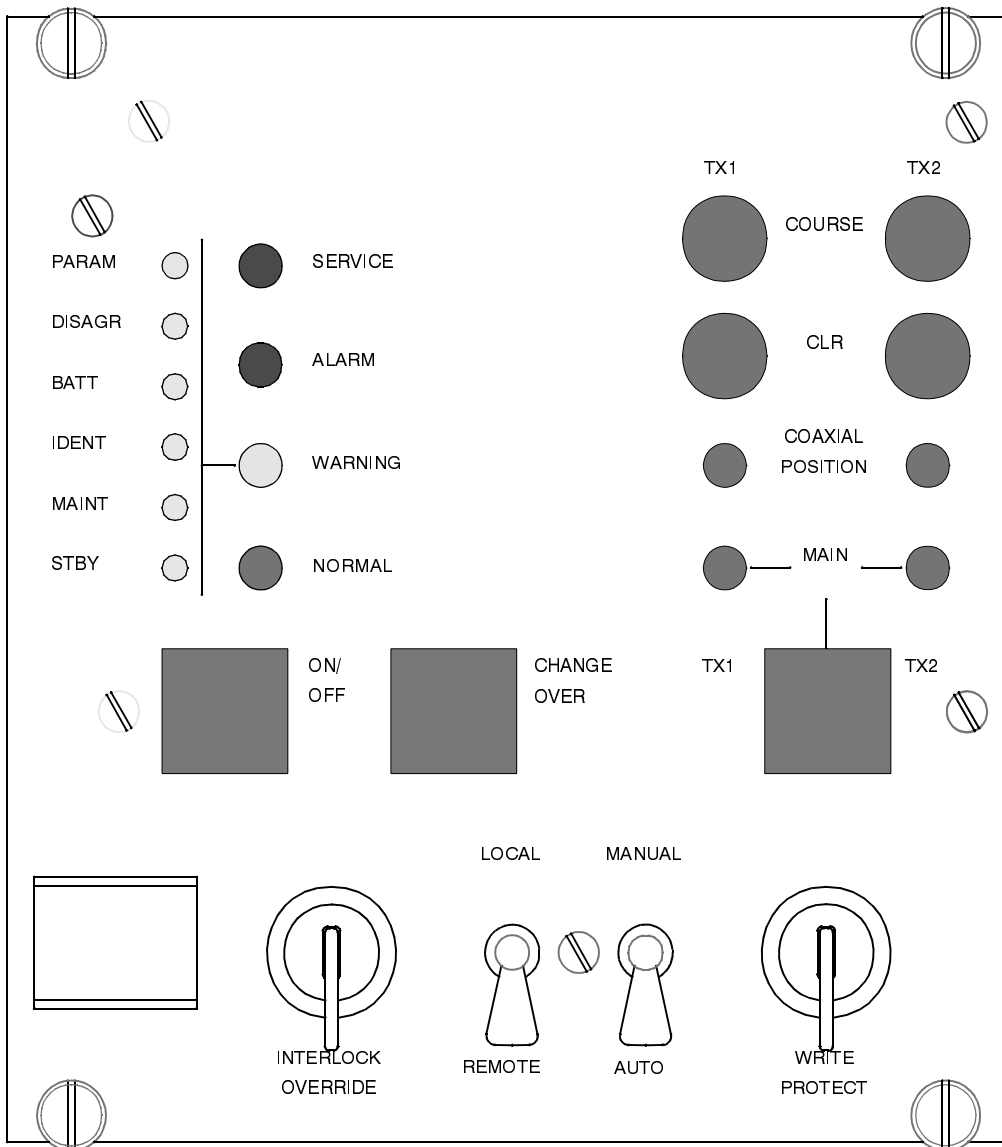

HBK 551/1

Figure 3-2 LC1217A front panel

**3.2.1 Glossary**

- Changeover** The transition from a normal ILS «on» state (coax pos=main select and active main transmitters on air) to a normal ILS «standby on» state (coax pos. not equal to main select, and standby transmitters active on air).
- Shutdown** The transition from any ILS state to a normal ILS «off» state (coax pos=main select and no active transmitters).
- Automatic** When the ILS is in automatic mode of operation, any detected alarm(s) will lead to either CHANGEOVER or SHUTDOWN.
- Manual** When the ILS is in manual mode of operation, the ILS state will not change if alarm(s) are detected.
- Interlock** When an ILS is in active interlock mode (the interlock signal is an input to the

remote control), the ILS will turn off all active transmitters and not allow them to be turned on before the interlock condition is removed. This signal overrides manual mode of operation.

**3.2.2 Pushbuttons**

ON/OFF

Used to:

- Toggle the ILS on/off.

Valid when:

- The LOCAL/REMOTE switch must be in LOCAL position, and
- The interlock signal is not active if the ILS is configured for interlock.

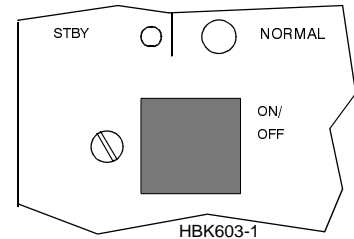

CHANGEOVER

Used to:

- Toggle the coax relay and transmitters between TX1/ TX2 as the active transmitter(s).

Valid when:

- The LOCAL/REMOTE switch is in LOCAL position, and
- The ILS is «on» when the MANUAL/AUTO switch is in AUTO position.

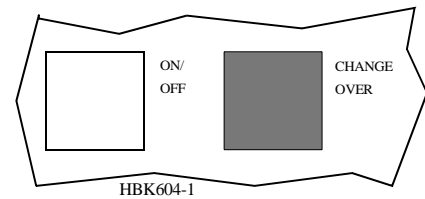

MAIN SELECT

Used to:

- Toggle between TX1/TX2 as the main transmitter.

Valid when:

- The LOCAL/REMOTE switch is in LOCAL position.

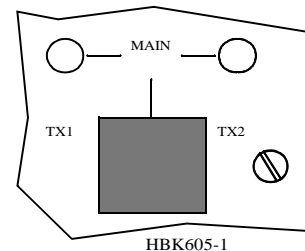

COURSE TX1/TX2

Used to:

- Toggle the COURSE TX1/TX2 on/off.

Valid when:

- LOCAL/REMOTE switch is in LOCAL position, and
- MANUAL/AUTO switch is in MANUAL position, and
- The interlock signal is active if the ILS is configured for interlock.

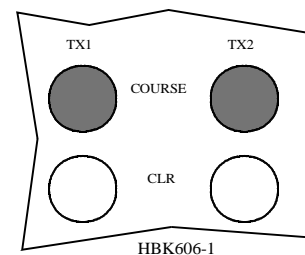

CLEARANCE TX1/TX2

Used to:

- Used to toggle the CLEARANCE TX1/TX2 on/off.

Valid when:

- CLEARANCE transmitters are present, and
- LOCAL/REMOTE switch is in LOCAL position, and
- MANUAL/AUTO switch is in MANUAL position, and
- The interlock signal is active if the ILS is configured for interlock.

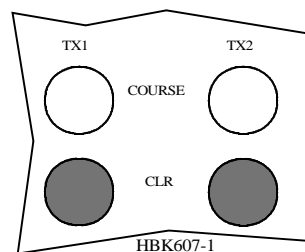

**3.2.3 Switches/Switchlocks**

**LOCAL / REMOTE**

Used to:

- Select between LOCAL and REMOTE mode of operation. REMOTE mode of operation will inhibit use of the local push-button (as described above) and the use of the local serial communication port for entering RMS access level 2 and 3. LOCAL mode of operation will inhibit use of the remote control push-buttons (ON/OFF, CHANGEVER) and the use of the remote serial communication ports for entering RMS access level 2 and 3.

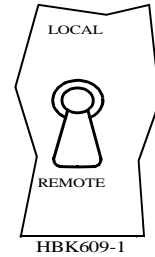

Valid when:

- The LOCAL/REMOTE switch is in LOCAL position.

**MANUAL / AUTO**

Used to:

- Select between AUTOMATIC and MANUAL mode of operation.

Valid when:

- The LOCAL/REMOTE switch is in LOCAL position.

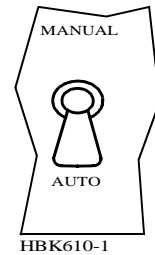

**WRITE PROTECT**

Used to:

- Prevent changing of alarm limits and other ILS parameter adjustments. Setting this switchlock in vertical/horizontal position will prevent/not prevent entering of access level 3

Valid when:

- Always

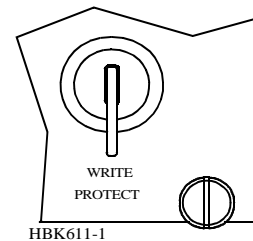

**INTERLOCK OVERRIDE**

Used to:

- Override the interlock input to allow testing of transmitters. Using this function will allow the local panel pushbuttons to be used (ON/OFF, CHANGEVER and the individual TX on/off keys).

Valid when:

- The LOCAL/REMOTE switch is in LOCAL position, and
- The MANUAL/AUTO switch is in MANUAL position.

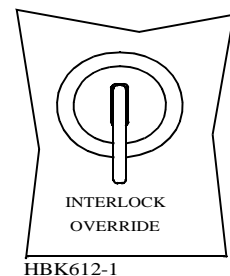

**3.2.4 System Status Indications**

**SERVICE**

Used to:

- Indicate that the ILS is currently in SERVICE mode of operation. This will also set the remote control to alarm state.

Activated by:

- EXTERNAL SERVICE line forced low (by LF1223A set in service condition), or
- RMS in access level 2 or 3, or
- The LOCAL/REMOTE switch is in LOCAL position, or
- The MANUAL/AUTO switch is in MANUAL position, or
- MANUAL mode entered from RMS, or
- Mismatch between the WRITE PROTECT switch and configuration strap setting on U6 (strap position 6-15).

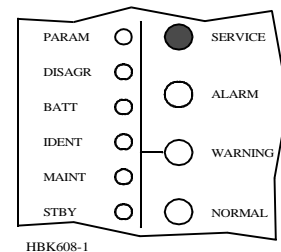



**ALARM**

Used to:

- Indicate that the ILS has detected an alarm condition.

Activated by:

- One or more alarms present.

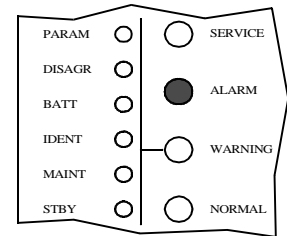

HBK613-1

**WARNING**

Used to:

- Indicate that the ILS has detected one or more warning conditions.

Activated by:

- Warning condition(s) detected by RMS.

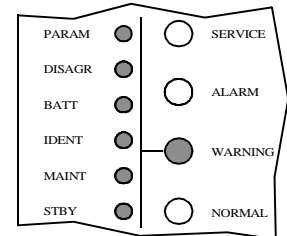

HBK614-1

**NORMAL**

Used to:

- Indicate that no alarm conditions are detected by the ILS.

Activated by:

- No alarms present.

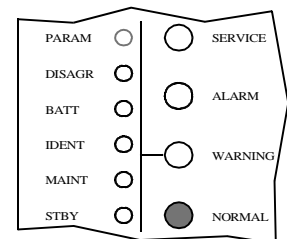

HBK615-1

**PARAMETER WARNING:**

Used to:

- Indicate that there are one or more monitor parameter warnings present. The warnings from the monitor 1/monitor 2 are voted before displayed.

Activated by:

- One or more monitor parameters outside the warning limits.

**MONITOR DISAGREE**

Used to:

- Indicate that monitor 1 and monitor 2 disagrees on which parameters that are in alarm state.

Activated by:

- Difference in monitor 1/monitor 2 alarm detection.

**BATTERY WARNING**

Used to:

- Indicate that the ILS is running using the 27V battery.

Activated by:

- Loss of mains for charging the 27V battery.

**IDENT WARNING**

Used to:

- Indicate that the ident is faulty for LLZ.

Activated by:

- Loss of ident Morse coding for LLZ.

**MAINTENANCE WARNING**

Used to:

- Indicate that one or more of the maintenance parameter warnings detected.

Activated by:

- One or more maintenance parameters faulty or outside limits.

**STANDBY TRANSMITTER ON AIR**

Used to:

- Indicate that coax position directs the standby transmitters to the antenna and the main transmitters to the dummy load.

Activated by:

- Coax position differs from transmitter main select.

**COAXIAL POSITION TX1/TX2**

Used to:

- Indicate the position of the coax relay.

Activated by:

- Coax relay position.

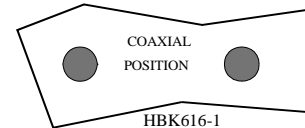

**MAIN TX1/TX2**

Used to:

- Indicate which transmitter that is defined as main.

Activated by:

- Main select position.

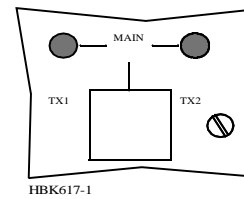

**COURSE TX1/TX2**

Used to:

- Indicate the status of COURSE 1/COURSE 2 status. If illuminated the transmitter is on.

Activated by:

- Transmitter «on».

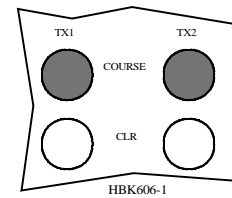

**CLEARANCE TX1/TX2**

Used to:

- Indicate the status of CLEARANCE 1/CLEARANCE 2 status. If illuminated the transmitter is on.

Activated by:

- Transmitter «on».

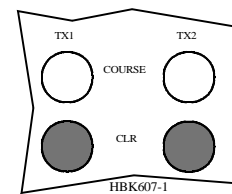

### 3.3 Local Keyboard/Display Operation

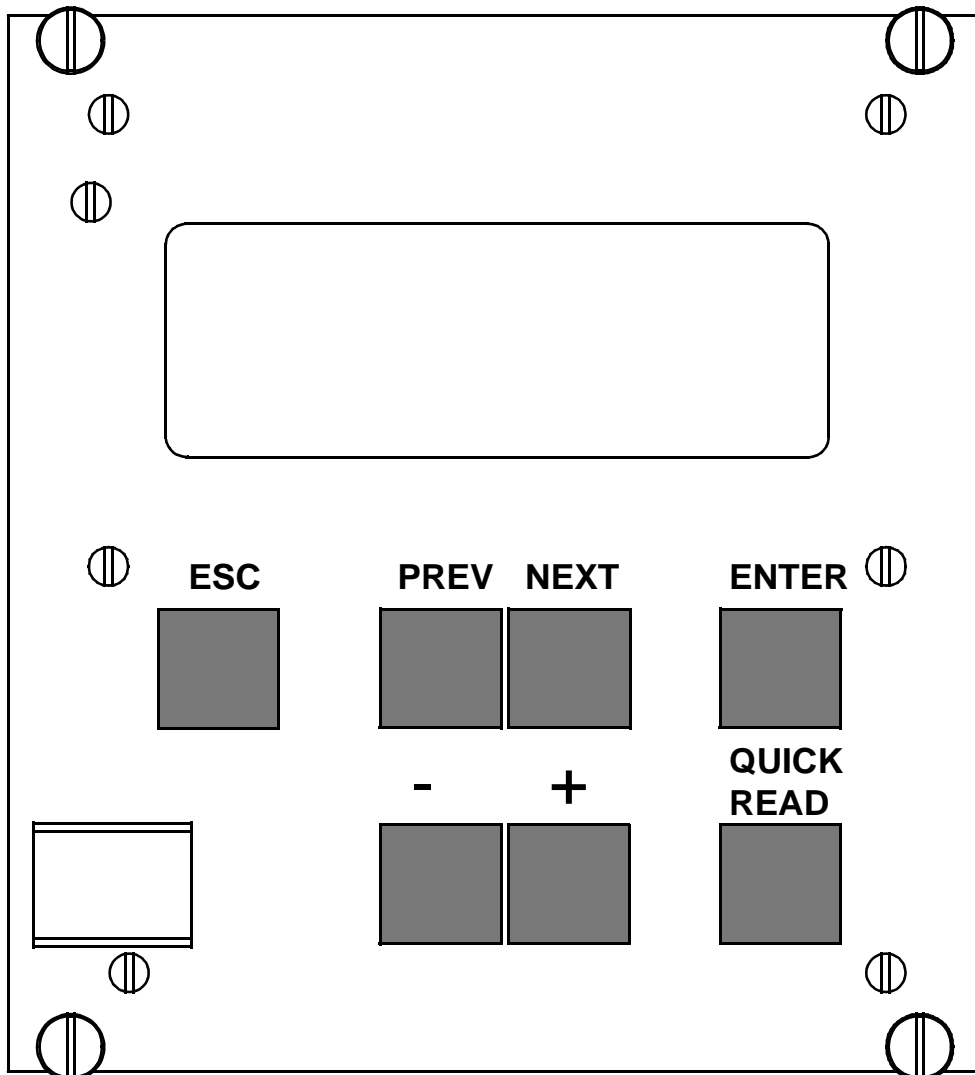

HBK550-1

Figure 3-3 The local keyboard/display

#### 3.3.1 The menu structure.

The front panel menu system includes a 20x4 character LCD with 7 dedicated pushbutton keys. The system is organised as a top-down menu tree-structure where the main menu is the default entering point.

The main menu screen has three menu-options. The options are divided into the three access levels; **level 1** with basic readout functions, **level 2** with test and control functions and **level 3** with permanent system parameter settings and configuration changes.

>Read syst para	L1
Local settings	L2
Syst settings	L3

Figure 3-4 The top level main menu screen.

### 3.3.2 Handling the different menuscreens.

The menu system consists of **five** basic screen types; menu-screens, readout-screens, toggle-screens, input/storing-screens, and the quick read screens.

#### 3.3.2.1 The menu screen

The menu screen is controlled by the key-buttons: <PREV> <NEXT> <ENTER> and <ESC>.

The menu options are formatted as a long list where each option holds one character line. If a menu screen includes more than four options, a small arrow-indicator will be displayed in the lower-right corner. This informs the user that more than four menu options are available. The blinking arrow cursor left to the menu-text is controlled by the <NEXT> and <PREV> keys. The <ENTER> key activates the menu options left to the arrow-cursor.

The <ESC> key brings the user one menu-level upwards or back in the menu-tree-structure. The menu scrolls down if the user pushes the <NEXT> key when the arrow-cursor is at the lower line and the arrow indicator is displayed in the lower-right corner. The menu will in the same way scroll upwards by pushing the <PREV>-key in a corresponding situation.

#### 3.3.2.2 The readout screen

The readout screens display the various monitor and maintenance parameter readings. The screens are entered by stepping through the menu options. The <ESC> key brings the user back to the last menu-screen again. The parameter readings are continuously updated.

CL readout		M1	M2
DDM.:		0.1%	0.1%
AI	U	+1.5%	+1.5%
Wa	U	-1.5%	-1.5%

Figure 3-5 A typical readout screen: CL DDM.

#### 3.3.2.3 The toggle screens

The toggle screens offer the user to choose between two or more options. The options text is enclosed by two blinking square-brackets. The plus «+» and minus «-» keys step through the various options. The <ENTER> key activates the chosen toggle-option. The <ESC> keys leaves the screen without activating any of the options.

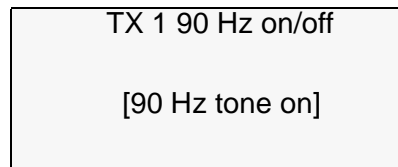

Figure 3-6 A typical toggle screen: TX1 90Hz on/off.

### 3.3.2.4 Input/Store screen

The user can change the various parameter alarm and warning settings in the input/storing-screens. A virtual cursor is controlled by the <PREV> and <NEXT> keys. An input field number will blink if the cursor is moved to the correct position. The blinking limit values can now be changed by pushing the plus «+» and minus «-» keys. If the input field is digital, the valid options will be «False» and «True» when the plus «+» and minus «-» keys are pushed.

When all the input numbers in the screen are changed to the preferred new values, the cursor must be moved to the (STORE)-field in the upper left corner. When the cursor is placed at this (STORE)-field, the brackets will start blinking. The <ENTER> key will now store the new values on the screen in the ILS. The <ESC> key leaves the screen unchanged.

CL <store>	M1	M2
DDM.:	0.1%	0.1%
Al U	+1.5%	+1.5%
Wa U	-1.5%	-1.5%

Figure 3-7 A typical input/store screen: CL DDM

### 3.3.2.5 The quick read screens

The quick read screens are access by pushing the <QUICK READ> key. The key toggles between the original menu tree and the quick read screens. The <QUICK READ> button can be pushed at all times, not changing the original menu-screens. The quick read screens include only the basic monitor readings. The <PREV> and <NEXT> keys step through the quick read screens.

CL	%DDM	%SDM	RFv
M1	0.1	40.0	3.0
M2	0.1	40.0	3.0

Figure 3-8 A typical quick read screen: CL.

## 3.3.3 The access levels.

The level 3 menu options must be entered by typing a 4 character password. The level 2 menu can be entered as an ordinary menu-option.

### 3.3.3.1 Level 2

To enter the level 2 menu option, the front panel switches must be in the LOCAL and MANUAL positions. The remote panel access switch must also be in ACCESS position. The user is

denied access if the switches are not correctly set.

Local switch on Front panel in REMOTE position Push <ESC>
--

Figure 3-9 An access denial screen: Switch in REMOTE position.

### 3.3.3.2 Level 3

To enter the level 3 menu option, the front panel switches must be as for level 2 access. In addition the WRITE PROTECT switch must be in «ACCESS» position. The user must key a 4 character password to enter level 3 access. The access-screen is operated similarly to an input/store-screen. The blinking cursor is moved by the <PREV> and <NEXT> keys. A blinking input-field is changed by the plus «+» and minus «-» keys.

When the correct password is entered, the cursor must be moved to the <level 3 access>-field. The brackets will then start blinking. The <ENTER> key will now bring the user to the level3 options. The <ESC> key leaves the screen back to the main menu.

LEVEL ACCESS 3 m m m m <level3 access>
---

Figure 3-10 Level 3 access screen.

### 3.3.3.3 Leaving the access levels

If the user enters level 2 or 3, an extra menu line is added in the main menu screen. This is a leave current access level option. The user must enter this menu option to quit the current access level - typically when leaving the ILS.

The access levels are also left when the front panel switches are changed to an illegal position. (e.g. switch in REMOTE position)

>Read syst para	L1
Local settings	L2
Syst settings	L3
Leave access 3	

Figure 3-11 The top level main menu screen: User in level 3 access.

## 3.3.4 Function listing

The menu system includes the following functionality.

### 3.3.4.1 Level 1

Readout of all the monitor values, warning and alarm limits.

Readout of all the maintenance values and warning limits.

Readout of all the delays.

Readout of all the TX1 and TX2 configurations.

### **3.3.4.2 Level 2**

Ident. configurations with morse signal settings to normal, continuous, TST or off on TX1/TX2.  
Local morse speaker on/off on the transmitters.

TX1 and TX2: test-signal 90 Hz or 150 Hz dominance on/off.

TX1 and TX2: 90/150 Hz on/off.

Communications.

### **3.3.4.3 Level 3**

Settings of all the monitor warning and alarm limits.

Settings of all the maintenance warning limits.

Settings of all the delays.

Settings of all the TX1 and TX2 configurations.

### **3.3.5 The menu tree**

The top 3 levels of the menu tree is shown in Figure 3-12.

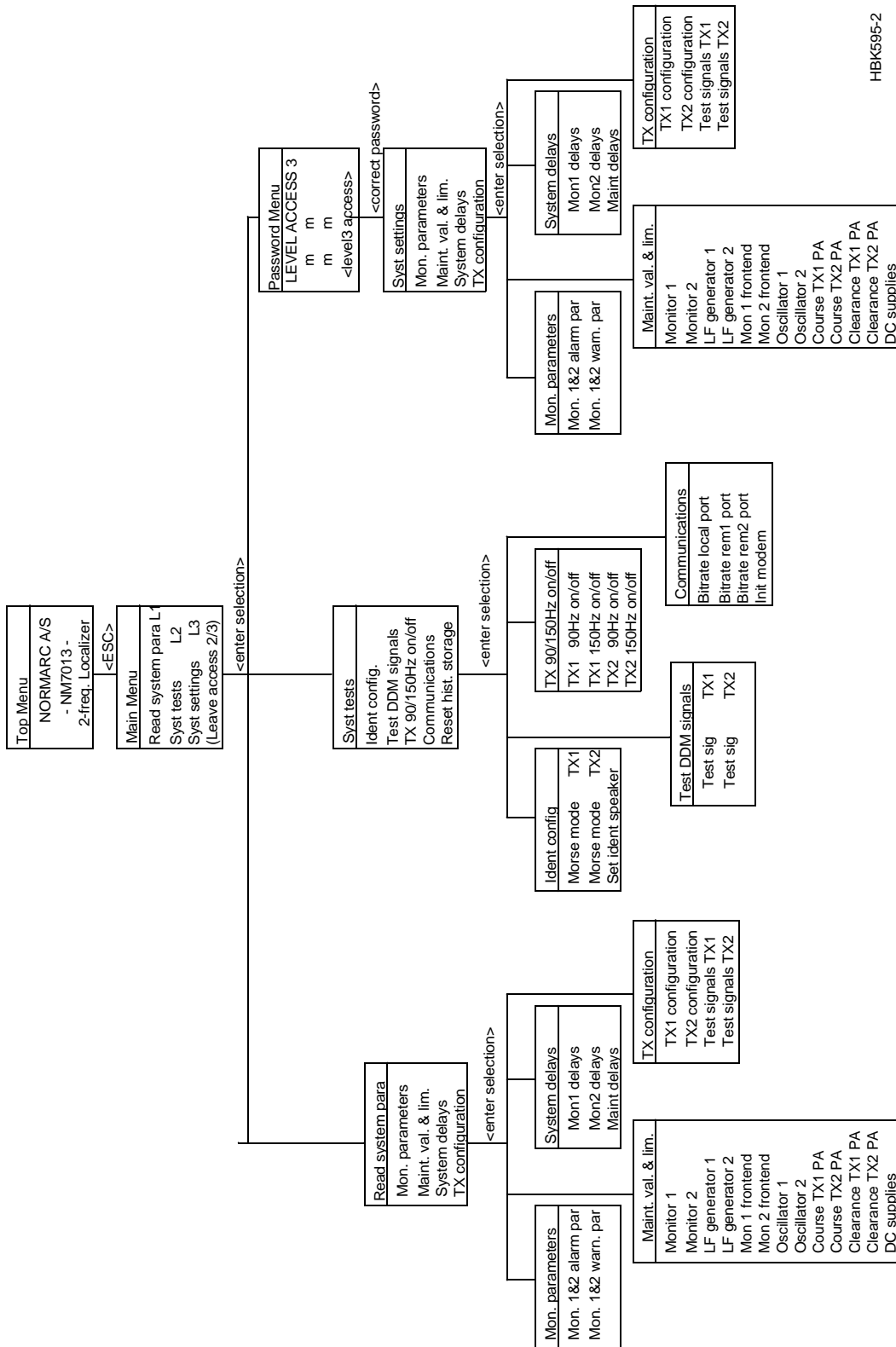

HBK595-2

Figure 3-12 The menu tree: The top levels



## 4 Tower Equipment

### 4.1 Remote Control Operation

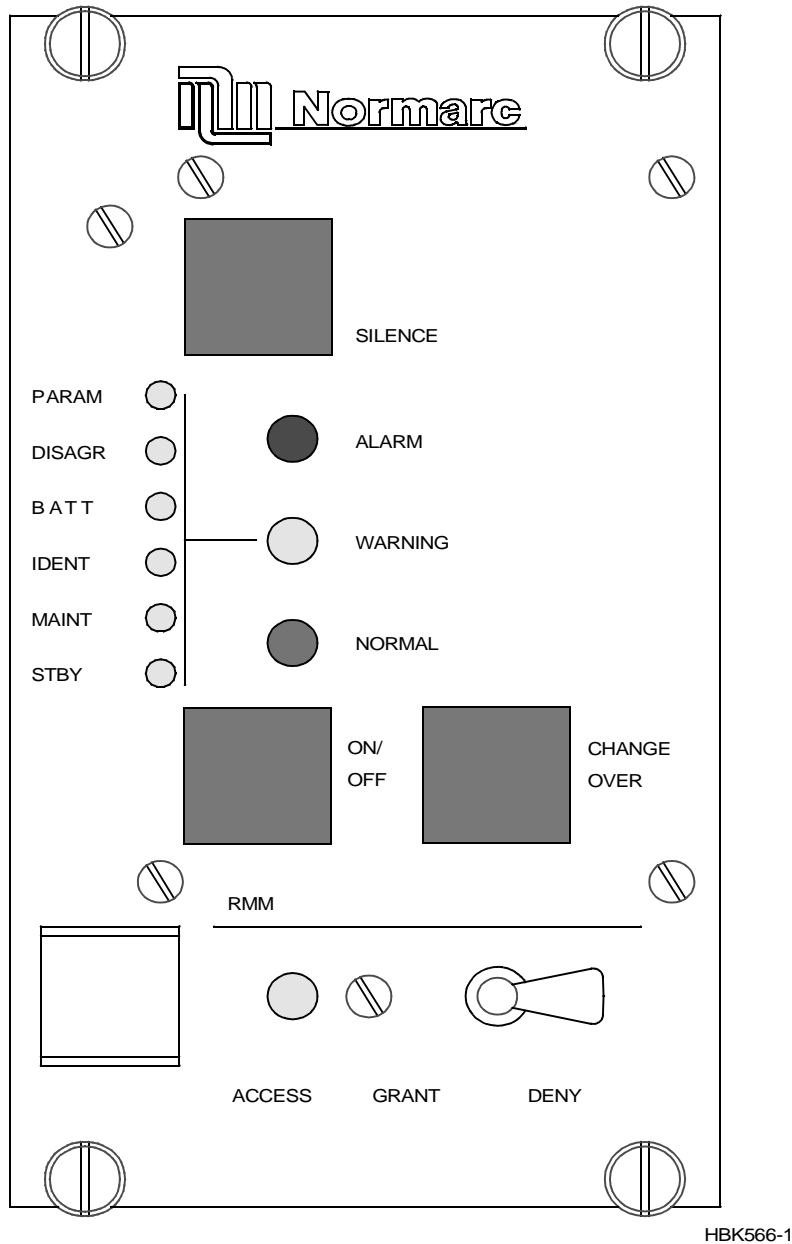

HBK566-1

Figure 4-1 RF1242A front panel.

#### 4.1.1 Glossary

**INTERLOCK** When an ILS is in active interlock mode (the interlock signal is an input to the remote control), the ILS will turn off all active transmitters and not allow them to be turned on before the interlock condition is removed. This signal overrides manual mode of operation.

#### 4.1.2 Pushbuttons

**ON/OFF**

Used to:

- Toggle the ILS on/off.

Valid when:

- The LOCAL/REMOTE switch must be in REMOTE position, and
- The interlock signal is not active if the ILS is configured for interlock.

**CHANGE OVER**

Used to:

- Toggle the coax relay and transmitters between TX1/TX2 as the active transmitter(s).

Valid when:

- The LOCAL/REMOTE switch on the ILS is in REMOTE position, and
- The ILS is «on» when the MANUAL/AUTO switch is in AUTO position.

**SILENCE**

Used to:

- Turn off the audio alarm on the remote control (caused by remote status change from NORMAL to ALARM). Also used for lamp test (all lamps are illuminated when this push-button is held down).

Valid when:

- Always.

**4.1.3 Switches/Switchlocks****GRANT/DENY**

Used to:

- Give access grant (access level 2/3) for RMS control of the ILS when the switch is in GRANT position. NOTE! This switch may be override by configuration straps on U6 on TC1216A (strap position 7-14). When this switch is in the DENY position no RMS access (at access level 2/3) is allowed.

Valid when:

- Always.

**4.1.4 System Status Indications****ALARM**

Used to:

- Indicate that the ILS has detected an alarm condition.

Activated by:

- One or more alarms present on the ILS, or
- Communication failure with ILS.

**WARNING**

Used to:

- Indicate that the ILS has detected one or more warning conditions.

Activated by:

- Warning condition(s) detected by RMS.

**NORMAL**

Used to:

- Indicate that no alarm conditions are detected by the ILS.

Activated by:

- No alarms present, and
- Communication with ILS is OK.

#### PARAMETER WARNING

Used to:

- Indicate that there are one or more monitor parameter warnings present.

Activated by:

- One or more monitor parameters outside the warning limits.

#### MONITOR DISAGREE

Used to:

- Indicate that there are one or more monitor parameter warnings present. The warnings from the monitor 1/monitor 2 are voted before displayed.

Activated by:

- Difference in monitor 1/monitor 2 alarm detection.

#### BATTERY WARNING

Used to:

- Indicate that the ILS is running using the 27V battery.

Activated by:

- Loss of mains for charging the 27V battery.

#### IDENT WARNING

Used to:

- Indicate that the ident is faulty for LLZ.

Activated by:

- Loss of ident Morse coding for LLZ.

#### MAINTENANCE WARNING

Used to:

- Indicate that one or more of the maintenance parameter warnings detected.

Activated by:

- One or more maintenance parameters faulty or outside limits.

#### STANDBY TRANSMITTER ON AIR

Used to:

- Indicate that coax position directs the standby transmitters to the antenna and the main transmitters to the dummy load.

Activated by:

- Coax position differs from transmitter main select.

#### ALARM BUZZER

Used to:

- Indicate that a transition from NORMAL to ALARM has occurred. Reset by pressing SILENCE push-button.

Activated by:

- Remote control state transition from NORMAL to ALARM.

## 4.2 Remote Slave Operation

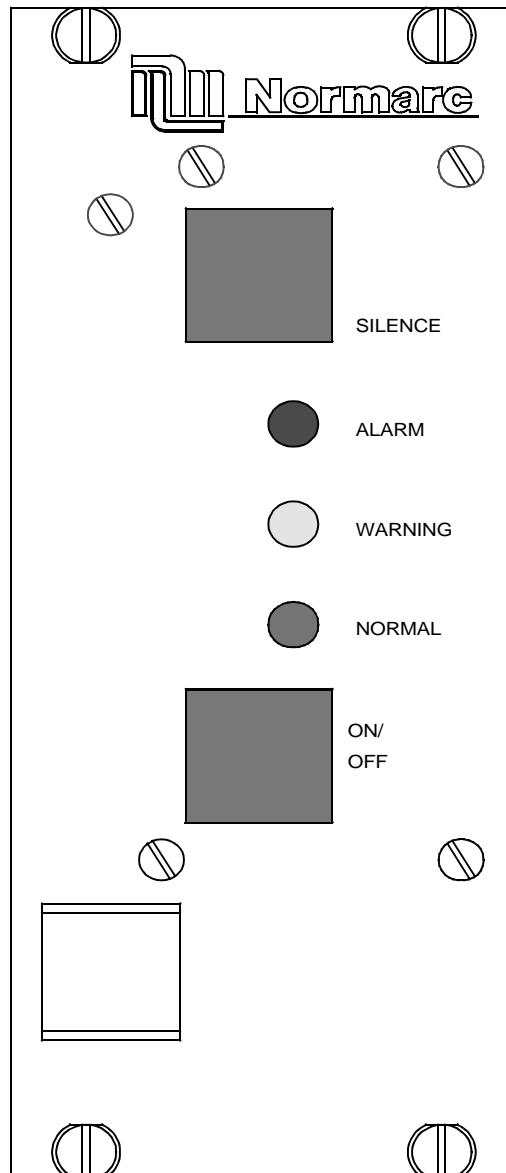

HBK599-1

Figure 4-2 SF1344A front panel.

### 4.2.1 Glossary

**INTERLOCK** When an ILS is in active interlock mode (the interlock signal is an input to the remote control), the ILS will turn off all active transmitters and not allow them to be turned on before the interlock condition is removed. This signal overrides manual mode of operation.

### 4.2.2 Pushbuttons

#### ON/OFF

Used to:

- Toggle the ILS on/off.

Valid when:

- The LOCAL/REMOTE switch must be in REMOTE position, and
- The interlock signal is not active if the ILS is configured for interlock.

### SILENCE

Used to:

- Turn off the audio alarm on the slave panel (generated by remote control). Also used for lamp test (all lamps are illuminated when this push-button is held down).

Valid when:

- Always.

## **4.2.3 System Status Indications**

### ALARM

Used to:

- Indicate that the ILS has detected an alarm condition.

Activated by:

- One or more alarms present on the ILS, or
- Communication failure with ILS.

### WARNING

Used to:

- Indicate that the ILS has detected one or more warning conditions.

Activated by:

- Warning condition(s) detected by RMS.

### NORMAL

Used to:

- Indicate that no alarm conditions are detected by the ILS.

Activated by:

- No alarms present, and
- Communication with ILS is OK.

## **4.3 Interlock Switch Operation**

The interlock function is used when mutual exclusive operation on different ILS systems is required. An active interlock for a station shall prevent transmission of ILS signals. The interlock signal is connected to the remote control RC1241 and transmitted to the ILS through the remote control connection.

The interlock function on the ILS is enabled/disabled from configuration settings on the TC1216A. The rest of this chapter describes an ILS configured for interlock.

When an active ILS receives an active interlock signal, the ILS performs a shutdown. If the interlock signal is deactivated, the ILS will automatically be turned on after a 20 second delay period.

For maintenance purposes, an interlock override function has been implemented. This function makes it possible to operate the ILS locally in manual mode with an active interlock signal. To activate the interlock override function the following conditions must be met:

- LOCAL/REMOTE switch must be in LOCAL position,
- AUTO/MANUAL switch must be in MANUAL position and
- INTERLOCK OVERRIDE switchlock must be set in horizontal position.

The remote control will always be set in ALARM state when the interlock override function is activated.

---

## 5 Remote Maintenance and Monitoring Software

This chapter is the user manual for the Remote Maintenance and Monitoring (RMM) software.

Version 3.9 of the RMM software is covered in this chapter. This version can be used to connect to ILS cabinets with version 5 up to and including version 12 of the RMS software.

### 5.1 Introduction

This paragraph gives a brief description of this user manual, the program and the system requirements.

#### 5.1.1 Description

This manual describes how to use the NM70xx remote monitoring software. The remote monitoring software consists of software running in the ILS rack and on software running on IBM/PC's and compatibles. The purpose of the system is to retrieve status and measurements from the ILS rack and to change ILS operation and parameters from a remote site. The retrieved data can be displayed and further processed by programs on the PC.

For example, the ILS data can be

- Displayed on the screen.
- Saved on disk for later use.
- Exported to other programs for graphical display of parameter variations.

#### 5.1.2 Available versions

The NM7000 RMM program is available in a DOS version and a 32 bit version for Windows 95/NT. Both versions are distributed together. Depending on the operating system installed on the PC, the user must install one of these versions.

#### 5.1.3 System requirements

The PC running the DOS version of the software must be equipped with:

- 386DX33 based computer
- DOS 3.0 or later
- a hard disk
- 4 Mbyte RAM
- HIMEM installed
- a RS-232 serial port connected to a Hayes compatible 2400 baud modem
- a printer port & printer, if printouts are desired

For Windows 95 and NT the following are acceptable minimum configurations:

**95:** 486x33 and 8 MB RAM

**NT:** Minimum 486x66 and 16-20 MB RAM

A recommended configuration for running the DOS version includes the following:

- a 486 based computer or better
- a mathematical co-processor (486DX internal is satisfactory)
- a VGA monitor
- DOS 6.0 or later
- I/O board with 16550 UART

If a 386- or a slow 486-based PC is used, it is recommended to drop the bitrate to 2400 or 4800 bps.

If a mouse is available, it is supported by the RMM software.

#### **5.1.4 Running under Microsoft Windows 3.xx**

Neither the DOS version nor the Win95/NT version of the RMM program runs under Windows 3.xx. The DOS version can, of course, be started on a PC with Windows 3.xx installed as long as Windows is not also started.

If the RMM-software is running on a slow PC with Windows 95 or NT, avoid to start up several other applications. This to ensure sufficient processor-time is available for data processing in the NM 7000 RMM.

#### **5.1.5 How to use this manual**

The user interface of the RMM software is very similar to the one used in Microsoft Windows. If you are familiar with using Windows programs, you will easily understand how to operate this program, and you can skip Chapter 5.2. The next chapters describe each feature of the program. You may want to read these chapters to learn how use the RMM software.

#### **5.1.6 Starting the RMM software**

To install the RMM PC Software, create a directory named NM7000 on the hard disk. Then copy the contents of the NMS152A (DOS) or NMS152B (Win95/NT) RMM PC SW floppy to this directory.

To start the program, make the RMM system directory your current directory. Then start NM7000.EXE (DOS) or NM7000.BAT (Win95/NT).

If you are not familiar with DOS commands, the above steps can be performed with the following commands:

```
CD\NM7000.↵  
NM7000.↵
```

## **5.2 User interface components**

There are three visible components to the RMM software: the menu bar at the top, the window area in the middle and the status line at the bottom of the screen. The next few sections describe these components, and the information that they display.

### **5.2.1 The menu bar and menus**

The menu bar is your primary access to all the menu commands. The menu bar is always visible. If a menu command is followed by an ellipsis (...) choosing the command displays a dialog box. If the command does not have an ellipsis, the action occurs when you choose the command.

Here is how to choose menu commands using the keyboard:

1. Press *F10*. This makes the menu bar active; the next thing you type will relate to the items in the menu bar.



2. Use the arrow keys to select the menu you want to display. Then press *Enter*.  
As a shortcut for this step, you can just press the highlighted letter of the menu title. For example, when the menu bar is active, press *F* to move to and display the File menu. At any time, press *Alt* and the highlighted letter (such as *Alt+F*) to display the menu you want.
3. Use the arrow keys again to select a command from the menu you have opened. Then press *Enter*.  
At this point, the ILS Data Sampler either carries out the command, displays a dialog box, or displays another menu.

There are two ways to choose commands with a mouse:

- Click the desired menu title to display the menu and click the desired command.
- Or, drag straight from the menu title down to the menu command. Release the mouse button on the command you want. (If you change your mind, just drag off the menu; no command will be chosen.)

Note that some menu commands are unavailable when it would make no sense to choose them. However, you can always get on-line Help about currently unavailable commands.

### 5.3 Shortcuts

The software offers a number of quick ways to choose menu commands. The click-drag method for mouse users is an example. From the keyboard, you can use a number of keyboard shortcuts (or *hot keys*) to access the menu bar, choose commands, or work within dialog boxes. You need to hold down *Alt* while pressing the highlighted letter when moving from an input box to a group of buttons or boxes. Here is a list of the shortcuts available:

Do this	To accomplish this...
Press <i>Alt</i> plus the highlighted letter of the command (just press the highlighted letter in a dialog box).	Display the menu or carry out the command.
Type the keystrokes next to a menu command.	Carry out the command.

Table 5-1 Shortcut commands.

For example, to display a previously saved log, press *Alt+F D* (for File |Display log) or you can just press *F3*, the shortcut displayed next to it.

#### 5.3.1 The desktop area

Most of what you see and do in the ILS Data Sampler environment happens in a *window*. A window is a screen area that you can open, move, resize, zoom, tile, and overlap. Every window is positioned on the *desktop*, the area between the menu bar and the status line.

You can have many windows open at the same time, but only one window can be active at any time. Any command you choose or text you type generally applies only to the active window.

You can spot the active window easily: It is the one with the double-lined border around it. The active window usually has a close box, a zoom box, and scroll bars. If your windows are overlapping, the active window is always the one on top of all the others.

There are several types of windows, and they may have all or some of the following character-

istics:

- a title bar
- a close box
- scroll bars
- a zoom box
- A window that controls a modem also has a *flow display* icon. This icon is normally changing, indicating that new data is received from the ILS station.

The *close box* of a window is the box in the upper left corner. Click this box to quickly close the window. (Or choose Window | Close, with shortcut *Alt+F3*). The Help window is considered temporary; you can also close it by pressing *Esc*.

The *title bar*, the topmost horizontal bar of a window, contains the name of the window. Double-clicking the title bar zoom the window. You can also drag the title bar to move the window around.

The *zoom box* of a window appears in the upper right corner. If the icon is an up arrow, you may click the arrow to enlarge the window to the largest size possible. If the icon is a double headed arrow, the window is already at its maximum size. In that case, clicking it returns the window to its previous size. To zoom a window from the keyboard, choose Window | Zoom, with shortcut *F5*).

**Shortcut:** Double-click the title bar of a window to zoom or restore it.

#### 5.3.1.1 *Scrolling the contents of a window*

*Scroll bars* are horizontal or vertical bars with an arrow in each end, and a box between these. You use the scroll bars with a mouse to scroll the contents of an ILS parameter display window. Click the arrow at either end to scroll one line at a time. (Keep the mouse button pressed to scroll continuously.) You can click the shaded area to either side of the scroll box to scroll a page at a time. Finally, you can drag the scroll box to any spot on the bar to quickly move to a place in the window relative to the position of the scroll box.

#### 5.3.1.2 *Resizing a window*

You can resize a window by dragging the resize corner (the bottom, right corner) of the window. The resize corner is displayed as single outline part of the window frame. To resize using the keyboard, choose Size/Move from the Window menu. Pressing the *arrow keys* will then move the window, and *Shift+arrow keys* resizes the window. Note that resizing only applies to windows which has a resize corner.

#### 5.3.1.3 *Quick window management*

The next table gives you a quick run-down of how to handle windows in the ILS Data Sampler. Note that you don't need a mouse to perform these actions - a keyboard works just fine.

Every window that displays ILS parameters has a small control window. This control window is placed at the upper left corner of the desktop when you choose to display a log file, or connect to an ILS station.

To accomplish this:	Use one of these methods
Open and display a saved log file	Choose File   Display log.
Close a window	Select the window, and press <i>Alt+F3</i> .
Hang up phone and close data window	Select the corresponding control window, and press <i>Alt+F3</i> .
Move the active window	Drag its title bar. Or choose Window   Size/Move and use the arrow keys to place the window where you want it, then press <i>Enter</i> .
Resize the active window	Drag the bottom right corner. Or choose Window   Size/Move and press <i>Shift</i> while you use the arrow keys to resize the window, then press <i>Enter</i> .
Zoom the active window	Click the zoom box in the upper right corner of the window, or Double-click the window's title bar, or Choose Window   Zoom

Table 5-2 Quick window operations.

### 5.3.2 The status line

The status line appears at the bottom of the screen. It

- reminds you of basic keystrokes and shortcuts (or hot keys) applicable at that moment in the active window.
- lets you click the shortcuts to carry out the action instead of choosing the command from the menu or pressing the shortcut keystroke.
- offers one-line hints on any selected menu command and dialog box items.
- tells you how much memory is currently available

The status line changes as you switch windows or activities. One of the most common status lines is the one you see when you are browsing a log file, or logging data. When you've selected a menu title or command, the status line changes to display a one-line summary of the function of the selected item.

### 5.3.3 Dialog boxes

A menu command with an ellipsis (...) after it leads to a *dialog box*. Dialog boxes offer a convenient way to view and set multiple options. When you are making settings in dialog boxes, you work with five basic types of on screen controls: Action buttons, radio buttons, check boxes, input boxes, and list boxes. Here is a sample dialog box that illustrates some of these items:

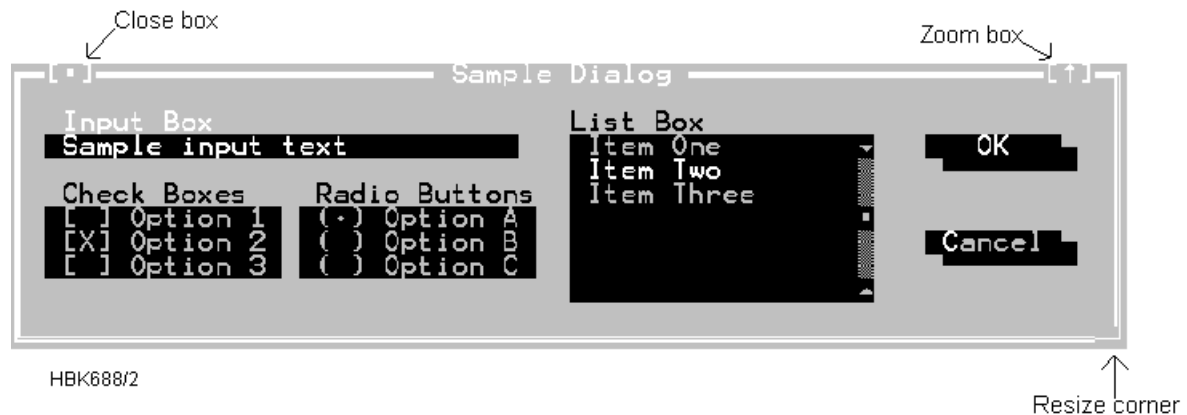

Figure 5-1 A sample dialog box.

### 5.3.3.1 Action buttons

This dialog box has two standard buttons: OK and Cancel. If you choose OK, the choices in the dialog box are accepted; if you choose Cancel, nothing changes and no action takes place, and the dialog box is put away. You can press *F1* to open a Help window for this dialog box. *Esc* is always a keyboard shortcut for Cancel (even if no Cancel button appears).

If you are using a mouse, click the dialog box button you want. When you are using the keyboard, press *Alt* and the highlighted letter of an item to activate it. For example, *ALT+O* selects OK because the O in OK is highlighted. Press *Tab* or *Shift+Tab* to move forward or back from one item to another in a dialog box. Each element is highlighted when it becomes active.

In this dialog box, OK is the *default button*, which means you need only press *Enter* to choose that button. (On monochrome systems, arrows indicate the default; on color monitors, default buttons are highlighted.) Be aware that tabbing to a button makes that button the default. You can then press *Spacebar* to choose that button.

### 5.3.3.2 Radio buttons and check boxes

Radio buttons are like car radio buttons. They come in groups, and only one radio button in the group can be on at any one time. To choose a radio button, click it or its text. From the keyboard, select *Alt* and press the highlighted letter (if any), or press *Tab* until the group is highlighted and then use the arrow keys to choose a particular radio button. Press *Tab* or *Shift+Tab* again to leave the group with the new radio button chosen.

Check boxes differ from radio buttons in that you can have any number of check boxes checked at any time. When you select a check box, an x appears in it to show you it's on. An empty box indicates it's off. To change the status of a check box, click it or its text, press *Tab* until the check box is highlighted and then press *Spacebar*, or select *Alt* and the highlighted letter (if any).

If several check boxes apply to a topic, they appear as a group. In that case, tabbing moves to the group. Once the group is selected, use the arrow keys to select the item you want, and then press *Spacebar* to check or uncheck it. On monochrome monitors, the active check box or group of check boxes will have a chevron symbol (>>) to the left and right. When you press *Tab*, the chevrons move to the next group of check boxes or radio buttons.

### 5.3.3.3 Toggles

Toggles let you select one setting out of a group defined settings. They are similar to Radio buttons (chapter 5.3.3.2); except that only the selected setting is displayed. You select other settings by clicking on the text showing the toggle setting, or by pressing the *space bar*.

### 5.3.3.4 Input and list boxes

Input boxes let you type in text. Most basic text-editing keys work in the text box (for example, arrow keys, *Home*, *End*, and *Ins*). If you continue to type once you reach the end of the box, the contents automatically scroll. If there is more text than what shows in the box, arrowheads appear at the end. You can click the arrowheads to scroll or drag the text.

If an input box has a down-arrow icon to its right, there is an associated *history list*. Click the down arrow icon, or press the down arrow key to display the list. You will find text you typed the last few times you used the input box. Press *Enter* to choose an item from this list. You can also edit an item in the history list. Press *Esc* to exit from the history list without making a selection.

A final component of many dialog boxes is a *list box*, which lets you scroll through and select from variable-length lists (often file names) without leaving a dialog box. If a blinking cursor appears in the list box and you know what you are looking for, you can type the word (or the first few letters of the word) and the ILS Data Sampler will search for it.

You make a list box active by clicking it or by choosing the highlighted letter of the list title (or press *Tab* until it's highlighted). Once a list box is displayed, you can use the scroll box to move through the list or press the arrow keys on the keyboard.

## 5.4 Configuring the RMM system

This chapter describes how to configure the RMM system. The configuration settings covered in this chapter does not affect the operation of remote ILS systems in any manner. It applies to the "PC part" of the system only.

The configuration dialogs is accessed via the Options menu. The following sub-chapters covers each of the menu items on this menu.

### 5.4.1 Communications setup

The software allows you to connect the modems to two of four communications ports; COM1 - COM4, with configurable IRQ's for COM3 and COM4. The ILS station may also be connected directly to the PC by the use of a null modem cable.

The communication with the ILS is done with the use of a Channel construct. In the station setup for an ILS station one selects a Channel in which the communication with the remote ILS shall flow. Each channel is then associated with a specific set of configurable communication settings.

Choosing *Communications setup* brings up the following dialog



HBK648/2

Figure 5-2 Com port setup dialog

Selecting one of the Channel setup buttons opens up a dialog like Figure 5-3 shows.



HBK647/4

Figure 5-3 Channel setup dialog

Note: DOS version also has the “Modem hangup String” and “Use DTR to hangup” fields in this window. In the Win95/NT version DTR will always be used to hangup the modem.

The items in this dialog has the following purposes.

Item	Purpose
Port	Specifies the serial communications adapter to which the modem or ILS is connected.
Bit rate	Specifies the bit rate to use when communicating with the modem or ILS.
Use DTR to hang-up	Select this if the software should use the DTR line instead of the "Modem hang-up string" to make the modem hang up. This is faster and safer than using the Modem hang-up string.
Direct connect	Select this if the PC is connected to the ILS via a null modem cable.

Item	Purpose
Leased line	Select this if the PC is connected to the ILS via dedicated leased line modems.
Normal dial-up	Select this if the PC shall connect the ILS via modem on a public telephone network.
Modem Init String	This string will be sent to the modem before each dialing process starts. The default is ATZ, which performs a software reset of the modem.
Hang-up String	Command to make the modem hang up the phone.

Table 5-3 Channel setup operations.

## Modem configuration

### 5.4.1.1 Close Connection

Selecting the "Use DTR to hang-up" is recommended, as this method for closing the connection is both safer and faster than the "+++" escape sequence (Hang-up string). Note that the modem must be configured with the AT&D2 command for the "Use DTR to hang-up" method to work (some modems do not include this command in their default initiation).

### 5.4.1.2 Recommended init-strings

Refer to the Technical notes at the end of this chapter for information on how to set up the modems on different types of connection.

## 5.4.2 IRQ setup

Selecting the IRQ setup button in the Com port setup dialog opens the following dialog.

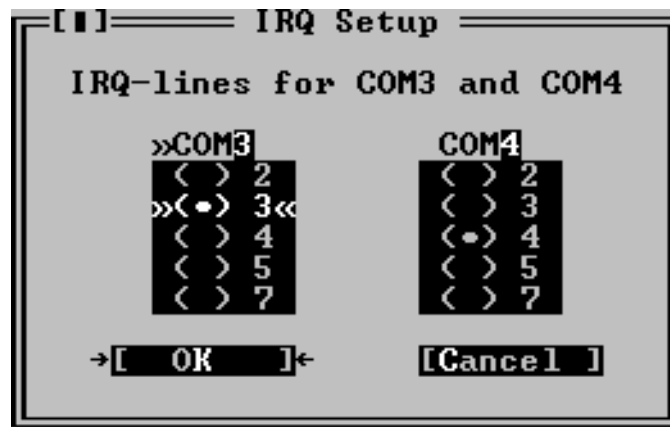

HBK664/2

Figure 5-4 IRQ setup dialog

This dialog allows alternate IRQ selections for COM3 and COM4.

### NOTE

The Win95/NT version does not have this dialog, as these settings are handled at the operating system level.

## 5.4.3 Printer setup

The Printer setup dialog contains options for an optionally connected printer. The dialog is shown below.



HBK887/3

Figure 5-5 Print setup dialog

The purpose of each field in the dialog is described below.

Item	Purpose
Port	Determines the printer port to use for the printing. If "File" is selected the output will be sent to the file specified in the string input field. The file will be created in the "Log directory" for the current station (see 5.5).
Print frames	Allows enabling/disabling the printing of special frame characters. Uncheck this checkbox if your printer does not support the PC-8 bit character set.
Send form-feed	Allow for sending a form-feed (ASCII 12) character to the printer following each print-out. The extra form-feed is required by most laser printers.

Table 5-4 Print setup operations.

To print the report, select File|Print report.

#### 5.4.4 Preferences

The Preferences dialog allows the user to set general program preferences



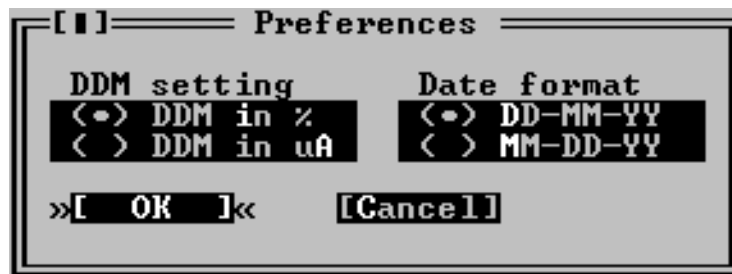

HBK686/3

Figure 5-6 Preferences dialog

The DDM setting applies to all user input and all screen or printer output of DDM measurements. Selecting % means that input/output is in percent, likewise, selecting uA results in micro ampere input/output.

The date format field selects day-month-year or month-day-year display of time.

#### 5.4.5 Toggle video mode

This menu selection toggles the current video mode between 25 lines and 43/50 lines.

#### 5.4.6 Set date/time

To set the date and time of the PC, select *Set date/time* from the *Options* menu. A dialog as show next is shown.

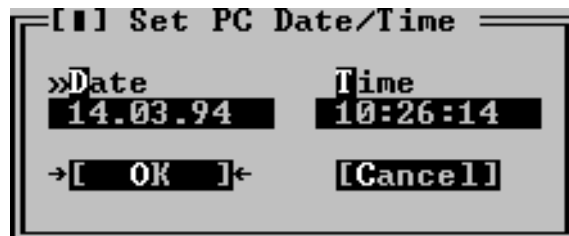

HBK651/2

Figure 5-7 Set date/time dialog

In the *Date* field, enter the current date in day.month.year format if DD.MM.YY is selected in the Preferences dialog (Figure 5-6). Else enter the date in MM.DD.YY format. In the time field, enter the current time of day in standard 24 hour format.

### 5.5 Setting up ILS stations

Before connecting to an ILS station the station must be added to the “station list”. Some information about each station must also be entered, e.g. the number to dial to connect to the station. This chapter describes how to set up ILS stations.

Selecting the ILS | Station list menu command brings up a dialog like the one shown below.



Figure 5-8 Station list dialog.

This dialog contains a list showing the name and number of the configured stations. Use the scroll bar to the left of the list to scroll or use the up/down arrow keys. If the selected Channel for a station is a “Direct connect” channel, the number field will show DIRECT/CHx. Up to 50 stations may be configured.

The following table describes how use this dialog.

To accomplish this	Do this
Change the configuration for a specific station.	Select the station from the list, and press the <i>Edit</i> button. You can also press <i>ENTER</i> , when the desired station is highlighted. Double-clicking the desired station also activates the Edit function.
Add a new station to the list	Press the <i>Add</i> button, or edit an empty name/number line from the list.
Delete a station	Select the station you want to delete and press the <i>Delete</i> button. You may also press <i>Del</i> on your keyboard.
Connect to the station (see the Displaying measurements chapter)	Press the <i>Connect</i> button.

Table 5-5 Station list operations.

When you have selected Add or Edit from the above dialog, another dialog appears. This dialog is shown in Figure 5-9.



HBK663/2

Figure 5-9 ILS Station setup dialog

The table below describes the meaning of each field in the ILS Station setup dialog.

Use field	To specify
Station name	A name for the ILS station. Holds up to 20 characters. This name is saved in the log files you create.
Number	The telephone number of the ILS station. This string is passed directly to the modem, meaning that special characters like ',' or other characters can be included if the modem understands them.
Log dir. name	The name of the directory where downloaded measurements shall be stored. The directory is made if it do not exist.
Auto download MED storage	Whether or not the medium time periodic storage should be downloaded automatically each day.
Start time	The time of day to start the automatic MED download.
I/O channel	Which I/O channel to use when connecting to this station. (See the Communications setup chapter)

Table 5-6 ILS station setup operations.

## 5.6 Connecting to an ILS station

To connect to an ILS station the station must first be added to the Station List, as described in chapter 5.5. When this has been done, just press the “Connect” button in the ILS Station List dialog. The software will try to make a connection to the station. Once a connection has been established you will be prompted to enter your username and passwords. You enter this information in the dialog box shown in Figure 5-10.

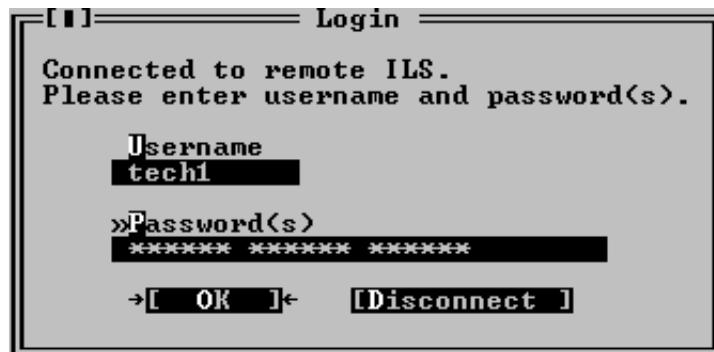

HBK676/2

Figure 5-10 Login dialog box

Your assigned access level depends on the number of passwords and the username entered. Different passwords must be separated with a space character. The following table outlines the access level properties, and how to gain them. Increasing access levels adds more access rights, and retaining the rights for the lower access levels.

Access level	You enter	Access rights
1	your username and 1 password	Read all measurements/status and show all settings, and download.
2	your username and 2 passwords	Change front panel settings and change settings in the "Ident and mod. switches" window.
3	your username and 3 passwords	Change all settings (except user administration)
MASTER	username MASTER and 3 passwords	Set up new users and change passwords.

Table 5-7 Login access rights.

When you have entered correct login information and pressed the OK button, the program will start to retrieve ILS configuration data. Windows that was open the last time you were connected to the ILS will automatically be opened when the ILS configuration has been received.

If you enter invalid login information the ILS will not grant you access rights to the ILS. The software will display a message telling you what went wrong, and let you perform another login attempt. You have three attempts. If all attempts are used without success the ILS will disconnect and not allow more login attempts for 3 minutes.

When the program has received the configuration data, the ILS configuration will be displayed in a window in the upper left corner of the desktop area. This window will be referred to as the "Link" window. Figure 5-11 shows a typical Link window.

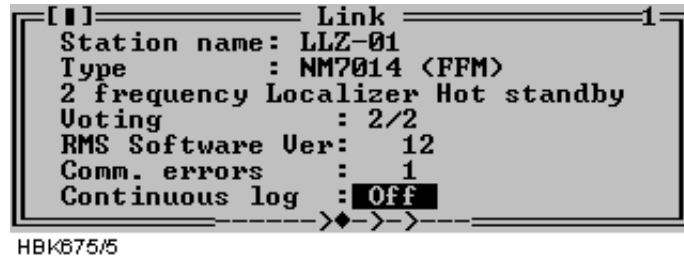

Figure 5-11 A typical Link window

### 5.6.1 Shutting down the connection to an ILS

To shut down an ILS connection, close the Link window for the connection you want to shut down. For information on how to close a window, see Table 5-2.

Do not close the windows you want reopened the next time you connect to this ILS station.

### 5.6.2 Baud rate recommendations

When connecting to the ILS at 9600 bps, Remote port 2 or Local port on the ILS should be used. For performance reasons, remote port 1 should not be used at 4800 and 9600 bps. This will affect the response times of the Local RMS front panel as well as message handling on the other RS-232 ports.

## 5.7 Monitor measurements and status

### 5.7.1 General

The functions described in this and the following chapters are accessed via the ILS|Measurement sub-menu.

The windows described here will automatically be updated with new measurements as long as the windows remain open.

The monitors signal the state of each parameter. For analog measurements, the states will be displayed by a character code preceding the measurement and by the color of the displayed number.

State	Character code	Colour code
Normal	(None)	(Black)
Raw warning	w	Yellow
Delayed warning	W	Yellow
Raw Alarm	a	Orange (light red)
Delayed Alarm	A	Red

Table 5-8 Monitor codes.

For digital measurement only two states are defined; OK and ERROR. The ERROR string is shown in red, while the OK string is shown in black.

### 5.7.2 Monitor window

To display the parameters shown in the window below select the ILS|Measurements|Monitor Window 1 menu item. This window displays the standard monitor parameters (DDM, SDM and RF-level) for each of the monitor channels (Course line, Displacement Sensitivity, Near field and Clearance Transmitter (2-freq. systems)). In addition, Difference Frequency (2-freq.systems), DC-loop and Ident information are displayed. The result of the continuous monitor self test is also shown.

		Monitor Window 1		2
/		MON1	MON2	STB
CL:	DDM %	0.0	0.0	-0.1
	SDM %	40.0	40.0	40.0
	RF U	3.0	3.0	3.0
DS:	DDM %	-0.1	-0.1	0.2
	SDM %	39.7	39.7	40.8
	RF U	3.0	3.0	3.0
NF:	DDM %	0.0	0.0	
	SDM %	40.0	40.0	
	RF U	3.0	3.0	
CLR:	DDM %	-0.1	-0.1	0.0
	SDM %	40.0	40.0	40.0
	RF U	3.0	3.0	3.0
DF	<kHz>	10.0	10.0	10.0
CL	IDENT	OK	OK	OK
CLR	IDENT	OK	OK	OK
Self test		OK	OK	OK
DC Loop		OK	OK	

HBK683/3

Figure 5-12 Monitor window

The DC loop status shown in this window will be OK if all the DC loop readings are within the warning limits, else ERROR is displayed (DC loop readings for each loop is displayed in Monitor window II).

### 5.7.3 Additional monitor parameters window

Selecting ILS|Measurements|Monitor 2 brings up the following window. This window shows secondary monitor parameters.

Due to the nature of the monitor self test signals, the values will toggle between alarm and normal. If one of these erroneous test signals fails to generate alarm, a self test error will be in Monitor Window 1. The CL/CLR MORSE parameters shows the modulation level of the ident signal. No activity on this signal for the time period specified in the ident delay setting, will result in an IDENT warning in Monitor Window 1.

Depending on the antenna system installed, up to 4 DC-loops can be active. The DC LOOP parameter in Monitor Window 1 shows accumulated status of the 4 DC-loops.

Monitor Window 2		5		
		MON1	MON2	STB
Self- DDM %		a -3.1	a -3.1	a -3.1
Test SDM %		a 24.7	a 24.7	a 24.9
	RF U	a 1.3	a 1.3	a 1.3
CL MORSE		0.0	0.0	5.8
CLR MORSE		1.7	1.2	3.8
DC LOOP 0		38.0	40.0	-4.0
DC LOOP 1		38.0	40.0	-3.0
DC LOOP 2		-3.0	-2.0	-4.0
DC LOOP 3		-4.0	-2.0	-3.0

HBK684/3

Figure 5-13 Additional monitor parameters window

### 5.7.4 External parameters window

Selecting ILS|Measurements|External brings up the following window. This window shows the measurements on the external channels. The NM 70xx can provide executive monitoring of signals from external equipment, defined by the user (option).

For external channels that are not used, no measurement field will be shown (e.g. the standby measurement field will be shown (e.g. the standby measurements in Figure 5-14)

External		4		
		MON1	MON2	STB
FFMChA	DDM	0.0	0.0	
FFMChA	SDM	39.8	39.8	
FFMChA	RF	52.1	52.1	
FFMChB	DDM	0.0	0.0	
FFMChB	SDM	39.9	39.9	
FFMChB	RF	63.8	63.8	
VOICE	DTCT			
FFM	EXE AL	0.0	0.0	

HBK657/4

Figure 5-14 External parameters window

### 5.7.5 Maintenance monitor window

Selecting ILS|Measurements|Maintenance brings up the window shown below. The maintenance warning parameters are displayed in groups corresponding to the modules on which they are measured. A separate group consists of the main power supplies and current measurements. In this way, the origin of a maintenance warning can easily be deduced.

If one maintenance parameter on a module is in warning status, the module to which it belongs is given the same status. Therefore, it can be easily determined the maintenance warning status of the system by looking at the top window (Figure 5-15) only.

The following table shows the defined status codes.

Status	Status code
All parameters OK	OK
Raw warning on at least one param.	WARN (R)
Delayed warning on at least one param.	WARN (D)
Internal I <sup>2</sup> C error on at least one param.	ERROR
No measurements applicable	N/A

Table 5-9 Status codes.

Digital parameters are displayed as outlined in the above table. Analog parameters are displayed with the same character and color codes as the monitor measurements.

By selecting a board on the list and double-clicking it or pressing *Enter* opens another window which displays the status/measurements on that specific board.

```

[[ ]] Maint. params. 2
>>Board list
MON1 MO1212      OK
MON2 MO1212      OK
STDBY MO1212     OK
FFM 1 FC1391     OK
FFM 2 FC1391     OK
TX1  LF1223      OK
TX2  LF1223      OK
MON1 MF1211/MF1219  WARN(D)
MON2 MF1211/MF1219  WARN(D)
STDBY MF1211/MF1219  WARN(D)
TX1  OS1221      OK
TX2  OS1221      OK
COURSE TX1 LPA/GPA  WARN(D)
COURSE TX2 LPA/GPA  WARN(D)
CLEARANCE TX1 LPA/GPA  WARN(D)
CLEARANCE TX2 LPA/GPA  WARN(D)
>>DC SUPPLIES     OK
RMS  RM1213      OK
TX CONTROL        WARN(D)

```

HBK677/5

Figure 5-15 Maintenance monitor window

The following figures show the available status/measurement windows.



MON1 MO1212 3		MON1 MF1211/MF1219 4	
+5U OK	OK	CL RF LEVEL	OK
STS ACT	OK	CL BASEBAND	OK
DSP PFO	OK	DS RF LEVEL	OK
DSP ERROR	OK	DS BASEBAND	OK
DIAG RST	OK	NF RF LEVEL	OK
SYNC ERROR	OK	NF BASEBAND	OK
+15U OK	OK	CLR RF LEVEL	OK
-15U OK	OK	CLR BASEBAND	OK
MON2 MO1212 5		MON2 MF1211/MF1219 6	
+5U OK	OK	CL RF LEVEL	OK
STS ACT	OK	CL BASEBAND	OK
DSP PFO	OK	DS RF LEVEL	OK
DSP ERROR	OK	DS BASEBAND	OK
DIAG RST	OK	NF RF LEVEL	OK
SYNC ERROR	OK	NF BASEBAND	OK
+15U OK	OK	CLR RFLEVEL	OK
-15U OK	OK	CLR BASEBAND	OK
STDBY MO1212 7		STDBY MF1211/MF1219 8	
+5U OK	OK	CL RF LEVEL	OK
STS ACT STB	OK	CL BASEBAND	OK
DSP PFO STB	OK	DS RF LEVEL	OK
DSP ERROR STB	OK	DS BASEBAND	OK
DIAG RST STB	OK	NF RF LEVEL	OK
SYNC ERROR STB	OK	NF BASEBAND	OK
+15U OK	OK	CLR RFLEVEL	OK
-15U OK	OK	CLR BASEBAND	OK

HBK679/2

Figure 5-16 Monitor maintenance parameters

TX1 LF1223 3		TX2 LF1223 4	
COU LEVEL 90	OK	CL LEVEL 90	OK
COU LEVEL 150	OK	CL LEVEL 150	OK
COU LEVEL DC	OK	CL LEVEL DC	OK
CLR LEVEL 90	OK	CLR LEVEL 90	OK
CLR LEVEL 150	OK	CLR LEVEL 150	OK
CLR LEVEL DC	OK	CLR LEVEL DC	OK
+15U OK	OK	+15U OK	OK
-15U OK	OK	-15U OK	OK
TX1 OS1221 5		TX2 OS1221 6	
COU OUTPUT LEVEL	OK	COU OUTPUT LEVEL	OK
COU TUNEVOLT	OK	COU TUNEVOLT	OK
COU SYNTH LOCK WARN	OK	COU SYNTH LOCK WARN	OK
COU LOCK DETECT	OK	COU LOCK DETECT	OK
CLR OUTPUT LEVEL	OK	CLR OUTPUT LEVEL	OK
CLR TUNEVOLT OK	OK	CLR TUNEVOLT OK	OK
CLR SYNTH LOCK WARN	OK	CLR SYNTH LOCK WARN	OK
CLR LOCK DETECT	OK	CLR LOCK DETECT	OK

HBK681/2

Figure 5-17 TX maintenance parameters

COURSE TX1 LPA/GPA 6			COURSE TX2 LPA/GPA 7		
PA 270 LEVEL	<U>	26.8	PA 270 LEVEL	<U>	26.6
CSB LEVEL	<W>	14.1	CSB LEVEL	<W>	n/a
SBO LEVEL	<W>	0.4	SBO LEVEL	<W>	n/a
PH CORR PEAK LEV		7.6	PH CORR PEAK LEVEL		n/a
CLEARANCE TX1 LPA/GPA 8			CLEARANCE TX2 LPA/GPA 9		
PA 270 LEVEL	<U>	26.4	PA 270 LEVEL	<U>	26.8
CSB LEVEL	<W>	13.8	CSB LEVEL	<W>	n/a
SBO LEVEL	<W>	0.4	SBO LEVEL	<W>	n/a
PH CORR PEAK LEVEL		7.9	PH CORR PEAK LEVEL		n/a

HBK680/2

Figure 5-18 PA maintenance parameters

DC SUPPLIES 6		
PS1 -15V	<U>	-15.1
PS2 -15V	<U>	-15.2
PS1 +5V	<U>	5.2
PS2 +5V	<U>	5.3
PS1 +8.5V	<U>	8.7
PS2 +8.5V	<U>	8.7
PS1 +15V	<U>	15.1
PS2 +15V	<U>	15.2
TX1 CLR 1150	<A>	n/a
TX1 CLR 190	<A>	n/a
TX1 COU 1150	<A>	n/a
TX1 COU 190	<A>	n/a
TX2 CLR 1150	<A>	n/a
TX2 CLR 190	<A>	n/a
TX2 COU 1150	<A>	n/a
TX2 COU 190	<A>	n/a
BATTERY CURRENT	<A>	-0.1
POWER CURRENT	<A>	1.9
BATTERY VOLTAGE	<U>	26.1
CHARGER 1 STATUS		OK
CHARGER 2 STATUS		OK

HBK678/3

Figure 5-19 DC-Supplies maintenance parameters

RMS RM1213 4		
RMS +5V	<U>	4.9
RMS BATTERY	<U>	3.0
EPROM CRC CHECK		OK
RAM CHECK		OK

H1127/1

Figure 5-20 RMS maintenance parameters

TX CONTROL 4		
RC LINK STATUS		OK
EPROM PARITY CHECK		OK
INTEGRITY CHECK		OK
INTERNAL CL DDM	<X>	0.0
INTERNAL CL SDM	<X>	40.0
INTERNAL CL RF	<U>	3.0

HBK746/2

Figure 5-21 TX Control maintenance parameters

### 5.7.6 User parameters window

Selecting ILS|Measurements|User brings up the window shown below. This window shows the user defined input/output states and measurements.

User	Value
Do not use	FALSE
Spare 6	FALSE
Spare 5	TRUE
Spare 4	TRUE
Spare 3	TRUE
Spare 2	TRUE
Counter 1	1
Counter 0	1
Temp.out	-37.3
Temp.in	22.9
AC level	189.2
Spare 1	0.0
Spare 2	0.0
Spare 3	0.0

HBK692/3

Figure 5-22 User parameters window (sample configuration).

If a digital user parameter is defined as an output and you have at least access level 2, you can change the output value by changing the state of the corresponding toggle in this window.

## 5.8 Monitor settings

The functions described in this and the following sub-chapter are accessed via the ILS|Monitor settings sub-menu.

The current access level determines which functions will be available. If a function is not available because of a low access level, the function will not be possible to activate.

All access levels allow the currently stored setting to be displayed; but in order to change a setting an access level of at least 3 is required.

### 5.8.1 Limits Monitor 1&2

When the ILS|Monitor settings|Limits Monitor 1&2 menu option is selected a window showing the currently configured monitor 1 and 2 alarm and warning limits is displayed. A window with sample data is displayed below.

Monitor Limits							
	Nom	MONITOR 1			MONITOR 2		
		Alarm Low	Alarm High	Warn %	Alarm Low	Alarm High	Warn %
→CL DDM	0.0	-0.93	0.93	75	-0.93	0.93	75←▲
CL SDM	40.0	-4.00	4.00	75	-4.00	4.00	75
CL RF	3.0	-0.37	0.43	75	-0.37	0.43	75
DS DDM	15.5	-2.58	2.59	75	-2.58	2.59	75
DS SDM	40.0	-20.01	20.01	75	-20.01	20.01	75
DS RF	3.0	-1.70	1.70	75	-1.70	1.70	75
NF DDM	0.0	-0.93	0.93	75	-0.93	0.93	75
NF SDM	40.0	-20.01	20.01	75	-20.01	20.01	75
NF RF	3.0	-1.70	1.70	75	-1.70	1.70	75
CLR DDM	0.0	-4.13	4.13	75	-4.13	4.13	75
CLR SDM	40.0	-4.00	4.00	75	-4.00	4.00	75
CLR RF	3.0	-0.37	0.44	75	-0.37	0.44	75
DF VALUE	10.0	-4.50	4.50	75	-4.50	4.50	75
CL ID	0.0	OFF	OFF	100	OFF	OFF	100
CLR ID	0.0	OFF	OFF	100	OFF	OFF	100
CL D ID	0.0	OFF	OFF	n/a	OFF	OFF	n/a
CLR D ID	0.0	OFF	OFF	n/a	OFF	OFF	n/a
DL 0	0.0	2.00	42.00	100	2.00	42.00	100
DL 1	0.0	2.00	42.00	100	2.00	42.00	100
DL 2	0.0	OFF	OFF	100	OFF	OFF	100
DL 3	0.0	OFF	OFF	100	OFF	OFF	100
Self Test DDM	0.0	-1.40	4.00	100	-1.40	4.00	100
Self Test SDM	40.0	-7.99	OFF	100	-7.99	OFF	100
Self Test RF	3.0	-1.20	1.80	100	-1.20	1.80	100
FFMChA DDM	0.0	-0.94	0.94	74	-0.94	0.94	74
FFMChA SDM	40.0	-4.00	4.00	75	-4.00	4.00	75
FFMChA RF	0.0	20.00	80.00	n/a	20.00	80.00	n/a
FFMChB DDM	0.0	-0.94	0.94	74	-0.94	0.94	74
FFMChB SDM	40.0	-4.00	4.00	75	-4.00	4.00	75
FFMChB RF	0.0	20.00	80.00	n/a	20.00	80.00	n/a
FFM EXE AL	0.0	0.00	200.00	n/a	0.00	200.00	n/a

»[Close]« [ Nom ] [ MON 1 Limits ] [ MON 2 Limits ] [ Name ]

HBK669/4

Figure 5-23 Monitor 1&2 limits window

The alarm limit field will show “OFF” if the alarm limit is equal to the maximum or minimum value.

The warning limit field for CL IDENT, CLR IDENT and external channels (i.e. FFM RF and VOICE) will show “n/a” as the warning limits for these parameters is not defined as a percentage of the alarm limits.

The “MON 1 Limits” and the “MON 2 Limits” buttons will only be displayed for access level 3 and master user access level.

In order to change the alarm and/or warning limits for a specific parameter; first select the parameter in the list box, then select the “MON 1 Limits” button or the “MON 2 Limits” button if you want to change either monitor 1 or monitor 2 alarm/warning.

When one of the above mentioned buttons is selected a dialog similar to the one below is opened. In this dialog one may enter new alarm limits and warning limit for the currently selected parameter. The alarm limits is always relative to the nominal value. The warning limit is always entered in percent of the selected alarm limit.

If the Symmetric button is pressed the alarm limit is entered as a value which is symmetric around the nominal value; hence only one alarm limit will have to be entered in the symmetric

mode.

The arrowheads after each input field in this dialog can be clicked on to increase or decrease the displayed limit value. Hold down *Shift* to increment/decrement by a larger value. The up and down arrow keys may be used instead of the mouse.

Due to the digital representation of the alarm and warning limits, the entered value is rounded to the nearest 12-bit digital value. The actual stored value, which is read back to the dialog box, can therefore differ slightly from the entered value.

The text OFF may be entered in alarm limits field to inhibit low, high or any alarms on the current monitor parameter. If OFF is entered, one would normally enter 100 (%) in the warning field, in order to also inhibit warning indications. For parameters where the warning limits is not in % of the alarm limits, large negative and positive numbers must be entered to inhibit the warning. See Appendix B for recommended values.

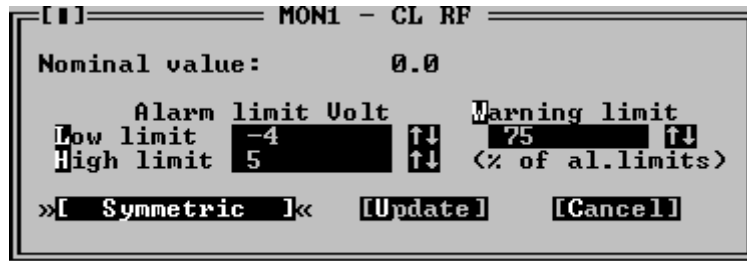

HBK670/2

Figure 5-24 Monitor parameter input dialog

The NAME button is used to change the parameter name. This applies to the external channels only.

Refer to appendix B for the factory default values of all monitor parameters.

### 5.8.2 Limits Standby monitor

When the ILS|Monitor settings|Limits Stdby monitor menu option is selected a window showing the currently configured standby monitor alarm and warning limits is displayed. This window is used in the same way as the Monitor 1&2 limits window, described above.

### 5.8.3 Delays

Selecting ILS|Monitor settings|Delays brings up the Monitor Delays window, shown below. The NM70xx is configured with three separately adjustable delays: Normal, Near Field, Ident and Far Field Monitor. This window displays the currently configured Monitor 1&2 (equal delays) and standby monitor delays. To change a delay; first select the desired parameter on the list and then press the "Mon 1 and 2" button if the delay for Monitor 1 and 2 should be altered, else press the "Stdby" button for a standby monitor delay change.

Monitor Delays				
		MON1	MON2	STDBY
→GEN	delay	1.0	1.0	1.0←
NF	delay	10.0	10.0	
IDENT	delay	20.0	20.0	20.0
FPM	delay	10.0	10.0	

»[Close]« [MON1] [MON2] [Stdby]

HBK654/4

Figure 5-25 Monitor delays window

A standby column will be shown if the system is equipped with a standby monitor. The resolution of the delay parameters is 1/10 second.

Once the “Mon 1 and 2” or the “Stdby” button has been pressed an input dialog like the one shown below is opened. Enter the desired delay in the field, or use the up and down arrows to increment/decrement the current value. When the “Update” button is selected, the ILS will be updated.

[ ]= MON1&2 - GEN delay

»Delay

10.00 [↑↓]

→[Update]← [Cancel]

HBK652/2

Figure 5-26 Delay input dialog

Valid input range in this window is 0.4 to 102.3 seconds. The total changeover-shutdown delay will be two times this value. See Appendix B for recommended values.

### 5.8.4 Limits Maintenance monitor

When the ILS|Monitor settings|Analog maintenance limits or Digital maintenance limits menu item is selected a window showing the currently configured analog/digital maintenance monitor warning limits is displayed. Windows with sample data is displayed below. The board name is shown indented to the left. The maintenance parameters are shown after each board name.

For analog parameters the “Low” and “High” columns show the low and high warning limits. For digital parameters a single column shows the “normal state” for the parameter. If the parameter state is not equal to this state a maintenance warning will be generated by the ILS RMM software. If no warning is wanted for a parameter the columns will display “OFF”.

See Appendix B for factory default settings.

Analog maintenance limits		
	Low	High
→COURSE TX1 LPA/GPA		
PA 270 LEVEL (U)	24.0	28.0
CSB LEVEL (W)	12.0	17.0
SBO LEVEL (W)	0.2	0.8
PH CORR PEAK LEVEL	1.0	13.0
COURSE TX2 LPA/GPA		
PA 270 LEVEL (U)	24.0	28.0
CSB LEVEL (W)	12.0	17.0
SBO LEVEL (W)	0.2	0.8
PH CORR PEAK LEVEL	1.0	13.0
CLEARANCE TX1 LPA/GPA		
PA 270 LEVEL (U)	24.0	28.0
CSB LEVEL (W)	12.0	17.0
SBO LEVEL (W)	0.2	0.8
PH CORR PEAK LEVEL	1.0	13.0
CLEARANCE TX2 LPA/GPA		
PA 270 LEVEL (U)	24.0	28.0
CSB LEVEL (W)	12.0	17.0
SBO LEVEL (W)	0.2	0.8
PH CORR PEAK LEVEL	1.0	13.0
DC SUPPLIES		
PS1 -15U (U)	-16.8	-13.8
PS2 -15U (U)	-16.8	-13.8
PS1 +5U (U)	4.7	5.9

»[Close]«      [Change]

HBK665/3

Figure 5-27 Analog maintenance monitor limits window

This list is scrollable, all defined parameters are listed in the Maintenance monitor chapter.

Digital maintenance limits	
	Normal
→MON1 M01212	
+5U OK	High
STS ACT	High
DSP PFO	High
DSP ERROR	Low
DIAG RST	High
SYNC ERROR	Low
+15U OK	High
-15U OK	Low
MON2 M01212	
+5U OK	High
STS ACT	High
DSP PFO	High
DSP ERROR	Low
DIAG RST	High
SYNC ERROR	Low
+15U OK	High

»[Close]«      [Change]

HBK668/3

Figure 5-28 Digital maintenance monitor limits window

This list is scrollable, all defined parameters are listed in the Maintenance monitor chapter.

To change a warning limit; first select the desired parameter on the list and press the "Change" button. Depending on the type (digital/analog) of the dialog, one of the dialogs

shown next will be opened.



HBK667/3

Figure 5-29 Input dialog for digital maintenance parameters

To change the setting for a digital parameter click in the normal state field or use the space bar to toggle. The normal state field will toggle between Low, High and OFF. The settings for the CHARGER 1 STATUS and CHARGER 2 STATUS parameters is On and Off.

Press the Update button when the desired state is shown.

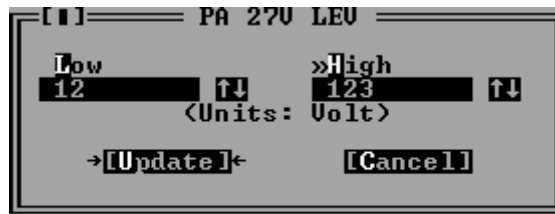

HBK666/2

Figure 5-30 Input dialog for analog maintenance parameters

To change the setting for an analog parameter, type in the wanted low and high warning limits in the corresponding fields. Then press the Update button.

### 5.8.5 Delays Maintenance monitor

To display or change the maintenance monitor delay parameters, select the ILS|Monitor settings|Delays maintenance monitor menu item. The window shown below will be displayed. The operation of the window is similar to the operation of the Monitor delays window.

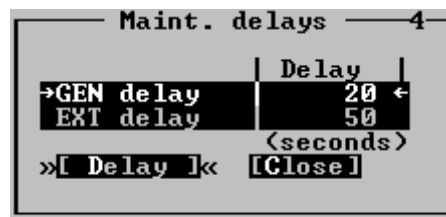

HBK653/3

Figure 5-31 Maintenance delay window

The resolution of the maintenance delay parameters is 1 second. Valid input range is 1 to 1023 seconds.

### 5.8.6 Analog user parameters

Selecting ILS|Monitor settings|Analog user parameters opens the window in Figure 5-32. This



window shows the current settings for the analog user parameters.

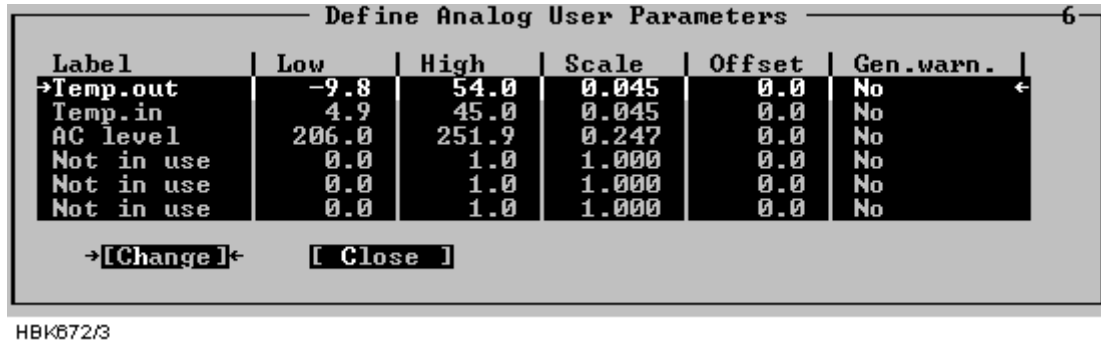

Figure 5-32 Analog user parameters definitions

The following definitions can be made for the analog user parameters: Name, lower and upper warning limits, and scale and offset constants for conversion to engineering units. There is also a field for enabling/disabling generation of a maintenance warning.

To change the settings for a parameter, select the parameter on the list and press the “Change” button. This brings up the dialog shown below.

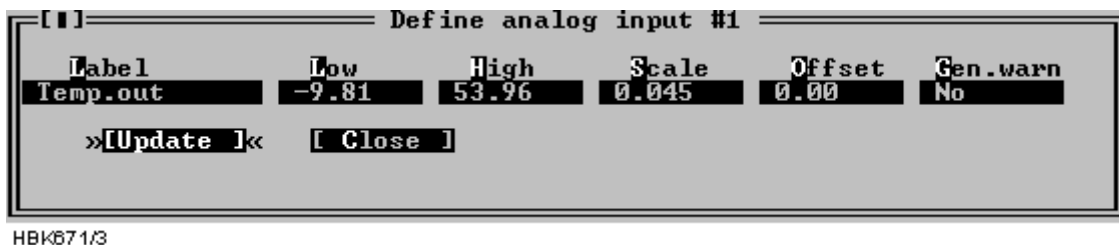

Figure 5-33 Analog user parameter settings dialog

### 5.8.7 Digital user parameters

Selecting ILS|Monitor settings|Digital user parameters opens the window shown below. This window shows the current settings for the digital user parameters. There are six parameters which operate as digital input or output, and two parameters which count number of positive transitions on the corresponding digital inputs. The counter will count from 0 to 99, and be automatically reset to 0.

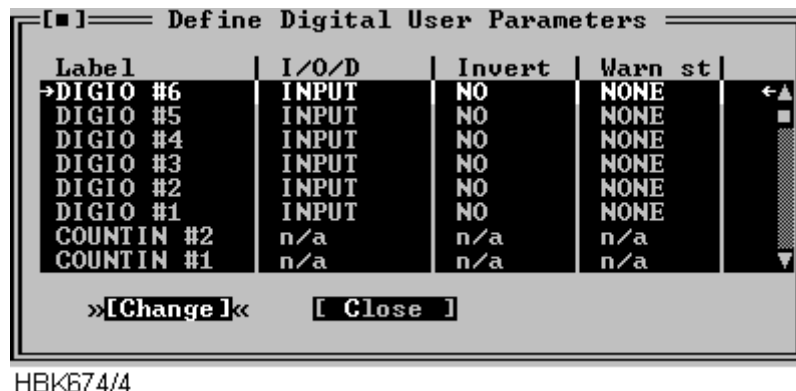
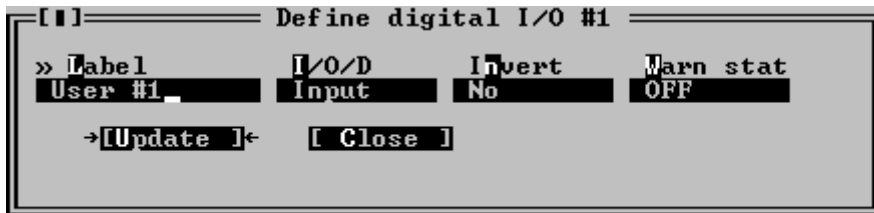

Figure 5-34 Digital user parameters definitions

The following definitions can be made for the digital user parameters: Name, input or output selection, whether the value shall be inverted or not, and warning state of the parameter (TRUE / FALSE / NONE).

To change the setting for a I/O parameter, select the parameter on the list and press the “Change” button. This brings up the dialog shown below.



HBK673/3

Figure 5-35 Digital user parameters settings dialog

For the counter parameters; the “Change” button opens a dialog where the label text can be modified.

## 5.9 TX settings

### 5.9.1 TX Adjustments

Selecting the ILS|TX settings|TX adjustments menu item opens the window shown below.

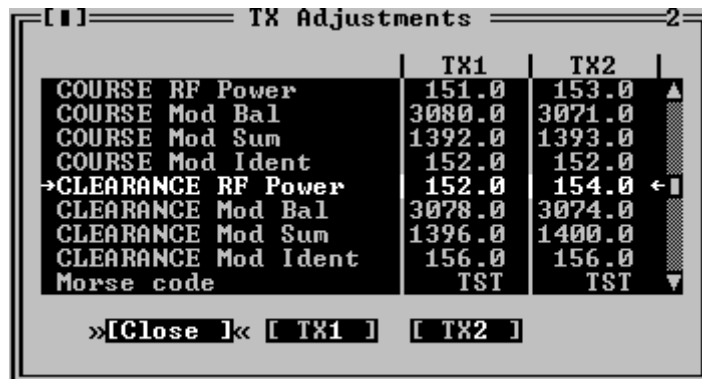

HBK691/3

Figure 5-36 TX adjustments window

The following TX parameters can be changed for Course and Clearance (2-freq. systems) for transmitter 1 and 2:

- 90Hz & 150Hz modulation balance (DDM),
- 90Hz & 150Hz modulation sum (SDM),
- RF power
- Ident modulation depth
- In addition, the runway Morse code identification (2-4 letters) is entered here.

To change TX adjustment values click the TX1 or TX2 buttons. A dialog similar to the one below will be opened. To change the parameter value you have the following options:

- Click on the up and down arrows to increment/decrement the value. The ILS will automati-

- cally be updated when you stop changing the value.
- Press the up and down arrows on your keyboard to increment/decrement the value. Holding **Shift** down will increment/decrement by a larger value. The ILS will automatically be updated when you stop changing the value.
- Enter a new value in the numeric input field. The ILS will be updated when you press **Enter** or click the **Update** button.

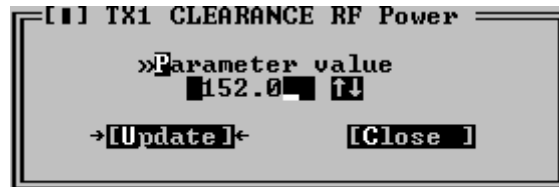

HBK741/3

Figure 5-37 TX Adjustment input dialog

The TX-adjustment values are the positions of digital potentiometers used and stored in the EEPROM on the LF generator boards. The values are unit-less integers in the range 0-4095. See Appendix B for typical values used.

### 5.9.2 Ident. and modulation switches

Selecting ILS|TX settings|Ident. and modulation switches brings up the window shown below.

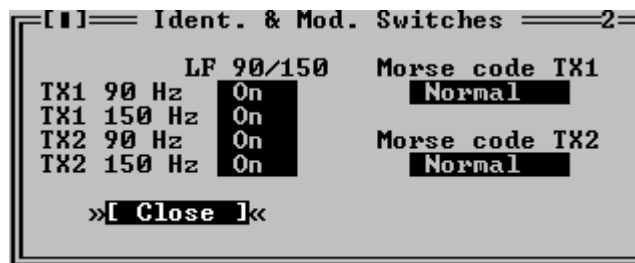

HBK859/4

Figure 5-38 Ident. and modulation switches window

In this window the LF generator 90 Hz and 150 Hz signals may be switched on or off and the Morse code and VOICE settings may be changed (LLZ only). VOICE on/off is only applicable for VOICE configured Localizers. The following table describes the effect of each Morse code setting.

Setting	Transmitted ident.
OFF	None (silent)
NORMAL	The one selected in TX adjustments - Morse code
CONT.	Continuous 1020 Hz tone.
TST	The Morse code for TST

Table 5-10 Morse code settings.

### 5.9.3 CLR mod. and DME settings

Selecting ILS|TX settings|CLR mod. and DME settings brings up the window shown below.

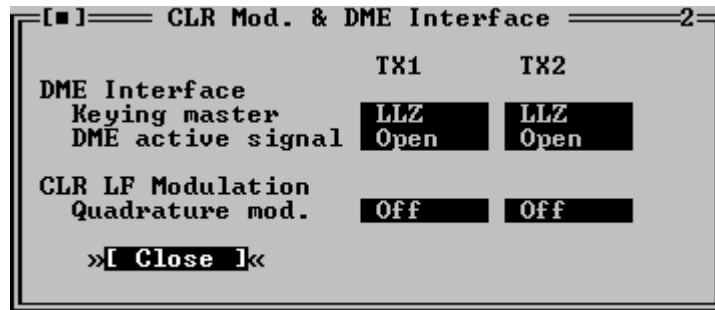

HBK744/2

Figure 5-39 CLR mod. and DME settings dialog

The fields in this window specifies the operation of the DME interface (LLZ only) and quadrature modulation of the CLR LF signal (2-freq. systems only).

The following table describes the each selection.

Keying master	LLZ	LLZ is the keying master
	DME	DME is the keying master
DME active signal	OPEN	Open circuit indicates active DME (enables colocation)
	CLOSED	Closed circuit indicates active DME (enables colocation)
Quadrature mod.	OFF	Do not quadrature modulate the clearance LF signal.
	ON	Enable quadrature modulation of the clearance LF signal.

Table 5-11 CLR modulation and DME settings.

### 5.10 Power scaling

#### NOTE

The scaling values in this window should only be changed on racks with the first version of the PA module (LPA1230A/GPA1231A/GPA1232A version 1). On newer PA modules, the power reading is pre-adjusted, and the scaling value should be set to 1.0.

Selecting ILS|TX Settings|Power scaling when connected to an ILS with RMS software version 10, or later, will bring up the window below.

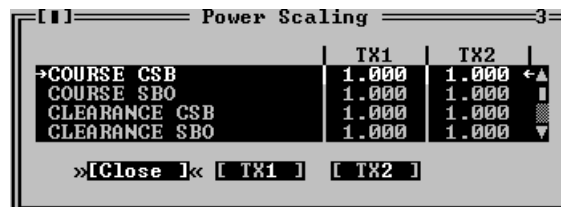

HBK1126/2

Figure 5-40 Power scaling settings

The scaling values will normally be in the range 0.5-2.0.

The values in this window can be used to adjust the power measurements done on the transmitters. The measurement values are displayed in the maintenance windows for the transmit-

ters.

These scaling values are stored in the RMS system in the ILS. This implies that the values will have to be changed if a PA module is replaced.

### 5.11 Front panel operation

When ILS|Front panel is selected a window displaying the same information as the ILS front panel is opened. See Figure 5-41.

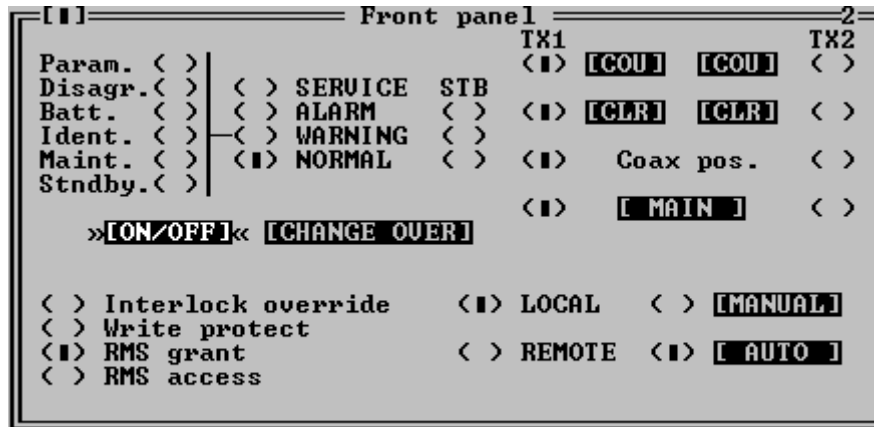

HBK658/2

Figure 5-41 Front panel window

Pressing buttons in this window has the same effect as pressing the corresponding switch on the ILS front panel.

Note that some switches on the ILS front panel is not possible to change from the RMM system (e.g. write protect). The settings of these switches is displayed as "LED's" in this window.

### 5.12 Get historical data

#### 5.12.1 General

Selecting ILS|Get historical data opens the Storage download window, shown in Figure 5-42. This window is used to download one of the data storages.

The different storages contain the following information. All stored items are given a corresponding time stamp:

- *Alarm storage:* Samples of all monitor and maintenance parameters for a period starting from 30s before an alarm occurred and ending with the actual alarm sample. Up to 7 alarm storages can be stored in the ILS. The RMM will download all storages into one alarm storage file.
- *Warning storage:* One sample of all monitor and maintenance parameters at the instant when a warning LED is activated. The 25 last warnings are stored.
- *Medium time periodic storage:* One sample of all monitor and maintenance parameters stored periodically at user specified intervals (see 5.22). The storage contains the last 96 samples.
- *Long time periodic storage:* For every day through a 180 days period, the mean value and

standard deviation of all monitor and analog maintenance parameters.

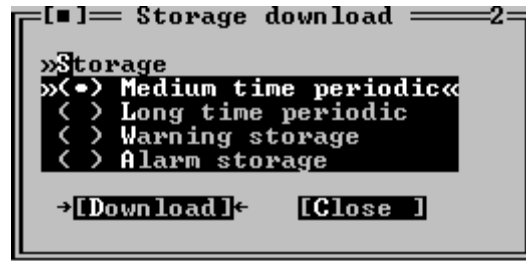

HBK689/2

Figure 5-42 Storage download window

E.g. to download the alarm storage buffer; just select the Alarm storage radio button and press the "Download" button. The software will then retrieve the alarm storage and store the data on the local hard disk.

The software automatically creates a name for the file in which the data is stored. The name is of the form YYMMDD.ext. Where YY is the last two digits of the current year, MM is the month and DD is the day of month number. The filename extension field is defined in the following table.

Storage type	Extension
Medium time periodic	.MED
Long time	.LON
Warning	.WRN
Alarm	.ALA

Table 5-12 Filename extensions.

The file will be created in the directory specified in the Log dir. field of the current station setup.

### 5.12.2 Alarm storage specific

The software will check the .ALA file for the current day (if it exists) to see whether or not a new alarm has occurred. If no new alarm is available in the ILS storage buffer no data will be downloaded, and you will be notified about the situation.

## 5.13 Continuous data logging

When ILS|Continuous logging is selected the dialog in Figure 5-43 is opened. From this dialog the user controls the writing of received data to a file. The data written to a file can be displayed on screen and exported to text format for later use in a spreadsheet program. The user may select which types of data to be stored on disk, as displayed in Figure 5-43.

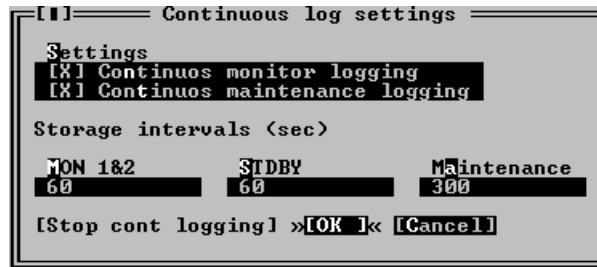

HBK850/4

Figure 5-43 Continuous logging dialog

The time interval between each time a sample is stored can also be configured in this dialog. The intervals must be entered in seconds and tenths of a second. The storage interval information entered in this dialog will be stored and associated with the current station.

The software automatically creates a name for the file in which the data is stored. The name is of the form YYYYMMDD.ext. Where YY is last two digits of the current year, MM is the month and DD is the day of month number. The filename extension field is CNT.

The file will be created in the directory specified in the Log dir. field of the current station setup.

The "Stop cont logging" button in this window can be used to stop logging continuous data (once it has been enabled). When continuous logging has been turned on the "Continuous log" field in the Link window displays "ON".

## 5.14 Events

Selecting ILS|Events brings up the window shown in Figure 5-44. This window displays the last 50 events (user operations, log-in/out, alarms, warnings) in a scrollable list. The displayed fields are:

- The time when the event occurred
- The user caused the event (if any)
- The event type description

Event diagnostics is also invoked from this window, see chapter 5.24 for a description of this feature.

Events			
Time	User	Event	
08.10.99 12:42:19.1	MASTER	Logged on - local	
08.10.99 14:25:23.4	System	Intgrt OK, turned OFF	
08.10.99 14:25:24.8	System	Powered off	
08.10.99 14:27:16.6	System	Powered on	
08.10.99 14:28:48.6	Remote	RC connection OK	
08.10.99 14:29:11.7	Remote	Turned ON	
08.10.99 14:29:12.0	System	Maint. warning off	
08.10.99 14:29:15.4	System	Ident. warning off	
08.10.99 14:29:15.7	System	Stb para warning off	
08.10.99 14:29:16.9	System	Service OFF	
08.10.99 14:29:18.8	System	Param. warning off	
08.10.99 14:29:54.4	System	ALARM: MON1:NF SDM MON2:NF SDM MON1:NF RF	
08.10.99 14:29:54.7	System	ChangeOver to TX2	
08.10.99 14:29:55.8	System	Stb para warning	
08.10.99 14:30:03.9	System	ALARM: MON1:NF SDM MON2:NF SDM MON1:NF RF	
08.10.99 14:30:04.0	System	ShutDown from TX2	
08.10.99 14:30:39.5	KARI	Logged on - local	

[Close] »[Event diagnostics...]«

HBK655/4

Figure 5-44 Events window

### 5.15 Test DDM

The ILS|Test DDM function is for use when a DDM flight test is performed on the system. The Test DDM window is shown in Figure 5-45. The window contains the following fields:

- The current CL and NF DDM nominal, measurement, and low and high alarm limit.
- Buttons for quick access to the monitor alarm/warning configuration dialog (see chapter 5.8.1).
- DDM adjustment “potentiometers” for adjusting dominance levels. The **Inc** and **Dec** buttons increase/decrease the dominance level. NOTE: Pressing **Inc** on a 150 Hz level will decrease the potentiometer value, while **Dec** will increase the value.
- Toggles for setting the type of dominance (toggles between Off, 90 Hz and 150 Hz)

The required access levels for the fields in this dialog is as follows:

- To change monitor limits (use of the “monitor CL/NF DDM” buttons) requires access level 3.
- All other settings require access level 2.



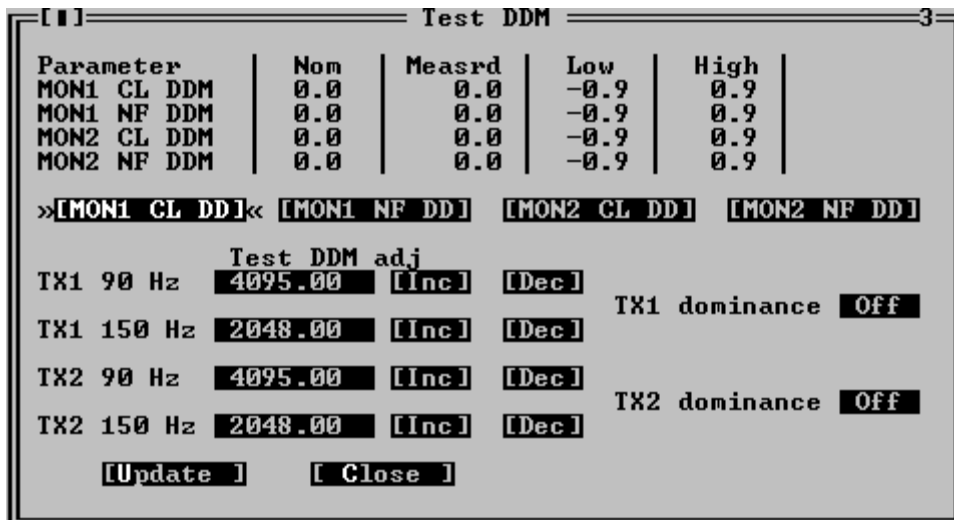

HBK690/3

Figure 5-45 Test DDM window

The test DDM values are unit-less integers in the range 0-4095.

### 5.16 Set ILS date/time

The functionality of the ILS|Set ILS date/time window depends on whether or not the user is logged in as an ordinary user or as master user. When logged in as a master user this window allows setting of the ILS RMS system clock. When logged in as an ordinary user, this window displays the current ILS RMS system date/time.

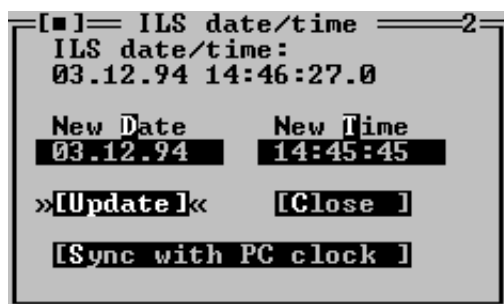

HBK660/2

Figure 5-46 ILS date/time window.

The available master user operations is outlined in the table below.

Field	Description
New Date	Holds the date to be sent to the ILS upon an Update button activation.
New Time	Holds the time to be sent to the ILS upon an Update button activation.
Update (button)	Sets the ILS RMS clock to the date/time specified in the New Date and New Time fields.

Field	Description
Sync with PC clock (button)	Sets the ILS RMS clock equal to the local PC system clock.
Close (button)	Closes the ILS date/time window.

Table 5-13 Master user available operations.

### 5.17 User administration

The functionality of the ILS|User list/adm. window depends on whether or not the user is logged in as an ordinary user or as master user. When logged in as a master user this window allows configuring of existing and new users which shall be granted access to the RMM system. When logged in as an ordinary user, this window only displays the last time each user was logged on.

The following is a description of the available operations when logged in as a master user.

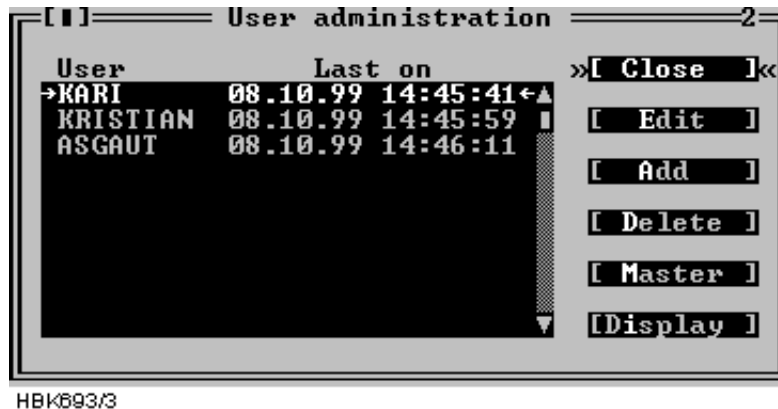

Figure 5-47 User administration window

The available master user operations is outlined in the table below.

Operation (button)	Description
EDIT	Edit the username and/or passwords for the currently selected user
ADD	Add a new user
DELETE	Delete the currently selected user
MASTER	Edit the passwords for the master user
DISPLAY	Edit the password for the ILS front panel display panel.

Table 5-14 Master user operations.

When Edit, Add or Master is selected in the User administration window a dialog showing the currently defined username and passwords is opened. In this dialog you may enter or change the username and password(s).

Note that passwords must be 6-8 characters in length. Both the username and passwords should only consist of characters in the range A-Z, a-z or 0-9.

The username for the master user cannot be changed.



HBK694/2

Figure 5-48 User configuration dialog

### 5.18 ILS Modem settings

With access level 3 you have access to change ILS modem bit rate and initiation strings and make the ILS initiate the modems. Selecting ILS|Modem configuration brings up the window shown below.

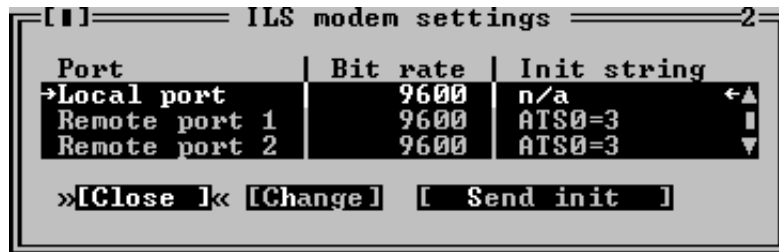

HBK662/3

Figure 5-49 ILS Modem settings window.

The window displays the currently configured bit rates and init strings. Pressing the **Change** button brings up a dialog where you can change the bit rate and/or the init string for the selected port. Note that it is no init string for the local port, since a modem is not supported for this port.

Pressing the **Send init** button starts modem initiation at the selected port. When the ILS is done initiating a dialog showing the result of the modem initiation will appear.

If the init-string is left blank or the word «**default**» is written, the ILS will use a default init-string that shall work on standard Hayes compatible modems under normal conditions.

Please consult the modem manual for further information about modem commands and initialisation.

### 5.19 Upload configuration to ILS

Several boards in the NORMARC 7000 cabinet store settings or operational parameters in internal EEPROM. Whenever a new board is inserted in a cabinet, these parameters need to be configured. This can be done by “uploading” the parameter values to the cabinet with the use of the “ILS | Configuration options | Upload configuration to ILS” menu item. When this menu item is chosen, a window for selecting a previously stored “CFG” file (see section 5.20) is displayed.

Once the user has selected the file containing the desired configuration parameters, the window shown in Figure 5-50 is opened. This window lists boards for which the configuration may

be uploaded. Configuration for one board or all boards (normally used only for new cabinets) can be uploaded.

This is an access level 3 operation.

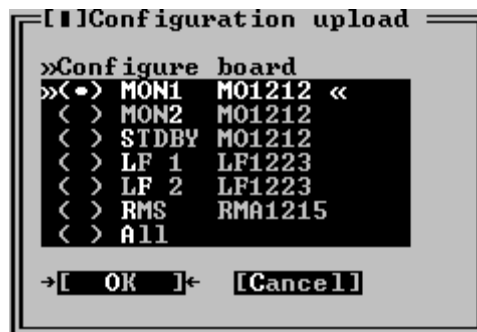

HBK1141/1

Figure 5-50 Configuration upload

When the OK button is clicked, the RMM software starts the upload and displays a window telling the user that the operation is in progress. The upload may take a few minutes, depending on the board type selected for upload. In order to speed up the upload process, it is a good idea to close all windows that display monitor or maintenance measurements (this frees up communication bandwidth).

Note 1: Refer to chapter 7 for detailed information on uploading configuration after e.g. a board replacement.

Note 2: The following configuration data for the RMS board are not stored in the configuration file and therefore require manual updating: "Lamp mappings", "ILS modem configuration", and "User list/ adm."

## 5.20 Write configuration to file

As described in section 5.19, different boards store configuration data in internal EEPROM. The configuration data can be stored on disk with the use of the "ILS | Configuration options | Write configuration to file" menu item. Selecting this menu item brings up the window shown in Figure 5-51. The user must enter a new filename, or select an existing file for storing the configuration parameters. If an existing file is selected, the user is asked whether or not the file should be overwritten.

This is an access level 1 operation.

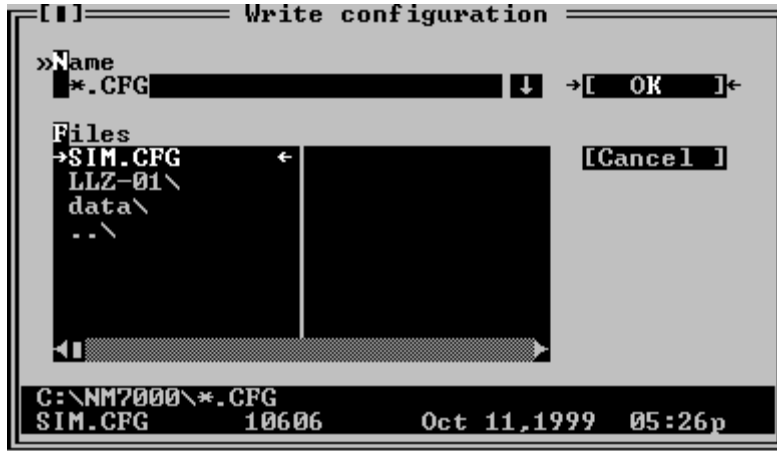

HBK1140/1

Figure 5-51 Write configuration to file.

The configuration file is a plain ASCII text file. The file may be inspected by the user, but to avoid introducing possible errors, it is not recommended to manually edit it

### 5.21 Lamp mappings

At access level 3 the user may configure which of the small warning LED's that are "mapped" to the main (big) warning LED on the local and remote control panels.

Figure 5-52 shows the window that appears when the "ILS | Configuration options | Lamp mappings" menu item is selected. An "X"-mark to the left of the warning type indicates that an active warning of that type will cause the corresponding main warning lamp to be activated.

If the configuration is changed, remember to click the "Update" button to send the new settings to the cabinet.

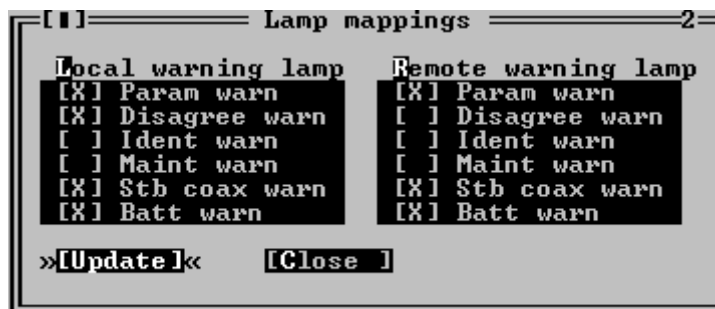

HBK1142/1

Figure 5-52 Lamp mappings HBK1142

### 5.22 Medium storage sample interval

The sample intervals for the medium time storage may be selected by choosing ILS| Configuration options| Medium storage sample interval. This brings up the window shown below.

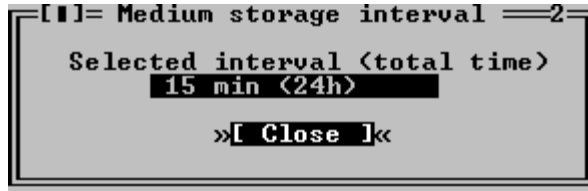

HBK745/2

Figure 5-53 Medium storage interval setting dialog

The following intervals may be selected

Storage interval	Total medium storage time
15 Minutes	24 Hours
30 Minutes	48 Hours
60 Minutes	4 Days
120 Minutes	8 Days

Table 5-15 Medium time storage interval settings

### 5.23 Displaying stored measurements

#### 5.23.1 General

This chapter describes how to open and display a storage buffer after it has been downloaded and stored on the local hard disk, as described in chapter 5.12.

The desired file is opened by selecting File|Open log. A dialog like the one shown below will be displayed. This dialog shows the files matching the wild card mask in the Name field. The directory may be changed by double clicking (or by pressing *Enter*) a list entry with a back slash (“\”) appended to the name.

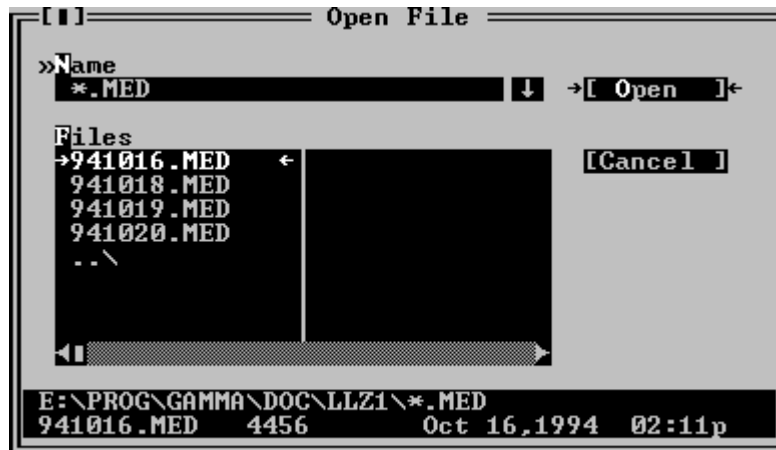

HBK685/3

Figure 5-54 Open log file dialog

When a selection has been made a new window will be opened. This window displays information about the data stored in the opened file. The different types of storage files have different information displayed in this window, as described in the following chapters.

When a this window is opened, you would display the stored status/measurements by open-

ing the appropriate windows by selecting menu items from the ILS menu. Note that some menu items will not be accessible because some information types is not stored in the log file.

To move back and forth in the stored data, press *F7* and *F8*.

### 5.23.2 Medium time periodic (MED)

When a MED file has been opened a window as shown below will be opened.

This window displays the time stamps of the first, the currently displayed one, and the last sample stored in the file.

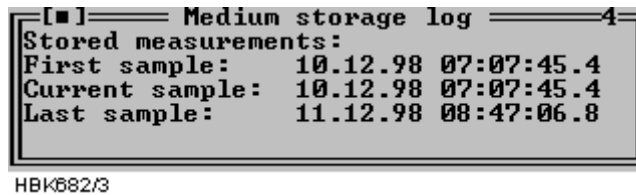

Figure 5-55 MED file log window

### 5.23.3 Alarm storage (ALA)

When an ALA file has been opened a window as shown below will be opened. This window shows the time stamps of the currently displayed Monitor 1, Monitor 2, Standby (if installed) and Maintenance monitor samples. This window also has a list where you select an alarm to study.

The operation of the window is outlined in the table below.

To accomplish this	Do this
Study a specific alarm	Select the desired alarm on the alarm selection list and press the "Display" button.
Advance to the first raw alarm state	Press the "1st alarm" button.

Table 5-16 Alarm storage operations.

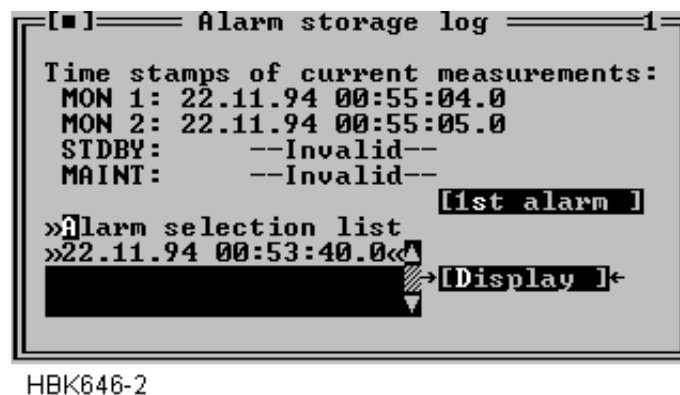

Figure 5-56 ALA file log window

### 5.23.4 Continuous data log (CNT)

When a CNT file has been opened a window as shown below will be opened. This window shows the same information as the Alarm storage window, except that this window does not have the alarm specific functions.

```

[ ] Cont storage log 1
Time stamps of current measurements:
MON 1: 27.11.94 14:38:03.0
MON 2: 27.11.94 14:38:03.0
STDBY: 27.11.94 14:38:05.0
MAINT: 27.11.94 14:38:37.0

```

HBK649/2

Figure 5-57 CNT file log window.

## 5.24 DIAGNOSTICS

### 5.24.1 General description of the diagnostic functions

The NM7000 RMM system has two algorithms to isolate a failure in the ILS. The algorithms are the *Current data diagnostics* and the *Alarm Event diagnostics*. See chapter 7 for a thorough description of these algorithms.

### 5.24.2 Current data diagnostics

This diagnostic function are invoked by selecting ILS|Current data diagnostics. Based upon the current status of the equipment, the program will suggest the faulty module, if any.

### 5.24.3 Alarm Event diagnostics

This diagnostic function are invoked from the Event list window. A CHANGEOVER or SHUTDOWN event must be selected in the event list, then may the diagnostic function be invoked by pressing the **Event diagnostics** button below the event list. Based upon the nature of the CHANGEOVER or SHUTDOWN event, combined with the contents of the corresponding alarm storage, the program will suggest the faulty module which originated the alarm. Note that the event storage diagnostics function will only be able to isolate faults to module level when a single fault has occurred

## 5.25 Exporting data

You can export stored measurements to a spreadsheet with the function described in this section. Exported data will be stored in an ASCII text file. This text file may then be imported into a spreadsheet program or a graphical presentation program.

Data from all types of log files may be exported.

The Export data function is located on the file menu. In order to use the function, you must first open the log file from which you want to export data. This is done by using the File|Open log function (described in chapter 5.22). When a log file has been opened you may select the Export data function. The dialog shown in Figure 5-58 will appear. Select the type of data to export and press OK. You will be prompted to enter a file name for the exported data. The Decimal point field selects the type decimal point character used when stored data are exported to a text file. Select the proper setting for use by your spreadsheet program or graphical presentation program.



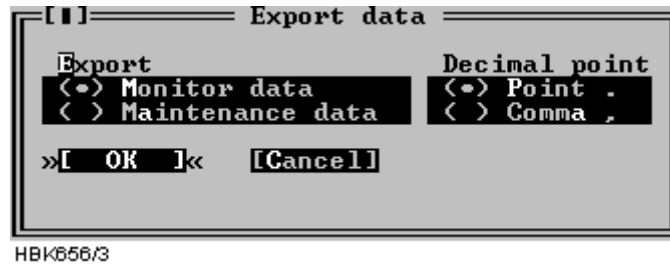

Figure 5-58 Export data dialog

Each field in the export file are separated by a TAB character. Each line contains all measurements in a sample. The line begins with the time stamp of sample (resolution 1 second). The next field is 1/10 seconds of the time stamp. The rest of the line is the measurements/parameters of the sample.

The type of decimal point used for analog measurements is defined by Decimal point setting in the Preferences dialog (see chapter 5.4.4).

Digital parameters (OK/ERROR) are exported as numbers, 0 and 1. 1 equals OK, and 0 indicates ERROR.

### 5.26 Printing reports

When you are logged in on an ILS you can make printouts of several measurements and configurations.

The Print Report function is located on the file menu. To use it you must first connect and log in on a ILS rack (access level 1). Figure 5-59 shows the Print Report dialog which is opened when you select the File|Print report menu item.

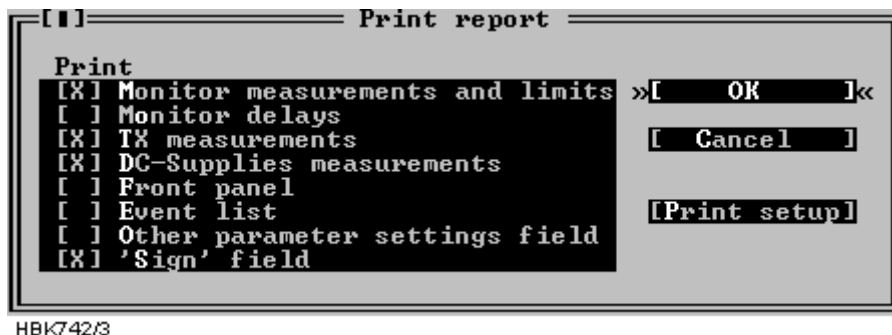

Figure 5-59 Print Report dialog

The system will print the data you select in the 'Print' section of the dialog. The **Print setup** button is a shortcut to the Options|Print setup dialog, described in chapter 5.4.3.

### 5.27 Print screen

To print the screen contents in the Windows 95/NT version, select the File|Print screen menu option. This will send the current screen contents to the printer port selected in the Print setup window.

To print the screen under DOS use the "Print Screen" key on the PC keyboard. This will print the screen on LPT1 (independent of the port selected in the Print setup window).

## 5.28 Technical note - Leased line SETUP (USRobotics)

### USING NM7000 RMM SOFTWARE WITH LEASED LINE CONNECTION

Applies to USRobotics Courier Dual Standard V.34+ modems

#### 5.28.1 Definitions

Local modem	The modem attached to the PC running NM7000 RMM software.
Remote modem	The modem attached to the NM7000 cabinet.

#### 5.28.2 Configuring the remote modem

1. *Set DIP switches on the remote modem.*
  - Switch 1 must be set to the DTR ALWAYS ON position.
  - Switch 4 must be set to the ON position - Do not echo offline commands
  - Switch 5 must be set to the AUTO ANSWER ON RING position.
  - The remaining switches should be left in their factory default positions.
2. *Connecting the modem to the cabinet.*
  - The remote modem must be connected to Remote Port 2 on the connection interface board in the ILS cabinet.
3. *Configure remote modem init string.*
  - With a PC running NM7000 RMM software, log in with MASTER access on the Local Port.
  - Select «Modem configuration» from the ILS menu.
  - Set the Remote port 2 modem configuration as follows (all '0' letters are zeroes):

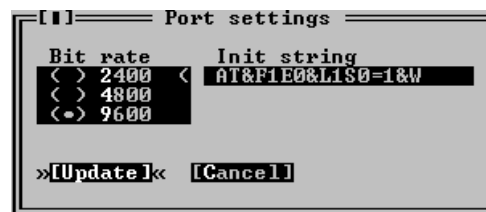

HBK1125/2

Figure 5-60 ILS port settings for leased-line connections

4. *Initializing the remote modem.*
  - Pressing the «Send init» button in the ILS modem settings window makes the ILS send the initialization string on the port selected in the port list.
  - The ILS will also send the these init strings when the ILS is powered on.

#### 5.28.3 Configuring the local modem

1. All modem DIP switches should be left in their factory default positions.

- Configure the «Channel Setup» for the leased line connection as follows (all '0' letters are zeroes):



HBK1124/2

Figure 5-61 RMM channel setup for USR leased-line connections

The modem will be automatically set up for leased when a connection with this channel is selected by the user.

Users of the DOS version should also select «Use DTR to hangup». The hangup string is ignored.

### 5.29 Technical note - Dial up connection SETUP (USRobotics)

#### USING NM7000 RMM SOFTWARE WITH DIAL UP CONNECTION

Applies to USRobotics Courier Dual Standard V.34+ modems

##### 5.29.1 Definitions

Local modem	The modem attached to the PC running NM7000 RMM software.
Remote modem	The modem attached to the NM7000 cabinet.

##### 5.29.2 Configuring the remote modem

- Set DIP switches on the remote modem.
  - Switch 1 must be set to the DTR ALWAYS ON position.
  - Switch 4 must be set to the ON position - Do not echo offline commands
  - Switch 5 must be set to the AUTO ANSWER ON RING position.
  - The remaining switches should be left in their factory default positions.
- Connecting the modem to the cabinet.
  - The remote modem must be connected to Remote Port 2 on the connection interface board in the ILS cabinet.
- Configure remote modem init string.
  - With a PC running NM7000 RMM software, log in with MASTER access on the Local Port.
  - Select «Modem configuration» from the ILS menu.
  - Set the Remote port 2 modem configuration as follows (All '0' letters are zeroes.):

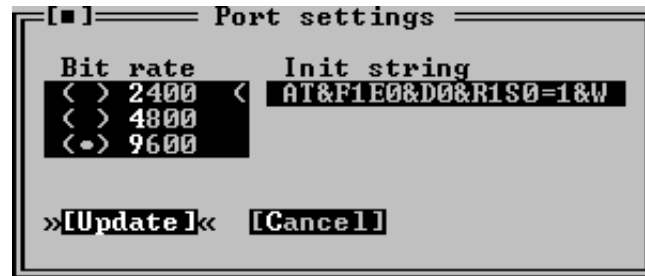

HBK1139/1

Figure 5-62 ILS port settings for USRobotics dial up connection

#### 4. Initializing the remote modem.

- Pressing the «Send init» button in the ILS modem settings window makes the ILS send the initialization string on the port selected in the port list.
- The ILS will also send these init strings each time the ILS is powered on.

### 5.29.3 Configuring the local modem

1. All modem DIP switches should be left in their factory default positions.
2. Configure the «Channel Setup» for the dial up connection as follows:



HBK1123/2

Figure 5-63 Local modem configuration

The modem will automatically dial and connect to the remote ILS when a connection with this channel is selected by the user.

Of course, the telephone number to dial when connecting to this station must be configured in the ILS Station Setup window.

Users of the DOS version should also select «Use DTR to hangup». The hangup string is ignored.

### NOTE

**Some PBX dial tones are not recognized by the modem. In this case the modem will not start dialing when the user has selected a station to connect to. The problem is corrected by entering X3 in the init string field. E.g.: AT&F1X3**

### 5.30 Technical note - Leased line SETUP (WESTERMO)

This description applies to Westermo TD-32AC / TD-32DC modems.

#### 5.30.1 DIP switch settings.

SW1:	1	2	3	4	
ILS Modem	0	1	0	1	Leased line, switch off echo and result code. All AT commands ignored, including +++
PC-Modem	1	0	0	0	Dial mode, configured from PC-program

SW2:	1	2	3	4	5	6	7	8	
ILS Modem	1	0	0	1	0	0	0	0	Enable SW2:2 to 7. Asynchronous. DTR/DSR disconnected.
PC-Modem	1	0	0	0	0	0	0	0	Enable SW2:2 to 7. Asynchronous. DTR/DSR not disconnected.

SW3:	1	2	3	4	5	6	7	8	
ILS and PC	1	0	0	0	0	0	0	0	2-wire connection.

SW4:	1	2	3	4	5	6	7	8	
ILS and PC	0	1	1	0	1	1	0	0	9600 bps. 8 data bits. No stop bits.

SW5:	1	2	3	4	5	6	7	8	
ILS-Modem	1	1	1	1	0	0	0	0	V.32bis, 9600 bps
PC-Modem	1	1	1	1	0	0	0	0	Auto detect line parameters.

#### 5.30.2 Connecting the modem to the cabinet.

The modem must be connected to Remote Port 1<sup>1</sup> or Remote Port 2 on the connection interface board in the ILS cabinet. The baud rate for this port must be 9600 bps (this is the default setting). There is no need to configure any modem init strings in the NM7000 RMS.

#### 5.30.3 Connecting the modem to the PC

The modem must be connected to COM1, 2, 3 or 4. The PC RMM modem connection type should be set to *Leased line*. The modem init string should be:

AT\N5&D0&C1&L1&WD

(The hangup string is ignored in the DOS version)

---

1. It is recommended to use Remote Port 2 on the ILS, because this port has a 16 byte FIFO that reduces the CPU load caused by the serial communication handling. If the modem must be connected to Remote Port 1, a cable with RTS (pin 4) connected to DSR (pin 6) both in the modem-end, must be used. Also, RTS must not be connected in the ILS-end.

### 5.31 Technical note - dial up SETUP (WESTERMO)

This description applies to Westermo TD-32AC / TD-32DC modems.

#### 5.31.1 DIP switch settings.

SW1:	1	2	3	4	
ILS Modem	0	0	0	0	Dial-up connection. Enable AT commands. Auto answer.
PC-Modem	1	0	0	0	Dial-up connection. Enable AT commands.

SW2:	1	2	3	4	5	6	7	8	
ILS Modem	1	0	0	1	0	0	0	0	Enable SW2:2 to 7. Asynchronous. DTR/DSR disconnected.
PC-Modem	1	0	0	0	0	0	0	0	Enable SW2:2 to 7. Asynchronous. DTR/DSR not disconnected.

SW3:	1	2	3	4	5	6	7	8	
ILS and PC	1	0	0	0	0	0	0	0	2-wire connection.

SW4:	1	2	3	4	5	6	7	8	
ILS and PC	0	1	1	0	1	1	0	0	9600 bps. 8 data bits. No stop bits.

SW5:	1	2	3	4	5	6	7	8	
ILS and PC	1	1	1	1	0	0	0	0	Auto detect line parameters.

#### 5.31.2 Connecting the modem to the cabinet.

The modem must be connected to Remote Port 1<sup>1</sup> or Remote Port 2 on the connection interface board in the ILS cabinet. The baud rate for this port must be 9600 bps. The init string for the port should be:

ATE0&C1&D2&W

#### 5.31.3 Connecting the modem to the PC

The modem must be connected to COM1, 2, 3 or 4. The connection type in the NM7000 RMM software must be set to *Normal dial-up*, the baud rate to 9600 bps and the init string should be:

ATX3&C1&D2\N5&W

In the DOS version, the *Use DTR to hangup* check box should also be checked (the hang-up string will then be ignored).

---

1. It is recommended to use Remote Port 2 on the ILS, because this port has a 16 byte FIFO that reduces the CPU load caused by the serial communication handling. If the modem must be connected to Remote Port 1, a cable with RTS (pin 4) connected to DSR (pin 6) both in the modem-end, must be used. Also, RTS must not be connected in the ILS-end.

## PART III MAINTENANCE

### 6 Periodic maintenance CAT I and II

#### **IMPORTANT:**

**No adjustments / alignments shall be done during a Periodic Maintenance. The parameters should be recorded and compared with their nominal values only.**

Over some time, the parameters may change due to natural variations. Variations of less than 50% of their alarm limits, are considered normal. If a parameter is changing more than 50% of its alarm limit, it is likely due to a discrepancy / degeneration of a module, cable etc. In this case, the reason for the discrepancy should be searched for.

If the result calls for changing a module, rephasing of cables etc., a flight check is often required to verify that parameters are inside operating tolerances.

#### **6.1 Weekly inspections**

Test equipment

- PC with RMM and printer

##### **6.1.1 Monitor Parameters recordings**

(Can be changed to Monthly intervals if allowed by the Authority.)

- Tx1 to antenna. Open the RMM program in *level 1*.
- Open **Monitor Window 1**.
- Open **Front Panel**.
- Make a paper copy by "Print Screen" function. (*Table 6-1*)
  
- Tx2 to antenna. (Executed by tower personnel if ILS is not taken out of service.)
- Make a second paper copy by "Print Screen" function. (*Table 6-2*)
- Compare Monitor parameter values with previous records.

#### **6.2 Monthly inspections**

Test equipment

- Field Test Set

#### **6.3 Quarterly inspections**

(Can be changed to 6 Months intervals for Cat I installations and 4 Months for Cat II.)

Test equipment

- Oscilloscope
- Stop watch
- PC with RMM and printer

##### **6.3.1 Tx Parameters and DC Power supply recordings.**

Tx1 to antenna. Tx2 active to dummy load.

Open **Maintenance parameters**. Double click **COURSE TX1 LPA/GPA, COURSE TX2 LPA/GPA, CLR TX1 LPA/GPA, CLR TX2 LPA/GPA, DC SUPPLIES**. Fill in Table 6-7 manually or make a paper copy by "Print Screen" function.

Compare values with previous recordings.

### 6.3.2 Monitor Integrity Check (Alternative 1)

#### 6.3.2.1 False radiation time Tx1 Main

Equipment in mode AUTO. Main Select Tx1. Tx 1 on.

- Remove the CL monitor cable from the monitor input.
- Note the time elapsed\*) from the signal was removed until Tx2 was shut off.
- Record in Table 6-9 line a) the measured delay time from cable removal until the standby transmitter has switched off. Check that the equipment carries out a changeover to Tx 2 before shutoff. Record in Table 6-9 line b)
- Open PA maintenance parameters window. (Ref para 5.7.5 Operating Manual). Check that PA 27V LEVEL Course Tx1 is 0 V. Record in Table 6-9 line c).

Reconnect the monitor cable.

#### 6.3.2.2 False radiation time Tx2 Main

Equipment in mode AUTO. Main Select Tx2. Tx 2 on.

- Remove the CL monitor cable from the monitor input.
- Note the time elapsed\*) from the signal was removed until Tx1 was shut off. Check that the equipment carries out a changeover to Tx 1 before shutoff.
- Record in Table 6-9 line d) the measured delay time from cable removal until the standby transmitter has switched off. Check that the equipment carries out a changeover to Tx 2 before shutoff. Record in Table 6-9 line e)
- Open PA maintenance parameters window. (Ref para 5.7.5 Operating Manual). Check that PA 27V LEVEL Course Tx1 and Clearance Tx 1 is 0 V. Record in Table 6-9 line f).

Reconnect the monitor cable.

Note:\*) *Near immediate change if short delays are used.*

### 6.3.3 Monitor Integrity Check (Alternative 2)

Can be performed from a remote location.

Test equipment

- PC with RMM

Note results in *Table 6-10 (Alternative 2)*.

#### 6.3.3.1 Integrity check:

Open the RMM program in *level 2*.

Note: Level 2 must be enabled for the remote RMM in the ILS configuration.

- Tx1 to antenna. Use **MAIN SELECT** and **CHANGEVER** in the **Front Panel** window.
- Open **Front Panel, Event List, Ident and Modulation Switches** and **Maintenance Windows for COURSE TX1 LPA/GPA, CLEARANCE TX1 LPA/GPA, COURSE TX2 LPA/GPA, CLEARANCE TX2 LPA/GPA**.
- Turn off Tx1 COU Mod 90Hz in the **Modulation Switches** window. Observe that a transfer



to Tx2 takes place.

a) Check that the text: **Auto ChgOver to TX2** appears in the event list.

Turn off Tx2 COU Mod 90Hz in the **Modulation Switches** window. Observe that the system turns off.

b) Check that the text: **Auto ShtDown frm TX2** appears in the event list.

c) Check that measurement for PA 27V level < 1V in **Maintenance Monitor Windows for COURSE TX1 LPA/GPA** and **COURSE TX2 LPA/GPA**.

Turn on Tx1 COU Mod 90Hz and Tx2 COU Mod 90Hz in the **Modulation Switches** window again.

## 6.4 Annual inspections

Test Equipment

- PC including NM7000 RMM program
- NM3710 ILS Field Test Set, including attenuator 20 dB or 30 dB
- Oscilloscope
- Frequency counter 10 Hz to 350 MHz
- RF Signal generator including calibrated ILS modulation
- Digital voltmeter
- Wattmeter with probe covering 328-336MHz, 10 watts.
- Stop watch

### 6.4.1 RF Frequency check.

Set the **AUTOMATIC/MANUAL** switch to *MANUAL* and **REMOTE/LOCAL** to *LOCAL*.

#### 6.4.1.1 Course Transmitter Frequency

Switch on Course Tx1.

- Connect the Frequency Counter to CSB Cou test connector in the **Change Over Section** via a 50 ohm test cable. (Use 50 ohm input port of the counter)
- If necessary switch off the 90 Hz and 150 Hz modulation through the **Local Display and Keyboard** or the **RMM Program**.

Nominal frequency: (Channel frequency + 7.5kHz)  $\pm 0.002\%$

Repeat the measurements for Course Tx2.  
Record the frequency readings in Table 6-11.

#### 6.4.1.2 Clearance Transmitter Frequency

Switch on Clearance Tx1.

- Connect the Frequency Counter to CSB CLR test connector in the **Change Over Section** via a 50 ohm test cable. (Use 50 ohm input port of the counter)
- If necessary switch off the 90 Hz and 150 Hz modulation through the **Local Display and Keyboard** or the **RMM Program**.

Nominal frequency: (Channel frequency - 7.5kHz)  $\pm 0.002\%$

Repeat the measurements for Clearance Tx2.  
Record the frequency readings in Table 6-11.

#### 6.4.2 LF Frequency check.

90/150 Hz MODULATION FREQUENCY checks

Switch on Course Tx1.

- Connect the Frequency Counter to CSB test connector on **Course Tx1 Section** via a 50 ohm test cable. (Use high impedance input port of counter)
- Turn off the 90 Hz modulation for Course Tx1 through the **Local Display and Keyboard** or the **RMM Program**.
- Read the 150 Hz frequency. Tolerance  $\pm 0.05$  Hz.
  
- Turn the 90 Hz modulation on and turn 150 Hz modulation off through the **Local Display and Keyboard** or the **RMM Program**.
- Read the 90 Hz frequency. Tolerance  $\pm 0.05$  Hz.

Repeat the test for Course Tx2.  
Record the frequency readings in Table 6-12.

#### 6.4.3 Transmitter waveforms checks.

Carry out the tests outlined in paragraphs a)...f) for Cou Tx2, CLR Tx1 and CLR Tx2.  
Record the results of the outlined tests in Table 6-8.

##### 6.4.3.1 PHASE CORR. check.

Switch on Course Tx1.

- Connect the Oscilloscope to PHASE CORR test connector on Course Tx1 Section via a 50 ohm test cable.
- Set Oscilloscope input mode to DC.

The waveform observed should take a continuous form without limiting segments or deep notches or other discontinuities.

(Each modulator develops it's own waveform shape due to spreads in insertion phases).  
The dynamic maximum point should be approximately -4 volt.

##### 6.4.3.2 SBO waveform checks.

Switch on Course Tx1.

- Connect the Oscilloscope to SBO test connector on Course Tx1 Section via 50 ohm test cable.
- Set Oscilloscope input mode to DC.
- Check that the waveform resembles the graph below, left.

For best signal resolution on the scope, it is advisable to set the oscilloscope in double sweep rate and FREE RUN trigger mode ("kissing pattern" mode). The two halves of the 30 Hz waveform will then overlap and look like one waveform when perfect power balance is achieved.

DEMODULATED SBO: NORMAL

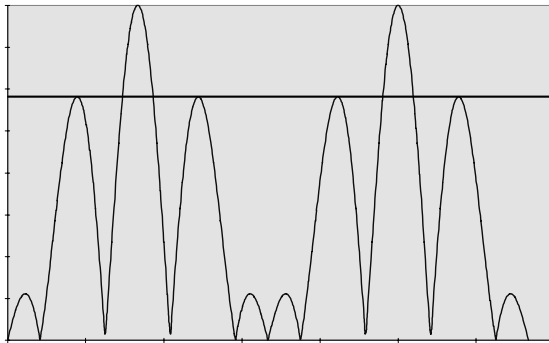

DEMODULATED SBO: 1dB POWER  
IMBALANCE (150Hz<90Hz)

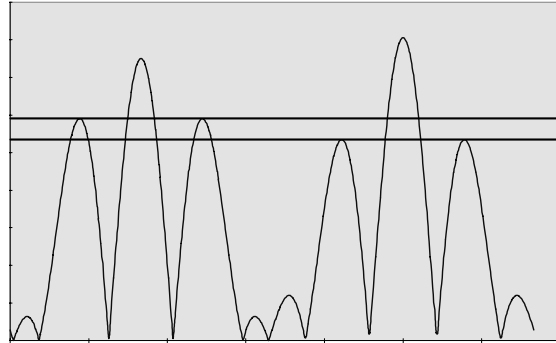

#### 6.4.3.3 RF Phase

- Connect the Oscilloscope to SBO test connector on Course Tx1 Section via 50 ohm test cable.

**NOTE:**

Set the scope's input mode to DC.

Set the oscilloscope in normal trigger mode such that the waveform below can be observed. The observed waveform should resemble the NORMAL graph on the left.

DEMODULATED SBO-SIGNAL: NORMAL

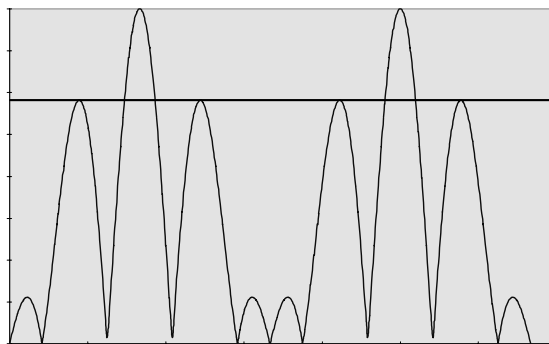

DEMODULATED SBO-SIGNAL: 5° RF-PHASE ERROR

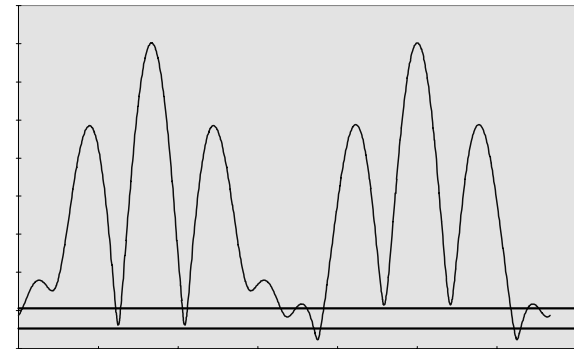

#### 6.4.3.4 CSB waveform check. LF phase

Switch on Course Tx1.

- Connect the Oscilloscope to CSB test connector on Course Tx1 Section via 50 ohm test cable.
- Set the Oscilloscope input mode to DC.

Look for the intermediate peaks of the CSB demodulated waveform. Check that the waveform resembles the graph below (left). The intermediate waveform peaks shall have the same max-

imum and minimum level, indicating 90/150 Hz zero phase start.

DEMOMULATED CSB: NORMAL

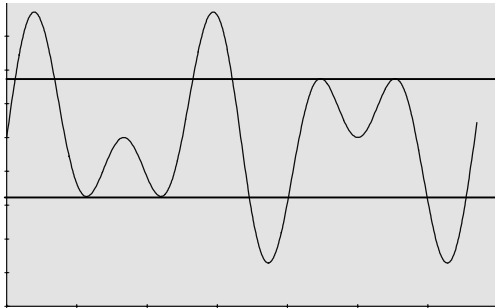

DEMOMULATED CSB: 10° LF PHASE ERROR

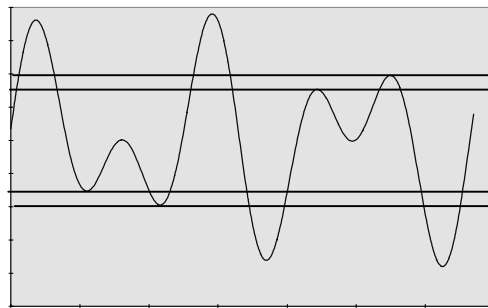

#### 6.4.3.5 DDM and SDM check.

Switch on Tx1.

- Connect the Field Test Set to the CSB Cou test connector on the Change Over Section through a 20 or 30 dB attenuator.
- Use a double shielded 50 ohm coaxial test cable. On the Field Test Set read DDM. The nominal reading should be 0.0% DDM.
- On the Field Test Set read SDM. The nominal reading should be 80.0%, or the same as the previous reading/ commissioned value.

#### 6.4.3.6 Not in use

#### 6.4.4 (Not in use)CSB output power.

a) Course Tx CSB. Switch off the transmitters. Select Tx1 as Main Tx.

- Insert the power meter into the Course CSB output path of the Cabinet. Switch on Tx1. Read and record the Tx1 power in *Table 6-13*.
- Change over to Tx2. Read and record the Tx2 power in *Table 6-13*.

b) Clearance Tx CSB. Switch off the transmitters. Select Tx1 as Main Tx.

- Insert the power meter into the Clearance CSB output path of the Cabinet. Switch on Tx1. Read and record the Tx1 power in *Table 6-13*.
- Change over to Tx2. Read and record the Tx2 power in *Table 6-13*.

#### 6.4.5 Monitor Alarm Limit checks.

After completion and recording of the alarm parameters into Table 6-14, compare and check that the values are the same as in the previous records.

External RF Signal Generator applied as signal source.

Set the **AUTOMATIC/MANUAL** switch to *MANUAL*, the **REMOTE/LOCAL** to *LOCAL* and **MAIN SELECT** to *Tx1*.

Switch on Course Tx1 and Clearance Tx1.

Check **Monitor 1** first.

#### 6.4.5.1 CL DDM ALARM

Apply a test signal from the RF Signal Generator to the CL input connector in the back of the cabinet. (Disconnect first the signal cable from the Monitor network). Adjust the signal to the same RF level and frequency as the normal signal applied to the monitor.

Modulation shall be: 0.0% DDM, 80.0% SDM.

Verify modulation setting (DDM, SDM) by checking the test signal with the Field Test Set.

Use the **Local Display and Keyboard** or the **RMM Program** to display the measured values for CL DDM.

- Change DDM from the generator slowly towards 150 Hz dominance until a point where the letter **A** (indicates that monitor has an ALARM for the displayed parameter) is shown beside the measured parameter for **Monitor 1**.
- Check the new generator DDM value with the Field Test Set.
- Record in Table 6-14 line *a*).
  
- Change DDM from the generator slowly towards 90 Hz dominance until a point where the letter **A** (indicates that monitor has an ALARM for the displayed parameter) is shown beside the measured parameter for **Monitor 1**.
- Check the new generator DDM value with the **Field Test Set**.
- Record in Table 6-14 line *aa*).

Repeat the procedure for **Monitor 2**.

#### 6.4.5.2 CL SDM ALARM

The test setup is the same as in a).

Use the **Local Display and Keyboard** or the **RMM Program** to display the measured values for CL SDM

- Increase SDM from the generator slowly until a point where the letter **A** (indicates that monitor has an ALARM for the displayed parameter) is shown beside the measured parameter for **Monitor 1**.
- Check the new generator SDM value with the Field Test Set.
- Record in Table 6-14 line *b*).
  
- Decrease SDM from the generator slowly until a point where the letter **A** (indicates that monitor has an ALARM for the displayed parameter) is shown beside the measured parameter for **Monitor 1**.
- Check the new generator SDM value with the Field Test Set.
- Record in Table 6-14 line *bb*).
- Repeat the procedure for **Monitor 2**.

#### 6.4.5.3 CL RF ALARM

The test setup is the same as in a).

Use the **Local Display and Keyboard** or the **RMM Program** to display the measured values for CL SDM.

- Decrease slowly RF level on the generator until a point where the letter **A** (indicates that monitor has an ALARM for the displayed parameter) is shown beside the measured parameter for **Monitor 1**.
- Record the RF level reading at alarm point in Table 6-14 line *c*).

Repeat the procedure for **Monitor 2**.

#### 6.4.5.4 DS DDM ALARM

Apply a test signal from the RF Signal Generator to the DS input connector in the back of the cabinet. (Disconnect first the signal cable from the Monitor network). Adjust the signal to the same RF level and frequency as the normal signal applied to the monitor.

Modulation shall be: 17.5%DDM, 80.0%SDM.

Verify modulation setting (DDM, SDM) by checking the test signal with the **Field Test Set**.

Use the **Local Display and Keyboard** or the **RMM Program** to display the measured values for DS DDM.

- Increase DDM from the generator slowly above nominal value until a point where the letter **A** (indicates that monitor has an ALARM for the displayed parameter) is shown beside the measured parameter for **Monitor 1**.
- Check the new generator DDM value with the Field Test Set.
- Record in *Table 6-14* line *d*).
  
- Decrease DDM from the generator slowly below nominal value until a point where the letter **A** (indicates that monitor has an ALARM for the displayed parameter) is shown beside the measured parameter for **Monitor 1**.
- Check the new generator DDM value with the Field Test Set.
- Record in *Table 6-14* line *dd*).

Repeat the procedure for **Monitor 2**.

#### 6.4.5.5 NF DDM ALARM

Apply a test signal from the RF Signal Generator to the NF input connector in the back of the cabinet. (Disconnect first the signal cable from the Near Field Antenna). Adjust the signal to the same RF level and frequency as the normal signal applied to the monitor.

Modulation shall be: 0.0% DDM, 80.0% SDM.

Verify modulation setting (DDM, SDM) by checking the test signal with the **Field Test Set**.

Use the **Local Display and Keyboard** or the **RMM Program** to display the measured values for NF DDM

- Change DDM from the generator slowly towards 150 Hz dominance until a point where the letter **A** (indicates that monitor has an ALARM for the displayed parameter) is shown beside the measured parameter for **Monitor 1**.
- Check the new generator DDM value with the Field Test Set.
- Record in *Table 6-14* line *e*).
  
- Change DDM from the generator slowly towards 90 Hz dominance until a point where the letter **A** (indicates that monitor has an ALARM for the displayed parameter) is shown beside the measured parameter for **Monitor 1**.
- Check the new generator DDM value with the Field Test Set.
- Record in *Table 6-14* line *ee*).

Repeat the procedure for **Monitor 2**.

#### 6.4.5.6 CLR DDM ALARM

Apply a test signal from the RF Signal Generator to the CLR input connector in the back of the cabinet. (Disconnect first the signal cable from the Monitor network). Adjust the signal to the

same RF level and frequency as the normal signal applied to the monitor.

Modulation shall be: Same as commissioned values DDM and SDM from CLR output of Monitor network.

Verify modulation setting (DDM, SDM) by checking the test signal with the Field Test Set.

Use the **Local Display and Keyboard** or the **RMM Program** to display the measured values for CLR DDM.

- Increase DDM from the generator slowly from nominal value until a point where the letter **A** (indicates that monitor has an ALARM for the displayed parameter) is shown beside the measured parameter for **Monitor 1**.
- Check the new generator DDM value with the Field Test Set.
- Record in Table 6-14 line *f*).
  
- Decrease DDM from the generator slowly from nominal value until a point where the letter **A** (indicates that monitor has an ALARM for the displayed parameter) is shown beside the measured parameter for **Monitor 1**.
- Check the new generator DDM value with the Field Test Set.
- Record in Table 6-14 line *ff*).

Repeat the procedure for **Monitor 2**.

#### 6.4.5.7 CLR SDM ALARM

The test setup is the same as in *f*).

Use the **Local Display and Keyboard** or the **RMM Program** to display the measured values for CLR SDM.

- Increase SDM from the generator slowly until a point where the letter **A** (indicates that monitor has an ALARM for the displayed parameter) is shown beside the measured parameter for **Monitor 1**.
- Check the new generator SDM value with the Field Test Set.
- Record in Table 6-14 line *g*).
  
- Decrease SDM from the generator slowly until a point where the letter **A** (indicates that monitor has an ALARM for the displayed parameter) is shown beside the measured parameter for **Monitor 1**.
- Check the new generator SDM value with the Field Test Set.
- Record in *Table 6-14* line *gg*).

Repeat the procedure for **Monitor 2**.

#### 6.4.5.8 CLR RF ALARM

The test setup is the same as in *c*).

Use the **Local Display and Keyboard** or the **RMM Program** to display the measured values for CL SDM.

- Decrease slowly RF level on the generator until a point where the letter **A** (indicates that monitor has an ALARM for the displayed parameter) is shown beside the measured parameter for **Monitor 1**.
- The nominal level reduction should be 1 dB.
- Record the RF reading at alarm point in Table 6-14 line *h*).

Repeat the procedure for **Monitor 2**.

#### 6.4.6 Near Field Monitor delay

Set the **AUTOMATIC/MANUAL** switch to *AUTOMATIC*, the **REMOTE/LOCAL** to *LOCAL* and **MAIN SELECT** to *Tx1*.

Switch on Course Tx1 and Clearance Tx1.

**System Status Indications** should be *NORMAL* and *SERVICE*

Make an alarm by removing the NF cable to the Cabinet. After the specified delay, the transmitter shall change to Tx2, then after the same time lapse Tx2 shall shut down.

Record in Table 6-15 line a) the measured delay time from cable removal until the standby transmitter has switched off.

#### 6.4.7 20 seconds inhibit

After shutdown check that an immediate attempted restart of a transmitter is inhibited at least 20 seconds from the time the standby Tx is shut off.

Record in Table 6-15 line b) the measured time lapse from the standby transmitter has switched off until the main transmitter is again radiating to the antenna.

#### 6.4.8 Battery maintenance

Check with digital voltmeter that the voltage across the battery terminals is between 27.0 V and 27.8 V. Record in Table 6-16 line a) the measured voltage.

Switch off the mains 220 V. After approximately 10 minutes battery operation with transmitter to air check that the voltage across the battery terminals is not less than 23 V. Record in Table 6-16 line b) the voltage.

Switch back to mains 220 V. After 24 hours check that the battery terminal voltage is again back between 27.0 to 27.8 V. Record in Table 6-16 line c) the voltage. The 27 V can be monitored from the RMM facility.

#### 6.4.9 Final check GP

Check that all electrical contacts and connectors are not loose.

Carry out a visual check outside and inside of the equipment.

Check that all switches and keys are in *NORMAL* position.

Check that the System lamp status is *NORMAL* after the switches *AUTO/MANUAL* and *REMOTE ON/OFF* are in *AUTO* and *ON* respectively.



		MON1	MON2
CL	DDM %		
	SDM %		
	RF V		
DS	DDM %		
	SDM %		
	RF V		
NF	DDM %		
	SDM %		
	RF V		
CLR	DDM %		
	SDM %		
	RF V		
DF	kHz		
CL	IDENT	N.A.	N.A.
CLR	IDENT	N.A.	N.A.
Self test			
DC Loop		N.A.	N.A.

Table 6-1 Monitor 1 window (Tx 1 to Air)

		MON1	MON2
CL	DDM %		
	SDM %		
	RF V		
DS	DDM %		
	SDM %		
	RF V		
NF	DDM %		
	SDM %		
	RF V		
CLR	DDM %		
	SDM %		
	RF V		
DF	kHz		
CL	IDENT	N.A.	N.A.
CLR	IDENT	N.A.	N.A.
Self test			
DC Loop		N.A.	N.A.

Table 6-2 Monitor 1 window (Tx 2 to Air)

		MON1	MON2
CL	DDM %	0.0	0.0
	SDM %	80.0	80.0
	RF V	3.0	3.0
DS	DDM %	0.0	0.0
	SDM %	80.0	80.0
	RF V	3.0	3.0
NF	DDM %	0.0	0.0
	SDM %	80.0	80.0
	RF V	3.0	3.0
CLR	DDM %	0.0	0.0
	SDM %	80.0	80.0
	RF V	3.0	3.0
DF	kHz	15.0	15.0
CL	IDENT		
CLR	IDENT		
Self test		OK	OK
DC-loop			

Table 6-3 Monitor 1 window

(Not for recordings, make a "print screen copy")

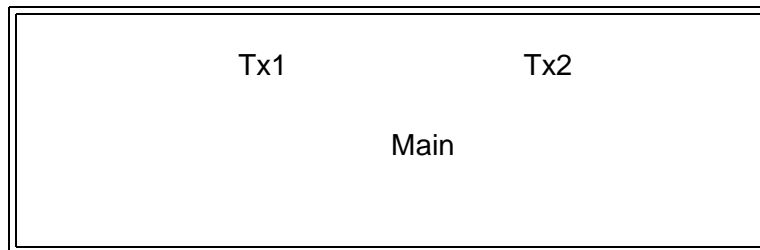

Table 6-4 Front panel window (displays Tx1 to air)

		MON1	MON2
CL	DDM %	0.0	0.0
	SDM %	80.0	80.0
	RF V	3.0	3.0
DS	DDM %	0.0	0.0
	SDM %	80.0	80.0
	RF V	3.0	3.0
NF	DDM %	0.0	0.0
	SDM %	80.0	80.0
	RF V	3.0	3.0
CLR	DDM %	0.0	0.0
	SDM %	80.0	80.0
	RF V	3.0	3.0
DF	kHz	15.0	15.0
CL	IDENT		
CLR	IDENT		
Self test		OK	OK
DC-loop			

Table 6-5 Monitor 1 window

(Not for recordings, make a "print screen copy")

Tx1	Tx2
Main	

Table 6-6 Front panel window (Displays Tx2 to air)

<b>DC Supplies</b>		<b>Unit</b>	
RMS +5V	(V)		
RMS Battery	(V)		
PS1 -15V	(V)		
PS2 -15V	(V)		
PS1 +5V	(V)		
PS2 +5V	(V)		
PS1 +8.5V	(V)		
PS2 +8.5V	(V)		
PS1 +15V	(V)		
PS2 +15V	(V)		
TX1 CLR I150	(A)		
TX1 CLR I90	(A)		
TX1 COU I150	(A)		
TX1 COU I90	(A)		
TX2 CLR I150	(A)		
TX2 CLR I90	(A)		
TX2 COU I150	(A)		
TX2 COU I90	(A)		
BATTERY CURRENT	(A)		
POWER CURRENT	(A)		
BATTERY VOLTAGE	(A)		

<b>Course Tx1 LPA/GPA</b>		
PA 27V Level (V)		
CSB Level (W)		
SBO Level (W)		
PH CORR LEVEL		
<b>Course Tx2 LPA/GPA</b>		
PA 27V Level (V)		
CSB Level (W)		
SBO Level (W)		
PH CORR LEVEL		
<b>CLR TX1 LPA/GPA</b>		
PA 27V Level (V)		
CSB Level (W)		
<b>CLR TX2 LPA/GPA</b>		
PA 27V Level (V)		
CSB Level (W)		

Table 6-7 (Not for recordings, make a "print screen copy")

	<b>Date</b>				
		<b>Cou Tx1</b>	<b>Cou Tx2</b>	<b>CLR Tx1</b>	<b>CLR Tx2</b>
a)	Phase corr check (ok)				
b)	SBO waveform check (ok)				
c)	CSB/LF phase check (ok)				
d)	RF phase check (ok)				
e)	DDM check Cou (%DDM)				
f)	SDM check Cou (%SDM)				
g)	(Not in use)				

Table 6-8 Transmitter waveform checks

	Date						
a)	General alarm delay Tx1 - Tx2	sec					
b)	Changeover carried out						
c)	PA 27V level						
d)	General alarm delay Tx1 - Tx2	sec					
e)	Changeover carried out						
f)	PA 27V level						

Table 6-9 Monitor Integrity Test (Alternative 1)

	Date	
a)	Auto ChgOver to TX2 (ok)	
b)	PA 27V level <1V (ok)	
c)	Auto ShtDown frm TX2 (ok)	
d)	PA 27V level <1V (ok)	
e)	Auto ChgOver to TX1(ok)	
f)	PA 27V level <1V (ok)	
g)	Auto ShtDown frm TX1 (ok)	
h)	PA 27V level <1V (ok)	

Table 6-10 Monitor Integrity Test (Alternative 2)

	Date		Tx1	Tx2
a)	Course transmitter frequency	MHz		
b)	Clearance transmitter frequency	MHz		

Table 6-11 RF Frequency check

Date		Tx1	Tx2
150 Hz frequency	Hz		
90 Hz-Frequency	Hz		

Table 6-12 LF Frequency check

	Date		Tx1	Tx2
a)	Course transmitter output power	W		
b)	Clearance transmitter output power	W		

Table 6-13 CSB output power

Date										
Mon1/Mon2			M1	M2	M1	M2	M1	M2	M1	M2
Text ref.	Parameter	Unit								
a)	CL DDM Alarm 150	μA/%DDM								
aa)	CL DDM alarm 90	μA/%DDM								
b)	CL SDM alarm high	%								
bb)	CL SDM alarm low	%								
c)	CL RF alarm	dB								
d)	DS DDM alarm wide	μA/%DDM								
dd)	DS DDM alarm narrow	μA/%DDM								
e)	NF DDM alarm 150	μA/%DDM								
ee)	NF DDM alarm 90	μA/%DDM								
f)	CLR DDM alarm 150	μA/%DDM								
ff)	CLR DDM alarm 90	μA/%DDM								
g)	CLR SDM alarm high	%								
gg)	CLR SDM alarm low	%								
h)	CLR RF alarm	dB								

Table 6-14 Monitor Alarm Limits check

Date										
a)	Near Field Monitor Delay	sec								
b)	20 seconds inhibit	sec								

Table 6-15 Near Field Monitor Delay and 20 seconds inhibit

Date										
a)	Battery terminal voltage	volts								
b)	Battery terminal voltage	volts								
c)	Battery terminal voltage	volts								

Table 6-16 Battery maintenance

## **7 Corrective maintenance**

### **7.1 Overview**

This chapter contains procedures for locating and replacing faulty Line Replaceable Units (LRU).

### **7.2 Diagnostic functions**

#### **7.2.1 General description**

If the LLZ or GP fails, the RMM software should be used to locate the faulty LRU.

The RMM software can perform two types of diagnostic tests based on the measurements made available by the embedded RMS software in the NORMARC 7000 cabinet:

1. "Current data diagnostics". The diagnose is here based on live data received from an connected ILS rack or based on historical data sets (snap shots) of measurements previously stored to disk.
2. "Alarm event diagnostics". This diagnostics function attempts to report the cause of a transmitter changeover or a changeover/shutdown situation. The diagnose is based on a particular alarm event in the event list and the corresponding measurements in an alarm storage that will be downloaded from the rack.

The diagnostic tests are based on passive reading of various measurement points inside the NM70XX cabinet and the data from the executive monitors. No special signals need to be injected for the algorithms to work (although the transmitters must be turned on).

The operator needs to be logged in at access level 1 to perform a Current data diagnostics and an Alarm event diagnostics. Since only access level 1 is required, the diagnostics tests can therefore be performed locally or from a remote location using a modem connection.

#### **7.2.2 Current data diagnostics**

The Current data diagnostics is invoked by selecting the ILS | Current data diagnostics menu item in the RMM software.

There are two typical cases in which the current data diagnostics function may be used:

1. On an operative ILS system, on which a warning situation is indicated. In this case the current data diagnostics can be used to quickly find the cause of the warning without taking the system out of service.
2. In manual mode after a transmitter changeover or shutdown situation (monitor alarm). The system can then be set to transmit on air, and the current data diagnostics used to locate the module that is causing the monitor alarms.

For detailed information about the algorithms used in the automatic Current data diagnostics, refer to section 7.4.3.

#### **7.2.3 Alarm event diagnostics**

The RMS subsystem in the NORMARC 7000 cabinet continuously reads data sets from monitor 1, 2 and the standby monitor. The last 30 seconds of data are stored in an internal ring buffer. This buffer is partitioned in groups with different sampling periods:

- For the last 2 seconds, 10 data sets are stored each second for monitor 1 and 2. Standby

monitor data sets are stored at ¼ of this frequency.

- For the last 10 seconds, one data set is stored each second.
- For the last 30 seconds, monitor 1, 2, standby and maintenance data are stored every 5<sup>th</sup> second.

When a changeover or shutdown alarm occurs the RMS does the following:

1. Stores the ring buffer with the last 30 seconds of monitor and maintenance data from before the alarm in an internal alarm storage buffer. This buffer resides in non-volatile RAM.
2. Places an changeover or shutdown alarm event in the event list. This event includes alarm state information for each monitor-channel. This information is used by the RMM software for diagnosing the alarm event.

The RMS keeps the seven most recent alarm storage buffers. A changeover-only situation fills one alarm storage buffer, while a changeover with subsequent shutdown situation uses two alarm storage buffers.

No alarm storage buffers will be saved if the equipment is in service mode when the alarm occurs. (Service mode is activated by any of the following switches: Local, Manual, Write Protect disable, Interlock Override and the Access Grant enable switch on the Remote Control.)

The data in the buffers can be downloaded by the RMM software when a user initiates an alarm event diagnostics (if the data is not already downloaded), and used in the diagnostic algorithms described in the following sections.

The operator initiates an alarm event diagnostics by first selecting a changeover or shutdown alarm in the Event List and then selects the "Event diagnostics" button.

Once the alarm storage has been downloaded it is also possible to display the individual samples. This method can be used, in addition to the automatic diagnostic function, to find the cause of changeover or shutdown alarms.

For information on how to download and display historical data see Chapter 5 in the Operating Manual.

For detailed information about the algorithms used in the automatic Alarm event diagnostics, refer to section 7.4.4.

#### **7.2.4 Manual fault diagnosis**

Should the automatic diagnostic functions fail or give misleading results, manual diagnosis using external measurement equipment can be performed.

### **7.3 LRU change procedures**

#### **7.3.1 Replacing units**

When replacing any faulty module(s), please follow this procedure:

- Make sure the ILS configuration file from the last flight check is available if one of the following boards need to be replaced: MO1212, LF1223, or RMA1215.
- Make a print report of the monitor and maintenance values to document what the key parameters were before the faulty module(s) was/were changed.
- Power down the system.



- Make sure you are wearing an ESD chain that is connected to either the ILS cabinet or some other grounded point.
- Replace the faulty module.
- Power up the system.
- Perform necessary adjustments for the unit in question; please refer to ch. 7.3.2-7.3.10.
- Check the Monitor and Maintenance parameters, make a new printout and compare with the printed report made when the system was operating normally.
- *If any anomalies are discovered, follow the procedure described in chapters and to locate the specific error.*

The manufacturer don't recommend repairing faulty units. The ILS cabinet is modularly built up to make it possible to change smaller parts of the system at a relatively low cost.

### 7.3.2 MF1211/MF1219 replacement

#### PREPARATIONS:

Power down system. Remove old unit and place the new unit on an extender board.

#### ADJUSTMENT (DS-CHANNEL):

Pre-check	Check that all monitor inputs from MCU are correct. (Use field measurement instrument NM3710). Make a note of the values.
RF-level	Set R338 in middle position. Set strap fields S++ on connector P2 and adjust R338 until TP23 reads 240mV. Adjust RF potentiometer R342 on front of MF1219 card until DS RF level reads exactly 3,0 volts.
AGC Time	Adjust AGC timing pot R49 until DC value measured at TP1 are the same with transmitters on and off.
SDM	Adjust SDM pot R48 until the DS SDM reading is the same as the value measured with the 3710.
DDM	Check that the DS DDM reading is the same as with 3710 (Nominal Value may be set in RMM program to give a DDM screen readout of 0%).

#### ADJUSTMENT (CLR-CHANNEL):

Pre-check	Check that all monitor inputs from MCU are correct. (Use field measurement instrument NM3710). Make a note of the values.
RF-level	Set R1338 in middle position. Set strap fields S++ on connector P1002 and adjust R1338 until TP1023 reads 240mV. Adjust RF potentiometer R1342 on front of MF1219 card until CLR RF level reads exactly 3,0 volts.AGC.
AGC Time	Adjust AGC timing pot R1049 until DC value measured at TP 2 is the same with transmitters on and off.
SDM	Adjust SDM pot R48++ until the CLR SDM reading is the same as the values measured with the 3710.
DDM	Check that the CLR DDM readings are the same as with 3710 (Nominal Value may be set in RMM program to give a DDM screen readout of 0%).

#### ADJUSTMENT (CL CHANNEL):

Pre-check	Check that all monitor inputs from MCU are correct. (Use field measurement instrument NM3710). Make a note of the values.
RF-level	Set R2338 in middle position. Set strap fields S++ on connector P2002 and adjust R2338 until TP2023 reads 240mV. Adjust RF potentiometer R2342 on front of MF1219 card until RF level reads exactly 3,0 volts.
AGC Time	Adjust AGC timing pot R2049 until DC values measured at TP 3 is the same with transmitters on and off.
SDM	Adjust SDM pot R2048 until the CL SDM readings is the same as the value

measured with the 3710.  
 DDM Check that the CL DDM readings are the same as with 3710.

**ADJUSTMENT (NF CHANNEL):**

Pre-check Check that all monitor inputs from MCU are correct. (Use field measurement instrument NM3710). Make a note of the values.  
 RF-level Set R3338 in middle position. Set strap fields S++ on connector P3002 and adjust R3338 until TP3023 reads 240mV. Adjust RF potentiometer R3342 on front of MF1219 card until NF RF level reads exactly 3,0 volts.  
 AGC Time Adjust AGC timing pot R3049 until the DC value measured at TP4 are the same with transmitters on and off.  
 SDM Adjust SDM pot R3048 until the NF SDM readings is the same as the value measured with the 3710.  
 DDM Check that the NF DDM reading is the same as with 3710.

**CHECK:**

Power down system. Remove the extension card and place the MF1219 inside cabinet. Turn transmitters on.

Monitor Use RMM software to check monitor readings for all four channels. RF level should now be 3.0V, SDM 40% and DDM 0,0%. It might be necessary to make small adjustments to the RF Level with potentiometers R342 (DS), R1342 (CLR), R2342 (CL) and R3342 (NF).  
 Maintenance Use RMM software to check maintenance values for MF1219 card. There shall be no warnings (if the transmitters are on).

**7.3.3 PS1227 replacement****PREPARATIONS:**

Power down system. Remove old unit and place the new unit in the vacant slot.

**ADJUSTMENT:**

No adjustments are necessary.

**CHECK:**

System: Remove the other PS1227 unit. Turn transmitters on and set the correct transmitter to air (Transmitter 1 to check Powersupply 1). Check the monitor readings to verify correct transmitter behaviour.  
 Maintenance Power down the ILS, re-insert the other PS1227 unit, and power up again. Check the RMM maintenance readings of the PS1227 system voltages; check both powersupplies.

**7.3.4 OS1221 replacement****PREPARATIONS:**

Power down system. Remove old unit. Write down the strap settings of the old OS1221A (LLZ) or 1221B (GP) card and make sure the new card is identically configured. Please refer to Appendix B to verify the frequency selection.

**ADJUSTMENT:**

The frequency of the RF output signal is normally factory adjusted. To adjust the frequency, power down the ILS, remove the shield, place the OS1221 card on an extender board and adjust by fine-tuning the capacitor C1. Turn off 90, 150 and 1020 Hz modulation tones from

RMM software. Measure the RF frequency at the CSB outlet at the front of the ILS cabinet

**CHECK:**

Power down the system and place the card inside cabinet.

Maintenance Check the maintenance parameters for the OS1221 unit.

### **7.3.5 MO1212 replacement**

**PREPARATIONS:**

- Power down system. Remove old unit.
- Compare the version numbers of the removable EPROM on the card. Make sure the new unit contains the same or newer EPROM software version.
- Place the new card in the vacant slot.

**ADJUSTMENT:**

1. Use RMM software to upload configuration to the replaced monitor board.
2. Check that the CL, DS, NF and CLR measurements in the RMM software are the same as before the replacement. Adjust the channel gains on the corresponding monitor frontend board if any discrepancies are seen.

**CHECK:**

Verify monitor limits with an external ILS generator, as described in chapter 6.

Monitor Make sure the ILS is operating in normal state (transmitters on) and check that all parameters are normal.

Maintenance Check the maintenance parameters for the MO1212 unit.

Final Make a printout of the monitor values (Print Report) and settings. Compare with previous report taken before the board was replaced. Check that the alarm limits and delays are the same as before.

### **7.3.6 TCA1218 replacement**

**PREPARATIONS:**

Power down system. Remove old unit.

**ADJUSTMENT:**

Make sure that all configuration straps (U1) are set as on the previous module. The best way to do this is to exchange the U1 component platform.

Compare the version numbers of the EPROM- and FPGA units on the board. Make sure the new unit contains the same EPROM and FPGA versions.

**CHECK:**

Start up: Check that the ILS front panel display shows the correct equipment setting (e.g. NM7013 Two-frequency Localizer).

Maintenance: Check the maintenance parameters for the TCA1218 unit.

Front Panel: Set the local/remote switch in local position and the auto/manual switch in manual position. Check that it is possible to turn transmitters on/off and perform a changeover.

Integrity test: Turn main transmitter(s) on. Set the auto/manual switch in auto position. Use RMM software to switch off the 90 Hz tones of both main transmitters. Observe that a changeover, and after a while a shutdown takes place.

For more extensive integrity testing of the monitors, please refer to Operating Manual, chapter 6.

### **7.3.7 RMA1215 replacement**

#### PREPARATIONS:

Power down system. Remove old unit. Compare the version numbers of the removable RMS EPROM on the board. Make sure the new unit contains the same or newer EPROM software version.

#### ADJUSTMENT:

- Use RMM software to upload configuration to RMA1215.
- The following settings are not stored in the configuration file and must be manually updated: ILS Date/time, Modem configuration, User configuration, Lamp mappings and Medium storage sample interval.
- If the version number of the RMS EPROM is lower than 13, it is necessary to upload configuration to monitor 1, 2 and standby monitor if present. Note that if this is done it is also necessary to perform a monitor limits test as described in chapter 6.

#### CHECK:

Monitor        Make sure the ILS is operating in normal state (transmitters on) and check that all parameters are normal.

Maintenance: Check the maintenance parameters for the RMA1215 unit.

### **7.3.8 LF1223 replacement**

#### PREPARATIONS:

Power down system. Remove old unit and place the new unit on an extender board.

#### ADJUSTMENT:

Turn on transmitters. It is important to use RMM software to upload LF1223-configuration to ILS. When the LF-configuration has been correctly uploaded, only minor adjustments should be necessary. (Follow the procedure in chapter to re-adjust both/all transmitters.)

#### CHECK:

Monitor:        Make sure the ILS is operating in normal state (transmitters on) and check that all parameters are normal.

Maintenance: Check the maintenance parameters for the replaced LF1223 board.

Transmitters: Check waveforms as described in Technical Manual, chapter 7 for all transmitters.

### **7.3.9 COA1207 replacement**

#### PREPARATIONS:

Remove old unit and mount new unit in the cabinet. Make a note of all attenuator and phaser settings on the old unit.

#### ADJUSTMENT:

Connect all cables and dummyloads to the same inputs and outputs of the new COA 1207. Set all phasers and attenuators in the same position as on the replaced unit.

#### CHECK:

Follow adjustment procedures described in Engineering and Commissioning Handbook to verify

that the CSB and SBO phase of of the cabinet is correct.

### 7.3.10 LPA1230/GPA1231/GPA1232 replacement

#### PREPARATIONS:

Power down system. Remove old unit and place the new unit in cabinet.

#### ADJUSTMENT:

Turn on transmitters. Follow the procedure in chapter 7 in the Technical Manual to re-adjust the transmitters.

#### CHECK:

Check waveforms as described in chapter 7 in the Technical Manual.

## 7.4 Detailed description of the automatic diagnostic algorithms

### 7.4.1 Overview

The following sections begins with a description of the diagnostic solutions that may be reported by the software, then continues with detailed descriptions of the Current data diagnostics and the Alarm event diagnostics function.

### 7.4.2 Possible diagnostic solutions

The following table lists and describes the diagnostic solutions that may be reported by the diagnostic functions in the RMM software.

Diagnostic solution	Description
MONITOR 1	Monitor 1 (MO1212) (LRU)
MONITOR 2	Monitor 2 (MO1212) (LRU)
STDBY MON	Standby monitor (MO1212) (LRU)
LF GENERATOR 1	LF generator 1 (LF1223) (LRU)
LF GENERATOR 2	LF generator 2 (LF1223) (LRU)
MONITOR FRONTEND 1	Monitor frontend 1 (MF1211/19) (LRU)
MONITOR FRONTEND 2	Monitor frontend 2 (MF1211/19) (LRU)
MONITOR FRONTEND STANDBY	Standby monitor frontend (MF1211/19) (LRU)
OSCILLATOR 1	Oscillator 1 (OS1221) (LRU)
OSCILLATOR 2	Oscillator 2 (OS1221) (LRU)
LPA/GPA TX1 COURSE	LPA/GPA TX1 COURSE (LRU)
LPA/GPA TX1 CLEARANCE	LPA/GPA TX1 CLEARANCE (LRU)
LPA/GPA TX2 COURSE	LPA/GPA TX2 COURSE (LRU)
LPA/GPA TX2 CLEARANCE	LPA/GPA TX2 CLEARANCE (LRU)
RMS BOARD	RMS board (RMA1215) (LRU)
POWER SUPPLY 1	Power supply 1 (PS1227) (LRU)
POWER SUPPLY 2	Power supply 2 (PS1227) (LRU)
EXTERNAL POWER	External power.

EXTERNAL FACTOR	An external factor influencing monitor measurements.
COMMON CABLING	Cabling or any part of the system that is common for the transmitters or monitor system, e.g. antenna element, cable, distribution- or monitoring networks.
TX CONTROL	TX control board (TCA1218) (LRU)
REMOTE CONTROL	Remote control unit (RCA1240) (LRU) or its communication link.
ANTENNA SYSTEM	Antenna system.
USER INPUT	User defined input on CI1210 is in warning state.
UNABLE TO ISOLATE	The diagnostic function was unable to determine a possible faulty module.

### 7.4.3 Current data diagnostics

The following sub-sections describes the tests performed by the RMM software for current data diagnostics. All diagnostic solutions detected are recorded and presented to the operator. If a diagnostic solution is found to be the result of more than one test, the solution that is the result of most tests will be listed first.

#### 7.4.3.1 I<sup>2</sup>C read error on any board implies a failure on that board

If a board is reported with “ERROR” status there is probably a fault on this board. “ERROR” indicates that the RMS does not detect valid I<sup>2</sup>C-bus acknowledge signals from the board when attempting to read its maintenance data. All boards, except the TX Control board, in the NM70XX cabinet have an I<sup>2</sup>C-interface to the RMS board.

Note: If all boards are indicated with “ERROR” status, the problem may be a faulty I<sup>2</sup>C interface on the RMS board, or any of the boards may have a “stuck-at” error on the I<sup>2</sup>C bus signals.

#### 7.4.3.2 Maintenance parameter warnings

##### 7.4.3.2.1 External power supply tests

###### DIAGNOSTIC ALGORITHM:

If there is a maintenance warning indication on the external power module, there is a problem with the 27V power supply, the battery chargers or the system is on battery operation.

##### 7.4.3.2.2 Power supply 1 and 2 tests

###### DIAGNOSTIC ALGORITHM:

1. If there is a maintenance warning indication on power supply 1 and not on power supply 2, or vice versa, there is a fault on the power supply which has the warning.
2. If there is a maintenance warning on both power supply boards AND not on the external power module both power supplies are faulty.

##### 7.4.3.2.3 Maintenance warnings without follow-errors

###### DIAGNOSTIC ALGORITHM:

A maintenance warning on a board listed in the following table indicates that there is a fault on that board.

<b>Board</b>
LF generator 1 or 2
Oscillator 1 or 2
RMS board
Monitor 1 or 2
TX Control board
User defined inputs

#### 7.4.3.2.4 Power amplifier tests

##### DIAGNOSTIC ALGORITHM:

Warnings on a PA implies PA failure if there is no warning or error on the corresponding OS or LF.

##### DESCRIPTION:

The algorithm assumes that a warning indication on any of the measurements on a PA means there is a failure on this PA, if the corresponding OS and LF have no maintenance warning indications. (A fault on the OS and LF may cause a warning on the PA.)

#### 7.4.3.2.5 Monitor 1 and 2 frontend tests

##### DIAGNOSTIC ALGORITHM:

Warning on monitor frontend 1 implies monitor frontend 1 failure if there is no warning on monitor frontend 2 and vice versa.

##### DESCRIPTION:

The maintenance measurements from the monitor frontend boards will be affected by the monitor input signals, i.e. the diagnostic algorithm can not use these measurements alone to reliably diagnose fault on the monitor frontend boards. The algorithm assumes that both frontends are fed the same input signals. If a maintenance warning then exists on one, but not both of the boards, this board is assumed to be faulty. If maintenance warnings exists on both boards no knowledge is gained about monitor frontend health status.

#### 7.4.3.2.6 Remote control tests

##### DIAGNOSTIC ALGORITHM:

If there is a "RC link status" warning, there is a problem with the remote control or its data link.

##### DESCRIPTION:

A warning on the RC link status indicates that the TXC does not receive valid data from the remote control unit.

#### 7.4.3.2.7 Transmitter control tests

##### DIAGNOSTIC ALGORITHM:

TX control "EPROM check" or "Integrity check" warnings indicate a failure on the TXC board.

#### 7.4.3.2.8 Standby monitor tests

**DIAGNOSTIC ALGORITHM:**

If there is a warning on the standby monitor board this board is faulty.

## 7.4.3.2.9 Standby monitor frontend tests

**DIAGNOSTIC ALGORITHM:**

If there is a warning on the standby monitor frontend board AND there is no warning or alarm indication on the standby monitor measurements then the standby monitor frontend board is faulty.

## 7.4.3.2.10 User defined parameters

**DIAGNOSTIC ALGORITHM:**

If there is a warning on any of the user defined inputs then "User defined input" is faulty.

*7.4.3.3 Monitor self-test error***DIAGNOSTIC ALGORITHM:**

Monitor self-test failure indicates an error on the monitor board that reports this failure.

*7.4.3.4 Monitor DC-loop alarm***DIAGNOSTIC ALGORITHM:**

If both monitor 1 AND monitor 2 reports DC-loop alarms or warnings the antenna has a broken element.

*7.4.3.5 Monitor warning tests***DIAGNOSTIC ALGORITHM:**

Figure 7-1 illustrates the tests done by the RMM software for automatically diagnosing faults that result in monitor 1 and 2 warning indications.



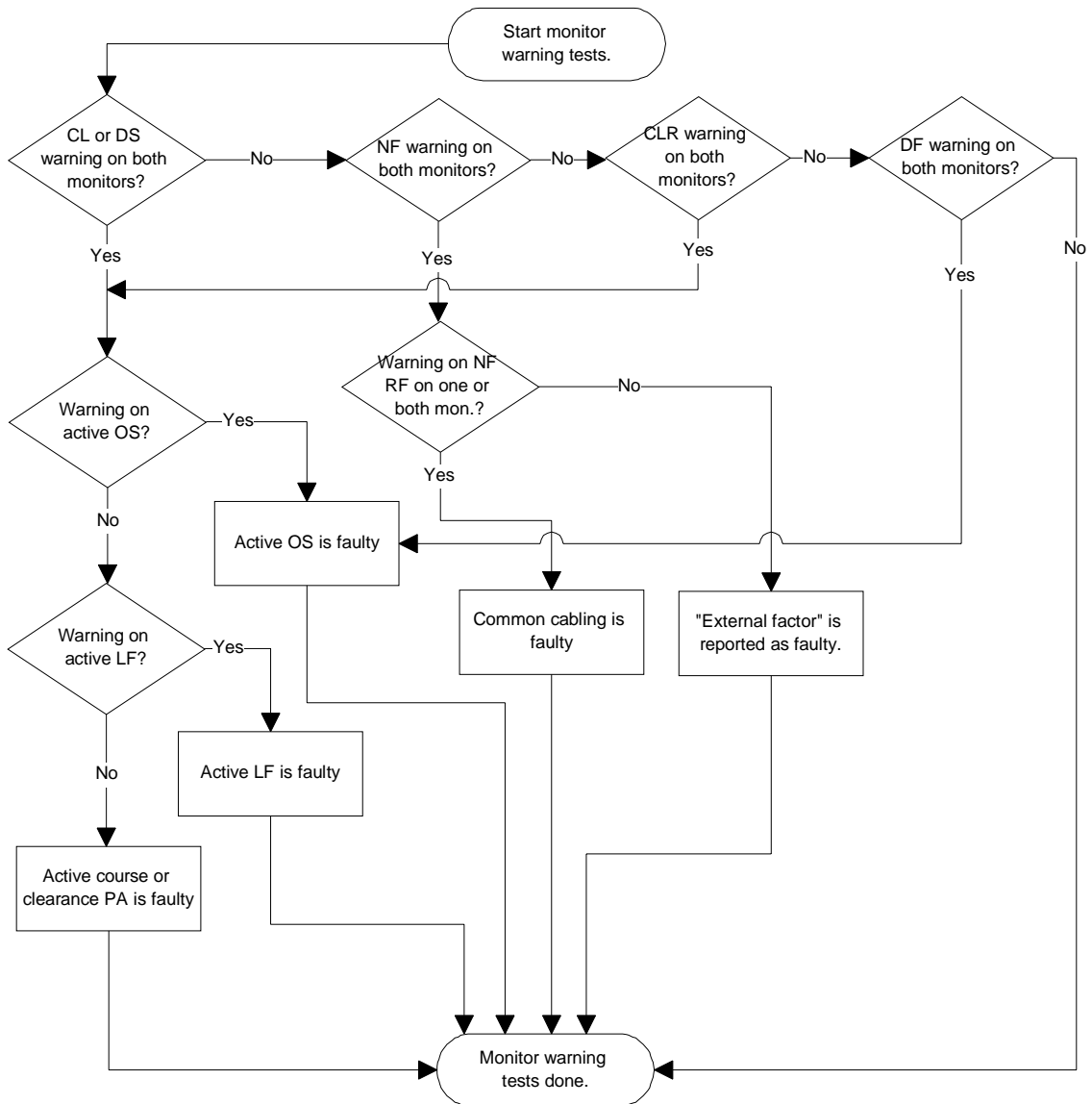

Figure 7-1 Flow diagram for Monitor warning tests.

7.4.3.6 Monitor disagree

**DIAGNOSTIC ALGORITHM:**

If one monitor indicates delayed warning, raw alarm or alarm on any parameter and the other monitor does not, then the monitor which indicates the delayed warning, raw alarm or alarm is probably faulty.

**7.4.4 Alarm event diagnostics**

7.4.4.1 Changeover without shutdown

The flow diagram in Figure 7-2 describes the algorithm used to diagnosing a changeover alarm that is not followed by a shutdown alarm. The RMM software uses the maximum configured monitor alarm delay to determine whether a changeover alarm is followed by a shutdown. If no shutdown alarm event occurred within the maximum configured alarm delay after the changeover alarm event this algorithm will be used.

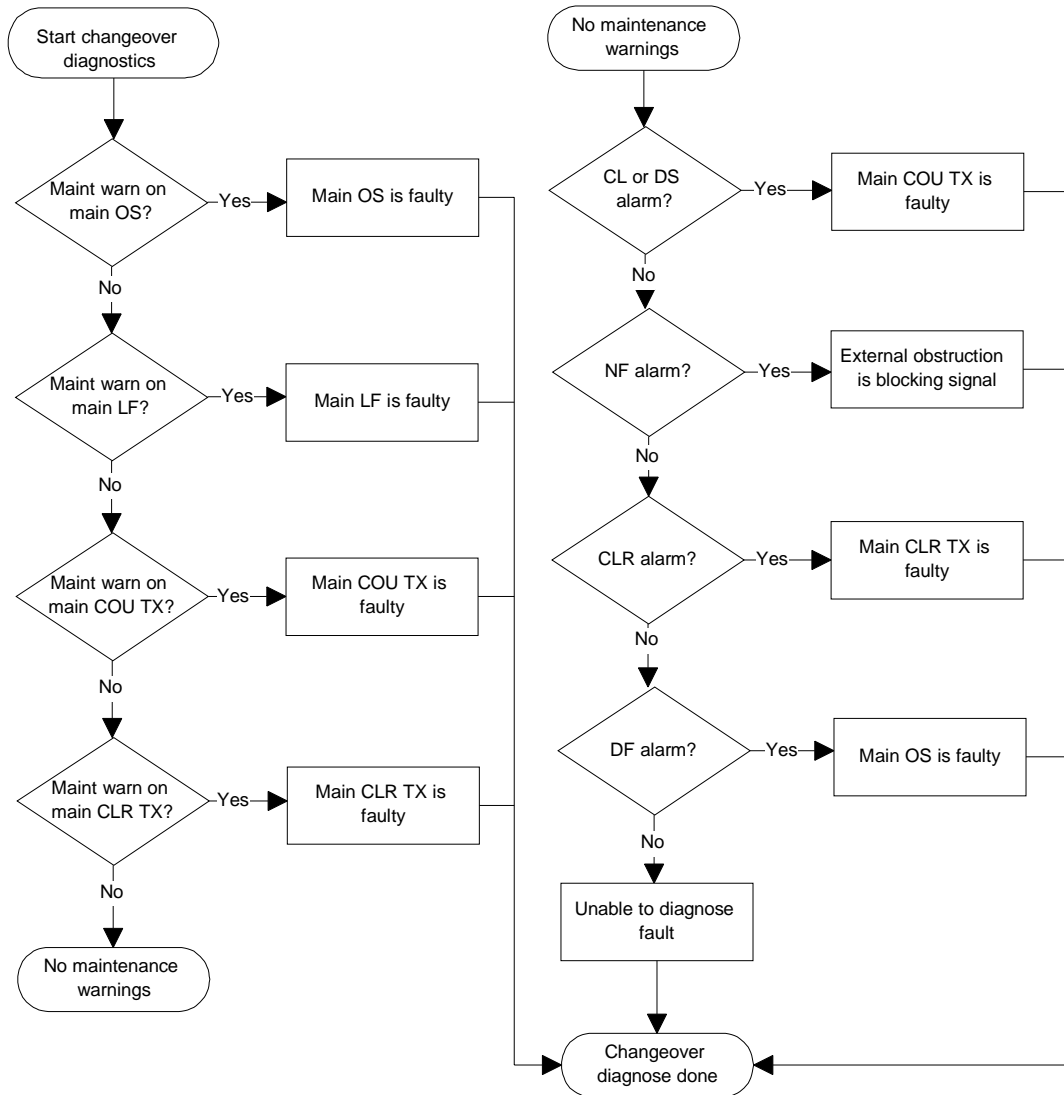

Figure 7-2 Flow diagram for diagnosing a changeover-only alarm.

7.4.4.2 Changeover with subsequent shutdown

A changeover alarm event that is followed by a shutdown alarm event within the maximum configured monitor delay will be diagnosed as described in this section. The algorithm used depends on the voting configuration.

7.4.4.3 Algorithm for systems with 2/2 voting

Figure 7-3 shows the flow diagram for diagnosing changeover/shutdown situations on systems with 2/2 voting.

**DESCRIPTION:**

The algorithm is based on the fact that a fault (in a 2/2 voting system) which causes a complete shutdown, must be some point that is common for the transmitter section and the moni-

toring section.

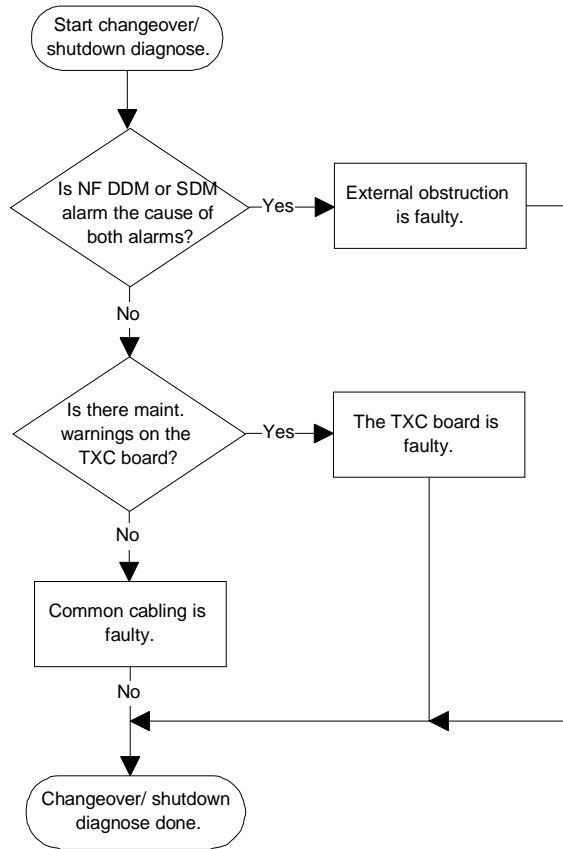

Figure 7-3 Flow diagram for diagnosing changeover/shutdown alarms.



**PART IV APPENDIX**

**A Monitor and Maintenance Parameters**

**A.1 Monitor Alarm Parameters**

These are ILS parameters measured by the monitors. An alarm on any of these parameters will cause change-over/shut-down.

Channel	Parameter	Description
CL	DDM	Course Line - Difference in depth of modulation
	SDM	Course Line - Sum of depth of modulation
	RF	Course Line - RF level
DS	DDM	Displacement Sensitivity - Difference in depth of modulation
	SDM	Displacement Sensitivity - Sum of depth of modulation
	RF	Displacement Sensitivity - RF level
NF	DDM	Near Field - Difference in depth of modulation
	SDM	Near Field - Sum of depth of modulation
	RF	Near Field - RF level
CLR	DDM	Clearance - Difference in depth of modulation
	SDM	Clearance - Sum of depth of modulation
	RF	Clearance - RF level
-	DF	Difference Frequency
-	CL IDENT	IDENT signal from CL monitor (LLZ only)
-	CLR IDENT	IDENT signal from CLR monitor (LLZ only)
-	Self test	Logical OR of monitor self test signals
-	DC LOOP	Logical OR of DC-LOOP signals (LLZ only)

*Table A-1 Monitor Alarm Parameters - Monitor Window 1.*

Channel	Parameter	Description
-	TEST: DDM	Monitor self test signal
-	TEST: SDM	Monitor self test signal
-	TEST: RF	Monitor self test signal
-	CL ID MOD	IDENT signal modulation on CL monitor (LLZ only)
-	CLR ID MOD	IDENT signal modulation on CLR monitor (LLZ only)
-	DC LOOP 0	DC-LOOP for antenna element group 0 (LLZ only)
-	DC LOOP 1	DC-LOOP for antenna element group 1 (LLZ only)
-	DC LOOP 2	DC-LOOP for antenna element group 2 (LLZ only)
-	DC LOOP 3	DC-LOOP for antenna element group 3 (LLZ only)

*Table A-2 Monitor Alarm Parameters - Monitor Window 2.*

## A.2 Maintenance Parameters

These parameters may cause maintenance warning and can be used for fault isolation purposes.

Originates from module	Parameter	Gives WARNING when (with default warning limits setting):
MO1212	+5V OK	+5V Supply Voltage below predefined limit.
	STS ACT	ADC conversion error
	DSP PFO	DSP power failure
	DSP ERROR	DSP watchdog warning.
	DIAG RST	Not used
	SYNC ERROR	COMPARATOR out of sync
	+15V OK	+15V Supply Voltage below predefined limit.
	-15V OK	-15V Supply Voltage below predefined limit.
MF1211/ MF1219	CL RF LEVEL	RF level from CL monitor channel below predefined limit.
	CL BASEBAND	Baseband level from CL monitor channel below predefined limit.
	DS RF LEVEL	RF level from DS monitor channel below predefined limit.
	DS BASEBAND	Baseband level from DS monitor channel below predefined limit.
	NF RF LEVEL	RF level from NF monitor channel below predefined limit.
	NF BASEBAND	Baseband level from NF monitor channel below predefined limit.
	CLR RF LEVEL	RF level from CLR monitor channel below predefined limit.
	CLR BASEBAND	Baseband level from CLR monitor channel below predefined limit.
LF1223	COURSE LEVEL 90	Output level of 90Hz tone to COURSE transmitter below predefined limit.
	COURSE LEVEL 150	Output level of 150Hz tone to COURSE transmitter below predefined limit.
	COURSE LEVEL DC	Output level of DC signal to COURSE transmitter below predefined limit.
	CLR LEVEL 90	Output level of 90Hz tone to CLR transmitter below predefined limit.
	CLR LEVEL 150	Output level of 150Hz tone to CLR transmitter below predefined limit.
	CLR LEVEL DC	Output level of DC signal to CLR transmitter below predefined limit.
	+15V OK	+15V Supply Voltage below predefined limit.
	-15V OK	-15V Supply Voltage below predefined limit.
OS1221	COURSE OUTPUT LEVEL	RF level output to COURSE transmitter is below a predefined level
	COU TUNEVOLT	COURSE tune voltage outside predefined limits.
	COURSE SYNTH LOCK WARN	Synthesiser has been out of lock since COURSE transmitter was turned on.

COURSE LOCK DETECT	COURSE synthesiser is out of lock
CLR OUTPUT LEVEL	RF level output to CLR transmitter is below a predefined level
CLR TUNEVOLT	CLR tunevoltage outside predefined limits.
CLR SYNTH LOCK WARN	Synthesiser has been out of lock since CLR trasmitter was turned on.
CLR LOCK DETECT	CLR synthesiser is out of lock

Table A-3 Logical Maintenance Parameters.

Originates from module	Parameter	Description
TX LPA/GPA	PA 27V LEVEL	Measured value of 27V Voltage to LPA/GPA
	CSB LEVEL	Measured value of output level of CSB signal
	SBO LEVEL	Measured value of output level of SBO signal
	PH CORR PEAK LEVEL	Measured peak level of phase correction signal

Table A-4 Analog Maintenance Parameters.

Originates from module	Parameter	Description
RMA1215	RMS +5V	Measured value of +5V voltage
	RMS BATTERY	Measured value of RMS battery voltage
PS1227	PS1 -15V	Measured value of -15V supply voltage from PS1227A #1
	PS2 -15V	Measured value of -15V supply voltage from PS1227A #2
	PS1 +5V	Measured value of +5V supply voltage from PS1227A #1
	PS2 +5V	Measured value of +5V supply voltage from PS1227A #2
	PS1 +8.5V	Measured value of +8.5V supply voltage from PS1227A #1
	PS2 +8.5V	Measured value of -8.5V supply voltage from PS1227A #2
	PS1 +15V	Measured value of +15V supply voltage from PS1227A #1
	PS2 +15V	Measured value of +15V supply voltage from PS1227A #2
	TX1 CLR I150	Measured value of current through TX1 CLR 150Hz amplifier
	TX1 CLR I90	Measured value of current through TX1 CLR 90Hz amplifier

	TX1 COURSE I150	Measured value of current through TX1 COURSE 150Hz amplifier
	TX1 COURSE I90	Measured value of current through TX1 COURSE 90Hz amplifier
	TX2 CLR I150	Measured value of current through TX2 CLR 150Hz amplifier
	TX2 CLR I90	Measured value of current through TX2 CLR 90Hz amplifier
	TX2 COURSE I150	Measured value of current through TX2 COURSE 150Hz amplifier
	TX2 COURSE I90	Measured value of current through TX2 COURSE 90Hz amplifier
CI1210	CHARGER STATUS	Charger Voltage OK / not OK
	BATT CURRENT	Measured value of battery current (negative if charging)
	POWER CURRENT	Measured value of total system current consumption

*Table A-5 DC Supplies Maintenance Parameters.*

Originates from module	Parameter	Description
CI1210	Temp in	Inside temperature (if installed)
	Temp out	Outside temperature (if installed)
	AC voltage	Mains voltage (if installed)
	User defined	3 user defined analog inputs

*Table A-6 User Defined Analog Inputs Maintenance Parameters.*

Originates from module	Parameter	Description
CI1210	User defined	8 user defined logical inputs/outputs

*Table A-7 User Defined Logical Inputs/Outputs Maintenance Parameters.*



## B Factory default configuration settings

### B.1 Cat I monitor LIMIT configuration

Factory default alarm, warning-limits and nominal values are shown in Table 1.

DDM values are in % DDM (which is the default DDM measurement unit in the RMM software).

Limit values are relative to the configured nominal value. The nominal values for DDM measurements can be configured by the user. Other nominal values can not be modified by the user.

Monitor 1 and monitor 2 are always configured equally and according to Table 1. The standby monitor are also configured according to this table, but with a few exceptions, see the notes following the table.

Note that for the CL, DS, NF, CLR, and FFM channels the alarm limits are fine-tuned during commissioning and flight tests to match each site installation.

For information on using the RMM software to set the monitor limits, see chapter 5.8 in the Operating Manual.

Channel	Signal	LLZ			GP		
		Nom	Alarm L/H	Warn L/H	Nom	Alarm L/H	Warn L/H
CL	DDM	0.0 %	-1.5/1.5	75 %	0.0 %	-3.73/3.73	75 %
CL	SDM	40 %	-4/4	75 %	80 %	-5/5	75 %
CL	RF	3.0 V	1f: -1/1.5 2f: -0.35/0.47	75 %	3.0 V	1f: -1/1.5 2f: -0.36/0.43	75 %
NF	DDM	0.0 %	-1.5/1.5	75 %	0.0 %	-5.25/5.25	75 %
NF	SDM	40 %	-20/20	75 %	80 %	-20/20	75 %
NF	RF	3.0 V	-1.5/1.5	75 %	3.0 V	-1.7/1.7	75 %
DS	DDM	15.5 %	-2.5/2.5	75 %	17.5 %	-4.3/4.3	75 %
DS	SDM	40 %	-20/20	75 %	80 %	-20/20	75 %
DS	RF	3.0 V	-1.5/1.5	75 %	3.0 V	-1.7/1.7	75 %
CLR	DDM	0.0 %	1f: Off/Off 2f: -4.0/4.0	1f: 100 % 2f: 75 %	0.0 %	1f: Off/Off 2f: -5.25/5.25	1f: 100 % 2f: 75 %
CLR	SDM	40 %	1f: Off/Off 2f: -4.0/4.0	1f: 100 % 2f: 75 %	80 %	1f: Off/Off 2f: -5/5	1f: 100 % 2f: 75 %
CLR	RF	3.0 V	1f: Off/Off 2f: -0.37/0.44	1f: 100 % 2f: 75 %	3.0 V	1f: Off/Off 2f: -0.36/0.43	1f: 100 % 2f: 75 %
DF		10 kHz	1f: Off/Off 2f: -4/4	1f: 100 % 2f: 75 %	15 kHz	1f: Off/Off 2f: -4.5/4.5	1f: 100 % 2f: 75 %
CLR	IDENT	0.0 %	Off/Off	1f: -69/69 2f: 2.5/20	0.0 %	Off/Off	-69/69
CLR	MORSE	0.0 %	Off/Off	100 %	0.0 %	Off/Off	100 %
CL	IDENT	0.0 %	Off/Off	2.5/20	0.0 %	Off/Off	-69/69
CL	MORSE	0.0 %	Off/Off	100 %	0.0 %	Off/Off	100 %
DC-L0		0	2/42	100 %	0	Off/Off	100 %

DC-L1		0	2/42	100 %	0	Off/Off	100 %
DC-L2		0	2/42	100 %	0	Off/Off	100 %
DC-L3		0	2/42	100 %	0	Off/Off	100 %
Self test	DDM	0.0 %	-1.4/4.0	100 %	0.0 %	-2.5/Off	100 %
Self test	SDM	40 %	-8/Off	100 %	40 %	25/Off	100 %
Self test	RF	3.0 V	-1.2/1.8	100 %	3.0 V	-1/Off	100 %
FFM	ChA DDM	0.0 %	-1.5/1.5	75 %	0.0 %	-3.7/3.7	75 %
FFM	ChA SDM	40 %	-4/4	75 %	80 %	-5/5	75 %
FFM	ChA RF	0.0 V	20/80	30/70	0.0 V	20/80	30/70
FFM	ChB DDM	0.0 %	-1.5/1.5	75 %	0.0 %	Off/Off	100 %
FFM	ChB SDM	40 %	-4/4	75 %	80 %	Off/Off	100 %
FFM	ChB RF	0.0 V	20/80	30/70	0.0 V	Off/Off	-100/100
FFM	EXE AL	0	0/200	-2047/2047	0	0/200	-2047/ 2047
CL	VOICE DETECT	0.0	Off/Off	150/204	0.0	Off/Off	-150/204

Table B-1 CAT I alarm and warning limits.

#### Notes:

1. Unused DC loop channels: Set monitor alarm limits OFF and warning limits to 100%.
2. Unused Far Field Monitor (FFM) channels: Set monitor alarm limits to OFF and warning limits to 100% (RF warning to  $\pm 100$ ).
3. Unused VOICE channels: Set alarm limits to OFF and warning limits to  $\pm 204$ .
4. Standby monitor: Always disable alarms and warnings on the following channels: Near Field, DC-loop, Far Field Monitor, and Voice.

#### B.1.1 Description of the FFM EXE AL limits

The FFM EXE AL (Far Field Monitor Executive Alarm) parameter is used to implement executive changeover/shutdown on FFM alarms. This measurement is zero when no alarms exists on the FFM DDM/SDM/RF parameters. When an alarm has lasted for the time configured in the FFM delay value, this measurement will be set to the value 101.

By setting the FFM EXE AL high alarm limit to 100, the TX Control will initiate an (executive) changeover or shutdown on FFM parameter alarms. (Actually, any high alarm limit between 1 and 100 would work, but 100 is recommended as the default if executive FFM alarms is desired.)

For non-executive FFM alarms, set the FFM EXE AL high alarm limit to a value higher than 101 (200 is recommended as the default).

#### B.1.2 Description of the CL IDENT and CLR IDENT limits

The CL IDENT and CLR IDENT parameters are the absolute value of the difference between two consecutive 1020 Hz modulation measurements taken on the Course Line and Clearance channels. This means that these parameters will have the value 0 when, for example, the ident-keyer stops sending Morse code or if the 1020 Hz tone is continuously on (at approximately the same level). A positive non-zero value is therefore an indication of ident. modulation activity.

The recommended low warning limit is 2.5. The ident. modulation levels then needs to be

large enough to periodically produce a CL or CLR IDENT measurement that is greater than this low limit to reset the IDENT delay counter. All measurements that is greater than this minimum value should be accepted, the upper warning limit is therefore set to a large value (20 is the recommended value).

If executive changeover/shutdown is desired on alarms on the CL or CLR IDENT parameters, the warning limits recommended above should be used, instead of OFF, on the alarm limits.

**B.2 Cat II monitor LIMIT configuration**

For Cat II equipment the monitor limits are configured as for Cat I (see table 1), with the exceptions shown in Table B-2. (Only the LLZ limits are different.)

Channel	Signal	LLZ			GP		
		Nom	Ala H/L	Wa H/L	Nom	Ala	Warn
CL	DDM	0.0 %	-1.1/1.1	75 %	0.0 %	-3.73/3.73	75 %
NF	DDM	0.0 %	-1.1/1.1	75 %	0.0 %	-5.25/5.25	75 %

Table B-2 Alarm and warning limits for Cat II equipment.

**B.3 Cat III monitor LIMIT configuration**

For Cat III equipment the monitor limits are configured as for Cat I (see table 1), with the exceptions shown in Table B-3. (Only the LLZ limits are different.)

Channel	Signal	LLZ			GP		
		Nom	Ala H/L	Wa H/L	Nom	Ala	Warn
CL	DDM	0.0 %	-0.9/0.9	75 %	0.0 %	-3.73/3.73	75 %
NF	DDM	0.0 %	-0.9/0.9	75 %	0.0 %	-5.25/5.25	75 %

Table B-3 Alarm and warning limits for Cat III equipment.

**B.4 Executive Monitor delay configuration**

The factory default delay configuration for Cat I and II/III (values compliant with ICAO Annex 10) are shown in Factory default delay values..

Note that Annex 10 specifies the total changeover + shutdown delay after an alarm. The delay values used in the NORMARC 7000 RMM software are the time delay between the detection of an alarm and the resulting changeover or shutdown. When a changeover takes place the delay counters are reset. The values entered in the RMM software are therefore set to the Annex 10 value divided by two.

The NF delay is used for alarms on the NF DDM, SDM and RF parameters. The IDENT delay is used on the CL/CLR IDENT, MORSE and VOICE parameters. The FFM delay is used on all FFM parameters including FFM EXE AL. The GEN delay is used on all remaining parameters.

See chapter 5.8.3 in the Operating Manual for information on delay configuration using the RMM software.

Channel	LLZ		GP	
	Cat I	Cat II/III	Cat I	Cat II/III
GEN	5 s	1 s	3 s	1 s
NF	20 s	20 s	20 s	20 s
IDENT	20 s	20 s	N/A	N/A
FFM	60 s	60 s	60 s	60 s

Table B-4 Factory default delay values.

### B.5 Maintenance parameter configuration

The following sub-sections describe the maintenance measurements collected by the RMS for diagnostic purposes. Default warning limits are also defined for each measurement type.

The warning limit for digital measurement points are set to the “normal” state of the measurement point. For example, for a measurement point that is normally “HIGH”, the warning limit is set to “HIGH”.

For analog measurement points the limits are specified as “low limit”/“high limit”.

See chapter 5.8.4 in the Operating Manual for information on using the RMM software to set these limits.

### B.6 Oscillator 1 and 2 (OS 1221)

Measurement	Warn. limit.	Description
COU OUTPUT LEVEL	HIGH	Detects low output level from the board. May cause low radiated power.
COU TUNEVOLT	HIGH	Voltage Controlled Oscillator parameter drift.
COU SYNTH LOCK	HIGH	The phase locked loop has been out of lock. (May be reset by turning the TX off/on.)
COU LOCK DETECT	HIGH	Output frequency is unstable.
CLR OUTPUT LEVEL	HIGH	Detects low output level from the board. May cause low radiated power.
CLR TUNEVOLT OK	HIGH	Voltage controlled oscillator parameter drift.
CLR SYNTH LOCK	HIGH	The phase locked loop has been out of lock. (May be reset by turning the TX off/on.)
CLR LOCK DETECT	HIGH	Output frequency is stable/not stable.

**B.6.1 LF generator 1 and 2 (LF 1223)**

Measurement	Warn. limit.	Description
COU LEVEL 90	HIGH	Course line 90 Hz output level ok/not ok.
COU LEVEL 150	HIGH	Course line 150 Hz output level ok/not ok.
COU LEVEL DC	HIGH	Course line DC output level ok/not ok.
CLR LEVEL 90	HIGH	Clearance 90 Hz output level ok/not ok.
CLR LEVEL 150	HIGH	Clearance 150 Hz output level ok/not ok.
CLR LEVEL DC	HIGH	Clearance DC output level ok/not ok.
V15P OK	HIGH	+15 V supply voltage ok/not ok.
V15N OK	LOW	-15 V supply voltage ok/not ok.

**B.6.2 TX 1 and 2, Course and Clearance**

Measurement	Warn. limit.	Description
PA V27P LEVEL	24/27 (V)	+27 V voltage measurement (Volt).
CSB POWER LEVEL	12/17 (W)	CSB output power measurement (Watt).
SBO POWER LEVEL	0.2/0.8 (W)	SBO power measurement (Watt).
PH CORR PEAK LEVEL	1/13	Phase correlation peak level measurement. May indicate that the transmitter is working outside its dynamic range.
PS1/2 COU/CLR I90/I150	-0.5/1.5 (A)	Current consumption in 90/150 Hz amplifiers (Ampere). The TX1 currents is measured on PS1, the TX2 currents on PS2. These measurements are listed in the DC Supplies maintenance parameter window in the RMM software, but are associated with the LPA/GPA modules in the automatic diagnostic functions.

**B.6.3 RF frontends for monitor 1, 2 and standby monitor (MF 1211/1219)**

Measurement	Warn. limit	Description
CL RF LEVEL	HIGH	Detects low Course Line RF level.
CL BASEBAND	HIGH	Detects low Course Line baseband level.
DS RF LEVEL	HIGH	Detects low Course Line RF level.
DS BASEBAND	HIGH	Detects low Course Line baseband level.
NF RF LEVEL	HIGH	Detects low Near Field RF level.
NF BASEBAND	HIGH	Detects low Near Field baseband level.
CLR RF LEVEL	HIGH	Detects low Clearance RF level.
CLR BASEBAND	HIGH	Detects low Clearance baseband level.

**B.6.4 Monitor 1, 2 and standby (MO 1212)**

Measurement	Warn. limit	Description
V5P OK	HIGH	+5 V supply voltage ok/not ok.
STS ACT	HIGH	A/D conversion completed ok/not ok.
DSP PFO	HIGH	DSP +5 V ok/not ok.
DSP ERROR	LOW	DSP filter conversion completed ok/not ok.
DIAG RST	HIGH	For resetting diag. result (not used)
SYNC ERROR	LOW	DSP operation ok/not ok.
V15P OK	HIGH	+15 V supply voltage ok/not ok.
V15N OK	LOW	-15 V supply voltage ok/not ok.

**B.6.5 Transmitter control board (TCA 1216)**

Measurement	Warn. limit	Description
EPROM PARITY CHECK	LOW	EPROM parity check ok/not ok.
INTEGRITY CHECK	LOW	Integrity check ok/not ok.
RC LINK STATUS	HIGH	Remote control link status ok/not ok. A warning is generated if the TXC board does not receive a valid data stream from the RC unit.
INTERNAL CL DDM	-1/1 (% DDM)	Measurements on the Course CSB signal output from the cabinet. Only measured on hot standby systems. These signals are not associated with the TCA 1216 board in the automatic diagnostic functions.
INTERNAL CL SDM	36/44 (%)	See description for INTERNAL CL DDM.
INTERNAL CL RF	2.6/3.4 (V)	See description for INTERNAL CL DDM.

**B.6.6 Remote monitoring board (RMA 1215)**

Measurement	Warn. limit	Description
RMS V5P LEVEL	4.3/6 (V)	+5V voltage measurement (Volt).
RMS LI BATT LEVEL	2.7/3.5 (V)	Clock and RAM battery voltage measurement (Volt).
EPROM CHECK	HIGH	Program memory CRC check ok/not ok. Runs continuously, and completes every 30 minutes (approx.).
RAM CHECK	HIGH	RAM read/write test. Runs continuously, and completes a check of all RAM every 15 minutes (approx.).

### B.6.7 Power supply 1 and 2 (PS 1227)

The measurements listed here are displayed in the DC SUPPLIES maintenance window in the RMM software.

Measurement	Warn. limit	Description
V15N LEVEL	-16.8/-13.8 (V)	Measurement of -15 V output voltage (Volt).
V5P LEVEL	4.6/5.9 (V)	Measurement of +5 V output voltage (Volt).
V8P5P LEVEL	8.2/9.4 (V)	Measurement of +8.5 V output voltage (Volt).
V15P LEVEL	13.8/16.8 (V)	Measurement of +15 V output voltage (Volt).

### B.6.8 External power

The measurements listed here are displayed in the DC SUPPLIES maintenance window in the RMM software.

Measurement	Warn. limit	Description
BATTERY V27P LEVEL	23/28 (V)	Measurement of 27 V battery supply voltage.
BATTERY CURRENT	-1/10 (A)	
POWER CURRENT	-1/20 (A)	
CHARGER 1 STATUS	ON	Battery charger 1 status input.
CHARGER 2 STATUS	ON	Battery charger 2 status input.

### B.6.9 User defined inputs

No default settings are defined for these parameters.

Measurement	Description
USER_DIG0 - 7	8 user definable digital inputs/output.
TEMP_OUTDOOR	Analog input for outdoor temperature sensor.
TEMP_INDOOR	Analog input for indoor temperature sensor.
AC_LEVEL	Analog input AC power level measurement.
ANA_CH1 - 3	3 user definable analog inputs.

### B.7 Maintenance delay configuration

The factory default maintenance delays are as follows:

GEN delay: 20 seconds  
EXT delay: 50 seconds

### B.8 Morse code configuration

The factory default Morse code are "TST".

### B.9 Typical TX Adjustments values

Typical TX adjustment values lists typical values entered in the RMM software (menu item ILS | TX settings | TX adjustments) entered in the RMM software for LLZ and GP equipment.

Note that the adjustment values incorporate both a modulation level setting and a small, unpredictable, correction for individual variation on the low frequency generator boards (LF1223). The correction is shown after the “±” sign in Typical TX adjustment values.

Parameter	Values for LLZ (15 W)	Values for GP (5 W/0.5 W)
Course RF Power	152 ± 8	115 ± 5
Course Mod Bal.	3078 ± 25	3100 ± 50
Course Mod Sum	3090 ± 25	2760 ± 50
Course Mod Id.	127 ± 10 (8 % ident. mod.) 150 ± 10 (10 % ident. mod.)	N/A
Clearance RF Power	152 ± 8	52 ± 5
Clearance Mod Bal.	3078 ± 25	1515 ± 20
Clearance Mod Sum	3090 ± 25	2760 ± 40
Clearance Mod Id.	127 ± 10 (8 % ident. mod.) 150 ± 10 (10 % ident. mod.)	N/A

Table B-5 Typical TX adjustment values

### B.10 User administration configuration

The following user are set up on new equipment:

Username:	MASTER
Password number 1:	MASTER1
Password number 2:	MASTER2
Password number 3:	MASTER3

These passwords should be changed after the commissioning.

### B.11 Frequency configuration strap settings

This section defines the strap settings on the OS1221A (LLZ) and OS1221B (GP) for the standard ICAO Annex 10 ILS frequencies.

The strap settings for each frequency and equipment type are shown in Table B-6 and Table B-7. The straps are numbered from A0 to A5 and N0 to N9. A0 is the bottom strap in two groups of straps. (when the board is held as inserted in the cabinet).

An “X” character in the table means the strap must be inserted. A blank means the strap must be removed.



**B.11.1 OS1221B strap settings for 2-frequency GP**

The course transmitter frequency is set with straps in the J2 strap block. The configured course frequency is the channel frequency + 7.5 kHz.

**Ch. freq. (MHz) A0 A1 A2 A3 A4 A5 N0 N1 N2 N3 N4 N5 N6 N7 N8 N9**

329.15	X	X	X	X				X			X		X		X	
329.3	X	X		X	X	X	X				X		X		X	
329.45	X	X	X			X	X				X		X		X	
329.6	X	X			X		X				X		X		X	
329.75	X	X	X	X	X	X					X		X		X	
329.9	X	X		X		X					X		X		X	
330.05	X	X	X		X						X		X		X	
330.2	X	X											X		X	
330.35	X	X	X	X		X	X	X	X	X			X		X	
330.5	X	X		X	X		X	X	X	X			X		X	
330.65	X	X	X				X	X	X	X			X		X	
330.8	X	X			X	X		X	X	X			X		X	
330.95	X	X	X	X	X			X	X	X			X		X	
331.1	X	X		X				X	X	X			X		X	
331.25	X	X	X		X	X	X		X	X			X		X	
331.4	X	X				X	X		X	X			X		X	
331.55	X	X	X	X			X		X	X			X		X	
331.7	X	X		X	X	X			X	X			X		X	
331.85	X	X	X			X			X	X			X		X	
332	X	X			X				X	X			X		X	
332.15	X	X	X	X	X	X	X	X		X			X		X	
332.3	X	X		X		X	X	X		X			X		X	
332.45	X	X	X		X		X	X		X			X		X	
332.6	X	X					X	X		X			X		X	
332.75	X	X	X	X		X		X		X			X		X	
332.9	X	X		X	X			X		X			X		X	
333.05	X	X	X					X		X			X		X	
333.2	X	X			X	X	X			X			X		X	
333.35	X	X	X	X	X		X			X			X		X	
333.5	X	X		X			X			X			X		X	
333.65	X	X	X		X	X				X			X		X	
333.8	X	X				X				X			X		X	
333.95	X	X	X	X						X			X		X	
334.1	X	X		X	X	X	X	X	X				X		X	
334.25	X	X	X			X	X	X	X				X		X	
334.4	X	X			X		X	X	X				X		X	
334.55	X	X	X	X	X	X		X	X				X		X	
334.7	X	X		X		X		X	X				X		X	
334.85	X	X	X		X			X	X				X		X	
335	X	X						X	X				X		X	

*Table B-6 OS1221B Course frequency settings for 2-freq. GP*

The clearance transmitter frequency is set with straps in the J102 strap block. The configured clearance frequency is the channel frequency - 7.5 kHz.

**Ch. freq. A0 A1 A2 A3 A4 A5 N0 N1 N2 N3 N4 N5 N6 N7 N8 N9  
(MHz)**

329.15	X				X			X			X		X		X	
329.3	X		X	X	X	X	X				X		X		X	
329.45	X			X		X	X				X		X		X	
329.6	X		X		X		X				X		X		X	
329.75	X						X				X		X		X	
329.9	X		X	X		X					X		X		X	
330.05	X			X	X						X		X		X	
330.2	X		X										X		X	
330.35	X				X	X	X	X	X				X		X	
330.5	X		X	X	X		X	X	X	X			X		X	
330.65	X			X			X	X	X	X			X		X	
330.8	X		X		X	X		X	X	X			X		X	
330.95	X					X		X	X	X			X		X	
331.1	X		X	X				X	X	X			X		X	
331.25	X			X	X	X	X		X	X			X		X	
331.4	X		X			X	X		X	X			X		X	
331.55	X				X		X		X	X			X		X	
331.7	X		X	X	X	X			X	X			X		X	
331.85	X			X		X			X	X			X		X	
332	X		X		X				X	X			X		X	
332.15	X									X			X		X	
332.3	X		X	X		X	X	X		X			X		X	
332.45	X			X	X		X	X		X			X		X	
332.6	X		X				X	X		X			X		X	
332.75	X				X	X		X		X			X		X	
332.9	X		X	X	X			X		X			X		X	
333.05	X			X				X		X			X		X	
333.2	X		X		X	X	X			X			X		X	
333.35	X					X	X			X			X		X	
333.5	X		X	X			X			X			X		X	
333.65	X			X	X	X				X			X		X	
333.8	X		X			X				X			X		X	
333.95	X				X					X			X		X	
334.1	X		X	X	X	X	X	X	X				X		X	
334.25	X			X		X	X	X	X				X		X	
334.4	X		X		X		X	X	X				X		X	
334.55	X						X	X	X				X		X	
334.7	X		X	X		X		X	X				X		X	
334.85	X			X	X			X	X				X		X	
335	X		X					X	X				X		X	

Table B-7 OS1221B Clearance frequency settings for 2-freq. GP

---

## **C Maintenance Procedures**

The following maintenance instructions are derived from FAA manual 6750.49 chapter 5. The reference paragraph numbers are identical to FAA numbers. FAA manual 6750.49 chapter 4 should be used as guide to select the Monthly, Quarterly, Semiannually etc. instructions in this chapter. If FAA chapter 4 refers to an item not found in this chapter, the item in FAA manual chapter 5 should be used.

### **5.40 LINE ENTRY OF NORMAL READINGS.**

#### **a. Object.**

This procedure provides a method to complete a line entry of the normal parameters on FAA Form 6750-26, with the equipment in normal configuration.

#### **b. Discussion.**

A line entry of the glide slope normal parameters is required after equipment transfer, before a normal end-fire glide slope ground check, and periodically as required in chapter 4. This check is made without adjustment to the equipment and can be performed from a remote maintenance monitor (RMM). Computer generated data reports may be used in lieu of FAA forms.

#### **c. Test Equipment Required.**

1. A portable ILS receiver (PIR).
2. A dvm.
3. BIRD wattmeter.

#### **NOTE:**

Chapter 1, Paragraph 1-2b, Test Equipment, discusses external test equipment and BITE, and their proper use in the NAS. Particular attention must be paid to the proper use and maintenance of test equipment to ensure accurate evaluations of equipment operation. For instance, when using a BIRD wattmeter for power measurements, the same set of rf bodies, wattmeter, and elements must be utilized due to the variability of the wattmeter components. For BITE, proper calibration and verification of measurements are required.

#### **d. Conditions.**

The facility is operating normally. For facilities that are equipped with standby equipment, switch standby equipment on-line to take readings.

#### **e. Detailed Procedure.**

At the local site or RMM location, perform the following steps.

**(1)** Measure and record the normal course SBO dc voltage on Navia Aviation Form "All Glide Slopes Normal Radiated Parameters".

**(3)** Measure and record the monitor width DDM (DS), the monitor course DDM (CL), and the modulation equality (carrier feedline DDM) on Navia Aviation Form "All Glide Slopes Normal Radiated Parameters".

**(4)** To obtain a computer generated data report of normal readings, log onto the facility to be recorded, check that the transmitter to be recorded is "On Antenna". The report may be printed by interacting the "Print report" window in the File menu. Include the Front Panel in

order to inform which transmitter was active to the antennas during measurements.

(5) At all dual equipment facilities complete a normal line entry for each set of equipment.

#### **5-41 LOCAL AND REMOTE MONITOR SHUTDOWN OPERATION.**

##### **a. Object.**

This procedure provides a method to determine that a shutdown is properly sensed at the local and/or remote control points.

##### **b. Discussion.**

Certain alarms in the ILS equipment shall result in an equipment transfer and/or shutdown. Also, if remotely monitored, an indication that the facility is shut down shall be received at the remote monitor location. This check confirms that the shutdown occurs and that the remote control point is properly notified. This check can also be initiated and monitored from a remote maintenance monitor (RMM) location.

##### **c. Conditions.**

The facility is operating normally. Advance coordination of this maintenance activity with air traffic control personnel is required.

##### **d. Detailed Procedure.**

1. Simulate a continuous alarm, or from the RMM perform a station integrity check.
2. Allow a shutdown to occur.
3. Determine that the proper remote and local alarm indications occurred.
4. If remote restore capability is installed, restore the facility from the remote control point or allow the auto-restart circuit to restore the facility.
5. Make an entry in the facility log that this check was completed.

**5-42 thru 5-44 reserved.**

#### **5-45 CAPTURE-EFFECT MONITOR.**

##### **a. Object.**

This procedure provides a method to determine whether the glide slope monitor alarm points are within the reference values established during the reference flight inspection.

##### **b. Discussion.**

1. The glide slope monitor is used to ensure the integrity of the glide slope system by permitting the glide slope to operate only if certain system parameters are within the limits established during the reference flight inspection. This performance check is accomplished by adjusting the transmitting equipment to cause a monitor alarm and then verifying that the radiated parameters are within established reference values. If a radiated parameter is found outside the established reference values, it must be determined if the condition is due to monitor drift. If so, the monitor alarm points must be tightened to ensure that for day-to-day monitor drift, the monitor will alarm whenever the radiated signal parameters are at or beyond the established reference values.
2. The reference data must be measured carefully. Rf power measurements using the Bird Wattmeter must always be accomplished with the same meter and elements. The elements shall be clearly marked. In addition to the rf wattmeter readings, it is recommended

that a digital voltmeter (dvm) be used to obtain reference readings for carrier and sideband power in normal, wide, and narrow alarm. These reference readings can be made with greater repeatability by using the dvm than by using the analog wattmeter. This is done by connecting a dvm, set to measure dc voltage, to the detector element output in place of the normal meter. Improved consistency in dvm readings will result if the dvm input is shunted with a 1400-W  $\pm 1$  percent resistor. This resistor presents the same load to the detector elements as the normal analog meter. If the reference readings are made with the load resistor in place, all future measurements must be made in this configuration.

3. Measurements taken with built in test equipment (BITE) (i.e., power, DDM, modulation, etc.) must be verified for accuracy with external test equipment as outlined in this handbook. This is to ensure that repeatable results are obtained and maintained in the case of internal equipment failure and/or replacement of modules that effect BITE measurements.
4. For equipment that uses a maintenance data terminal (MDT), when adjusting the phase of a signal, the number of degrees adjusted may need to be determined from a reference index number. This may be accomplished via a table or conversion chart, usually found in the equipment TI. For this reason, the alternate methods described in the procedures (i.e., the addition and removal of line lengths, elbows, etc.) is recommended.
5. The monitor DDM values are the monitor input values as measured with a PIR or the digital readout values of the monitor or as measured with BITE/MDT. No tolerance is established for the DDM values. They are used to detect trends such as system or monitor drift.
6. This performance check requires a line entry on Navia Aviation Form "CEGS Monitor Reference Data". The reference data line contains the reference data used to perform a monitor performance check. The reference data line can only be updated in accordance with paragraph 5-7.

**c. Test Equipment Required.**

1. A portable ILS receiver (PIR).
2. BITE/MDT
3. BIRD wattmeter
4. A dvm.
5. The FA-9438 modulation meter or equivalent.

**d. Conditions.**

A facility shutdown is required for this check.

**e. Detailed Procedure.**

1. Preliminary actions.

(a) Refer to Navia Aviation Form "CEGS Monitor Reference Data" for the reference values specified during the monitor performance check.

(b) Verify that modulation is 40 percent for each tone. (PIR connected to CSB COU test connector on facility front). The facility must be properly phased.

(c) Set up the PIR or equivalent to measure DDM in the carrier feedline and ensure that modulation equality (0 DDM) exists.

(d) Bypass the equipment monitor(s).

2. Width alarms.

(a) Connect the dvm to the transmitter SBO test connector.. *This voltage represents the nominal transmitter SBO power in front of the SBO step attenuator.* Measure the dc voltage, note

the transmitter SBO attenuator value and record in Table "CEGS Monitor Reference Data". Compare the values to the reference values. If found outside the tolerance investigation should be carried out.

(b) Decrease the sideband power (increase the SBO attenuator value) until the monitor is in alarm. Confirm that this attenuator value is not greater than the flight checked reference value. Record this SBO attenuator value. If the alarm value has been exceeded, corrective action should be taken.

(c) Measure and record the width monitor DDM on Navia Aviation Form "CEGS Monitor Reference Data". The width DDM is available in the PMDT Monitor 1 window. Note that no tolerance exists on this entry. It is used to detect trends.

(d) Increase the sideband power (decrease the SBO attenuator value) until the monitor is in alarm. Confirm that this attenuator value is not less than the flight checked reference value. Record this SBO attenuator value. If the alarm value has been exceeded, corrective action should be taken.

(e) Measure and record the width monitor DDM on Navia Aviation Form "CEGS Monitor Reference Data". The width DDM is available in the PMDT Monitor 1 window. Note that no tolerance exists on this entry. It is used to detect trends.

(g) Return the sideband power to normal.

### 3. Path angle alarms (integral).

(a) Connect the PIR to measure DDM in the carrier feedline (Facility CSB test connector).

(b) Using the PMDT, open Test DDM window, click on TX1 dominance **Off** button to activate 90 Hz predominance (assuming transmitter 1 is active to the antennas). If necessary adjust **Inc** or **Dec** until the monitor course position channel has just passed the threshold of alarm. Measure and record the carrier feedline DDM value on Navia Aviation Form "CEGS Monitor Reference Data". Confirm that the carrier feedline DDM is not more than established reference value. If not within tolerance, corrective action is required.

(c) Measure and record the course monitor DDM on Navia Aviation Form "CEGS Monitor Reference Data". The course monitor DDM can be observed in the currently active Test DDM window as parameter MON1 CL DDM Nom. Note that no tolerance is established for this entry. It is used only to detect trends.

(d) Repeat the procedure in steps (b) and (c) with the TX1 dominance button activated to 150 Hz.

(e) Restore the TX1 dominance button to **off**.

### 4. SBO dephasing alarms.

(a) Insert a N type elbow in the CSB carrier feedline. (CSB phase retarded)

(b) Confirm that the phase change is within the operating tolerance in chapter 3.

(c) Repeat the procedure in step (b) with the SBO phase retarded.

(d) Remove the added line lengths.

5. Middle antenna dephasing alarms.

(a) Insert and adjust the test kit phaser in the middle antenna feedline until the clearance monitor alarms. The test kit phaser should be the same as used for the reference flight check that established the Navia Aviation Form "CEGS Monitor Reference Data" values. Also, the test phaser should have been previously checked with a vector voltmeter to ensure accuracy. A preferred alternate method is to add the same predetermined line length (type N or BNC elbows, or equivalent) to both the lower and upper antenna outputs of the APCU.

(b) Record the change in degrees in the middle antenna dephasing column on Navia Aviation Form "CEGS Monitor Reference Data". Confirm that the value is within established reference value. If not within tolerance, corrective action is required.

(c) Repeat the procedure in the above steps with the middle antenna phase retarded (the same line length added to the middle antenna output).

(d) Restore the middle antenna phase to normal, or remove the test phaser or lines.

6. Attenuate upper antenna alarm.

(a) Insert the capture-effect test kit attenuator into the upper antenna feedline. This attenuator should have been previously checked with a vector voltmeter to ensure that the total insertion phase delay equals  $360^\circ \pm 5^\circ$ . Also, the accuracy of the dial calibration of the attenuator should be verified. Refer to paragraph 5-155 for this procedure.

(b) Adjust the test attenuator until the path monitor alarms. (c) Record the attenuation value in the upper antenna attenuation column on Navia Aviation Form "CEGS Monitor Reference Data". Confirm that the attenuation is less than, or equal to, the established reference value. If not within tolerance, corrective action is required.

(d) Remove the test attenuator from the upper antenna feedline.

7. Attenuate middle antenna alarm.

(a) Insert the capture-effect test kit attenuator into the middle antenna feedline.

(b) Adjust the test attenuator until the width monitor alarms.

(c) Record the attenuation value in the middle antenna attenuation column on Navia Aviation Form "CEGS Monitor Reference Data". Confirm that the attenuation is less than, or equal to, the established reference value. If not within tolerance, corrective action is required.

(d) Remove the test attenuator from the middle antenna feedline.

8. Modulation level alarms.

(a) Reduce the carrier power until the monitor is in rf low-level alarm. This is accomplished from the PMDT: Open the TX Adjustments window. Select COURSE RF Power (for active

transmitter to antenna). Note the 3-digits value.

(b) Then reduce the value of the 3-digits number followed by Update until the monitor channel CL is in alarm. Measure and record the COU CSB dc voltage at the transmitter test connector.

(c) Measure the carrier power using the BIRD wattmeter connecting to the course CSB feedline inside the facility.

(d) Restore the carrier rf power to normal (original 3-digit value). Measure and record the carrier power still connecting the BIRD wattmeter to the course CSB feedline inside the facility.

(e) Determine if the carrier power reduction corresponding to alarm is within the operating tolerance in chapter 3.

(f) Remove the wattmeter from the carrier feedline.

#### 9. Rf level alarms.

(a) Reduce the carrier power until the monitor is in rf low-level alarm. This is accomplished from the PMDT: Open the TX Adjustments window. Select COURSE RF Power (for active transmitter to antenna). Note the 3-digits value.

(b) Then reduce the value of the 3-digits number followed by Update until the monitor channel CL is in alarm. Measure and record the COU CSB dc voltage at the transmitter test connector.

(c) Measure the carrier power using the BIRD wattmeter connecting to the course CSB feedline inside the facility.

(d) Restore the carrier rf power to normal (original 3-digit value). Measure and record the carrier power still connecting the BIRD wattmeter to the course CSB feedline inside the facility.

(e) operating tolerance in chapter 3.

(f) Remove the wattmeter from the carrier feedline.

10. **Clearance transmitter.** Repeat steps (8) and (9).

#### **NOTE:**

The FA-9438 modulation meter may not accurately measure the high 150 Hz modulation percentage. In this case, use the alternate procedure explained in paragraph 5-47.

11. Restore the facility to service.

**5-46 Reserved.**



## **5-47 90 AND 150 Hz MODULATION PERCENTAGES.**

### **a. Object.**

This procedure provides a method to determine the amplitude modulation percentages of the 90 and 150 Hz navigational tones.

### **b. Discussion.**

1. The FA-9438 modulation meter (or equivalent) is the primary standard for the measurement of modulation percentage. Other equivalent pieces of test equipment could include a portable ILS receiver (PIR) capable of measuring modulation directly or built-in test equipment (BITE). These may be substituted for the FA-9438 when properly calibrated and/or verified for accuracy. The oscilloscope method is a backup method that uses the detected composite carrier envelope for determining the approximate percentage. The oscilloscope reference values should be noted when flight inspection or FA-9348 modulation meter have been used to measure modulation.
2. If flight inspection reports the modulation out of tolerance, reconfirm your measurement. If the measurement is within the FA-9438 or BITE that has been verified with the FA-9438, before adjusting the transmitter modulation percentage to meet flight inspection tolerances, advise flight inspection personnel of your situation. If possible, ask them to verify their system calibration and check for radio-frequency interference (rfi). Factors that may cause a difference in modulation percentage readings are:
  - (a) Excessive carrier component distortion.
  - (b) FA-9438 calibration correction factor or front panel calibration.
  - (c) BITE malfunction. With standby equipment, a quick check might be made by transferring to the standby to check for the same indication.
  - (d) Transmitter output spectrum and frequency and the 90 and 150 Hz frequencies.
  - (e) Stray rf pickup by the cable connecting the FA-9438 to the rf wattmeter body coupler may cause erroneous or inconsistent readings. Double-shielded coaxial cable, such as RG-223/U will minimize stray rf pickup by the cable.

### **c. Test Equipment Required.**

1. The FA-9438 modulation meter (or equivalent).

### **d. Conditions.**

The facility is operating normally.

### **e. Procedures.**

Refer to Instruction Book TI 6750.141, Installation, Operation, and Maintenance Instructions for Meter, ILS Modulation, Type FA-9438, section 3, for complete front panel calibration and operational instructions. The following steps are a digest of those instructions. Steps (1)

through (5) are the front panel calibration steps. The alternate procedure (paragraph g) uses the oscilloscope to determine the approximate modulation percentage.

1. Turn the FA-9438 ac power switch ON and allow a 10-minute warmup.
2. Place the function selector switch to RF ZERO, and adjust the RF ZERO control for 00.0 on the PERCENT MODULATION indication.
3. Place the function selector switch to DISPLAY ZERO, and adjust the DISPLAY ZERO control for 00.0 on the PERCENT MODULATION indicator.
4. Place the function selector switch to CAL 150 Hz, and adjust the CAL 150 Hz control for 42.5 on the PERCENT MODULATION indicator.
5. Place the function selector switch to CAL 90 Hz, and adjust the CAL 90 Hz control for 42.5 on the PERCENT MODULATION INDICATOR.

**NOTE:**

It may be necessary to repeat steps (2) through (5) occasionally as the FA-9438 warms up.

6. Use a double-shielded coaxial cable and connect the modulation meter to the COU CSB test connector on the front of the facility. Insert a 20 dB attenuator at the input of the modulation meter.
7. Place the function selector switch to LOCALIZER or GLIDE SLOPE, as appropriate, and read the 90 Hz and 150 Hz modulation percentages on the PERCENT MODULATION indicator.
8. Record the percentages on FAA Form 6750-32, and determine if they are in tolerance.
9. At two-frequency facilities, complete the steps above for the clearance transmitter on a different FAA Form 6750-32. (Test cable connected to CLR CSB test connector.)
10. Restore the equipment to normal.

**5-48 thru 5.51 Reserved.**

**5.52 Not recommended for Navia Aviaion ILS.**

**5.53 Not recommended for Navia Aviaion ILS.**

**5-55 thru 5-60 Reserved.**

**5-61 Not applicable.**

