

IdeaCentre A540 Series User Guide



Read this first

Before using this documentation and the product it supports, ensure that you read and understand the following:

- Appendix A “Important safety information” on page 45
- *Safety and Warranty Guide*
- *Setup Guide*

First Edition (May 2019)

© Copyright Lenovo 2019.

LIMITED AND RESTRICTED RIGHTS NOTICE: If data or software is delivered pursuant to a General Services Administration “GSA” contract, use, reproduction, or disclosure is subject to restrictions set forth in Contract No. GS-35F-05925.

Contents

About this documentation iii

Chapter 1. Meet your computer 1

Front	1
Rear	3
Bottom	7
Features and specifications	8
Statement on USB transfer rate	9

Chapter 2. Get started with your computer 11

Adjust the computer stand	11
Get started with Windows 10	11
Windows account	11
Set up face recognition	12
Windows user interface	12
Connect to networks	13
Connect to the wired Ethernet	13
Connect to Wi-Fi networks.	13
Lenovo Vantage and Lenovo PC Manager	13
Use the multi-touch screen	14
Use multimedia	17
Use audio	17
Use the camera	17
Connect to an external display	17

Chapter 3. Explore your computer 19

Manage power	19
Set power button behaviors	19
Set the power plan	19
Transfer data	19
Connect to a Bluetooth-enabled device.	19
Use the optical drive	20
Use a media card	20

Chapter 4. Troubleshooting and recovery 21

Basic procedure for resolving computer problems	21
Troubleshooting	21
Startup problems	22

Screen problems	23
Audio problems	24
Network problems	25
Performance problems	27
CD or DVD problems	28
Software problems.	29
Recovery	29
Restore system files and settings to an earlier point	29
Restore your files from a backup	29
Reset your computer	29
Use advanced options	29
Windows automatic recovery.	30
Create and use a recovery USB device	30
Update the device driver	31

Chapter 5. CRU replacement 33

What are CRUs	33
Replace a CRU	33
Storage drive	33
Hinge cover	36

Chapter 6. Help and support 41

Self-help resources	41
Call Lenovo	42
Before you contact Lenovo	42
Lenovo Customer Support Center.	43
Purchase additional services.	43

Appendix A. Important safety information. 45

Appendix B. Accessibility and ergonomic information 59

Appendix C. Compliance information. 63

Appendix D. Notices and trademarks. 75

About this documentation

- Illustrations in this documentation might look different from your product.
- Depending on the model, some optional accessories, features, and software programs might not be available on your computer.
- Depending on the version of operating systems, some user interface instructions might not be applicable to your computer.
- Documentation content is subject to change without notice. Lenovo makes constant improvements on the documentation of your computer, including this *User Guide*. To get the latest documentation, go to: <https://support.lenovo.com>
- Microsoft® makes periodic feature changes to the Windows® operating system through Windows Update. As a result, some information in this documentation might become outdated. Refer to Microsoft resources for the latest information.
- This documentation applies to the following product models:

Model name	Machine type (MT)
IdeaCentre A540-27ICB	F0EK
IdeaCentre A540-24ICB	F0EL
IdeaCentre A540-24API	F0EM

Chapter 1. Meet your computer

Front

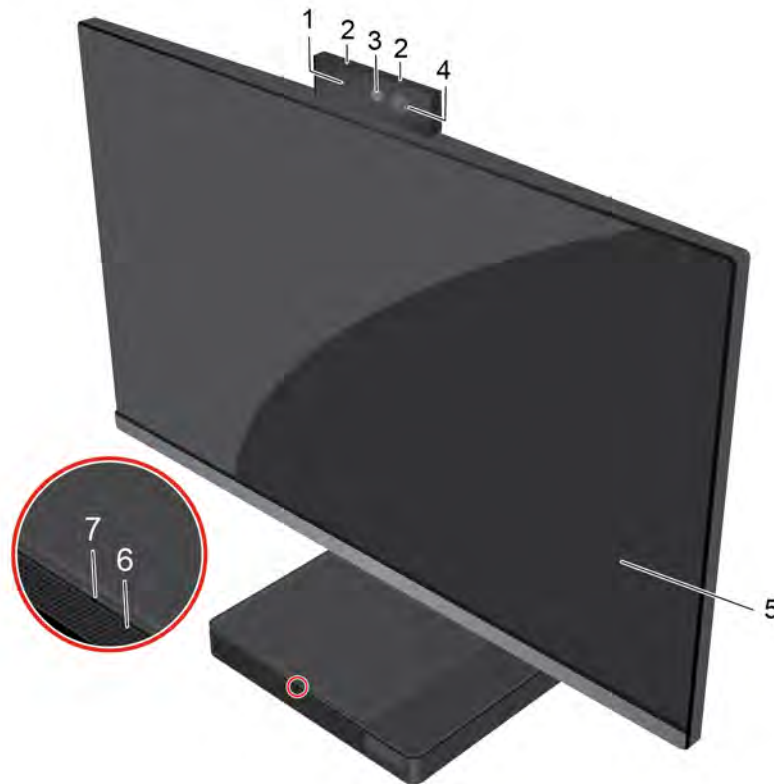

1. Integrated camera activity indicator	The indicator is on when the camera is in use.
2. Integrated microphones (2)	Capture or record sound and voice. Take pictures or record videos by clicking Camera from the Start menu.
3. Integrated camera	If you use other apps that support photographing, video chatting, and video conference, the camera starts automatically when you enable the camera-required feature from the app.
4. Infrared camera	Sign in to your account with face authentication.
5. Screen	Displays text, graphics, and videos. Selected models support multi-touch function. See "Use the multi-touch screen" on page 14.

6. Internal speakers

Enable you to experience high-quality sound.

7. Wireless charging indicator*

The indicator shows the charging status of a phone that supports wireless charging.

- **Blinking white:** The phone is being charged.
- **Solid white:** The phone is fully charged.
- **Blinking amber:** Charging error occurs.
- **Off:** No compatible phone is detected.

Note: For some phones, the indicator might still blink white when the phone is fully charged.

* optional

Rear

24-inch models

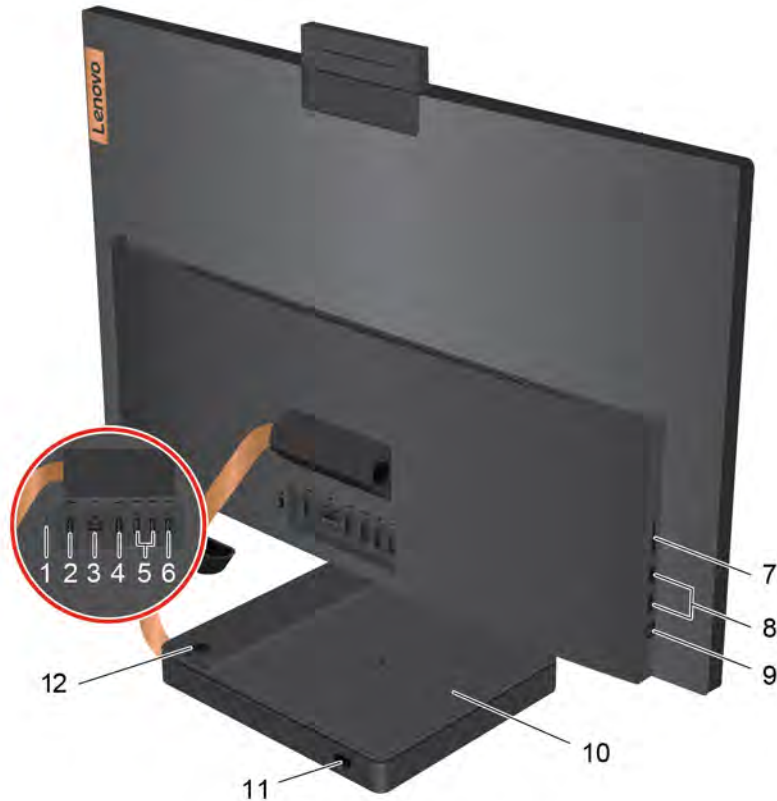

1. HDMI™ in/out switcher	Switch between HDMI-in mode and HDMI-out mode manually.
2. HDMI 1.4 in connector	Receive audio and video signals to the computer. For more information, see https://www.hdmi.org/manufacturer/hdmi_1_4/index.aspx .
3. Ethernet connector	Connect to a local area network (LAN). When the green indicator is on, the computer is connected to a LAN. When the yellow indicator blinks, data is being transmitted.
4. HDMI 1.4 out connector	Send audio and video signals from the computer to another audio or video device, such as a high-performance monitor. For more information, see https://www.hdmi.org/manufacturer/hdmi_1_4/index.aspx .
5. USB 2.0 connectors (2)	Connect USB-compatible devices, such as a USB keyboard, USB mouse, USB storage device, or USB printer.
6. USB 3.1 connector Gen 1/Gen 2*	Connect USB-compatible devices, such as a USB keyboard, USB mouse, USB storage device, or USB printer.

7. 3 in 1 SD card slot	<p>Supported cards:</p> <ul style="list-style-type: none"> • Secure Digital (SD) card • Secure Digital eXtended-Capacity (SDXC) UHS-1 card • Secure Digital High-Capacity (SDHC) UHS-1 card <p>Note: Your computer does not support the content protection for recordable media (CPRM) feature for the SD card.</p> <p>See “Use a media card” on page 20.</p>
8. USB 3.1 connectors Gen 1/ Gen 2* (2)	Connect USB-compatible devices, such as a USB keyboard, USB mouse, USB storage device, or USB printer.
9. Combo audio jack	<p>Connect headphones or headsets with a 3.5-mm (0.14-inch), 4-pole plug.</p> <p>Note: This jack does not support standalone external microphones. If you use headsets, choose one with a single plug.</p>
10. Wireless charging pad**	<p>Charge a phone that supports wireless charging.</p> <p>Place your phone at the center of the pad. If the indicator blinks amber, adjust the phone's position and remove any metal object on or near the pad.</p>
11. Power cord connector	Connect the power cord to your computer for power supply.
12. Power button	<p>Press to turn on the computer.</p> <p>To turn off the computer, open the Start menu, click  Power, and then select Shut down.</p> <p>The indicator in the power button shows the system status of your computer.</p> <ul style="list-style-type: none"> • On: The computer is on. • Off: The computer is off or in hibernation mode. • Blinking: The computer is in sleep mode.

* for A540–24ICB models only

** optional

27-inch models

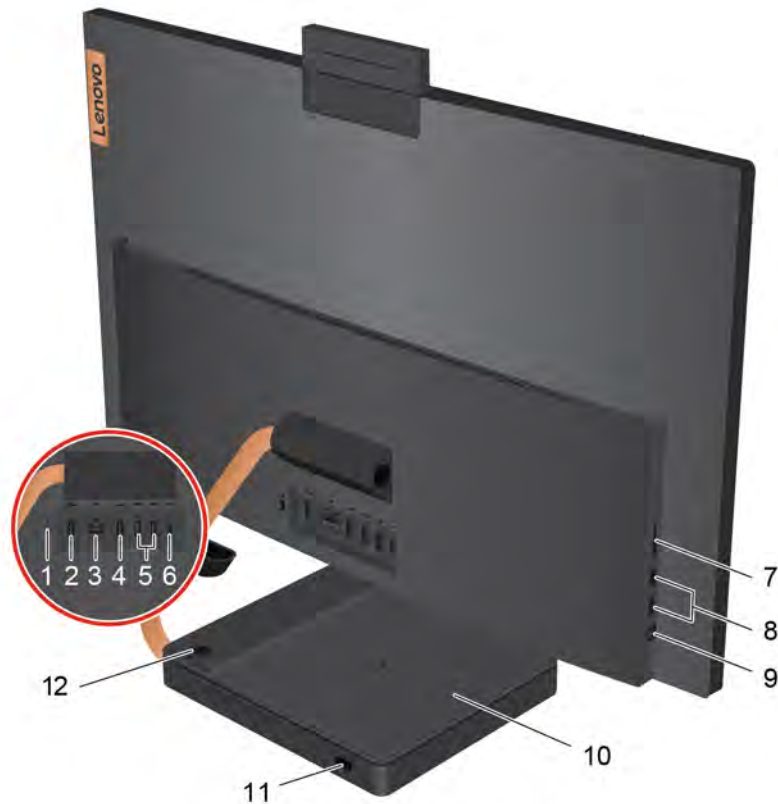

1. HDMI in/out switcher	Switch between HDMI-in mode and HDMI-out mode manually.
2. HDMI 1.4 in connector	Receive audio and video signals to the computer. For more information, see https://www.hdmi.org/manufacturer/hdmi_1_4/index.aspx .
3. Ethernet connector	Connect to a local area network (LAN). When the green indicator is on, the computer is connected to a LAN. When the yellow indicator blinks, data is being transmitted.
4. HDMI 1.4 out connector	Send audio and video signals from the computer to another audio or video device, such as a high-performance monitor. For more information, see https://www.hdmi.org/manufacturer/hdmi_1_4/index.aspx .
5. USB 2.0 connectors (2)	Connect USB-compatible devices, such as a USB keyboard, USB mouse, USB storage device, or USB printer.

6. USB-C™ connector (USB 3.1 Gen 1)	<ul style="list-style-type: none"> • Charge your computer. • Charge USB-C compatible devices with the output voltage and current of 5 V and 3 A. • Transfer data at USB 3.1 speed, up to 5 Gbps. • Connect to an external display: <ul style="list-style-type: none"> – USB-C to VGA: 1900 x 1200 pixels, 60 Hz – USB-C to DP: 3840 x 2160 pixels, 60 Hz • Connect to USB-C accessories to help expand your computer functionality. To purchase USB-C accessories, go to https://www.lenovo.com/accessories.
7. 3 in 1 SD card slot	<p>Supported cards:</p> <ul style="list-style-type: none"> • Secure Digital (SD) card • Secure Digital eXtended-Capacity (SDXC) UHS-1 card • Secure Digital High-Capacity (SDHC) UHS-1 card <p>Note: Your computer does not support the content protection for recordable media (CPRM) feature for the SD card.</p> <p>See “Use a media card” on page 20.</p>
8. USB 3.1 connectors Gen 2 (2)	<p>Connect USB-compatible devices, such as a USB keyboard, USB mouse, USB storage device, or USB printer.</p>
9. Combo audio jack	<p>Connect headphones or headsets with a 3.5-mm (0.14-inch), 4-pole plug.</p> <p>Note: This jack does not support standalone external microphones. If you use headsets, choose one with a single plug.</p>
10. Wireless charging pad*	<p>Charge a phone that supports wireless charging.</p> <p>Place your phone at the center of the pad. If the indicator blinks amber, adjust the phone's position and remove any metal object on or near the pad.</p>
11. Power cord connector	<p>Connect the power cord to your computer for power supply.</p>
12. Power button	<p>Press to turn on the computer.</p> <p>To turn off the computer, open the Start menu, click  Power, and then select Shut down.</p> <p>The indicator in the power button shows the system status of your computer.</p> <ul style="list-style-type: none"> • On: The computer is on. • Off: The computer is off or in hibernation mode. • Blinking: The computer is in sleep mode.

* optional

Bottom



1. HDD door*

Enable you to insert or remove the hard disk drive. You can use the latch to lock or unlock the HDD door.

2. Internal speakers (2)

Enable you to experience high-quality sound.

* for 24-inch models only

Features and specifications

Hardware configuration	<ol style="list-style-type: none">1. Right-click the Start button to open the Start context menu.2. Click Device Manager. Type the administrator password or provide confirmation if prompted.
Power supply	<ul style="list-style-type: none">• A540-24ICB: 90/120-watt automatic voltage-sensing power supply• A540-24API: 120-watt automatic voltage-sensing power supply• A540-27ICB: 120/150-watt automatic voltage-sensing power supply
Electrical input	<ul style="list-style-type: none">• Input voltage: From 100 V ac to 240 V ac• Input frequency: 50/60 Hz
Adaptability for power supply	<ul style="list-style-type: none">• Mainland China: 220 V\pm22 V, 50 Hz\pm1 Hz• Adaptive voltage positioning: 90 V to 264 V, 50/60 Hz• With voltage selection switch: 90 V to 264 V, 50 Hz\pm1 Hz
Microprocessor	To view the microprocessor information of your computer, right-click the Start button and then click System .
Memory	Double data rate 4 (DDR4) small outline dual in-line memory module (SODIMM)
Storage device	<ul style="list-style-type: none">• 2.5-inch form factor, 7-mm (0.28-inch) height hard disk drive• M.2 solid-state drive• Intel® Optane™ memory <p>To know the storage drive capacity of your computer, right-click the Start button and then click Disk Management.</p> <p>Note: The storage drive capacity indicated by the system is less than the nominal capacity.</p>
Video features	<ul style="list-style-type: none">• Brightness control• Color display with Thin Film Transistor (TFT) technology• Color display with Wide Viewing Angle (WVA)• Display size:<ul style="list-style-type: none">– 609.6 mm (24 inches)– 685.8 mm (27 inches)• Display resolution:<ul style="list-style-type: none">– 1920 x 1080 pixels (24 inches)– 2560 x 1440 pixels (27 inches)• Multi-touch technology*• The integrated graphics card supports the following:<ul style="list-style-type: none">– HDMI 1.4 out connector• The optional discrete graphics card provides an enhanced video experience and extended capabilities.

Audio features	<ul style="list-style-type: none"> • The integrated audio card supports the following: <ul style="list-style-type: none"> – Combo audio jack – Integrated microphones – Internal speakers • The optional discrete audio card provides an enhanced audio experience and extended capabilities.
Expansion	<ul style="list-style-type: none"> • 3 in 1 SD card slot (SD, SDHC, SDXC) • Memory slots • M.2 solid-state drive slot • External optical drive* • Storage drive bay
Network features	<ul style="list-style-type: none"> • Bluetooth • Ethernet LAN • Wireless LAN
Other features	<ul style="list-style-type: none"> • Keyboard: USB wired, 2.4G wireless • Mouse: USB wired, 2.4G wireless • Wireless charger* • Windows Hello • Modern standby (for 24ICB and 27ICB models only) • MS Far field Cortana • HDD open door (4-side borderless default, 3-side borderless optional) (for 24-inch models only)

* optional

Statement on USB transfer rate

Depending on many factors such as the processing capability of the host and peripheral devices, file attributes, and other factors related to system configuration and operating environments, the actual transfer rate using the various USB connectors on this device will vary and will be slower than the data rate listed below for each corresponding device.

USB device	Data rate (Gbit/s)
3.1 Gen 1	5
3.1 Gen 2	10
3.2	20

Chapter 2. Get started with your computer

Adjust the computer stand

Note: For information about installing the computer stand, refer to the setup guide that comes with your computer.

Full-function monitor stand

- Tilt the screen forward and back.

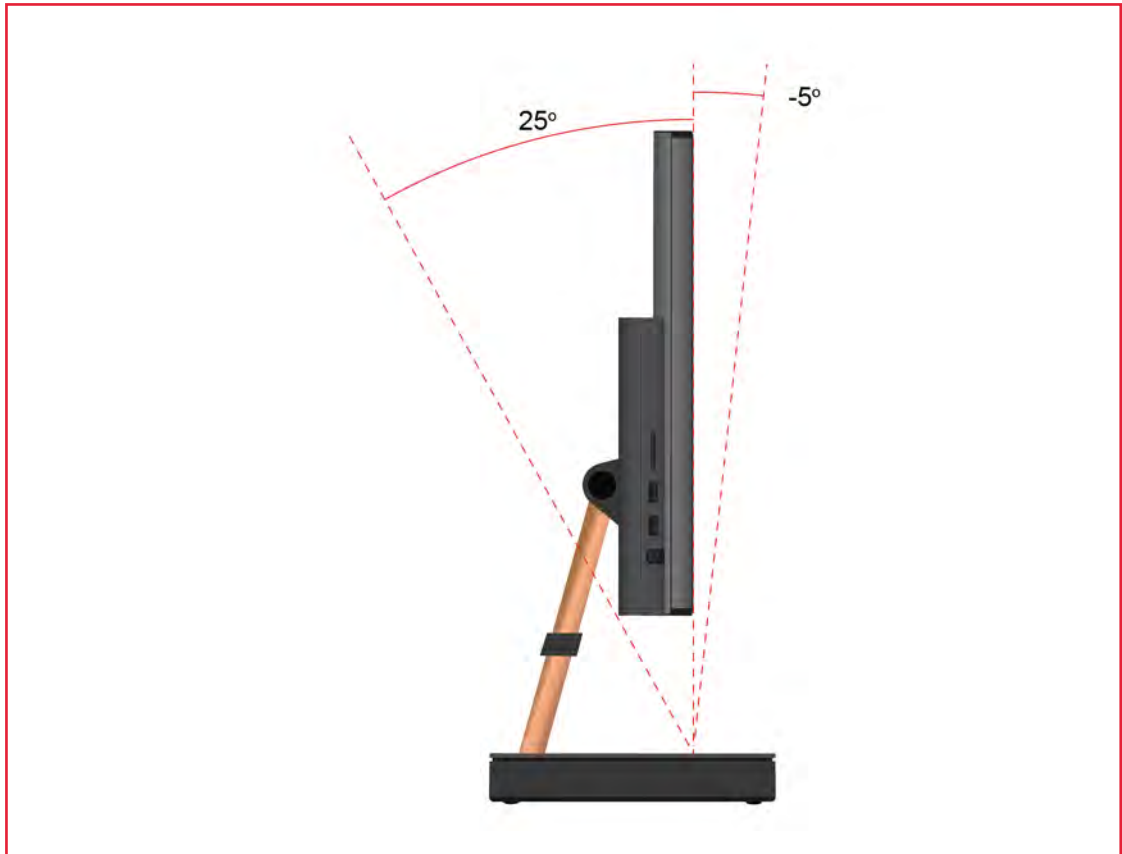

Get started with Windows 10

Learn the basics of Windows 10 and start working with it right away. For more information about Windows 10, see the Windows help information.

Windows account

A user account is required to use the Windows operating system. It can either be a Windows user account or a Microsoft account.

Windows user account

When you start Windows for the first time, you are prompted to create a Windows user account. This first account you created is of the “Administrator” type. With an Administrator account, you can create additional user accounts or change account types by doing the following:

1. Open the Start menu and select **Settings** → **Accounts** → **Other people**.
2. Follow the on-screen instructions.

Microsoft account

You can also log in to the Windows operating system with a Microsoft account.

To create a Microsoft account, go to the Microsoft sign-up page at <https://signup.live.com> and follow the on-screen instructions.

With a Microsoft account, you can:

- Enjoy one-time signing in if you are using other Microsoft services, such as OneDrive, Skype, and Outlook.com.
- Sync personalized settings across other Windows-based devices.

Set up face recognition

If your computer includes a Windows Hello-compatible infrared camera, you can set up face recognition to sign in with your face.

1. Open the Start menu and select **Settings** → **Accounts** → **Sign-in options**.







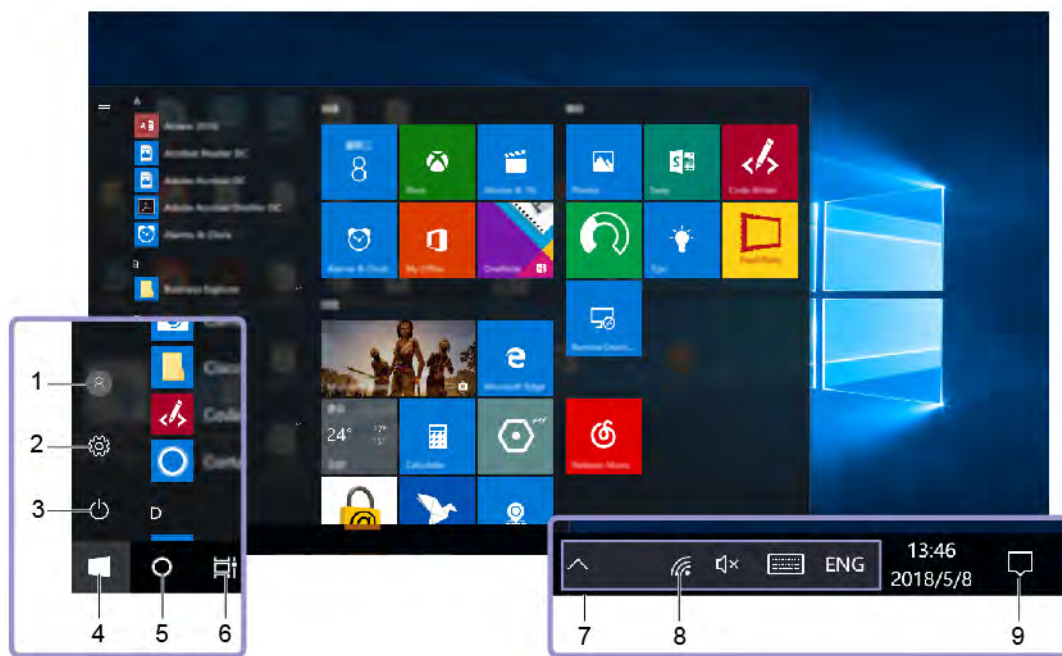

Note: If you are using a local account, the account must be password protected. Otherwise, you cannot set face recognition.

2. Under **Face Recognition**, select **Set up** → **Get started**.
3. Follow on-screen instructions to finish face recognition.

It is recommended that you create a PIN when prompted. A PIN can be used to sign in to Windows in cases when face recognition does not work.

Windows user interface



1. Account 	Change account settings, lock the computer, or sign out from the current account.
2. Settings 	Launch Settings.
3. Power 	Shut down, restart, or put the computer into sleep mode.
4. Start button 	Open the Start menu.
5. Windows Search 	Type what you are looking for in the search box and get search results from your computer and the Web.
6. Task View 	Display all opened apps and switch among them.
7. Windows notification area	Display notifications and status of some features.
8. Network icon	Connect to an available wireless network and display the network status. When connected to a wired network, the icon changes to  .
9. Action center 	Display the latest notifications from apps and provide quick access to some features.

Open the Start menu

- Click the **Start** button.
- Press the Windows logo key on the keyboard.

Open the Start context menu

Right-click the **Start** button.

Access Control Panel

- Open the Start menu and click **Windows System → Control Panel**.
- Use Windows Search.

Launch an app

- Open the Start menu and select the app you want to launch.
- Use Windows Search.

Connect to networks

Your computer helps you connect to the world through a wired or wireless network.

Connect to the wired Ethernet

Connect your computer to a local network through the Ethernet connector on your computer with an Ethernet cable.

Connect to Wi-Fi networks

1. Click the network icon in the Windows notification area. A list of available wireless networks is displayed.
2. Select a network to connect. Provide required information, if needed.

Lenovo Vantage and Lenovo PC Manager

Lenovo Vantage and Lenovo PC Manager is software developed by Lenovo. Using the software, you can:

- View product information

- View warranty and support information
- Run hardware scan and diagnose problems
- Change hardware settings
- Update Windows, drivers, and UEFI/BIOS

Lenovo Vantage or PC Manager may be pre-installed on your computer. To open it, enter the software name in Windows Search and select the matched result.

Note: If Lenovo Vantage is not pre-installed, you can download it from Microsoft Store.

Use the multi-touch screen

If your computer display supports the multi-touch function, you can navigate the screen with simple touch gestures.

Note: Some gestures might not be available depending on the app you use.



Tap once

- From the Start menu: Open an app or item.
- From the desktop: Select an app or item.
- In an open app: Perform an action such as **Copy**, **Save**, and **Delete**, depending on the app.



Tap twice quickly

Open an app or item from the desktop.



Tap and hold

Open a shortcut menu.

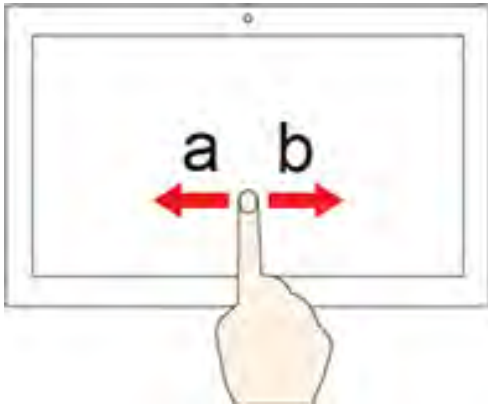

Slide

Scroll through items, such as lists, pages, and photos.



Drag an item to the location you want

Move an object.

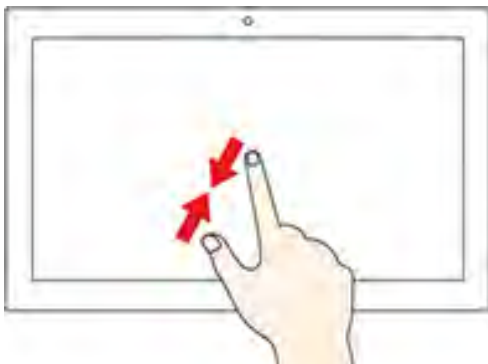

Move two fingers closer together

Zoom out.

Move two fingers farther apart

Zoom in.

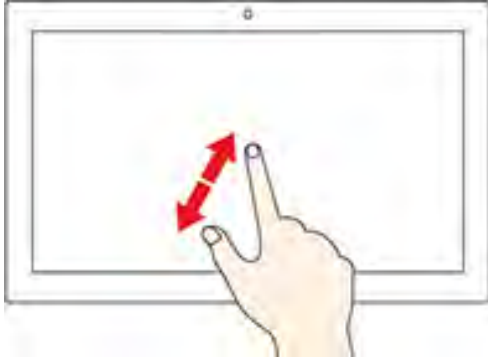

Swipe in from the right edge

Open the action center to see your notifications and quick actions.

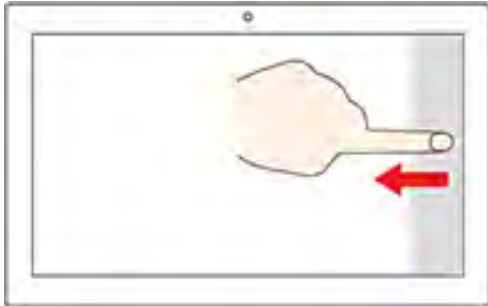

Swipe in from the left edge

View all your open windows in task view.



- **Swipe downwards shortly from the top edge (for full-screened app or when your computer is in the tablet mode)**

Show a hidden title bar.

- **Swipe in from the top edge to the bottom edge (when your computer is in the tablet mode)**

Close the current app.

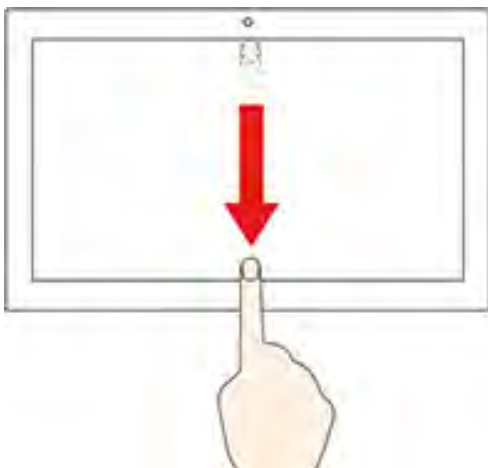

Tips

- Turn off the computer before cleaning the multi-touch screen.
- Use a dry, soft, and lint-free cloth or a piece of absorbent cotton to remove fingerprints or dust from the multi-touch screen. Do not apply solvents to the cloth.
- The multi-touch screen is a glass panel covered with a plastic film. Do not apply pressure or place any metallic object on the screen, which might damage the touch panel or cause it to malfunction.
- Do not use fingernails, gloved fingers, or inanimate objects for input on the screen.
- Regularly calibrate the accuracy of the finger input to avoid a discrepancy.

Use multimedia

Use your computer for business or entertainment with the devices (such as a camera, a monitor, or speakers).

Use audio

To enhance the audio experience, connect speakers, headphones, or a headset to the audio connector.

Adjust the volume

1. Click the volume icon in the Windows notification area on the taskbar.
2. Follow the on-screen instructions to adjust the volume. Click the speaker icon to mute the audio.

Change the sound settings

1. Go to Control Panel and view by category.
2. Click **Hardware and Sound** → **Sound**.
3. Change the settings as you prefer.

Use the camera

You can use the camera to take photos or record videos.

To take photos or record a video:

1. Open the Start menu and click **Camera**. You also can type Camera in the search box.
2. To take a photo, click the camera icon. If you want to record video, click the video icon to switch to video mode.

If you use other programs that provide features such as photographing, video capturing, and video conference, the camera starts automatically when you enable the camera-required feature.

To configure the camera settings:

1. Open the Start menu and click **Lenovo Vantage** → **Hardware Settings** → **Audio/Visual**.
2. Locate the **Camera** section and then follow the on-screen instructions.

Connect to an external display

Connect your computer to a projector or a monitor to give presentations or expand your workspace.

Connect to a wired display

1. Connect the external display to an appropriate video connector on your computer, such as the HDMI-out connector.

2. Connect the external display to an electrical outlet.
3. Turn on the external display.

If your computer cannot detect the external display, right-click an empty area of the desktop, and then click **Display settings → Detect**.

Connect to a wireless display

To use a wireless display, ensure that both your computer and the external display support the Miracast® feature.

- Open the Start menu, and then click **Settings → Devices → Bluetooth & other devices → Add Bluetooth or other device**. In the Add a device window, click **Wireless display or dock**. Then, follow the instructions on the screen.
- Click the action center icon  in the Windows notification area and click **Connect**. Select the wireless display and follow the on-screen instructions.

Set the display mode

Right-click a blank area on the desktop and select **Display settings**. Then, select a display mode of your preference from the **Multiple displays** menu.

- **Duplicate these displays:** Displays the same video output on both your computer screen and an external display.
- **Extend these displays:** Extends the video output from your computer display to an external display. You can drag and move items between the two displays.
- **Show only on 1:** Displays the video output only on your computer screen.
- **Show only on 2:** Displays the video output only on an external display.

If you show programs using DirectDraw or Direct3D® in full-screen mode, only the main display shows the video output.

Change display settings

1. Right-click a blank area on the desktop and select **Display settings**.
2. Select the display that you want to configure.
3. Change display settings of your preference.

You can change the settings for both the computer display and the external display. For example, you can define which one is the main display and which one is the secondary display. You also can change the resolution and orientation.

Note: If you set a higher resolution for the computer display than the external display, only part of the screen can be displayed on the external display.

Chapter 3. Explore your computer

Manage power

Use the information in this section to achieve the best balance between performance and power efficiency.

Set power button behaviors

You can define what the power button does according to your preference. For example, by pressing the power button, you can turn off the computer or put the computer to sleep or hibernation mode.

To change what the power button does:

1. Go to Control Panel and view by large icons or small icons.
2. Click **Power Options** → **Choose what the power buttons do**.
3. Change the settings as you prefer.

Set the power plan

For ENERGY STAR® compliant computers, the following power plan takes effect when your computers have been idle for a specified duration:

Table 1. Default power plan (when plugged into ac power)

<ul style="list-style-type: none">• Turn off the display: After 10 minutes• Put the computer to sleep: After 25 minutes
--

To awaken the computer from Sleep mode, press any key on your keyboard.

To reset the power plan to achieve the best balance between performance and power saving:

1. Go to Control Panel and view by large icons or small icons.
2. Click **Power Options**, and then choose or customize a power plan of your preference.

Transfer data

Quickly share your files using the built-in Bluetooth technology among devices with the same features. You also can install a disc or media card to transfer data.

Connect to a Bluetooth-enabled device

You can connect all types of Bluetooth-enabled devices to your computer, such as a keyboard, a mouse, a smartphone, or speakers. The devices must be within a short distance, usually 10 meters (33 feet), from the computer.

1. Turn on Bluetooth on the computer.
 - a. Open the Start menu, and then click **Settings** → **Devices** → **Bluetooth & other devices**.
 - b. Turn on the **Bluetooth** switch.
2. Click **Add Bluetooth or other device** → **Bluetooth**.
3. Select a Bluetooth device, and then follow the on-screen instructions.

Your Bluetooth device and computer will automatically connect the next time if the two devices are in range of each other with Bluetooth turned on. You can use Bluetooth for data transfer or remote control and communication.

Use the optical drive

If your computer has an optical drive, read the following information.

Know the type of your optical drive

1. Right-click the **Start** button to open the Start context menu.
2. Click **Device Manager**. Type the administrator password or provide confirmation, if prompted.

Install or remove a disc

1. With the computer on, press the eject/close button on the optical drive. The tray slides out of the drive.
2. Insert a disc into the tray or remove a disc from the tray, and then press the eject/close button again to close the tray.

Note: If the tray does not slide out of the drive when you press the eject/close button, turn off the computer. Then, insert a straightened paper clip into the emergency-eject hole adjacent to the eject/close button. Use the emergency eject only in an emergency.

Record a disc

1. Insert a recordable disc into the optical drive that supports recording.
2. Do one of the following:
 - Open the Start menu, and then click **Settings → Devices → AutoPlay**. Select or turn on **Use AutoPlay for all media and devices**.
 - Open Windows Media Player.
 - Double-click the ISO file.
3. Follow the on-screen instructions.

Use a media card

Install a media card

1. Locate the SD-card slot.
2. Ensure that the metal contacts on the card are facing that in the SD-card slot. Insert the card firmly into the SD-card slot until it is secured in place.

Remove a media card

Attention: Before removing a media card, eject the card from the Windows operating system first. Otherwise, data on the card might get corrupted or lost.

1. Click the triangular icon in the Windows notification area to show hidden icons. Then, right-click the **Safely Remove Hardware and Eject Media** icon.
2. Select the corresponding item to eject the card from the Windows operating system.
3. Press the card and remove it from your computer. Store the card safely for future use.

Chapter 4. Troubleshooting and recovery

This chapter provides solutions to resolve the computer problems. Use the basic procedure as a starting point for resolving computer problems.

Basic procedure for resolving computer problems

Prerequisite

Before you start, read Appendix A “Important safety information” on page 45 and print the following instructions.

1. Check that:
 - a. The cables for all connected devices are connected correctly and securely.
 - b. All components have been reassembled correctly.
 - c. All connected devices that require ac power are connected to properly grounded and working electrical outlets.
 - d. All connected devices are enabled in UEFI BIOS.
2. Use an antivirus program to see if the computer has been infected by a virus. If the program detects a virus, remove the virus.
3. Go to “Troubleshooting” on page 21 and follow the instructions for the type of problem you are experiencing.
4. Run the diagnostic program.
5. Recover your operating system. See “Recovery” on page 29.
6. If the problem persists, contact Lenovo. See Chapter 6 “Help and support” on page 41.

Troubleshooting

Use the troubleshooting information to find solutions to problems that have definite symptoms.

Startup problems

Problem	Solution
The computer does not start up when you press the power button.	<ul style="list-style-type: none">• Ensure that the power cord is correctly connected to the rear of the computer and to a working electrical outlet.• If the computer has a secondary power switch on the rear of the computer, ensure that it is switched on.• The power indicator on the front of the computer is on.• The computer voltage matches the voltage available at the electrical outlet for your country or region.
The operating system does not start up from the correct storage drive or fails to start up	<ul style="list-style-type: none">• Ensure that all storage drive signal cables and power cables are connected correctly.• Ensure that the storage drive the computer starts up from is listed as the first startup device in UEFI BIOS.• In rare cases, the storage drive with the operating system might get corrupted or damaged. In such cases, you might need to replace the storage drive.• If the computer is installed with an Optane memory:<ul style="list-style-type: none">– Ensure that the Optane memory is not removed.– Ensure that the Optane memory is not damaged. Check the Optane memory using diagnostic tools.
The computer beeps multiple times before the operating system starts up.	Ensure that no keys are stuck.

Screen problems

Problem	Solution
My screen goes blank while the computer is on.	<ul style="list-style-type: none">• The computer voltage matches the voltage available at the electrical outlet for your country or region.• Press a key to exit the screen saver.• Press the power button to resume the computer from sleep or hibernation mode.• The brightness and contrast is set correctly.• If the screen goes blank when some programs start, install the device drivers for the programs. Refer to the documentation for the affected program to check whether any device drivers are required.
The image appears to be flickering.	<ul style="list-style-type: none">• The screen might be affected by interference from nearby equipment. Magnetic fields around other devices, such as transformers, appliances, fluorescent lights, and other monitors, might be causing the problem. Move fluorescent desk lighting or any equipment that produces magnetic fields farther away from the screen. If the problem persists, turn off the computer. Then, adjust the placement of the computer and other devices so that they are at least 305 mm (12 inches) apart. Turn on the computer.• Reset the refresh rate.<ol style="list-style-type: none">1. Right-click a blank area on the desktop.2. Click Display settings. On the Display tab, click Advanced display settings → Display adapter properties for Display 1.3. Click the Monitor tab, and then reset the refresh rate to be the highest and noninterlaced.
The image is discolored.	<ul style="list-style-type: none">• The screen might be affected by interference from nearby equipment. Move fluorescent desk lighting or any equipment that produces magnetic fields farther away from the screen.• Turn off the computer. Then, adjust the placement of the computer and other devices so that they are at least 305 mm (12 inches) apart. Turn on the computer.

Audio problems

Problem	Solution
The audio cannot be heard on the Windows operating system.	<ul style="list-style-type: none">• If you are using powered external speakers that have an On/Off control, ensure that:<ul style="list-style-type: none">– The On/Off control is set to the On position.– The speaker power cable is connected to a properly grounded, functional ac electrical outlet.• If your external speakers have a volume control, ensure that the volume is not set too low.• Click the volume icon in the Windows notification area on the taskbar. Check the speaker and volume settings. Do not mute the speaker or set the volume at a very low level.• If your computer has a front audio panel, ensure that the volume is not set too low.• Ensure that your external speakers (and headphones, if used) are connected to the correct audio connector on the computer. Most speaker cables are color-coded to match the audio connector. <p>Note: When external-speaker or headphone cables are connected to the audio connector, the internal speaker, if present, is disabled. In most cases, if an audio adapter is installed in one of the expansion slots, the audio function built into the system board is disabled. Therefore, you must use the audio connectors on the audio adapter.</p> <ul style="list-style-type: none">• Ensure that the program you are running is designed for use in the Microsoft Windows operating system. If the program is designed to run in DOS, the program does not use the Windows sound feature. The program must be configured to use SoundBlaster Pro or SoundBlaster emulation.• Ensure that the audio device drivers are correctly installed.
The sound does not come from the headset or headphones.	<ol style="list-style-type: none">1. Exit the application that uses the sound device (for example, Windows Media Player).2. Right-click the volume icon in the Windows notification area on the taskbar.3. Click Playback devices.4. Select the headset or headphones, and then click Set Default.5. Click OK.
The sound comes from one of the external speakers.	<ul style="list-style-type: none">• Ensure that the speaker cable is inserted completely into the connector on the computer.• Ensure that the cable that connects the left speaker to the right speaker is securely connected.• Ensure that the balance settings are set correctly.<ol style="list-style-type: none">1. Right-click the volume icon in the Windows notification area on the taskbar. Then, click Open Volume Mixer and select the desired speaker.2. Click the speaker icon on top of the volume control, and then click the Levels tab.

Network problems

Note: The Wi-Fi and Bluetooth features are optional.

Problem	Solution
The computer cannot connect to an Ethernet LAN.	<ul style="list-style-type: none">• Connect the cable from the Ethernet connector to the RJ45 connector of the hub.• Enable the Ethernet LAN feature in UEFI BIOS.• Enable the Ethernet LAN adapter.<ol style="list-style-type: none">1. Go to Control Panel and view by large icons or small icons.2. Click Network and Sharing Center → Change adapter settings.3. Right-click the Ethernet LAN adapter icon and click Enable.• Update or reinstall the Ethernet LAN driver.• Install all networking software that is necessary for your network environment. Check with your LAN administrator for the necessary networking software.• Set the same duplex for the switch port and the adapter. If you configured the adapter for full duplex, ensure that the switch port is also configured for full duplex. Setting a wrong duplex mode might degrade performance, cause data loss, or result in lost connections.
When a Gigabit Ethernet model computer is used at a speed of 1000 Mbps, the Ethernet LAN connection fails or errors occur.	Connect the network cable to the Ethernet connector using Category 5 wiring and a 100 BASE-T hub/switch (not 100 BASE-X).
The Wake On LAN (WOL) feature does not work.	Enable the Wake On LAN feature in UEFI BIOS.
The Wi-Fi feature does not work.	<ul style="list-style-type: none">• Enable the Wi-Fi feature in UEFI BIOS.• Enable all Wi-Fi devices.<ol style="list-style-type: none">1. Right-click the Start button to open the Start context menu.2. Click Device Manager. Type the administrator password or provide confirmation, if prompted.3. Expand Network adapters to display all network devices.4. Right-click each Wi-Fi device, and then click Enable device.• Enable the Wi-Fi feature in Windows Settings.<ol style="list-style-type: none">1. Open the Start menu.2. Click Settings → Network & Internet → Wi-Fi.3. Enable the Wi-Fi feature.• Update or reinstall the Wi-Fi driver.

Problem	Solution
The Bluetooth feature does not work.	<ul style="list-style-type: none"> • Enable the Bluetooth feature in UEFI BIOS. • Enable all Bluetooth devices. <ol style="list-style-type: none"> 1. Right-click the Start button to open the Start context menu. 2. Click Device Manager. Type the administrator password or provide confirmation, if prompted. 3. Expand Bluetooth to display all Bluetooth devices. Right-click each Bluetooth device, and then click Enable device. 4. Expand Network adapters to display all network devices. Right-click each Bluetooth device, and then click Enable device. • Turn on the Bluetooth radio. <ol style="list-style-type: none"> 1. Open the Start menu. 2. Click Settings → Devices → Bluetooth & other devices. 3. Turn on the Bluetooth switch to enable the Bluetooth feature. • Update or reinstall the Bluetooth driver.
Sound does not come from the Bluetooth headset or headphones.	<ol style="list-style-type: none"> 1. Exit the application that uses the sound device (for example, Windows Media Player). 2. Right-click the volume icon in the Windows notification area on the taskbar. 3. Click Playback devices. 4. If you are using the headset profile, select Bluetooth Hands-free Audio, and then click Set Default. If you are using the AV profile, select Stereo Audio, and then click Set Default. 5. Click OK.

Performance problems

Problem	Solution
Excessive fragmented files exist on the storage drives.	<p>Note: Depending on the volume of the storage drives and amount of data stored on the storage drives, the disk-defragmentation process might take up to several hours.</p> <ol style="list-style-type: none">1. Close any open programs and windows.2. Open the Start menu.3. Click Windows System → File Explorer → This PC.4. Right-click your C drive and then click Properties.5. Click the Tools tab.6. Click Optimize. Select the drive as desired, and then click Optimize.7. Follow the on-screen instructions.
The free storage drive space is insufficient.	<ul style="list-style-type: none">• Clean out your Inbox, Sent Items, and Deleted Items folders from your e-mail application.• Clean up your C drive.<ol style="list-style-type: none">1. Open the Start menu.2. Click Windows System → File Explorer → This PC.3. Right-click your C drive and then click Properties.4. Check the amount of free space, and then click Disk Cleanup.5. A list of unnecessary file categories is displayed. Select the category you want to delete, and then click OK.• Disable some Windows features or remove some unnecessary programs.<ol style="list-style-type: none">1. Go to Control Panel and view by large icons or small icons.2. Click Programs and Features.3. Do one of the following:<ul style="list-style-type: none">– To disable some Windows features, click Turn Windows features on or off. Follow the on-screen instructions.– To remove some unnecessary programs, select the program you want to remove, and then click Uninstall/Change or Uninstall.
The free memory space is insufficient.	<ul style="list-style-type: none">• Right-click a blank area on the taskbar and open Task Manager. Then, end some tasks you are not performing.• Install additional memory modules.

CD or DVD problems

Problem	Solution
A CD or DVD does not work.	<ul style="list-style-type: none">• Ensure that the optical drive supports the CD or DVD.• Ensure that the disc is inserted correctly, with its label up.• Ensure that the disc you are using is clean. To remove dust or fingerprints, wipe the disc clean with a soft cloth from the center to the outside. Wiping a disc in a circular motion might cause loss of data.• Ensure that the power cable and signal cable are securely connected to the drive.• Ensure that the disc you are using is not scratched or damaged. Try inserting another disc that you know works.• If you have multiple CD or DVD drives installed (or a combination of CD and DVD drives), try inserting the disc into the other drive. In some cases, only one of the drives is connected to the audio subsystem.
A bootable recovery medium, such as the Product Recovery CD, cannot be used to start your computer.	<p>Ensure that the CD or DVD drive is set as the top priority of the boot priority order in UEFI BIOS.</p> <p>Note: On some computer models, the startup sequence is permanently set and cannot be changed.</p>
A black screen is displayed instead of the DVD video.	<ul style="list-style-type: none">• Restart the DVD player program.• Try a lower screen resolution or color depth.• Close any open files, and then restart the computer.
A DVD movie does not play.	<ul style="list-style-type: none">• Ensure that the disc surface is clean and not scratched.• Check the disc or package for regional coding. You might need to purchase a disc with coding for the region where you are using the computer.
No audio or only an intermittent audio comes out while a DVD movie is playing.	<ul style="list-style-type: none">• Check the volume control settings on the computer and on your speakers.• Ensure that the disc surface is clean and not scratched.• Check all cable connections to and from the speakers.• Use the DVD menu for the video to select a different audio track.
The playback is slow or choppy.	<ul style="list-style-type: none">• Disable any background programs, such as AntiVirus or Desktop Themes.• Ensure that video resolution is less than 1152 x 864 pixels.
A message indicating invalid disc or no disc found is displayed.	<ul style="list-style-type: none">• Ensure that the disc is in the drive with the shiny side of the disc facing down.• Ensure that video resolution is less than 1152 x 864 pixels.• Ensure that the DVD or CD is inserted into an appropriate optical drive. For example, do not insert a DVD into a CD-only drive.

Software problems

Problem	Solution
Some programs do not work as expected.	<ol style="list-style-type: none">1. Check whether the problem is caused by a program.<ol style="list-style-type: none">a. Ensure that the software is compatible with the computer. Refer to the information supplied with the software for more information.b. Verify that other software works correctly on the computer.c. Verify that the software you are using works on another computer.2. If the problem is caused by a program:<ul style="list-style-type: none">• Refer to the printed documentation that comes with the program or the help system of the program.• Update the program.• Uninstall the program and then reinstall it. To download a program that is preinstalled on your computer, go to https://support.lenovo.com and follow the on-screen instructions.

Recovery

This section introduces the recovery information of the Windows 10 operating system. Ensure that you read and follow the on-screen recovery instructions. The data on your computer might be deleted during the recovery process. To avoid data loss, make a backup copy of all the data that you want to keep.

Restore system files and settings to an earlier point

1. Go to Control Panel and view by large icons or small icons.
2. Click **Recovery** → **Open System Restore**. Then, follow the on-screen instructions.

Restore your files from a backup

Note: If you use the File History tool to restore your files from a backup, ensure that you backed up your data earlier with the tool.

1. Go to Control Panel and view by large icons or small icons.
2. Click **File History** → **Restore personal files**. Then, follow the on-screen instructions.

Reset your computer

In the resetting process, you can choose to keep your files or remove them when you reinstall the operating system.

Note: The items in the graphical user interface (GUI) might change without notice.

1. Open the Start menu, and then click **Settings** → **Update & Security** → **Recovery**.
2. In the **Reset this PC** section, click **Get started**.
3. Follow the on-screen instructions to reset your computer.

Use advanced options

1. Open the Start menu, and then click **Settings** → **Update & security** → **Recovery**.
2. In the **Advanced startup** section, click **Restart now** → **Troubleshoot** → **Advanced options**.
3. Select a preferred option from the following list, and then follow the on-screen instructions.

- Restore the Windows operating system from a restore point recorded on your computer
- Restore the Windows operating system from a specific system image
- Fix problems that prevent the Windows operating system from loading
- Use the Command Prompt for advanced troubleshooting
- Change the UEFI firmware settings on your computer
- Change the startup settings of the Windows operating system
- Go back to the previous build

Windows automatic recovery

Note: Ensure that your computer is connected to ac power during the recovery process.

The Windows recovery environment on your computer operates independently from the Windows 10 operating system. It enables you to recover or repair the operating system even if the Windows 10 operating system fails to start.

After two consecutive failed boot attempts, the Windows recovery environment starts automatically. Then, you can choose repair and recovery options by following the on-screen instructions.

Create and use a recovery USB device

It is recommended that you create a recovery USB drive as early as possible as a backup for the Windows recovery programs. With the recovery USB drive, you can troubleshoot and fix the problems even if the preinstalled Windows recovery programs are damaged.

Create a recovery USB drive

Attention: The creation process deletes anything stored on the USB drive. To avoid data loss, make a backup copy of all the data that you want to keep.

1. Ensure that your computer is connected to ac power.
2. Prepare a USB drive with at least 16 GB of storage capacity. The actual USB capacity required depends on the size of the recovery image.
3. Connect the prepared USB drive to the computer.
4. Type **recovery** in the search box. Then, click **Create a recovery drive**.
5. Click **Yes** in the User Account Control window to allow the Recovery Media Creator program to start.
6. In the Recovery Drive window, follow the on-screen instructions to create a recovery USB drive.

Use the recovery USB drive

If you cannot start your computer, go to Chapter 6 “Help and support” on page 41 first to try to solve the problem by yourself. If you still cannot start your computer, use the recovery USB drive to recover your computer.

1. Ensure that your computer is connected to ac power.
2. Connect the recovery USB drive to the computer.
3. Turn on or restart the computer. When the logo screen is displayed, press F12. The Boot Menu window opens.
4. Select the recovery USB drive as the boot device.
5. Click **Troubleshoot** to display optional recovery solutions.
6. Select a recovery solution as desired. Then, follow the on-screen instructions to complete the process.

Update the device driver

Attention: Reinstalling device drivers will change the current configuration of the computer.

You should download the latest driver for a component when you notice poor performance from that component or when you added a component. This action might eliminate the driver as the potential cause of a problem. Download and install the latest driver by one of the following methods:

- From Lenovo Vantage:
 1. Open the Start menu and click **Lenovo Vantage**.
 2. Click **System Update**. In the **Lenovo System Update** section, click **Check For Updates**. The available update packages are displayed and categorized by critical, recommended, or optional.
 3. Select the update packages you want and click **Install selected**. The update packages will be downloaded and installed automatically.
- From the Lenovo Support Web site:

Go to <https://support.lenovo.com> and select the entry for your computer. Then, follow the on-screen instructions to download and install necessary drivers and software.
- From Windows Update:

Note: The device drivers provided by Windows Update might not be tested by Lenovo. It is recommended that you get device drivers from Lenovo.

1. Open the Start menu.
2. Click **Settings → Update & Security → Windows Update**.
3. Follow the on-screen instructions.

Chapter 5. CRU replacement

What are CRUs

Customer Replaceable Units (CRUs) are parts that can be upgraded or replaced by the customer. Lenovo computers contain the following types of CRUs:

- **Self-service CRUs:** Refer to parts that can be installed or replaced easily by customer themselves or by trained service technicians at an additional cost.
- **Optional-service CRUs:** Refer to parts that can be installed or replaced by customers with a greater skill level. Trained service technicians can also provide service to install or replace the parts under the type of warranty designated for the customer's machine.

If you intend on installing the CRU, Lenovo will ship the CRU to you. CRU information and replacement instructions are shipped with your product and are available from Lenovo at any time upon request. You might be required to return the defective part that is replaced by the CRU. When return is required: (1) return instructions, a prepaid shipping label, and a container will be included with the replacement CRU; and (2) you might be charged for the replacement CRU if Lenovo does not receive the defective CRU within thirty (30) days of your receipt of the replacement CRU. For full details, see the Lenovo Limited Warranty documentation at:

https://www.lenovo.com/warranty/llw_02

Refer to the following CRU list for your computer.

Self-service CRUs

- Storage drive
- Storage drive bracket
- Hinge cover

Replace a CRU

Follow the replacement procedure to replace a CRU.

Storage drive

Prerequisite

Before you start, read Appendix A "Important safety information" on page 45 and print the following instructions.

Attention: The internal storage drive is sensitive. Inappropriate handling might cause damage and permanent loss of data. When handling the internal storage drive, observe the following guidelines:

- Replace the internal storage drive only for upgrade or repair. The internal storage drive is not designed for frequent changes or replacement.
- Before replacing the internal storage drive, make a backup copy of all the data that you want to keep.
- Do not touch the contact edge of the internal storage drive. Otherwise, the internal storage drive might get damaged.
- Do not apply pressure to the internal storage drive.

- Do not make the internal storage drive subject to physical shocks or vibration. Put the internal storage drive on a soft material, such as cloth, to absorb physical shocks.

Replacement procedure

1. Turn off the computer and remove all connected devices and cables.
2. Place a soft, clean towel or cloth on the desk or surface. Hold the sides of your computer and gently lay it down so that the computer cover is against the surface and the screen is facing up.
3. Push the latch to unlock the storage drive door.

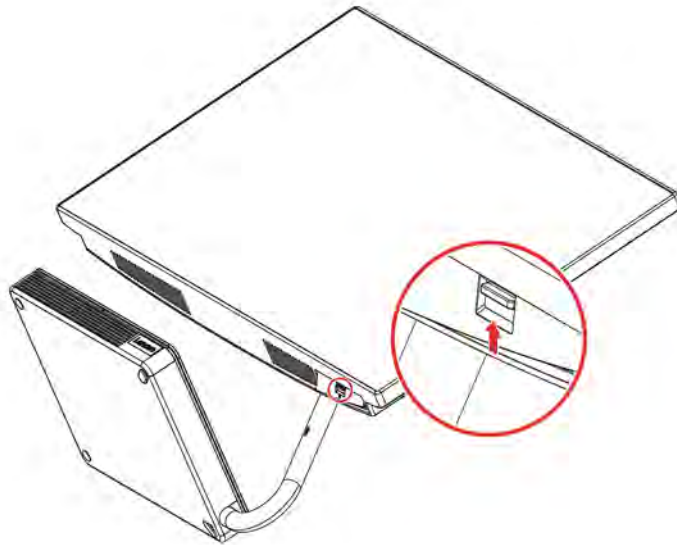

4. Pull the storage drive and the bracket out.



5. Remove the storage drive from the bracket.

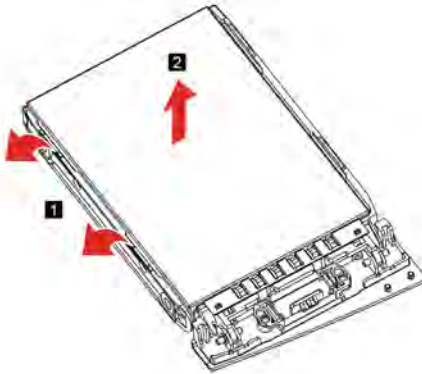

6. Install the storage drive into the bracket.

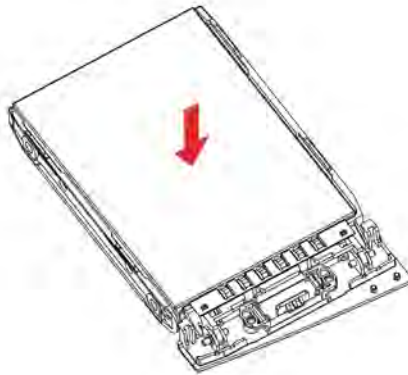

7. Install the storage drive and the bracket.

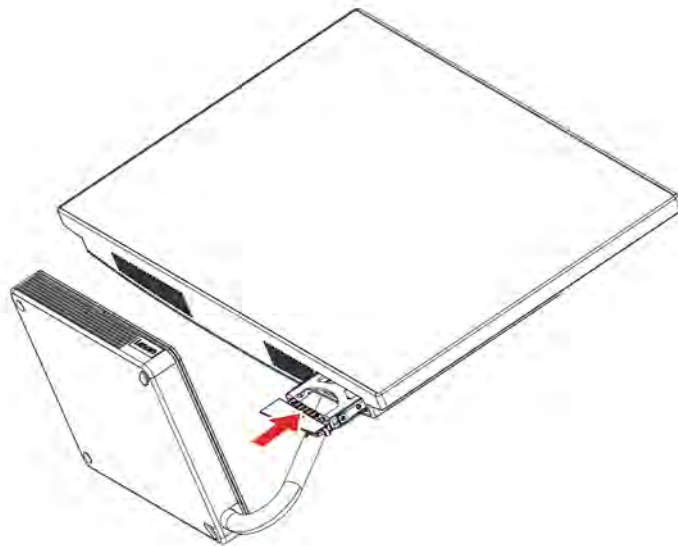

8. Lock the storage drive door.

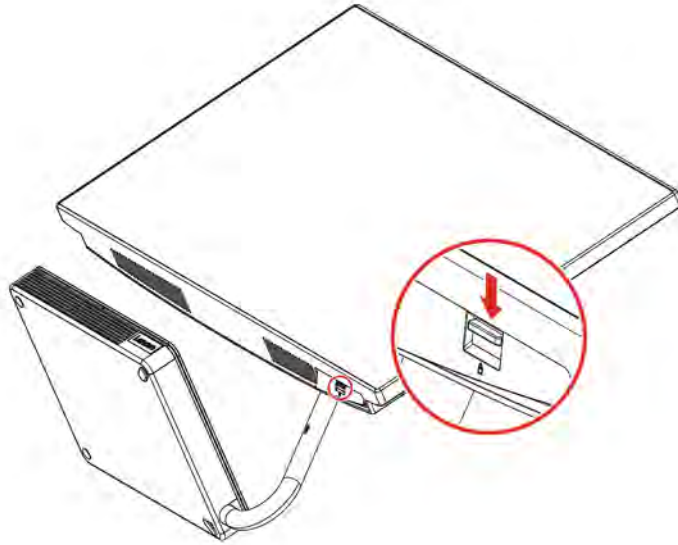

9. Place the computer in an upright position.
10. Reconnect the ac power adapter and all disconnected cables to the computer.

Hinge cover

Prerequisite

Before you start, read Appendix A “Important safety information” on page 45 and print the following instructions.



Before you open the hinge cover, turn off the computer and wait several minutes until the computer is cool.

Replacement procedure

1. Turn off the computer and remove all connected devices and cables.
2. Position the computer to see the rear side of the computer.
3. Slightly press the hinge cover sides.

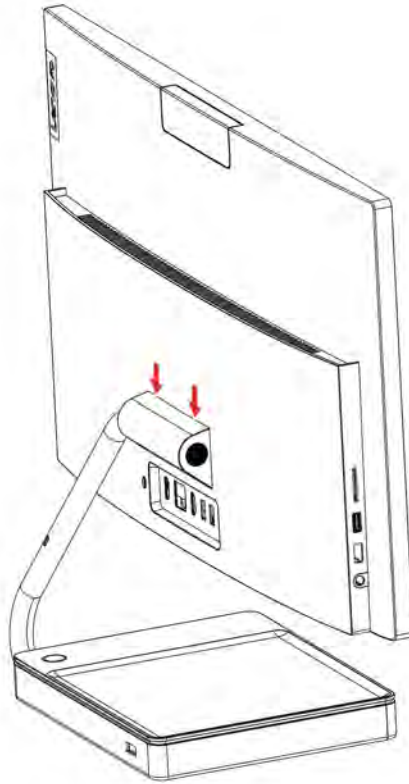

4. Remove the hinge cover.

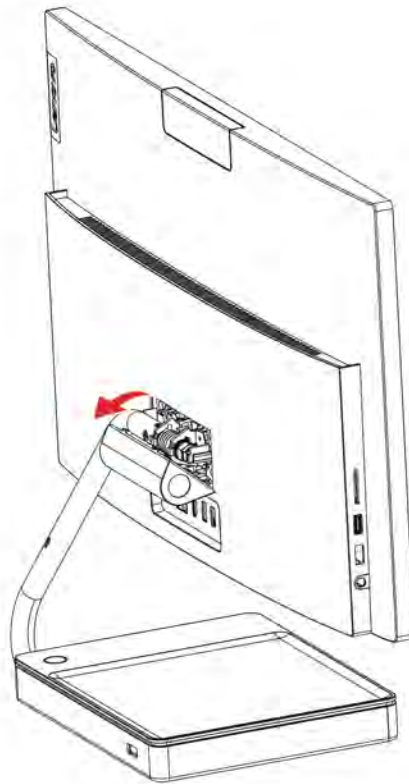

5. Install the hinge cover.

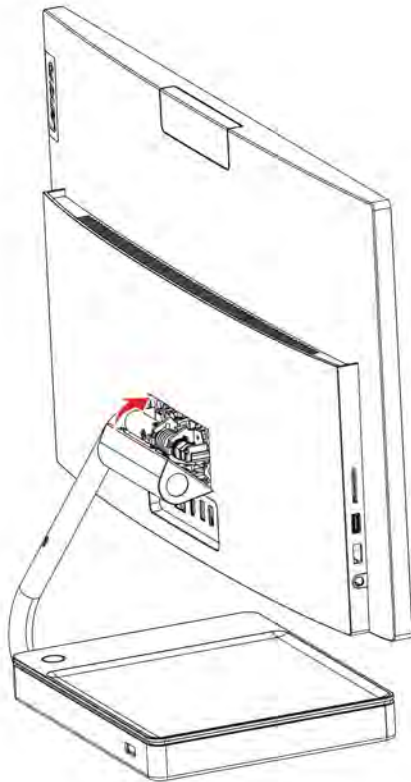

6. Slightly press the hinge cover sides until the it snaps into position.

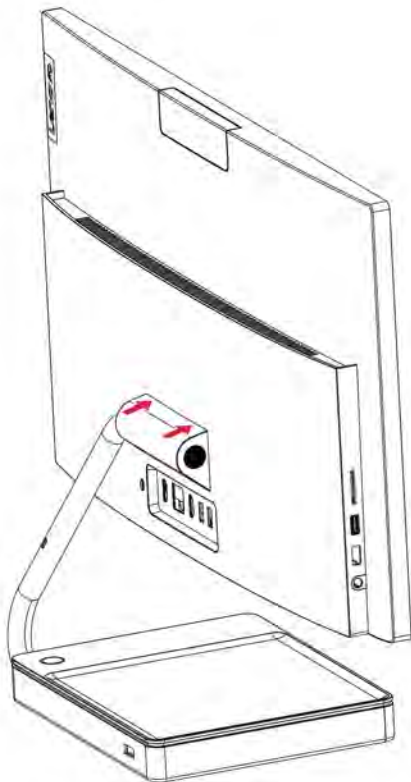

7. Reconnect the ac power adapter and all disconnected cables to the computer.

Chapter 6. Help and support

Self-help resources

Use the following self-help resources to learn more about the computer and troubleshoot problems.

Resources	How to access?
Use Lenovo Vantage to: <ul style="list-style-type: none">• Download and install the latest drivers and firmware.• Configure hardware settings.• Diagnose computer hardware problems.• Check the computer warranty status.• Protect your computer from malicious Wi-Fi networks.	<ul style="list-style-type: none">• Open the Start menu and click Lenovo Vantage.• Use Windows Search.
Product documentation: <ul style="list-style-type: none">• <i>Safety and Warranty Guide</i>• <i>Setup Guide</i>• <i>This User Guide</i>• <i>Regulatory Notice</i>	<ol style="list-style-type: none">1. Go to https://support.lenovo.com.2. Detect your computer or select computer model manually.3. Select Documentation and filter out the documentation you want.
Lenovo Support Web site with the latest support information of the following: <ul style="list-style-type: none">• Drivers and software• Diagnostic solutions• Product and service warranty• Product and parts details• Knowledge base and frequently asked questions	<p>https://support.lenovo.com</p>
Windows help information	<ul style="list-style-type: none">• Open the Start menu and click Get Help or Tips.• Use Windows Search or the Cortana® personal assistant.• Microsoft support Web site: https://support.microsoft.com

Call Lenovo

If you have tried to correct the problem yourself and still need help, you can call Lenovo Customer Support Center.

Before you contact Lenovo

Prepare the following before you contact Lenovo:

1. Record the problem symptoms and details:
 - What is the problem? Is it continuous or intermittent?
 - Any error message or error code?
 - What operating system are you using? Which version?
 - Which software applications were running at the time of the problem?
 - Can the problem be reproduced? If so, how?
2. Record the system information:
 - Product name
 - Machine type and serial number

The following illustration shows where to find the machine type and serial number of your computer.

- For A540 27-inch models and A540 24-inch (with 3-sides borderless panel) models:



- For A540 24-inch (with 4-sides borderless panel) models:



Lenovo Customer Support Center

During the warranty period, you can call Lenovo Customer Support Center for help.

Telephone numbers

For a list of the Lenovo Support phone numbers for your country or region, go to:

<https://pcsupport.lenovo.com/supportphonenumberlist>

Note: Phone numbers are subject to change without notice. If the number for your country or region is not provided, contact your Lenovo reseller or Lenovo marketing representative.

Services available during the warranty period

- Problem determination - Trained personnel are available to assist you with determining if you have a hardware problem and deciding what action is necessary to fix the problem.
- Lenovo hardware repair - If the problem is determined to be caused by Lenovo hardware under warranty, trained service personnel are available to provide the applicable level of service.
- Engineering change management - Occasionally, there might be changes that are required after a product has been sold. Lenovo or your reseller, if authorized by Lenovo, will make selected Engineering Changes (ECs) that apply to your hardware available.

Services not covered

- Replacement or use of parts not manufactured for or by Lenovo or nonwarranted parts
- Identification of software problem sources
- Configuration of UEFI BIOS as part of an installation or upgrade
- Changes, modifications, or upgrades to device drivers
- Installation and maintenance of network operating systems (NOS)
- Installation and maintenance of programs

For the terms and conditions of the Lenovo Limited Warranty that apply to your Lenovo hardware product, see “Warranty information” in the *Safety and Warranty Guide* that comes with your computer.

Purchase additional services

During and after the warranty period, you can purchase additional services from Lenovo at:

<https://www.lenovo.com/services>

Service availability and service name might vary by country or region.

Appendix A. Important safety information

Safety notices

This information can help you safely use your computer. Follow and retain all information included with your computer. The information in this document does not alter the terms of your purchase agreement or the Limited Warranty. For more information, see "Warranty Information" in the *Safety and Warranty Guide* that comes with your computer.

Customer safety is important. Our products are developed to be safe and effective. However, personal computers are electronic devices. Power cords, power adapters, and other features can create potential safety risks that can result in physical injury or property damage, especially if misused. To reduce these risks, follow the instructions included with your product, observe all warnings on the product and in the operating instructions, and review the information included in this document carefully. By carefully following the information contained in this document and provided with your product, you can help protect yourself from hazards and create a safer computer work environment.

Note: This information includes references to power adapters and batteries. In addition, some products (such as speakers and monitors) ship with external power adapters. If you have such a product, this information applies to your product. In addition, computer products contain a coin-sized internal battery that provides power to the system clock even when the computer is unplugged, so the battery safety information applies to all computer products.

Conditions that require immediate action

Products can become damaged due to misuse or neglect. Some product damage is serious enough that the product should not be used again until it has been inspected and, if necessary, repaired by an authorized servicer.

As with any electronic device, pay close attention to the product when it is turned on.

On very rare occasions, you might notice an odor or see a puff of smoke or sparks vent from your product. Or you might hear sounds like popping, cracking, or hissing. These might merely mean that an internal electronic component has failed in a safe and controlled manner. Or, they might indicate a potential safety issue. Do not take risks or attempt to diagnose the situation yourself. Contact the Customer Support Center for further guidance. For a list of Service and Support phone numbers, see the following Web site:

<https://pcsupport.lenovo.com/supportphonenumberlist>

Frequently inspect your computer and its components for damage or wear or signs of danger. If you have any question about the condition of a component, do not use the product. Contact the Customer Support Center or the product manufacturer for instructions on how to inspect the product and have it repaired, if necessary.

In the unlikely event that you notice any of the following conditions, or if you have any safety concerns with your product, stop using the product and unplug it from the power source and telecommunication lines until you can speak to the Customer Support Center for further guidance.

- Power cords, plugs, power adapters, extension cords, surge protectors, or power supplies that are cracked, broken, or damaged.
- Signs of overheating, smoke, sparks, or fire.

- Damage to a battery (such as cracks, dents, or creases), discharge from a battery, or a buildup of foreign substances on the battery.
- A cracking, hissing, or popping sound, or strong odor that comes from the product.
- Signs that liquid has been spilled or an object has fallen onto the computer product, the power cord, or power adapter.
- The computer product, power cord, or power adapter has been exposed to water.
- The product has been dropped or damaged in any way.
- The product does not operate normally when you follow the operating instructions.

Note: If you notice these conditions with a product (such as an extension cord) that is not manufactured for or by Lenovo, stop using that product until you can contact the product manufacturer for further instructions, or until you get a suitable replacement.

Service and upgrades

Do not attempt to service a product yourself unless instructed to do so by the Customer Support Center or your documentation. Only use a Service Provider who is approved to repair your particular product.

Note: Some computer parts can be upgraded or replaced by the customer. Upgrades typically are referred to as options. Replacement parts approved for customer installation are referred to as Customer Replaceable Units, or CRUs. Lenovo provides documentation with instructions when it is appropriate for customers to install options or replace CRUs. You must closely follow all instructions when installing or replacing parts. The Off state of a power indicator does not necessarily mean that voltage levels inside a product are zero. Before you remove the covers from a product equipped with a power cord, always ensure that the power is turned off and that the product is unplugged from any power source. If you have any questions or concerns, contact the Customer Support Center.

Although there are no moving parts in the computer after the power cord has been disconnected, the following warnings are required for your safety.



Moving Parts:

Keep fingers and other parts of your body away from hazardous, moving parts. If you suffer an injury, seek medical care immediately.



Hot Surface:

Avoid contact with hot components inside the computer. During operation, some components become hot enough to burn the skin. Before you open the computer cover, turn off the computer, disconnect power, and wait approximately 10 minutes for the components to cool.



After replacing a CRU, reinstall all protective covers, including the computer cover, before connecting power and operating the computer. This action is important to help prevent unexpected electrical shock and help ensure the containment of an unexpected fire that could happen under extremely rare conditions.



Sharp Edges:

When replacing CRUs, be cautious of sharp edges or corners that might cause injury. If you suffer an injury, seek medical care immediately.

Power cords and power adapters



DANGER

Use only the power cords and power adapters supplied by the product manufacturer.

The power cords shall be safety approved. For Germany, it shall be H03VV-F, 3G, 0.75 mm², or better. For other countries, the suitable types shall be used accordingly.

Never wrap a power cord around a power adapter or other object. Doing so can stress the cord in ways that can cause the cord to fray, crack, or crimp. This can present a safety hazard.

Always route power cords so that they will not be walked on, tripped over, or pinched by objects.

Protect power cords and power adapters from liquids. For instance, do not leave your power cord or power adapter near sinks, tubs, toilets, or on floors that are cleaned with liquid cleansers. Liquids can cause a short circuit, particularly if the power cord or power adapter has been stressed by misuse. Liquids also can cause gradual corrosion of power cord terminals and/or the connector terminals on a power adapter, which can eventually result in overheating.

Ensure that all power cord connectors are securely and completely plugged into receptacles.

Do not use any power adapter that shows corrosion at the ac input pins or shows signs of overheating (such as deformed plastic) at the ac input pins or anywhere on the power adapter.

Do not use any power cords where the electrical contacts on either end show signs of corrosion or overheating or where the power cord appears to have been damaged in any way.

To prevent possible overheating, do not cover the power adapter with clothing or other objects when the power adapter is plugged into an electrical outlet.

Power cord notice

Note: The power cord and adapter provided with this product are intended to be used with this product only. Do not use them with any other products.

For your safety, Lenovo provides a power cord with a grounded attachment plug to use with this product. To avoid electrical shock, always use the power cord and plug with a properly grounded outlet.

Power cords provided by Lenovo in the United States and Canada are listed by Underwriter's Laboratories (UL) and certified by the Canadian Standards Association (CSA).

For units intended to be operated at 115 volts: Use a UL-listed and CSA-certified cord set consisting of a minimum 18 AWG, Type SVT or SJT, three-conductor cord, a maximum of 15 feet in length and a parallel blade, grounding-type attachment plug rated 10 amperes, 125 volts.

For units intended to be operated at 230 volts (U.S. use): Use a UL-listed and CSA-certified cord set consisting of a minimum 18 AWG, Type SVT or SJT, three-conductor cord, a maximum of 15 feet in length and a tandem blade, grounding-type attachment plug rated 10 amperes, 250 volts.

For units intended to be operated at 230 volts (outside the U.S.): Use a cord set with a grounding-type attachment plug. The cord set should have the appropriate safety approvals for the country in which the equipment will be installed.

Power cords provided by Lenovo for a specific country or region are usually available only in that country or region.

For units intended to be operated in Germany: The power cords must be safety approved. For Germany, it must be H05VV-F, 3G, 0.75 mm², or better. For other countries, the suitable types must be used accordingly.

For units intended to be operated in Denmark: Use a cord set with a grounding-type attachment plug. The cord set should have the appropriate safety approvals for the country in which the equipment will be installed.

For units intended to be operated in Norway, Sweden, Finland: Use a cord set with a two-prong attachment plug. The cord set should have the appropriate safety approvals for the country in which the equipment will be installed.

If you intend to use your PC in a country or region that is different from your ordering location, please purchase an additional Lenovo power cord for the country or region where the PC will be used. Refer to the power cord guide provided in our Web site, <https://support.lenovo.com>, for details. Some countries and regions support multiple voltages, so make sure you order the appropriate power cord for the intended voltage.

Extension cords and related devices

Ensure that extension cords, surge protectors, uninterruptible power supplies, and power strips that you use are rated to handle the electrical requirements of the product. Never overload these devices. If power strips are used, the load should not exceed the power strip input rating. Consult an electrician for more information if you have questions about power loads, power requirements, and input ratings.

Plugs and outlets



If a receptacle (power outlet) that you intend to use with your computer equipment appears to be damaged or corroded, do not use the outlet until it is replaced by a qualified electrician.

Do not bend or modify the plug. If the plug is damaged, contact the manufacturer to obtain a replacement.

Do not share an electrical outlet with other home or commercial appliances that draw large amounts of electricity; otherwise, unstable voltage might damage your computer, data, or attached devices.

Some products are equipped with a three-pronged plug. This plug fits only into a grounded electrical outlet. This is a safety feature. Do not defeat this safety feature by trying to insert it into a non-grounded outlet. If you cannot insert the plug into the outlet, contact an electrician for an approved outlet adapter or to replace the outlet with one that enables this safety feature. Never overload an electrical outlet. The overall system load should not exceed 80 percent of the branch circuit rating. Consult an electrician for more information if you have questions about power loads and branch circuit ratings.

Be sure that the power outlet you are using is properly wired, easily accessible, and located close to the equipment. Do not fully extend power cords in a way that will stress the cords.

Be sure that the power outlet provides the correct voltage and current for the product you are installing.

Carefully connect and disconnect the equipment from the electrical outlet.

Power supply statement

Never remove the cover on a power supply or any part that has the following label attached.



Hazardous voltage, current, and energy levels are present inside any component that has this label attached. There are no serviceable parts inside these components. If you suspect a problem with one of these parts, contact a service technician.

External devices

CAUTION:

Do not connect or disconnect any external device cables other than Universal Serial Bus (USB) and 1394 cables while the computer power is on; otherwise, you might damage your computer. To avoid possible damage to attached devices, wait at least five seconds after the computer is shut down to disconnect external devices.

Lithium coin-cell battery notice



Danger of explosion if battery is incorrectly replaced.

If the coin-cell battery is not a CRU, do not attempt to replace the coin-cell battery. Replacement of the battery must be done by a Lenovo-authorized repair facility or technician.

The Lenovo-authorized repair facilities or technicians recycle Lenovo batteries according to local laws and regulations.



When replacing the lithium coin-cell battery, use only the same type or equivalent type that is recommended by the manufacturer. The battery contains lithium and can explode if not properly used, handled, or disposed of. Swallowing the lithium coin-cell battery will cause choking or severe internal burns in just two hours and might even result in death.

Keep batteries away from children. If the lithium coin-cell battery is swallowed or placed inside any part of the body, seek medical care immediately.

Do not:

- Throw or immerse into water
- Heat to more than 100 °C (212°F)
- Repair or disassemble
- Leave in an extremely low air pressure environment
- Leave in an extremely high-temperature environment
- Crush, puncture, cut, or incinerate

Dispose of the battery as required by local ordinances or regulations.

The following statement applies to users in the state of California, U.S.A.

California Perchlorate Information:

Products containing manganese dioxide lithium coin-cell batteries may contain perchlorate.

Perchlorate Material - special handling may apply, see <https://www.dtsc.ca.gov/hazardouswaste/perchlorate/>.

Heat and product ventilation



Computers, power adapters, and many accessories can generate heat when turned on and when batteries are charging. Always follow these basic precautions:

- Do not leave your computer, power adapter, or accessories in contact with your lap or any part of your body for an extended period when the products are functioning or when the battery is charging. Your

computer, power adapter, and many accessories produce some heat during normal operation. Extended contact with the body could cause discomfort or, potentially, a skin burn.

- Do not charge the battery or operate your computer, power adapter, or accessories near flammable materials or in explosive environments.
- Ventilation slots, fans, and heat sinks are provided with the product for safety, comfort, and reliable operation. These features might inadvertently become blocked by placing the product on a bed, sofa, carpet, or other flexible surface. Never block, cover, or disable these features.

Inspect your desktop computer for dust accumulation at least once every three months. Before inspecting your computer, turn off the power and unplug the computer's power cord from the electrical outlet; then remove any dust from vents and perforations in the bezel. If you notice external dust accumulation, then examine and remove dust from the inside of the computer including heat sink inlet fins, power supply vents, and fans. Always turn off and unplug the computer before opening the cover. If possible, avoid operating your computer within two feet of high-traffic areas. If you must operate your computer in or near a high-traffic area, inspect and, if necessary, clean your computer more frequently.

For your safety and to maintain optimum computer performance, always follow these basic precautions with your desktop computer:

- Keep the cover closed whenever the computer is plugged in.
- Regularly inspect the outside of the computer for dust accumulation.
- Remove dust from vents and any perforations in the bezel. More frequent cleanings might be required for computers in dusty or high-traffic areas.
- Do not restrict or block any ventilation openings.
- Do not store or operate your computer inside furniture, as this might increase the risk of overheating.
- Airflow temperatures into the computer should not exceed 35°C (95°F).
- Do not install air filtration devices. They may interfere with proper cooling.

Electrical current safety information



Electric current from power, telephone, and communication cables is hazardous.

To avoid a shock hazard:

- **Do not use your computer during a lightning storm.**
- **Do not connect or disconnect any cables or perform installation, maintenance, or reconfiguration of this product during an electrical storm.**
- **Connect all power cords to a properly wired and grounded electrical outlet.**
- **Connect properly wired outlets to any equipment that will be attached to this product.**
- **Whenever possible, use one hand only to connect or disconnect signal cables.**
- **Never turn on any equipment when there is evidence of fire, water, or structural damage.**
- **Disconnect the attached power cords, battery, and all the cables before you open the device covers, unless instructed otherwise in the installation and configuration procedures.**
- **Do not use your computer until all internal parts enclosures are fastened into place. Never use the computer when internal parts and circuits are exposed.**

 **DANGER**

Connect and disconnect cables as described in the following procedures when installing, moving, or opening covers on this product or attached devices.

To connect:

1. Turn everything **OFF**.
2. First, attach all cables to devices.
3. Attach signal cables to connectors.
4. Attach power cords to outlets.
5. Turn devices **ON**.

To disconnect:

1. Turn everything **OFF**.
2. First, remove power cords from outlets.
3. Remove signal cables from connectors.
4. Remove all cables from devices.

The power cord must be disconnected from the wall outlet or receptacle before installing all other electrical cables connected to the computer.

The power cord may be reconnected to the wall outlet or receptacle only after all other electrical cables have been connected to the computer.

 **DANGER**

During electrical storms, do not perform any replacement and do not connect the telephone cable to or disconnect it from the telephone outlet on the wall.

Laser safety information

CAUTION:

When laser products (such as CD-ROMs, DVD drives, fiber optic devices, or transmitters) are installed, note the following:

- Do not remove the covers. Removing the covers of the laser product could result in exposure to hazardous laser radiation. There are no serviceable parts inside the device.
- Use of controls or adjustments or performance of procedures other than those specified herein might result in hazardous radiation exposure.

 **DANGER**

Some laser products contain an embedded Class 3B laser diode. Note the following:
Laser radiation when open. Do not stare into the beam, do not view directly with optical instruments, and avoid direct exposure to the beam.

Liquid crystal display (LCD) notice



To avoid shock hazards:

- Do not remove the covers.
- Do not operate this product unless the stand is attached.
- Do not connect or disconnect this product during an electrical storm.
- The power cord plug must be connected to a properly wired and grounded power outlet.
- Any equipment to which this product will be attached must also be connected to properly wired and grounded power outlets.
- To isolate the monitor from the electrical supply, you must remove the plug from the power outlet. The power outlet should be easily accessible.

Handling:

- If your monitor weighs more than 18 kg (39.68 lb), we recommend that it be moved or lifted by two people.

Product disposal (TFT monitors):

- The fluorescent lamp in the liquid crystal display contains mercury; dispose according to local, state, or federal laws.

Battery warnings:

- Risk of explosion if battery is replaced by an incorrect type.
- Dispose of used batteries according to the instructions.

Use earphones, headphones, or a headset

- If your computer has both a headphone connector and an audio line-out connector, always use the headphone connector for earphones, headphones, or a headset. However, the headphone connector does not support the microphone of the headset.
- If your computer has both a headset connector and an audio line-out connector, always use the headset connector for earphones, headphones, or a headset.



Excessive sound pressure from earphones and headphones can cause hearing loss. Adjustment of the equalizer to maximum increases the earphone and headphone output voltage and the sound pressure level. Therefore, to protect your hearing, adjust the equalizer to an appropriate level.

Excessive use of headphones or earphones for a long period of time at high volume can be dangerous if the output of the headphone or earphone connectors do not comply with specifications of EN 50332-2. The headphone output connector of your computer complies with EN 50332-2 Sub clause 7. This specification limits the computer's maximum wide band true RMS output voltage to 150 mV. To help protect against hearing loss, ensure that the headphones or earphones you use also comply with EN 50332-2 (Clause 7

Limits) or a wide band characteristic voltage of 75 mV. Using headphones that do not comply with EN 50332-2 can be dangerous due to excessive sound pressure levels.

If your Lenovo computer came with headphones or earphones in the package, as a set, the combination of the headphones or earphones and the computer already complies with the specifications of EN 50332-1. If different headphones or earphones are used, ensure that they comply with EN 50332-1 (Clause 6.5 Limitation Values). Using headphones that do not comply with EN 50332-1 can be dangerous due to excessive sound pressure levels.

Choking hazard notice



CHOKING HAZARD – Product contains small parts.

Keep away from children under three years.

Plastic bag notice



Plastic bags can be dangerous. Keep plastic bags away from babies and children to avoid danger of suffocation.

Glass parts notice

CAUTION:

Some parts of your product may be made of glass. This glass could break if the product is dropped on a hard surface or receives a substantial impact. If glass breaks, do not touch or attempt to remove it. Stop using your product until the glass is replaced by trained service personnel.

Computer placement notices

Inappropriate computer placement might cause harm to children.

- Place the computer on a sturdy piece of low-rise furniture or furniture that has been anchored.
- Do not place the computer at the edge of the furniture.
- Keep the computer cables out of the reach of children.
- Some items, such as toys, might attract children. Keep such items away from the computer.

Supervise children in rooms where the above safety instructions cannot be fully implemented.

Hazardous energy statement



Disconnect all power cords from electrical outlets before removing the computer cover or any part that has the above label attached.

DO NOT disassemble components that have the above label attached. There are no serviceable parts inside these components.

Your product is designed for safe use. However, hazardous voltage, current, and energy levels are present inside any component that has this label attached. Disassembling of these components might cause fire or might even result in death. If you suspect a problem with one of these parts, contact a service technician.

CAUTION:



Bright Light, possible skin or eye damage. Disconnect power before servicing.

CAUTION:



Infrared Light, possible skin or eye damage. Disconnect power before servicing.

Eye comfort

The property of the display in combination with following notes result in reduced eye fatigue and increased comfort.

For tips on how to minimize visual fatigue, please go to <https://www.lenovo.com/us/en/safecomp/> to visit “Minimizing Visual Fatigue”.

Tip-over hazard prevention notice

The computer may cause harm to children if it is not located in an appropriate place. Follow the tips below to protect children from harm caused by the computer tipping over:

- Place the computers or monitors on sturdy furniture with a low base or furniture that has been anchored. Push the computers or monitors as far from the edge of the furniture as possible..
- Keep remote controls, toys, and other items that might attract children away from the computers or monitors
- Keep the computer or monitor cables out the reach of the children.
- Supervise children in rooms where these safety tips have not been followed.

CAUTION:

Some parts of your product may be made of glass. This glass could break if the product is dropped on a hard surface or receives a substantial impact. If glass breaks, do not touch it or attempt to remove it. Stop using your product until the glass is replaced by trained service personnel.

Remote control

CAUTION:

Do not use rechargeable batteries in this device.

Static electricity prevention

Static electricity, although harmless to you, can seriously damage computer components and options. Improper handling of static-sensitive parts can damage the part. When you unpack an option or CRU, do not open the static-protective package containing the part until the instructions direct you to install it.

When you handle options or CRUs, or perform any work inside the computer, take the following precautions to avoid static-electricity damage:

- Limit your movement. Movement can cause static electricity to build up around you.
 - Always handle components carefully. Handle adapters, memory modules, and other circuit boards by the edges. Never touch exposed circuitry.
 - Prevent others from touching components.
 - When you install a static-sensitive option or CRU, touch the static-protective package containing the part to a metal expansion-slot cover or other unpainted metal surface on the computer for at least two seconds. This reduces static electricity in the package and your body.
 - When possible, remove the static-sensitive part from the static-protective packaging and install the part without setting it down. When this is not possible, place the static-protective packaging on a smooth, level surface and place the part on it.
 - Do not place the part on the computer cover or other metal surface.
-

Operating environment

Temperature

- Operating: From 10°C (50°F) to 35°C (95°F)
- Storage or transportation:
 - For common desktop computers: From -40°C (-40°F) to 55°C (131°F)
 - For all-in-one desktop computers: From -20°C (-4°F) to 55°C (131°F)

Note: If your computer is stored or transported in temperatures less than 10°C (50°F), allow the computer to rise slowly to an optimal operating temperature before use. This process might take up to two hours. Using the computer in a lower operating temperature might result in irreparable damage to your computer.

Relative humidity

- Operating: 35%-80% (non-condensing)
- Storage: 20%–93% (non-condensing)

Atmospheric pressure

86 kPa to 106 kPa

Cleaning and maintenance

With appropriate care and maintenance, your computer will serve you reliably. The following topics offer information to help you keep your computer working with best performance.

Basic maintenance tips

Here are some basic points about keeping your computer functioning properly:

- Keep the computer in a clean, dry environment. Ensure that the computer rests on a flat, steady surface.
- Do not cover any of air vents. These air vents provide airflow to keep the computer from overheating.
- Keep electrical appliances such as an electric fan, radio, high-powered speakers, air conditioner, and microwave oven away from your computer because the strong magnetic fields generated by these appliances can damage the monitor and data on the storage drive.
- Keep food and drinks away from all parts of the computer. Food particles and spills might make the keyboard and mouse stick and unusable.
- Do not get the power switches or other controls wet. Moisture can damage these parts and cause an electrical hazard.
- Always disconnect a power cord by grasping the plug instead of the cord.
- Keep the computer software, device drivers, and operating system up-to-date.
- Empty your recycle bin on a regular basis.
- Clean out your Inbox, Sent Items, and Deleted Items folders in your e-mail application on a regular basis.
- Clean up files and free up storage drive space and memory space occasionally to prevent performance problems.
- Keep a log book. Entries might include major software or hardware changes, device-driver updates, intermittent problems and what you did to resolve them, and other issues you might have experienced. The cause of a problem might be change in hardware, change in software, or any other actions that might have taken place. A log book can help you or a Lenovo technician determine the cause of a problem.
- Back up your data on the storage drive regularly. You can restore the storage drive from a backup.
- Create a recovery medium as early as possible. You can use the recovery medium to recover your operating system even if Windows fails to start up.
- Get the most up-to-date operating system update patches, software programs, and device drivers.

Maintenance tips about moving the computer

Before moving the computer, take the following precautions:

1. Back up your data on the storage drive.
2. Remove any media from the drives and turn off all connected devices and the computer. Then, disconnect all power cords from electrical outlets and disconnect all cables that are connected to the computer.
3. If you saved the original shipping cartons and packing materials, use them to pack the units. If you are using different cartons, cushion the units to avoid damage.

When you move the computer to another country or region, you must take local electrical standards into consideration. If the local electrical outlet style is different from the type you are currently using, contact the Lenovo Customer Support Center to purchase either an electrical plug adapter or a new power cord.

Clean your computer

CAUTION:

Remove any media from the drives and turn off all connected devices and the computer. Then, disconnect all power cords from electrical outlets and disconnect all cables that are connected to the computer.

It is a good practice to clean your computer periodically to protect the surfaces and ensure trouble-free operation.

Clean the computer surface: Wipe it with a lint-free cloth dampened in mild soap and water. Avoid applying liquids directly to the surface.

Clean the keyboard: Wipe the keys one by one with a lint-free cloth dampened in mild soap and water. If you wipe several keys at a time, the cloth might hook onto an adjacent key and possibly damage it. Avoid spraying cleaner directly onto the keyboard. To remove any crumbs or dust from beneath the keys, you can use a camera blower with a brush or use cool air from a hair dryer.

Clean the computer screen: Scratches, oil, dust, chemicals, and ultraviolet light can affect the performance of your computer screen. Use a dry, soft lint-free cloth to wipe the screen gently. If you see a scratchlike mark on your screen, it might be a stain. Wipe or dust the stain gently with a soft, dry cloth. If the stain remains, moisten a soft, lint-free cloth with water or eyeglass cleaner, but do not apply liquids directly to your computer screen. Ensure that the computer screen is dry before closing it.

Appendix B. Accessibility and ergonomic information

This chapter provides information about accessibility and ergonomics.

Accessibility information

Lenovo is committed to providing users who have hearing, vision, and mobility limitations with greater access to information and technology. This section provides information about the ways these users can get the most out of their computer experience. You also can get the most up-to-date accessibility information from the following Web site:

<https://www.lenovo.com/accessibility>

Keyboard shortcuts

The following list contains keyboard shortcuts that can help make your computer easier to use.

Note: Depending on your keyboard, some of the following keyboard shortcuts might not be available.

- **Windows logo key + U:** Open Ease of Access Center
- **Right Shift for eight seconds:** Turn on or turn off Filter Keys
- **Shift five times:** Turn on or turn off Sticky Keys
- **Num Lock for five seconds:** Turn on or turn off Toggle Keys
- **Left Alt+Left Shift+Num Lock:** Turn on or turn off Mouse Keys
- **Left Alt+Left Shift+PrtScn (or PrtSc):** Turn on or turn off High Contrast

For more information, go to <https://windows.microsoft.com>, and then search using any of the following keywords: keyboard shortcuts, key combinations, shortcut keys.

Ease of Access Center

Ease of Access Center on the Windows operating system enables you to configure your computers to suit their physical and cognitive needs.

To access Ease of Access Center:

1. Go to Control Panel and view by Category.
2. Click **Ease of Access → Ease of Access Center**.
3. Choose the appropriate tool by following the on-screen instructions.

Ease of Access Center mainly includes the following tools:

- **Magnifier**
Magnifier is a useful utility that enlarges the entire screen or part of the screen so that you can see the items better.
- **Narrator**
Narrator is a screen reader that reads what is displayed on the screen aloud and describes events such as error messages.
- **On-Screen Keyboard**
If you prefer to type or enter data into your computer using a mouse, joystick, or other pointing device instead of a physical keyboard, you can use On-Screen Keyboard. On-Screen Keyboard displays a visual

keyboard with all the standard keys. You can select keys using the mouse or another pointing device, or you can tap to select the keys if your computer supports multi-touch screen.

- **High Contrast**

High Contrast is a feature that heightens the color contrast of some text and images on your screen. As a result, those items are more distinct and easier to identify.

- **Personalized keyboard**

Adjust keyboard settings to make your keyboard easier to use. For example, you can use your keyboard to control the pointer and make the keyboard easier to type certain key combinations.

- **Personalized mouse**

Adjust mouse settings to make your mouse easier to use. For example, you can change the pointer appearance and make your mouse easier to manage windows.

Speech Recognition

Speech Recognition enables you to control your computer by voice.

You can use verbal instructions to control the keyboard and mouse. With verbal instructions, you can start programs, open menus, click objects on the screen, dictate text into documents, and write and send e-mails.

To use Speech Recognition:

1. Go to Control Panel and view by Category.
2. Click **Ease of Access → Speech Recognition**.
3. Follow the on-screen instructions.

Screen-reader technologies

Screen-reader technologies are primarily focused on software program interfaces, help systems, and various online documents. For additional information about screen readers, see the following:

- Use PDFs with screen readers:
<https://www.adobe.com/accessibility.html?promoid=DJGVE>
- Use the JAWS screen reader:
<https://www.freedomscientific.com/Products/Blindness/JAWS>
- Use the NVDA screen reader:
<https://www.nvaccess.org/>

Screen resolution

You can make the text and images on your screen easier to read by adjusting the screen resolution of your computer.

To adjust the screen resolution:

1. Right-click an empty area of the desktop and then click **Display settings → Display**.
2. Follow the on-screen instructions.

Note: Setting a resolution too low might prevent some items from fitting on the screen.

Customizable item size

You can make the items on your screen easier to read by changing the item size.

- To change the item size temporarily, use the Magnifier tool in Ease of Access Center.
- To change the item size permanently:

- Change the size of all the items on your screen.
 1. Right-click an empty area of the desktop and then click **Display settings → Display**.
 2. Change the item size by following the on-screen instructions. For some applications, your configuration might not take effect until you sign out and then sign in again.
- Change the size of the items on a Web page.

Press and hold Ctrl, and then press the plus-sign key (+) to enlarge or the minus-sign key (–) to reduce the text size.
- Change the size of the items on the desktop or a window.

Note: This function might not work on some windows.

If your mouse has a wheel, press and hold Ctrl, and then scroll the wheel to change the item size.

Industry-standard connectors

Your computer provides industry-standard connectors that enable you to connect assistive devices.

Documentation in accessible formats

Lenovo provides electronic documentation in accessible formats, such as properly tagged PDF files or HyperText Markup Language (HTML) files. Lenovo electronic documentation is developed to ensure that visually impaired users can read the documentation through a screen reader. Each image in the documentation also includes adequate alternative text so that visually impaired users can understand the image when they use a screen reader.

Ergonomic information

Good ergonomic practice is important to get the most from your personal computer and to avoid discomfort. Arrange your workplace and the equipment you use to suit your individual needs and the kind of work that you perform. In addition, use healthy work habits to maximize your performance and comfort when using your computer.

Working in the virtual office might mean adapting to frequent changes in your environment. Adapting to the surrounding light sources, active seating, and the placement of your computer hardware, can help you improve your performance and achieve greater comfort.

This example shows someone in a conventional setting. Even when not in such a setting, you can follow many of these tips. Develop good habits, and they will serve you well.



General posture: Make minor modifications in your working posture to deter the onset of discomfort caused by long periods of working in the same position. Frequent short breaks from your work also help to prevent minor discomfort associated with your working posture.

Display: Position the display to maintain a comfortable viewing distance of 510 mm to 760 mm (20 inches to 30 inches). Avoid glare or reflections on the display from overhead lighting or outside sources of light. Keep the display screen clean and set the brightness to levels that enable you to see the screen clearly. Press the brightness control keys to adjust display brightness.

Head position: Keep your head and neck in a comfortable and neutral (vertical, or upright) position.

Chair: Use a chair that gives you good back support and seat height adjustment. Use chair adjustments to best suit your comfort posture.

Arm and hand position: If available, use chair arm rests or an area on your working surface to provide weight support for your arms. Keep your forearms, wrists, and hands in a relaxed and neutral (horizontal) position. Type with a soft touch without pounding the keys.

Leg position: Keep your thighs parallel to the floor and your feet flat on the floor or on a footrest.

Appendix C. Compliance information

This chapter provides regulatory, environmental, RoHS, and ENERGY STAR information about Lenovo products.

Radio frequency compliance statements

Computer models equipped with wireless communications comply with the radio frequency and safety standards of any country or region in which it has been approved for wireless use.

Besides this document, ensure that you read the *Regulatory Notice* for your country or region before using the wireless devices contained in your computer.

Locate wireless regulatory notices

For more information about the wireless regulatory notices, refer to the *Regulatory Notice* at: <https://support.lenovo.com>

European Union-compliance with the Radio Equipment Directive

- **For computer models with wireless radio devices:**

This product is in conformity with all the requirements and essential norms that apply to EU Council Radio Equipment Directive 2014/53/EU on the approximation of the laws of the Member States relating to radio equipment. The full text of the system EU declaration of conformity and the EU wireless module declarations are available at the following Internet addresses:

- For desktop computers: <https://www.lenovo.com/eu-doc-desktops>
- For workstations: <https://www.lenovo.com/eu-doc-workstations>

Lenovo cannot accept responsibility for any failure to satisfy the protection requirements resulting from a non-recommended modification of the product, including the installation of option cards from other manufacturers. This product has been tested and found to comply with the limits for Class B equipment according to European Standards harmonized in the Directives in compliance. The limits for Class B equipment were derived for typical residential environments to provide reasonable protection against interference with licensed communication devices.

- **For computer models without wireless radio devices:**

The full text of the system EU declaration of conformity is available at the following Internet addresses:

- For desktop computers: <https://www.lenovo.com/eu-doc-desktops>
- For workstations: <https://www.lenovo.com/eu-doc-workstations>

Lenovo cannot accept responsibility for any failure to satisfy the protection requirements resulting from a non-recommended modification of the product, including the installation of option cards from other manufacturers. This product has been tested and found to comply with the limits for Class B equipment according to European Standards harmonized in the Directives in compliance. The limits for Class B equipment were derived for typical residential environments to provide reasonable protection against interference with licensed communication devices.

Brazil

Este equipamento não tem direito à proteção contra interferência prejudicial e não pode causar interferência em sistemas devidamente autorizados.

This equipment is not protected against harmful interference and may not cause interference with duly authorized systems.

Mexico

Advertencia: En Mexico la operación de este equipo está sujeta a las siguientes dos condiciones: (1) es posible que este equipo o dispositivo no cause interferencia perjudicial y (2) este equipo o dispositivo debe aceptar cualquier interferencia, incluyendo la que pueda causar su operación no deseada.

Singapore



Korea

무선설비 전파 혼신 (사용주파수 2400 ~ 2483.5 , 5725 ~ 5825 무선제품해당)

해당 무선설비가 전파혼신 가능성이 있으므로 인명안전과 관련된 서비스는 할 수 없음

SAR 정보

본 장치는 전파 노출에 대한 가이드라인을 충족합니다.

본 장치는 무선 송수신기입니다. 본 장치는 국제 가이드라인으로 권장되는 전파 노출에 대한 제한을 초과하지 않도록 설계되었습니다. 장치 액세서리 및 최신 부품을 사용할 경우 SAR 값이 달라질 수 있습니다. SAR 값은 국가 보고 및 테스트 요구 사항과 네트워크 대역에 따라 다를 수 있습니다. 본 장치는 사람의 신체에서 20mm 이상의 거리에서 사용할 수 있습니다.

Environmental information of countries and regions

This section provides environmental, recycling, and RoHS information about Lenovo products.

Recycling and environmental information

Lenovo encourages owners of information technology (IT) equipment to responsibly recycle their equipment when it is no longer needed. Lenovo offers a variety of programs and services to assist equipment owners in recycling their IT products. For information about recycling Lenovo products, go to:

<https://www.lenovo.com/recycling>

The latest environmental information about our products is available at:

<https://www.lenovo.com/ecodeclaration>

Important WEEE information



The WEEE marking on Lenovo products applies to countries with WEEE and e-waste regulations (for example, the European WEEE Directive, India E-Waste Management Rules). Appliances are labeled in accordance with local regulations concerning waste electrical and electronic equipment (WEEE). These regulations determine the framework for the return and recycling of used appliances as applicable within each geography. This label is applied to various products to indicate that the product is not to be thrown away, but rather put in the established collection systems for reclaiming these end of life products.

Users of electrical and electronic equipment (EEE) with the WEEE marking must not dispose of end of life EEE as unsorted municipal waste, but use the collection framework available to them for the return, recycle, and recovery of WEEE and to minimize any potential effects of EEE on the environment and human health due to the presence of hazardous substances. Lenovo electrical and electronic equipment (EEE) may contain parts and components, which at end-of-life might qualify as hazardous waste.

EEE and waste electrical and electronic equipment (WEEE) can be delivered free of charge to the place of sale or any distributor that sells electrical and electronic equipment of the same nature and function as the used EEE or WEEE.

For additional WEEE information, go to:

<https://www.lenovo.com/recycling>

WEEE information for Hungary

Lenovo, as a producer, bears the cost incurred in connection with the fulfillment of Lenovo's obligations under Hungary Law No. 197/2014 (VIII.1.) subsections (1)-(5) of section 12.

Japan recycling statements

Collect and recycle a disused Lenovo computer or monitor

If you are a company employee and need to dispose of a Lenovo computer or monitor that is the property of the company, you must do so in accordance with the Law for Promotion of Effective Utilization of Resources. Computers and monitors are categorized as industrial waste and should be properly disposed of by an industrial waste disposal contractor certified by a local government. In accordance with the Law for Promotion of Effective Utilization of Resources, Lenovo Japan provides, through its PC Collecting and Recycling Services, for the collecting, reuse, and recycling of disused computers and monitors. For details, visit the Lenovo Web site at:

<https://www.lenovo.com/recycling/japan>

Pursuant to the Law for Promotion of Effective Utilization of Resources, the collecting and recycling of home-used computers and monitors by the manufacturer was begun on October 1, 2003. This service is provided free of charge for home-used computers sold after October 1, 2003. For details, go to:

<https://www.lenovo.com/recycling/japan>

Dispose of Lenovo computer components

Some Lenovo computer products sold in Japan may have components that contain heavy metals or other environmental sensitive substances. To properly dispose of disused components, such as a printed circuit board or drive, use the methods described above for collecting and recycling a disused computer or monitor.

Dispose of disused lithium batteries from Lenovo computers

A button-shaped lithium battery is installed inside your Lenovo computer to provide power to the computer clock while the computer is off or disconnected from the main power source. If you need to replace it with a new one, contact your place of purchase or contact Lenovo for service. If you need to dispose of a disused lithium battery, insulate it with vinyl tape, contact your place of purchase or an industrial-waste-disposal operator, and follow their instructions.

Disposal of a lithium battery must comply with local ordinances and regulations.

Brazil recycling information

Declarações de Reciclagem no Brasil

Descarte de um Produto Lenovo Fora de Uso

Equipamentos elétricos e eletrônicos não devem ser descartados em lixo comum, mas enviados à pontos de coleta, autorizados pelo fabricante do produto para que sejam encaminhados e processados por empresas especializadas no manuseio de resíduos industriais, devidamente certificadas pelos órgãos ambientais, de acordo com a legislação local.

A Lenovo possui um canal específico para auxiliá-lo no descarte desses produtos. Caso você possua um produto Lenovo em situação de descarte, ligue para o nosso SAC ou encaminhe um e-mail para: reciclar@lenovo.com, informando o modelo, número de série e cidade, a fim de enviarmos as instruções para o correto descarte do seu produto Lenovo.

Battery recycling information for the European Union



Notice: This mark applies only to countries within the European Union (EU).

Batteries or packaging for batteries are labeled in accordance with European Directive 2006/66/EC concerning batteries and accumulators and waste batteries and accumulators. The Directive determines the framework for the return and recycling of used batteries and accumulators as applicable throughout the European Union. This label is applied to various batteries to indicate that the battery is not to be thrown away, but rather reclaimed upon end of life per this Directive.

In accordance with the European Directive 2006/66/EC, batteries and accumulators are labeled to indicate that they are to be collected separately and recycled at end of life. The label on the battery may also include a chemical symbol for the metal concerned in the battery (Pb for lead, Hg for mercury, and Cd for cadmium). Users of batteries and accumulators must not dispose of batteries and accumulators as unsorted municipal waste, but use the collection framework available to customers for the return, recycling, and treatment of batteries and accumulators. Customer participation is important to minimize any potential effects of batteries and accumulators on the environment and human health due to the potential presence of hazardous substances.

Before placing electrical and electronic equipment (EEE) in the waste collection stream or in waste collection facilities, the end user of equipment containing batteries and/or accumulators must remove those batteries and accumulators for separate collection.

Disposing of lithium batteries and battery packs from Lenovo products

A coin-cell type lithium battery might be installed inside your Lenovo product. You can find details about the battery in the product documentation. If the battery needs to be replaced, contact your place of purchase or contact Lenovo for service. If you need to dispose of a lithium battery, insulate it with vinyl tape, contact your place of purchase or a waste-disposal operator, and follow their instructions.

Disposing of battery packs from Lenovo products

Your Lenovo device might contain a lithium-ion battery pack or a nickel metal hydride battery pack. You can find details on the battery pack in the product documentation. If you need to dispose of a battery pack, insulate it with vinyl tape, contact Lenovo sales, service, or your place of purchase, or a waste-disposal operator, and follow their instructions. You also can refer to the instructions provided in the user guide for your product.

For proper collection and treatment, go to:
<https://www.lenovo.com/lenovo/environment>

Recycling information for Mainland China

《废弃电器电子产品回收处理管理条例》提示性说明

联想鼓励拥有联想品牌产品的用户当不再需要此类产品时，遵守国家废弃电器电子产品回收处理相关法律法规，将其交给当地具有国家认可的回收处理资质的厂商进行回收处理。更多回收服务信息，请点击进入<http://support.lenovo.com.cn/activity/551.htm>

Battery recycling information for Taiwan



廢電池請回收

Restriction of Hazardous Substances (RoHS) Directive of countries and regions

The latest environmental information about Lenovo products is available at:
<https://www.lenovo.com/ecodeclaration>

European Union RoHS

This Lenovo product, with included parts (cables, cords, and so on) meets the requirements of Directive 2011/65/EU on the restriction of the use of certain hazardous substances in electrical and electronic equipment ("RoHS recast" or "RoHS 2").

For more information about Lenovo worldwide compliance on RoHS, go to:
<https://www.lenovo.com/rohs-communication>

Turkish RoHS

The Lenovo product meets the requirements of the Republic of Turkey Directive on the Restriction of the Use of Certain Hazardous Substances in Waste Electrical and Electronic Equipment (WEEE).

Türkiye AEEE Yönetmeliğine Uygunluk Beyanı

Bu Lenovo ürünü, T.C. Çevre ve Orman Bakanlığı'nın "Atık Elektrik ve Elektronik Eşyalarda Bazı Zararlı Maddelerin Kullanımının Sınırlandırılmasına Dair Yönetmelik (AEEE)" direktiflerine uygundur.

AEEE Yönetmeliğine Uygundur.

Ukraine RoHS

Цим підтверджуємо, що продукція Леново відповідає вимогам нормативних актів України, які обмежують вміст небезпечних речовин

India RoHS

RoHS compliant as per E-Waste (Management) Rules.

Mainland China RoHS

产品中有害物质的名称及含量

部件名称	有害物质					
	铅(Pb)	汞(Hg)	镉(Cd)	六价铬 (Cr(VI))	多溴联苯 (PBB)	多溴二苯醚 (PBDE)
印刷电路板组件*	X	O	O	O	O	O
硬盘	X	O	O	O	O	O
光驱	X	O	O	O	O	O
内存	X	O	O	O	O	O
电脑I/O 附件	X	O	O	O	O	O
电源	X	O	O	O	O	O
键盘	X	O	O	O	O	O
鼠标	X	O	O	O	O	O
机箱/附件	X	O	O	O	O	O
电池	X	O	O	O	O	O

本表格依据 SJ/T 11364 的规定编制。
O：表示该有害物质在该部件所有均质材料中的含量均在 GB/T 26572 规定的限量要求以下。
X：表示该有害物质至少在该部件的某一均质材料中的含量超出 GB/T 26572 规定的限量要求。
注：表中标记“X”的部件，皆因全球技术发展水平限制而无法实现有害物质的替代。
印刷电路板组件*：包括印刷电路板及其零部件、电容和连接器。
根据型号的不同，可能不会含有以上的所有部件，请以实际购买机型为准。



在中华人民共和国境内销售的电子信息产品必须标识此标志，标志内的数字代表在正常使用状态下的产品的环保使用期限。

Taiwan RoHS

臺灣 RoHS - 個人電腦

單元	限用物質及其化學符號					
	鉛 (Pb)	汞 (Hg)	鎘 (Cd)	六價鉻 (Cr ⁶⁺)	多溴聯苯 (PBB)	多溴二苯醚 (PBDE)
印刷電路板組件	-	○	○	○	○	○
硬碟	-	○	○	○	○	○
光碟機	-	○	○	○	○	○
記憶體	-	○	○	○	○	○
電源供應器	-	○	○	○	○	○
鍵盤	-	○	○	○	○	○
滑鼠	-	○	○	○	○	○
機殼	-	○	○	○	○	○
配件 (電源線)	-	○	○	○	○	○
散熱模組	-	○	○	○	○	○

備考1. “超出0.1 wt %”及“超出0.01 wt %”係指限用物質之百分比含量超出百分比含量基準值。

備考2. “○”係指該項限用物質之百分比含量未超出百分比含量基準值。

備考3. “-”係指該項限用物質為排除項目。

臺灣 RoHS - 一體機

單元	限用物質及其化學符號					
	鉛 (Pb)	汞 (Hg)	鎘 (Cd)	六價鉻 (Cr ⁶⁺)	多溴聯苯 (PBB)	多溴二苯醚 (PBDE)
印刷電路板組件	-	○	○	○	○	○
硬碟	-	○	○	○	○	○
光碟機	-	○	○	○	○	○
記憶體	-	○	○	○	○	○
電腦I/O配件	-	○	○	○	○	○
電源供應器	-	○	○	○	○	○
鍵盤	-	○	○	○	○	○
滑鼠	-	○	○	○	○	○
機殼	-	○	○	○	○	○
螢幕	-	○	○	○	○	○
配件 (電源線)	-	○	○	○	○	○
散熱模組	-	○	○	○	○	○

備考1. “超出0.1 wt %”及“超出0.01 wt %”係指限用物質之百分比含量超出百分比含量基準值。

備考2. “○”係指該項限用物質之百分比含量未超出百分比含量基準值。

備考3. “-”係指該項限用物質為排除項目。

Electromagnetic emission notices

Federal Communications Commission (FCC) Supplier's Declaration of Conformity

The following information refers to IdeaCentre A540-27ICB, IdeaCentre A540-24ICB, and IdeaCentre A540-24API and machine types: F0EK, F0EL, and F0EM.

This equipment has been tested and found to comply with the limits for a Class B digital device, pursuant to Part 15 of the FCC Rules. These limits are designed to provide reasonable protection against harmful interference in a residential installation. This equipment generates, uses, and can radiate radio frequency energy and, if not installed and used in accordance with the instructions, may cause harmful interference to radio communications. However, there is no guarantee that interference will not occur in a particular installation. If this equipment does cause harmful interference to radio or television reception, which can be determined by turning the equipment off and on, the user is encouraged to try to correct the interference by one or more of the following measures:

- Reorient or relocate the receiving antenna.
- Increase the separation between the equipment and receiver.
- Connect the equipment into an outlet on a circuit different from that to which the receiver is connected.
- Consult an authorized dealer or service representative for help.

Lenovo is not responsible for any radio or television interference caused by using other than recommended cables and connectors or by unauthorized changes or modifications to this equipment. Unauthorized changes or modifications could void the user's authority to operate the equipment.

This device complies with Part 15 of the FCC Rules. Operation is subject to the following two conditions: (1) this device may not cause harmful interference, and (2) this device must accept any interference received, including interference that may cause undesired operation.

Responsible Party:
Lenovo (United States) Incorporated
7001 Development Drive
Morrisville, NC 27560
Email: FCC@lenovo.com



Industry Canada compliance statement

CAN ICES-3(B)/NMB-3(B)

European Union conformity

EU Contact: Lenovo (Slovakia), Landererova 12, 811 09 Bratislava, Slovakia



Compliance with the EMC Directive

This product is in conformity with the protection requirements of EU Council Directive 2014/30/EU on the approximation of the laws of the Member States relating to electromagnetic compatibility.

This product has been tested and found to comply with the limits for Class B equipment according to European Standards harmonized in the Directives in compliance. The Class B requirements for equipment are intended to offer adequate protection to broadcast services within residential environments.

German Class B compliance statement

Hinweis zur Einhaltung der Klasse B zur elektromagnetischen Verträglichkeit

Dieses Produkt entspricht den Schutzanforderungen der EU-Richtlinie zur elektromagnetischen Verträglichkeit Angleichung der Rechtsvorschriften über die elektromagnetische Verträglichkeit in den EU-Mitgliedsstaaten und hält die Grenzwerte der Klasse B der Norm gemäß Richtlinie.

Um dieses sicherzustellen, sind die Geräte wie in den Handbüchern beschrieben zu installieren und zu betreiben. Des Weiteren dürfen auch nur von der Lenovo empfohlene Kabel angeschlossen werden. Lenovo übernimmt keine Verantwortung für die Einhaltung der Schutzanforderungen, wenn das Produkt ohne Zustimmung der Lenovo verändert bzw. wenn Erweiterungskomponenten von Fremdherstellern ohne Empfehlung der Lenovo gesteckt/eingebaut werden.

Zulassungsbescheinigung laut dem Deutschen Gesetz über die elektromagnetische Verträglichkeit von Betriebsmitteln, EMVG vom 20. Juli 2007 (früher Gesetz über die elektromagnetische Verträglichkeit von Geräten), bzw. der EU Richtlinie 2014/30/EU, der EU Richtlinie 2014/53/EU Artikel 3.1b), für Geräte der Klasse B.

Dieses Gerät ist berechtigt, in Übereinstimmung mit dem Deutschen EMVG das EG-Konformitätszeichen - CE - zu führen. Verantwortlich für die Konformitätserklärung nach Paragraf 5 des EMVG ist die Lenovo (Deutschland) GmbH, Meitnerstr. 9, D-70563 Stuttgart.

Japan VCCI Class B compliance statement

この装置は、クラスB機器です。この装置は、住宅環境で使用することを目的としていますが、この装置がラジオやテレビジョン受信機に近接して使用されると、受信障害を引き起こすことがあります。
取扱説明書に従って正しい取り扱いをして下さい。

VCCI-B

Japan compliance statement for products which connect to the power mains with rated current less than or equal to 20 A per phase

日本の定格電流が 20A/相 以下の機器に対する高調波電流規制
高調波電流規格 JIS C 61000-3-2 適合品

Japan notice for ac power cord

The ac power cord shipped with your product can be used only for this specific product. Do not use the ac power cord for other devices.

本製品およびオプションに電源コード・セットが付属する場合は、それぞれ専用のものになっていますので他の電気機器には使用しないでください。

Other compliance information

This section provides other compliance information about Lenovo products.

Export classification notice

This product is subject to the United States Export Administration Regulations (EAR) and has an Export Classification Control Number (ECCN) of 5A992.c. It can be re-exported except to any of the embargoed countries in the EAR E1 country list.

Lenovo product service information for Taiwan

委製商/進口商名稱: 荷蘭商聯想股份有限公司台灣分公司
進口商地址: 台北市中山區北安路780號7樓
進口商電話: 0800-000-702 (代表號)

Taiwan precautionary vision statement

警語：使用過度恐傷害視力

注意事項：

- 使用30分鐘請休息10分鐘。
- 未滿2歲幼兒不看螢幕，2歲以上每天看螢幕不要超過1小時。

Keyboard and mouse compliance statement for Taiwan

本產品隨貨附已取得經濟部標準檢驗局認可之PS/2或USB的鍵盤與滑鼠一組

Eurasian compliance mark



Brazil audio notice

Ouvir sons com mais de 85 decibéis por longos períodos pode provocar danos ao sistema auditivo.

Enable or disable the ErP LPS compliance mode

Lenovo computers meet the eco-design requirements of the ErP Lot 3 regulation. For more information, go to:

<https://www.lenovo.com/ecodeclaration>

You can enable the ErP LPS compliance mode to reduce the consumption of electricity when the computer is off or in sleep mode.

To enable or disable the ErP LPS compliance mode:

1. Restart the computer. When the logo screen is displayed, press F1 or Fn+F1.
2. Select **Power** → **Enhanced Power Saving Mode** and press Enter.
3. Depending on whether you select **Enabled** or **Disabled**, do one of the following:
 - If you select **Enabled**, press Enter. Then, select **Power** → **Automatic Power On** and press Enter. Check whether the Wake on LAN feature is disabled automatically. If no, disable it.
 - If you select **Disabled**, press Enter. Then, go to the next step.
4. Press F10 or Fn+F10 to save the changes and exit.

When the ErP LPS compliance mode is enabled, you can wake up the computer by doing one of the following:

- Press the power button.
- Enable the Wake Up on Alarm feature to make the computer wake up at a set time.

To meet the off mode requirement of ErP compliance, you need to disable the Fast Startup function.

1. Go to Control Panel and view by large icons or small icons.
2. Click **Power Options** → **Choose what the power buttons do** → **Change settings that are currently unavailable**.
3. Clear the **Turn on fast startup (recommended)** option from the **Shutdown settings** list.

ENERGY STAR model information



ENERGY STAR is a joint program of the U.S. Environmental Protection Agency and the U.S. Department of Energy aimed at saving money and protecting the environment through energy efficient products and practices.

Lenovo is proud to offer our customers products with an ENERGY STAR compliant designation. The following machine types have been designed and tested to conform to the ENERGY STAR program requirement for computers at the time of manufacture.

FOEK, FOEL, and FOEM

For more information about Lenovo ENERGY STAR certified products, go to:

https://www.lenovo.com/us/en/social_responsibility/energy/

By using ENERGY STAR compliant products and taking advantage of the power management features of your computer, you reduce the consumption of electricity. Reduced electrical consumption contributes to potential financial savings, a cleaner environment, and the reduction of greenhouse gas emissions.

For more information about ENERGY STAR, go to:

<https://www.energystar.gov>

Lenovo encourages you to make efficient use of energy an integral part of your day-to-day operations. To help in this endeavor, Lenovo has preset a default power plan. To change the power plan, see “Set the power plan” on page 19.

Appendix D. Notices and trademarks

Notices

Lenovo may not offer the products, services, or features discussed in this document in all countries. Consult your local Lenovo representative for information on the products and services currently available in your area. Any reference to a Lenovo product, program, or service is not intended to state or imply that only that Lenovo product, program, or service may be used. Any functionally equivalent product, program, or service that does not infringe any Lenovo intellectual property right may be used instead. However, it is the user's responsibility to evaluate and verify the operation of any other product, program, or service.

Lenovo may have patents or pending patent programs covering subject matter described in this document. The furnishing of this document does not give you any license to these patents. You can send license inquiries, in writing, to:

*Lenovo (United States), Inc.
1009 Think Place - Building One
Morrisville, NC 27560
U.S.A.
Attention: Lenovo Director of Licensing*

LENOVO PROVIDES THIS PUBLICATION "AS IS" WITHOUT WARRANTY OF ANY KIND, EITHER EXPRESS OR IMPLIED, INCLUDING, BUT NOT LIMITED TO, THE IMPLIED WARRANTIES OF NON-INFRINGEMENT, MERCHANTABILITY OR FITNESS FOR A PARTICULAR PURPOSE. Some jurisdictions do not allow disclaimer of express or implied warranties in certain transactions, therefore, this statement may not apply to you.

Changes are made periodically to the information herein; these changes will be incorporated in new editions of the publication. To provide better service, Lenovo reserves the right to improve and/or modify the products and software programs described in the manuals included with your computer, and the content of the manual, at any time without additional notice.

The software interface and function and hardware configuration described in the manuals included with your computer might not match exactly the actual configuration of the computer that you purchase. For the configuration of the product, refer to the related contract (if any) or product packing list, or consult the distributor for the product sales. Lenovo may use or distribute any of the information you supply in any way it believes appropriate without incurring any obligation to you.

The products described in this document are not intended for use in implantation or other life support applications where malfunction may result in injury or death to persons. The information contained in this document does not affect or change Lenovo product specifications or warranties. Nothing in this document shall operate as an express or implied license or indemnity under the intellectual property rights of Lenovo or third parties. All information contained in this document was obtained in specific environments and is presented as an illustration. The result obtained in other operating environments may vary.

Lenovo may use or distribute any of the information you supply in any way it believes appropriate without incurring any obligation to you.

Any references in this publication to non-Lenovo Web sites are provided for convenience only and do not in any manner serve as an endorsement of those Web sites. The materials at those Web sites are not part of the materials for this Lenovo product, and use of those Web sites is at your own risk.

Any performance data contained herein was determined in a controlled environment. Therefore, the result obtained in other operating environments may vary significantly. Some measurements may have been made on development-level systems and there is no guarantee that these measurements will be the same on generally available systems. Furthermore, some measurements may have been estimated through extrapolation. Actual results may vary. Users of this document should verify the applicable data for their specific environment.

This document is copyrighted by Lenovo and is not covered by any open source license, including any Linux agreement(s) which may accompany software included with this product. Lenovo may update this document at any time without notice.

For the latest information or any questions or comments, contact or visit the Lenovo Web site:

<https://support.lenovo.com>

Trademarks

LENOVO, LENOVO logo, IDEACENTRE, and IDEACENTRE logo are trademarks of Lenovo. Intel, Intel SpeedStep, Optane, and Thunderbolt are trademarks of Intel Corporation or its subsidiaries in the U.S. and/or other countries. Microsoft, Windows, Direct3D, BitLocker, and Cortana are trademarks of the Microsoft group of companies. Mini DisplayPort (mDP), DisplayPort, and VESA are trademarks of the Video Electronics Standards Association. The terms HDMI and HDMI High-Definition Multimedia Interface are trademarks or registered trademarks of HDMI Licensing LLC in the United States and other countries. Wi-Fi, Wi-Fi Alliance, WiGig, and Miracast are registered trademarks of Wi-Fi Alliance. USB-C is a trademark of USB Implementers Forum. All other trademarks are the property of their respective owners. © 2019 Lenovo.

Lenovo

Lenovo

Regulatory Notices for Wireless Modules

Eighteenth Edition (June 2019)

© Copyright Lenovo 2013, 2019.

LIMITED AND RESTRICTED RIGHTS NOTICE: If data or software is delivered pursuant a General Services Administration "GSA" contract, use, reproduction, or disclosure is subject to restrictions set forth in Contract No. GS-35F-05925.

Contents

Chapter 1. Identifying the wireless modules	1
Chapter 2. Read first — regulatory information.	3
Chapter 3. Regulatory information about wireless modules	5
USA — Federal Communications Commission (FCC)	5
Approved wireless devices.	5
Preinstalled wireless LAN modules	5
Simultaneous use of RF transmitters	6
Canada — Industry Canada (IC)	7
IC Certification number	7
Numéro d'homologation IC	9
Electronic emission notices	11
Europe — EU Declaration of Conformity	11
EU declaration of conformity (multi-language translations)	12
Notice for users in India.	18
Notice for users in Japan	18

日本国内で無線 LAN アダプターおよび Bluetooth アダプターをご使用になる場合の注意	18
無線 LAN 製品ご使用時におけるセキュリティに関するご注意	20
使用環境および快適に使用するために	20
Notice for users in Argentina (Nota para Uso en Argentina)	21
Notice for users in Brazil (Aviso para os utilizadores no Brasil)	21
Notice for users in Korea	22
Notice for users in Mexico (Nota para uso en Mexico)	23
Notice for users in Morocco	23
Notice for users in Nigeria	23
Notice for users in Pakistan	24
Notice for users in Saudi Arabia	25
Notice for users in Serbia	33
Notice for users in South Africa.	34
Notice for users in Taiwan	34
Notice for users in Thailand	35
Notice for users in the UAE	35
Appendix A. Trademarks	37

Chapter 1. Identifying the wireless modules

This document provides regulatory information about the wireless modules used in a number of Lenovo brand computers.

To identify the wireless modules used in your computer, refer to the following tables:

ideacentre computers

Lenovo computer	Wireless modules
ideacentre 710-25ISH	QCNFA34AC, 8260NGW
ideacentre AIO 910-27ISH	3165NGW, QCNFA435
ideacentre Y900 RE-34ISZ	QCNFA34AC, 8260NGW
ideacentre AIO 510S-23ISU	3165NGW, QCNFA435
ideacentre 510S-08ISH	3165NGW, QCNFA435
Lenovo Legion T530-28ICB	3165NGW, RTL8821CE, 8265NGW, RTL8822BE, QCNFA435
Lenovo Legion T730-28ICO	8265NGW, RTL8822BE
Lenovo Legion T530-28APR	RTL8821CE, RTL8822BE, QCNFA435
Lenovo Legion C530-19ICB	3165NGW, RTL8821CE, 8265NGW, RTL8822BE, QCNFA435
Lenovo Legion C730-19ICO	8265NGW, RTL8822BE
ideacentre 510S-07ICB	3165NGW, RTL8821CE
ideacentre A340-24ICB	3165NGW, RTL8821CE, QCNFA435
ideacentre A340-24IGM	3165NGW, RTL8821CE, QCNFA435
ideacentre A340-24IWL	3165NGW, RTL8821CE, QCNFA435
ideacentre A340-22ICB	3165NGW, RTL8821CE, QCNFA435
ideacentre A340-22IGM	3165NGW, RTL8821CE, QCNFA435
ideacentre A340-22IWL	3165NGW, RTL8821CE, QCNFA435
Yoga A940-27ICB	8265NGW, RTL8822BE, BM23SPKXY
IdeaCentre T540- 15ICB G	8265NGW, 3165NGW, RTL8821CE, RTL8822BE
ideacentre A340-22AST	QCNFA435, RTL8821CE
IdeaCentre A540-27ICB	3165NGW, RTL8822CE, 9462NGW
IdeaCentre A540-24ICB	RTL8822CE, 9462NGW
IdeaCentre A540-24API	RTL8822CE, QCNFA435
ideacentre 510S-07ICK	3165NGW, RTL8821CE
ideacentre 510-15ICK	3165NGW, 8265NGW, RTL8821CE, RTL8822BE
ideacentre 510A-15ICK	3165NGW, 8265NGW, RTL8821CE, RTL8822BE
ideacentre A340-24ICK	3165NGW, RTL8821CE, QCNFA435

Lenovo computer	Wireless modules
ideacentre A340-22ICK	3165NGW, RTL8821CE, QCNFA435
IdeaCentre T540-15ICK G	3165NGW, 8265NGW, RTL8821CE, RTL8822BE

Chapter 2. Read first – regulatory information

Read this document before using your computer. The Lenovo and ideacentre computers listed in Chapter 1 of this document comply with the radio frequency and safety standards of any country or region in which it has been approved for wireless use. Install and use these computers according to the instructions and precautions provided in this document.

The latest Regulatory Notice has been uploaded on the Web site. To refer to it, go to <http://www.lenovo.com/UserManuals>.

Veillez lire le présent document avant d'utiliser votre ordinateur. Cet ordinateur est conforme aux normes de fréquence radio et de sécurité de tous les pays ou régions dans lesquels son utilisation sans fil a été homologuée. Installez et utilisez l'ordinateur en respectant les instructions qui suivent.

La version la plus récente de la Notice relative à la réglementation a été chargée sur le site Web. Pour la consulter, accédez à <http://www.lenovo.com/UserManuals>.

Chapter 3. Regulatory information about wireless modules

This section provides the regulatory information about wireless modules used in your computers.

USA – Federal Communications Commission (FCC)

Approved wireless devices

This section presents the FCC ID and model number of each wireless device.

Note: The following wireless modules marketed in the USA and Canada do not support or function in the extended channels (Ch. 12 and 13). Models: 3165NGW, 8260NGW, 8265NGW, QCNFA34AC, QCNFA435, RTL8821CE, RTL8822CE, 9462NGW and RTL8822BE.

Preinstalled wireless LAN and Bluetooth combo adapter

- Wireless LAN and Bluetooth combo Mini PCI Express Card
FCC ID: PD98260NG (Model: 8260NGW)
- Wireless LAN and Bluetooth combo Mini PCI Express Card
FCC ID: PPD-QCNFA34AC (Model: QCNFA34AC)
- Wireless LAN and Bluetooth combo Mini PCI Express Card
FCC ID: PD93165NGU (Model: 3165NGW)
- Wireless LAN and Bluetooth combo Mini PCI Express Card
FCC ID: PPD-QCNFA435 (Model: QCNFA435)
- Wireless LAN and Bluetooth combo Mini PCI Express Card
FCC ID: PD98265NG (Model: 8265NGW)
- Wireless LAN and Bluetooth combo Mini PCI Express Card
FCC ID: TX2-RTL8821CE (Model: RTL8821CE)
- Wireless LAN and Bluetooth combo Mini PCI Express Card
FCC ID: TX2-RTL8821CE (Model: RTL8822BE)
- Wireless LAN and Bluetooth combo Mini PCI Express Card
FCC ID: PD99462NG (Model: 9462NGW)
- Wireless LAN and Bluetooth combo Mini PCI Express Card
FCC ID: TX2-RTL8822CE (Model: RTL8822CE)

Preinstalled Bluetooth adapter

- Bluetooth Mini PCI Express Card
FCC ID: A8TBM23SPKXYC2A (Model: BM23SPKXY)

Preinstalled wireless LAN modules

FCC ID location

If you find one of the following indications on the label at the bottom side of your computer, your computer contains a Wireless LAN Mini PCI Express Card, preinstalled by Lenovo:

- "Contains Transmitter Module: FCC ID: PD98260NG"
- "Contains Transmitter Module: FCC ID: PPD-QCNFA34AC"
- "Contains Transmitter Module: FCC ID: PD93165NGU"
- "Contains Transmitter Module: FCC ID: PPD-QCNFA435"
- "Contains Transmitter Module: FCC ID: PD93165NGU"

- "Contains Transmitter Module: FCC ID: PD98265NG"
- "Contains Transmitter Module: FCC ID: PPD-QCNFA34AC"
- "Contains Transmitter Module: FCC ID: PPD-QCNFA435"

Use of the wireless LAN adapter

Attention: You are prohibited to replace the preinstalled Wireless LAN Mini PCI Express Card modules with any other card. If one of your cards requires replacement, send your computer with the preinstalled card(s) to Lenovo so that Lenovo will repair it.

Radio Frequency interference requirements

Each module has been tested and found to comply with the limits for a Class B digital device pursuant to FCC Part 15 Subpart B. Refer to the "Electronic emission notices" on page 11.

When you use a wireless LAN and Bluetooth combo module in the 802.11 a/n transmission mode, note that high power radars are allocated as primary users of the 5250 to 5350 MHz and 5650 to 5850 MHz bands. These radar stations can cause interference with and/or damage this device.

FCC RF Exposure compliance

The radiated output power of the PCI Express Mini Card authorized to use for your computer is far below the FCC radio frequency exposure limits. Nevertheless, it shall be used in such a manner that the potential for human contact during normal operation is minimized as follows:

CAUTION:

To comply with FCC RF exposure compliance requirements, a separation distance of at least 20 cm (8 inches) must be maintained between the antennas connected to the PCI Express Mini Cards and all persons.

For **Yoga A940–271CB**, the radiated output power of the Wireless Power charger authorized to use for your computer is far below the FCC radio frequency exposure limits. Nevertheless, it shall be used in such a manner that the potential for human contact during normal operation is minimized as follows:

CAUTION:

To comply with FCC RF exposure compliance requirements, a separation distance of at least 20 cm (8 inches) must be maintained between the Wireless Power charger and all persons.

Simultaneous use of RF transmitters

Each computer listed in Chapter 1 of this document is approved for simultaneous use of one of the approved wireless LAN adapters. For a list of those transmitters, refer to "Approved wireless devices" on page 5.

Make sure of the following conditions when you use any other external wireless option device:

1. When you use any other RF option device, you are requested to confirm that the device conforms to the RF Safety requirement and is approved to use for your computer.
2. You must follow the RF Safety instructions of wireless option devices that are included in the user manual of the RF option device.
3. If wireless options are prohibited to use in conjunction with another transmitters, you must turn off all other wireless features in your computer.

Canada – Industry Canada (IC)

IC Certification number

Approved wireless devices

This section presents the IC Certification and model number of each wireless device.

Preinstalled wireless LAN and Bluetooth combo adapter

- Wireless LAN and Bluetooth combo Mini PCI Express Card
IC: 1000M-3165NG (Model: 3165NGW)
- Wireless LAN and Bluetooth combo Mini PCI Express Card
IC: 1000M-8260NG (Model: 8260NGW)
- Wireless LAN and Bluetooth combo Mini PCI Express Card
IC: 1000M-8265NG (Model: 8265NGW)
- Wireless LAN and Bluetooth combo Mini PCI Express Card
IC: 4104A-QCNFA34AC (Model: QCNFA34AC)
- Wireless LAN and Bluetooth combo Mini PCI Express Card
IC: 4104A-QCNFA435 (Model: QCNFA435)
- Wireless LAN and Bluetooth combo Mini PCI Express Card
IC: 6317A-RTL8821CE (Model: RTL8821CE)
- Wireless LAN and Bluetooth combo Mini PCI Express Card
IC: 6317A-RTL8822BE (Model: RTL8822BE)
- Wireless LAN and Bluetooth combo Mini PCI Express Card
IC: 61000M-9462NG (Model: 9462NGW)
- Wireless LAN and Bluetooth combo Mini PCI Express Card
IC: 6317A-RTL8822CE (Model: RTL8822CE)

Preinstalled Bluetooth adapter

- Bluetooth Mini PCI Express Card
IC: 12246A-BM23SPKXYC2 (Model: BM23SPKXY)

Preinstalled wireless LAN modules

Use of the wireless LAN adapter: If you find one of the following indications on the label at the bottom side of your computer, your computer contains a Wireless LAN Mini PCI Express Card, preinstalled by Lenovo:

- "Contains Transmitter Module: Canada IC: 1000M-3165NG"
- "Contains Transmitter Module: Canada IC: 1000M-8260NG"
- "Contains Transmitter Module: Canada IC: 1000M-8265NG"
- "Contains Transmitter Module: Canada IC: 4104A-QCNFA34AC"
- "Contains Transmitter Module: Canada IC: 4104A-QCNFA435"
- "Contains Transmitter Module: Canada IC: 6317A-RTL8821CE"
- "Contains Transmitter Module: Canada IC: 6317A-RTL8822BE"

Attention: You are prohibited to replace the preinstalled Wireless LAN Mini PCI Express Card modules with any other card. If one of your cards requires replacement, send your computer with the preinstalled card(s) to Lenovo so that Lenovo will repair it.

Low power license-exempt radio communication devices (RSS-210, RSS-247)

Operation is subject to the following two conditions:

1. This device may not cause interference.
2. This device must accept any interference, including interference that may cause undesired operation of the device.

When you use a wireless LAN module in the 802.11 a/n transmission mode, note the following:

- The devices for the band 5150–5350 MHz are only for indoor usage to reduce potential for harmful interference to co-channel Mobile Satellite systems.
- High power radars are allocated as primary users (meaning they have priority) of 5250–5350 MHz and 5650–5850 MHz and these radars could cause interference and/or damage to LE-LAN (Licence-Exempt Local Area Network) devices.
- The maximum antenna gain permitted for devices in the 5250-5350 MHz, 5470-5725 MHz, and 5725-5825 MHz bands complies with the e.i.r.p. limit in Industry Canada Standard RSS-210, RSS-247.

IC Antenna Statement

This Lenovo computer contains a modular wireless radio transmitter that has been approved by Industry Canada to operate with the antenna types listed below with the maximum permissible gain indicated. Antenna types not included in this list, having a gain greater than the maximum gain indicated for that type, are strictly prohibited for use with this device.

Module Model Number:	IC ID:	Maximum Gain:
8260NGW	IC: 1000M-8260NG	3.24 dBi (2.4GHz), 3.64 dBi (5.15-5.25 GHz), 3.73 dBi (5.47-5.35 Ghz), 4.77 dBi (5.47-5.725 Ghz), 4.97 dBi (5.725-5.825 Ghz)
8265NGW	IC: 1000M-8265NG	3.24 dBi (2.4GHz), 3.64 dBi (5.15-5.25 GHz), 3.73 dBi (5.25-5.35 Ghz), 4.77 dBi (5.47-5.725 Ghz), 4.97 dBi (5.725-5.825 Ghz)
QCNFA34AC	IC: 4104A-QCNFA34AC	4.76dBi
QCNFA435	IC: 4104A-QCNFA435	5.56dBi
RTL8821CE	IC: 6317A-RTL8821CE	3.5 dBi (2.4 GHz), 5dBi(5GHz)
RTL8822BE	IC: 6317A-RTL8822BE	3.5 dBi (2.4 GHz), 5dBi(5GHz)
3165NGW	IC: 1000M-3165NG	3.24 dBi (2.4 GHz), 3.64 dBi (5.15-5.25 GHz), 3.73 dBi (5.25-5.35 Ghz), 4.77 dBi (5.47-5.725 Ghz), 4.97 dBi (5.725-5.85 Ghz)
BM23SPKXY	IC: 12246A-BM23SPKXYC2	1.927dBi (2.4GHz)
RTL8822CE	IC: 6317A-RTL8822CE	3.5 dBi (2.4 GHz), 5dBi(5GHz)
9462NGW	IC: 1000M-9462NG	3.24 dBi (2.4 GHz), 3.64 dBi (5.15-5.25 GHz), 3.73 dBi (5.25-5.35 Ghz), 4.77 dBi (5.47-5.725 Ghz), 4.97 dBi (5.725-5.825 Ghz)

Exposure of humans to RF fields (RSS-102)

Those computers employ low gain integral antennas that do not emit RF field in excess of Health Canada limits for the general population; consult Safety Code 6, obtainable from Health Canada's Web site at <http://www.hc-sc.gc.ca/>.

The radiated energy from the antennas connected to the wireless adapters conforms to the IC limit of the RF exposure requirement regarding IC RSS-102, Issue 5, Section 4, set forth for an uncontrolled environment.

For **Yoga A940–27ICB with Wireless Power Charger**, the product complies with the IC RF Exposure for Low Power Consumer Wireless Power Transfer limits set forth for an uncontrolled environment and is safe for intended operation as described in your User Guide. To comply with this exposure compliance requirement, a separation distance of at least 10 cm (4 inches) must be maintained between the Wireless Power charger and all persons.

Numéro d'homologation IC

Périphériques sans fil homologués

Cette section présente le numéro d'homologation IC et le numéro de modèle de chaque périphérique sans fil.

Module sans fil préinstallé

- IC: 1000M-3165NG (Model: 3165NGW)
- IC: 1000M-8260NG (Model: 8260NGW)
- IC: 1000M-8265NG (Model: 8265NGW)
- IC: 4104A-QCNFA34AC (Model: QCNFA34AC)
- IC: 4104A-QCNFA435 (Model: QCNFA435)
- IC: 6317A-RTL8821CE (Model: RTL8821CE)
- IC: 6317A-RTL8822BE (Model: RTL8822BE)
- IC: 12246A-BM23SPKXYC2 (Model: BM23SPKXY)
- IC: 1000M-9462NG (Model: 9462NGW)
- IC: 6317A-RTL8822CE (Model: RTL8822CE)

Module sans fil préinstallé

Si vous rencontrez une des indications suivantes sur l'étiquette se trouvant au bas de l'ordinateur, cela signifie que Lenovo y a préinstallé une carte réseau sans fil Mini PCI Express :

- "Contains Transmitter Module: Canada IC: 1000M-3165NG"
- "Contains Transmitter Module: Canada IC: 1000M-8260NG"
- "Contains Transmitter Module: Canada IC: 1000M-8265NG"
- "Contains Transmitter Module: Canada IC: 4104A-QCNFA34AC"
- "Contains Transmitter Module: Canada IC: 4104A-QCNFA435"
- "Contains Transmitter Module: Canada IC: 6317A-RTL8821CE"
- "Contains Transmitter Module: Canada IC: 6317A-RTL8822BE"

Attention: L'ordinateur contient un mécanisme d'authentification. Vous pouvez installer ou désinstaller tout dispositif sans fil. Si vous installez une carte sans fil qui n'est pas homologuée dans votre ordinateur, l'ordinateur ne démarrera pas mais affichera un message d'erreur et générera des bips sonores.

Permis d'émission à faible puissance – Cas des appareils de communications radio (CNR-210, CNR-247)

Le fonctionnement de ce type d'appareil est soumis aux deux conditions suivantes:

1. Cet appareil ne peut pas causer de perturbations électromagnétiques.
2. Cet appareil doit accepter toutes les perturbations reçues, y compris celles susceptibles d'occasionner un fonctionnement indésirable.

Lorsque vous utilisez une carte de réseau local sans fil dans le mode de transmission 802.11 a/n, tenez compte des remarques suivantes:

- Les appareils destinés à la bande 5150–5350 MHz devront être exclusivement utilisés en intérieur afin de réduire les risques de perturbations électromagnétiques gênantes sur les systèmes de satellite mobile dans un même canal.
- Les radars à forte puissance sont désignés comme les utilisateurs principaux (c'est-à-dire qu'ils sont prioritaires) des bandes 5250-5350 MHz et 5650-5850 MHz. Ils peuvent provoquer des perturbations électromagnétiques sur les appareils de type LE-LAN (réseau de communication local sans licence) ou les endommager.
- Le gain d'antenne maximal autorisé pour les appareils dans les bandes de fréquence 5250-5350 MHz, 5470-5725 MHz et 5725-5825 MHz est conforme à la limite p.i.r.e (puissance isotrope rayonnée équivalente) définie de la norme industrielle du Canada CNR-210, CNR-247.

Déclaration IC antenne

Cet ordinateur Lenovo contient un émetteur radio sans fil modulaire qui a été approuvé par Industrie Canada pour fonctionner avec les types d'antenne énumérés ci-dessous avec le gain maximal admissible indiqué. Types d'antennes ne figurent pas dans cette liste, ayant un gain supérieur au gain maximal indiqué pour ce type, sont strictement interdits pour une utilisation avec cet appareil.

Nombre Module Modèle:	IC ID:	Maximum Gain:
8265NGW	IC: 1000M-8265NG	3.24 dBi (2.4GHz), 3.64 dBi (5.15-5.25 GHz), 3.73 dBi (5.25-5.35 Ghz), 4.77 dBi (5.47-5.725 Ghz), 4.97 dBi (5.725-5.825 Ghz)
8260NGW	IC: 1000M-8260NG	3.24 dBi (2.4GHz), 3.64 dBi (5.15-5.25 GHz), 3.73 dBi (5.47-5.35 Ghz), 4.77 dBi (5.47-5.725 Ghz), 4.97 dBi (5.725-5.825 Ghz)
QCNFA435	IC: 4104A-QCNFA435	5.56dBi
3165NGW	IC: 1000M-3165NG	3.24 dBi (2.4 GHz), 3.64 dBi (5.15-5.25 GHz), 3.73 dBi (5.25-5.35 Ghz), 4.77 dBi (5.47-5.725 Ghz), 4.97 dBi (5.725-5.85 Ghz)
RTL8821CE	IC: 6317A-RTL8821CE	3.5 dBi (2.4 GHz), 5dBi(5GHz)
RTL8822BE	IC: 6317A-RTL8822BE	3.5 dBi (2.4 GHz), 5dBi(5GHz)
QCNFA34AC	IC: 4104A-QCNFA34AC	4.76dBi
BM23SPKXY	IC: 12246A-BM23SPKXYC2	1.927dBi (2.4GHz)

RTL8822CE	IC: 6317A-RTL8822CE	3.5 dBi (2.4 GHz), 5dBi(5GHz)
9462NGW	IC: 1000M-9462NG	3.24 dBi (2.4 GHz), 3.64 dBi (5.15-5.25 GHz), 3.73 dBi (5.25-5.35 Ghz), 4.77 dBi (5.47-5.725 Ghz), 4.97 dBi (5.725-5.825 Ghz)

Exposition des êtres humains aux champs radioélectriques (RF) (CNR-102)

L'ordinateur utilise des antennes intégrales à faible gain qui n'émettent pas un champ électromagnétique supérieur aux normes imposées par le Ministère de la santé canadien pour la population. Consultez le Safety Code 6 sur le site Web du Ministère de la santé canadien à l'adresse <http://www.hc-sc.gc.ca>.

L'énergie émise par les antennes reliées aux adaptateurs sans fil conforme à la limite IC de l'exigence de l'exposition aux RF IC concernant RSS-102, Issue 5, Section 4, définies pour un environnement non contrôlé.

Yoga A940-27ICB avec chargeur sans fil : le produit est conforme aux limites établies par IC en ce qui concerne l'exposition aux fréquences radio pour le chargement sans fil en consommation basse dans un environnement non contrôlé et il peut être utilisé en toute sécurité comme décrit dans votre Guide de l'utilisateur. Pour rester dans ces limites d'exposition, une distance d'au moins 10 cm (4 pouces) doit être respectée entre le chargeur sans fil et toute personne.

Electronic emission notices

Refer to your product *User Guide* for information regarding the FCC compliance statement and other compliance statements.

Industry Canada Class B Emission Compliance Statement

This Class B digital apparatus complies with Canadian ICES-003.

Avis de conformité à la réglementation d'Industrie Canada

Cet appareil numérique de la classe B est conforme à la norme NMB-003 du Canada.

Europe – EU Declaration of Conformity

Products intended for sale within the European Union are marked with the Conformité Européenne (CE) Marking, which indicates compliance with the applicable Directives and European Norms, and amendments, identified below.

Wireless Function	Modules
WLAN/Bluetooth combo module	3165NGW, 8260NGW, 8265NGW, QCNFA34AC, QCNFA435, RTL8821CE, RTL8822CE, 9462NGW and RTL8822BE
Bluetooth module	BM23SPKXY



For EU Frequency band restriction

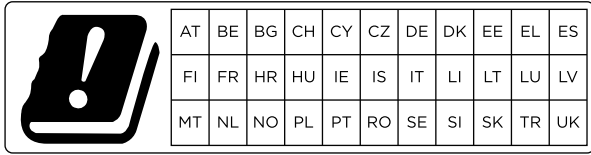

EU declaration of conformity (multi-language translations)

This section provides the EU declaration of conformity in different languages.

English

Hereby, Lenovo® (Singapore) Pte. Ltd., declares that the wireless equipment listed in this section is in compliance with the Radio Equipment Directive 2014/53/EU.

The full text of the system EU declaration of conformity and the EU wireless module declarations are available at the following Internet addresses:

www.lenovo.com/eu-doc-desktops

www.lenovo.com/eu-doc-workstations

EU Frequency band restriction for wireless LAN

Usage of this device is limited to indoor in the band 5150 MHz to 5350 MHz (channels 36, 40, 44, 48, 52, 56, 60, 64).

Bulgarian

С настоящото Lenovo (Singapore) Pte. Ltd. декларира, че безжичното оборудване, споменато в този раздел, съответства на Директивата за радиооборудване 2014/53/ЕС.

Пълният текст на декларацията за съответствие на ЕС относно системата и декларациите за безжичните модули на ЕС е наличен на следния адрес в интернет:

www.lenovo.com/eu-doc-desktops

www.lenovo.com/eu-doc-workstations

Ограничение в ЕС за честотни ленти за безжичен LAN

Употребата на това устройство е ограничена само на закрито в диапазона 5150 MHz до 5350 MHz (канали 36, 40, 44, 48, 52, 56, 60, 64).

Croatia

Lenovo (Singapore) Pte. Ltd. ovime izjavljuje da je bežična oprema navedena u ovom odjeljku usklađena s Direktivom o radijskoj opremi 2014/53/EU.

Cjeloviti tekst EU izjave o sukladnosti sustava i EU izjave o bežičnim modulima dostupne su na sljedećoj web-adresi:

www.lenovo.com/eu-doc-desktops

www.lenovo.com/eu-doc-workstations

Ograničenje frekvencijskog pojasa za bežični LAN u EU-u

Upotreba uređaja ograničena je na zatvorene prostore unutar pojasa od 5150 MHz do 5350 MHz (kanali 36, 40, 44, 48, 52, 56, 60, 64).

Czech

Společnost Lenovo (Singapore) Pte. Ltd. tímto prohlašuje, že bezdrátová zařízení uvedená v této části dokumentu splňují základní i další relevantní požadavky směrnice o rádiových zařízeních 2014/53/EU.

Celé znění EU prohlášení o shodě systému a EU prohlášení o bezdrátových modulech je k dispozici na této internetové adrese:

www.lenovo.com/eu-doc-desktops

www.lenovo.com/eu-doc-workstations

Omezení EU pro frekvenční pásma bezdrátové sítě LAN

Použití tohoto zařízení je omezeno na vnitřní prostory a frekvenční pásma 5150 až 5350 MHz (kanály 36, 40, 44, 48, 52, 56, 60, 64).

Danish

Lenovo (Singapore) Pte. Ltd. erklærer hermed, at det trådløse udstyr, der er angivet i dette afsnit, overholder direktivet om radioudstyr 2014/53/EU.

Den fulde erklæring vedrørende systemets overholdelse af EU-krav og erklæringerne om de trådløse modulers overholdelse af EU-krav (hvis relevante) er tilgængelige via følgende internetadresse:

www.lenovo.com/eu-doc-desktops

www.lenovo.com/eu-doc-workstations

Restriktioner for frekvensbånd i EU for et trådløst LAN

Brug af denne enhed er begrænset til indendørs brug i frekvensbåndet 5150 MHz til 5350 MHz (kanal 36, 40, 44, 48, 52, 56, 60, 64).

Dutch

Hierbij verklaart Lenovo (Singapore) Pte. Ltd. dat de draadloze apparatuur die in dit artikel is aangegeven voldoet aan de richtlijn 2014/53/EU voor radioapparatuur.

De volledige tekst van de EU-conformiteitsverklaring betreffende systemen en van de EU-verklaringen betreffende draadloze modules is beschikbaar op het volgende internetadres:

www.lenovo.com/eu-doc-desktops

www.lenovo.com/eu-doc-workstations

EU-beperking van frequentieband voor een draadloos LAN

Gebruik van dit apparaat is beperkt tot gebruik binnenshuis in de band van 5150 MHz tot 5350 MHz (kanalen 36, 40, 44, 48, 52, 56, 60, 64).

Estonian

Lenovo (Singapore) Pte. Ltd. kinnitab käesolevaga, et selles jaotises esitatud traadita side seadmed vastavad raadioseadmete direktiivile 2014/53/EL.

Süsteemi EL-i vastavusdeklaratsioonide ja EL-i traadita side mooduli deklaratsioonide täielikud tekstid on saadaval järgmisel Interneti-aadressil:

www.lenovo.com/eu-doc-desktops

www.lenovo.com/eu-doc-workstations

EL-i sagedusvahemiku piirang traadita side LAN-ile

Seda seadet võib kasutada siseruumides sagedusvahemikus 5150–5350 MHz (kanalid 36, 40, 44, 48, 52, 56, 60, 64).

Finnish

Lenovo (Singapore) Pte. Ltd. ilmoittaa täten, että tässä jaksossa mainitut langattomat laitteet ovat radiolaitedirektiivin 2014/53/EU mukaisia.

Lausuma järjestelmän EU-säännöstenmukaisuudesta ja lausumat langattomien moduulien EU-säännöstenmukaisuudesta ovat saatavilla kokonaisuudessaan seuraavassa Internet-osoitteessa:

www.lenovo.com/eu-doc-desktops

www.lenovo.com/eu-doc-workstations

Langattoman lähiverkon taajuusalueen rajoitus EU:n alueella

Tämä laite on tarkoitettu käytettäväksi sisätiloissa taajuusalueella 5 150–5 350 MHz (kanavat 36, 40, 44, 48, 52, 56, 60 ja 64).

French

Par la présente, Lenovo (Singapore) Pte. Ltd., déclare que les équipements sans fil listés dans cette section sont conformes à la directive 2014/53/EU sur les équipements radio.

Le texte complet de la déclaration européenne de conformité et des déclarations européennes concernant les modules sans fil, s'il y a lieu, sont disponibles à l'adresse Internet suivante:

www.lenovo.com/eu-doc-desktops

www.lenovo.com/eu-doc-workstations

Restriction liée à une bande de fréquence pour un réseau local sans fil au sein de l'Union européenne

Ce périphérique doit être utilisé exclusivement à l'intérieur, dans la bande de fréquence de 5150 à 5350 MHz (canaux 36, 40, 44, 48, 52, 56, 60, 64).

German

Hiermit erklärt Lenovo (Singapore) Pte. Ltd., dass das in diesem Abschnitt aufgelistete drahtlose Gerät die Funkanlagen-Richtlinie 2014/53/EU erfüllt.

Der vollständige Text der EU-Konformitätserklärung für das System und der EU-Deklarationen zu drahtlosen Modulen kann unter der folgenden Internetadresse eingesehen werden:

www.lenovo.com/eu-doc-desktops

www.lenovo.com/eu-doc-workstations

EU-Frequenzbandeinschränkung für drahtloses LAN

Die Verwendung dieses Gerätes ist im Frequenzband zwischen 5.150 und 5.350 MHz (Kanäle 36, 40, 44, 48, 52, 56, 60, 64) auf die Verwendung im Innenbereich beschränkt.

Greek

Με την παρούσα, η Lenovo (Singapore) Pte. Ltd., δηλώνει ότι ο ασύρματος εξοπλισμός που αναφέρεται σε αυτήν την ενότητα συμμορφώνεται με την Οδηγία περί Ραδιοεξοπλισμού 2014/53/ΕΕ.

Το πλήρες κείμενο της δήλωσης συμμόρφωσης της ΕΕ για το σύστημα και των δηλώσεων της ΕΕ για τις ασύρματες μονάδες είναι διαθέσιμο στην ακόλουθη διεύθυνση στο Internet:

www.lenovo.com/eu-doc-desktops

www.lenovo.com/eu-doc-workstations

Περιορισμός ζώνης συχνοτήτων στην ΕΕ για ασύρματο LAN

Η χρήση αυτής της συσκευής περιορίζεται σε εσωτερικούς χώρους στη ζώνη συχνοτήτων 5150 MHz έως 5350 MHz (κανάλια 36, 40, 44, 48, 52, 56, 60, 64).

Hungarian

A Lenovo (Singapore) Pte. Ltd. ezennel kijelenti, hogy a fejezetben említett vezeték nélküli készülék megfelel az 2014/53/EU számú, Rádióberendezésekről szóló direktívában foglaltaknak.

A berendezés Európai Unió-beli megfelelőségi nyilatkozata és a vezeték nélküli eszközökkel kapcsolatos európai nyilatkozat (ha elérhető) a következő weboldalon tekinthető meg:

www.lenovo.com/eu-doc-desktops

www.lenovo.com/eu-doc-workstations

Frekvenciatartományra vonatkozó európai uniós korlátozás vezeték nélküli LAN-hálózatokhoz

Az eszköz használata beltérre korlátozódik az 5150–5350 MHz tartományban (csatornák: 36, 40, 44, 48, 52, 56, 60, 64).

Icelandic

Hér með lýsir Lenovo (Singapore) Pte. Ltd. því yfir að þráðlausí búnaðurinn sem getið er í þessum hluta uppfylla allar kröfur og önnur viðkomandi ákvæði tilskipunar 1999/5/EC.

ESB Takmarkanir á tíðnisviði þráðlauss LAN Mini PCI staðarnetkorts

Notkun þessa tækis er takmörkuð við innanhússnotkun á tíðnisviðinu 5150 til 5350 MHz (rásir 36, 40, 44, 48, 52, 56, 60, 64).

Italian

Con la presente documentazione, Lenovo (Singapore) Pte. Ltd. dichiara che l'apparecchiatura wireless indicata in questa sezione è conforme alla direttiva 2014/53/EU sulle apparecchiature radio.

Il testo integrale della dichiarazione di conformità europea del sistema e le dichiarazioni UE dei moduli wireless, se applicabili, sono disponibili al seguente indirizzo Internet:

www.lenovo.com/eu-doc-desktops

www.lenovo.com/eu-doc-workstations

Restrizioni UE sulla banda di frequenza per una WLAN (wireless LAN)

L'utilizzo di questo dispositivo è limitato ad ambienti chiusi in banda compresa tra 5150 MHz e 5350 MHz (canali 36, 40, 44, 48, 52, 56, 60, 64).

Latvian

Ar šo uzņēmums Lenovo (Singapore) Pte. Ltd. paziņo, ka šajā sadaļā norādītais bezvadu aprīkojums atbilst radioiekārtu Direktīvai 2014/53/EK.

Pilnais teksts par sistēmas piemērotību ES atbilstības deklarācijai un ES bezvadu moduļu deklarācijām ir pieejams šādā interneta adresē:

www.lenovo.com/eu-doc-desktops

www.lenovo.com/eu-doc-workstations

ES frekvenču joslu ierobežojums bezvadu LAN adapterim

Šī ierīce ir paredzēta izmantošanai iekšējās joslās no 5150 MHz līdz 5350 MHz (kanālos 36, 40, 44, 48, 52, 56, 60, 64).

Lithuaninan

Šiame dokumente „Lenovo (Singapore) Pte. Ltd.“ pareiškia, kad belaidė įranga, nurodyta šiame skyriuje, atitinka Radijo įrangos direktyvos 2014/53/ES reikalavimus.

Visą sistemą ES atitiktis deklaracijos ir ES belaidžio ryšio modulio deklaracijų tekstą galite rasti apsilankę adresu internete:

www.lenovo.com/eu-doc-desktops

www.lenovo.com/eu-doc-workstations

Belaidžio LAN ES dažnių diapazono apribojimas

Šį įrenginį patalpose galima naudoti 5 150–5 350 MHz dažnių diapazonu (kanalai: 36, 40, 44, 48, 52, 56, 60, 64).

Norwegian

Lenovo (Singapore) Pte. Ltd. erklærer herved at det trådløse utstyret som er oppført i dette kapitlet, er i samsvar med direktiv 2014/53/EU om radioutstyr.

Den fullstendige teksten i EUs samsvarserklæring for systemet og EUs samsvarserklæringer for trådløse moduler, hvis aktuelt, er tilgjengelig på følgende Internett-adresser:

www.lenovo.com/eu-doc-desktops

www.lenovo.com/eu-doc-workstations

Begrensinger for frekvensbånd i EU for trådløst LAN

Denne enheten er begrenset til innendørs bruk i frekvensbåndet 5150 til 5350 MHz (kanal 36, 40, 44, 48, 52, 56, 60, 64).

Polish

Lenovo (Singapore) Pte. Ltd., niniejszym oświadcza, że urządzenie bezprzewodowe wymienione w tej sekcji spełnia wymagania dyrektywy w sprawie sprzętu radiowego 2014/53/UE.

Pełny tekst deklaracji zgodności systemów i modułów łączności bezprzewodowej z przepisami UE można znaleźć na następującej stronie internetowej:

www.lenovo.com/eu-doc-desktops

www.lenovo.com/eu-doc-workstations

Ograniczenia dotyczące pasm częstotliwości w UE dla połączeń bezprzewodowych LAN

Urządzenie jest przeznaczone do użytkowania wewnątrz budynków, w pasmach częstotliwości 5150 do 5350 MHz (kanały 36, 40, 44, 48, 52, 56, 60 i 64).

Portuguese

A Lenovo (Singapore) Pte. Ltd., declara por este meio que o equipamento sem fios listado nesta secção está em conformidade com a Diretiva de Equipamento de Rádio 2014/53/UE.

O texto completo da declaração de conformidade da UE e das declarações de módulos sem fios da UE para o sistema encontram-se disponíveis no seguinte endereço da Internet:

www.lenovo.com/eu-doc-desktops

www.lenovo.com/eu-doc-workstations

Restrição da banda de frequências na UE para uma LAN sem fios

A utilização deste dispositivo está limitada à utilização no interior, na banda 5150 a 5350 MHz (canais 36, 40, 44, 48, 52, 56, 60, 64).

Romanian

Prin aceasta, Lenovo (Singapore) Pte. Ltd. declară că echipamentul fără fir prezentat în această secțiune este în conformitate cu Directiva privitoare la echipamentele radio 2014/53/UE.

Textul complet al sistemului de declarații de conformitate și declarațiile privind modulele fără fir UE sunt disponibile la următoarele adrese:

www.lenovo.com/eu-doc-desktops

www.lenovo.com/eu-doc-workstations

Restricția UE privind banda de frecvență a unei rețele LAN fără fir

Utilizarea acestui dispozitiv este limitată la spațiile interioare, în banda de 5.150 – 5.350 MHz (canalele 36, 40, 44, 48, 52, 56, 60, 64).

Slovakian

Spoločnosť Lenovo (Singapore) Pte. Ltd. týmto vyhlasuje, že bezdrôtové zariadenie uvedené v tejto časti je v súlade so smernicou o rádiových zariadeniach 2014/53/EÚ.

Úplné texty vyhlásenia EÚ o zhode pre systém a vyhlásení EÚ pre bezdrôtové moduly sú dostupné na nasledujúcej internetovej adrese:

www.lenovo.com/eu-doc-desktops

www.lenovo.com/eu-doc-workstations

Obmedzenie frekvenčného pásma EÚ pre bezdrôtovú sieť LAN

Používanie tohto zariadenia je obmedzené na interiér vo frekvenčnom pásme 5 150 až 5 350 MHz (kanály 36, 40, 44, 48, 52, 56, 60, 64).

Slovenian

Lenovo (Singapore) Pte. Ltd. s tem izjavlja, da je brezžična oprema, navedena v tem razdelku, v skladu z direktivo o radijski opremi 2014/53/EU.

Celotno besedilo izjave EU o skladnosti za sistem in morebitnih deklaracij EU za brezžični modul je na voljo na tem spletnem naslovu:

www.lenovo.com/eu-doc-desktops

www.lenovo.com/eu-doc-workstations

Omejitev Evropske unije glede frekvenčnega pasu za brezžična krajevna omrežja

Ta naprava je omejena na notranjo uporabo v pasu od 5150 do 5350 MHz (kanali 36, 40, 44, 48, 52, 56, 60, 64).

Spanish

Mediante el presente documento, Lenovo (Singapore) Pte. Ltd., declara que el equipo inalámbrico indicado en esta sección cumple con la Directiva de Equipos de Radio 2014/53/UE.

El texto completo del sistema Declaración de conformidad UE y las declaraciones de los módulos inalámbricos de la UE, si corresponde, están disponibles en la siguiente dirección de Internet:

www.lenovo.com/eu-doc-desktops

www.lenovo.com/eu-doc-workstations

Restricción de banda de frecuencia de la UE para LAN inalámbrica

La utilización de este dispositivo está limitada a interiores en la banda de 5150 MHz a 5350 MHz (canales 36, 40, 44, 48, 52, 56, 60, 64).

Swedish

Härmed intygar Lenovo (Singapore) Pte. Ltd. att den trådlösa utrustningen i det här avsnittet överensstämmer med direktivet för radioutrustning 2014/53/EU.

Den fullständiga texten i EU-deklarationen om överensstämmelse och EU-deklarationen om trådlösa moduler för systemet finns, om tillämpligt, på följande webbadress:

www.lenovo.com/eu-doc-desktops

www.lenovo.com/eu-doc-workstations

Frekvensområdesbegränsning inom EU för trådlöst nätverk

Enheten får bara användas inomhus i frekvensområdet 5150–5350 MHz (kanal 36, 40, 44, 48, 52, 56, 60, 64).

Turkish

Lenovo (Singapore) Pte. Ltd., bu bölümde listelenen kablosuz cihazların temel gereksinimler ve Radyo Ekipmanları Yönetmeliği 2014/53/EC ile uyumlu olduğunu beyan eder.

Sisteme ait AB uyumluluk bildirimini ve ABD kablosuz modülü bildirimlerinin tam metni şu İnternet adresinde sunulmaktadır:

www.lenovo.com/eu-doc-desktops

www.lenovo.com/eu-doc-workstations

Kablosuz LAN için AB Frekans bandı kısıtlaması

Bu cihazın kullanımı iç mekanlarda, 5150 - 5350 MHz bant aralığı (36, 40, 44, 48, 52, 56, 60, 64 kanalları) ile sınırlıdır.

Notice for users in India

For model: 3165NGW

NR-ETA/1623

NR-ETA/1624

For model: 8265NGW

NR-ETA-/4791

NR-ETA-/4792

For model: RTL8822BE

NR-ETA-/4671

NR-ETA-/4670

For model: RTL8821CE

NR-ETA/5229-RLO(NR)

NR-ETA/5230-RLO(NR)

For model: 9462NGW

NR-ETA/7902-RLO(NR)

NR-ETA/7903-RLO(NR)

For model: 8260NGW

NR-ETA/2401

NR-ETA/2402

For model: QCNFA34AC

ETA-187/2014-RLO(SR)

For model: QCNFA435

ETA-010/2015-RLO(SR)/454

ETA-011/2015-RLO(SR)/455

For model: RTL8822CE

SR-ETA/20189288

SR-ETA/20189289



Notice for users in Japan

内蔵無線アダプターを日本国内でご使用になる際の注意

日本国内で無線 LAN アダプターおよび Bluetooth アダプターをご使用になる場合の注意

本製品が装備する無線アダプターは、電波法および電気通信事業法により技術基準認証を下記のとおり取得しています。本製品に組み込まれた無線設備を他の機器で使用する場合は、当該機器が上記と同じく認証を受けていることをご確認ください。認証されていない機器での使用は、電波法の規定により認められていません。

Table 1. 無線 LAN/Bluetooth アダプター

認証申請者名	認証製品名	認証番号
Intel Mobile Communications S. A.S.	3165NGW 1	 003-150009  D150008003
	9462NGW 1	 003-170245  D170151003
	8260NGW 1	 003-150093  D150069003
	8265NGW 1	 003-160104  D160055003
Qualcomm Atheros, Inc.	QCNFA34AC 1	 003-140109  D140067003
	QCNFA435 1	 003-140299  D140299003
Realtek Semiconductor Corp.	RTL8821CE 1	 201-163301  D160283201
	RTL8822CE 1	 201-180775  D180171201
	RTL8822BE 1	 201-160557  D160122201
Microchip	BM23SPKXY 1	 202-SMC067

1: 無線 LAN および Bluetooth 両用型の無線装置です。

(5 GHz の場合)

5 GHz帯は屋内使用限定(登録局との通信を除く)。

(2.4 GHz の場合)

この機器の使用周波数帯では、電子レンジ等の産業・科学・医療用機器のほか工場の製造ライン等で使用されている移動体識別用の構内無線局(免許を要する無線局)および特定小電力無線局(免許を要しない無線局)並びにアマチュア無線局(免許を要する無線局)が運用されています。

1. この機器を使用する前に、近くで移動体識別用の構内無線局及び特定小電力無線局並びにアマチュア無線局が運用されていないことを確認してください。
2. 万一、この機器から移動体識別用の構内無線局に対して電波干渉の事例が発生した場合には、速やかに使用周波数を変更するかまたは電波の発射を停止した上で、下記連絡先にご連絡頂き、混信回避のための処置等についてご相談ください。
3. その他、この機器からの移動体識別用の特定小電力無線局あるいはアマチュア無線局に対して有害な電波干渉の事例が発生した場合など何かお困りのことが起きたときには、次の連絡先にお問い合わせください。

連絡先: レノボ・スマートセンター(スマートセンターのご利用方法は、次のホームページでご確認頂けます。<http://www.lenovo.com/jp/lsmartctr/>)



無線 LAN アダプター (IEEE802.11b/g 準拠) の場合

この機器が、2.4 GHz 周波数帯 (2400 から 2483.5 MHz) を使用する直接拡散 (DS) 方式および直交周波数分割多重方式 (OFDM) の無線装置で、干渉距離が約 40 m (定格出力 10 mW/MHz) であることを意味しています。



Bluetooth アダプターの場合

この機器が、2.4 GHz 周波数帯 (2400 から 2483.5 MHz) を使用する周波数ホッピング (FH) 方式の無線装置で、干渉距離が約 10 m であることを意味します。

2.4FH2

Bluetooth アダプターの場合

この機器が、2.4 GHz 周波数帯 (2400 から 2483.5 MHz) を使用する周波数ホッピング (FH) 方式の無線装置で、干渉距離が約 20 m であることを意味します。

2.4FH4

Bluetooth アダプターの場合

この機器が、2.4 GHz 周波数帯 (2400 から 2483.5 MHz) を使用する周波数ホッピング (FH) 方式の無線装置で、干渉距離が約 40 m であることを意味します。

2.4FH8

Bluetooth アダプターの場合

この機器が、2.4 GHz 周波数帯 (2400 から 2483.5 MHz) を使用する周波数ホッピング (FH) 方式の無線装置で、干渉距離が約 80 m であることを意味します。

以上の内容は、「社団法人 電波産業会」ARIB STD-T66の趣旨に基づくものです。

無線 LAN 製品ご使用時におけるセキュリティに関するご注意

無線 LAN では、LAN ケーブルを使用する代わりに、電波を利用してパソコン等と無線アクセスポイント間で情報のやり取りを行うため、電波の届く範囲であれば自由に LAN 接続が可能であるという利点があります。その反面、電波はある範囲内であれば障害物 (壁等) を越えてすべての場所に届くため、セキュリティに関する設定を行っていない場合、以下のような問題が発生する可能性があります。

- 通信内容を盗み見られる 悪意ある第三者が、電波を故意に傍受し、
 - ID やパスワード又はクレジットカード番号等の個人情報
 - メールの内容等の通信内容を盗み見られる可能性があります。
- 不正に侵入される 悪意ある第三者が、無断で個人や会社内のネットワークへアクセスし、
 - 個人情報や機密情報を取り出す (情報漏洩)
 - 特定の人物になりすまして通信し、不正な情報を流す (なりすまし)
 - 傍受した通信内容を書き換えて発信する (改ざん)
 - コンピュータウイルスなどを流しデータやシステムを破壊する (破壊)などの行為をされてしまう可能性があります。

本来、無線 LAN カードや無線アクセスポイントは、これらの問題に対応するためのセキュリティの仕組みを持っていますので、無線 LAN 製品のセキュリティに関する設定を行って製品を使用することで、その問題が発生する可能性は少なくなります。

セキュリティの設定を行わないで使用した場合の問題を充分理解した上で、お客様自身の判断と責任においてセキュリティに関する設定を行い、製品を使用することをお奨めします。

使用環境および快適に使用するために

ワイヤレス LAN PCI Express ミニ・カード、および Bluetooth デバイスは、ほかの無線装置のように無線周波数電磁波を放射します。しかしながら、これらの無線装置が発する電磁波が人体へ与える影響は、頭部等へ直接接触して使用される携帯電話などの機器とは異なり、とても弱いレベルのものです。

ワイヤレス LAN PCI Express ミニ・カード、および Bluetooth デバイスは、無線周波数に関する安全基準や勧告などのガイドラインに従って動作するもので、Lenovo®は、消費者が内蔵ワイヤレス・カードを使用しても安全であると考えます。これらの標準および勧告は、科学者団体の合意や広範な研究文献を頻繁に検討、調査している科学者のパネルや委員会の審議の結果を反映しています。

状況や環境によって、建物の所有者や組織の代表責任者がワイヤレス LAN PCI Express ミニ・カード、または Bluetooth デバイスの使用を制限することがあります。たとえば、次のような場合や場所です。

- 飛行機の搭乗中、病院内、あるいはガソリンスタンド、(電気式発火装置のある) 爆発の危険のある場所、医療用インプラント、またはペースメーカーなどの装着式医療用電子機器の近くで、内蔵ワイヤレス・カードを使用すること。

- 他の装置や機能に対して有害と認識または確認されている妨害を起こす危険性がある場合。

特定の場所で (たとえば空港や病院など) ワイヤレス・デバイスの使用が許可されているかどうか分からない場合は、ideacentre の電源を入れる前に、ワイヤレス LAN PCI Express ミニ・カード、または Bluetooth デバイスを使用してもよいかどうかをお尋ねください。

Notice for users in Argentina (Nota para Uso en Argentina)

For model: QCNFA34AC
Transceptor
CNC C-13621

For model: QCNFA435
Transceptor
CNC C-14476

For model: RTL8821CE

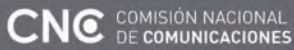

Modelo: RTL8821CE
Equipo: Transceptor
CNC: C-17250

For model: RTL8822CE

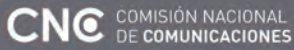

Modelo: RTL8822CE
Equipo: Transceptor
CNC: C-22785

For model: 8260NGW



Modelo: Intel 8260NGW
Equipo: Acceso Inalambrico de Red
CNC: C-14836

For model: 3165NGW



Modelo: Intel 3165NGW
Equipo: Acceso Inalambrico de Red
CNC: C-14440

For model: RTL8822BE

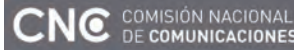

Modelo: RTL8822BE
Equipo: Transceptor
CNC: C-16809

For model: 9462NGW



Modelo: Intel 9462NGW
Equipo: Acceso Inalambrico de Red
CNC: C-20987

Notice for users in Brazil (Aviso para os utilizadores no Brasil)

For 8260NGW



For 3165NGW



For QCNFA34AC (NFA344)



For QCNFA435



For RTL8821CE



For RTL8822BE



For 8265NGW



For 9462NGW



For RTL8822BE



Brazilian Portuguese	Este equipamento opera em caráter secundário, isto é, não tem direito a proteção contra interferência prejudicial, mesmo de estações do mesmo tipo, e não pode causar interferência a sistemas operando em caráter primário
English	This equipment is a secondary type device, that is, it is not protected against harmful interference, even if the interference is caused by a device of the same type, and it also cannot cause any interference to primary type devices.

Notice for users in Korea

For models: 8260NGW, 8265NGW, 3165NGW, QCNFA435, RTL8821CE, RTL8822BE, BM23SPKXY, RTL8822CE, 9462NGW and QCNFA34AC

B 급 기기 (가정용 방송통신기자재)

이 기기는 가정용(B 급) 전자파적합기기로서 주로 가정에서 사용하는 것을 목적으로하며, 모든 지역에서 사용할 수 있습니다.

무선설비 전파 혼신 (사용주파수 2400~2483.5 , 5725~5825 무선제품해당)
해당 무선설비가 전파혼신 가능성이 있으므로 인명안전과 관련된 서비스는 할 수 없음

Notice for users in Mexico (Nota para uso en Mexico)

For model: 8260NGW

Equipo:Adaptator INTEL® 8260NGW
IFT: RCPIN8215-0957

For model: 3165NGW

Intel 3165NGW
IFT: RCPIN3115-0385

For model: 8265NGW

Equipo:Adaptator INTEL® 8265NGW
IFT: RCPIN8216-0896

For model: RTL8821CE

Module Combo 802.11a/b/g/n/ac
IFT: RCPRERT17-0354

For model: 9462NGW

Equipo:Adaptator INTEL® wireless AC 9462
IFT: RCPIN9417-2005

For model: QCNFA34AC

Tarjeta TIPO M.2 802.11a/b/g/n/ac+BT4.1
IFT: RCPQUQC14-1244

For model: QCNFA435

Tableta tipo single stream 802.11a/b/g/n/ac+BT 4.1 M.2
Cofetel: RCPQUQC15-0323

For model: RTL8822BE

Module Combo Modulo Wi-Fi
IFT: RCPRERT16-1591

For model: RTL8822CE

Module Combo 802.11a/b/g/n/ac
IFT: RCPRERT18-2159

Advertencia:

En Mexico la operación de este equipo está sujeta a las siguientes dos condiciones: (1) es posible que este equipo o dispositivo no cause interferencia perjudicial y (2) este equipo o dispositivo debe aceptar cualquier interferencia, incluyendo la que pueda causar su operación no deseada.

Notice for users in Morocco

For models: 8260NGW, 8265NGW, 3165NGW, QCNFA435, RTL8821CE, RTL8822BE, RTL8822CE, 9462NGW and QCNFA34AC

The operation of this product in the radio channel 2 (2417 MHz) is not authorized in the following cities: Agadir, Assa-Zag, Cabo Negro, Chaouen, Goulmima, Oujda, Tan Tan, Taourirt, Taroudant and Taza.

The operation of this product in the radio channels 4, 5, 6, and 7 (2425 - 2442 MHz) is not authorized in the following cities: Aéroport Mohamed V, Agadir, Aguelmous, Anza, Benslimane, Béni Hafida, Cabo Negro, Casablanca, Fès, Lakkab, Marrakech, Merchich, Mohammédia, Rabat, Salé, Tanger, Tan Tan, Taounate, Tit Mellil, Zag.

Due to the channel restrictions above, the operation of this product using the fat channel mode (40 MHz of channel bandwidth) is not allowed at the 2.4 GHz frequency band.

Notice for users in Nigeria

For models: 8260NGW, 8265NGW, 3165NGW, QCNFA435, RTL8821CE, RTL8822BE, RTL8822CE, 9462NGW and QCNFA34AC

Connection and use of this
communications equipment
is permitted by the Nigerian
Communications Commission

Notice for users in Pakistan

The following adapters have been approved by Pakistan Telecommunication Authority (PTA): 8260NGW, 8265NGW, 3165NGW, QCNFA435, RTL8821CE, RTL8822BE, RTL8822CE, 9462NGW and QCNFA34AC

Notice for users in Saudi Arabia

For model: 8260NGW



هيئة الاتصالات وتقنية المعلومات
Communications and Information Technology Commission

شهادة مطابقة Conformity Certificate

Certificate No: **2018-787** رقم الشهادة :

معلومات مقدم الطلب		
Applicant Information	معلومات مقدم الطلب	
Applicant:	Intel Mobile Communications SAS	اسم الجهة :
بيانات الشهادة		
Issue Date:	26/06/2018	1439/10/12 تاريخ الاصدار :
Validity Period:	26/06/2020	1441/11/05 تاريخ الانتهاء :
بيانات الجهاز		
Product Name:	INTEL 8260NGW	اسم المنتج :
Product Model:	8260NGW	موديل المنتج :
Manufacturer:	INTEL MOBILE COMMUNICATIONS	المصنع :
معلومات اضافية		
Operating Frequency : Maximum Output Power allowed (EIRP) :	2400-2483 MHz:100 mW 5150-5350 MHz:200 mW 5470-5825 MHz:200 mW	الترددات المستخدمة : وطاقة الخرج القصوى المسموحة
Device comply with CITC technical Specification No.:	RI103 , RI045	الجهاز مطابق لمواصفات الهيئة رقم :
Additional Requirement	الالتزام بضوابط استخدام الشبكات الاسلكية المحلية (WLAN - WiFi)	



يمكن التحقق من صحة وصلاحيه هذه الشهادة من خلال زيارة الرابط اثناء في
الموقع الإلكتروني لهيئة الاتصالات وتقنية المعلومات
عن طريق استخدام
أو الرمز التالي :
<http://ers.citc.gov.sa>



اعتماد الشهادة

بناء على نظام الاتصالات الصادر بالمرسوم الملكي ذي الرقم (12/م) والتاريخ 1422/03/12هـ ولانتهه التنفيذية، وبموجب تنظيم هيئة الاتصالات وتقنية المعلومات بقرار
مجلس الوزراء رقم (74) والتاريخ 1422/03/05هـ فقد اصدرت الهيئة هذه الوثيقة بخصوص مطابقة الجهاز المشار اليه اعلام، علماً بأن هذه الوثيقة لا تعتبر موافقة على فتح
الاجهزة المشار إليها اعلان أو الترخيص باستخدامها، بل هي شهادة مطابقة للمواصفات الفنية المعمول بها بالهيئة. كما أن هذه الشهادة قد صدرت عن الهيئة بناء على المعلومات
المتاحة لها والتي وفرتها الجهة المستوردة أو المصنعة وقت صدور هذه الشهادة، ولا يجوز استخدام أو حيازة الاجهزة أو المتاجرة بها بصورة تخالف أحكام وأنظمة هيئة الاتصالات
وتقنية المعلومات والأنظمة الأخرى ذات العلاقة المعمول بها في المملكة، وتحمل الجهة المستوردة أو المصنعة وحدها المسؤولية عن أية أضرار أو خسائر أو إصابات قد تنشأ عن
حيازة أو استخدام هذه الاجهزة أو المتاجرة بها. وفي حال كون الاجهزة مصنعة خارج المملكة فإنه يجب التقدم إلى الهيئة من قبل المستورد بطلب لفتح الاجهزة قبل وقت وصولها
إلى أحد المنافذ الجمركية.



شهادة مطابقة
Conformity Certificate

Certificate No: 2019-320 رقم الشهادة :

Applicant Information		معلومات مقدم الطلب
Applicant:	Intel Corporation SAS	اسم الجهة :
Certificate Details		بيانات الشهادة
Issue Date:	11/02/2019	1440/06/06 تاريخ الإصدار :
Validity Period:	11/02/2021	1442/06/29 تاريخ الانتهاء :
Device Details		بيانات الجهاز
Product Name:	Intel Dual Band Wireless AC 3165	اسم المنتج :
Product Model:	Intel 3165NGW	موديل المنتج :
Manufacturer:	INTEL MOBILE COMMUNICATIONS	المصنع :
Additional Details		معلومات إضافية
Operating Frequency : Maximum Output Power allowed (EIRP) :	2400-2483.5 MHz:100 mW 5150-5350 MHz:200 mW 5470-5825 MHz:200 mW	الترددات المستخدمة : وطاقة الخرج القصوى المسموحة
Device comply with CITC technical Specification No.:	RI045	الجهاز مطابق لمواصفات الهيئة رقم :
Additional Requirement	الالتزام بظوابط استخدام الشبكات اللاسلكية الصحية (WLAN / WiFi)	متطلبات إضافية



يمكن التحقق من صحة وصلاحيه هذه الشهادة من خلال زيارة الرابط اثناء في الموقع الإلكتروني لهيئة الاتصالات وتقنية المعلومات
عن طريق استخدام الرمز التالي :

<http://ers.citc.gov.sa>



اعتماد الشهادة

بناءً على نظام الاتصالات الصادر بالمرسوم الملكي ذي الرقم (12/م) والتاريخ 1422/03/12 هـ ولائحته التنفيذية وبموجب تنظيم هيئة الاتصالات وتقنية المعلومات بنسبته مجلس الوزراء رقم (74) والتاريخ 1422/03/05 هـ، فقد أصدرت الهيئة هذه الرقعة بخصوص مطابقة الجهاز المشار إليه أعلاه، علماً بأن هذه الرقعة لا تعتبر موافقة على طرح الأجهزة المشار إليها أعلاه أو الترخيص باستخدامها، بل هي شهادة مطابقة للمواصفات الفنية المعمول بها بالهيئة، كما أن هذه الشهادة قد صدرت عن الهيئة بناءً على المعلومات المتأخذة لها والتي وفرتها الجهة المستوردة أو المصنعة وقت صدور هذه الشهادة، ولا يجوز استخدام أو حيازة الأجهزة أو المتاجرة بها بصورة تخالف أحكام وأنظمة هيئة الاتصالات وتقنية المعلومات والأنظمة الأخرى ذات العلاقة المعمول بها في المملكة، ولتحليل الجهة المستوردة أو المصنعة وحدها المسؤولية عن أية أضرار أو خسائر أو إصابات قد تنتج عن حيازة أو استخدام هذه الأجهزة أو المتاجرة بها، وفي حال كون الأجهزة مصنعة خارج المملكة فإنه يجب التقدم إلى الهيئة من قبل المستورد بطلب لفتح الأجهزة قبل وقت وصولها إلى أحد المداخل الجمركية.



شهادة مطابقة
Conformity Certificate

Certificate No: 2018-1099 : رقم الشهادة :

معلومات مقدم الطلب		
Applicant Information		
Applicant:	Intel Mobile Communications SAS	اسم الجهة :
بيانات الشهادة		
Certificate Details		
Issue Date:	23/07/2018	1439/11/10 : تاريخ الاصدار :
Validity Period:	23/07/2020	1441/12/02 : تاريخ الانتهاء :
بيانات الجهاز		
Device Details		
Product Name:	INTEL 8265NGW	اسم المنتج :
Product Model:	8265NGW	موديل المنتج :
Manufacturer:	INTEL MOBILE COMMUNICATIONS	المصنع :
معلومات اضافية		
Additional Details		
Operating Frequency : Maximum Output Power allowed (EIRP) :	2400-2483.5 MHz:19.6 dBm 5150-5250 MHz:22.3 dBm 5470-5725 MHz:22.4 dBm 2400-2483.5 MHz:9.5 dBm 2400-2483.5 MHz:14.9 dBm 5250-5350 MHz:22.2 dBm 5725-5850 MHz:13.98 dBm	الترددات المستخدمة : وطاقة الخرج القصوى المسموحة
Device comply with CITC technical Specification No.:	RI103 ; RI045	الجهاز مطابق لمواصفات الهيئة رقم :
Additional Requirement	متطلبات اضافية	



يمكن التحقق من صحة وصلاحيه هذه الشهادة من خلال زيارة الرابط اثناء في الموقع الإلكتروني لهيئة الاتصالات وتقنية المعلومات

عن طريق استخدام
أو الرمز التالي :

<http://ers.citc.gov.sa>



اعتماد الشهادة

بناء على نظام الاتصالات الصادر بالمرسوم الملكي ذي الرقم (12/م) والتاريخ 1422/03/12هـ - ولائحته التنفيذية، وبموجب تنظيم هيئة الاتصالات وتقنية المعلومات بقسورار مجلس الوزراء رقم (74) والتاريخ 1422/03/05هـ، فقد اصدرت الهيئة هذه الوثيقة بخصوص مطابقة الجهاز المشار اليه اعلا، طالما بان هذه الوثيقة لا تعتبر موافقة على فتح الأجهزة المشار إليها اعلا، أو الترخيص باستخدامها، بل هي شهادة مطابقة للمواصفات الفنية المعمول بها بالهيئة، كما أن هذه الشهادة قد صدرت عن الهيئة بناء على المعلومات المتناخذه لها والتي وفرتها الجهة المستوردة والمصنعة وقت صدور هذه الشهادة، ولا يجوز استخدام أو حيازة الأجهزة أو المتاجرة بها بصورة تخالف أحكام وأنظمة هيئة الاتصالات وتقنية المعلومات والأنظمة الأخرى ذات العلاقة المعمول بها في المملكة، وتحمل الجهة المستوردة أو المصنعة وحدها المسؤولية عن أية أضرار أو خسائر أو إصابات قد تنشأ عن حيازة أو استخدام هذه الأجهزة أو المتاجرة بها. وفي حال كون الأجهزة مصنعة خارج المملكة فإنه يجب التقدم إلى الهيئة من قبل المستورد بطلب لمسح الأجهزة قبل لوقت وصولها إلى أحد المنافذ الجمركية.



شهادة مطابقة
Conformity Certificate

Certificate No: 13032018-14042019-22290 رقم الشهادة :

Applicant Information		معلومات مقدم الطلب
Applicant:	MARKET SUCCESS (S) PTE LTD	اسم الجهة :
Certificate Details		بيانات الشهادة
Issue Date:	14/04/2017 1438/07/17	تاريخ الاصدار :
Validity Period:	14/04/2019 1440/08/09	تاريخ الانتهاء :
Device Details		بيانات الجهاز
Product Name:	802.11a/b/n/ac+BT 4.1 M.2 Type Card	اسم المنتج :
Product Model:	QCNFA34AC	موديل المنتج :
Manufacturer:	Qualcomm Atheros, Inc.	المصنع :
Additional Details		معلومات اضافية
Operating Frequency : Maximum Output Power allowed (EIRP) :	2400-2483.5 MHZ:19.88 dBm 5150-5825 MHZ:22.63 dBm	الترددات المستخدمة : وطاقة الخرج القصوى المسموحة
Device comply with CITC technical Specification No.:	RI103 , RI045	الجهاز مطابق لمواصفات الهيئة رقم :
Additional Requirement	الانترام بضوابط استخدام الشبكات الاسلكية المحلية (WLAN - WIFI)	متطلبات اضافية



يمكن التحقق من صحة وصلاحيه هذه الشهادة من خلال زيارة الرابط اثناء في الموقع الإلكتروني لهيئة الاتصالات وتقنية المعلومات

عن طريق استخدام
أو الرمز التالي :

<http://ers.citc.gov.sa>



اعتماد الشهادة

بناءً على نظام الاتصالات الصادر بالمرسوم الملكي ذي الرقم (12/م) والتاريخ 1422/03/12 هـ والائحة التنفيذية، وبموجب تنظيم هيئة الاتصالات وتقنية المعلومات بقرار مجلس الوزراء رقم (74) والتاريخ 1422/03/05 هـ، قد أصدرت الهيئة هذه الوثيقة بخصوص مطابقة الجهاز المشار إليه أعلاه، علماً بأن هذه الوثيقة لا تعتبر موافقة على فتح الأجهزة المشار إليها أعلاه أو الترخيص باستخدامها، بل هي شهادة مطابقة للمواصفات الفنية المعمول بها بالهيئة، كما أن هذه الشهادة قد صدرت عن الهيئة بناءً على المعلومات المتاحة لها والتي وفرتها الجهة المستوردة أو المصنعة وقت صدور هذه الشهادة، ولا يجوز استخدام أو حيازة الأجهزة أو المتاجرة بها بصورة تخالف أحكام والنظمة هيئة الاتصالات وتقنية المعلومات والأنظمة الأخرى ذات العلاقة المعمول بها في المملكة، وتحمل الجهة المستوردة أو المصنعة وحدها المسؤولية عن أية أضرار أو خسائر أو إصابات قد تنشأ عن حيازة أو استخدام هذه الأجهزة أو المتاجرة بها، وفي حال كون الأجهزة مصنعة خارج المملكة فإنه يجب التقدم إلى الهيئة من قبل المستورد بطلب لفحص الأجهزة قبل لوقت وصولها إلى أحد المنافذ الجمركية.

شهادة مطابقة
Conformity Certificate

Certificate No: TA 07122016-28012018-18495 رقم الشهادة :

Applicant Information		معلومات مقدم الطلب
Applicant:	HUAT SING (S) PTE LTD	اسم الجهة :
Certificate Details		بيانات الشهادة
Issue Date:	29/01/2018 12/05/1439	تاريخ الاصدار :
Validity Period:	29/01/2020 1441/06/04	تاريخ الانتهاء :
Device Details		بيانات الجهاز
Product Name:	Single Stream 802.11a/b/g/n/ac+BT 4.1 M.2	اسم المنتج :
Product Model:	QCNFA435	موديل المنتج :
Manufacturer:	Qualcomm Atheros, Inc.	المصنع :
Additional Details		معلومات اضافية
Operating Frequency : Maximum Output Power allowed (EIRP) :	2400-2483.5 MHz:19.85 dBm 5150-5350 MHz:22.21 dBm 2402-2480 MHz:8.34 dBm 5350-5825 MHz:22.21 dBm	الترددات المستخدمة : وطاقة الخرج القصوى المسموحة
Device comply with CITC technical Specification No.:	IT005 , RI045 , RI103	الجهاز مطابق لمواصفات الهيئة رقم :
Additional Requirement	الالتزام بضوابط استخدام الشبكات اللاسلكية المحلية (WLAN - WIFI)	متطلبات اضافية

يمكن التحقق من صحة وصلاحيه هذه الشهادة من خلال زيارة الرابط ادناه في
الموقع الإلكتروني لهيئة الاتصالات وتقنية المعلومات
عن طريق استخدام
الرمز التالي :
<http://ers.citc.gov.sa>



اعتماد الشهادة

بناء على نظام الاتصالات الصادر بالمرسوم الملكي ذي الرقم 12/م (و التاريخ 1422/03/12 هـ - ولائحته التنفيذية) وبموجب تنظيم هيئة الاتصالات وتقنية المعلومات بقرار
مجلس الوزراء رقم (74) (و التاريخ 1422/03/05 هـ) فقد أصدرت الهيئة هذه الوثيقة بخصوص مطابقة الجهاز المشار إليه أعلاه. علماً بأن هذه الوثيقة لا تعتبر موافقة على فتح
الأجهزة المشار إليها أعلاه أو الترخيص باستخدامها، بل هي شهادة مطابقة للمواصفات الفنية المعمول بها بالهيئة، كما أن هذه الشهادة قد صدرت عن الهيئة بناءً على المعلومات
المتاحة لها والتي وفرتها الجهة المستوردة أو المصنعة وقت صدور هذه الشهادة، ولا يجوز استخدام أو حيازة الأجهزة أو المتاجرة بها بصورة تخالف أحكام وأنظمة هيئة الاتصالات
وتقنية المعلومات، والأنظمة الأخرى ذات العلاقة المعمول بها في المملكة، وبالحمل المجهه المستوردة أو المصنعة ومدعها المستوردة عن أية لمرار أو خسائر أو (تدابير قد نشأ عن
حيازة أو استخدام هذه الأجهزة أو المتاجرة بها. وفي حال كون الأجهزة مصنعة خارج المملكة فإنه يجب التقدم إلى الهيئة من قبل المستورد بطلب لمصح الأجهزة قبل بوقت وصولها
إلى أحد المنافذ الجمركية.



شهادة مطابقة
Conformity Certificate

Certificate No: 2019-150 : رقم الشهادة :

Applicant Information		معلومات مقدم الطلب
Applicant:		اسم الجهة :
Certificate Details		بيانات الشهادة
Issue Date:	23/01/2019	1440/05/17 : تاريخ الاصدار :
Validity Period:	23/01/2021	1442/06/10 : تاريخ الانتهاء :
Device Details		بيانات الجهاز
Product Name:	RTL8821CE	اسم المنتج :
Product Model:	RTL8821CE	موديل المنتج :
Manufacturer:	Realtek Semiconductor Corp.	المصنع :
Additional Details		معلومات اضافية
Operating Frequency : Maximum Output Power allowed (EIRP) :	2400-2483.5 MHz:19.99 dBm 5150-5725 MHz:22.73 dBm	الترددات المستخدمة : وطاقة الخرج القصوى المسموحة
Device comply with CITC technical Specification No.:	GEN001 , RI04S , RI103	الجهاز مطابق لمواصفات الهيئة رقم :
Additional Requirement	(WLAN / WiFi) المتطلبات الاسلكية المحلية	متطلبات اضافية



يمكن التحقق من صحة وصلاحيه هذه الشهادة من خلال زيارة الرابط ادناه في
الموقع الإلكتروني لهيئة الاتصالات وتقنية المعلومات
عن طريق استخدام
أو الرمز التالي :

<http://ers.citc.gov.sa>



اعتماد الشهادة

بناءً على نظام الاتصالات الصادر بالمرسوم الملكي ذي الرقم (12/م) والتاريخ 1422/03/12 هـ ولائحته التنفيذية، وبموجب تنظيم هيئة الاتصالات وتقنية المعلومات بقرار
مجلس الوزراء رقم (74) والتاريخ 1422/03/05 هـ، فقد أصدرت الهيئة هذه الوثيقة بخصوص مطابقة الجهاز المشار إليه أعلاه، علماً بأن هذه الوثيقة لا تعتبر موافقة على قسح
الأجهزة المشار إليها أعلاه أو الترخيس باستخدامها، بل هي شهادة مطابقة للمواصفات الفنية المعمول بها بالهيئة، كما أن هذه الشهادة قد صدرت عن الهيئة بناءً على المعلومات
المتاحة لها والتي وفرتها الجهة المستوردة أو المصنعة وقت صدور هذه الشهادة، ولا يجوز استخدام أو حيازة الأجهزة أو المتاجرة بها بصورة تخالف أحكام والنظمة هيئة الاتصالات
وتقنية المعلومات والأنظمة الأخرى ذات العلاقة المعمول بها في المملكة، وتحمل الجهة المستوردة أو المصنعة وحدها المسؤولية عن أية أضرار أو خسائر أو إصابات قد تنشأ عن
حيازة أو استخدام هذه الأجهزة أو المتاجرة بها. وفي حال كون الأجهزة مصنعة خارج المملكة فإنه يجب التقدم إلى الهيئة من قبل المستورد بطلب لنسح الأجهزة قبل وقت وصولها
إلى أحد المنافذ الجمركية



شهادة مطابقة
Conformity Certificate

Certificate No: 2018-1235 رقم الشهادة :

Applicant Information		معلومات مقدم الطلب
Applicant:		اسم الجهة :
Certificate Details		بيانات الشهادة
Issue Date:	05/08/2018 1439/11/23	تاريخ الإصدار :
Validity Period:	05/08/2020 1441/12/15	تاريخ الانتهاء :
Device Details		بيانات الجهاز
Product Name:	802.11 a/b/g/n/ac RTL8822BE Combo module	اسم المنتج :
Product Model:	RTL8822BE	موديل المنتج :
Manufacturer:	Realtek Semiconductor Corp.	المصنع :
Additional Details		معلومات إضافية
Operating Frequency : Maximum Output Power allowed (EIRP) :	2400-2483.5 MHz:19.98 dBm 5150-5250 MHz:22.93 dBm 5250-5350 MHz:22.97 dBm 5470-5725 MHz:22.97 dBm 5725-5825 MHz:29.11 dBm	الترددات المستخدمة : وطاقة الخرج القصوى المسموحة
Device comply with CITC technical Specification No.:	R1045, R1103	الجهاز مطابق لمواصفات الهيئة رقم :
Additional Requirement	لائزيم بصواب استخدام الشبكات اللاسلكية الضخمية (WLAN - WiFi)	متطلبات إضافية



يمكن التحقق من صحة وصلاحيه هذه الشهادة من خلال زيارة الرابط اثناء في الموقع الإلكتروني لهيئة الاتصالات وتقنية المعلومات
عن طريق استخدام أو الرمز التالي :

<http://ers.citc.gov.sa>



اعتماد الشهادة

بناء على نظام الاتصالات الصادر بالمرسوم الملكي ذي الرقم (12/هـ) والتاريخ 1422/03/12 هـ ولأئحته التنفيذية، وبموجب تنظيم هيئة الاتصالات وتقنية المعلومات بقسورار مجلس الوزراء رقم (74) والتاريخ 1422/03/05 هـ، فقد أصدرت الهيئة هذه الوثيقة بخصوص مطابقة الجهاز المشار إليه أعلاه، علماً بأن هذه الوثيقة لا تعتبر موافقة على فتح الأجهزة المشتركة إليها أعلاه أو الترخيص باستخدامها، بل هي شهادة مطابقة للمواصفات الفنية المعمول بها بالهيئة، كما أن هذه الشهادة قد صدرت من الهيئة بناءً على المعلومات المتاحه لها والتي وفرتها الجهة المستوردة أو المصنعة وقت صدور هذه الشهادة، ولا يجوز استخدام أو حيازة الأجهزة أو المتاجر بها بصورة تخالف أحكام وأنظمة هيئة الاتصالات وتقنية المعلومات والأنظمة الأخرى ذات العلاقة المعمول بها في المملكة، وتعمل الجهة المستوردة أو المصنعة وحدها المسؤولة عن أية أضرار أو خسائر أو إصابات قد تنشأ عن حيازة أو استخدام هذه الأجهزة أو المتاجر بها، وفي حال كون الأجهزة مصنعة خارج المملكة فإنه يجب التقدم إلى الهيئة من قبل المستورد بطلب لفحص الأجهزة قبل وقت وصولها إلى أحد المنافذ الجمركية.



شهادة مطابقة
Conformity Certificate

Certificate No: TA 2018-2267 : رقم الشهادة :

Applicant Information		معلومات مقدم الطلب
Applicant:	BVCPS H.K. Ltd, Taoyuan Branch	اسم الجهة :
Certificate Details		بيانات الشهادة
Issue Date:	16/11/2018 1440/03/08	تاريخ الاصدار :
Validity Period:	16/11/2020 1442/04/01	تاريخ الانتهاء :
Device Details		بيانات الجهاز
Product Name:	802.11a/b/g/n/ac RTL8822CE Combo module	اسم المنتج :
Product Model:	RTL8822CE	موديل المنتج :
Manufacturer:	Realtek Semiconductor Corp.	المصنع :
Additional Details		معلومات اضافية
Operating Frequency : Maximum Output Power allowed (EIRP) :	2400-2483.5 MHz:17.08 dBm 2400-2483.5 MHz:19.99 dBm 5150-5350 MHz:22.99 dBm 5470-5725 MHz:22.99 dBm 5725-5850 MHz:24.885 dBm	الترددات المستخدمة : وطاقة الخرج القصوى المسموحة
Device comply with CITC technical Specification No.:	RI045 , RI103	الجهاز مطابق لمواصفات الهيئة رقم :
Additional Requirement	لاتزام بضوابط استخدام الشبكات اللاسلكية المحلية (WLAN - WIFI)	متطلبات اضافية



يمكن التحقق من صحة وصلاحيه هذه الشهادة من خلال زيارة الرابط اذناه في
الموقع الإلكتروني لهيئة الاتصالات وتقنية المعلومات
عن طريق استخدام
أو الرمز التالي :

<http://ers.citc.gov.sa>



اعتماد الشهادة

بناءً على نظام الاتصالات الصادر بالمرسوم الملكي ذي الرقم (12/م) والتاريخ 1422/03/12هـ ولأخذه التنفيذ، وبموجب تنظيم هيئة الاتصالات وتقنية المعلومات بقسور
محيط الوزراء رقم (74) والتاريخ 1422/03/05هـ، فقد أصدرت الهيئة هذه الوثيقة بخصوص مطابقة الجهاز المشار إليه أعلاه، علماً بأن هذه الوثيقة لا تعتبر موافقة على فتح
الأجهزة المشار إليها أعلاه أو الترخيس باستخدامها، بل هي شهادة مطابقة للمواصفات الفنية المعمول بها بالهيئة. كما أن هذه الشهادة قد صدرت عن الهيئة بناءً على المعلومات
المتاحة لها والتي وفرتها الجهة المستوردة أو المصنعة وقت صدور هذه الشهادة، ولا يجوز استخدام أو حيازة الأجهزة أو المتاجرة بها بصورة تخالف أحكام وأنظمة هيئة الاتصالات
وتقنية المعلومات والأنظمة الأخرى ذات العلاقة المعمول بها في المملكة، وتتضمن الجهة المستوردة أو المصنعة وحدها المسؤولية عن أية أضرار أو خسائر أو إصابات قد تنشأ عن
حيازة أو استخدام هذه الأجهزة أو المتاجرة بها. وفي حال كون الأجهزة مصنعة خارج المملكة فإنه يجب التقدم إلى الهيئة من قبل المستورد بطلب لمسح الأجهزة قبل وقت وصولها
إلى أحد المنافذ الجمركية.

For model: 9462NGW



هيئة الاتصالات وتقنية المعلومات
Communications and Information Technology Commission

شهادة مطابقة Conformity Certificate

Certificate No: TA 14122017-14122019-21795 : رقم الشهادة :

Applicant Information		معلومات مقدم الطلب
Applicant:	Intel Mobile Communications SAS	اسم الجهة :
Certificate Details		بيانات الشهادة
Issue Date:	14/12/2017	1439/03/26 : تاريخ الاصدار :
Validity Period:	14/12/2019	1441/04/17 : تاريخ الانتهاء :
Device Details		بيانات الجهاز
Product Name:	Intel Wireless-AC 9462	اسم المنتج :
Product Model:	9462NGW	موديل المنتج :
Manufacturer:	INTEL MOBILE COMMUNICATIONS	المصنع :
Additional Details		معلومات اضافية
Operating Frequency : Maximum Output Power allowed (EIRP) :	2400-2483.5 MHz:10 dBm 2400-2483.5 MHz:13.3 dBm 2400-2483.5 MHz:19.8 dBm 5150-5250 MHz:22.8 dBm 5250-5350 MHz:22.8 dBm 5470-5725 MHz:22.8 dBm 5725-5825 MHz:13.91 dBm	الترددات المستخدمة : وطاقة الخرج القصوى المسموحة
Device comply with CITC technical Specification No.:	RI045 , RI103	الجهاز مطابق لمواصفات الهيئة رقم :
Additional Requirement		متطلبات اضافية



يمكن التحقق من صحة وصلاحيه هذه الشهادة من خلال زيارة الرابط المذاه في
الموقع الإلكتروني لهيئة الاتصالات وتقنية المعلومات
عن طريق استخدام
أو الرمز التالي :

<http://ers.citc.gov.sa>



اعتماد الشهادة

بناء على نظام الاتصالات الصادر بالمرسوم الملكي ذي الرقم (12/م) والتاريخ 1422/03/12هـ ولائحته التنفيذية، وبموجب تنظيم هيئة الاتصالات وتقنية المعلومات بقرار
مجلس الوزراء رقم (74) والتاريخ 1422/03/05هـ، فقد أصدرت الهيئة هذه الرخصة بخصوص مطابقة الجهاز المشار إليه أعلاه، علماً بأن هذه الرخصة لا تعتبر مرافقة على فتح
الأجهزة المشار إليها أعلاه أو الترخيص باستخدامها، بل هي شهادة مطابقة للمواصفات الفنية المعمول بها بالهيئة. كما أن هذه الشهادة قد صدرت عن الهيئة بناءً على المعلومات
المتاحة لها والتي وفرتها الجهة المستوردة أو المصنعة وقت صدور هذه الشهادة، ولا يجوز استخدام أو حيازة الأجهزة أو المتاجرة بها بصورة تخالف أحكام وأنظمة هيئة الاتصالات
وتقنية المعلومات والأنظمة الأخرى ذات العلاقة المعمول بها في المملكة، وتحمل الجهة المستوردة أو المصنعة وحدها المسؤولية عن أية أضرار أو خسائر أو إصابات قد تنشأ عن
حيازة أو استخدام هذه الأجهزة أو المتاجرة بها. وفي حال كون الأجهزة مصنعة خارج المملكة فإنه يجب التقدم إلى الهيئة من قبل المستورد بطلب لمسح الأجهزة قبل رقت وصولها
إلى أحد المنافذ الجمركية.

Notice for users in Serbia

The following adapters have been approved by Ratel: 8260NGW, 8265NGW, 3165NGW, QCNFA435, RTL8821CE, RTL8822BE, RTL8822CE, 9462NGW and QCNFA34AC

Notice for users in South Africa

For model: QCNFA34AC



For model: 8260NGW



For model: 3165NGW



For model: QCNFA435



For model: 8265NGW



For model: RTL8822BE



For model: RTL8821CE



For model: RTL8822CE



For model: 9462NGW



Notice for users in Taiwan

For models: 8260NGW, 8265NGW, 3165NGW, QCNFA435, RTL8821CE, RTL8822BE, and QCNFA34AC

根據NCC低功率電波輻射性電機管理辦法規定：

第十二條 經型式認證合格之低功率射頻電機，非經許可，公司、商號或使用者均不得擅自變更頻率、加大功率或變更原設計之特性及功能。

第十四條 低功率射頻電機之使用不得影響飛航安全及干擾合法通信；經發現有干擾現象時，應立即停用，並改善到無干擾時方得繼續使用。
前項合法通信，指依電信法規定作業之無線電通信。
低功率射頻電機須忍受合法通信或工業、科學及醫療用電波輻射性電機設備之干擾。

在5.25-5.35兆赫頻帶內操作之無線資訊傳輸設備，限於室內使用。

Notice for users in Thailand

For models: 8260NGW, 8265NGW, 3165NGW, QCNFA435, RTL8821CE, RTL8822BE, RTL8822CE, 9462NGW RTL8822CE, 9462NGW and QCNFA34AC

เครื่องโทรคมนาคมและอุปกรณ์นี้ มีความสอดคล้องตามข้อกำหนดของ กทช./กสทช.

เครื่องวิทยุคมนาคมนี้มีระดับการแผ่คลื่นแม่เหล็กไฟฟ้าสอดคล้องกับมาตรฐานความปลอดภัย ต่อสุขภาพของมนุษย์จากการใช้เครื่องวิทยุคมนาคมที่คณะกรรมการกิจการโทรคมนาคมแห่งชาติ กำหนด

Notice for users in the UAE

For model: QCNFA34AC

TRA
REGISTERED No.
ER34640/14
DEALER No.
DA0039119/10

For model: 3165NGW

TRA
REGISTERED No.
ER37771/15
DEALER No.
0018841/09

For model: RTL8821CE

TRA
REGISTERED NO.
ER50849/16
DEALER NO.
0033451/10

For model: QCNFA435

TRA
REGISTERED No.
ER37623/15
DEALER No.
DA0039119/10

For model: 8260NGW

TRA
REGISTERED No.
ER40232/15
DEALER No.
0018841/09

For model: RTL8822BE

REGISTERED NO.
ER48726/16
DEALER NO.
0033451/10

For model: 8265NGW

TRA
REGISTERED NO.
ER46868/16
DEALER NO.
0018841/09

For model: 9462NGW

TRA
REGISTERED NO.
ER60467/18
DEALER NO.
0018841/09

For model: RTL8822CE

TRA
REGISTERED NO.
ER67276/18
DEALER NO.
0033451/10

Telecommunications Regulatory Authority (TRA) approved

Appendix A. Trademarks

Lenovo, the Lenovo logo, and ideacentre are trademarks of Lenovo in the United States, other countries, or both.

Intel and Centrino are trademarks of Intel Corporation in the U.S. and/or other countries.

Other company, product, or service names may be trademarks or service marks of others.