

# Yoga A940

## User Guide



Lenovo

**NOTE:**

Before using this information and the product it supports, ensure that you read and understand the following:

- *Safety and Warranty Guide*
- *Setup Guide*
- “Important safety information” on page 18

Lenovo makes constant improvements on the documentation of your computer, including this *User Guide*. To get all the latest documents, go to:

<https://support.lenovo.com>

**First Edition (October 2018)**

**© Copyright Lenovo 2018**

LENOVO products, data, computer software, and services have been developed exclusively at private expense and are sold to governmental entities as commercial items as defined by 48 C.F.R. 2.101 with limited and restricted rights to use, reproduction and disclosure.

LIMITED AND RESTRICTED RIGHTS NOTICE: If products, data, computer software, or services are delivered pursuant to a General Services Administration “GSA” contract, use, reproduction, or disclosure is subject to restrictions set forth in Contract No. GS-35F-05925.

# Contents

<b>Meeting your computer</b> .....	<b>1</b>
Front view .....	1
Rear view.....	3
Left view .....	4
Right view .....	5
Peripheral devices.....	6
<b>Touch screen instructions</b> .....	<b>10</b>
Touch screen calibration .....	10
Using touch screen .....	10
<b>Troubleshooting and confirming setup</b> .....	<b>12</b>
Solving problems .....	12
Troubleshooting display problems .....	12
Troubleshooting audio problems .....	13
Troubleshooting software problems.....	14
Troubleshooting problems with optical drives and hard disks .....	14
Special considerations for troubleshooting Windows.....	15
Windows help system.....	16
BIOS setup utility .....	16
Performing daily maintenance tasks .....	17
<b>Important safety information</b> .....	<b>18</b>
Conditions that require immediate action .....	19
General safety guidelines .....	20
Electrical current safety information.....	27

Lithium battery notice.....	28
Modem safety information.....	28
Laser compliance statement .....	29
Power supply statement .....	29
Power cord notice.....	30
Products with television tuner options installed.....	31
Data safety.....	32
Cleaning and maintenance.....	33
Using headphones or earphones .....	33
Plastic bag notice .....	34
Tip-over hazard prevention notice .....	34
Additional safety information .....	35
Important safety information for service technicians .....	38
<b>Service and support information .....</b>	<b>49</b>
Downloading publications .....	49
<b>Lenovo limited warranty.....</b>	<b>50</b>
Part 1 – General terms .....	50
Part 2 – Country-specific terms.....	54
Part 3 – Warranty service information .....	58
<b>Notices.....</b>	<b>60</b>
Declaration.....	60
Electronic emissions notices .....	61
Regulatory information .....	65
Compliance information .....	65
Mainland China RoHS.....	65
Taiwan RoHS .....	66
Turkish statement of compliance.....	67

Ukraine RoHS statement.....	67
India RoHS statement.....	67
Waste electrical and electronic equipment (WEEE) notices.....	68
Eurasian compliance mark.....	71
ENERGY STAR information.....	71
Enabling ErP compliance mode.....	72
Export Classification Notice.....	73
<b>Legal notices .....</b>	<b>74</b>
Trademarks.....	74

# Meeting your computer

## Front view

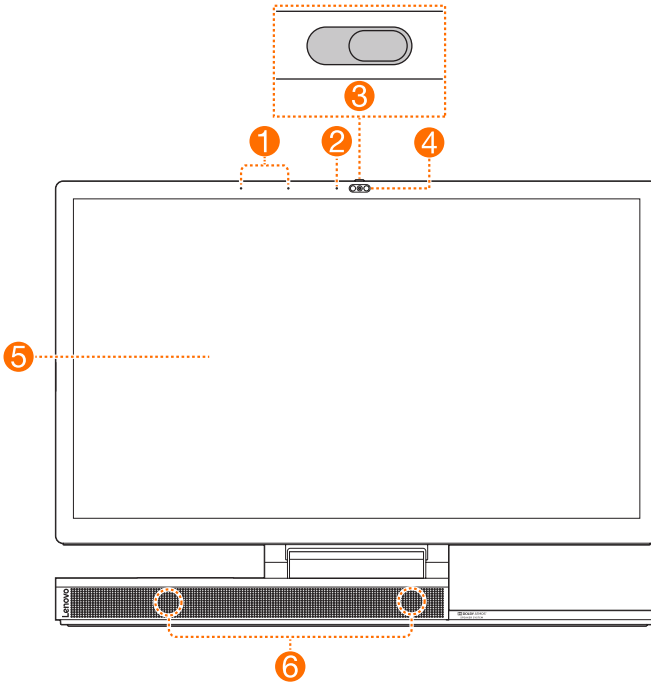

- ① Microphones
- ② Camera indicator
- ③ Camera cover slider
- ④ Camera  
(standard or Windows Hello compatible)
- ⑤ Display  
(with multi-touch function)
- ⑥ Speakers  
(with Bluetooth connectivity)

### Camera cover slider

Move this slider to cover or uncover the camera lens.

**NOTE:**

It is designed to protect your privacy. If you see a red dot, the lens is covered.

### **Camera (standard or Windows Hello compatible)**

Select models include a Windows Hello compatible camera.

### **Speakers (with Bluetooth connectivity)**

The speakers have separate Bluetooth connection capability. In addition to providing audio output for the computer, the speakers can be paired with Bluetooth-enabled smartphones and provide audio output for them.

### **Pairing the speakers with a smartphone**

1. Turn on Bluetooth on your smartphone.

**NOTE:**

You don't have to turn on the computer. However, it must be plugged into a working electrical outlet.

2. In the Bluetooth device list, look for "Yoga A940 BT SPK-xxxxx," where "xxxxx" is a model-specific ID number.

**NOTE:**

If you cannot find the device name, the speakers have already been paired with another smartphone. Hold down the LED lamp button for at least 5 seconds to clear the pairing. Refer to "Right view" for the location of the LED lamp button.

3. Select the device name, enter the PIN code "1111" when prompted.

# Rear view

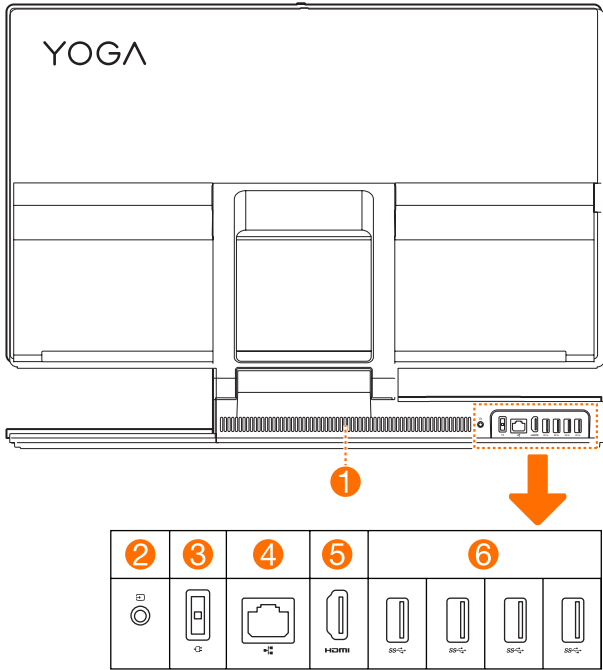

- 1 Air vents
- 2 Monitor/computer mode switch
- 3 Power connector
- 4 Ethernet connector
- 5 HDMI in/out connector
- 6 USB 3.1 Gen 1 connectors

## Air vents

**ATTENTION:**

Do not block the air vents. Otherwise, the computer might overheat.

## Monitor/computer mode switch

Switches what is displayed on the computer screen (computer/HDMI input).



# Left view

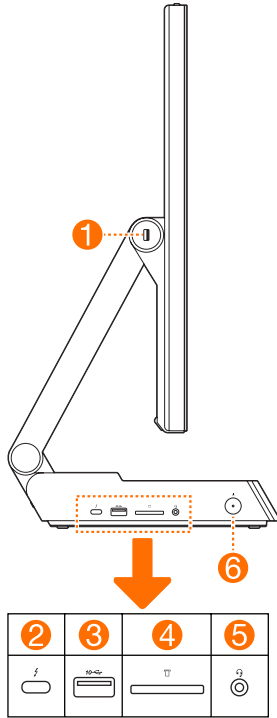

- 1 USB 2.0 connector
- 2 Thunderbolt 3 (USB-C) connector
- 3 USB 3.1 Gen 2 connector
- 4 Memory card slot
- 5 Combo audio jack
- 6 Power button (with indicator)

## Thunderbolt 3 (USB-C) connector

With a compatible cable, it can connect to external display devices. The connector also can be used to connect devices for data transfer.

## Combo audio jack

### NOTES:

- The combo audio jack does not support conventional microphones.
- The recording function may not be supported if third party headphones or headsets are connected, due to different industry standards.

# Right view

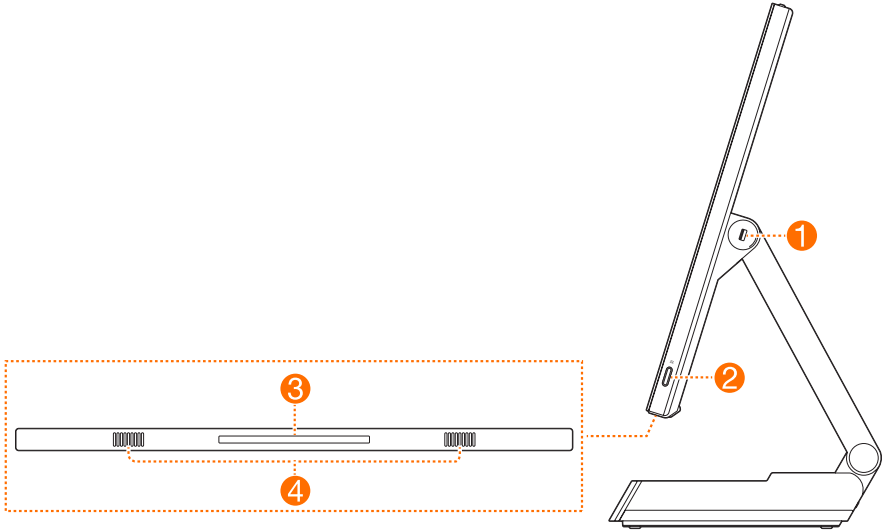

1 USB 2.0 connector

3 LED lamp

2 LED lamp button

4 Speakers

## LED lamp button

Turns on/off or adjusts the brightness of the LED lamp 3.

# Peripheral devices

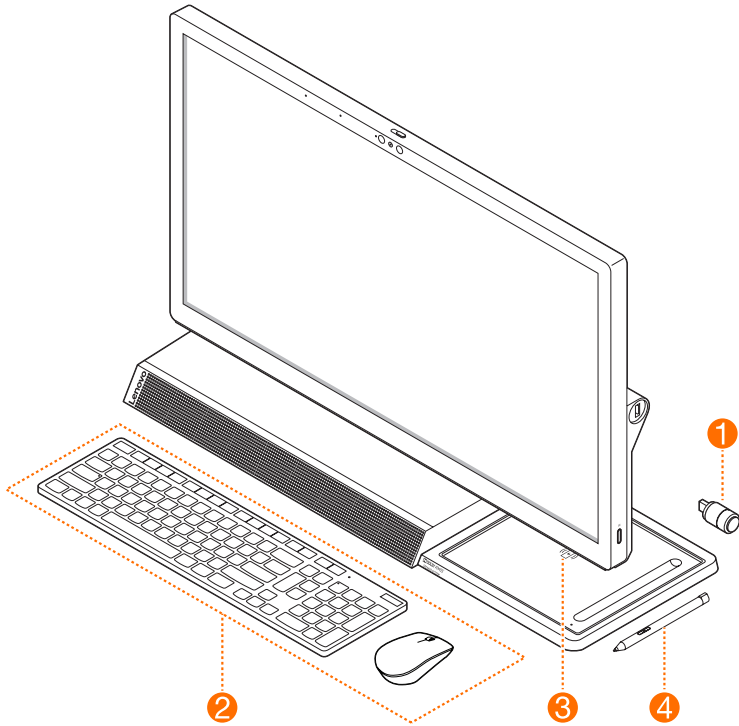

- 1 Lenovo Dial
- 2 Wireless mouse and keyboard

- 3 Wireless charging pad
- 4 Lenovo Digital Pen

## Wireless mouse and keyboard

Read the documentation that came with the keyboard and mouse for usage instructions.

**NOTE:**

Your computer may not come with all the listed devices.

## ■ Lenovo Dial

Designed specifically for Yoga A940, Lenovo Dial includes a press button and two rotating rings. When connected with the computer, it can be used to quickly change certain settings or run certain commands.





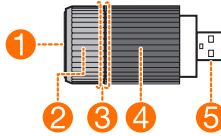









**NOTE:**

Lenovo Dial is supported by some Adobe and Microsoft Office applications.



- ① Press button
- ② Outer rotating ring
- ③ 360° LED light
- ④ Inner rotating ring
- ⑤ Connector

When you start different supported applications, the color of the dial's LED light changes accordingly.

		Adobe Illustrator			Microsoft Word
		Adobe Photoshop			Microsoft PowerPoint
		Adobe Premier Pro			Microsoft Excel
		Adobe Lightroom		Unsupported Programs/ Windows Desktop	

## Setting up button and ring functions

For each of the supported applications, you can set up functions for the dial's press button and two rotating rings.

1. Insert the dial into either of the two USB 2.0 connectors.

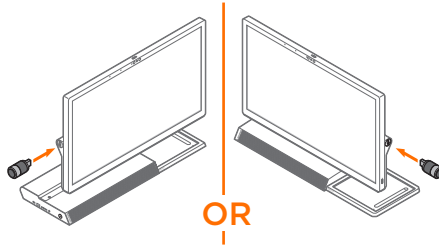

2. Start a supported application.
3. Press and hold the button until vibration occurs. The settings page is displayed.
4. Press the button or rotate the rings to select a target command from the respective lists.
5. Press and hold the button to exit the settings page.

## ■ Wireless charging pad

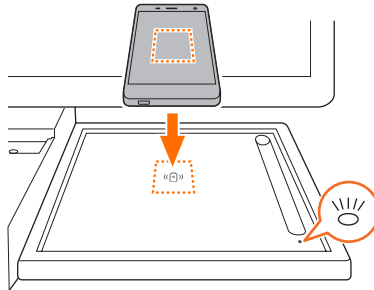

You can use the wireless charging pad to charge phones that support wireless charging.

### *Wireless charging pad – indicator status*

Indicator status	Meaning
Blinking white	The phone is being charged
Solid amber	Charging error occurs
Off	No compatible phone is detected

#### **NOTE:**

Place your phone in the center of the pad. If the indicator is amber, adjust the phone's position and remove metal objects on or near the pad.

## ■ Lenovo Digital Pen

Lenovo Digital Pen uses AAAA battery. The battery may or may not ship with the pen. If the pen ships with an AAAA battery, check and remove an insulation pad before first use.

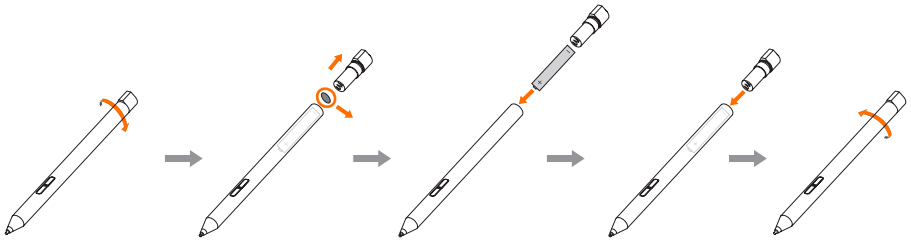

### ATTENTION:

Use and replace with the correct battery type.

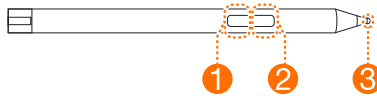

1 Top button

3 Tip

2 Bottom button

## Button functions of Lenovo Digital Pen

The table below lists Lenovo Digital Pen's button functions for some popular applications. To use the eraser function, hold down the bottom button and tap on the strokes you want to erase.

*Lenovo Digital Pen – button functions*

Application	Top button	Bottom button
Microsoft Word	No function	Eraser
Paint	Color 2	No function
Microsoft Edge	No function	Eraser
Microsoft OneNote	No function	Eraser
Sticky Notes	No function	Eraser
Sketchpad	No function	Eraser
Screen sketch	No function	Eraser

### NOTE:

Sticky Notes, Sketchpad, and Screen sketch are three applications provided with Windows Ink Workspace.

# Touch screen instructions

**ATTENTION:**

Touch screens are only available on some models.

The monitor is touch-sensitive thanks to its touch-sensitive screen. A touch screen is an input device just like a mouse or a keyboard, and the user's fingers transmit position information via the touch screen to the computer. With this technology, you only need to touch the pictures or words on the computer display lightly with your finger, and the computer will react.

## Touch screen calibration

Prior to first use or whenever the touch screen reacts in a different place where you are touching it, start the calibration program. The procedure is as follows:

- Enter **Tablet PC Setting** into the search box on the taskbar, then click **Calibrate** to start the program.
- To perform calibration, use your finger or a touch pen with a diameter of over 9 mm to touch each of the calibration points shown in sequence.

## Using touch screen

**NOTE:**

Refer to **Get Started** to learn more about how to use the touch screen. Enter **Get Started** into the search box on the taskbar, then select **Touch and keyboard** for additional information.

### ■ Other touch screen settings

- Enter **Pen and Touch** into the search box on the taskbar.
- Select the touch actions you want to adjust. Click on **Settings** to adjust the **Speed** and **Spatial tolerance** parameters to match the user's natural way of double-tapping. Double-tap the graphic in the lower right-hand corner of the window to test the settings.

## ■ Precautions when using the touch screen

1. When using the touch screen, be careful not to tear the surface with any sharp objects.

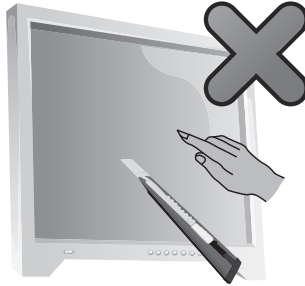

2. To ensure normal use of the touch screen, ensure that both the screen surface and your fingers are clean and dry.
3. To ensure precise positioning on the touch screen, avoid handling or touching the glass frame when you are touching the screen.
4. Turn the computer off for safety before cleaning the screen and frame with a soft cotton cloth. Do not wipe it with a wet cloth as this may leave a water mark and affect touch operation.
5. Do not place or drop anything on the four corners or frame of the screen. This could separate the screen from the frame and prevent the screen sensing properly. Please avoid leaving water and dust in the gap between the casing and glass when you are cleaning the frame.
6. Avoid using the touch screen in dusty environments or hot or humid conditions. Any abrupt temperature change may cause condensation on the inside surface of the glass screen. This condensation will disappear after a short time and does not affect normal use.
7. Do not spray any liquid or cleaner directly onto the touch screen.
8. Do not use solvents or industrial alcohol-based cleaners.
9. Avoid using the computer in strong sunlight, which will affect the function of the touch screen.
10. Recognition of touch gestures can be influenced by the following:
  - Touching the correct place on the screen.
  - The speed of movement.
  - The time interval from when the screen was last touched.
11. The touch screen also does not function during the startup process, in Hibernate mode and in Sleep mode or Safe mode.
12. Do not touch the screen with your finger or any other objects during the computer startup or wake up process.



# Troubleshooting and confirming setup

## Solving problems

### Follow these tips when troubleshooting your computer:

- If you added or removed a part before the problem started, review the installation procedures to ensure that the part is correctly installed.
- If a peripheral device does not work, ensure that the device is properly connected.
- If an error message appears on the screen, write down the exact message. This message may help support personnel diagnose and fix the problem(s).
- If an error message occurs in a program, see the Help document of that program.

## Troubleshooting display problems

**Problem:** Blank screen or no image is displayed on the monitor.

### Troubleshooting and problem resolution:

- 1 Check to see if the monitor has been turned on; if not, press the Power button.
2. Check to see if the monitor power cord is loose; if so, plug the power cord securely into the monitor.
3. Check to see if the signal cable to the monitor is securely connected to the connector on the computer graphics card; if not, shut down the computer then connect the signal cable of the monitor securely to the connector on the computer graphics card.

**Problem:** You need to change the display property settings.

**Setting display background and icon properties:**

1. Right-click the desktop anywhere except over an icon, then select **Personalize** from the pop-up menu.
2. From here, select the appropriate options to:
  - Change the desktop background
  - Select a screen saver
  - Select Windows color options for borders and taskbar
  - Select a theme
3. Right-click the desktop anywhere except over an icon, then select **Display settings** from the pop-up menu to change the appearance.

**Problem:** Ripple on screen.

**Troubleshooting and problem resolution:**

1. Check to see if any of the following devices are located less than one meter from the computer: refrigerators, electric fans, electric dryers, UPS systems, regulators, fluorescent lamps or other computers that may be generating magnetic interference.
2. Move any interfering devices away from the computer.
3. If the problem persists, contact Lenovo Service.

## Troubleshooting audio problems

**Problem:** No sound from the integrated speakers.

**Troubleshooting and problem resolution:**

- Adjust the Windows volume control: select the speaker icon from the taskbar. Ensure that the volume is turned up and the sound is not muted. Adjust the volume, bass, or treble controls to eliminate distortion.
- Reinstall the audio driver.
- Disconnect any headphones from the headphone connector: sound from the speakers is automatically disabled when headphones are connected to the computer's side-panel headphone connector.

**Problem:** No sound from headphones.

**Troubleshooting and problem resolution:**

- Check the headphone cable connection: ensure that the headphone cable is securely inserted into the headphone connector.
- Adjust the Windows volume control: select the speaker icon from the taskbar. Ensure that the volume is turned up and the sound is not muted.

# Troubleshooting software problems

**Problem:** You are unable to exit a running program normally.

**Troubleshooting and problem resolution:**

1. Press the **Ctrl**, **Alt** and **Delete** keys at the same time, then select the **Task Manager** option from the Windows logon screen.
2. Select the problem program, then click the **End Task** button.

**Problem:** You need to install or uninstall a program.

**Problem resolution:**

**During installation** never abort the install process by powering the system off or through other drastic means. This can cause system program problems or even failure during system initialization.

**During the uninstall process**, never directly delete the files or folders. This is harmful to the operating system, and might cause a system-wide malfunction. Use the following procedure to properly uninstall programs:

1. Back up all documents and system settings related to the program before removing it.
2. If the program has its own uninstaller, run it directly to uninstall the program.
3. If the program does not have its own uninstaller, use the search box on the taskbar to open the **Control Panel**.
4. From the **Control Panel**, choose **Programs** → **Programs and Features**.
5. Find the program in the **Programs and Features** dialog box and then select **Uninstall/Change**.
6. Follow the prompts displayed to uninstall the software.

# Troubleshooting problems with optical drives and hard disks

**Problem:** The optical drive is unable to read a CD/DVD.

**Troubleshooting and problem resolution:**

1. Check to see if there is an optical drive icon in the resource manager of the operating system. If not, restart your computer. If there is still no icon, contact Lenovo Service. Otherwise, continue with the next step of this procedure.
2. Confirm that the CD/DVD has been properly placed in the drive. If not, reload the CD or DVD. Otherwise, continue with the next step of this procedure.
3. Check the specifications that came with your computer to confirm that this optical drive is capable of reading this type of CD or DVD.

4. If the CD/DVD cannot be read, replace it with a known good CD/DVD such as one that was shipped with the computer.
5. If the known good CD cannot be read, visually check the operating side of the CD/DVD for defects.

**Problem:** The capacity of the hard disk, as indicated by the system, is less than the nominal capacity.

**Troubleshooting and problem resolution:** For computers equipped with the OneKey Recovery feature, the system recovery feature needs to occupy some hard disk space. This may account for the apparent hard disk capacity deficit.

**Further technical explanation:** The nominal capacity of the hard disk is expressed in the decimal system as 1000 bytes. But the actual hard disk capacity is expressed in the binary system as 1024 bytes (For example, the nominal capacity 1G is 1000M, while the actual capacity 1G is 1024M).

The capacity of the hard disk shown in Windows can be calculated according to the calculations in the following example:

The nominal capacity of the hard disk is 40G, while its actual capacity should be:  
 $40\text{G} \times 1000 \times 1000 \times 1000 / (1024 \times 1024 \times 1024) = 37\text{G}.$

The capacity of the hard disk shown in the system can be obtained by subtracting the service partition:  
 $3\text{G} \times 1000 \times 1000 \times 1000 / (1024 \times 1024 \times 1024) = 2.79\text{G}.$

The capacity of the hard disk as calculated using this method may be slightly different from the actual capacity due to the rounding of totals.

## Special considerations for troubleshooting Windows

Record the following information as it may be useful later when troubleshooting system problems:

The drivers for this computer model only support the Windows 10 system.

**Problem:** The operating system fails to start up.

**Troubleshooting and problem resolution:**

If the computer is installed with an Optane memory:

- Ensure that the Optane memory is not removed.
- Check the Optane memory using the diagnostic tool that is preinstalled in your computer, to ensure it is not damaged.

# Windows help system

The Windows help system provides you with detailed information about using the Windows operating system.

To access the Windows help system, do the following:

Open the Start menu and then click or tap **Get Started** to get more details.

You also can enter **Get Started** or what you're looking for in the search box on the taskbar. You'll get suggestions and answers to your questions about Windows and the best search results available from your PC and the Internet.

To perform system recovery after a serious error in Windows 10, click or tap the Start button and select **Settings** → **Update & security** → **Recovery**. Then, follow the instructions on the screen for system recovery.

## ATTENTION:

The Windows operating system is provided by Microsoft Corporation. Please use it in accordance with the END USER LICENSE AGREEMENT (EULA) between you and Microsoft. For any question related to the operating system, please contact Microsoft directly.

# BIOS setup utility

## What is the BIOS setup utility?

The BIOS setup utility is ROM-based software. It communicates basic computer information and provides options for setting boot devices, security, hardware mode, and other preferences.

## How can I start the BIOS setup utility?

To start the BIOS setup utility:

1. Shut down the computer.
2. Turn the computer on and repeatedly press and release the **F1** key to start the Setup Utility program.

## How can I change the boot mode?

There are two boot modes: UEFI and Legacy. To change the boot mode, start the BIOS setup utility and select **Startup** → **Boot Priority**, then set boot mode to UEFI or Legacy support on the boot menu.

### **When do I need to change the boot mode?**

The default boot mode for your computer is the UEFI mode. If you need to install a legacy Windows operating system (any operating system before Windows 8.1) on your computer, you must change the boot mode to Legacy support. The legacy Windows operating system cannot be installed if you don't change the boot mode.

## **Performing daily maintenance tasks**

### **Cleaning the computer components**

Because many of the computer components consist of sophisticated integrated circuit boards, it is very important to periodically clean the computer to prevent dust buildup. The cleaning supplies you need to clean the components include: a vacuum cleaner, a soft cotton cloth, pure water (preferably purified or distilled water) and cotton swabs.

#### **ATTENTION:**

Before you clean your computer, disconnect the computer from the electrical outlet. Clean your computer with a soft cloth dampened with water. Do not use liquid or aerosol cleaners, which may contain flammable substances.

#### **NOTE:**

To avoid damaging the computer or display, do not spray cleaning solution directly onto the display. Only use products specifically designed for cleaning displays, and follow the instructions included with the product.

### **The following are general methods for cleaning the components:**

- You can use a soft cloth to remove dust on the surface of the computer, the monitor, the printer, the speakers and the mouse.
- You can use a vacuum cleaner to clean in otherwise inaccessible corners.
- To clean the keyboard thoroughly, shut down the computer and scrub it gently with a wet cloth. Do not use the keyboard until it is dry.

### **Do not do any of the following:**

- Allow water to enter the computer.
- Use a heavily dampened cloth.
- Spray water directly onto the surface of the monitor or inside the computer.

LCD monitor should be cleaned daily. Use a dry cloth to brush dust from the monitor and keyboard every day. Keep all surfaces clean and free of grease stains.