

## User Guide Lexmark Mobile Solutions Module

NOTE: Feature requires use of mobile device that supports Bluetooth Smart (Bluetooth Low Energy).

The Mobile Solutions Module (LEX-M06-001) can be used in conjunction with a mobile smartphone or tablet with Bluetooth Smart support to transfer authentication data (badge id or user credentials) from the device to the host printer.

- 1) Install the Mobile Solutions Module as shown in the installation diagrams included with the option. Note the install methods shown for supported systems with 4.3", 7", and 10" touchscreen displays and choose the one corresponding to your printer. Note the location of the locating sticker for the Mobile Solutions Module on the printer as shown on the installation diagrams. For more information, consult [support.lexmark.com](http://support.lexmark.com).
- 2) Install the Lexmark mobile app with authentication support. The app can be obtained from the Google Play store or from Lexmark.
- 3) Launch the mobile authentication app. You will then be prompted to place the mobile device close to the locating sticker of the Mobile Solutions Module on the printer.
- 4) Printer will indicate an "Authenticating with credentials from mobile device" status. Successful or unsuccessful authentication will be indicated on the printer touch screen.
- 5) The Federal Communications Commission (FCC) of the United States of America requires that "the outside of the device into which the module is installed must also display a label referring to the enclosed module" (FCC rules part 15.212). This label has the FCC ID of the modular transmitter listed on it. This label is included with the device. Place the label on the back of the machine near the rating label (refer to the pictorial below – your product may not look exactly like the pictorial). Do not cover up any existing label but place in an open area. Other countries may also require such labeling and those countries certification numbers may also be included on the label. Failure to place the label will result in non-compliance with the FCC and other countries regulatory agencies.

Contains FCC ID:IYLLEXM06001  
Contains IC:2376A-LEXM06001



Place supplied FCC ID host label on back of host machine near existing rating label. Your product may not look like this.

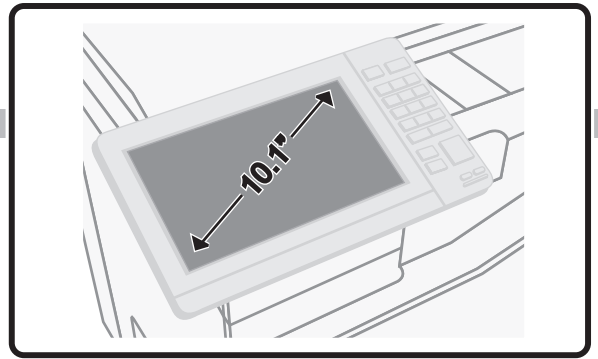
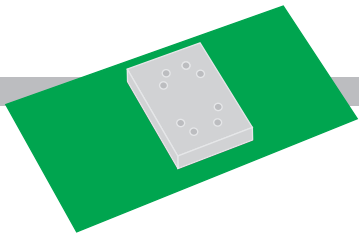

1

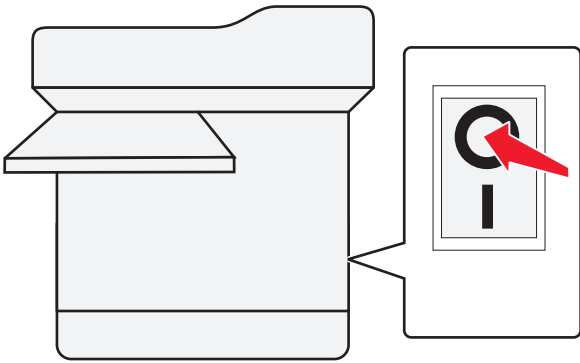

2

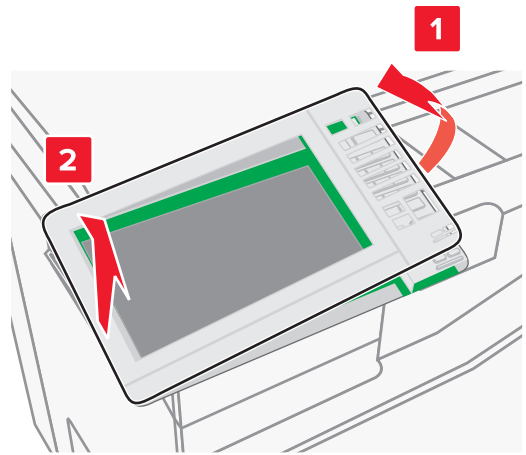

3

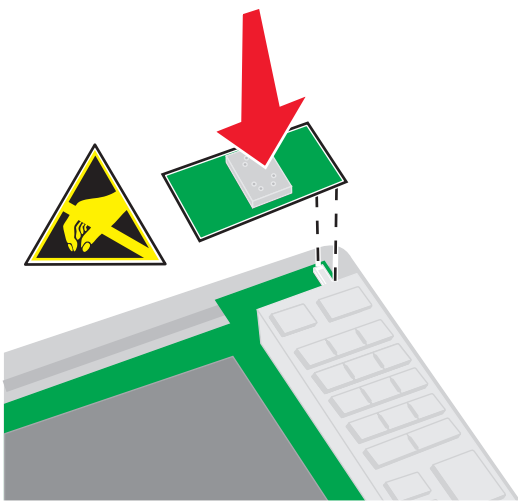

4

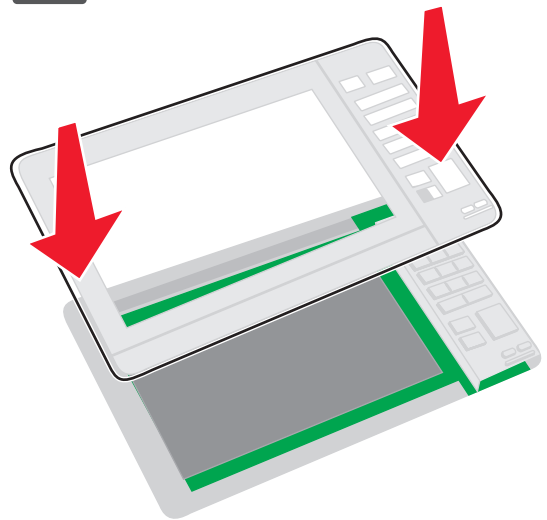

5

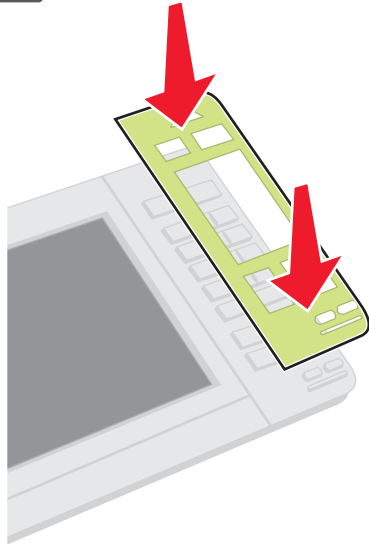

6

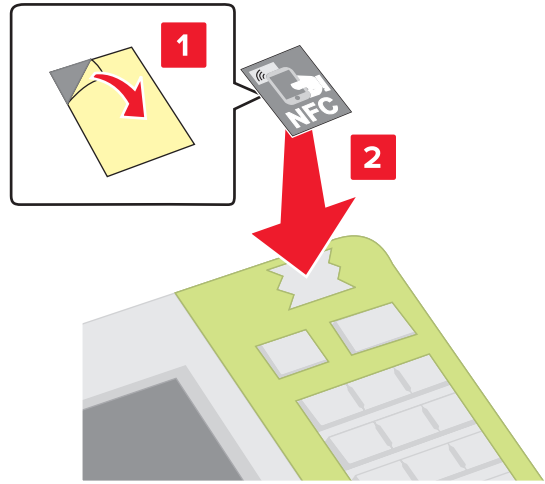

7

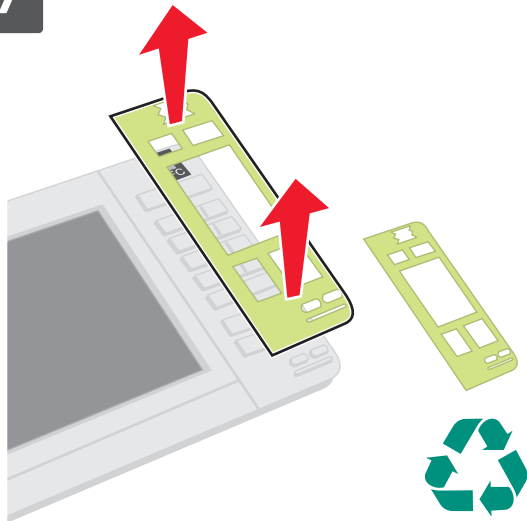

8

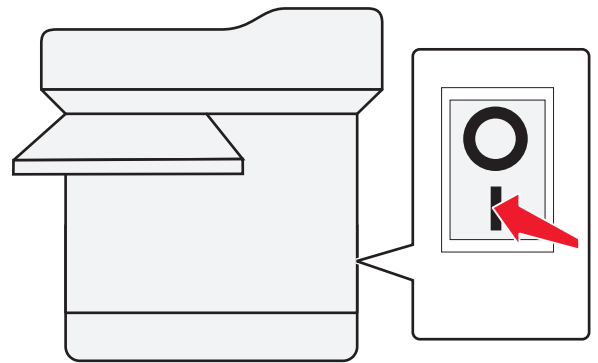

Make sure your wireless network adapter is installed in your printer and working properly.

Assurez-vous que votre adaptateur réseau sans fil est installé sur votre imprimante et qu'il fonctionne correctement.

Accertarsi che la scheda di rete wireless sia installata nella stampante e funzioni correttamente.

Vergewissern Sie sich, dass ein WLAN-Adapter in Ihrem Drucker installiert ist und ordnungsgemäß funktioniert.

Asegúrese de que el adaptador de red inalámbrica está instalado en la impresora y funciona correctamente.

Verifique se o adaptador de rede sem fio está instalado na sua impressora e funcionando corretamente.

Zorg dat uw draadloze netwerkadapter op de printer is geïnstalleerd en dat deze correct werkt.

Kontroller, at der er installeret en trådløs netværksadapter i printeren, og at den fungerer.

Se till att den trådlösa nätverksadaptern är installerad i skrivaren och fungerar som den ska.

Varmista, että langaton verkkosovitin on asennettu tulostimeen ja toimii oikein.

Kontroller at den trådløse nettverksadapteren er installert i skriveren og fungerer som den skal.

Zkontrolujte, zda je v tiskárně nainstalován adaptér bezdrátové sítě a funguje správně.

Ellenőrizze, hogy a vezeték nélküli hálózati adapter csatlakoztatva van-e a nyomtatóhoz, illetve hogy megfelelően működik-e.

Upewnij się, że w drukarce jest zainstalowana bezprzewodowa karta sieciowa, która działa prawidłowo.

Убедитесь в том, что адаптер беспроводной сети установлен в принтер и работает нормально.

Asigurați-vă că adaptorul de rețea wireless este instalat în imprimanta dvs. și funcționează corespunzător.

Βεβαιωθείτε ότι ο προσαρμογέας ασύρματου δικτύου έχει εγκατασταθεί στον εκτυπωτή και λειτουργεί σωστά.

Kablosuz ağ bağdaştırıcınızın yazıcınızda kurulu olduğundan ve düzgün çalıştığından emin olun.

ワイヤレスネットワークアダプタがプリンタにインストールされ、正しく動作していることを確認します。

프린터에 무선 네트워크 어댑터가 설치되고 제대로 작동하고 있는지 확인하십시오.

確認已在您的印表機上安裝無線網路配接卡，並確認配接卡能正常運作。

确认无线网络适配器安装在打印机中并且工作正常。

تأكد من تركيب مهائى شبكة الاتصال اللاسلكية بالطابعة ومن أنه يعمل بشكل سليم.

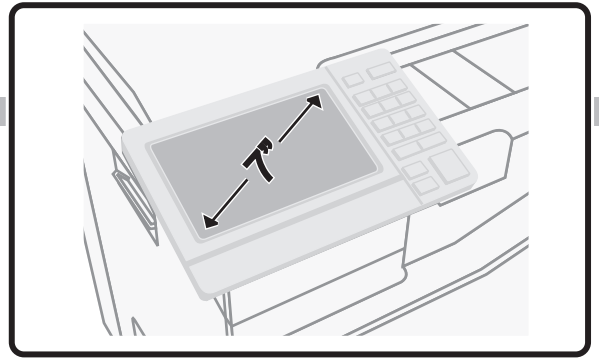
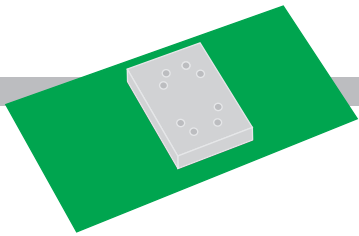

1

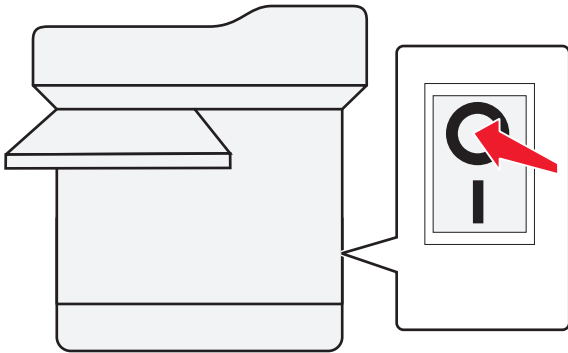

2

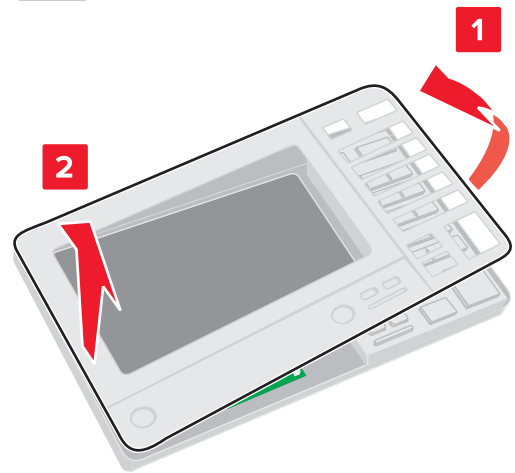

3



4

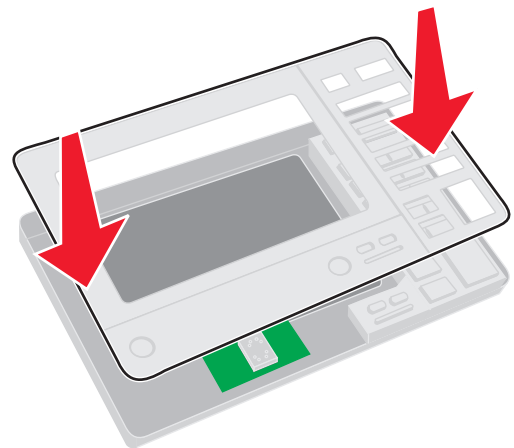

5

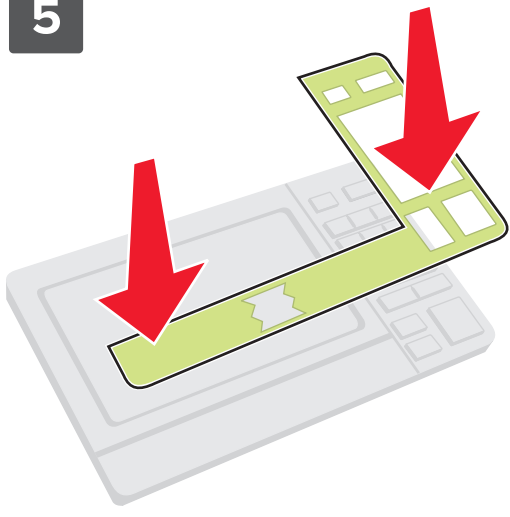

6

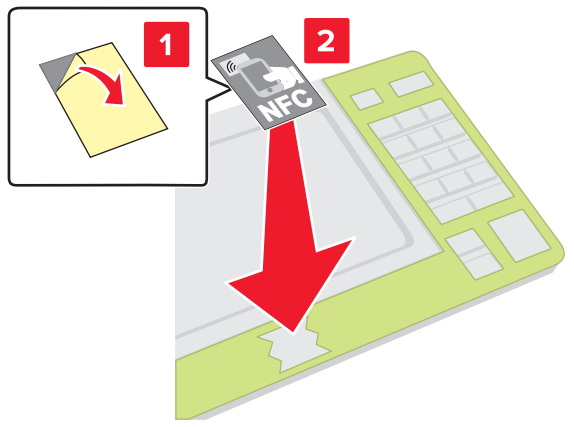

7

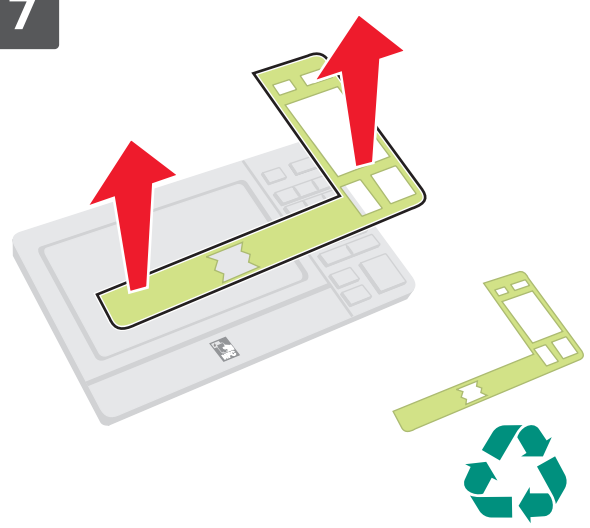

8

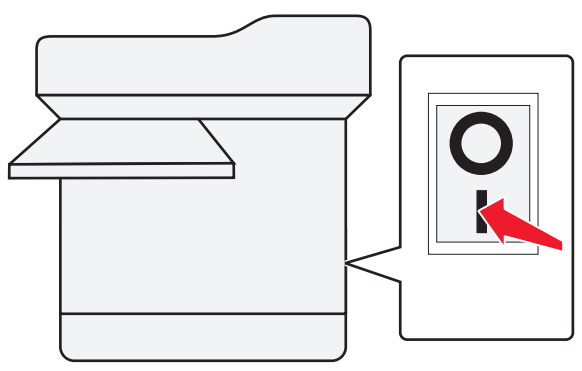

Make sure your wireless network adapter is installed in your printer and working properly.

Assurez-vous que votre adaptateur réseau sans fil est installé sur votre imprimante et qu'il fonctionne correctement.

Accertarsi che la scheda di rete wireless sia installata nella stampante e funzioni correttamente.

Vergewissern Sie sich, dass ein WLAN-Adapter in Ihrem Drucker installiert ist und ordnungsgemäß funktioniert.

Asegúrese de que el adaptador de red inalámbrica está instalado en la impresora y funciona correctamente.

Verifique se o adaptador de rede sem fio está instalado na sua impressora e funcionando corretamente.

Zorg dat uw draadloze netwerkadapter op de printer is geïnstalleerd en dat deze correct werkt.

Kontroller, at der er installeret en trådløs netværksadapter i printeren, og at den fungerer.

Se till att den trådlösa nätverksadaptern är installerad i skrivaren och fungerar som den ska.

Varmista, että langaton verkkosovitin on asennettu tulostimeen ja toimii oikein.

Kontroller at den trådløse nettverksadapteren er installert i skriveren og fungerer som den skal.

Zkontrolujte, zda je v tiskárně nainstalován adaptér bezdrátové sítě a funguje správně.

Ellenőrizze, hogy a vezeték nélküli hálózati adapter csatlakoztatva van-e a nyomtatóhoz, illetve hogy megfelelően működik-e.

Upewnij się, że w drukarce jest zainstalowana bezprzewodowa karta sieciowa, która działa prawidłowo.

Убедитесь в том, что адаптер беспроводной сети установлен в принтер и работает нормально.

Asigurați-vă că adaptorul de rețea wireless este instalat în imprimanta dvs. și funcționează corespunzător.

Βεβαιωθείτε ότι ο προσαρμογέας ασύρματου δικτύου έχει εγκατασταθεί στον εκτυπωτή και λειτουργεί σωστά.

Kablosuz ağ bağdaştırıcınızın yazıcınızda kurulu olduğundan ve düzgün çalıştığından emin olun.

ワイヤレスネットワークアダプタがプリンタにインストールされ、正しく動作していることを確認します。

프린터에 무선 네트워크 어댑터가 설치되고 제대로 작동하고 있는지 확인하십시오.

確認已在您的印表機上安裝無線網路配接卡，並確認配接卡能正常運作。

确认无线网络适配器安装在打印机中并且工作正常。

تأكد من تركيب مهائى شبكة الاتصال اللاسلكية بالطابعة ومن أنه يعمل بشكل سليم.



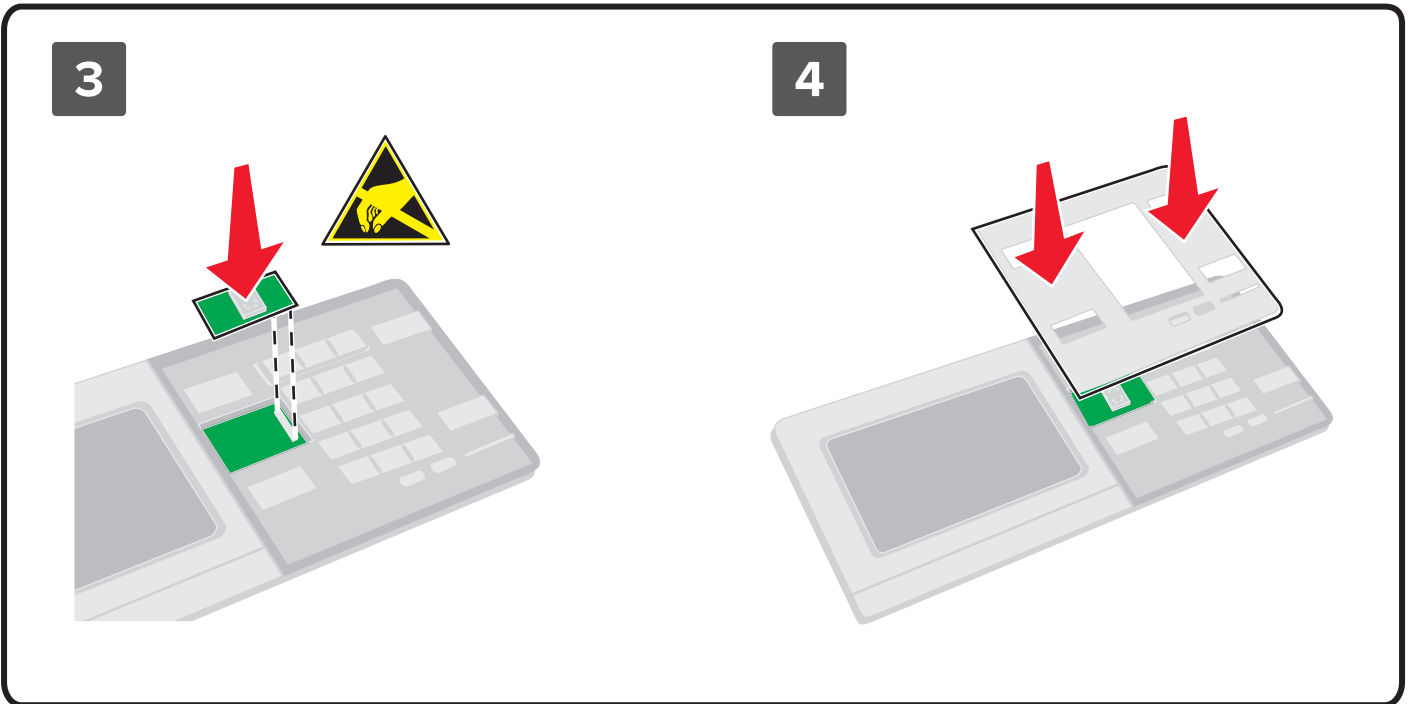
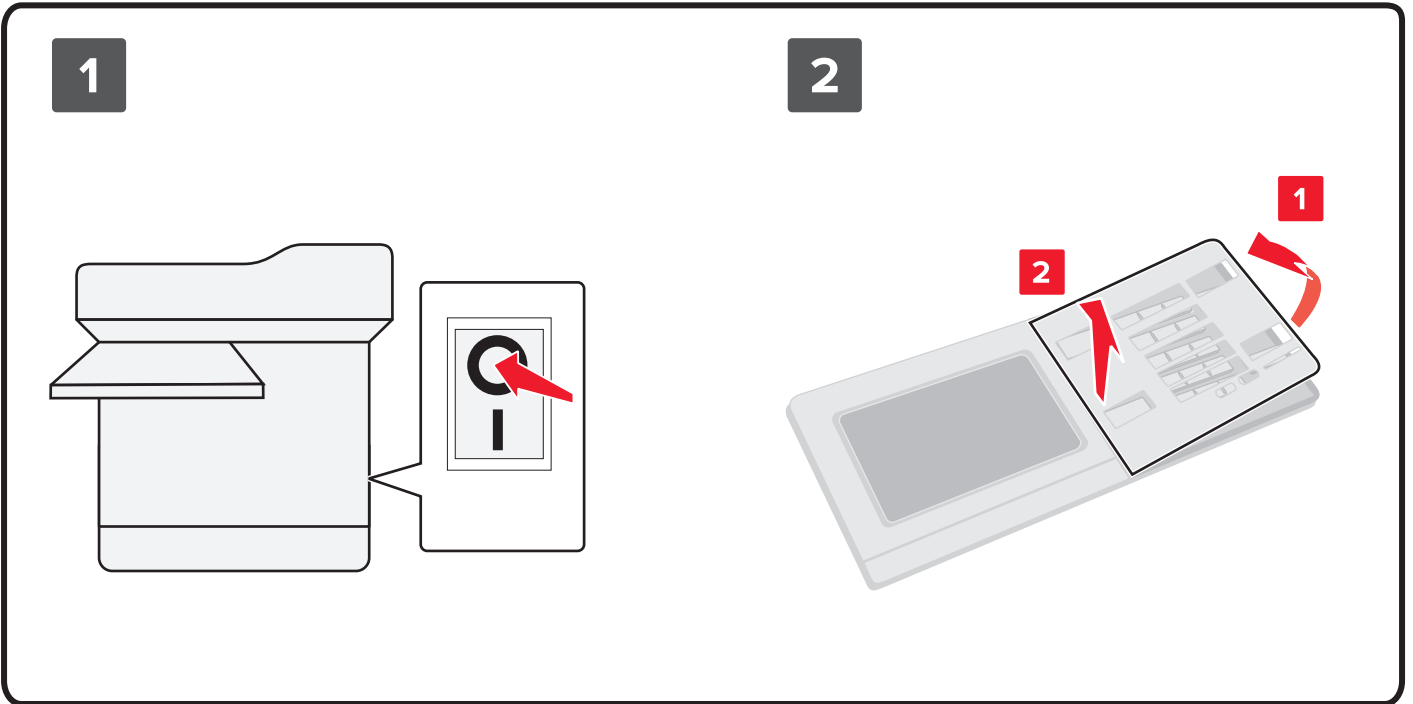
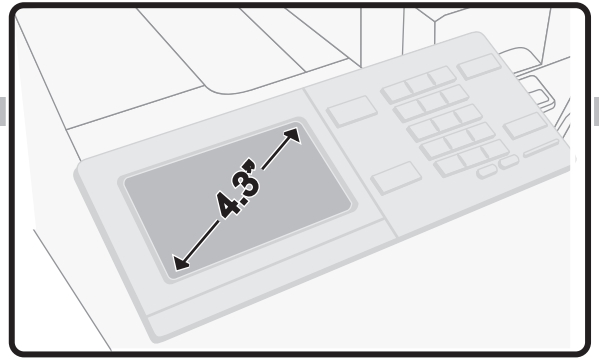
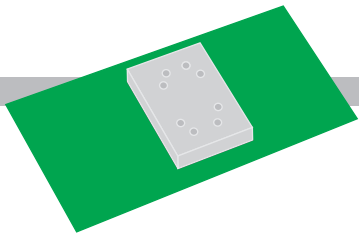

5

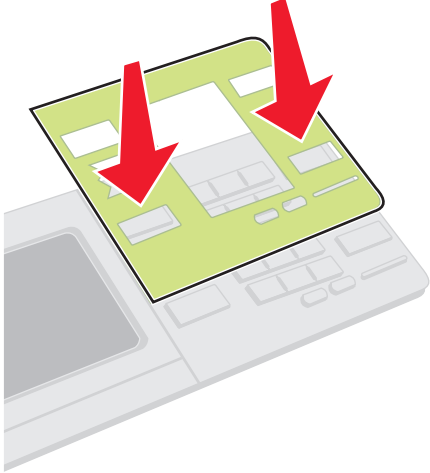

6

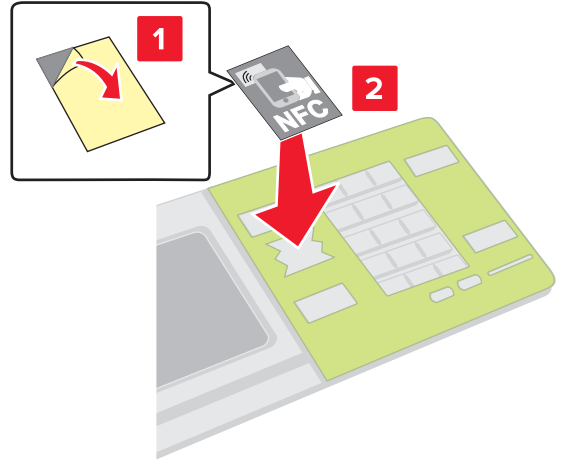

7

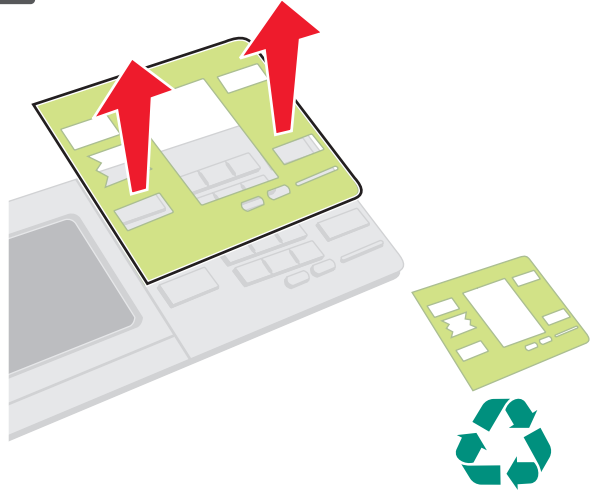

8

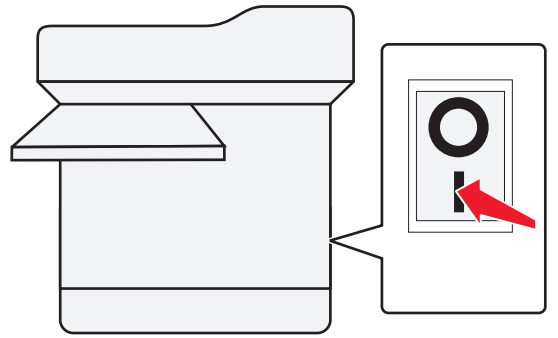

Make sure your wireless network adapter is installed in your printer and working properly.

Assurez-vous que votre adaptateur réseau sans fil est installé sur votre imprimante et qu'il fonctionne correctement.

Accertarsi che la scheda di rete wireless sia installata nella stampante e funzioni correttamente.

Vergewissern Sie sich, dass ein WLAN-Adapter in Ihrem Drucker installiert ist und ordnungsgemäß funktioniert.

Asegúrese de que el adaptador de red inalámbrica está instalado en la impresora y funciona correctamente.

Verifique se o adaptador de rede sem fio está instalado na sua impressora e funcionando corretamente.

Zorg dat uw draadloze netwerkadapter op de printer is geïnstalleerd en dat deze correct werkt.

Kontroller, at der er installeret en trådløs netværksadapter i printeren, og at den fungerer.

Se till att den trådlösa nätverksadaptern är installerad i skrivaren och fungerar som den ska.

Varmista, että langaton verkkosovitin on asennettu tulostimeen ja toimii oikein.

Kontroller at den trådløse nettverksadapteren er installert i skriveren og fungerer som den skal.

Zkontrolujte, zda je v tiskárně nainstalován adaptér bezdrátové sítě a funguje správně.

Ellenőrizze, hogy a vezeték nélküli hálózati adapter csatlakoztatva van-e a nyomtatóhoz, illetve hogy megfelelően működik-e.

Upewnij się, że w drukarce jest zainstalowana bezprzewodowa karta sieciowa, która działa prawidłowo.

Убедитесь в том, что адаптер беспроводной сети установлен в принтер и работает нормально.

Asigurați-vă că adaptorul de rețea wireless este instalat în imprimanta dvs. și funcționează corespunzător.

Βεβαιωθείτε ότι ο προσαρμογέας ασύρματου δικτύου έχει εγκατασταθεί στον εκτυπωτή και λειτουργεί σωστά.

Kablosuz ağ bağdaştırıcınızın yazıcınızda kurulu olduğundan ve düzgün çalıştığından emin olun.

ワイヤレスネットワークアダプタがプリンタにインストールされ、正しく動作していることを確認します。

프린터에 무선 네트워크 어댑터가 설치되고 제대로 작동하고 있는지 확인하십시오.

確認已在您的印表機上安裝無線網路配接卡，並確認配接卡能正常運作。

确认无线网络适配器安装在打印机中并且工作正常。

تأكد من تركيب مهائى شبكة الاتصال اللاسلكية بالطابعة ومن أنه يعمل بشكل سليم.

## **Federal Communications Commission (FCC) compliance information statement**

This product has been tested and found to comply with the limits for a Class B digital device, pursuant to Part 15 of the FCC Rules. Operation is subject to the following two conditions: (1) this device may not cause harmful interference, and (2) this device must accept any interference received, including interference that may cause undesired operation.

The FCC Class B limits are designed to provide reasonable protection against harmful interference when the equipment is operated in a residential installation. This equipment generates, uses, and can radiate radio frequency energy and, if not installed and used in accordance with the instructions, may cause harmful interference to radio communications. However, there is no guarantee that interference will not occur in a particular installation. If this equipment does cause harmful interference to radio or television reception, which can be determined by turning the equipment off and on, the user is encouraged to try to correct the interference by one or more of the following measures:

Reorient or relocate the receiving antenna.

Increase the separation between the equipment and receiver.

Connect the equipment into an outlet on a circuit different from that to which the receiver is connected.

Consult your point of purchase or service representative for additional suggestions.

The manufacturer is not responsible for radio or television interference caused by using other than recommended cables or by unauthorized changes or modifications to this equipment. Unauthorized changes or modifications could void the user's authority to operate this equipment.

**Note:** To assure compliance with FCC regulations on electromagnetic interference for a Class B computing device, use a properly shielded and grounded cable such as Lexmark part number 1021231 for parallel attach or 1021294 for USB attach. Use of a substitute cable not properly shielded and grounded may result in a violation of FCC regulations.

Any questions regarding this compliance information statement should be directed to:

Director of Lexmark Technology & Services  
Lexmark International, Inc.  
740 West New Circle Road  
Lexington, KY 40550  
(859) 232-3000

## **Industry Canada compliance statement**

This Class B digital apparatus meets all requirements of the Canadian Interference-Causing Equipment Standard ICES-003.

## **Avis de conformité aux normes de l'industrie du Canada**

Cet appareil numérique de classe B est conforme aux exigences de la norme canadienne relative aux équipements pouvant causer des interférences NMB-003.

## **Modular component notice**

This product contains the following modular component(s):  
LEX-M06-001, FCCID:IYLLEXM06001, IC:2376A-LEXM06001

## **Exposure to radio frequency radiation**

The radiated output power of this device is far below the radio frequency exposure limits of the FCC and other regulatory agencies. A minimum separation of 20 cm (8 inches) must be maintained between the antenna and any persons for this device to satisfy the RF exposure requirements of the FCC and other regulatory agencies.

## **Industry Canada (Canada)**

Under Industry Canada regulations, this radio transmitter may only operate using an antenna of a type and maximum (or lesser) gain approved for the transmitter by Industry Canada. To reduce potential radio interference to other users, the antenna type and its gain should be so chosen that the equivalent isotropically radiated power (EIRP) is not more than that necessary for successful communication.

This device complies with Industry Canada license-exempt RSS standards. Operation is subject to the following two conditions: (1) this device may not cause interference, and (2) this device must accept any interference, including interference that may cause undesired operation of the device. To prevent radio interference to the licensed service, this device is intended to be operated indoors and away from windows to provide maximum shielding.

## **Industrie Canada (Canada)**

Selon la réglementation d'Industrie Canada, l'émetteur radio ne fonctionner qu'avec une antenne dont le type et le gain maximal (ou inférieur) ont été approuvés par Industrie Canada. Pour réduire les interférences radio potentielles auprès d'autres utilisateurs, le type d'antenne et son gain doivent être choisis de telle sorte que la puissance isotrope rayonnée équivalente (PIRE) ne soit pas supérieure à ce qui est nécessaire pour assurer la réussite de la communication.

Cet appareil est conforme aux normes RSS exemptes de licence d'Industrie Canada. Son fonctionnement est soumis aux deux conditions suivantes : (1) cet appareil ne doit pas causer d'interférences et (2) il doit accepter toutes les interférences, y compris les interférences pouvant entraîner un fonctionnement indésirable.

Pour éviter toute interférence radio au service sous licence, cet appareil est destiné à être utilisé à l'intérieur et à l'écart des fenêtres afin d'assurer une protection maximale.

## **European Community (EC) directives conformity**

This product is in conformity with the protection requirements of EC Council directives 2004/108/EC, 2006/95/EC, 2009/125/EC, and 2011/65/EU on the approximation and harmonization of the laws of the Member States relating to electromagnetic compatibility, safety of electrical equipment designed for use within certain voltage limits, the ecodesign of energy-related products, and on the restrictions of use of certain hazardous substances in electrical and electronic equipment. The manufacturer of this product is: Lexmark International, Inc., 740 West New Circle Road, Lexington, KY, 40550 USA. The authorized representative is: Lexmark International Technology Hungária Kft., 8 Lechner Ödön fasor, Millennium Tower III, 1095 Budapest HUNGARY. A declaration of conformity to the requirements of the Directives is available upon request from the Authorized Representative or may be obtained at [www.lexmark.com/en\\_us/about/regulatory-compliance/european-union-declaration-of-conformity.html](http://www.lexmark.com/en_us/about/regulatory-compliance/european-union-declaration-of-conformity.html).

This product satisfies the Class B limits of EN 55022 and safety requirements of EN 60950-1.

## Notice to users in the European Union

Products bearing the CE mark are in conformity with the protection requirements of EC Council directives 2004/108/EC, 2006/95/EC, 1999/5/EC, and 2011/65/EU on the approximation and harmonization of the laws of the Member States relating to electromagnetic compatibility, safety of electrical equipment designed for use within certain voltage limits, radio equipment and telecommunications terminal equipment, and on the restrictions of use of certain hazardous substances in electrical and electronic equipment.

Compliance is indicated by the CE marking.



The manufacturer of this product is: Lexmark International, Inc., 740 West New Circle Road, Lexington, KY, 40550 USA. The authorized representative is: Lexmark International Technology Hungária Kft., 8 Lechner Ödön fasor, Millennium Tower III, 1095 Budapest HUNGARY. A declaration of conformity to the requirements of the Directives is available upon request from the Authorized Representative or may be obtained at [www.lexmark.com/en\\_us/about/regulatory-compliance/european-union-declaration-of-conformity.html](http://www.lexmark.com/en_us/about/regulatory-compliance/european-union-declaration-of-conformity.html).

This product satisfies the Class B limits of EN 55022 and safety requirements of EN 60950-1.

## Radio and Telecommunications Terminal Equipment (R&TTE) Compliance Statement

Česky	Společnost Lexmark International, Inc. tímto prohlašuje, že výrobek tento výrobek je ve shodě se základními požadavky a dalšími příslušnými ustanoveními směrnice 1999/5/ES.
Dansk	Lexmark International, Inc. erklærer herved, at dette produkt overholder de væsentlige krav og øvrige relevante krav i direktiv 1999/5/EF.
Deutsch	Hiermit erklärt Lexmark International, Inc., dass sich das Gerät dieses Gerät in Übereinstimmung mit den grundlegenden Anforderungen und den übrigen einschlägigen Bestimmungen der Richtlinie 1999/5/EG befindet.
Ελληνική	ΜΕ ΤΗΝ ΠΑΡΟΥΣΑ Η LEXMARK INTERNATIONAL, INC. ΔΗΛΩΝΕΙ ΟΤΙ ΑΥΤΟ ΤΟ ΠΡΟΪΟΝ ΣΥΜΜΟΡΦΩΝΕΤΑΙ ΠΡΟΣ ΤΙΣ ΟΥΣΙΩΔΕΙΣ ΑΠΑΙΤΗΣΕΙΣ ΚΑΙ ΤΙΣ ΛΟΙΠΕΣ ΣΧΕΤΙΚΕΣ ΔΙΑΤΑΞΕΙΣ ΤΗΣ ΟΔΗΓΙΑΣ 1999/5/ΕΚ.
English	Hereby, Lexmark International, Inc., declares that this type of equipment is in compliance with the essential requirements and other relevant provisions of Directive 1999/5/EC.
Español	Por medio de la presente, Lexmark International, Inc. declara que este producto cumple con los requisitos esenciales y cualesquiera otras disposiciones aplicables o exigibles de la Directiva 1999/5/CE.
Eesti	Käesolevaga kinnitab Lexmark International, Inc., et seade see toode vastab direktiivi 1999/5/EÜ põhinõuetele ja nimetatud direktiivist tulenevatele muudele asjakohastele sätetele.
Suomi	Lexmark International, Inc. vakuuttaa täten, että tämä tuote on direktiivin 1999/5/EY oleellisten vaatimusten ja muiden sitä koskevien direktiivin ehtojen mukainen.
Français	Par la présente, Lexmark International, Inc. déclare que l'appareil ce produit est conforme aux exigences fondamentales et autres dispositions pertinentes de la directive 1999/5/CE.
Magyar	Alulírott, Lexmark International, Inc. nyilatkozom, hogy a termék megfelel a vonatkozó alapvető követelményeknek és az 1999/5/EC irányelv egyéb előírásainak.
Íslenska	Hér með lýsir Lexmark International, Inc. yfir því að þessi vara er í samræmi við grunnkröfur og aðrar kröfur, sem gerðar eru í tilskipun 1999/5/EC.
Italiano	Con la presente Lexmark International, Inc. dichiara che questo questo prodotto è conforme ai requisiti essenziali ed alle altre disposizioni pertinenti stabilite dalla direttiva 1999/5/CE.

Latviski	Ar šo Lexmark International, Inc. deklarē, ka šis izstrādājums atbilst Direktīvas 1999/5/EK būtiskajām prasībām un citiem ar to saistītajiem noteikumiem.
Lietuvių	Šiuo Lexmark International, Inc. deklaruoja, kad šis produkta atitinka esminius reikalavimus ir kitas 1999/5/EB direktyvos nuostatas.
Malti	Bil-preżenti, Lexmark International, Inc., jiddikjara li dan il-prodott huwa konformi mal-ftiġijiet essenzjali u ma dispożizzjonijiet oħrajn relevanti li jinsabu fid-Direttiva 1999/5/KE.
Nederlands	Hierbij verklaart Lexmark International, Inc. dat het toestel dit product in overeenstemming is met de essentiële eisen en de andere relevante bepalingen van richtlijn 1999/5/EG.
Norsk	Lexmark International, Inc. erklærer herved at dette produktet er i samsvar med de grunnleggende krav og øvrige relevante krav i direktiv 1999/5/EF.
Polski	Niniejszym Lexmark International, Inc. oświadcza, że niniejszy produkt jest zgodny z zasadniczymi wymogami oraz pozostałymi stosownymi postanowieniami Dyrektywy 1999/5/EC.
Português	A Lexmark International Inc. declara que este produto está conforme com os requisitos essenciais e outras disposições da Diretiva 1999/5/CE.
Slovensky	Lexmark International, Inc. týmto vyhlasuje, že tento produkt spĺňa základné požiadavky a všetky príslušné ustanovenia smernice 1999/5/ES.
Slovensko	Lexmark International, Inc. izjavlja, da je ta izdelek v skladu z bistvenimi zahtevami in ostalimi relevantnimi določili direktive 1999/5/ES.
Svenska	Härmed intygar Lexmark International, Inc. att denna produkt står i överensstämmelse med de väsentliga egenskapskrav och övriga relevanta bestämmelser som framgår av direktiv 1999/5/EG.

## 日本の VCCI 規定

製品にこのマークが表示されている場合、次の要件を満たしています。



この装置は、クラス B 情報技術装置です。この装置は、家庭環境で使用することを目的としていますが、この装置がラジオやテレビジョン受信機に近接して使用されると、受信障害を引き起こすことがあります。取扱説明書に従って正しい取り扱いをしてください。

VCCI-B