

Quick Reference

Printer Overview

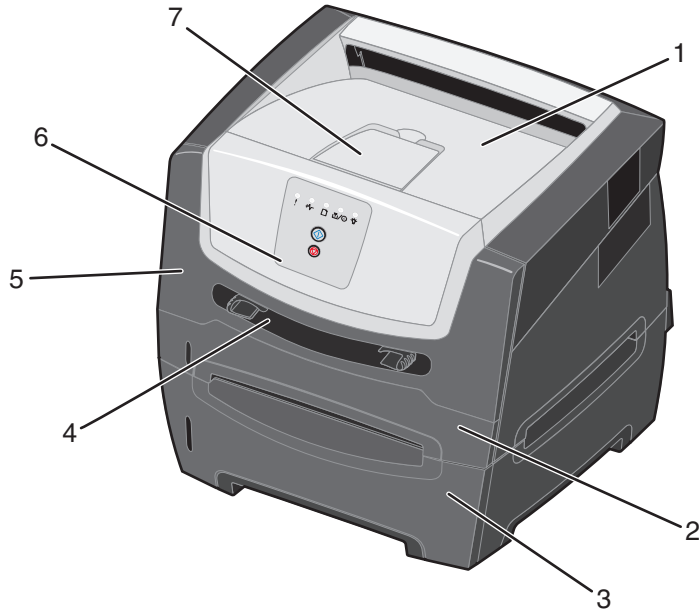

- 1 150-sheet output bin
- 2 250-sheet tray
- 3 550-sheet drawer (optional)
- 4 Manual feeder
- 5 Front door
- 6 Control panel
- 7 Paper support

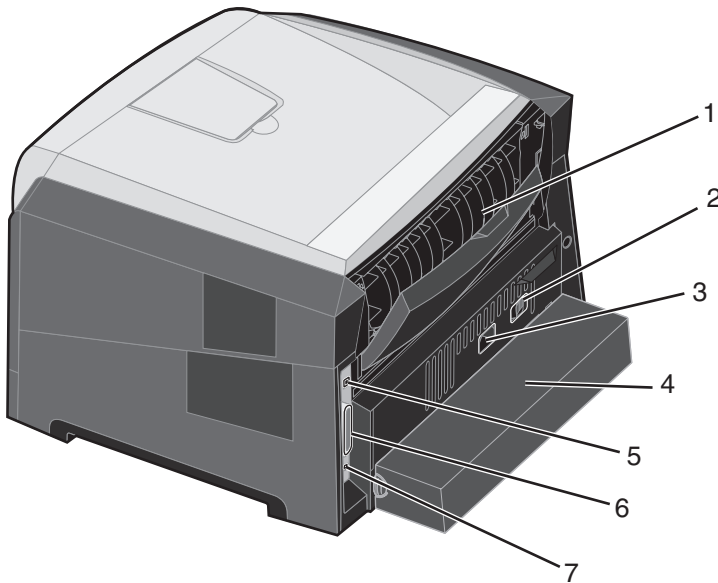

- 1 Rear exit
- 2 Power button
- 3 Power cord connect
- 4 Dust cover (not available for some models)
- 5 USB connect
- 6 Parallel connect
- 7 Ethernet connect

Overview of the control panel

The control panel has 5 lights and 2 buttons.

Note: The Continue button also functions as a light.

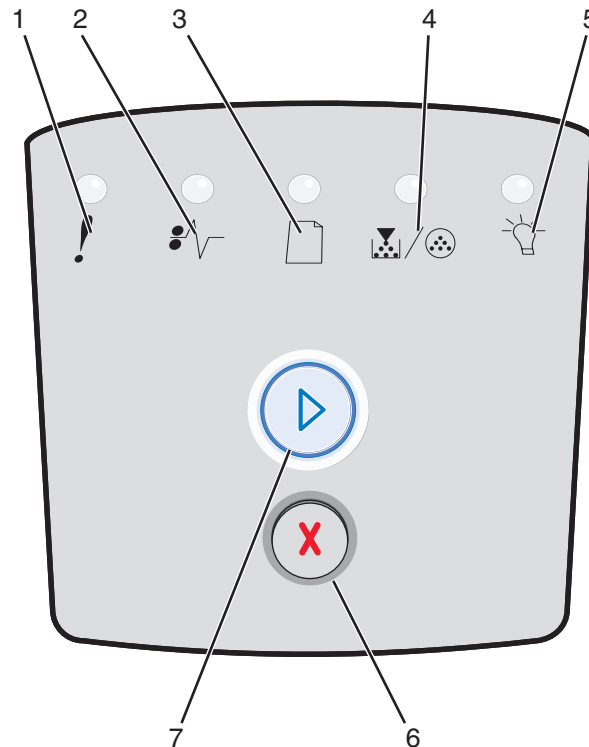

- | | | | |
|---|----------------------------|---|-----------------|
| 1 | Error | 5 | Ready |
| 2 | Paper Jam | 6 | Cancel button |
| 3 | Load Paper | 7 | Continue button |
| 4 | Toner Low / Replace PC Kit | | |





















Following a common error light sequence:

- Press and release **Continue** (▶) to resume printing.
- Press and release **Continue** (▶) twice quickly to display a secondary error code.
- Press and release **Cancel** (⊗) to cancel the job currently printing.
- Press and hold **Cancel** (⊗) until all of the lights come on to reset the printer.





































Understanding the control panel lights

The control panel lights mean different things, depending on their sequence. Lights that are off, on, and/or blinking indicate printer conditions such as printer status, intervention, or service.



























Common light sequences

	 = On	 = Blinking	 = Slow blink	Empty = Off		
Printer Condition	 Continue	 Error	 Toner Low / Replace PC Kit	 Load Paper	 Paper Jam	 Ready
Ready / Power Saver						
Busy						
Hex Trace Ready						
Waiting						
Flushing / Resolution reduced						
Not ready (printer is offline)						
Close door						
Insufficient collation area / Insufficient memory						

Common light sequences (continued)

	   = On	   = Blinking	 = Slow blink	Empty = Off		
Printer Condition	 Continue	 Error	 Toner Low / Replace PC Kit	 Load Paper	 Paper Jam	 Ready
Complex page						
Cancel job/ Reset printer						
Load print media						
Load manual feeder						
Toner low						
Toner cartridge region mismatch						
Photoconductor kit life warning						
Replace photoconductor (printer hard stop)						
Programming engine code/ Programming system code						

Common light sequences (continued)

		 = On	 = Blinking	 = Slow blink	Empty = Off	
Printer Condition						
	Continue	Error	Toner Low / Replace PC Kit	Load Paper	Paper Jam	Ready
Invalid engine code / Invalid network code						
Network interface errors / Host interface disabled						
Service error						
Printer error						
Paper jam printer error						
Short paper						
Output bin full						

Printing the menu settings and network setup pages

To print the menu settings page and network setup page, press the **Continue**  button from the Ready state.

On the menu settings page:

- Verify that the options you installed are correctly listed under “Installed Features.”
If an option is not listed under Installed Features, turn off the printer, unplug the power cord from the wall outlet, and reinstall the option.
- Verify the amount of memory installed is correctly listed under “Printer Information.”
- Verify that the paper trays are configured for the sizes and types of paper you loaded.

Printing a test page from your computer

- 1 Click **Start** → **Settings** → **Printers**.
- 2 Select your printer.
- 3 Click **File** → **Properties**.
- 4 Click **Print Test Page**.

Restoring factory defaults

Sometimes restoring the printer to the original factory default settings solves formatting problems. To reset the factory defaults:

- 1 Turn off the printer.
- 2 Open the front door.
- 3 Press **Continue** as you turn the printer back on.
- 4 Keep pressing **Continue** until the lights cycle, then release the **Continue** button.
- 5 Close the front door.
- 6 Press **Cancel**.
- 7 Press **Continue** until the control panel cycles through all the lights.
The Load Paper, Toner Low / Replace PC Kit, Ready and Continue lights appear.
- 8 Release the **Continue** button.
- 9 Turn the printer off and back on.
Factory defaults have been reset.

Using the Local Printer Settings Utility

The Local Printer Settings Utility lets you change printer settings not available from your printer driver (for example, activating **Alarm Control** if you want the printer to sound an alarm when it needs attention). To access the Local Printer Settings Utility from the computer software application, select **Start → All Programs → Lexmark → Local Printer Settings Utility**.

If you selected the Custom install path from your drivers CD, you must go back to your drivers CD and click **View Documentation** for instructions on installing and using the Local Printer Settings Utility.

You can change the following settings using the Local Printer Settings Utility:

Finishing Settings	Paper Settings	Parallel Settings	PCL Emulation Settings
<ul style="list-style-type: none"> • Copies • Blank Pages • Collation • Separator Sheets • Separator Source • Multipage Print • Multipage Order • Multipage View • Multipage Border 	<ul style="list-style-type: none"> • Paper Source • Paper Size • Paper Type • Custom Types • Substitute Size • Paper Texture • Paper Weight • Paper Loading 	<ul style="list-style-type: none"> • PCL SmartSwitch • PS SmartSwitch • Parallel Buffer • Advanced Status • Honor Init 	<ul style="list-style-type: none"> • Orientation • Lines Per Page • A4 Width • Tray Renumber • Auto CR after LF • Auto LF after CR
PostScript Settings	Quality Settings	Setup Settings	USB Settings
<ul style="list-style-type: none"> • Print PS Error • Font Priority 	<ul style="list-style-type: none"> • Print Resolution • Toner Darkness • Small Font Enhancer 	<ul style="list-style-type: none"> • Eco-mode • Quiet Mode • Alarm Control • Printer Language • Power Saver • Resource Save • Download Target • Print Timeout • Wait Timeout • Auto Continue • Jam Recovery • Page Protect • Print Area • Display Language • Toner Alarm 	<ul style="list-style-type: none"> • PCL SmartSwitch • PS SmartSwitch • USB Buffer

What types of print media can be loaded?

Get the most from your printer by properly loading the trays. Never mix media types within a tray.

Source	Sizes	Types	Weight	Capacity* (sheets)
250-sheet tray	A4, A5, A6 (grain long only), JIS B5, letter, legal, executive, folio, statement	Plain paper, bond, letterhead, transparencies, paper labels (single-sided only)	60–90 g/m ² (16–24 lb)	<ul style="list-style-type: none"> • 250 paper • 50 labels • 50 transparencies
550-sheet drawer	A4, A5, JIS B5, letter, legal, executive, folio, statement	Plain paper, bond, letterhead, transparencies, paper labels (single-sided only)	60–90 g/m ² (16–24 lb)	<ul style="list-style-type: none"> • 550 paper • 50 labels • 50 transparencies
Manual feeder	A4, A5, A6 (grain long only), JIS B5, letter, legal, executive, folio, statement, Universal [‡]	Plain paper, transparencies, paper labels (single-sided only)	60–163 g/m ² (16–43 lb)	1
		Card stock [†]	<ul style="list-style-type: none"> • 120–163 g/m² (66–90 lb) Index Bristol • 75–163 g/m² (46–100 lb) Tag 	
	7 ³ / ₄ , 9, 10, DL, C5, B5	Envelopes	75 g/m ² (20 lb)	

* Capacity for 20 lb print media, unless otherwise noted.

† Grain short is recommended. Use rear exit for best results.

‡ Universal size ranges:

– **Manual feeder:** 76–216 x 127–356 mm (3.0–8.5 x 5.0–14.0 in.) (includes 3 x 5 in. cards)

Note: It is recommended that print media smaller than 8 1/2 x 11 in. be loaded with the short edge toward the front of the tray.

Where can print media be loaded in the printer?

Your printer has two standard paper sources: a 250-sheet tray and a single-sheet manual feeder. Use the 250-sheet tray for most print jobs. Use the manual feeder for a single piece of paper, transparency, envelope, paper label, card stock, or index card. You can increase paper capacity by purchasing an optional 550-sheet drawer.

The output bin on top of the printer holds up to 150 sheets. The single-sheet rear exit provides a straight-through path to help reduce curling and potential jams. This is especially useful for specialty media, such as transparencies, envelopes, paper labels, card stock, or index cards.

Loading the 250-sheet tray

Follow these instructions to load paper in the 250-sheet tray.

- 1 Remove the 250-sheet tray.

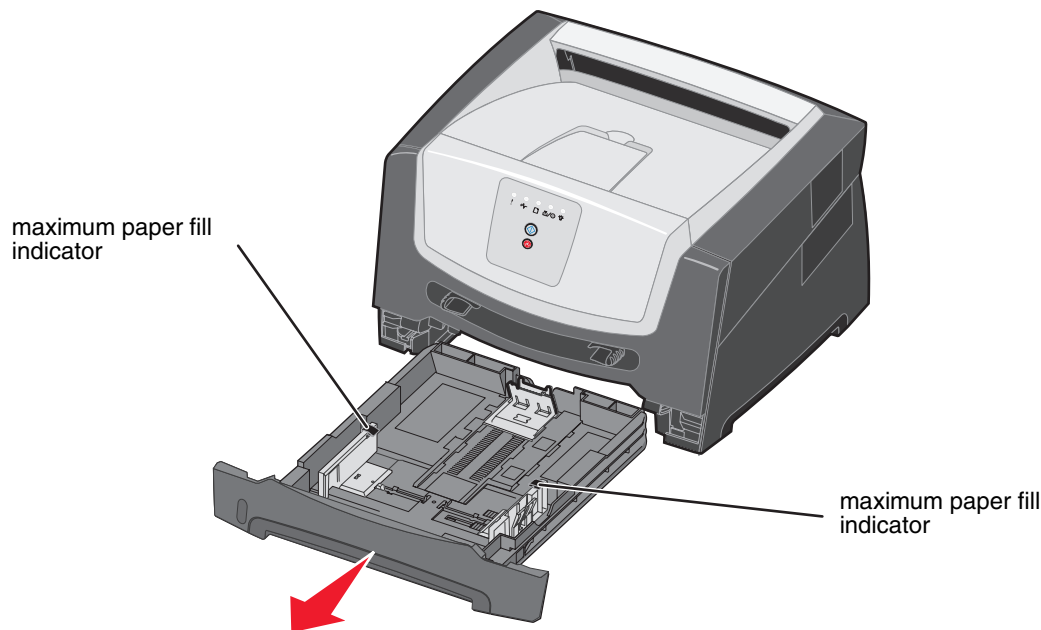

Note: To load legal- or folio-size paper, extend the length of the tray. For more information, see “Extending the tray for legal- or folio-size paper” on page 12.

- 2 Prepare a paper stack for loading by flexing and fanning it back and forth. Straighten the edges on a level surface.

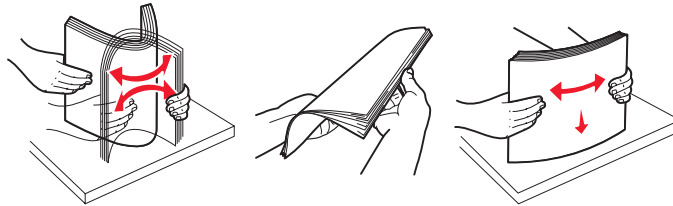

- 3 Adjust the rear paper guide for the print media size you will be loading.

Note: There should be a slight gap between the rear paper guide and the paper stack.

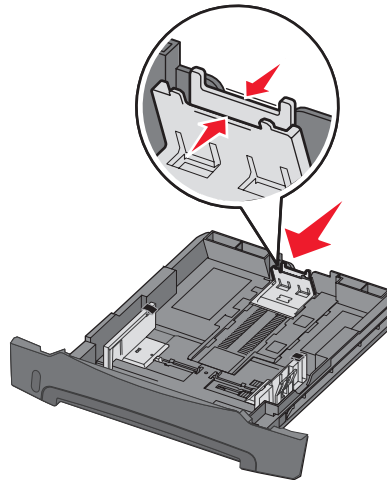

- 4 Insert the paper stack with the print side facing down.

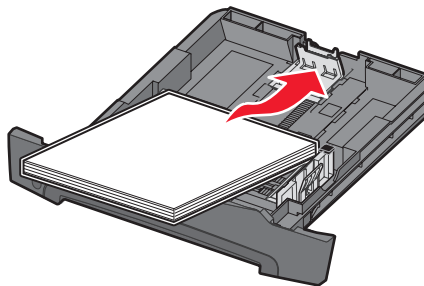

Note: Make sure the paper stack is laying flat in the tray and is not above the maximum paper fill indicators. Improper loading may cause jams.

5 Adjust the side paper guides to fit lightly against the paper stack.

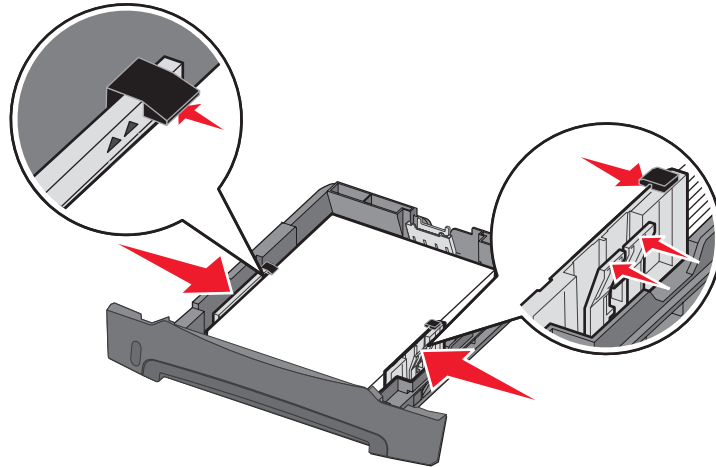

6 Insert the 250-sheet tray.

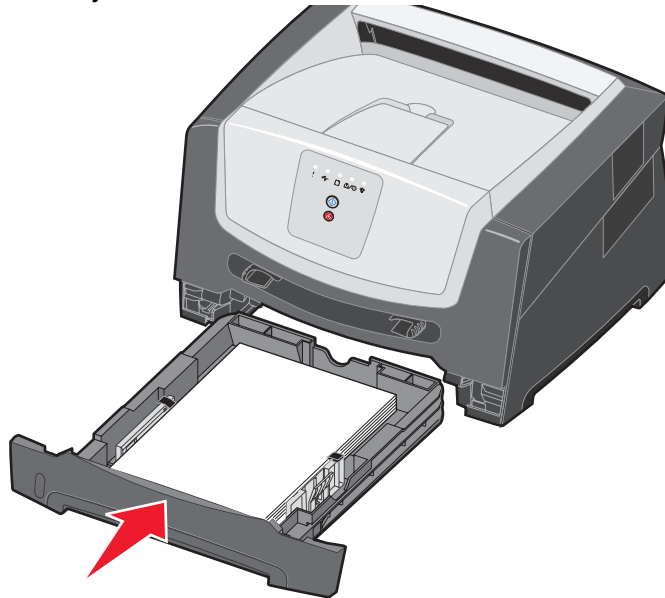

7 Extend the paper support on the output bin.

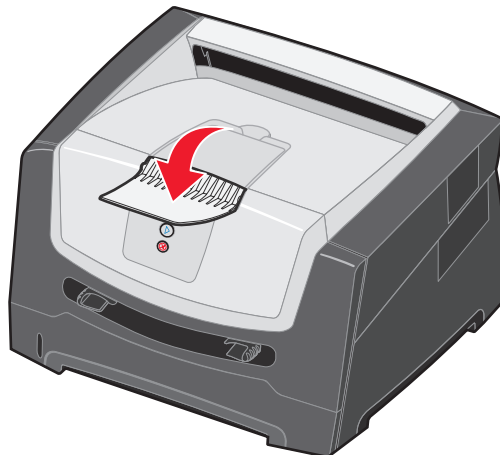

Extending the tray for legal- or folio-size paper

To load legal- or folio-size paper, extend the tray. You may also attach a dust cover (if available on your printer model) on the back of the printer to protect the tray while it is extended.

- 1 Press down on the latch at the back of the tray, and expand the tray until the extender locks into place.

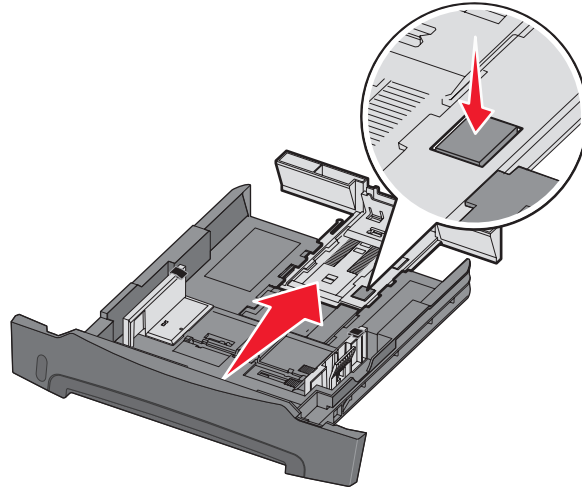

Attaching the dust cover

The dust cover helps protect the tray from the environment. It also keeps the tray from being knocked out of position while it is extended.

Attach the dust cover to the back of the printer by aligning the tabs on the cover to the holes on the printer, then *snap* the cover into place.

Note: This feature may not be available for some models.

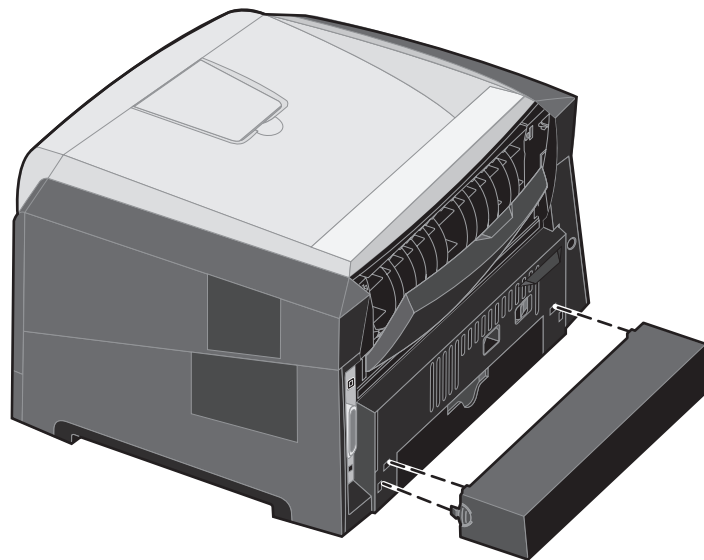

Loading the manual feeder

The manual feeder is located at the front of the printer and can only feed one sheet of print media at a time. You can use the manual feeder to make quick runs of paper types or sizes that are not currently loaded in the tray. You must set the paper size before using the manual feeder. For more information, see your driver CD, or see “Using the Local Printer Settings Utility” on page 7.

For information on acceptable print media to use in the manual feeder, see “What types of print media can be loaded?” on page 8. Using only the specified print media helps prevent paper jams and print-quality problems.

To load the manual feeder:

- 1** Place a sheet of the selected print media, print side facing up, at the center of the manual feeder, but only to the point where its leading edge can contact the paper guides. Otherwise, the printer will engage the print media too soon and likely skew the print job.
- 2** Adjust the paper guides to the print media width.
- 3** Hold both sides of the print media close to the manual feeder, and push it into the printer until it automatically engages.

There is a brief pause between the time the printer engages the print media and when it feeds into the printer.



Note: Do not force the print media into the feeder. Forcing the media causes jams.

- Insert envelopes with the flap side down and with the stamp area as shown.
- Hold transparencies by the edges, and avoid touching the print side. Oil from your fingers can affect print quality.
- Load letterhead faceup, with the top of the sheet entering first.

Using the rear exit

The single-sheet rear exit provides a straight-through paper path to help reduce curling and potential jams. This is especially useful for specialty media, such as transparencies, labels, card stock, or index cards.

To use the rear exit, open the rear exit door. When the rear exit door is open, all print media comes out the rear exit. When closed, all media is sent to the output bin on top of the printer.

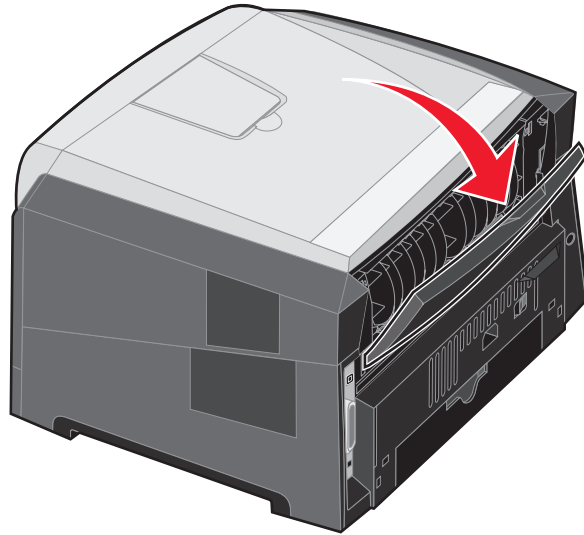

Note: If you print a multiple-page job with the rear exit door open, the print speed may slow down.

Canceling a print job

A print job can be canceled from the control panel or from your computer. The Cancel job light sequence is displayed on the control panel while the job is being canceled.

From the printer control panel

Press and release **Cancel**  to cancel the job currently printing.

From a Windows computer

- 1 Click **Start** → **Settings** → **Printers**.
- 2 Double-click the printer you are using to print the job.
A list of print jobs appears.
- 3 Right-click the document you want to stop printing, and then click **Cancel**.

From a Macintosh computer

Canceling a print job from a computer running Mac OS 9

When you send a job to print, the printer icon for your selected printer appears on the desktop.



- 1 Double-click the printer icon on your desktop.
A list of print jobs appears in the printer window.
- 2 Select the print job you want to cancel.
- 3 Click the trash can button.

Canceling a job from a computer running Mac OS X

When you send a job to print, the printer icon for your selected printer appears in the dock.

- 1 Open **Applications** → **Utilities**, and then double-click **Print Center** or **Printer Setup**.
- 2 Double-click the printer you are printing to.
- 3 In the printer window, select the print job you want to cancel.
- 4 Press **Delete**.

Clearing jams

When a paper jam occurs, the printer stops and the control panel **Paper Jam**  and **Continue**  lights come on. For more information, see the *Software and Documentation* CD that came with your printer.

We recommend clearing the entire paper path when a paper jam occurs.

- 1 Remove all paper from the 150-sheet output bin.
- 2 If you are feeding paper from the 250-sheet tray, remove the tray.

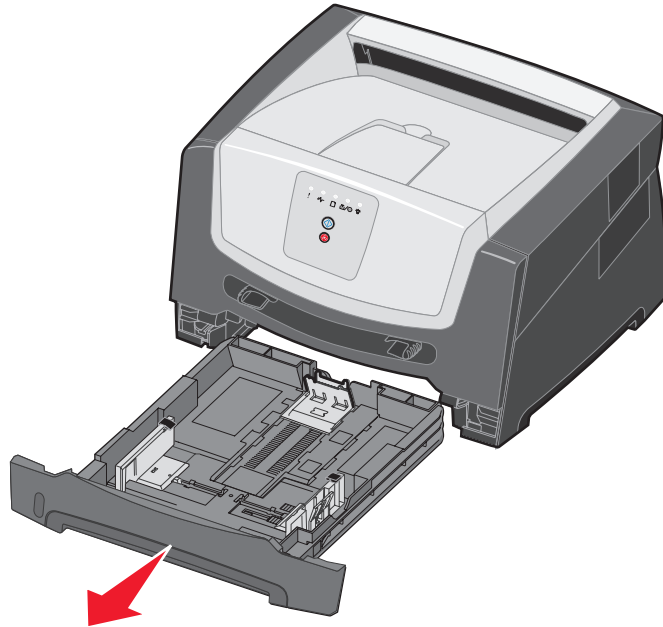

- 3 Remove the jammed pages.

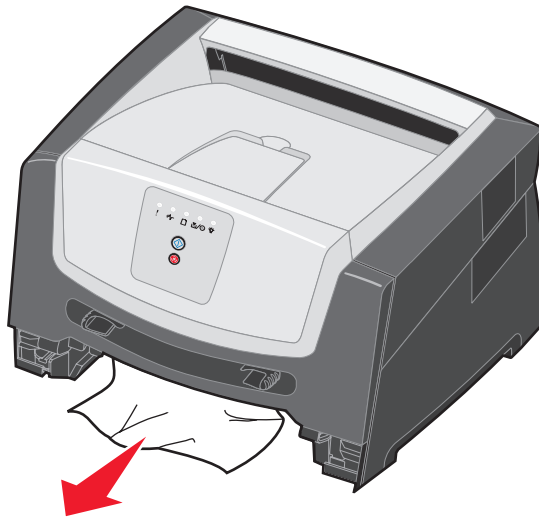

- 4 With the tray removed, press down on the green duplex flap to remove the jammed pages from the duplex area.

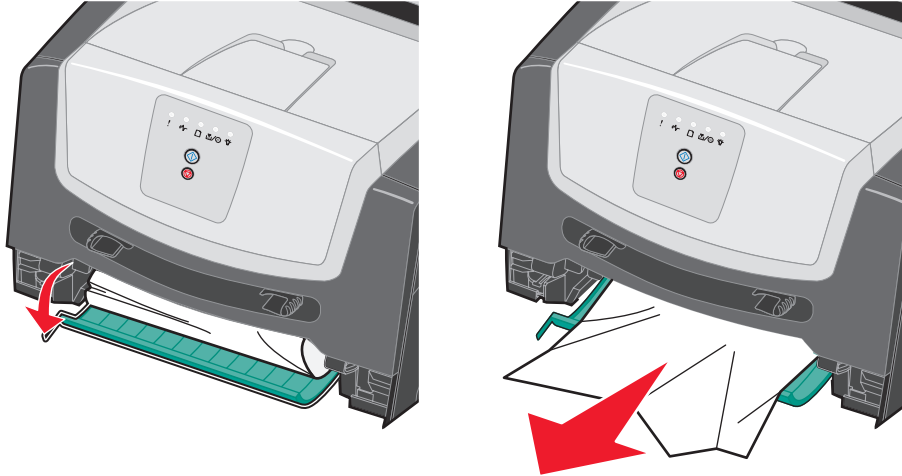

- 5 Install the 250-sheet tray.
6 Open the front door, and remove the print cartridge assembly.

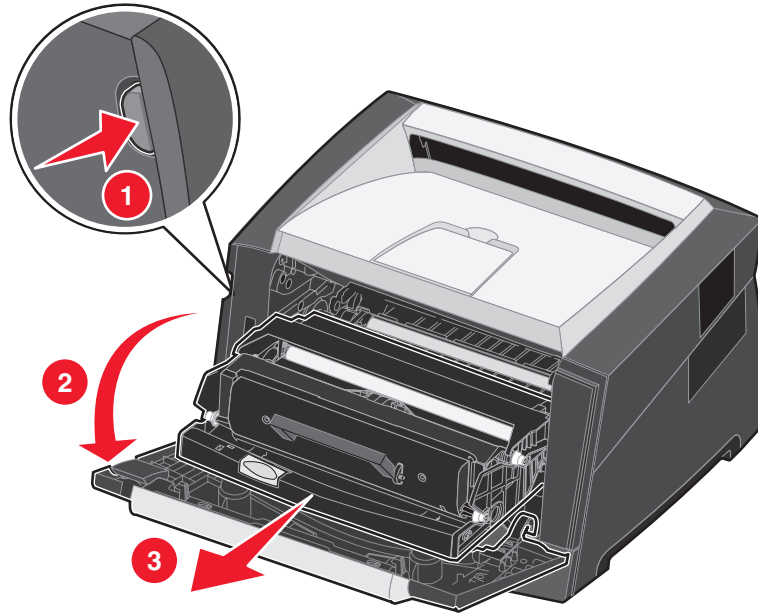

- 7 Lift the green flap at the front of the printer, and remove the jammed pages from behind the flap.



CAUTION: The fuser or fuser area may be hot.

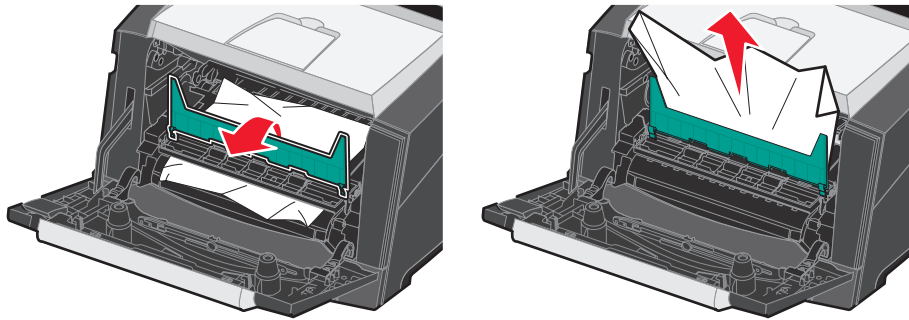

- 8 Open the rear exit door, and remove the jammed pages.

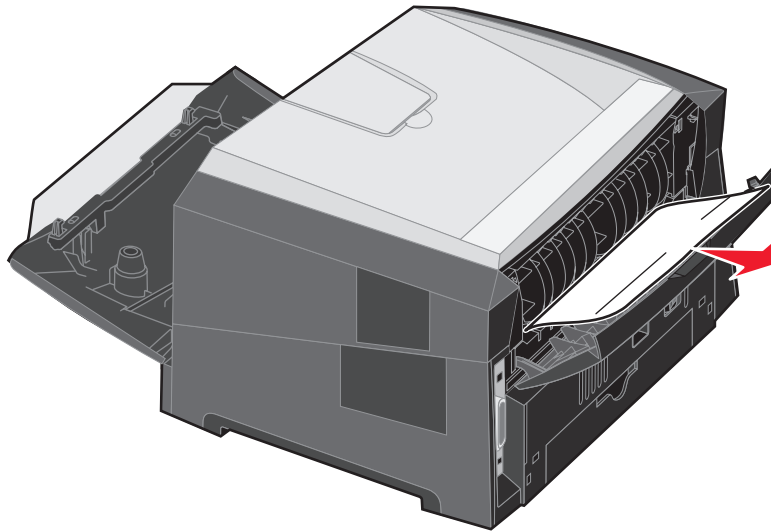

- 9 After you have cleared the jammed pages, reinstall the print cartridge assembly, and securely close all the printer doors.
- 10 Press **Continue**  to resume printing.

Note: Jam recovery is set to Auto by default. When jam recovery is set to Auto, the memory that holds the image of a page may be reused after the page is printed but before it has successfully exited the printer if that memory is needed for another use. Therefore, a jammed page may or may not be reprinted, depending on the overall memory usage of the printer.