



MX610 Series

User's Guide

May 2013

www.lexmark.com

Machine type(s):

7016

Model(s):

630, 670, 675

Contents

- Safety information.....7**
- Learning about the printer.....9**
 - Finding information about the printer.....9
 - Selecting a location for the printer.....10
 - Printer configurations.....11
 - Using the Embedded Web Server.....13
 - Understanding the basic functions of the scanner.....14
 - Using the ADF and scanner glass.....14
- Understanding the printer control panel.....15**
 - Using the printer control panel.....15
 - Understanding the colors of the Sleep button and indicator lights.....15
 - Understanding the home screen.....16
 - Using the touch-screen buttons.....18
- Setting up and using the home screen applications.....20**
 - Finding the IP address of the computer.....20
 - Finding the IP address of the printer.....21
 - Accessing the Embedded Web Server.....21
 - Customizing the home screen.....21
 - Understanding the different applications.....22
 - Activating the home screen applications.....22
 - Finding information about the home screen applications.....22
 - Setting up Forms and Favorites22
 - Setting up Card Copy23
 - Using MyShortcut24
 - Setting up Multi Send24
 - Setting up Scan to Network25
 - Setting up Remote Operator Panel.....26
 - Exporting and importing a configuration.....26
- Additional printer setup.....28**
 - Installing internal options.....28
 - Installing hardware options.....44
 - Attaching cables.....47

Setting up the printer software.....	48
Networking.....	50
Verifying printer setup.....	58
Loading paper and specialty media.....	59
Setting the paper size and type.....	59
Configuring Universal paper settings.....	59
Loading trays.....	59
Loading the multipurpose feeder.....	64
Using the standard bin and paper stop.....	69
Linking and unlinking trays.....	70
Paper and specialty media guide.....	73
Using specialty media.....	73
Paper guidelines.....	75
Supported paper sizes, types, and weights.....	78
Printing.....	82
Printing forms and a document.....	82
Printing from a flash drive or mobile device.....	83
Printing confidential and other held jobs.....	85
Printing information pages.....	87
Canceling a print job.....	87
Copying.....	89
Making copies.....	89
Copying photos.....	90
Copying on specialty media.....	90
Customizing copy settings.....	91
Placing information on copies.....	97
Canceling a copy job.....	97
Understanding the copy options.....	98
E-mailing.....	100
Setting up the printer to e-mail.....	100
Creating an e-mail shortcut.....	101
E-mailing a document.....	102
Customizing e-mail settings.....	103

Canceling an e-mail.....104
 Understanding the e-mail options.....104

Faxing.....107

Setting up the printer to fax.....107
 Sending a fax.....121
 Creating shortcuts.....124
 Customizing fax settings.....124
 Canceling an outgoing fax.....126
 Holding and forwarding faxes.....126
 Understanding the fax options.....127

Scanning.....130

Using Scan to Network.....130
 Scanning to an FTP address.....130
 Scanning to a computer or flash drive.....132
 Understanding the scan options.....135

Understanding the printer menus.....138

Menus list.....138
 Paper menu.....139
 Reports Menu.....149
 Network/Ports menu.....150
 Security menu.....158
 Settings menu.....163
 Help menu.....209

Saving money and the environment.....210

Saving paper and toner.....210
 Saving energy.....211
 Recycling.....215

Securing the printer.....216

Statement of Volatility.....216
 Erasing volatile memory.....216
 Erasing non-volatile memory.....217
 Erasing printer hard disk memory.....217
 Configuring printer hard disk encryption.....218

Finding printer security information.....219

Maintaining the printer.....220

Cleaning the printer parts.....220

Checking the status of parts and supplies.....222

Estimated number of remaining pages.....222

Ordering supplies.....222

Storing supplies.....224

Replacing supplies.....225

Moving the printer.....231

Managing the printer.....232

Finding advanced networking and administrator information.....232

Checking the virtual display.....232

Setting up e-mail alerts.....232

Viewing reports.....232

Configuring supply notifications from the Embedded Web Server.....233

Restoring factory default settings.....234

Clearing jams.....235

Avoiding jams.....235

Understanding jam messages and locations.....236

[x]-page jam, open automatic feeder top cover. [28y.xx].....238

[x]-page jam, clear standard bin. [20y.xx].....238

[x]-page jam, open rear door. [20y.xx].....239

[x]-page jam, open front door. [20y.xx].....240

[x]-page jam, remove tray 1 to clear duplex. [23y.xx].....243

[x]-page jam, clear manual feeder. [25y.xx].....244

[x]-page jam, open tray [x]. [24y.xx].....245

[x]-page jam, remove all pages from the output bin. Leave paper in bin. [45y.xx].....247

Troubleshooting.....253

Understanding the printer messages.....253

Solving printer problems.....268

Solving print problems.....274

Solving copy problems.....299

Solving fax problems.....303

Solving scanner problems.....309
Solving home screen applications problems.....314
Embedded Web Server does not open.....314
Contacting customer support.....315

Notices.....316

Product information.....316
Edition notice.....316
Power consumption.....320

Index.....333

Safety information

Connect the power cord to a properly grounded electrical outlet that is near the product and easily accessible.

Do not place or use this product near water or wet locations.

 **CAUTION—POTENTIAL INJURY:** This product uses a laser. Use of controls or adjustments or performance of procedures other than those specified herein may result in hazardous radiation exposure.

This product uses a printing process that heats the print media, and the heat may cause the media to release emissions. You must understand the section in your operating instructions that discusses the guidelines for selecting print media to avoid the possibility of harmful emissions.

 **CAUTION—POTENTIAL INJURY:** The lithium battery in this product is not intended to be replaced. There is a danger of explosion if a lithium battery is incorrectly replaced. Do not recharge, disassemble, or incinerate a lithium battery. Discard used lithium batteries according to the manufacturer's instructions and local regulations.

 **CAUTION—HOT SURFACE:** The inside of the printer might be hot. To reduce the risk of injury from a hot component, allow the surface to cool before touching.

 **CAUTION—POTENTIAL INJURY:** The printer weight is greater than 18 kg (40 lb) and requires two or more trained personnel to lift it safely.

 **CAUTION—POTENTIAL INJURY:** Before moving the printer, follow these guidelines to avoid personal injury or printer damage:

- Turn the printer off using the power switch, and then unplug the power cord from the electrical outlet.
- Disconnect all cords and cables from the printer before moving it.
- If an optional tray is installed, then remove it from the printer. To remove the optional tray, slide the latch on the right side of the tray toward the front of the tray until it *clicks* into place.
- Use the handholds located on both sides of the printer to lift it.
- Make sure your fingers are not under the printer when you set it down.
- Before setting up the printer, make sure there is adequate clearance around it.

Use only the power cord provided with this product or the manufacturer's authorized replacement.

Use only the telecommunications (RJ-11) cord provided with this product or a 26 AWG or larger replacement when connecting this product to the public switched telephone network.

 **CAUTION—SHOCK HAZARD:** If you are accessing the controller board or installing optional hardware or memory devices sometime after setting up the printer, then turn the printer off, and unplug the power cord from the electrical outlet before continuing. If you have any other devices attached to the printer, then turn them off as well, and unplug any cables going into the printer.

 **CAUTION—SHOCK HAZARD:** Make sure that all external connections (such as Ethernet and telephone system connections) are properly installed in their marked plug-in ports.

This product is designed, tested, and approved to meet strict global safety standards with the use of specific manufacturer's components. The safety features of some parts may not always be obvious. The manufacturer is not responsible for the use of other replacement parts.

 **CAUTION—POTENTIAL INJURY:** Do not cut, twist, bind, crush, or place heavy objects on the power cord. Do not subject the power cord to abrasion or stress. Do not pinch the power cord between objects such as furniture and walls. If any of these things happen, a risk of fire or electrical shock results. Inspect the power cord regularly for signs of such problems. Remove the power cord from the electrical outlet before inspecting it.

Refer service or repairs, other than those described in the user documentation, to a service representative.

 **CAUTION—TIPPING HAZARD:** Floor-mounted configurations require additional furniture for stability. You must use either a printer stand or printer base if you are using multiple input options. If you purchased a multifunction printer (MFP) that scans, copies, and faxes, then you may need additional furniture. For more information, see www.lexmark.com/multifunctionprinters.

 **CAUTION—POTENTIAL INJURY:** To reduce the risk of equipment instability, load each tray separately. Keep all other trays closed until needed.

 **CAUTION—SHOCK HAZARD:** Do not use the fax feature during a lightning storm. Do not set up this product or make any electrical or cabling connections, such as the fax feature, power cord, or telephone, during a lightning storm.

 **CAUTION—SHOCK HAZARD:** To avoid the risk of electrical shock when cleaning the exterior of the printer, unplug the power cord from the electrical outlet and disconnect all cables from the printer before proceeding.

SAVE THESE INSTRUCTIONS.

Learning about the printer

Finding information about the printer

What are you looking for?	Find it here
<p>Initial setup instructions:</p> <ul style="list-style-type: none"> • Connecting the printer • Installing the printer software 	<p>Setup documentation—The setup documentation came with the printer and is also available at http://support.lexmark.com.</p>
<p>Additional setup and instructions for using the printer:</p> <ul style="list-style-type: none"> • Selecting and storing paper and specialty media • Loading paper • Configuring printer settings • Viewing and printing documents and photos • Setting up and using the printer software • Configuring the printer on a network • Caring for and maintaining the printer • Troubleshooting and solving problems 	<p><i>User's Guide</i> and <i>Quick Reference Guide</i>—The guides may be available on the <i>Software and Documentation</i> CD. For more information, visit http://support.lexmark.com.</p>
<p>Instructions for:</p> <ul style="list-style-type: none"> • Connecting the printer to an Ethernet network • Troubleshooting printer connection problems 	<p><i>Networking Guide</i>—Open the <i>Software and Documentation</i> CD, and then navigate to: Documentation > User's Guide and other publications > Networking Guide</p>
<p>Help using the printer software</p>	<p>Windows or Mac Help—Open a printer software program or application, and then click Help.</p> <p>Click  to view context-sensitive information.</p> <p>Notes:</p> <ul style="list-style-type: none"> • Help is automatically installed with the printer software. • The printer software is located in the printer program folder or on the desktop, depending on your operating system.

What are you looking for?	Find it here
<p>The latest supplemental information, updates, and customer support:</p> <ul style="list-style-type: none"> • Documentation • Driver downloads • Live chat support • E-mail support • Voice support 	<p>Lexmark support Web site— http://support.lexmark.com</p> <p>Note: Select your country or region, and then select your product to view the appropriate support site.</p> <p>Support telephone numbers and hours of operation for your country or region can be found on the support Web site or on the printed warranty that came with your printer.</p> <p>Record the following information (located on the store receipt and at the back of the printer), and have it ready when you contact customer support so that they may serve you faster:</p> <ul style="list-style-type: none"> • Machine Type number • Serial number • Date purchased • Store where purchased
<p>Warranty information</p>	<p>Warranty information varies by country or region:</p> <ul style="list-style-type: none"> • In the U.S.—See the Statement of Limited Warranty included with this printer, or at http://support.lexmark.com. • In other countries and regions—See the printed warranty that came with your printer.

Selecting a location for the printer

 **CAUTION—POTENTIAL INJURY:** The printer weight is greater than 18 kg (40 lb) and requires two or more trained personnel to lift it safely.

When selecting a location for the printer, leave enough room to open trays, covers, and doors. If you plan to install any options, then leave enough room for them also. It is important to:

- Set up the printer near a properly grounded and easily accessible electrical outlet.
- Make sure airflow in the room meets the latest revision of the ASHRAE 62 standard or the CEN Technical Committee 156 standard.
- Provide a flat, sturdy, and stable surface.
- Keep the printer:
 - Clean, dry, and free of dust.
 - Away from stray staples and paper clips.
 - Away from the direct airflow of air conditioners, heaters, or ventilators.
 - Free from direct sunlight and humidity extremes.
- Observe the recommended temperatures and avoid fluctuations:

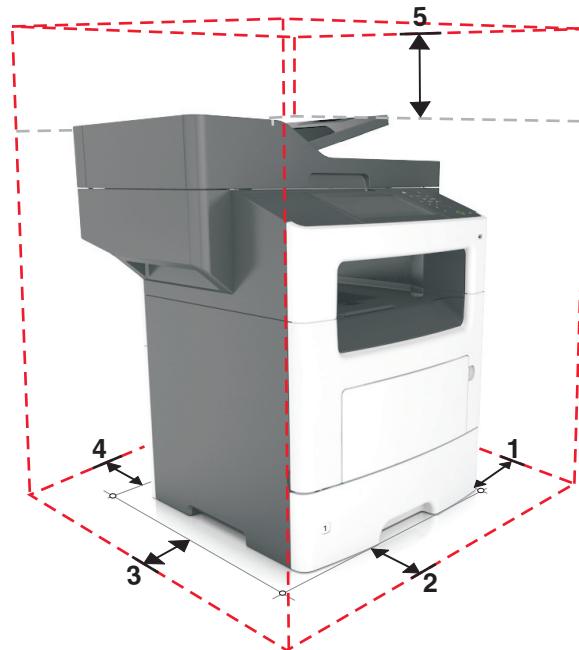

Ambient temperature	15.6 to 32.2°C (60 to 90°F)
Storage temperature	1 to 35°C (34 to 95°F)

- Allow the following recommended amount of space around the printer for proper ventilation:



1	Right side	304.8 mm (12 in.)
2	Front	508 mm (20 in.)
3	Left side	203.2 mm (8 in.)
4	Rear	203.2 mm (8 in.)
5	Top	800 mm (31.49 in.)

Printer configurations

- 
CAUTION—POTENTIAL INJURY: To reduce the risk of equipment instability, load each tray separately. Keep all other trays closed until needed.
- 
CAUTION—TIPPING HAZARD: Floor-mounted configurations require additional furniture for stability. You must use either a printer stand or printer base if you are using multiple input options. If you purchased a multifunction printer (MFP) that scans, copies, and faxes, then you may need additional furniture. For more information, see www.lexmark.com/multifunctionprinters.

Basic model

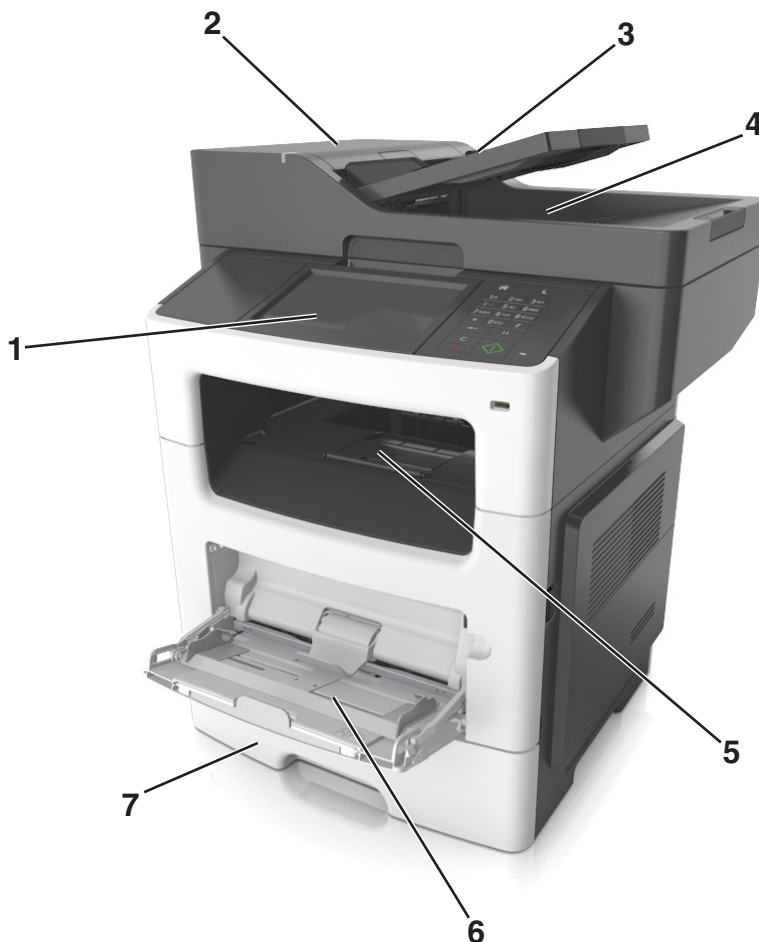

1	Display
2	Automatic document feeder (ADF)
3	ADF tray
4	ADF bin
5	Standard bin
6	Multipurpose feeder
7	Standard 550-sheet tray

Configured model



1	Optional 250-sheet tray
2	Optional 550-sheet tray
3	Optional stapler

Using the Embedded Web Server

Note: This feature is available only in network printers or printers connected to print servers.

If the printer is installed on a network, then you can use the Embedded Web Server to do the following:

- View the virtual display of the printer control panel.
- Check the status of the printer supplies.
- Configure supply notifications.
- Configure printer settings.
- Configure network settings.
- View reports.

To access the Embedded Web Server for your printer:

1 Obtain the printer IP address:

- From the TCP/IP section in the Network/Ports menu
- By printing a network setup page or menu settings page, and then finding the TCP/IP section

Notes:

- An IP address appears as four sets of numbers separated by periods, such as 123.123.123.123.
- If you are using a proxy server, then temporarily disable it to load the Web page correctly.

2 Open a Web browser, and then type the printer IP address in the address field.



3 Press **Enter**.

The Embedded Web Server page appears.

Understanding the basic functions of the scanner

- Make quick copies or set the printer to perform specific copy jobs.
- Send a fax using the printer control panel.
- Send a fax to multiple fax destinations at the same time.
- Scan documents and send them to your computer, an e-mail address, or an FTP destination.
- Scan documents and send them to another printer (PDF through an FTP).

Using the ADF and scanner glass

Automatic document feeder (ADF)	Scanner glass
 <p data-bbox="149 1150 716 1213">Use the ADF for multiple-page documents including two-sided (duplex) pages.</p>	 <p data-bbox="760 1192 1474 1285">Use the scanner glass for single-page documents, book pages, small items (such as postcards or photos), transparencies, photo paper, or thin media (such as magazine clippings).</p>

Using the ADF

When using the ADF:

- Load the document into the ADF tray faceup, short edge first.
- Load up to 50 sheets of plain paper into the ADF tray.
- Scan sizes from 105 x 148 mm (4.1 x 5.8 inches) wide to 216 x 368 mm (8.5 x 14.5 inches) long.
- Scan media weights from 52 to 120 g/m² (14–32 lb).
- Do not load postcards, photos, small items, transparencies, photo paper, or thin media (such as magazine clippings) into the ADF tray. Place these items on the scanner glass.

Using the scanner glass

When using the scanner glass:

- Place a document facedown on the scanner glass in the corner with the green arrow.
- Scan or copy documents up to 216 x 355.6 mm (8.5 x 14 inches) long.
- Copy books up to 25.3 mm (1 inch) thick.

Understanding the printer control panel

Using the printer control panel

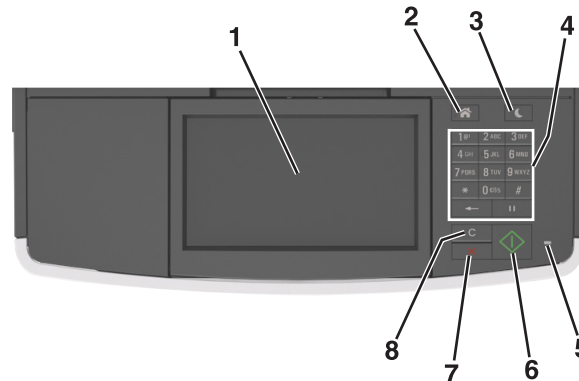

Use the		To
1	Printer control panel	<ul style="list-style-type: none"> View the printer status and messages. Set up and operate the printer.
2	Home button	Go to the home screen.
3	Sleep button	Enable Sleep mode or Hibernate mode. Do the following to wake the printer from Sleep mode: <ul style="list-style-type: none"> Press any hard button. Open a door or cover. Send a print job from the computer. Perform a power-on reset (POR) with the main power switch. Attach a device to the USB port on the printer.
4	Keypad	Enter numbers, letters, or symbols.
5	Indicator light	Check the status of the printer.
6	Start button	Start a job, depending on which mode is selected.
7	Cancel button	Stop all printer activity.
8	Clear All / Reset button	Reset the default settings of a function, such as printing, copying, or e-mailing.

Understanding the colors of the Sleep button and indicator lights

The colors of the Sleep button and indicator lights on the printer control panel signify a certain printer status or condition.

Indicator light	Printer status
Off	The printer is off or in Hibernate mode.
Blinking green	The printer is warming up, processing data, or printing.

Indicator light	Printer status
Solid green	The printer is on, but idle.
Blinking red	The printer requires user intervention.
Sleep button light	Printer status
Off	The printer is off, idle or in Ready state.
Solid amber	The printer is in Sleep mode.
Blinking amber	The printer is entering or waking from Hibernate mode.
Blinking amber for 0.1 second, then goes completely off for 1.9 seconds in a slow, pulsing pattern	The printer is in Hibernate mode.

Understanding the home screen

When the printer is turned on, the display shows a basic screen, referred to as the home screen. Touch the home screen buttons and icons to initiate an action such as copying, faxing, or scanning; to open the menu screen; or to respond to messages.

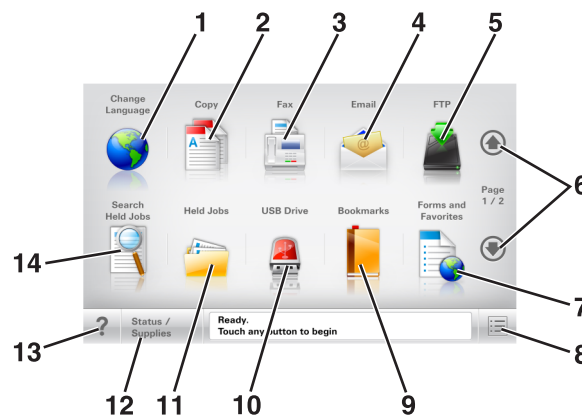

Note: Your home screen may vary depending on your home screen customization settings, administrative setup, and active embedded solutions.



Touch	To
1	Change Language Launch the Change Language pop-up window that lets you change the primary language of the printer.
2	Copy Access the Copy menus and make copies.
3	Fax Access the Fax menus and send fax.
4	E-mail Access the E-mail menus and send e-mails.
5	FTP Access the File Transfer Protocol (FTP) menus and scan documents directly to an FTP server.
6	Arrows Scroll up or down.
7	Forms and Favorites Quickly find and print frequently used online forms.
8	Menu icon Access the printer menus. Note: The menus are available only when the printer is in Ready state.

Touch		To
9	Bookmarks	Create, organize, and save a set of bookmarks (URL) into a tree view of folders and file links. Note: The tree view supports only bookmarks created from this function, and not from any other application.
10	USB Drive	View, select, print, scan, or e-mail photos and documents from a flash drive. Note: This icon appears only when you return to the home screen while a memory card or flash drive is connected to the printer.
11	Held Jobs	Display all current held jobs.
12	Status/Supplies	<ul style="list-style-type: none"> Show a warning or error message whenever the printer requires intervention to continue processing. Access the messages screen for more information on the message, and how to clear it.
13	Tips	Open a context-sensitive Help dialog.
14	Search held jobs	Search for one or more of the following items: <ul style="list-style-type: none"> User name for held or confidential print jobs Job names for held jobs, excluding confidential print jobs Profile names Bookmark container or print job names USB container or print job names for supported file types

Features

Feature	Description
Menu trail line Example: <u>Menus</u> > <u>Settings</u> > <u>Copy Settings</u> > Number of Copies	A menu trail line is located at the top of each menu screen. This feature shows the path taken to arrive at the current menu. Touch any of the underlined words to return to that menu. Number of Copies is not underlined because it is the current screen. If you touch an underlined word on the “Number of Copies” screen before the number of copies is set and saved, then the selection is not saved, and it does not become the default setting.
Attendance message alert 	If an attendance message affects a function, then this icon appears and the red indicator light blinks.
Warning 	If an error condition occurs, then this icon appears.
Status message bar	<ul style="list-style-type: none"> Show the current printer status such as Ready or Busy. Show printer conditions such as Toner Low or Cartridge Low. Show intervention messages so the printer can continue processing.

Feature	Description
Printer IP address Example: 123 . 123 . 123 . 123	The IP address of your network printer is located at the upper left corner of the home screen and appears as four sets of numbers separated by periods. You can use the IP address when accessing the Embedded Web Server so you can view and remotely configure printer settings even when you are not physically near the printer.

Using the touch-screen buttons

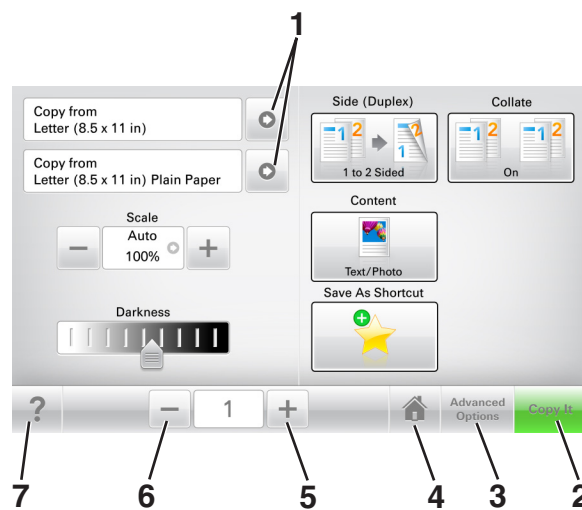

Note: Your home screen, icons, and buttons may vary, depending on your home screen customization settings, administrative setup, and active embedded solutions.



	Touch	To
1	Arrows	View a list of options.
2	Copy It	Print a copy.
3	Advanced Options	Select a copy option.
4	Home	Go to the home screen.
5	Increase	Select a higher value.
6	Decrease	Select a lower value.
7	Tips	Open a context-sensitive Help dialog.

Other touch-screen buttons

Touch	To
Accept 	Save a setting.

Touch	To
<p data-bbox="149 277 224 302">Cancel</p> 	<ul data-bbox="594 281 1393 352" style="list-style-type: none">• Cancel an action or a selection.• Exit a screen and return to the previous screen without saving changes.
<p data-bbox="149 449 214 474">Reset</p> 	<p data-bbox="581 449 873 474">Reset values on the screen.</p>

Setting up and using the home screen applications

Notes:

- Your home screen may vary, depending on your home screen customization settings, administrative setup, and active applications. Some applications are supported only in select printer models.
- There may be additional solutions and applications available for purchase. For more information, visit <http://support.lexmark.com> or contact the place where you purchased the printer.

Finding the IP address of the computer

Note: Make sure that you know how your printer and computer are connected to the network (Ethernet or wireless).

The computer IP address is required when setting up home screen applications, such as:

- Forms and Favorites
- Multi Send
- Scan to Network

For Windows users

1 Open the command window.

In Windows 8

From the Search charm, type **run**, and then navigate to:

Apps list > **Run** > type **cmd** > **OK**

In Windows 7 or earlier

- a Click  or click **Start**, and then click **Run**.
- b In the Start Search or Run dialog, type **cmd**.
- c Press **Enter**, or click **OK**.

2 Type **ipconfig**, and then click **Go** or press **Enter**.

Note: Type **ipconfig /all** to see additional useful information.

3 Look for **IP Address**.

The IP address appears as four sets of numbers separated by periods, such as 123.123.123.123.

For Macintosh users

Note: This is applicable only in Mac OS X version 10.5 or later.

- 1 From the Apple menu, navigate to:
System Preferences > Network
- 2 Click **Ethernet**, **Wi-Fi**, or **AirPort**.

3 Click **Advanced > TCP/IP**.

4 Look for **IPv4 Address**.

Finding the IP address of the printer

Note: Make sure your printer is connected to a network or to a print server.

You can find the printer IP address:

- From the top left corner of the printer home screen.
- From the TCP/IP section in the Network/Ports menu.
- By printing a network setup page or menu settings page, and then finding the TCP/IP section.

Note: An IP address appears as four sets of numbers separated by periods, such as 123.123.123.123.

Accessing the Embedded Web Server

The Embedded Web Server is the printer Web page that lets you view and remotely configure printer settings even when you are not physically near the printer.

1 Obtain the printer IP address:

- From the printer control panel home screen
- From the TCP/IP section in the Network/Ports menu
- By printing a network setup page or menu settings page, and then finding the TCP/IP section

Note: An IP address appears as four sets of numbers separated by periods, such as 123 . 123 . 123 . 123.

2 Open a Web browser, and then type the printer IP address in the address field.

3 Press **Enter**.

Note: If you are using a proxy server, then temporarily disable it to load the Web page correctly.

Customizing the home screen

1 Open a Web browser, and then type the printer IP address in the address field.

Note: View the printer IP address on the printer home screen. The IP address appears as four sets of numbers separated by periods, such as 123.123.123.123.

2 Do one or more of the following:

- Show or hide the icons of basic printer functions.
 - a** Click **Settings > General Settings > Home screen customization**.
 - b** Select the check boxes to specify which icons appear on the home screen.

Note: If you clear a check box beside an icon, then the icon does not appear on the home screen.

- c** Click **Submit**.
- Customize the icon for an application. For more information, see “Finding information about the home screen applications” on page 22 or see the documentation that came with the application.

Understanding the different applications

Use	To
Card Copy	Scan and print both sides of a card on a single page. For more information, see “Setting up Card Copy” on page 23.
Fax	Scan a document, and then send it to a fax number. For more information, see “Faxing” on page 107.
Forms and Favorites	Quickly find and print frequently used online forms directly from the printer home screen. For more information, see “Setting up Forms and Favorites” on page 22.
Multi Send	Scan a document, and then send it to multiple destinations. For more information, see “Setting up Multi Send” on page 24.
MyShortcut	Create shortcuts directly on the printer home screen. For more information, see “Using MyShortcut” on page 24.
Scan to E-mail	Scan a document, and then send it to an e-mail address. For more information, see “E-mailing” on page 100.
Scan to Computer	Scan a document, and then save it to a predefined folder on a host computer. For more information, see “Setting up Scan to Computer” on page 133.
Scan to FTP	Scan documents directly to a File Transfer Protocol (FTP) server. For more information, see “Scanning to an FTP address” on page 130.
Scan to Network	Scan a document, and then send it to a network shared folder. For more information, see “Setting up Scan to Network” on page 25.

Activating the home screen applications

Finding information about the home screen applications

Your printer comes with preinstalled home screen applications. Before you can use these applications, you must first activate and set up these applications using the Embedded Web Server. For more information on accessing the Embedded Web Server, see “Accessing the Embedded Web Server” on page 21.

For more information on configuring and using the home screen applications, do the following:

- 1 Go to <http://support.lexmark.com>.
- 2 Click **Software Solutions**, and then select either of the following:
 - **Scan to Network**—This lets you find information about the Scan to Network application.
 - **Other Applications**—This lets you find information about the other applications.
- 3 Click the **Manuals** tab, and then select the document for the home screen application.

Setting up Forms and Favorites

Note: A later version of this *User's Guide* may contain a direct link to the *Administrator's Guide* of this application. To check for updates of this *User's Guide*, go to <http://support.lexmark.com>.

Use	To
	<p>Streamline work processes by letting you quickly find and print frequently used online forms directly from the printer home screen.</p> <p>Note: The printer must have permission to access the network folder, FTP site, or Web site where the bookmark is stored. From the computer where the bookmark is stored, use sharing, security, and firewall settings to allow the printer at least a <i>read</i> access. For help, see the documentation that came with your operating system.</p>

1 Open a Web browser, and then type the printer IP address in the address field.

Note: View the printer IP address on the printer home screen. The IP address appears as four sets of numbers separated by periods, such as 123.123.123.123.

2 Click **Settings > Apps > Apps Management > Forms and Favorites**.

3 Click **Add**, and then customize the settings.

Notes:

- See the mouse-over help beside each field for a description of the setting.
- To make sure the location settings of the bookmark are correct, type the correct IP address of the host computer where the bookmark is located. For more information on obtaining the IP address of the host computer, see “Finding the IP address of the computer” on page 20.
- Make sure the printer has access rights to the folder where the bookmark is located.

4 Click **Apply**.

To use the application, touch **Forms and Favorites** on the printer home screen, and then navigate through form categories, or search for forms based on a form number, name, or description.

Setting up Card Copy

Note: A later version of this *User's Guide* may contain a direct link to the *Administrator's Guide* of this application. To check for updates of this *User's Guide*, go to <http://support.lexmark.com>.

Use	To
	<p>Quickly and easily copy insurance, identification, and other wallet-size cards.</p> <p>You can scan and print both sides of a card on a single page, saving paper and showing the information on the card in a more convenient manner.</p>

1 Open a Web browser, and then type the printer IP address in the address field.

Note: View the printer IP address on the printer home screen. The IP address appears as four sets of numbers separated by periods, such as 123.123.123.123.

2 Click **Settings > Apps > Apps Management > Card Copy**.

3 Change the default scanning options, if necessary.

- **Default tray**—Select the default tray to be used for printing scan images.
- **Default number of copies**—Specify the number of copies that should automatically print when the application is used.
- **Default contrast setting**—Specify a setting to increase or decrease the level of contrast when a copy of the scanned card is printed. Select **Best for Content** if you want the printer to adjust the contrast automatically.
- **Default scale setting**—Set the size of the scanned card when printed. The default setting is 100% (full size).
- **Resolution setting**—Adjust the quality of the scanned card.

Notes:

- When scanning a card, make sure the scan resolution is not more than 200 dpi for color, and 400 dpi for black and white.
- When scanning multiple cards, make sure the scan resolution is not more than 150 dpi for color, and 300 dpi for black and white.
- **Print Borders**—Select the check box to print the scan image with a border around it.

4 Click **Apply**.

To use the application, touch **Card Copy** on the printer home screen, and then follow the instructions.

Using MyShortcut

Note: A later version of this *User's Guide* may contain a direct link to the *Administrator's Guide* of this application. To check for updates of this *User's Guide*, go to <http://support.lexmark.com>.

Use	To
	Create shortcuts on the printer home screen, with settings for up to 25 frequently used copy, fax, or e-mail jobs.

To use the application, touch **MyShortcut**, and then follow the instructions on the printer display.

Setting up Multi Send

Note: A later version of this *User's Guide* may contain a direct link to the *Administrator's Guide* of this application. To check for updates of this *User's Guide*, go to <http://support.lexmark.com>.

Use	To
	Scan a document, and then send the scanned document to multiple destinations. Note: Make sure there is enough space in the printer hard disk.

1 Open a Web browser, and then type the printer IP address in the address field.

Note: View the printer IP address on the printer home screen. The printer IP address appears as four sets of numbers separated by periods, such as 123.123.123.123.

2 Click **Settings > Apps > Apps Management > Multi Send**.

3 From the Profiles section, click **Add**, and then customize the settings.

Notes:

- See the mouse-over help beside each field for a description of the setting.
- If you select **FTP** or **Share Folder** as a destination, then make sure the location settings of the destination are correct. Type the correct IP address of the host computer where the specified destination is located. For more information on obtaining the IP address of the host computer, see “Finding the IP address of the computer” on page 20.

4 Click **Apply**.

To use the application, touch **Multi Send** on the printer home screen, and then follow the instructions on the printer display.

Setting up Scan to Network

Note: A later version of this *User's Guide* may contain a direct link to the *Administrator's Guide* of this application. To check for updates of this *User's Guide*, go to <http://support.lexmark.com>.

Use	To
	<p>Scan a document and send it to a shared network folder. You can define up to 30 unique folder destinations.</p> <p>Notes:</p> <ul style="list-style-type: none"> • The printer must have permission to write to the destinations. From the computer where the destination is specified, use sharing, security, and firewall settings to allow the printer at least a <i>write</i> access. For help, see the documentation that came with your operating system. • The Scan to Network icon appears only when one or more destinations are defined.

1 Open a Web browser, and then type the printer IP address in the address field.

Note: View the printer IP address on the printer home screen. The IP address appears as four sets of numbers separated by periods, such as 123.123.123.123.

2 Do either of the following:

- Click **Set up Scan to Network > Click here**.
- Click **Settings > Apps > Apps Management > Scan to Network**.

3 Specify the destinations, and then customize the settings.

Notes:

- See the mouse-over help beside some of the fields for a description of the setting.
- To make sure the location settings of the destination are correct, type the correct IP address of the host computer where the specified destination is located. For more information on obtaining the IP address of the host computer, see “Finding the IP address of the computer” on page 20.

- Make sure the printer has access rights to the folder where the specified destination is located.

4 Click **Apply**.

To use the application, touch **Scan to Network** on the printer home screen, and then follow the instructions on the printer display.

Setting up Remote Operator Panel

This application enables you to interact with the printer control panel even when you are not physically near the network printer. From your computer, you can view the printer status, release held print jobs, create bookmarks, and do other print-related tasks.

1 Open a Web browser, and then type the printer IP address in the address field.

Note: View the printer IP address on the printer home screen. The IP address appears as four sets of numbers separated by periods, such as 123.123.123.123.

2 Click **Settings > Remote Operator Panel Settings**.

3 Select the **Enable** check box, and then customize the settings.

4 Click **Submit**.

To use the application, click **Remote Operator Panel > Launch VNC Applet**.

Exporting and importing a configuration

You can export configuration settings into a text file, and then import the file to apply the settings to other printers.

1 Open a Web browser, and then type the printer IP address in the address field.

Note: View the printer IP address on the printer home screen. The IP address appears as four sets of numbers separated by periods, such as 123.123.123.123.

2 To export or import a configuration for one application, do the following:

a Click **Settings > Apps > Apps Management**.

b From the list of installed applications, click the name of the application you want to configure.

c Click **Configure**, and then do either of the following:

- To export a configuration to a file, click **Export**, and then follow the instructions on the computer screen to save the configuration file.

Notes:

- When saving the configuration file, you can type a unique file name or use the default name.
- If a "JVM Out of Memory" error occurs, then repeat the export process until the configuration file is saved.

- To import a configuration from a file, click **Import**, and then browse to the saved configuration file that was exported from a previously configured printer.

Notes:

- Before importing the configuration file, you can choose to preview it first or load it directly.
- If a timeout occurs and a blank screen appears, then refresh the Web browser, and then click **Apply**.

3 To export or import a configuration for multiple applications, do the following:

a Click **Settings > Import/Export**.

b Do either of the following:

- To export a configuration file, click **Export Embedded Solutions Settings File**, and then follow the instructions on the computer screen to save the configuration file.
- To import a configuration file, do the following:
 - 1** Click **Import Embedded Solutions Settings File > Choose File**, and then browse to the saved configuration file that was exported from a previously configured printer.
 - 2** Click **Submit**.

Additional printer setup

Installing internal options

 **CAUTION—SHOCK HAZARD:** If you are accessing the controller board or installing optional hardware or memory devices sometime after setting up the printer, then turn the printer off, and unplug the power cord from the electrical outlet before continuing. If you have any other devices attached to the printer, then turn them off as well, and unplug any cables going into the printer.

Available internal options

- Memory card
 - DDR3 DIMM
 - Flash memory
 - Fonts
 - Firmware
 - Forms Barcode
 - Prescribe
 - IPDS
 - Printcryption
- Printer hard disk
- Lexmark™ Internal Solutions Ports (ISP)
 - Parallel 1284-B interface
 - MarkNet N8130 10/100 fiber interface
 - MarkNet N8350 802.11 b/g/n Wireless Print Server
 - RS-232-C serial interface

Accessing the controller board

⚠ CAUTION—SHOCK HAZARD: If you are accessing the controller board or installing optional hardware or memory devices sometime after setting up the printer, then turn the printer off, and unplug the power cord from the electrical outlet before continuing. If you have any other devices attached to the printer, then turn them off as well, and unplug any cables going into the printer.

- 1 Open the controller board access door.



- 2 Open the controller board shield using the green handle.

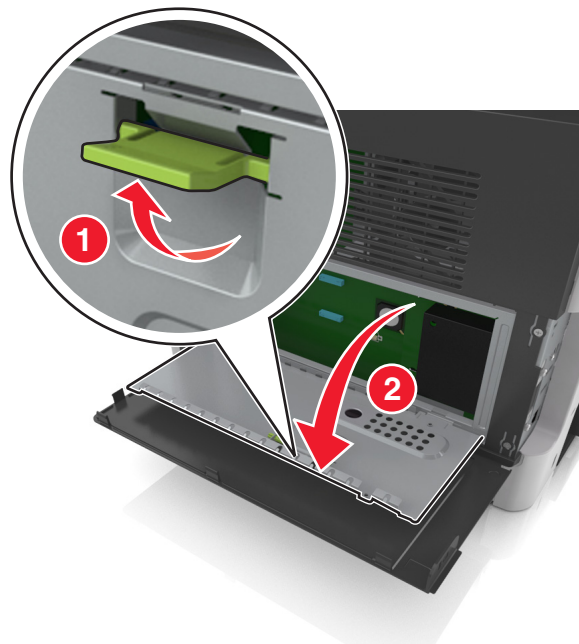

- 3 Use the following illustration to locate the appropriate connector.

Warning—Potential Damage: Controller board electronic components are easily damaged by static electricity. Touch something metal on the printer before touching any controller board electronic components or connectors.

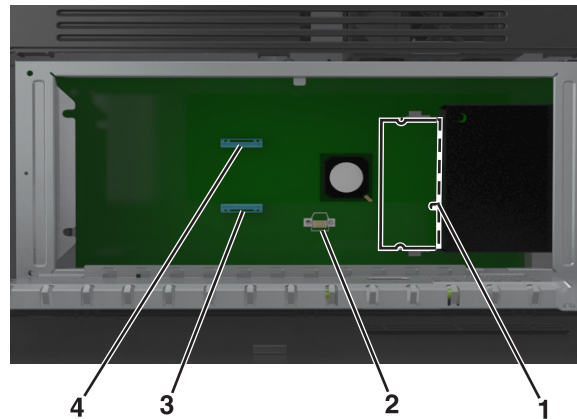

1	Memory card connector
2	Option card connector
3	Printer hard disk connector
4	Lexmark Internal Solutions Port connector

4 Close the shield, and then the access door.

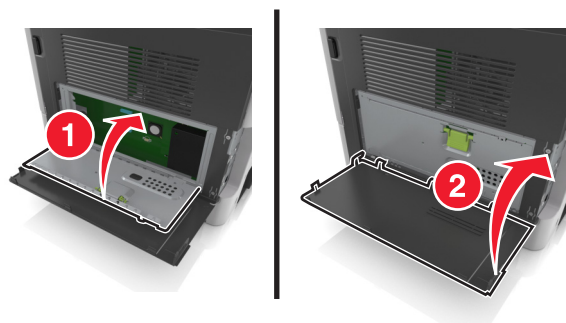

Installing a memory card

CAUTION—SHOCK HAZARD: If you are accessing the controller board or installing optional hardware or memory devices sometime after setting up the printer, then turn the printer off, and unplug the power cord from the electrical outlet before continuing. If you have any other devices attached to the printer, then turn them off as well, and unplug any cables going into the printer.

Warning—Potential Damage: Controller board electronic components are easily damaged by static electricity. Touch something metal on the printer before touching any controller board electronic components or connectors.

Note: An optional memory card can be purchased separately and attached to the controller board.

1 Access the controller board.

For more information, see “Accessing the controller board” on page 29.

2 Unpack the memory card.

Warning—Potential Damage: Do not touch the connection points along the edge of the card. Doing so may cause damage.

- 3 Align the notch (1) on the memory card with the ridge (2) on the connector.

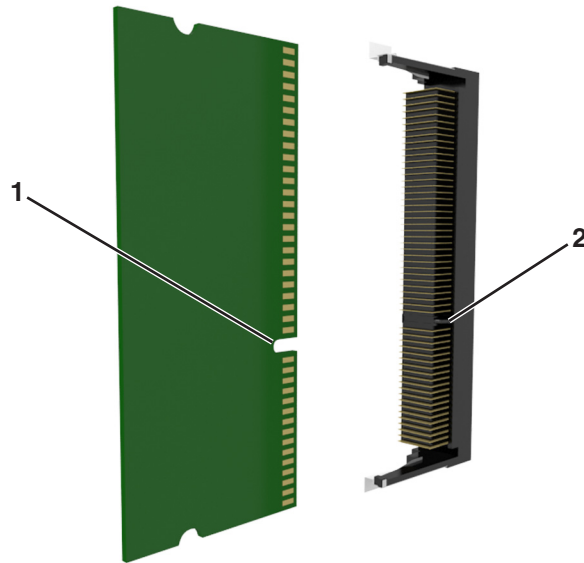

- 4 Push the memory card straight into the connector, and then push the card toward the controller board wall until it *clicks* into place.

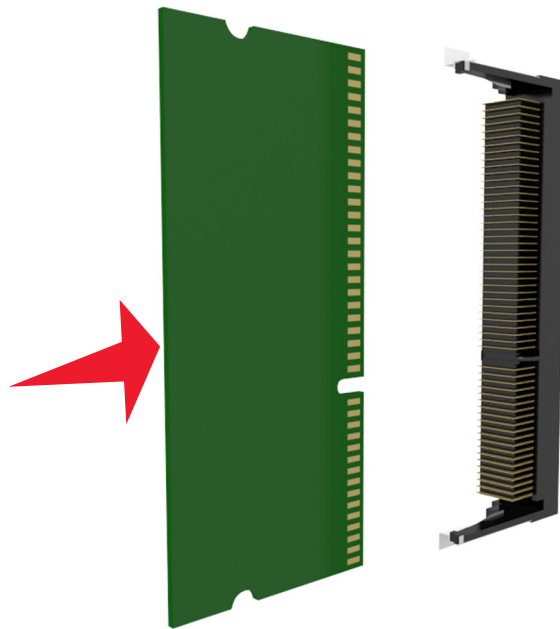

- 5 Close the controller board shield, and then the controller board access door.

Note: When the printer software and any hardware options are installed, you may need to manually add the options in the printer driver to make them available for print jobs. For more information, see “Updating available options in the printer driver” on page 49.

Installing an optional card

⚠ CAUTION—SHOCK HAZARD: If you are accessing the controller board or installing optional hardware or memory devices sometime after setting up the printer, then turn the printer off, and unplug the power cord from the electrical outlet before continuing. If you have other devices attached to the printer, then turn them off as well, and unplug any cables going into the printer.

Warning—Potential Damage: Controller board electronic components are easily damaged by static electricity. Touch something metal on the printer before touching any controller board electronic components or connectors.

1 Access the controller board.

For more information, see “Accessing the controller board” on page 29.

2 Unpack the optional card.

Warning—Potential Damage: Avoid touching the connection points along the edge of the card.

3 Holding the card by its sides, align the plastic pins (1) on the card with the holes (2) on the controller board.

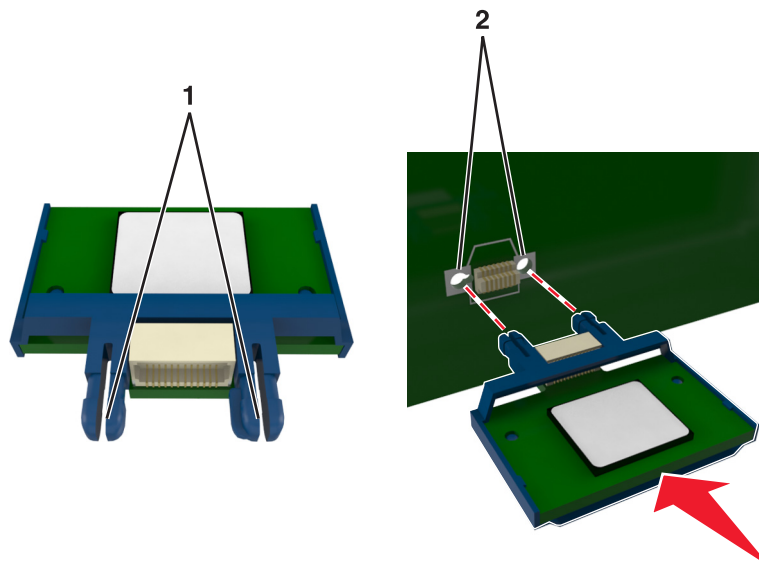

- 4 Push the card firmly into place as shown in the illustration.

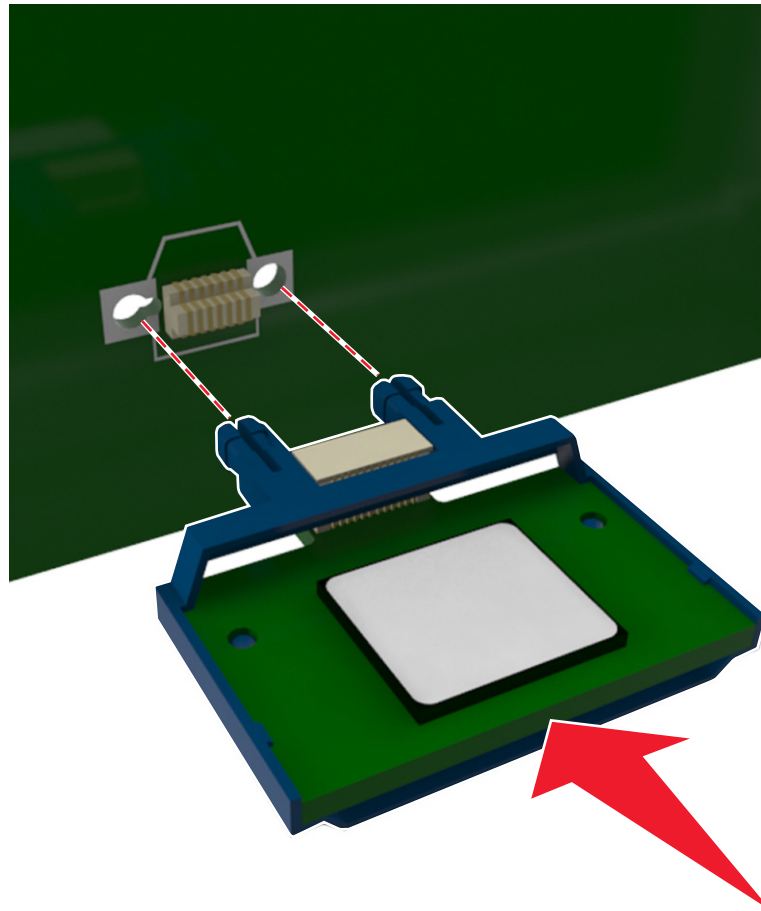

Warning—Potential Damage: Improper installation of the card may cause damage to the card and the controller board.

Note: The entire length of the connector on the card must touch and be flushed against the controller board.

- 5 Close the controller board shield, and then the controller board access door.

Note: When the printer software and any hardware options are installed, it may be necessary to manually add the options in the printer driver to make them available for print jobs. For more information, see “Updating available options in the printer driver” on page 49.

Installing an Internal Solutions Port

The controller board supports one optional Lexmark Internal Solutions Port (ISP).

Note: This task requires a flat-head screwdriver.

⚠ CAUTION—SHOCK HAZARD: If you are accessing the controller board or installing optional hardware or memory devices sometime after setting up the printer, then turn the printer off, and unplug the power cord from the electrical outlet before continuing. If you have any other devices attached to the printer, then turn them off as well, and unplug any cables going into the printer.

Warning—Potential Damage: Controller board electronic components are easily damaged by static electricity. Touch a metal surface on the printer before touching any controller board electronic components or connectors.

- 1 Open the controller board access door.



- 2 Lightly press the stop on the left side of the access door, and then slide the access door to remove it.

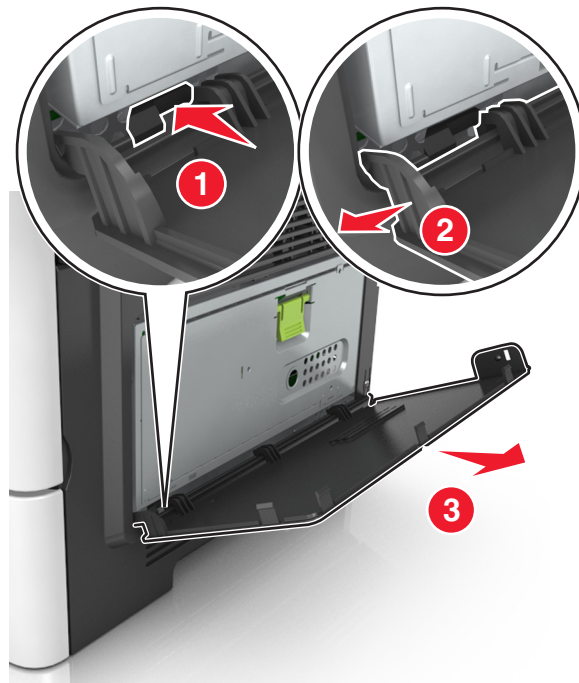

- 3 Unpack the ISP kit.

Note: Make sure to remove and discard the small cable attached to the white connector.

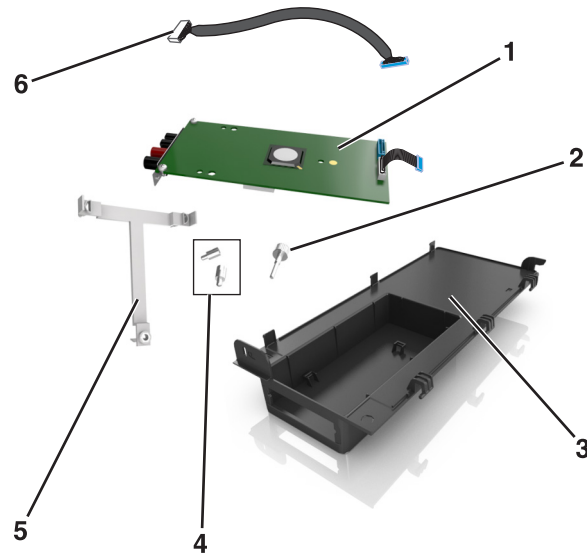

1	ISP solution
2	Screw to attach the ISP to the bracket
3	ISP exterior cover
4	Screws to attach the ISP metal bracket to the printer cage
5	Plastic bracket
6	Long ISP cable

4 Place the plastic bracket inside the ISP exterior cover until it *clicks* into place.

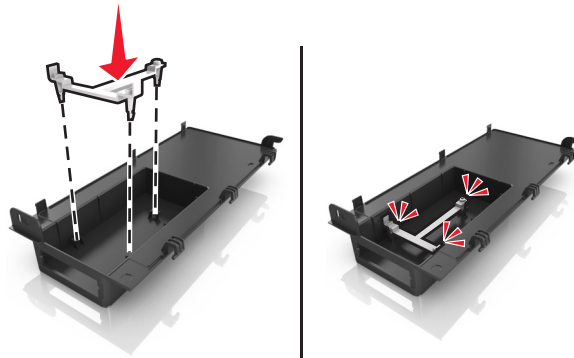

5 Slide and push the ISP solution into the plastic bracket.

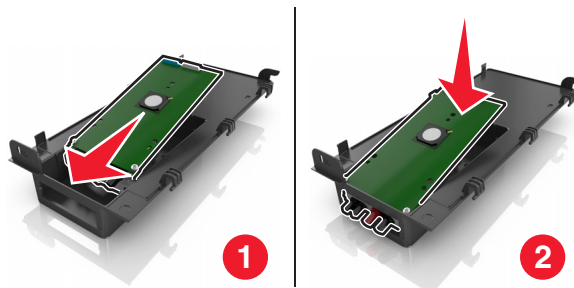

6 Secure the ISP solution to the plastic bracket using the long screw.

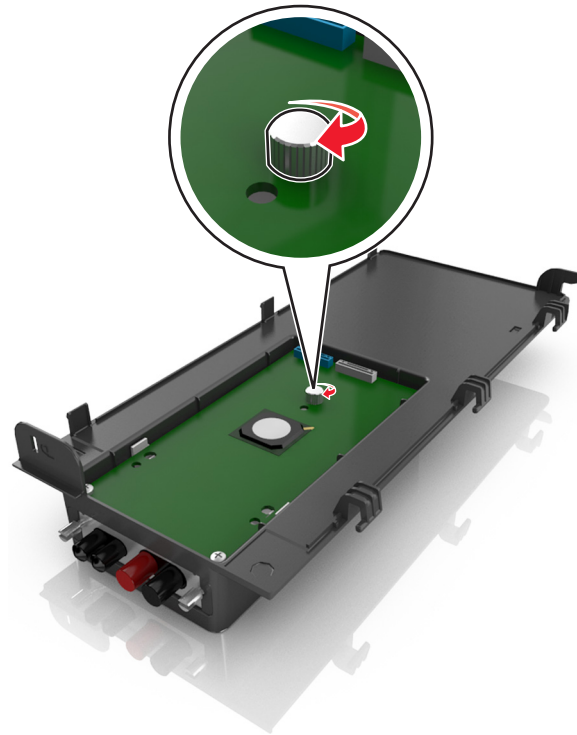

7 Tighten the two screws on the end of the ISP solution.

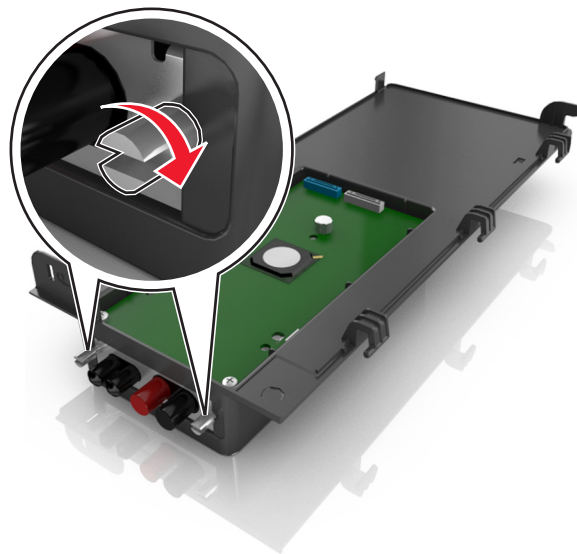

- 8 Attach the white plug of the ISP solution interface cable into the white receptacle on the ISP.

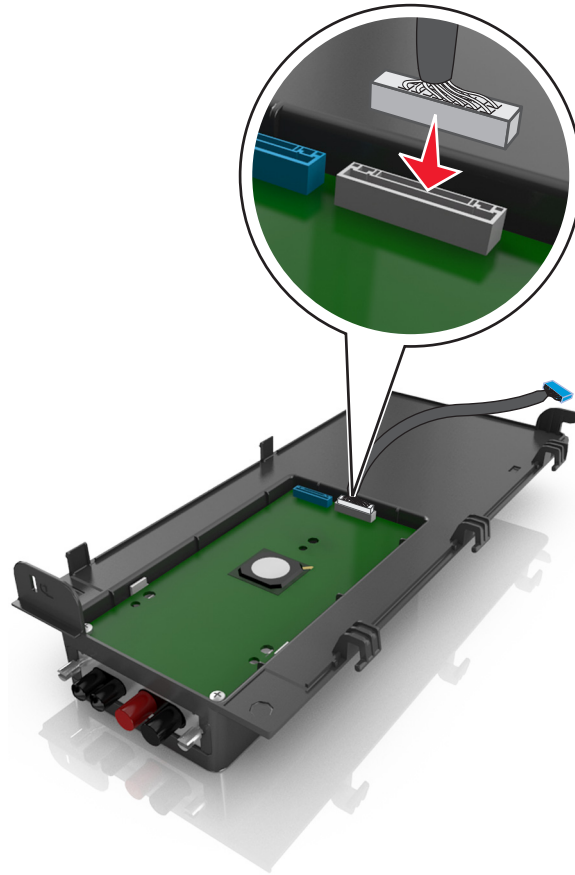

- 9 Attach the ISP exterior cover at an angle by inserting the left hinges first.

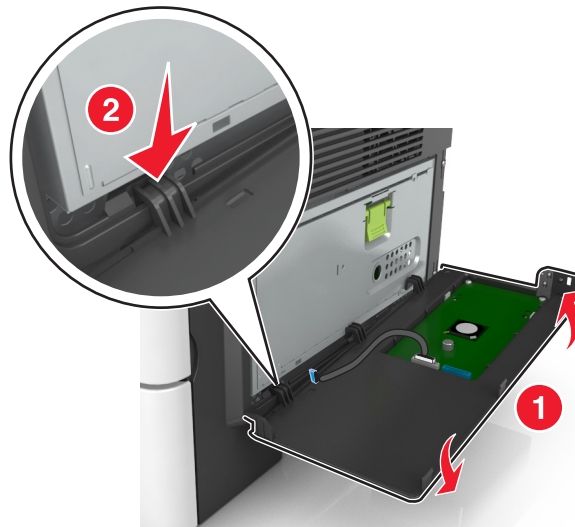

10 Lower the rest of the cover, and then slide the cover to the right.

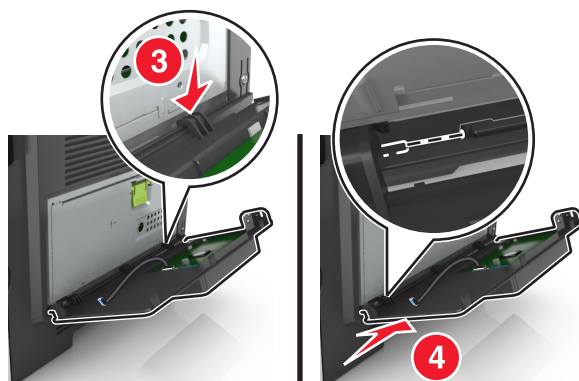

11 Run the ISP cable through the controller board shield.

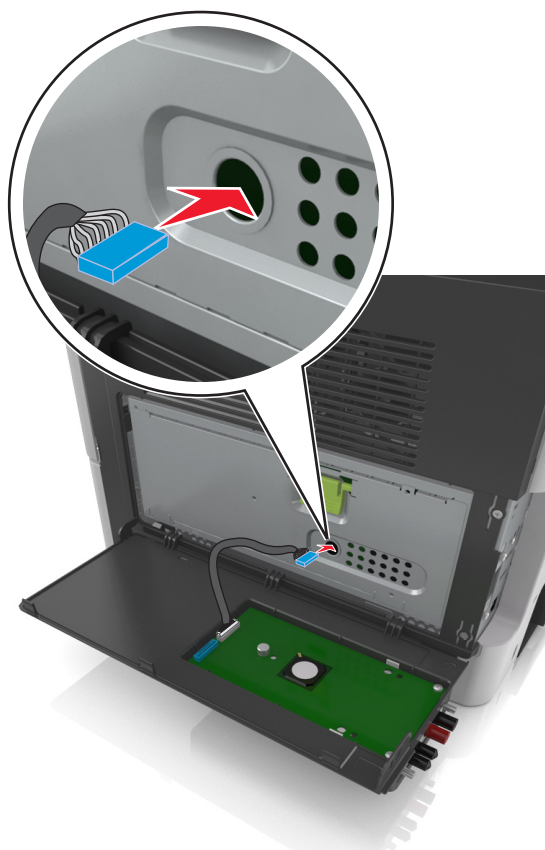

12 Open the shield using the green handle.

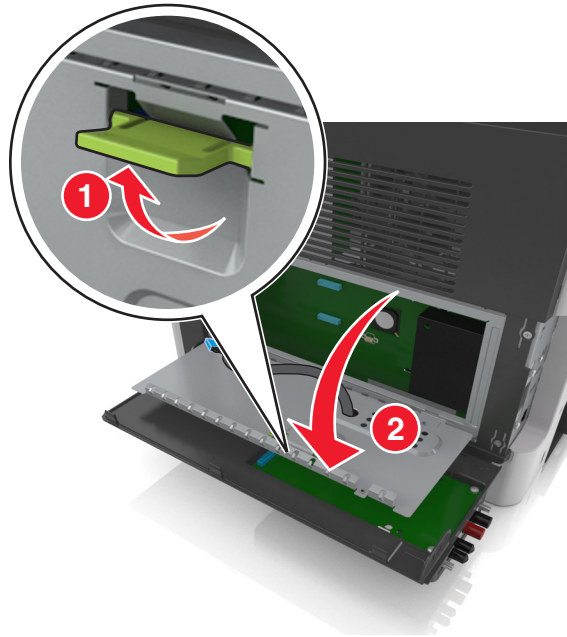

13 Attach the blue plug of the ISP solution interface cable into the blue receptacle on the controller board.

Note: If you have installed a printer hard disk, then you need to remove it. For more information, see “Removing a printer hard disk” on page 43. To reinstall the printer hard disk, see “Installing a printer hard disk” on page 40.

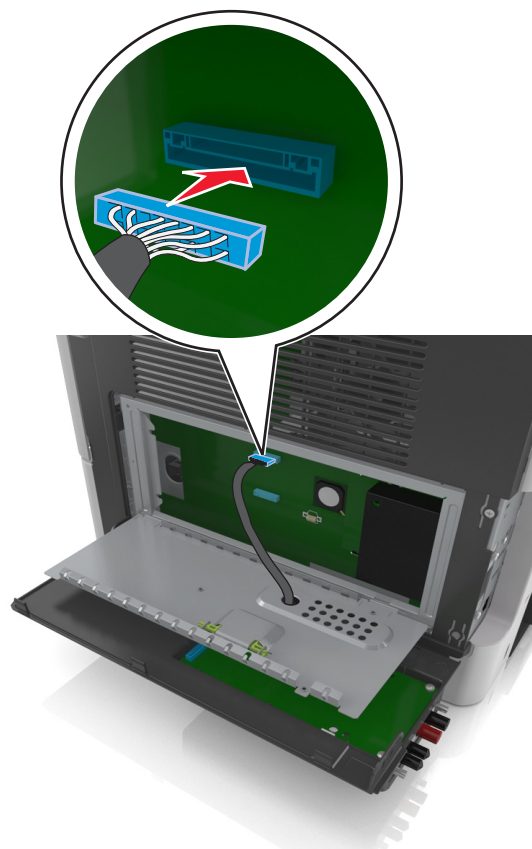

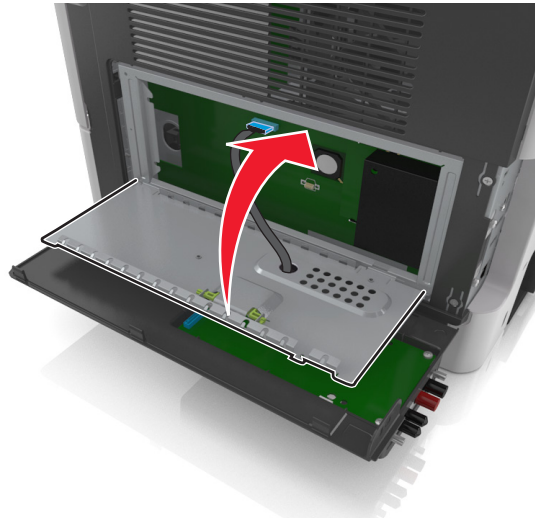
14 Close the shield.**15** Close the ISP exterior cover.

Note: When the printer software and any hardware options are installed, it may be necessary to manually add the options in the printer driver to make them available for print jobs. For more information, see “Updating available options in the printer driver” on page 49.

Installing a printer hard disk

CAUTION—SHOCK HAZARD: If you are accessing the controller board or installing optional hardware or memory devices sometime after setting up the printer, then turn the printer off, and unplug the power cord from the electrical outlet before continuing. If you have any other devices attached to the printer, then turn them off as well, and unplug any cables going into the printer.

Warning—Potential Damage: Controller board electronic components are easily damaged by static electricity. Touch a metal surface on the printer before touching any controller board electronic components or connectors.

- 1** Access the controller board.
For more information, see “Accessing the controller board” on page 29.
- 2** Unpack the printer hard disk.
- 3** Install the printer hard disk on the controller board.

Warning—Potential Damage: Hold only the edges of the printed circuit board assembly. Do not touch or press on the center of the printer hard disk. Doing so may cause damage.

- a Using a flat-head screwdriver, loosen the screws.

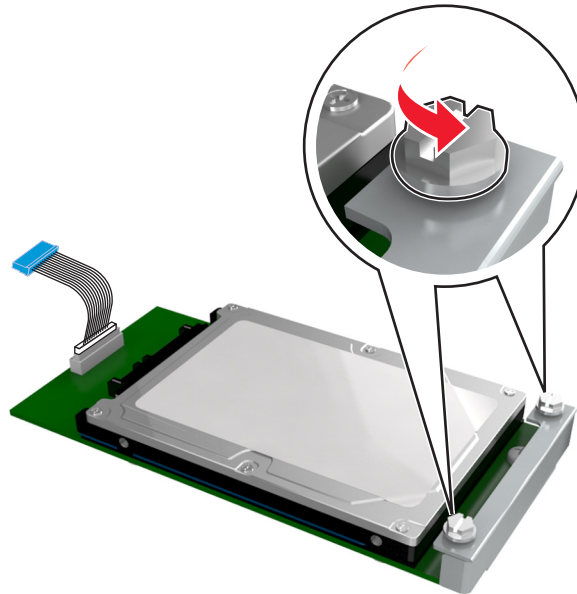

- b Insert the plug of the printer hard disk interface cable into the receptacle of the controller board.

Note: The plug and the receptacle are color-coded blue.

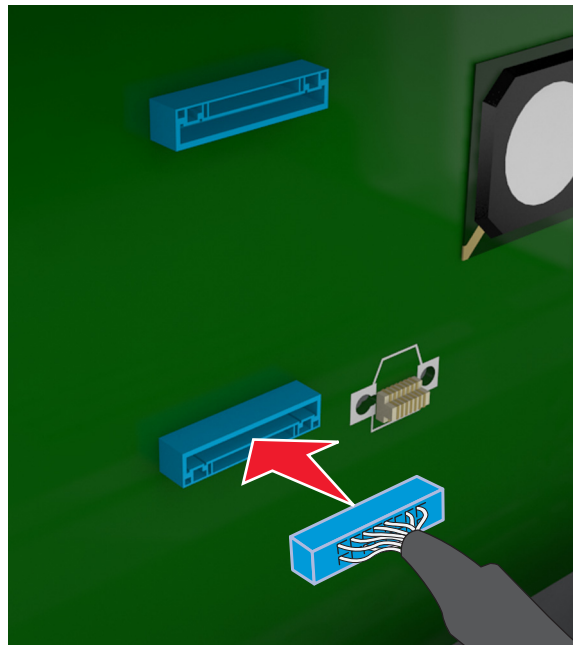

- c Align the screws on the printer hard disk to the slots on the controller board bracket, and then slide the printer hard disk onto the brackets.

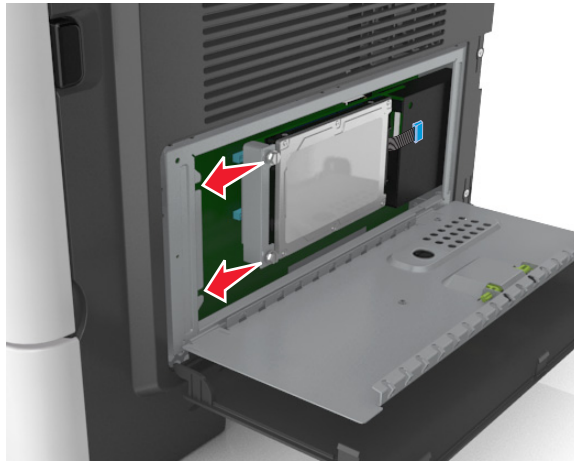

- d Tighten the two screws.

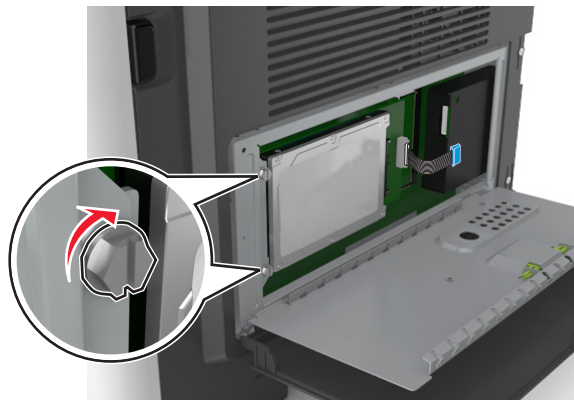

- 4 Close the controller board shield, and then close the controller board access door.

Note: When the printer software and any hardware options are installed, you may need to manually add the options in the printer driver to make them available for print jobs. For more information, see “Updating available options in the printer driver” on page 49.

Removing a printer hard disk

Warning—Potential Damage: Controller board electronic components are easily damaged by static electricity. Touch a metal surface on the printer before touching any controller board electronic components or connectors.

- 1 Access the controller board.

For more information, see “Accessing the controller board” on page 29.

Note: This task requires a flat-head screwdriver.

- 2 Loosen the screws that connect the printer hard disk to the controller board bracket.

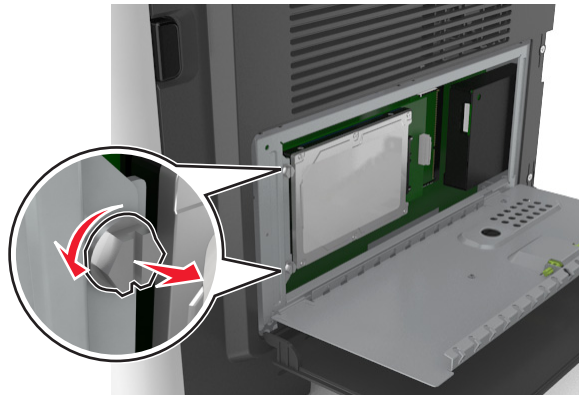

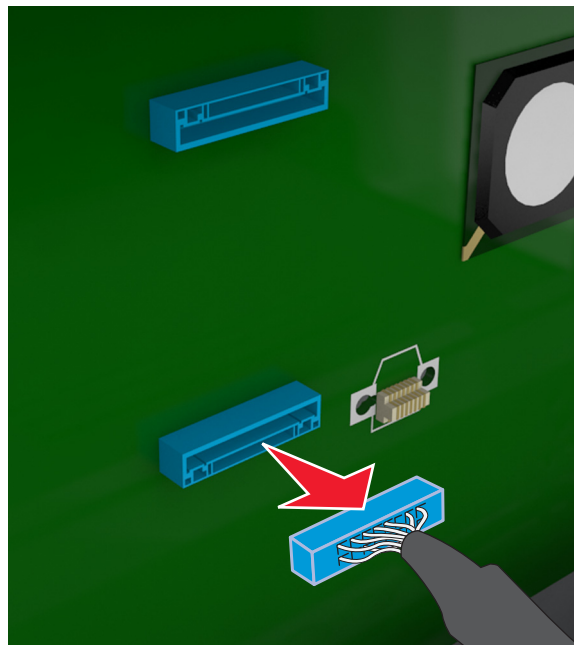

- 3 Unplug the printer hard disk interface cable from the receptacle in the controller board, leaving the cable attached to the printer hard disk. To unplug the cable, squeeze the paddle at the plug of the interface cable to disengage the latch before pulling the cable out.



- 4 Hold the printer hard disk by the edges, and then remove it from the printer.
- 5 Close the controller board shield, and then close the access door.

Installing hardware options

Order of installation



-  **CAUTION—POTENTIAL INJURY:** The printer weight is greater than 18 kg (40 lb) and requires two or more trained personnel to lift it safely.
-  **CAUTION—SHOCK HAZARD:** If you are accessing the controller board or installing optional hardware or memory devices sometime after setting up the printer, then turn the printer off, and unplug the power cord from the electrical outlet before continuing. If you have any other devices attached to the printer, then turn them off as well, and unplug any cables going into the printer.
-  **CAUTION—TIPPING HAZARD:** Floor-mounted configurations require additional furniture for stability. You must use either a printer stand or printer base if you are using multiple input options. If you purchased a multifunction printer (MFP) that scans, copies, and faxes, then you may need additional furniture. For more information, see www.lexmark.com/multifunctionprinters.

Install the printer and any hardware options you have purchased in the following order:

- Printer stand
- Optional 250- or 550-sheet tray
- Printer

For more information on installing a printer stand, optional 250- or 550-sheet tray, or spacer, see the setup sheet that came with the option.

Installing optional trays

-  **CAUTION—POTENTIAL INJURY:** The printer weight is greater than 18 kg (40 lb) and requires two or more trained personnel to lift it safely.
-  **CAUTION—SHOCK HAZARD:** If you are accessing the controller board or installing optional hardware or memory devices sometime after setting up the printer, then turn the printer off, and unplug the power cord from the electrical outlet before continuing. If you have any other devices attached to the printer, then turn them off as well, and unplug any cables going into the printer.
-  **CAUTION—TIPPING HAZARD:** Floor-mounted configurations require additional furniture for stability. You must use either a printer stand or printer base if you are using multiple input options. If you purchased a multifunction printer (MFP) that scans, copies, and faxes, then you may need additional furniture. For more information, see www.lexmark.com/multifunctionprinters.

- 1 Turn off the printer using the power switch, and then unplug the power cord from the electrical outlet.



- 2 Unpack the tray, and then remove all packing material.
- 3 Pull out the tray from the base.

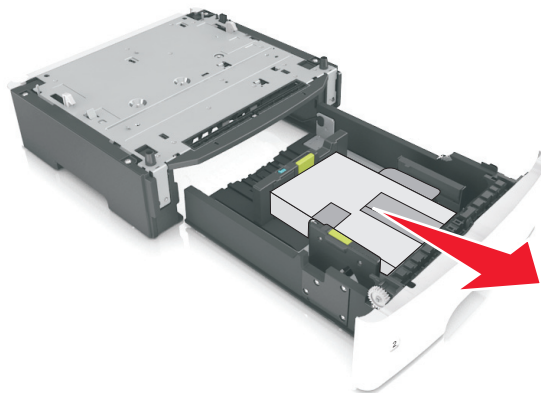

- 4 Remove any packing material from inside the tray.
- 5 Insert the tray into the base.
- 6 Place the tray near the printer.
- 7 Align the printer with the tray, and then slowly lower the printer into place.

Note: Optional trays lock together when stacked.

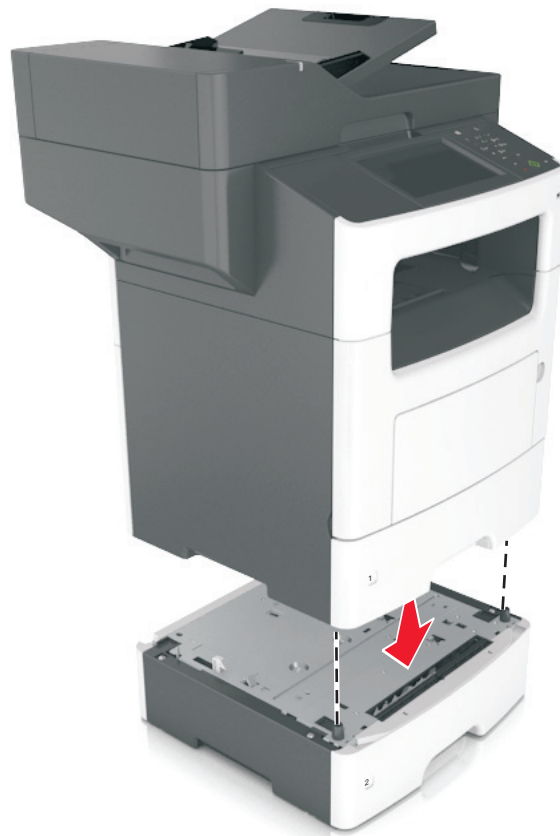

8 Connect the power cord to the printer, then to a properly grounded electrical outlet, and then turn on the printer.



Notes:

- When the printer software and any hardware options are installed, you may need to manually add the options in the printer driver to make them available for print jobs. For more information, see “Updating available options in the printer driver” on page 49.
- To uninstall the optional trays, slide the latch on the right side of the printer toward the front of the printer until it *clicks* into place, and then remove stacked trays one at a time from the top to the bottom.

Attaching cables

⚠ CAUTION—POTENTIAL INJURY: Do not use the fax feature during a lightning storm. Do not set up this product or make any electrical or cabling connections, such as the fax feature, power cord, or telephone, during a lightning storm.

Connect the printer to the computer using a USB cable or to the network using an Ethernet cable.

Make sure to match the following:

- The USB symbol on the cable with the USB symbol on the printer
- The appropriate Ethernet cable with the Ethernet port

Warning—Potential Damage: Do not touch the USB cable, any network adapter, or the printer in the area shown while actively printing or scanning. Loss of data or a malfunction can occur.

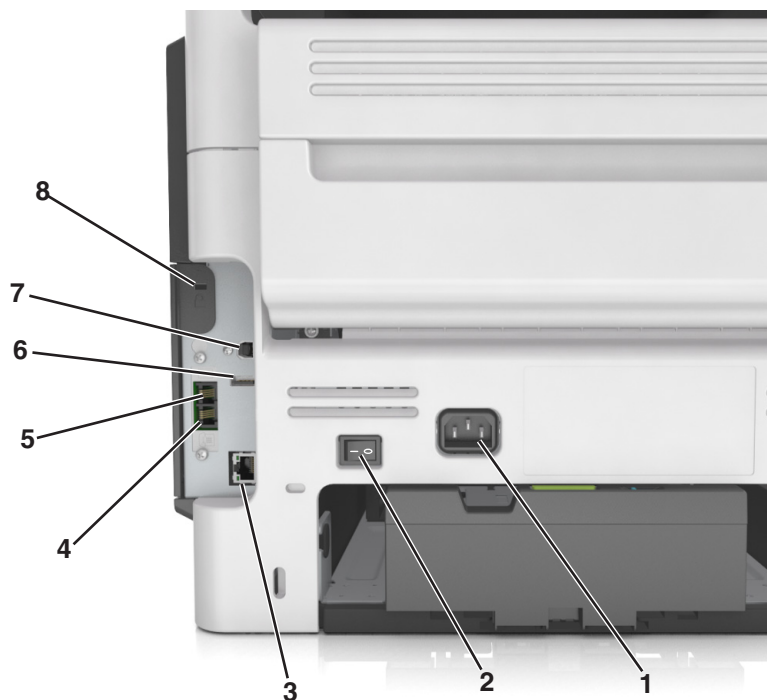

	Use the	To
1	Printer power cord socket	Connect the printer to a properly grounded electrical outlet.
2	Power switch	Turn the printer on or off.
3	Ethernet port	Connect the printer to an Ethernet network.
4	EXT port	Connect additional devices (telephone or answering machine) to the printer and the telephone line. Use this port if you do not have a dedicated fax line for the printer and if this connection method is supported in your country or region. Note: Remove the adapter plug to access the port.
5	LINE port	Connect the printer to an active telephone line through a standard wall jack (RJ-11), DSL filter, or VoIP adapter, or any other adapter that allows you to access the telephone line to send and receive faxes.
6	USB port	Attach a supported printer keyboard.

	Use the	To
7	USB printer port	Connect the printer to a computer.
8	Security slot	Attach a lock that will secure the printer in place.

Setting up the printer software

Installing the printer software

Notes:

- If you installed the printer software on the computer before but need to reinstall the software, then uninstall the current software first.
- Close all open software programs before installing the printer software.

1 Obtain a copy of the software installer package.

- From the *Software and Documentation* CD that came with your printer.
- From our Web site:

Go to www.lexmark.com, and then navigate to:

SUPPORT & DOWNLOADS > select your printer > select your operating system > download your software installer package

2 Do either of the following:

- If you are using the *Software and Documentation* CD, then insert the CD and wait for the installation dialog to appear.

If the installation dialog does not appear, then do the following:

In Windows 8

From the Search charm, type **run**, and then navigate to:
Apps list > **Run** > type **D:\setup.exe** > **OK**.

In Windows 7 or earlier

- Click , or click **Start** and then click **Run**.
- In the Start Search or Run dialog, type **D:\setup.exe**.
- Press **Enter**, or click **OK**.

Note: **D** is the letter of your CD or DVD drive.

In Macintosh

Click the CD icon on the desktop.

- If you are using the downloaded software installer from the Web, then double-click the installer that you have saved in your computer. Wait for the Select Installation Type dialog to appear, and then click **Install**.

Note: If you are prompted to run your software installation package, then click **Run**.

3 Click **Install**, and then follow the instructions on the computer screen.

Updating available options in the printer driver

When any hardware options are installed, you may need to manually add the options in the printer driver to make them available for use.

For Windows users

- 1 Open the printers folder.

In Windows 8

From the Search charm, type **run**, and then navigate to:

Apps list > **Run** > type **control printers** > **OK**

In Windows 7 or earlier

- a Click  or click **Start**, and then click **Run**.
 - b In the Start Search or Run dialog, type **control printers**.
 - c Press **Enter**, or click **OK**.
- 2 Depending on your device, do either of the following:
 - Press and hold the printer you want to update.
 - Right-click the printer you want to update.
 - 3 From the menu that appears, do either of the following:
 - For Windows 7 or later, select **Printer properties**.
 - For earlier versions, select **Properties**.
 - 4 Click the **Configuration** tab.
 - 5 Do either of the following:
 - Click **Update Now - Ask Printer**.
 - Under Configuration Options, manually add any installed hardware options.
 - 6 Click **Apply**.

For Macintosh users

- 1 From the Apple menu, navigate to either of the following:
 - **System Preferences** > **Print & Scan** > select your printer > **Options & Supplies** > **Driver**
 - **System Preferences** > **Print & Fax** > select your printer > **Options & Supplies** > **Driver**
- 2 Add any installed hardware options, and then click **OK**.

Networking

Notes:

- Purchase a MarkNet™ N8350 wireless network adapter first before setting up the printer on a wireless network. For information on installing the wireless network adapter, see the instruction sheet that came with the adapter.
- A Service Set Identifier (SSID) is a name assigned to a wireless network. Wired Equivalent Privacy (WEP), Wi-Fi Protected Access (WPA), WPA2, and 802.1X-RADIUS are types of security used on a network.

Preparing to set up the printer on an Ethernet network

To configure your printer to connect to an Ethernet network, organize the following information before you begin:

Note: If your network automatically assigns IP addresses to computers and printers, continue on to installing the printer.

- A valid, unique IP address for the printer to use on the network
- The network gateway
- The network mask
- A nickname for the printer (optional)

Note: A printer nickname can make it easier for you to identify your printer on the network. You can choose to use the default printer nickname, or assign a name that is easier for you to remember.

You will need an Ethernet cable to connect the printer to the network and an available port where the printer can physically connect to the network. Use a new network cable when possible to avoid potential problems caused by a damaged cable.

Installing the printer on an Ethernet network

For Windows users

- 1 Obtain a copy of the software installer package.
 - From the *Software and Documentation* CD that came with your printer.
 - From our Web site:
Go to www.lexmark.com, and then navigate to:
SUPPORT & DOWNLOADS > select your printer > select your operating system > download your software installer package
- 2 Do either of the following:
 - If you are using the *Software and Documentation* CD, then insert the CD and wait for the installation dialog to appear.
If the installation dialog does not appear, then do the following:

In Windows 8

From the Search charm, type **run**, and then navigate to:
Apps list > **Run** > type **D:\setup.exe** > **OK**

In Windows 7 or earlier

- a Click , or click **Start** and then click **Run**.
- b In the Start Search or Run dialog, type **D : \setup.exe**.
- c Press **Enter**, or click **OK**.

Note: D is the letter of your CD or DVD drive.

- If you are using the downloaded software installer from the Web, then double-click the installer that you have saved in your computer. Wait for the Select Installation Type dialog to appear, and then click **Install**.

Note: If you are prompted to run your software installation package, then click **Run**.

- 3 Click **Install**, and then follow the instructions on the computer screen.
- 4 Select **Ethernet connection**, and then click **Continue**.
- 5 Attach the Ethernet cable when instructed to do so.
- 6 Select the printer from the list, and then click **Continue**.
Note: If the configured printer does not appear in the list, then click **Modify Search**.
- 7 Follow the instructions on the computer screen.

For Macintosh users

- 1 Allow the network DHCP server to assign an IP address to the printer.
- 2 Obtain the printer IP address either:
 - From the printer control panel
 - From the TCP/IP section in the Network/Ports menu
 - By printing a network setup page or menu settings page, and then finding the TCP/IP section

Note: You will need the IP address if you are configuring access for computers on a different subnet than the printer.

- 3 Install the printer driver on the computer.
 - a Insert the *Software and Documentation* CD, and then double-click the installer package for the printer.
 - b Follow the instructions on the computer screen.
 - c Select a destination, and then click **Continue**.
 - d From the Easy Install screen, click **Install**.
 - e Type the user password, and then click **OK**.
All the necessary applications are installed on the computer.
 - f Click **Close** when installation is complete.
- 4 Add the printer.
 - For IP printing:
 - a From the Apple menu, navigate to either of the following:
 - **System Preferences > Print & Scan**
 - **System Preferences > Print & Fax**
 - b Click **+**.
 - c If necessary, click **Add Printer or Scanner** or **Add Other Printer or Scanner**.

- d Click the **IP** tab.
- e Type the printer IP address in the address field, and then click **Add**.
- For AppleTalk printing:

Notes:

- Make sure AppleTalk is activated on your printer.
- This feature is supported only in Mac OS X version 10.5.

- a From the Apple menu, navigate to:

System Preferences > Print & Fax

- b Click **+**, and then navigate to:

AppleTalk > select your printer > Add

Preparing to set up the printer on a wireless network

Notes:

- Make sure your wireless network adapter is installed in your printer and working properly. For more information, see the instruction sheet that came with the wireless network adapter.
- Make sure your access point (wireless router) is turned on and is working properly.

Make sure you have the following information before setting up the printer on a wireless network:

- **SSID**—The SSID is also referred to as the network name.
- **Wireless Mode (or Network Mode)**—The mode is either infrastructure or ad hoc.
- **Channel (for ad hoc networks)**—The channel defaults to automatic for infrastructure networks.

Some ad hoc networks will also require the automatic setting. Check with your system support person if you are not sure which channel to select.

- **Security Method**—There are four basic options for Security Method:

- WEP key

If your network uses more than one WEP key, then enter up to four in the provided spaces. Select the key currently in use on the network by selecting the default WEP transmit key.

- WPA or WPA2 preshared key or passphrase

WPA includes encryption as an additional layer of security. The choices are AES or TKIP. Encryption must be set for the same type on the router and on the printer, or the printer will not be able to communicate on the network.

- 802.1X–RADIUS

If you are installing the printer on an 802.1X network, then you may need the following:

- Authentication type
- Inner authentication type
- 802.1X user name and password
- Certificates

- No security

If your wireless network does not use any type of security, then you will not have any security information.

Note: We do not recommend using an unsecured wireless network.

Notes:

- If you do not know the SSID of the network that your computer is connected to, then launch the wireless utility of the computer network adapter, and then look for the network name. If you cannot find the SSID or the security information for your network, then see the documentation that came with the access point, or contact your system support person.
- To find the WPA/WPA2 preshared key or passphrase for the wireless network, see the documentation that came with the access point, see the Embedded Web Server associated with the access point, or consult your system support person.

Connecting the printer using the Wireless Setup Wizard

Before you begin, make sure that:

- A wireless network adapter is installed in the printer and is working properly. For more information, see the instruction sheet that came with the wireless network adapter.
- An Ethernet cable is disconnected from the printer.
- Active NIC is set to Auto. To set this to Auto, navigate to:

 > **Network/Ports** > **Active NIC** > **Auto** > **Submit**

Note: Make sure to turn off the printer, then wait for at least five seconds, and then turn the printer back on.

- 1 From the printer control panel, navigate to:

 > **Network/Ports** > **Network [x]** > **Network [x] Setup** > **Wireless** > **Wireless Connection Setup**

- 2 Select a wireless connection setup.

Use	To
Search for networks	Show available wireless connections. Note: This menu item shows all broadcast secured or unsecured SSIDs.
Enter a network name	Manually type the SSID. Note: Make sure to type the correct SSID.
Wi-Fi Protected Setup	Connect the printer to a wireless network using Wi-Fi Protected Setup.

- 3 Follow the instructions on the printer display.

Connecting the printer to a wireless network using Wi-Fi Protected Setup

Before you begin, make sure that:

- The access point (wireless router) is Wi-Fi Protected Setup (WPS) certified or WPS-compatible. For more information, see the documentation that came with your access point.
- A wireless network adapter installed in your printer is attached and working properly. For more information, see the instruction sheet that came with the wireless network adapter.

Using the Push Button Configuration method

- 1 From the printer control panel, navigate to:



> **Network/Ports** > **Network [x]** > **Network [x] Setup** > **Wireless** > **Wireless Connection Setup** > **Wi-Fi Protected Setup** > **Start Push Button Method**

- 2 Follow the instructions on the printer display.

Using the Personal Identification Number (PIN) method

- 1 From the printer control panel, navigate to:



> **Network/Ports** > **Network [x]** > **Network [x] Setup** > **Wireless** > **Wireless Connection Setup** > **Wi-Fi Protected Setup** > **Start PIN Method**

- 2 Copy the eight-digit WPS PIN.
- 3 Open a Web browser, and then type the IP address of your access point in the address field.

Notes:

- The IP address appears as four sets of numbers separated by periods, such as 123.123.123.123.
- If you are using a proxy server, then temporarily disable it to load the Web page correctly.

- 4 Access the WPS settings. For more information, see the documentation that came with your access point.
- 5 Enter the eight-digit PIN, and then save the setting.

Connecting the printer to a wireless network using the Embedded Web Server

Before you begin, make sure that:

- Your printer is connected temporarily to an Ethernet network.
- A wireless network adapter is installed in your printer and working properly. For more information, see the instruction sheet that came with the wireless network adapter.

- 1 Open a Web browser, and then type the printer IP address in the address field.

Notes:

- View the printer IP address on the printer control panel. The IP address appears as four sets of numbers separated by periods, such as 123.123.123.123.
- If you are using a proxy server, then temporarily disable it to load the Web page correctly.

- 2 Click **Settings** > **Network/Ports** > **Wireless**.
- 3 Modify the settings to match the settings of your access point (wireless router).
Note: Make sure to enter the correct SSID, security method, preshared key or passphrase, network mode, and channel.
- 4 Click **Submit**.
- 5 Turn off the printer, and then disconnect the Ethernet cable. Then wait for at least five seconds, and then turn the printer back on.
- 6 To verify if your printer is connected to the network, print a network setup page. Then in the Network Card [x] section, see if the status is Connected.

Changing port settings after installing a new network Internal Solutions Port

When a new Lexmark Internal Solutions Port (ISP) is installed in the printer, the printer configurations on computers that access the printer must be updated since the printer will be assigned a new IP address. All computers that access the printer must be updated with this new IP address.

Notes:

- If the printer has a static IP address, then you do not need to make any changes to the computer configurations.
- If the computers are configured to use the network name, instead of an IP address, then you do not need to make any changes to your computer configurations.
- If you are adding a wireless ISP to a printer previously configured for an Ethernet connection, then make sure the printer is disconnected from the Ethernet network when you configure the printer to operate wirelessly. If the printer is connected to the Ethernet network, then the wireless configuration completes, but the wireless ISP is inactive. To activate the wireless ISP, disconnect the printer from the Ethernet network, turn off the printer, and then turn it back on.
- Only one network connection is active at a time. To switch between Ethernet and wireless connection types, turn off the printer, connect the cable (to switch to an Ethernet connection) or disconnect the cable (to switch to a wireless connection), and then turn the printer back on.

For Windows users

- 1 Open a Web browser, and then type the printer IP address in the address field.

Notes:

- View the printer IP address on the printer control panel. The IP address appears as four sets of numbers separated by periods, such as 123.123.123.123.
- If you are using a proxy server, then temporarily disable it to load the Web page correctly.

- 2 Open the printers folder.

In Windows 8

From the Search charm, type **Run** and then navigate to:

Apps list > **Run** > type **control printers** > **OK**

In Windows 7 or earlier

a Click , or click **Start** and then click **Run**.

b In the Start Search or Run dialog, type **control printers**.

c Press **Enter**, or click **OK**.

- 3 To select the printer that has changed, do either of the following:

- Press and hold the printer, and then select **Printer properties**.
- Right-click the printer, and then select **Printer properties** (Windows 7 or later) or **Properties** (earlier versions).

Note: If there is more than one copy of the printer, then update all of them with the new IP address.

- 4 Click the **Ports** tab.

- 5 Select the port from the list, and then click **Configure Port**.

6 Type the new IP address in the “Printer Name or IP Address” field.

7 Click **OK > Close**.

For Macintosh users

1 Open a Web browser, and then type the printer IP address in the address field.

Notes:

- View the printer IP address on the printer control panel. The IP address appears as four sets of numbers separated by periods, such as 123.123.123.123.
- If you are using a proxy server, then temporarily disable it to load the Web page correctly.

2 Add the printer.

- For IP printing:
 - a From the Apple menu, navigate to either of the following:
 - **System Preferences > Print & Scan**
 - **System Preferences > Print & Fax**
 - b Click **+**.
 - c Click the **IP** tab.
 - d Type the printer IP address in the address field, and then click **Add**.

- For AppleTalk printing:

Notes:

- Make sure AppleTalk is activated on your printer.
- This feature is supported only in Mac OS X version 10.5.

- a From the Apple menu, navigate to:
System Preferences > Print & Fax
- b Click **+**, and then navigate to:
AppleTalk > select the printer > Add

Setting up serial printing

Use serial printing to print when the computer is far from the printer or to print at a reduced speed.

After installing the serial or communication (COM) port, configure the printer and the computer. Make sure you have connected the serial cable to the COM port on your printer.

1 Set the parameters in the printer.

- a From the printer control panel, navigate to the menu for the port settings.
- b Locate the menu for the serial port settings, and then adjust the settings, if necessary.
- c Save the modified settings, and then print a menu settings page.

2 Install the printer driver.**a** Obtain a copy of the software installer package.

- From the *Software and Documentation* CD that came with your printer
- From our Web site:
Go to www.lexmark.com, and then navigate to:
SUPPORT & DOWNLOADS > select your printer > select your operating system > download your software installer package

b Do either of the following:

- If you are using the *Software and Documentation* CD, then insert the CD and wait for the installation dialog to appear.
If the installation dialog does not appear, then do the following:

In Windows 8

From the Search charm type **run**, and then navigate to:
Apps list > **Run** > type **D:\setup.exe** > **OK**

In Windows 7 or earlier

- 1 Click , or click **Start** and then click **Run**.
- 2 In the Start Search or Run dialog, type **D:\setup.exe**.
- 3 Press **Enter** or click **OK**.

Note: D is the letter of your CD or DVD drive.

- If you are using the downloaded software installer from the Web, then double-click the installer that you have saved in your computer. Wait for the Select Installation Type dialog to appear, and then click **Install**.

Note: If you are prompted to run your software installer package, then click **Run**.

c Click **Install**.**d** Follow the instructions on the computer screen.**e** Select **Advanced**, and then click **Continue**.**f** From the Configure Printer Connection dialog, select a port.**g** If the port is not in the list, then click **Refresh**, or navigate to:

Add port > select a port type > enter the necessary information > **OK**

h Click **Continue** > **Finish**.**3** Set the COM port parameters.

After installing the printer driver, set the serial parameters in the COM port assigned to the printer driver.

Note: Make sure the serial parameters in the COM port match the serial parameters you set in the printer.

a Open Device Manager.**In Windows 8**

From the Search charm, type **run** and then navigate to:
Apps list > **Run** > type **devmgmt.msc** > **OK**

In Windows 7 or earlier

- 1 Click , or click **Start** and then click **Run**.
 - 2 In the Start Search or Run dialog, type `devmgmt.msc`.
 - 3 Press **Enter** or click **OK**.
- b** Double-click **Ports (COM & LPT)** to expand the list of available ports.
- c** Do either of the following:
- Press and hold the COM port where you attached the serial cable to your computer (example: COM1).
 - Right-click the COM port where you attached the serial cable to your computer (example: COM1).
- d** From the menu that appears, select **Properties**.
- e** On the Port Settings tab, set the serial parameters to the same serial parameters set in the printer. Check the serial heading of the menu settings page for the printer settings.
- f** Click **OK**, and then close all the dialogs.
- g** Print a test page to verify printer installation.

Verifying printer setup

When all hardware and software options are installed and the printer is turned on, verify that the printer is set up correctly by printing the following:

- **Menu settings page**—Use this page to verify that all printer options are installed correctly. A list of installed options appears toward the bottom of the page. If an option you installed is not listed, then it is not installed correctly. Remove the option, and then install it again.
- **Network setup page**—If your printer has Ethernet or wireless capability and is attached to a network, then print a network setup page to verify the network connection. This page also provides important information that aids network printing configuration.

Printing a menu settings page

From the home screen, navigate to:



> **Reports > Menu Settings Page**

Printing a network setup page

If the printer is attached to a network, then print a network setup page to verify the network connection. This page also provides important information that aids network printing configuration.

- 1 From the home screen, navigate to:



> **Reports > Network Setup Page**

- 2 Check the first section of the network setup page, and confirm that the status is **Connected**.

If the status is **Not Connected**, then the LAN drop may not be active, or the network cable may be malfunctioning. Consult a system support person for a solution, and then print another network setup page.

Loading paper and specialty media

The selection and handling of paper and specialty media can affect how reliably documents print. For more information, see “Avoiding jams” on page 235 and “Storing paper” on page 77.

Setting the paper size and type

From the home screen, navigate to:



> **Paper Menu** > **Paper Size/Type** > select a tray > select the paper size or type > **Submit**

Notes:

- The Paper Size setting is automatically set according to the position of the paper guides in each tray except the standard 550-sheet tray (Tray 1) and the multipurpose feeder.
- The Paper Size setting for Tray 1 and the multipurpose feeder must be set manually in the Paper Size menu.
- The factory default Paper Type setting is Plain Paper.
- The Paper Type setting must be set manually for all trays.

Configuring Universal paper settings

The Universal paper size is a user-defined setting that lets you print on paper sizes that are not preset in the printer menus.

Notes:

- The smallest supported Universal size is 76.2 x 76.2 mm (3 x 3 inches).
- The largest supported Universal size is 215.9 x 359.92 mm (8.5 x 14.17 inches).

1 From the home screen, navigate to:



> **Paper Menu** > **Universal Setup** > **Units of Measure** > select the unit of measure > 

2 Touch **Portrait Width** or **Portrait Height**.

3 Select the width or height, and then touch .

Loading trays



CAUTION—POTENTIAL INJURY: To reduce the risk of equipment instability, load each tray separately. Keep all other trays closed until needed.

1 Pull out the tray completely.

Note: Do not remove trays while a job prints or while **Busy** appears on the printer display. Doing so may cause a jam.



2 Squeeze, and then slide the width guide tab to the correct position for the size of the paper you are loading.

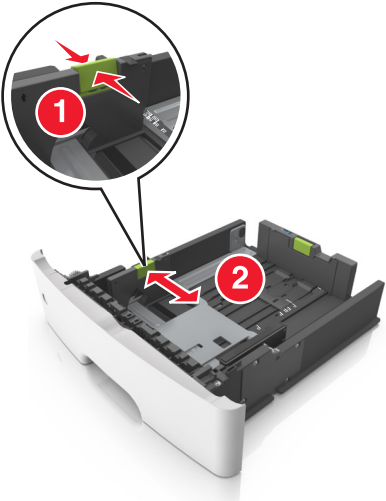

- 3 Squeeze, and then slide the length guide tab to the correct position for the size of the paper you are loading.

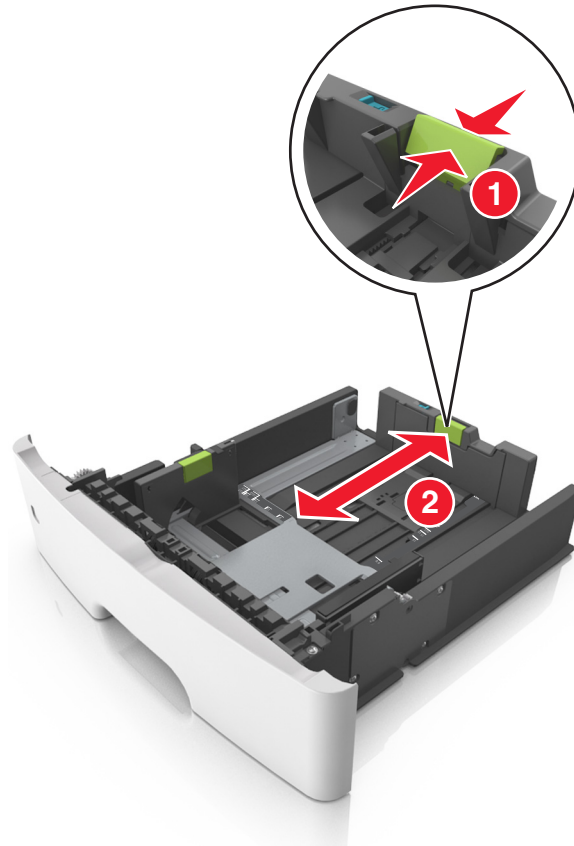

Notes:

- For some paper sizes like letter, legal, and A4, squeeze, and then slide the length guide tab backward to accommodate their length.
- When loading legal-size paper, the length guide extends beyond the base leaving the paper exposed to dust. To protect the paper from dust, you can purchase a dust cover separately. For more information, contact customer support.
- If you are loading A6-size paper in the standard tray, squeeze, and then slide the length guide tab toward the center of the tray to the A6-size position.
- Make sure the width and length guides are aligned with the paper size indicators on the bottom of the tray.

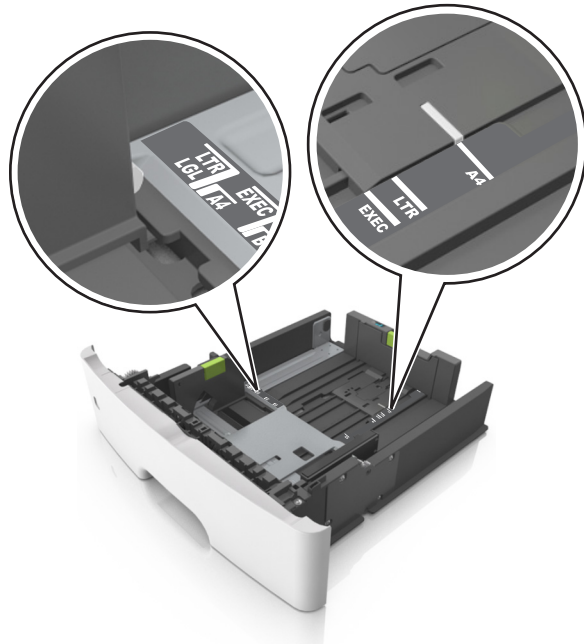

- 4 Flex the sheets back and forth to loosen them, and then fan them. Do not fold or crease the paper. Straighten the edges on a level surface.

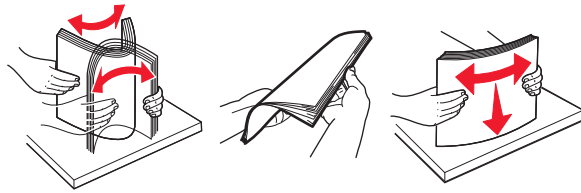

- 5 Load the paper stack with the printable side facedown.

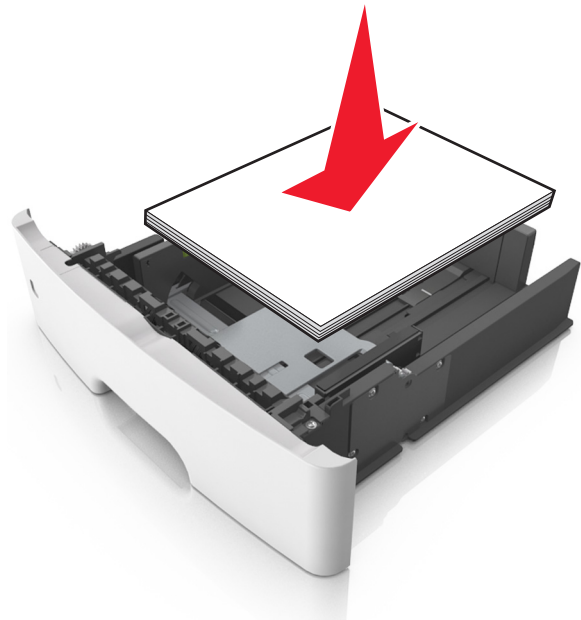

- There are different ways of loading letterhead depending on whether an optional staple finisher is installed or not, and whether two sided printing is needed.

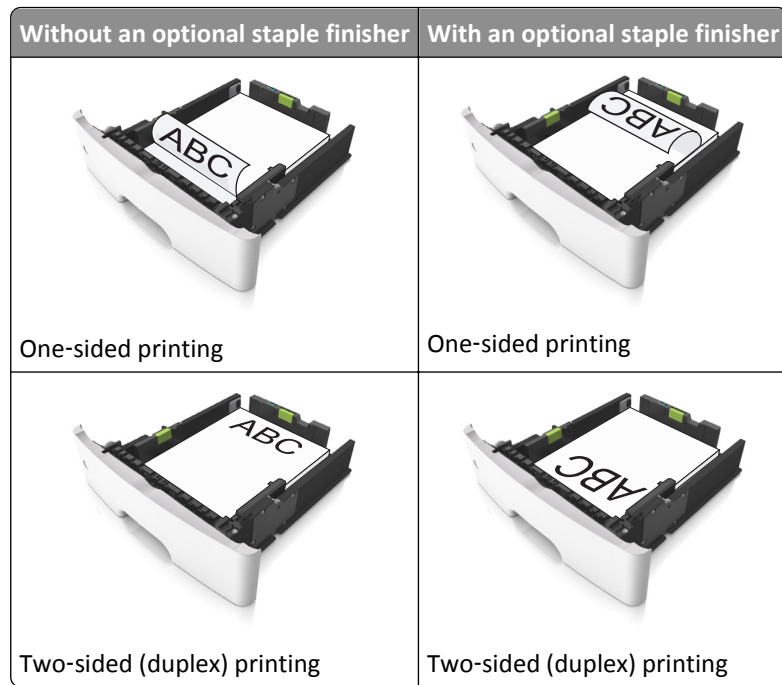

- Make sure the paper is below the maximum paper fill indicator located on the side of the width guide. Overfilling may cause paper jams.

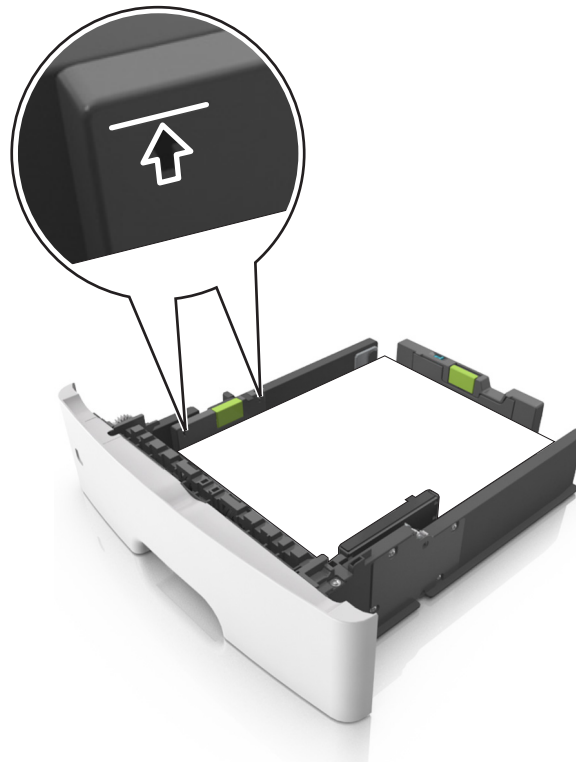

- 6 Insert the tray.



- 7 From the printer control panel, set the paper size and paper type in the Paper menu to match the paper loaded in the tray.

Note: Set the correct paper size and paper type to avoid paper jams and print quality problems.

Loading the multipurpose feeder

Use the multipurpose feeder when printing on different paper sizes and types or specialty media, such as card stock, transparencies, paper labels, and envelopes. You can also use it for single-page print jobs on letterhead.

- 1 Open the multipurpose feeder.



- a** Pull the multipurpose feeder extender.



- b** Pull the extender gently so that the multipurpose feeder is fully extended and open.

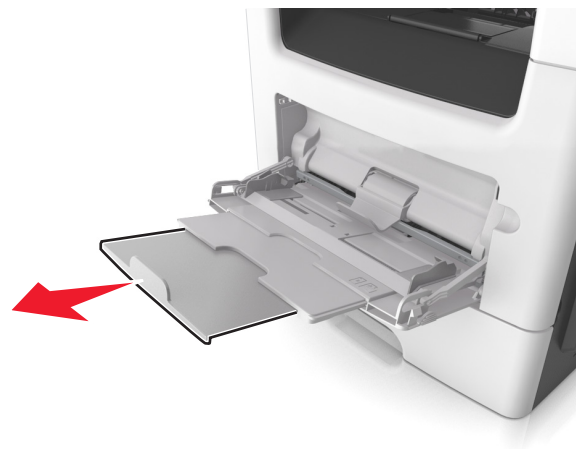

- 2 Squeeze the tab on the left width guide, and then move the guides for the paper you are loading.

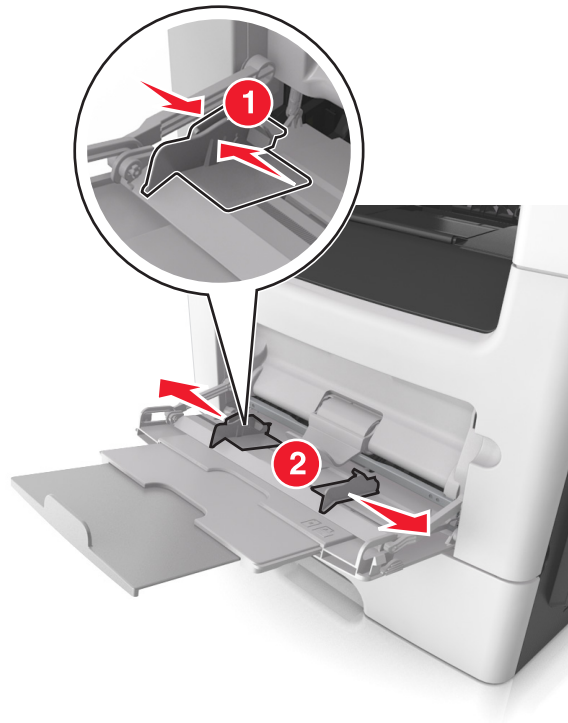

- 3 Prepare the paper or specialty media for loading.

- Flex sheets of paper back and forth to loosen them, and then fan them. Do not fold or crease the paper. Straighten the edges on a level surface.

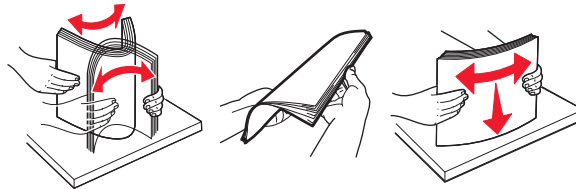

- Hold transparencies by the edges. Flex the stack of transparencies back and forth to loosen them, and then fan them. Straighten the edges on a level surface.

Note: Avoid touching the printable side of the transparencies. Be careful not to scratch them.

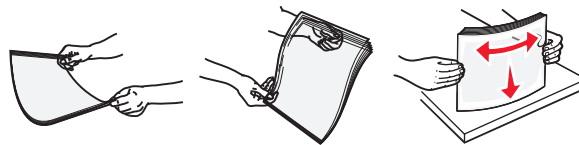

- Flex the stack of envelopes back and forth to loosen them, and then fan them. Straighten the edges on a level surface.



- 4 Load the paper or specialty media.

Notes:

- Do not force paper or specialty media into the multipurpose feeder.
- Make sure the paper or specialty media is below the maximum paper fill indicator located on the paper guides. Overfilling may cause paper jams.



- Load paper, transparencies, and card stock with the recommended printable side faceup and the top edge entering the printer first. For more information on loading transparencies, see the packaging that the transparencies came in.



Note: When loading A6-size paper, make sure the multipurpose feeder extender rests lightly against the edge of the paper so that the last few sheets of paper remain in place.

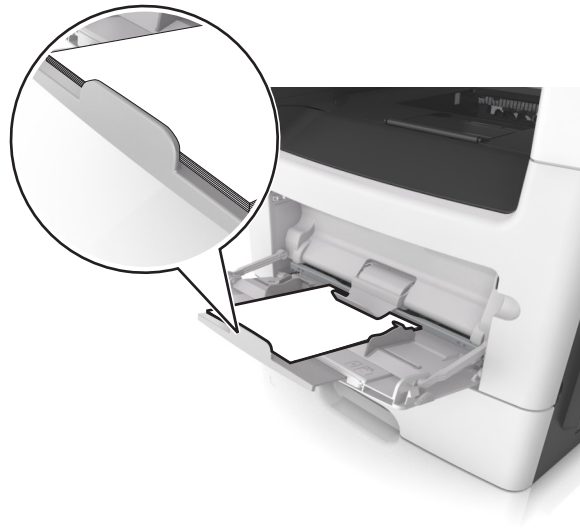

- Load letterhead faceup with the top edge entering the printer first. For two-sided (duplex) printing, load letterhead facedown with the bottom edge entering the printer first.



- Load envelopes with the flap on the left side facedown.



Warning—Potential Damage: Never use envelopes with stamps, clasps, snaps, windows, coated linings, or self-stick adhesives. These envelopes may severely damage the printer.

- 5 From the printer control panel, set the paper size and paper type in the Paper menu to match the paper or specialty media loaded in the multipurpose feeder.

Using the standard bin and paper stop

The standard bin holds up to 150 sheets of 20-lb paper. It collects prints facedown. The standard bin includes a paper stop that keeps paper from sliding out the front of the bin as it stacks.

To open the paper stop, pull it so that it flips forward.

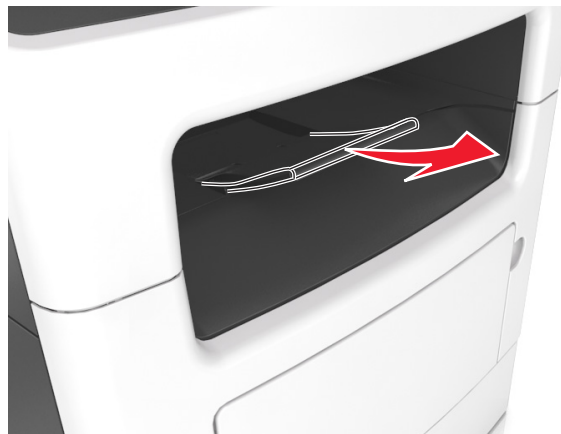

Note: Close the paper stop when moving the printer to another location.

Linking and unlinking trays

When the paper size and paper type for any trays are the same, the printer links those trays. When one linked tray becomes empty, paper feeds from the next linked tray. We recommend giving all unique paper, such as letterhead and different colored plain papers, a different custom type name so that the trays they are in do not automatically link.

Linking and unlinking trays

- 1 Open a Web browser, and then type the printer IP address in the address field.

Notes:

- View the printer IP address on the printer home screen. The IP address appears as four sets of numbers separated by periods, such as 123.123.123.123.
- If you are using a proxy server, then temporarily disable it to load the Web page correctly.

- 2 Click **Settings > Paper Menu**.

- 3 Change the paper size and type settings for the trays you are linking.

- To link trays, make sure the paper size and type for the tray match that of the other tray.
- To unlink trays, make sure the paper size or type for the tray does *not* match that of the other tray.

- 4 Click **Submit**.

Note: You can also change the paper size and type settings using the printer control panel. For more information, see “Setting the paper size and type” on page 59.

Warning—Potential Damage: Paper loaded in the tray should match the paper type name assigned in the printer. The temperature of the fuser varies according to the specified paper type. Printing issues may occur if settings are not properly configured.

Creating a custom name for a paper type

Using the Embedded Web Server

- 1 Open a Web browser, and then type the printer IP address in the address field.

Notes:

- View the printer IP address on the printer home screen. The IP address appears as four sets of numbers separated by periods, such as 123.123.123.123.
- If you are using a proxy server, then temporarily disable it to load the Web page correctly.

- 2 Click **Settings > Paper Menu > Custom Names**.

- 3 Select a custom name, and then type a custom paper type name.

- 4 Click **Submit**.

- 5 Click **Custom Types**, and then verify if the new custom paper type name has replaced the custom name.

Using the printer control panel

- 1 From the home screen, navigate to:



> **Paper Menu** > **Custom Names**

- 2 Select a custom name, and then type a custom paper type name.
- 3 Touch .
- 4 Touch **Custom Types**, and then verify that the new custom paper type name has replaced the custom name.

Assigning a custom paper type

Using the Embedded Web Server

Assign a custom paper type name to a tray when linking or unlinking trays.

- 1 Open a Web browser, and then type the printer IP address in the address field.

Notes:

- View the printer IP address on the printer home screen. The IP address appears as four sets of numbers separated by periods, such as 123.123.123.123.
- If you are using a proxy server, then temporarily disable it to load the Web page correctly.

- 2 Click **Settings** > **Paper Menu** > **Custom Types**.
- 3 Select a custom paper type name, and then select a paper type
Note: Paper is the factory default paper type for all user-defined custom names.
- 4 Click **Submit**.

Using the printer control panel

- 1 From the home screen, navigate to:



> **Paper Menu** > **Custom Types**

- 2 Select a custom paper type name, and then select a paper type
Note: Paper is the factory default paper type for all user-defined custom names.
- 3 Touch .

Configuring a custom name

Using the Embedded Web Server

- 1 Open a Web browser, and then type the printer IP address in the address field.

Notes:

- View the printer IP address on the printer home screen. The IP address appears as four sets of numbers separated by periods, such as 123.123.123.123.

- If you are using a proxy server, then temporarily disable it to load the Web page correctly.

2 Click **Settings > Paper Menu > Custom Types**.

3 Select a custom name you want to configure, then select a paper or specialty media type, and then click **Submit**.

Using the printer control panel

1 From the home screen, navigate to:



> **Paper Menu > Custom Types**

2 Select a custom name you want to configure, and then touch .

Paper and specialty media guide

Using specialty media

Tips on using letterhead

- Use letterhead designed specifically for laser printers.
- Print samples on the letterhead being considered for use before buying large quantities.
- Before loading letterhead, flex, fan, and straighten the stack to prevent sheets from sticking together.
- Page orientation is important when printing on letterhead. For information on how to load letterhead, see:
 - “Loading trays” on page 59
 - “Loading the multipurpose feeder” on page 64

Tips on using transparencies

- Print a test page on the transparencies being considered for use before buying large quantities.
- Feed transparencies from the standard tray, or the multipurpose feeder.
- Use transparencies designed specifically for laser printers. Transparencies must be able to withstand temperatures up to 185°C (365°F) without melting, discoloring, offsetting, or releasing hazardous emissions.
Note: If the transparency weight is set to Heavy and the transparency texture is set to Rough in the Paper menu, then transparencies can be printed at a temperature up to 195°C (383°F).
- Avoid getting fingerprints on the transparencies to prevent print quality problems.
- Before loading transparencies, flex, fan, and straighten the stack to prevent sheets from sticking together.

Tips on using envelopes

Print samples on the envelopes being considered for use before buying large quantities.

- Use envelopes designed specifically for laser printers. Check with the manufacturer or vendor to ensure that the envelopes can withstand temperatures up to 230°C (446°F) without sealing, wrinkling, curling excessively, or releasing hazardous emissions.
- For best performance, use envelopes made from 90-g/m² (24-lb bond) paper or 25% cotton. All-cotton envelopes must not exceed 75-g/m² (20-lb bond) weight.
- Use only new envelopes from undamaged packages.
- To optimize performance and minimize jams, do not use envelopes that:
 - Have excessive curl or twist
 - Are stuck together or damaged in any way
 - Have windows, holes, perforations, cutouts, or embossing
 - Have metal clasps, string ties, or folding bars
 - Have an interlocking design
 - Have postage stamps attached

- Have any exposed adhesive when the flap is in the sealed or closed position
- Have bent corners
- Have rough, cockle, or laid finishes
- Adjust the width guides to fit the width of the envelopes.

Note: A combination of high humidity (over 60%) and high printing temperature may wrinkle or seal envelopes.

Tips on using labels

Print samples on the labels being considered for use before buying large quantities.

Note: Use only paper label sheets. Vinyl, pharmacy, and two-sided labels are not supported.

For more information on label printing, characteristics, and design, see the *Card Stock & Label Guide* available at <http://support.lexmark.com>.

When printing on labels:

- Use labels designed specifically for laser printers. Check with the manufacturer or vendor to verify that:
 - The labels can withstand temperatures up to 230°C (446°F) without sealing, excessive curling, wrinkling, or releasing hazardous emissions.
 - Label adhesives, face sheet (printable stock), and topcoats can withstand up to 25-psi (172-kPa) pressure without delaminating, oozing around the edges, or releasing hazardous fumes.
- Do not use labels with slick backing material.
- Use full label sheets. Partial sheets may cause labels to peel off during printing, resulting in a jam. Partial sheets also contaminate the printer and the cartridge with adhesive, and could void the printer and toner cartridge warranties.
- Do not use labels with exposed adhesive.
- Do not print within 1 mm (0.04 inches) of the edge of the label, of the perforations, or between die-cuts of the label.
- Make sure the adhesive backing does not reach to the edge of the sheet. Zone coating of the adhesive should be at least 1 mm (0.04 inches) away from edges. Adhesive material contaminates the printer and could void the warranty.
- If zone coating of the adhesive is not possible, then remove a 2-mm (0.06-inches) strip on the leading and driver edge, and use a non-oozing adhesive.
- Portrait orientation is recommended, especially when printing bar codes.

Tips on using card stock

Card stock is heavy, single-ply specialty media. Many of its variable characteristics, such as moisture content, thickness, and texture, can significantly impact print quality. Print samples on the card stock being considered for use before buying large quantities.

- From the Paper menu, set the Paper Type to Card Stock.
- Select the appropriate Paper Texture setting.
- Be aware that preprinting, perforation, and creasing may significantly affect the print quality and cause jams or other paper handling problems.
- Check with the manufacturer or vendor to ensure the card stock can withstand temperatures up to 220°C (446°F) without releasing hazardous emissions.

- Do not use preprinted card stock manufactured with chemicals that may contaminate the printer. Preprinting introduces semi-liquid and volatile components into the printer.
- Use grain short card stock when possible.

Paper guidelines

Selecting the correct paper or specialty media reduces printing problems. For the best print quality, try a sample of the paper or specialty media before buying large quantities.

Paper characteristics

The following paper characteristics affect print quality and reliability. Consider these characteristics when evaluating new paper stock.

Weight

The standard printer trays can automatically feed paper weights up to 90-g/m² (24-lb) bond grain long paper. The optional trays can automatically feed paper weights up to 120-g/m² (32-lb) bond grain long paper. The multipurpose feeder can automatically feed paper weights up to 163-g/m² (43-lb) bond grain long paper. Paper lighter than 60 g/m² (16 lb) might not be stiff enough to feed properly, causing jams. For best performance, use 75-g/m² (20-lb) bond grain long paper. For paper smaller than 182 x 257 mm (7.2 x 10.1 inches), it is recommended to use 90 g/m² (24 lb) or heavier paper.

Note: Two-sided printing is supported only for 60–90-g/m² (16–24-lb) bond paper.

Curl

Curl is the tendency for paper to curl at its edges. Excessive curl can cause paper feeding problems. Curl can occur after the paper passes through the printer, where it is exposed to high temperatures. Storing paper unwrapped in hot, humid, cold, or dry conditions, even in the trays, can contribute to paper curling prior to printing and can cause feeding problems.

Smoothness

Paper smoothness directly affects print quality. If paper is too rough, toner cannot fuse to it properly. If paper is too smooth, it can cause paper feeding or print quality issues. Always use paper between 100 and 300 Sheffield points; smoothness between 150–250 Sheffield points produces the best print quality.

Moisture content

The amount of moisture in paper affects both print quality and the ability of the printer to feed the paper correctly. Leave paper in its original wrapper until it is time to use it. This limits the exposure of paper to moisture changes that can degrade its performance.

Condition paper before printing by storing it in its original wrapper in the same environment as the printer for 24–48 hours before printing. Extend the time to several days if the storage or transportation environment is very different from the printer environment. Thick paper may also require a longer conditioning period.

Grain direction

Grain refers to the alignment of the paper fibers in a sheet of paper. Grain is either *grain long*, running the length of the paper, or *grain short*, running the width of the paper.

For 60–90-g/m² (16–24-lb) bond paper, grain long paper is recommended.

Fiber content

Most high-quality xerographic paper is made from 100% chemically treated pulped wood. This content provides the paper with a high degree of stability resulting in fewer paper feeding problems and better print quality. Paper containing fibers such as cotton can negatively affect paper handling.

Unacceptable paper

The following paper types are not recommended for use with the printer:

- Chemically-treated papers used to make copies without carbon paper, also known as carbonless papers, carbonless copy paper (CCP), or no carbon required (NCR) paper
- Preprinted papers with chemicals that may contaminate the printer
- Preprinted papers that can be affected by the temperature in the printer fuser
- Preprinted papers that require a registration (the precise print location on the page) greater or lesser than ± 2.5 mm (± 0.10 inch), such as optical character recognition (OCR) forms

In some cases, registration can be adjusted with a software application to successfully print on these forms:

- Coated papers (erasable bond), synthetic papers, thermal papers
- Rough-edged, rough or heavily textured surface papers, or curled papers
- Recycled papers that fail EN12281:2002 (European)
- Paper weighing less than 60 g/m² (16 lb)
- Multiple-part forms or documents

Selecting paper

Using the appropriate paper prevents jams and helps ensure trouble-free printing.

To help avoid paper jams and poor print quality:

- *Always* use new, undamaged paper.
- Before loading paper, know the recommended printable side of the paper. This information is usually indicated on the paper package.
- *Do not* use paper that has been cut or trimmed by hand.
- *Do not* mix paper sizes, types, or weights in the same tray; mixing results in jams.
- *Do not* use coated papers unless they are specifically designed for electrophotographic printing.

Selecting preprinted forms and letterhead

Use these guidelines when selecting preprinted forms and letterhead:

- Use grain long for 60 to 90 g/m² (16 to 24 lb) weight paper.
- Use only forms and letterhead printed using an offset lithographic or engraved printing process.
- Avoid papers with rough or heavily textured surfaces.

Use papers printed with heat-resistant inks designed for use in xerographic copiers. The ink must be able to withstand temperatures up to 230°C (446°F) without melting or releasing hazardous emissions. Use inks that are not affected by the resin in toner. Inks that are oxidation-set or oil-based generally meet these requirements; latex inks might not. When in doubt, contact the paper supplier.

Preprinted papers such as letterhead must be able to withstand temperatures up to 230°C (446°F) without melting or releasing hazardous emissions.

Using recycled paper and other office papers

As an environmentally conscious company, Lexmark supports the use of recycled office paper produced specifically for use in laser (electrophotographic) printers. In 1998, Lexmark presented to the US government a study demonstrating that recycled paper produced by major mills in the US fed as well as non-recycled paper. However, no blanket statement can be made that *all* recycled paper will feed well.

Lexmark consistently tests its printers with recycled paper (20–100% post-consumer waste) and a variety of test paper from around the world, using chamber tests for different temperature and humidity conditions. Lexmark has found no reason to discourage the use of today's recycled office papers, but generally the following property guidelines apply to recycled paper.

- Low moisture content (4–5%)
- Suitable smoothness (100–200 Sheffield units, or 140–350 Bendtsen units, European)

Note: Some much smoother papers (such as premium 24 lb laser papers, 50–90 Sheffield units) and much rougher papers (such as premium cotton papers, 200–300 Sheffield units) have been engineered to work very well in laser printers, despite surface texture. Before using these types of paper, consult your paper supplier.

- Suitable sheet-to-sheet coefficient of friction (0.4–0.6)
- Sufficient bending resistance in the direction of feed

Recycled paper, paper of lower weight (<60 g/m² [16 lb bond]) and/or lower caliper (<3.8 mils [0.1 mm]), and paper that is cut grain-short for portrait (or short-edge) fed printers may have lower bending resistance than is required for reliable paper feeding. Before using these types of paper for laser (electrophotographic) printing, consult your paper supplier. Remember that these are general guidelines only and that paper meeting these guidelines may still cause paper feeding problems in any laser printer (for example, if the paper curls excessively under normal printing conditions).

Storing paper

Use these paper storage guidelines to help avoid jams and uneven print quality:

- For best results, store paper where the temperature is 21°C (70°F) and the relative humidity is 40 percent. Most label manufacturers recommend printing in a temperature range of 18–24°C (65–75°F) with relative humidity between 40 and 60 percent.
- Store paper in cartons, on a pallet or shelf, rather than on the floor.
- Store individual packages on a flat surface.
- Do not store anything on top of individual paper packages.
- Take paper out of the carton or wrapper only when you are ready to load it in the printer. The carton and wrapper help keep the paper clean, dry, and flat.

Supported paper sizes, types, and weights

Supported paper sizes

Paper size and dimension	Standard 550-sheet tray	Optional 250- or 550-sheet tray	Multipurpose feeder	ADF	Scanner glass	Duplex mode
Business card	X	X	X	X	✓	X
3 x 5	X	X	✓	X	✓	X
4 x 6	X	X	✓	X	✓	X
A4 210 x 297 mm (8.27 x 11.7 in.)	✓	✓	✓	✓	✓	✓
A5 148 x 210 mm (5.83 x 8.27 in.)	✓	✓	✓	✓	✓	X
A6 105 x 148 mm (4.13 x 5.83 in.)	✓	X	✓	✓	✓	X
JIS B5 182 x 257 mm (7.17 x 10.1 in.)	✓	✓	✓	✓	✓	X
Letter 215.9 x 279.4 mm (8.5 x 11 in.)	✓	✓	✓	✓	✓	✓
Legal 215.9 x 355.6 mm (8.5 x 14 in.)	✓	✓	✓	✓	✓	✓
Executive 184.2 x 266.7 mm (7.25 x 10.5 in.)	✓	✓	✓	✓	✓	X
Oficio (México) 215.9 x 340.4 mm (8.5 x 13.4 in.)	✓	✓	✓	✓	X	✓
Folio 215.9 x 330.2 mm (8.5 x 13 in.)	✓	✓	✓	✓	X	✓
Statement 139.7 x 215.9 mm (5.5 x 8.5 in.)	✓	✓	✓	✓	✓	X

* To support two-sided (duplex) printing, the Universal width must be between 76.2 mm (3 in.) and 215.9 mm (8.5 in.); the Universal length must be between 76.2 mm (3 in.) and 359.92 mm (14.17 in.).

Paper size and dimension	Standard 550-sheet tray	Optional 250- or 550-sheet tray	Multipurpose feeder	ADF	Scanner glass	Duplex mode
Universal* 76.2 x 76.2 mm to 215.9 x 359.92 mm (3 x 3 in. to 8.5 x 14.17 in.)	✓	✓	✓	✓	✓	✓
7 3/4 Envelope (Monarch) 98.4 x 190.5 mm (3.875 x 7.5 in.)	X	X	✓	X	X	X
9 Envelope 98.4 x 226.1 mm (3.875 x 8.9 in.)	X	X	✓	X	X	X
10 Envelope 104.8 x 241.3 mm (4.12 x 9.5 in.)	X	X	✓	X	X	X
DL Envelope 110 x 220 mm (4.33 x 8.66 in.)	X	X	✓	X	X	X
C5 Envelope 162 x 229 mm (6.38 x 9.01 in.)	X	X	✓	X	X	X
B5 Envelope 176 x 250 mm (6.93 x 9.84 in.)	X	X	✓	X	X	X
Other Envelope 85.7 x 165 mm to 215.9 x 355.6 mm (3.375 x 6.50 in. to 8.5 x 14 in.)	X	X	✓	X	X	X

* To support two-sided (duplex) printing, the Universal width must be between 76.2 mm (3 in.) and 215.9 mm (8.5 in.); the Universal length must be between 76.2 mm (3 in.) and 359.92 mm (14.17 in.).

Supported paper types and weights

Note: Labels, transparencies, envelopes, and card stock always print at a reduced speed.

Paper type	Standard 550-sheet tray	250- or 550-sheet tray	Multipurpose feeder	Duplex mode	ADF	Scanner glass
Plain paper	✓	✓	✓	✓	✓	✓
Card stock	X	X	✓	X	✓	✓
Transparencies	X	✓ ¹	✓	X	✓	✓

¹ Transparencies are supported only in the 250-sheet tray.

² Use envelopes that lie flat when individually placed on a table facedown.

Paper type	Standard 550-sheet tray	250- or 550-sheet tray	Multipurpose feeder	Duplex mode	ADF	Scanner glass
Recycled	✓	✓	✓	✓	✓	✓
Paper labels	✓	✓	✓	X	✓	✓
Bond	X	X	✓	X	✓	✓
Envelope ²	✓	✓	✓	✓	✓	✓
Rough envelope	X	X	✓	X	✓	✓
Letterhead	✓	✓	✓	✓	✓	✓
Preprinted	✓	✓	✓	✓	✓	✓
Colored paper	✓	✓	✓	✓	✓	✓
Light paper	✓	✓	✓	✓	✓	✓
Heavy paper	✓	✓	✓	✓	✓	✓
Rough/Cotton	✓	✓	✓	X	✓	✓
Custom Type [x]	✓	✓	✓	✓	✓	✓

¹ Transparencies are supported only in the 250-sheet tray.

² Use envelopes that lie flat when individually placed on a table facedown.

Paper sizes, types, and weights supported by the optional finisher

Supported paper sizes

Paper size	Dimensions	Staple finisher
A4	210 x 297 mm (8.3 x 11.7 in.)	X
A5	148 x 210 mm (5.8 x 8.3 in.)	X
A6	105 x 148 mm (4.1 x 5.8 in.)	X
JIS B5	182 x 257 mm (7.2 x 10.1 in.)	X
Letter	216 x 279 mm (8.5 x 11 in.)	✓
Legal	216 x 356 mm (8.5 x 14 in.)	✓
Executive	184 x 267 mm (7.3 x 10.5 in.)	X
Oficio (México)	216 x 340 mm (8.5 x 13.4 in.)	✓
Folio	216 x 330 mm (8.5 x 13 in.)	✓
Statement	140 x 216 mm (5.5 x 8.5 in.)	X
Universal	105 x 216 mm to 216 x 356 mm (4.13 x 8.5 in. to 8.5 x 14 in.)	X

Paper size	Dimensions	Staple finisher
7 3/4 Envelope (Monarch)	98 x 191 mm (3.9 x 7.5 in.)	X
9 Envelope	98 x 225 mm (3.9 x 8.9 in.)	X
10 Envelope	105 x 241 mm (4.1 x 9.5 in.)	X
DL Envelope	110 x 220 mm (4.3 x 8.7 in.)	X
C5 Envelope	162 x 229 mm (6.38 x 9.01 in.)	X
B5 Envelope	176 x 250 mm (6.93 x 9.84 in.)	X
Other Envelope	98 x 162 mm (3.9 x 6.4 in.) to 176 x 250 mm (6.9 x 9.8 in.)	X

Supported paper types and weights



Paper type	Staple finisher
Plain paper	✓
Card stock	X
Transparencies	X
Recycled	✓
Paper labels	✓
Bond	✓
Envelope	X
Rough envelope	X
Letterhead	✓
Preprinted	✓
Colored paper	✓
Light paper	✓
Heavy paper	✓
Rough/Cotton	✓
Custom Type [x]	✓

Printing

Printing forms and a document

Printing forms

Use the Forms and Favorites application to quickly and easily access frequently used forms or other information that is regularly printed. Before you can use this application, first set it up on the printer. For more information, see “Setting up Forms and Favorites” on page 22.

- 1 From the printer home screen, navigate to:
Forms and Favorites > select the form from the list > enter the number of copies > adjust other settings
- 2 Depending on your printer model, touch , , or **Submit**.

Printing a document

- 1 From the Paper menu on the printer control panel, set the paper type and size to match the paper loaded.
- 2 Send the print job:

For Windows users

- a With a document open, click **File** > **Print**.
- b Click **Properties**, **Preferences**, **Options**, or **Setup**.
- c Adjust the settings, if necessary.
- d Click **OK** > **Print**.

For Macintosh users

- a Customize the settings in the Page Setup dialog:
 - 1 With a document open, choose **File** > **Page Setup**.
 - 2 Choose a paper size or create a custom size to match the paper loaded.
 - 3 Click **OK**.
- b Customize the settings in the Print dialog:
 - 1 With a document open, choose **File** > **Print**.
If necessary, click the disclosure triangle to see more options.
 - 2 From the Print dialog and pop-up menus, adjust the settings if necessary.
Note: To print on a specific paper type, adjust the paper type setting to match the paper loaded, or select the appropriate tray or feeder.
 - 3 Click **Print**.

Adjusting toner darkness

- 1 Open a Web browser, and then type the printer IP address in the address field.

Notes:

- View the printer IP address on the printer home screen. The IP address appears as four sets of numbers separated by periods, such as 123.123.123.123.
- If you are using a proxy server, then temporarily disable it to load the Web page correctly.

2 Click **Settings > Print Settings > Quality Menu > Toner Darkness**.

3 Adjust the toner darkness, and then click **Submit**.

Using the printer control panel

1 From the home screen, navigate to:

 > **Settings > Print Settings > Quality Menu > Toner Darkness**

2 Adjust the setting, and then touch **Submit**.

Printing from a flash drive or mobile device

Printing from a flash drive

Notes:

- Before printing an encrypted PDF file, you will be prompted to type the file password from the printer control panel.
- You cannot print files for which you do not have printing permissions.

1 Insert a flash drive into the USB port.



**Notes:**

- A flash drive icon appears on the printer home screen when a flash drive is inserted.
- If you insert the flash drive when the printer requires attention, such as when a jam has occurred, then the printer ignores the flash drive.

- If you insert the flash drive while the printer is processing other print jobs, then **Busy** appears on the printer display. After these print jobs are processed, you may need to view the held jobs list to print documents from the flash drive.

Warning—Potential Damage: Do not touch the USB cable, any wireless network adapter, any connector, the memory device, or the printer in the areas shown while actively printing, reading, or writing from the memory device. Loss of data can occur.



- 2 From the printer control panel, touch the document you want to print.
- 3 Touch the arrows to get a preview of the document.
- 4 Use  or  to specify the number of copies to be printed, and then touch **Print**.

Notes:

- Do not remove the flash drive from the USB port until the document has finished printing.
- If you leave the flash drive in the printer after leaving the initial USB menu screen, then touch **Held Jobs** on the home screen to print files from the flash drive.

Printing from a mobile device

To download a compatible mobile printing application, visit www.lexmark.com/mobile.

Note: Mobile printing applications may also be available from your mobile device manufacturer.

Supported flash drives and file types

Notes:

- High-speed USB flash drives must support the full-speed standard. Low-speed USB devices are not supported.
- USB flash drives must support the File Allocation Table (FAT) system. Devices formatted with New Technology File System (NTFS) or any other file system are not supported.

Recommended flash drives	File type
<ul style="list-style-type: none"> • Lexar JumpDrive FireFly (512MB and 1GB) • SanDisk Cruzer Micro (512MB and 1GB) • Sony Micro Vault Classic (512MB and 1GB) 	<p>Documents:</p> <ul style="list-style-type: none"> • .pdf • .xps <p>Images:</p> <ul style="list-style-type: none"> • .dcx • .gif • .jpeg or .jpg • .bmp • .pcx • .tiff or .tif • .png • .fls

Printing confidential and other held jobs

Storing print jobs in the printer

1 From the printer control panel, navigate to:

 > **Security** > **Confidential Print** > select the print job type

Use	To
Max Invalid PIN	Limit the number of times an invalid PIN can be entered. Note: When the limit is reached, the print jobs for that user name and PIN are deleted.
Confidential Job Expiration	Hold print jobs in the computer until you enter the PIN from the printer control panel. Note: The PIN is set from the computer. It must be four digits, using the numbers 1–9.
Repeat Job Expiration	Print and store print jobs in the printer memory.
Verify Job Expiration	Print one copy of a print job and hold the remaining copies. It allows you to examine if the first copy is satisfactory. The print job is automatically deleted from the printer memory when all copies are printed.
Reserve Job Expiration	Store print jobs for printing at a later time. Note: The print jobs are held until deleted from the Held Jobs menu.
<p>Notes:</p> <ul style="list-style-type: none"> • Confidential, Verify, Reserve, and Repeat print jobs may be deleted if the printer requires extra memory to process additional held jobs. • You can set the printer to store print jobs in the printer memory until you start the print job from the printer control panel. • All print jobs that can be initiated by the user at the printer are called <i>held jobs</i>. 	

- 2 Touch **Submit**.

Printing confidential and other held jobs

Note: Confidential and Verify print jobs are automatically deleted from memory after printing. Repeat and Reserve jobs are *held* in the printer until you delete them.

For Windows users

- 1 With a document open, click **File > Print**.
- 2 Click **Properties, Preferences, Options, or Setup**.
- 3 Click **Print and Hold**.
- 4 Select the print job type (Confidential, Repeat, Reserve, or Verify), and then assign a user name. For a confidential print job, also enter a four-digit PIN.
- 5 Click **OK** or **Print**.
- 6 From the printer home screen, release the print job.
 - For confidential print jobs, navigate to:
Held jobs > select your user name > **Confidential Jobs** > enter the PIN > **Print**
 - For other print jobs, navigate to:
Held jobs > select your user name > select the print job > specify the number of copies > **Print**

For Macintosh users

- 1 With a document open, choose **File > Print**.
If necessary, click the disclosure triangle to see more options.
- 2 From the print options or Copies & Pages pop-up menu, choose **Job Routing**.
- 3 Select the print job type (Confidential, Repeat, Reserve, or Verify), and then assign a user name. For a confidential print job, also enter a four-digit PIN.
- 4 Click **OK** or **Print**.
- 5 From the printer home screen, release the print job.
 - For confidential print jobs, navigate to:
Held jobs > select your user name > **Confidential Jobs** > enter the PIN > **Print**
 - For other print jobs, navigate to:
Held jobs > select your user name > select the print job > specify the number of copies > **Print**

Modifying confidential print settings

- 1 Open a Web browser, and then type the printer IP address in the address field.

Notes:

- View the printer IP address on the printer home screen. The IP address appears as four sets of numbers separated by periods, such as 123.123.123.123.

- If you are using a proxy server, then temporarily disable it to load the Web page correctly.

2 Click **Settings > Security > Confidential Print Setup**.

3 Modify the settings:

- Set a maximum number of PIN entry attempts. When a user exceeds that number, all of the jobs for that user are deleted.
- Set an expiration time for confidential print jobs. When a user has not printed the jobs within that time, all of the jobs for that user are deleted.

4 Click **Submit** to save the modified settings.

Printing information pages

Printing a font sample list

1 From the home screen, navigate to:



> **Reports > Print Fonts**

2 Touch **PCL Fonts** or **PostScript Fonts**.

Printing a directory list

A directory list shows the resources stored in a flash memory or in the printer hard disk.

From the home screen, navigate to:



> **Reports > Print Directory**

Canceling a print job

Canceling a print job from the printer control panel

- 1** From the printer control panel, touch **Cancel Job** or press  on the keypad.
- 2** Touch the print job you want to cancel, and then touch **Delete Selected Jobs**.

Note: If you press  on the keypad, then touch **Resume** to return to the home screen.

Canceling a print job from the computer

For Windows users

- 1** Open the printers folder.

In Windows 8

From the Search charm, type **run**, and then navigate to:

Apps list > **Run** > type **control printers** > **OK**

In Windows 7 or earlier



- a** Click  or click **Start**, and then click **Run**.
- b** In the Start Search or Run dialog, type **control printers**.
- c** Press **Enter**, or click **OK**.

- 2** Double-click the printer icon.
- 3** Select the print job you want to cancel.
- 4** Click **Delete**.

For Macintosh users

- 1** From the Apple menu, navigate to either of the following:
 - **System Preferences > Print & Scan** > select your printer > **Open Print Queue**
 - **System Preferences > Print & Fax** > select your printer > **Open Print Queue**
- 2** From the printer window, select the print job you want to cancel, and then delete it.

Copying

Automatic document feeder (ADF)	Scanner glass
 <p>Use the ADF for multiple-page documents.</p>	 <p>Use the scanner glass for single pages, small items (such as postcards or photos), transparencies, photo paper, or thin media (such as magazine clippings).</p>

Making copies

Making a quick copy

- 1 Load an original document faceup, short edge first into the ADF tray or facedown on the scanner glass.

Notes:

- Do not load postcards, photos, small items, transparencies, photo paper, or thin media (such as magazine clippings) into the ADF tray. Place these items on the scanner glass.
- The ADF indicator light comes on when the paper is loaded properly.

- 2 If you are loading a document into the ADF tray, then adjust the paper guides.

Note: To avoid a cropped image, make sure the size of the original document and the size of the copy paper are the same.

- 3 From the printer control panel, press .

Copying using the ADF

- 1 Load an original document faceup, short edge first into the ADF tray.

Notes:

- Do not load postcards, photos, small items, transparencies, photo paper, or thin media (such as magazine clippings) into the ADF tray. Place these items on the scanner glass.
- The ADF indicator light comes on when the paper is loaded properly.



- 2 Adjust the paper guides.

- 3 From the home screen, navigate to:
Copy > specify the copy settings > **Copy It**

Copying using the scanner glass

- 1 Place an original document facedown on the scanner glass in the upper left corner.
- 2 From the home screen, navigate to:
Copy > specify the copy settings > **Copy It**
If you have more pages to scan, then place the next document on the scanner glass, and then touch **Scan the next page**.
- 3 Touch **Finish the Job**.

Copying photos

- 1 Place a photo facedown on the scanner glass in the upper left corner.
- 2 From the home screen, navigate to:
Copy > **Content** > **Photo** > 
- 3 From the Content Source menu, navigate to:
Photo/Film >  > **Copy It**
Note: If you have more photos to copy, then place the next photo on the scanner glass, and then touch **Scan the next page**.
- 4 Touch **Finish the Job**.

Copying on specialty media

Copying on transparencies

- 1 Load an original document faceup, short edge first into the ADF tray or facedown on the scanner glass.

Notes:

- Do not load postcards, photos, small items, transparencies, photo paper, or thin media (such as magazine clippings) into the ADF tray. Place these items on the scanner glass.
- The ADF indicator light comes on when the paper is loaded properly.



- 2 From the home screen, navigate to:

Copy > **Copy from** > select the size of the original document > 

3 Navigate to:

Copy to > select the tray that contains transparencies > **Copy It**

If there are no trays that contain transparencies, then navigate to:

Manual Feeder >  > select the size of the transparencies >  > **Transparency** > 

4 Load transparencies into the multipurpose feeder, and then touch **Copy It**.

Copying on letterhead

1 Load an original document faceup, short edge first into the ADF tray or facedown on the scanner glass.

Notes:

- Do not load postcards, photos, small items, transparencies, photo paper, or thin media (such as magazine clippings) into the ADF tray. Place these items on the scanner glass.
- The ADF indicator light comes on when the paper is loaded properly.

2 If you are loading a document into the ADF tray, then adjust the paper guides.

3 From the home screen, navigate to:

Copy > **Copy from** > select the size of the original document > 

4 Navigate to:

Copy to > select the tray containing the letterhead > **Copy It**

5 If there are no trays that support letterhead, then navigate to:

Manual Feeder > select the size of the letterhead > **Letterhead**

6 Load the letterhead faceup, top edge first into the multipurpose feeder, and then touch **Copy It**.

Customizing copy settings

Copying to a different size

1 Load an original document faceup, short edge first into the ADF tray or facedown on the scanner glass.

Notes:

- Do not load postcards, photos, small items, transparencies, photo paper, or thin media (such as magazine clippings) into the ADF tray. Place these items on the scanner glass.
- The ADF indicator light comes on when the paper is loaded properly.

2 If you are loading a document into the ADF tray, then adjust the paper guides.

3 From the home screen, navigate to:

Copy > **Copy from** > select the size of the original document > 

4 Navigate to:

Copy to > select a new size for the copy >  > **Copy It**

Making copies using paper from a selected tray

- 1 Load an original document faceup, short edge first into the ADF tray or facedown on the scanner glass.

Notes:

- Do not load postcards, photos, small items, transparencies, photo paper, or thin media (such as magazine clippings) into the ADF tray. Place these items on the scanner glass.
- The ADF indicator light comes on when the paper is loaded properly.

- 2 If you are loading a document into the ADF tray, then adjust the paper guides.
- 3 From the home screen, navigate to:

Copy > Copy from > select the size of the original document > 

- 4 Navigate to:

Copy to > select the tray containing the paper type you want to use > 

- 5 Touch **Copy It**.

Copying different paper sizes

Use the ADF to copy original documents with different paper sizes. Depending on the paper sizes loaded and the “Copy to” and “Copy from” settings, each copy is either printed on mixed paper sizes (Example 1) or scaled to fit a single paper size (Example 2).

Example 1: Copying on mixed paper sizes

- 1 Load an original document faceup, short edge first into the ADF tray or facedown on the scanner glass.

Notes:

- Do not load postcards, photos, small items, transparencies, photo paper, or thin media (such as magazine clippings) into the ADF tray. Place these items on the scanner glass.
- The ADF indicator light comes on when the paper is loaded properly.

- 2 If you are loading a document into the ADF tray, then adjust the paper guides.
- 3 From the home screen, navigate to:

Copy > Copy from > **Mixed Sizes** > 

- 4 Navigate to:

Copy to > **Auto Size Match** >  > **Copy It**

The scanner identifies the different paper sizes as they are scanned. Copies are printed on mixed paper sizes corresponding to the paper sizes of the original document.

Example 2: Copying on a single paper size

- 1 Load an original document faceup, short edge first into the ADF tray or facedown on the scanner glass.

Notes:

- Do not load postcards, photos, small items, transparencies, photo paper, or thin media (such as magazine clippings) into the ADF tray. Place these items on the scanner glass.

- The ADF indicator light comes on when the paper is loaded properly.

2 If you are loading a document into the ADF tray, then adjust the paper guides.

3 From the home screen, navigate to:

Copy > Copy from > Mixed Sizes > 

4 Navigate to:

Copy to > Letter >  **> Copy It**

The scanner identifies the different paper sizes as they are scanned, and then scales the mixed paper sizes to fit on the paper size selected.

Copying on both sides of the paper (duplexing)

1 Load an original document faceup, short edge first into the ADF tray or facedown on the scanner glass.

Notes:

- Do not load postcards, photos, small items, transparencies, photo paper, or thin media (such as magazine clippings) into the ADF tray. Place these items on the scanner glass.
- The ADF indicator light comes on when the paper is loaded properly.

2 If you are loading a document into the ADF tray, then adjust the paper guides.

3 From the home screen, navigate to:

Copy > Sides (Duplex) > select the preferred duplexing method

Note: For the preferred duplexing method, the first number represents sides of the original documents while the second number represents sides of the copy. For example, select “2 sided to 2 sided” if you have two-sided original documents and you want two-sided copies.

4 Touch  **> Copy It.**

Reducing or enlarging copies

Copies can be scaled from 25% to 400% of the original document size.

1 Load an original document faceup, short edge first into the ADF tray or facedown on the scanner glass.

Notes:

- Do not load postcards, photos, small items, transparencies, photo paper, or thin media (such as magazine clippings) into the ADF tray. Place these items on the scanner glass.
- The ADF indicator light comes on when the paper is loaded properly.

2 If you are loading a document into the ADF tray, then adjust the paper guides.

3 From the home screen, touch **Copy**.

- 4 From the Scale area, touch  or  to decrease or increase the value by 1%.

Touching “Copy to” or “Copy from” after setting Scale manually changes the scale value back to Auto.

Note: Auto is the factory default setting. This automatically adjusts the scan image of the original document to fit the size of the paper onto which you are copying.

- 5 Touch **Copy It**.

Adjusting copy quality

- 1 Load an original document faceup, short edge first into the ADF tray or facedown on the scanner glass.

Notes:

- Do not load postcards, photos, small items, transparencies, photo paper, or thin media (such as magazine clippings) into the ADF tray. Place these items on the scanner glass.
- The ADF indicator light comes on when the paper is loaded properly.

- 2 If you are loading a document into the ADF tray, then adjust the paper guides.

- 3 From the home screen, navigate to:

Copy > Content

- 4 Touch the button that best represents the content type of the document you are copying.

- **Text**—The content of the original document is mostly text or line art.
- **Text/Photo**—The original document is a mixture of text, graphics, and photos.
- **Photo**—The original document is mostly a photo or an image.
- **Graphics**—The original document is mostly business-type graphics, such as pie charts, bar charts, and animations.

- 5 Touch .

- 6 Touch the button that best represents the content source of the document you are copying.

- **Color Laser**—The original document was printed using a color laser printer.
- **Inkjet**—The original document was printed using an inkjet printer.
- **Magazine**—The original document is from a magazine.
- **Press**—The original document was printed using a printing press.
- **Black/White Laser**—The original document was printed using a mono laser printer.
- **Photo/Film**—The original document is a photo from a film.
- **Newspaper**—The original document is from a newspaper.
- **Other**—The original document was printed using an alternate or unknown printer.

- 7 Touch  > **Copy It**.

Collating copies

If you print multiple copies of a document, then you can choose to print the copies as a set (collated) or to print the copies as groups of pages (not collated).

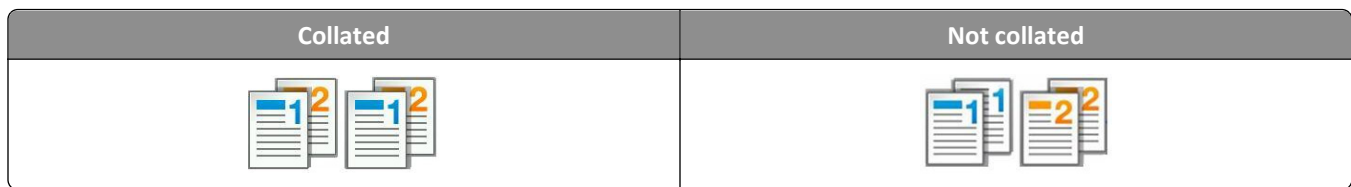

1 Load an original document faceup, short edge first into the ADF tray or facedown on the scanner glass.

Notes:

- Do not load postcards, photos, small items, transparencies, photo paper, or thin media (such as magazine clippings) into the ADF tray. Place these items on the scanner glass.
- The ADF indicator light comes on when the paper is loaded properly.

2 If you are loading a document into the ADF tray, then adjust the paper guides.

3 From the home screen, navigate to:

Copy > enter the number of copies > **Collate** > select the preferred order of pages >  > **Copy It**

Placing separator sheets between copies

1 Load an original document faceup, short edge first into the ADF tray or facedown on the scanner glass.

Notes:

- Do not load postcards, photos, small items, transparencies, photo paper, or thin media (such as magazine clippings) into the ADF tray. Place these items on the scanner glass.
- The ADF indicator light comes on when the paper is loaded properly.

2 If you are loading a document into the ADF tray, then adjust the paper guides.

3 From the home screen, navigate to:

Copy > **Advanced Options** > **Separator Sheets**

Note: Set Collate to “1,2,3 - 1,2,3” to place separator sheets between copies. If Collate is set to “1,1,1 - 2,2,2,” then the separator sheets are added to the end of the copy job. For more information, see “Collating copies” on page 94.

4 Select one of the following:

- **Between Copies**
- **Between Jobs**
- **Between Pages**
- **Off**

5 Touch  > **Copy It**.

Copying multiple pages onto a single sheet

In order to save paper, you can copy either two or four consecutive pages of a multiple-page document onto a single sheet of paper.

Notes:

- Make sure to set the paper size to letter, legal, A4, or JIS B5.
- Make sure to set the copy size to 100%.

1 Load an original document faceup, short edge first into the ADF tray or facedown on the scanner glass.

Notes:

- Do not load postcards, photos, small items, transparencies, photo paper, or thin media (such as magazine clippings) into the ADF tray. Place these items on the scanner glass.
- The ADF indicator light comes on when the paper is loaded properly.

2 If you are loading a document into the ADF tray, then adjust the paper guides.

3 From the home screen, navigate to:

Copy > Advanced Options > Paper Saver > select the output you want >  > Copy It

Note: If Paper Saver is set to Off, then the Print Page Borders option is unavailable.

Creating a custom copy job

The custom copy job or job build is used to combine one or more sets of original documents into a single copy job. Each set may be scanned using different job parameters. When a copy job is submitted and Custom Job is enabled, the scanner scans the first set of original documents using the specified settings, and then it scans the next set with the same or different settings.

The definition of a set depends on the scan source:

- If you scan a document on the scanner glass, then a set consists of one page.
- If you scan multiple pages using the ADF, then a set consists of all scanned pages until the ADF tray becomes empty.
- If you scan one page using the ADF, then a set consists of one page.

For example:

1 Load an original document faceup, short edge first into the ADF tray or facedown on the scanner glass.

Notes:

- Do not load postcards, photos, small items, transparencies, photo paper, or thin media (such as magazine clippings) into the ADF tray. Place these items on the scanner glass.
- The ADF indicator light comes on when the paper is loaded properly.

2 If you are loading a document into the ADF tray, then adjust the paper guides.

3 From the home screen, navigate to:

Copy > Advanced Options > Custom Job > On >  > Copy It

Note: When the end of a set is reached, the scan screen appears.

4 Load the next document faceup, short edge first into the ADF tray or facedown on the scanner glass, and then touch **Scan from automatic feeder** or **Scan from flatbed**.

Note: Change the scan job settings, if necessary.

5 If you have another document to scan, then repeat the previous step. Otherwise, touch **Finish the job**.

Placing information on copies

Placing a header or footer on pages

- 1 Load an original document faceup, short edge first into the ADF tray or facedown on the scanner glass.

Notes:



- Do not load postcards, photos, small items, transparencies, photo paper, or thin media (such as magazine clippings) into the ADF tray. Place these items on the scanner glass.
- The ADF indicator light comes on when the paper is loaded properly.

- 2 If you are loading a document into the ADF, then adjust the paper guides.

- 3 From the home screen, navigate to:

Copy > Advanced Options > Header/Footer > select where you want to place the header or footer > select the type of header or footer you want

- 4 Enter the required information depending on the header or footer you selected, and then touch **Done**.

- 5 Touch , and then press .

Placing an overlay message on each page

An overlay message can be placed on each page. The message choices are Urgent, Confidential, Copy, Custom, and Draft.

- 1 Load an original document faceup, short edge first into the ADF tray or facedown on the scanner glass.

Notes:

- Do not load postcards, photos, small items, transparencies, photo paper, or thin media (such as magazine clippings) into the ADF tray. Place these items on the scanner glass.
- The ADF indicator light comes on when the paper is loaded properly.

- 2 If you are loading a document into the ADF tray, then adjust the paper guides.

- 3 From the home screen, navigate to:

Copy > Advanced Options > Overlay > select overlay message > Done > Copy It

Canceling a copy job

Canceling a copy job while the original document is in the ADF

When the ADF begins processing a document, touch **Cancel Job** on the printer control panel.

Canceling a copy job while copying pages using the scanner glass

From the home screen, touch **Cancel Job**.

Canceling appears on the display. When the job is canceled, the Copy screen appears.

Canceling a copy job while pages are being printed

- 1 From the printer control panel, touch **Cancel Job** or press  on the keypad.
- 2 Touch the job you want to cancel, and then touch **Delete Selected Jobs**.

Note: If you press  on the keypad, then touch **Resume** to return to the home screen.

Understanding the copy options

Copy from

This option opens a screen where you can select the paper size of the original document.

- Touch the paper size that matches the original document.
- To copy an original document that contains mixed paper sizes with the same width, touch **Mixed Sizes**.
- To set the printer to automatically detect the size of the original document, touch **Auto Size Sense**.



Copy to

This option opens a screen where you can enter the paper size and type on which your copies will be printed.

- Touch the paper size and type that matches the paper loaded.
- If the settings for “Copy from” and “Copy to” are different, then the printer automatically adjusts the Scale setting to accommodate the difference.
- If the paper type or size that you want to copy onto is not loaded in one of the trays, then touch **Manual Feeder**, and manually load the paper in the multipurpose feeder.
- When “Copy to” is set to Auto Size Match, each copy matches the paper size of the original document. If a matching paper size is not in one of the trays, then **Paper size not found** appears and prompts to load a paper in a tray or multipurpose feeder.

Scale

This option lets you scale the document from 25% to 400% of the original document size. You can also set automatic scaling.

- When copying to a different paper size, such as from legal-size to letter-size paper, set the “Copy from” and “Copy to” paper sizes automatically to scale the scan image to fit the size of the paper onto which you are copying.
- To decrease or increase the value by 1%, touch  or  on the printer control panel. To make a continuous decrease or increase in value, hold the button for two seconds or more.

Darkness

This option lets you adjust how light or dark the copies are in relation to the original document.

Sides (Duplex)

This option lets you make one- or two-sided copies from one- or two-sided original documents.

Collate

This option keeps the pages of a print job stacked in sequence when printing multiple copies of the document.

Copies

This option lets you set the number of copies to be printed.

Content

This option lets you set the original document type and source.

Select from the following content types:

- **Text**—The content of the original document is mostly text or line art.
- **Text/Photo**—The original document is a mixture of text, graphics, and photos.
- **Photo**—The original document is mostly a photo or an image.
- **Graphics**—The original document is mostly business-type graphics, such as pie charts, bar charts, and animations.

Select from the following content sources:

- **Color Laser**—The original document was printed using a color laser printer.
- **Inkjet**—The original document was printed using an inkjet printer.
- **Magazine**—The original document is from a magazine.
- **Brochure**—The original document is from a brochure.
- **Black/White Laser**—The original document was printed using a mono laser printer.
- **Photo/Film**—The original document is a photo from film.
- **Newspaper**—The original document is from a newspaper.
- **Other**—The original document was printed using an alternate or unknown printer.

Save As Shortcut

This option lets you save the current settings by assigning a shortcut number.



Using the advanced options

Select from the following settings:

- **Advanced Imaging**—This adjusts the Background Removal, Color Balance, Color Dropout, Contrast, JPEG Quality, Mirror Image, Negative Image, Scan Edge to Edge, Shadow Detail, and Sharpness settings before you scan the document.
- **Custom Job**—This combines multiple scanning jobs into a single job.
- **Edge Erase**—This removes smudges or marks around the edges of a document. You can choose to remove an equal area around all four sides of the paper, or pick a particular edge. Edge Erase erases whatever is within the area selected, leaving nothing on that portion of the scan.
- **Transmission Log**—This prints the transmission log or transmission error log.
- **Adjust ADF Skew**—This straightens scanned images that are slightly skewed when received from the ADF tray.

Note: This option is supported only in select printer models.

E-mailing

Automatic document feeder (ADF)	Scanner glass
 <p data-bbox="149 751 613 783">Use the ADF for multiple-page documents.</p>	 <p data-bbox="630 800 1409 892">Use the scanner glass for single pages, small items (such as postcards or photos), transparencies, photo paper, or thin media (such as magazine clippings).</p>

You can use the printer to e-mail scanned documents to one or more recipients in a number of ways. You can type the e-mail address, use a shortcut number, or use the address book.

Setting up the printer to e-mail

Setting up the e-mail function

- 1 Open a Web browser, and then type the printer IP address in the address field.

Notes:

- View the printer IP address on the printer home screen. The IP address appears as four sets of numbers separated by periods, such as 123.123.123.123.
- If you are using a proxy server, then temporarily disable it to load the Web page correctly.

- 2 Click **Settings** > **E-mail/FTP Settings** > **E-mail Settings**.
- 3 Enter the appropriate information, and then click **Submit**.

Configuring e-mail settings

- 1 Open a Web browser, and then type the printer IP address in the address field.

Notes:

- View the printer IP address on the printer home screen. The IP address appears as four sets of numbers separated by periods, such as 123.123.123.123.
- If you are using a proxy server, then temporarily disable it to load the Web page correctly.

- 2 Click **Settings** > **E-mail/FTP Settings** > **E-mail Settings**.

- 3 Enter the appropriate information, and then click **Submit**.

Creating an e-mail shortcut

Creating an e-mail shortcut using the Embedded Web Server

- 1 Open a Web browser, and then type the printer IP address in the address field.

Notes:

- View the printer IP address on the printer home screen. The IP address appears as four sets of numbers separated by periods, such as 123.123.123.123.
- If you are using a proxy server, then temporarily disable it to load the Web page correctly.

- 2 Click **Settings**.
- 3 From the Other Settings column, click **Manage Shortcuts > E-mail Shortcut Setup**.
- 4 Type a unique name for the e-mail recipient, and then type the e-mail address. If you are entering multiple addresses, then separate each address with a comma.
- 5 Click **Add**.

Creating an e-mail shortcut using the printer control panel

- 1 From the home screen, navigate to:
E-mail > Recipient > type an e-mail address
To create a group of recipients, touch **Next address**, and then type the next recipient's e-mail address.
- 2 Touch **Subject**, then type the e-mail subject, and then touch **Done**.
- 3 Touch **Message**, then type your message, and then touch **Done**.
- 4 Adjust the e-mail settings.

Note: If you change the settings after the e-mail shortcut has been created, then the settings are not saved.

- 5 Touch .
- 6 Type a unique name for the shortcut, and then touch **Done**.
- 7 Verify that the shortcut name is correct, and then touch **OK**.
If the shortcut name is incorrect, then touch **Cancel**, and then reenter the information.

Notes:

- The shortcut name appears in the E-mail Shortcuts icon on the printer home screen.
- You can use the shortcut when e-mailing another document using the same settings.

E-mailing a document

You can use the printer to e-mail scanned documents to one or more recipients in a number of ways. You can type the e-mail address, use a shortcut number, or use the address book. You can also use the Multi Send or MyShortcut application from the printer home screen. For more information, see “Activating the home screen applications” on page 22.

Sending an e-mail using the printer control panel

- 1 Load an original document faceup, short edge first into the ADF tray or facedown on the scanner glass.

Notes:

- Do not load postcards, photos, small items, transparencies, photo paper, or thin media (such as magazine clippings) into the ADF tray. Place these items on the scanner glass.
- The ADF indicator light comes on when the paper is loaded properly.

- 2 If you are loading a document into the ADF tray, then adjust the paper guides.

Note: To avoid a cropped image, make sure that the size of the original document and the copy paper size are the same.

- 3 From the home screen, navigate to:

E-mail > Recipient(s)

- 4 Type the e-mail address, or press # using the keypad, and then enter the shortcut number.

Notes:

- To enter additional recipients, touch **Next address**, and then enter the address or shortcut number you want to add.
- You can also enter an e-mail address using the address book.

- 5 Touch **Done > Send It**.

Sending an e-mail using a shortcut number

- 1 Load an original document faceup, short edge first into the ADF tray or facedown on the scanner glass.

Notes:

- Do not load postcards, photos, small items, transparencies, photo paper, or thin media (such as magazine clippings) into the ADF tray. Place these items on the scanner glass.
- The ADF indicator light comes on when the paper is loaded properly.

- 2 If you are loading a document into the ADF tray, then adjust the paper guides.

- 3 Press #, then enter the shortcut number using the keypad, and then touch .

Note: To enter additional recipients, touch **Next address**, and then enter the address or shortcut number that you want to add.

- 4 Touch **Send It**.

Sending an e-mail using the address book

- 1 Load an original document faceup, short edge first into the ADF tray or facedown on the scanner glass.

Notes:

- Do not load postcards, photos, small items, transparencies, photo paper, or thin media (such as magazine clippings) into the ADF tray. Place these items on the scanner glass.
- The ADF indicator light comes on when the paper is loaded properly.

- 2 If you are loading a document into the ADF tray, then adjust the paper guides.
- 3 From the home screen, navigate to:

E-mail > **Recipient(s)** >  > type the name of the recipient > **Search**

- 4 Touch the name of the recipient.

Note: To enter additional recipients, touch **Next address**, and then enter the address or shortcut number that you want to add, or search the address book.

- 5 Touch **Done**.

Customizing e-mail settings

Adding e-mail subject and message information

- 1 Load an original document faceup, short edge first into the ADF tray or facedown on the scanner glass.

Notes:

- Do not load postcards, photos, small items, transparencies, photo paper, or thin media (such as magazine clippings) into the ADF tray. Place these items on the scanner glass.
- The ADF indicator light comes on when the paper is loaded properly.

- 2 If you are loading a document into the ADF tray, then adjust the paper guides.
- 3 From the home screen, navigate to:

E-mail > **Recipient(s)** > type the e-mail address > **Done**

- 4 Touch **Subject**, then type the e-mail subject, and then touch **Done**.
- 5 Touch **Message**, then type your message, and then touch **Done**.

Changing the output file type

- 1 Load an original document faceup, short edge first into the ADF tray or facedown on the scanner glass.

Notes:

- Do not load postcards, photos, small items, transparencies, photo paper, or thin media (such as magazine clippings) into the ADF tray. Place these items on the scanner glass.
- The ADF indicator light comes on when the paper is loaded properly.

- 2 If you are loading a document into the ADF tray, then adjust the paper guides.

3 From the home screen, navigate to:

E-mail > Recipient(s) > type the e-mail address > Done > Send as

4 Touch the button that represents the file type you want to send.

- **PDF**—Create a single file with multiple pages.
- **Secure PDF**—Create an encrypted PDF file that protects the file contents from unauthorized access.
- **TIFF**—Create multiple files or a single file. If Multi-page TIFF is turned off in the Settings menu of the Embedded Web Server, then TIFF saves one page in each file. The file size is usually larger than an equivalent JPEG.
- **JPEG**—Create and attach a separate file for each page of your original document, viewable by most Web browsers and graphics programs.
- **XPS**—Create a single XML Paper Specification (XPS) file with multiple pages, viewable using an Internet Explorer-hosted viewer and the .NET Framework, or by downloading a third-party standalone viewer.

5 Touch  > **Send It.**

Note: If you selected Secure PDF, then you will be prompted to enter your password twice.

Canceling an e-mail

- When using the ADF, touch **Cancel Job** while **Scanning** appears.
- When using the scanner glass, touch **Cancel Job** while **Scanning** appears, or while **Scan the Next Page / Finish the Job** appears.

Understanding the e-mail options

Recipient(s)

This option lets you enter the recipient of your e-mail. You may enter multiple e-mail addresses.

Subject

This option lets you type a subject line for your e-mail.

Message

This option lets you type a message that will be sent with your scanned attachment.

File Name

This option lets you customize the attachment file name.

Original Size

This option lets you set the paper size of the documents you are going to e-mail. When Original Size is set to Mixed Sizes, you can scan an original document that contains mixed paper sizes (letter- and legal-size pages).

Darkness

This option lets you adjust how light or dark your scanned documents are in relation to the original document.

Resolution

This option lets you adjust the output quality of your e-mail. Increasing the image resolution increases the e-mail file size and the time needed to scan your original document. Decreasing the image resolution reduces the file size.

Send As

This option lets you set the output type for the scan image.

Select one of the following:

- **PDF**—Use this to create a single file with multiple pages.
Note: PDF is the factory default setting.
- **Secure PDF**—Use this to create an encrypted PDF file that protects the file contents from unauthorized access.
- **TIFF**—Use this to create multiple files or a single file. If Multi-page TIFF is turned off in the Settings menu of the Embedded Web Server, then TIFF saves one page in each file. The file size is usually larger than an equivalent JPEG.
- **JPEG**—Use this to create and attach a separate file for each page of your original document.
- **XPS**—Use this to create a single XPS file with multiple pages.

Content

This option lets you set the original document type and source.

Select from the following content types:

- **Text**—The content of the original document is mostly text or line art.
- **Text/Photo**—The original document is a mixture of text, graphics, and photos.
- **Photo**—The original document is mostly a photo or an image.
- **Graphics**—The original document is mostly business-type graphics, such as pie charts, bar charts, and animations.

Select from the following content sources:

- **Color Laser**—The original document was printed using a color laser printer.
- **Inkjet**—The original document was printed using an inkjet printer.
- **Magazine**—The original document is from a magazine.
- **Brochure**—The original document is from a brochure.
- **Black/White Laser**—The original document was printed using a mono laser printer.
- **Photo/Film**—The original document is a photo from film.
- **Newspaper**—The original document is from a newspaper.
- **Other**—The original document was printed using an alternate or unknown printer.

Page Setup

This option lets you change the following settings:

- **Sides (Duplex)**—This specifies if the original document is printed on only one side or on both sides of the paper. This also identifies what needs to be scanned for inclusion in the e-mail.
- **Orientation**—This specifies the orientation of the original document, and then changes the Sides (Duplex) and Binding settings to match the orientation.
- **Binding**—This specifies if the original document is bound on the long-edge or short-edge side.

Scan Preview

This option lets you view the first page of the image before it is included in the e-mail. When the first page is scanned, the scanning is paused and a preview image appears.

Note: This option appears only when a working printer hard disk is installed.



Using the advanced options

Select from the following settings:

- **Advanced Imaging**—This adjusts the Background Removal, Color Balance, Color Dropout, Contrast, JPEG Quality, Mirror Image, Negative Image, Scan Edge to Edge, Shadow Detail, and Sharpness settings before you e-mail the document.
- **Custom Job**—This combines multiple scanning jobs into a single job.
- **Edge Erase**—This removes smudges or marks around the edges of a document. You can choose to remove an equal area around all four sides of the paper, or pick a particular edge. Edge Erase will erase whatever is within the area selected, leaving nothing on that portion of the scan.
- **Transmission Log**—This prints the transmission log or transmission error log.
- **Adjust ADF Skew**—This straightens scanned images that are slightly skewed when received from the ADF tray.

Note: This option is supported only in select printer models.

Faxing

Automatic document feeder (ADF)	Scanner glass
 <p data-bbox="149 751 716 814">Use the ADF for multiple-page documents including two-sided (duplex) pages.</p>	 <p data-bbox="756 800 1474 888">Use the scanner glass for single-page documents, book pages, small items (such as postcards or photos), transparencies, photo paper, or thin media (such as magazine clippings).</p>

Setting up the printer to fax

 **CAUTION—SHOCK HAZARD:** Do not use the fax feature during a lightning storm. Do not set up this product or make any electrical or cabling connections, such as the fax feature, power cord, or telephone, during a lightning storm.

Notes:

- The following connection methods are applicable only in select countries or regions.
- During the initial printer setup, clear the fax function check box and any other function you plan to set up later, and then press **Continue**.
- The indicator light may blink red if the fax function is enabled but not fully set up.

Warning—Potential Damage: Do not touch the cables or the printer in the area shown while actively sending or receiving a fax.



Initial fax setup

Many countries and regions require outgoing faxes to contain the following information in a margin at the top or bottom of each transmitted page, or on the first page of the transmission: fax name (identification of the business, other entity, or individual sending the message) and fax number (telephone number of the sending fax machine, business, other entity, or individual). For more information, see “Regulatory notices for telecommunication terminal equipment” on page 322.

To enter your fax setup information, use the printer control panel, or use your browser to access the Embedded Web Server and then enter the Settings menu.

Note: If you do not have a TCP/IP environment, then you must use the printer control panel to enter your fax setup information.

Using the printer control panel for fax setup

When the printer is turned on for the first time, a series of start-up screens appear. If the printer has fax capabilities, then the Fax Name and Fax Number screens appear.

- 1 When the Fax Name screen appears, do the following:
 - a Enter the name to be printed on all outgoing faxes.
 - b Enter the fax name, and then touch **Submit**.
- 2 When the Fax Number screen appears, enter the fax number, and then touch **Submit**.

Using the Embedded Web Server for fax setup

- 1 Open a Web browser, and then type the printer IP address in the address field.

Notes:

- View the printer IP address on the printer home screen. The IP address appears as four sets of numbers separated by periods, such as 123.123.123.123.
- If you are using a proxy server, then temporarily disable it to load the Web page correctly.

- 2 Click **Settings > Fax Settings > Analog Fax Setup**.
- 3 In the Fax Name field, type the name to be printed on all outgoing faxes.
- 4 In the Fax Number field, enter the printer fax number.
- 5 Click **Submit**.

Choosing a fax connection

Scenario 1: Standard telephone line

Setup 1: Printer is connected to a dedicated fax line

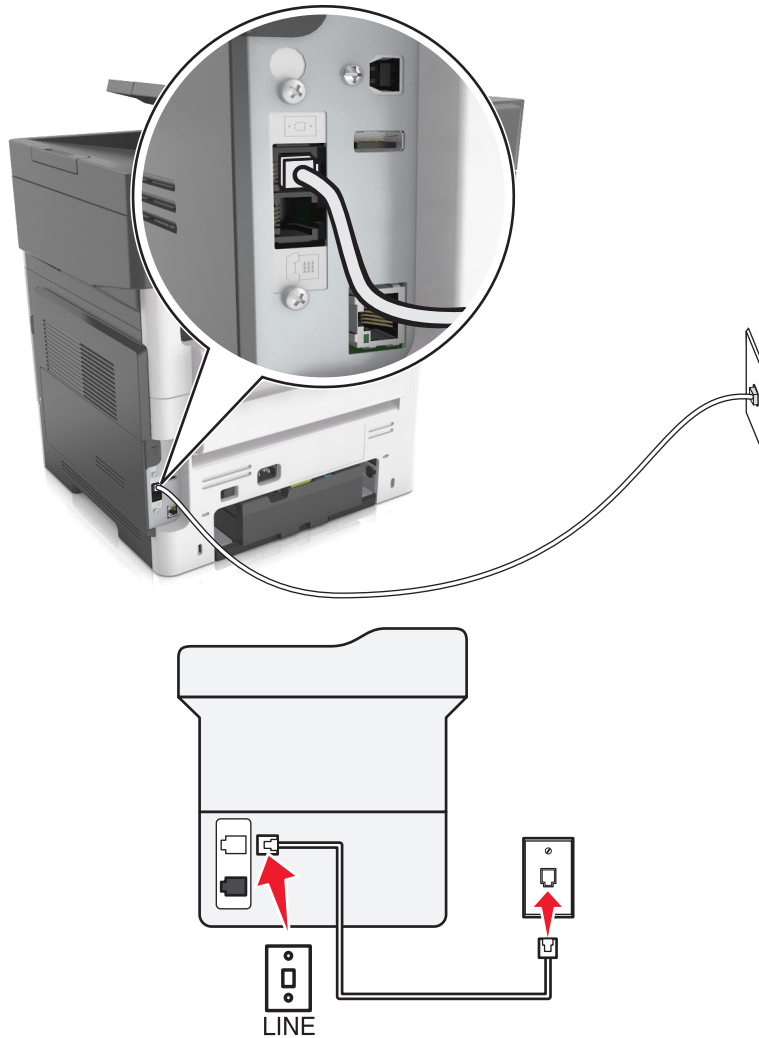



To connect:

- 1 Connect one end of the telephone cable that came with the printer to the  port of the printer.
- 2 Connect the other end of the telephone cable to an active analog wall jack.

Tips for this setup:

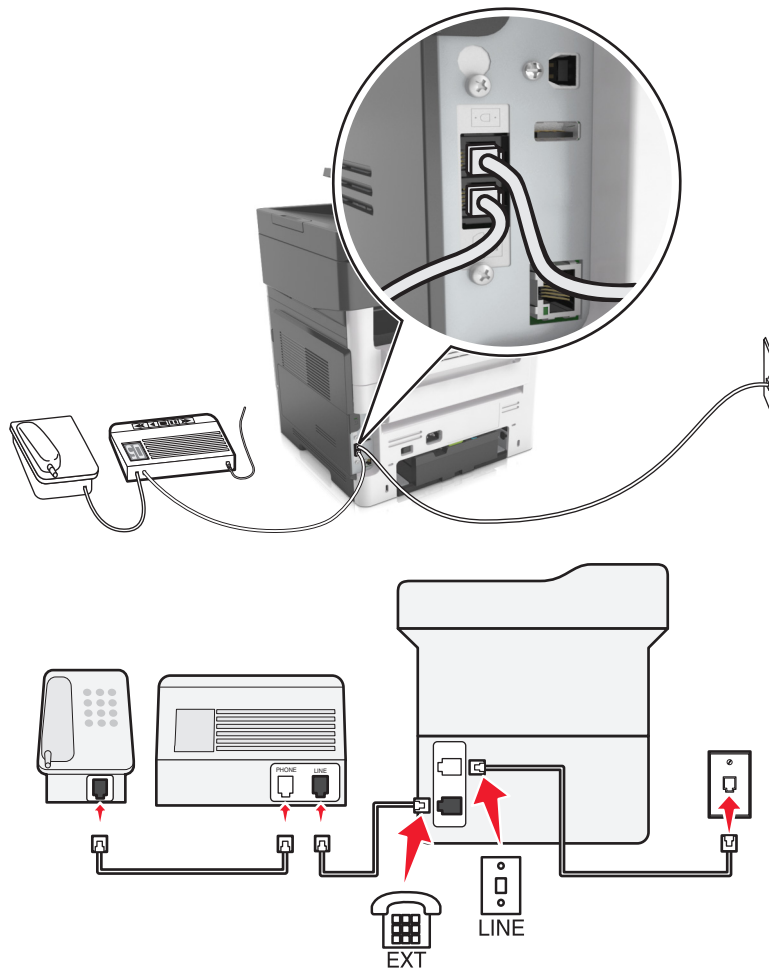
- You can set the printer to receive faxes automatically (Auto Answer On) or manually (Auto Answer Off).
- If you want to receive faxes automatically (Auto Answer On), then set the printer to pick up on any number of rings that you want.

Setup 2: Printer is sharing the line with an answering machine**Connected to the same telephone wall jack****To connect:**

- 1 Connect one end of the telephone cable that came with the printer to the  port of the printer.
- 2 Connect the other end of the telephone cable to an active analog wall jack.
- 3 Connect the answering machine to the  port of the printer.

Connected to different wall jacks

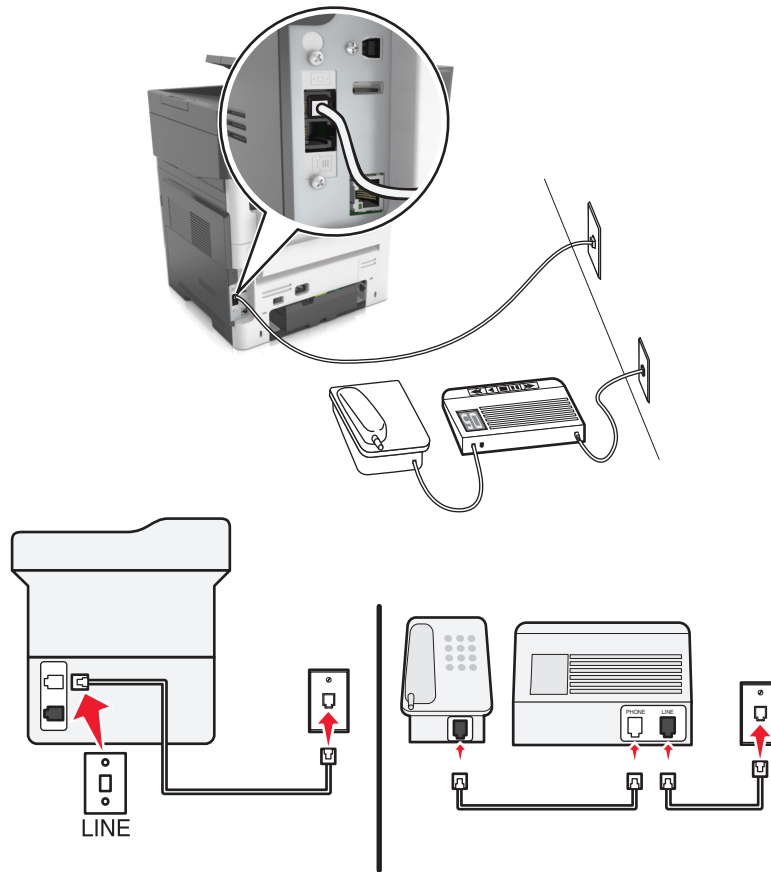

To connect:

- 1 Connect one end of the telephone cable that came with the printer to the  port of the printer.
- 2 Connect the other end of the telephone cable to an active analog wall jack.



Tips for this setup:

- If you have only one telephone number on your line, then you need to set the printer to receive faxes automatically (Auto Answer On).
- Set the printer to pick up calls two rings after the answering machine. For example, if the answering machine picks up calls after four rings, then set the printer to pick up after six rings. This way, the answering machine picks up calls first and your voice calls are received. If the call is a fax, then the printer detects the fax signal on the line and takes over the call.
- If you subscribe to a distinctive ring service provided by your telephone company, then make sure that you set the correct ring pattern for the printer. Otherwise, the printer does not receive faxes even if you have set it to receive faxes automatically.

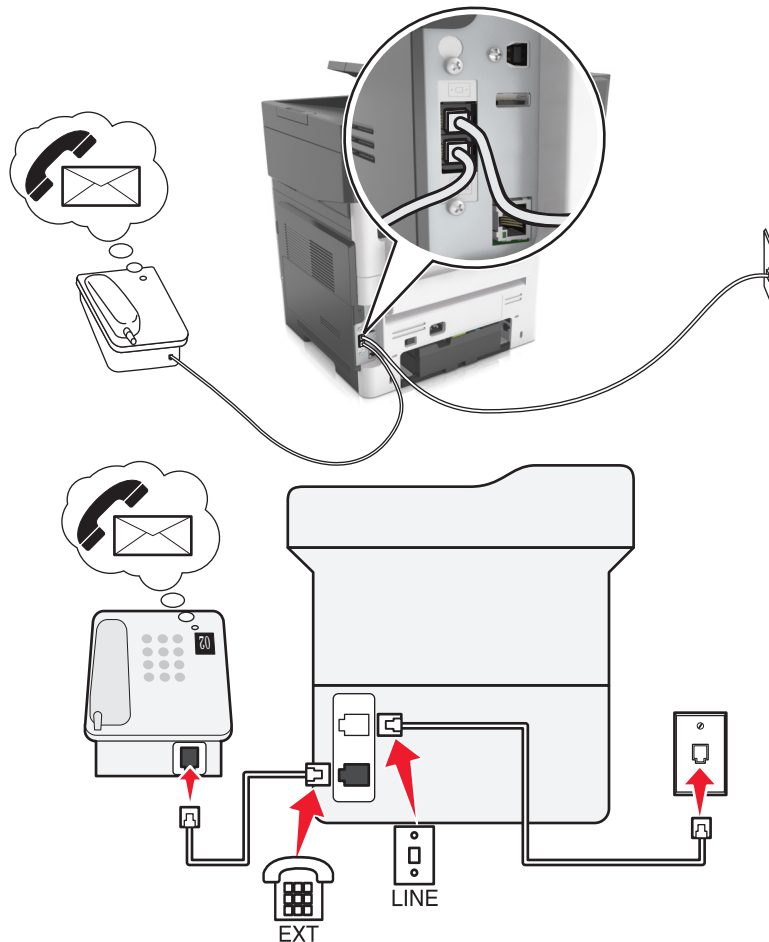
Setup 3: Printer is sharing the line with a telephone subscribed to voice mail service



To connect:

- 1 Connect one end of the telephone cable that came with the printer to the  port of the printer.
- 2 Connect the other end of the telephone cable to an active analog wall jack.
- 3 Connect the telephone to the  port of the printer.

Tips for this setup:

- This setup works best if you subscribe to a distinctive ring service. If you have distinctive ring service, then make sure that you set the correct ring pattern for the printer. Otherwise, the printer does not receive faxes even if you have set it to receive faxes automatically.
- If you have only one telephone number on your line, then you need to set the printer to receive faxes manually (Auto Answer Off).

When you answer the telephone and you hear fax tones, press ***9*** or the manual answer code on the telephone to receive the fax.

- You can also set the printer to receive faxes automatically (Auto Answer On), but you need to turn off the voice mail service when you are expecting a fax. This setting works best if you are using voice mail more often than fax.

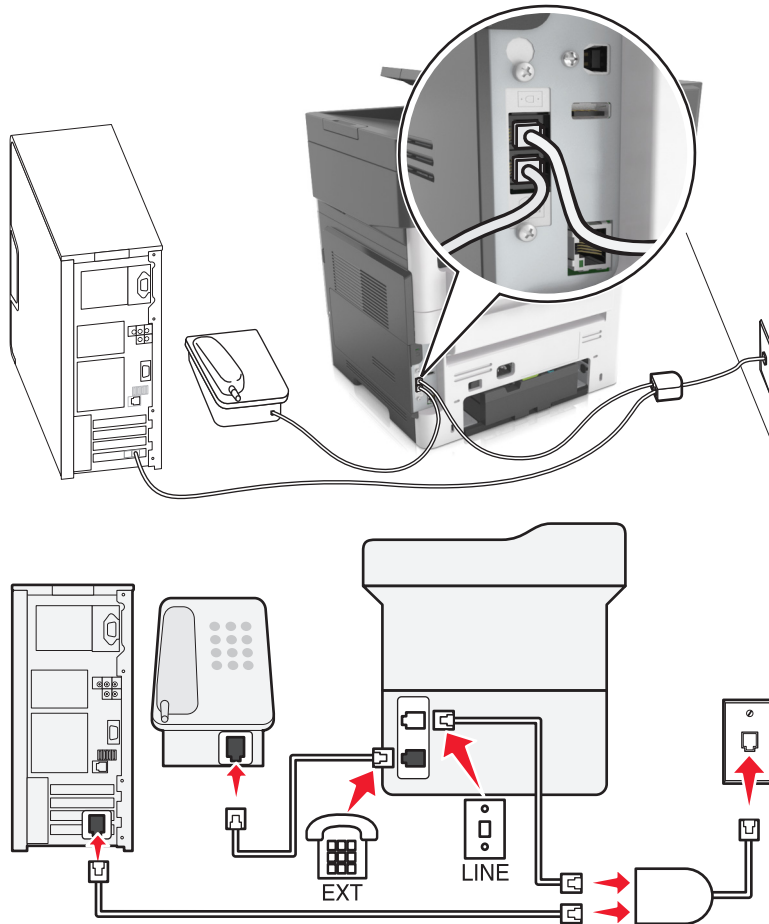

Scenario 2: Digital Subscriber Line (DSL)



A Digital Subscriber Line splits your regular telephone line into two channels: voice and Internet. Telephone and fax signals travel through the voice channel, and Internet signals pass through the other channel. This way, you can use the same line for analog voice calls (including faxes) and digital Internet access.

To minimize interference between the two channels and ensure a quality connection, you need to install a DSL filter for the analog devices (fax machine, telephone, answering machine) in your network. Interference causes noise and static on the telephone, failed and poor quality faxes for the printer, and slow Internet connection on your computer.



To install a filter for the printer:

- 1 Connect the line port of the DSL filter to the wall jack.
- 2 Connect one end of the telephone cable that came with your printer to the  port of the printer. Connect the other end to the phone port on the DSL filter.
- 3 To continue using a computer for Internet access, connect the computer to the DSL HPN port on the DSL filter.
- 4 To connect a telephone to the printer, remove any installed adapter plug from the  port of the printer, and then connect the telephone to the port.

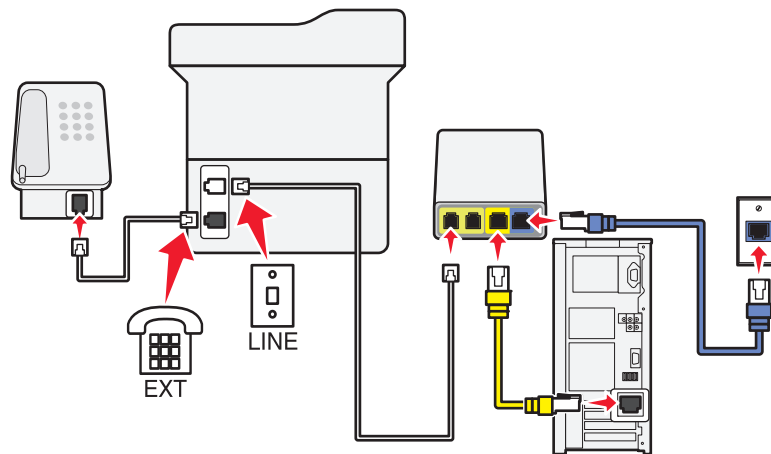
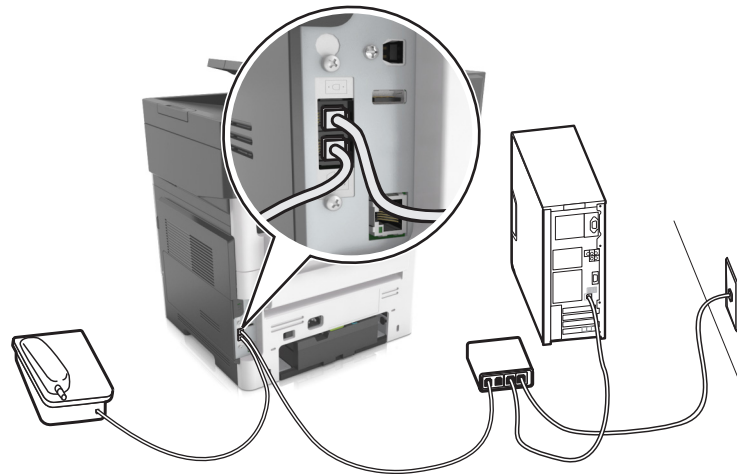
Scenario 3: VoIP telephone service



To connect:

- 1 Connect one end of a telephone cable to the  port of the printer.
- 2 Connect the other end of the cable to the port labeled **Phone Line 1** or **Phone Port** on the VoIP adapter.
The port labeled **Phone Line 2** or **Fax Port** is not always active. You may need to pay extra to your VoIP provider if you want to activate the second phone port.
- 3 Remove the protective plug from the  port of the printer, and then connect the telephone to the port.

Tips for this setup:

- To make sure that the phone port on the VoIP adapter is active, plug an analog telephone into the phone port, and then listen for a dial tone. If you hear a dial tone, then the port is active.
- If you need two phone ports for your devices but do not want to pay extra, then do not plug the printer into the second phone port. You can use a phone splitter. Plug the phone splitter into the **Phone Line 1** or **Phone Port**, and then plug the printer and telephone into the splitter.

Make sure you use a phone splitter, *not* a line splitter. To make sure that you are using the correct splitter, plug an analog telephone into the splitter and then listen for a dial tone.

Scenario 4: Digital telephone service through a cable provider

Setup 1: Printer is connected directly to a cable modem

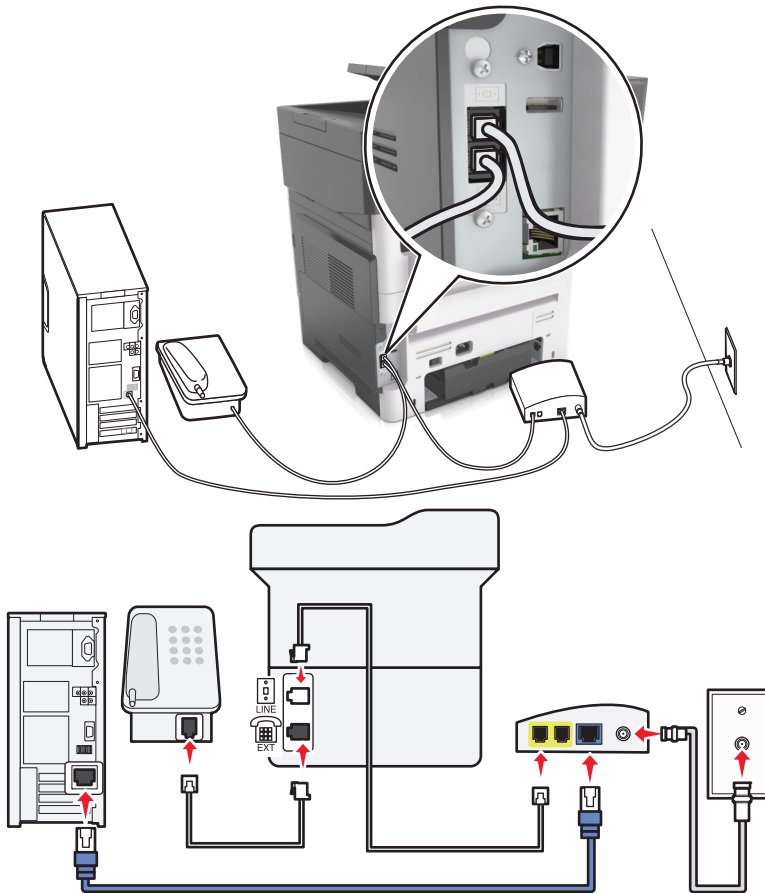

- 1 Connect one end of the telephone cable that came with your printer to the  port of the printer.
- 2 Connect the other end of the cable to the port labeled **Phone Line 1** or **Phone Port** on the cable modem.



Note: The port labeled **Phone Line 2** or **Fax Port** is not always active. VoIP providers may charge additional cost for activation of the second phone port.

- 3 Connect your analog telephone phone to the  port of the printer.

Notes:

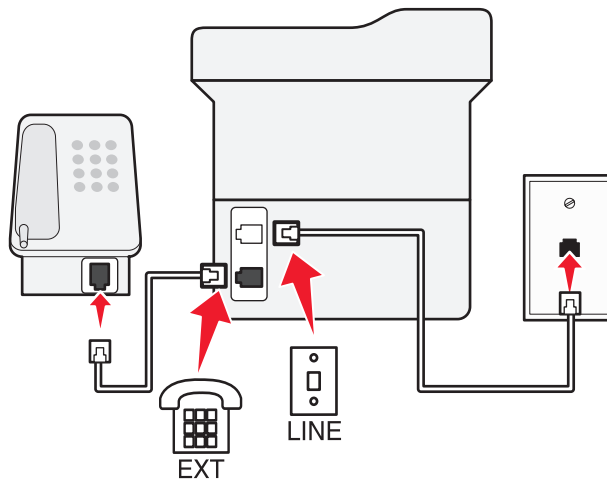
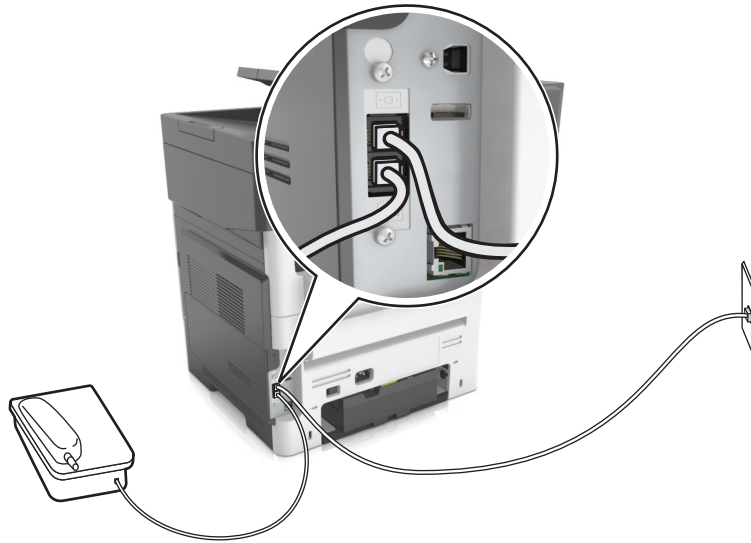
- To make sure that the telephone port on the cable modem is active, plug an analog telephone into the telephone port, and then listen for a dial tone. If you hear a dial tone, then the port is active.
- If you need two telephone ports for your devices, but do not want to pay additional cost, then do not plug the printer into the second telephone port. You can use a phone splitter. Plug the phone splitter into the **Phone Line 1** or **Phone Port**, and then plug the printer and telephone into the splitter.
- Make sure you use a phone splitter, *not* a line splitter. To make sure that you are using the correct splitter, plug an analog telephone into the splitter and then listen for a dial tone.

Setup 2: Printer is connected to a wall jack; cable modem is installed elsewhere in the facility



- 1 Connect one end of the telephone cable that came with your printer to the  port of the printer.
- 2 Connect the other end of the telephone cable to an active analog telephone wall jack.
- 3 Connect your analog telephone to the  port of the printer.

Scenario 5: Countries or regions with different telephone wall jacks and plugs

Some countries or regions may have different types of telephone wall jack connectors than those that came with the printer. The standard wall jack adopted by most countries or regions is RJ-11. Your printer comes with the RJ-11 jack and a telephone cable with the RJ-11 plug.

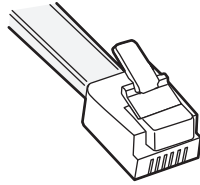
If the wall jack or equipment in your facility is not compatible with this type of connection, then you need to use a telephone adapter. An adapter for your country or region may not come with your printer, and you may need to purchase it separately.



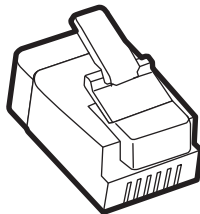

There may be an adapter plug installed in the  port of the printer. If you are using a telephone adapter or a facility that has a cascaded or serial wiring scheme, then do not remove the adapter plug from the  port of the printer.



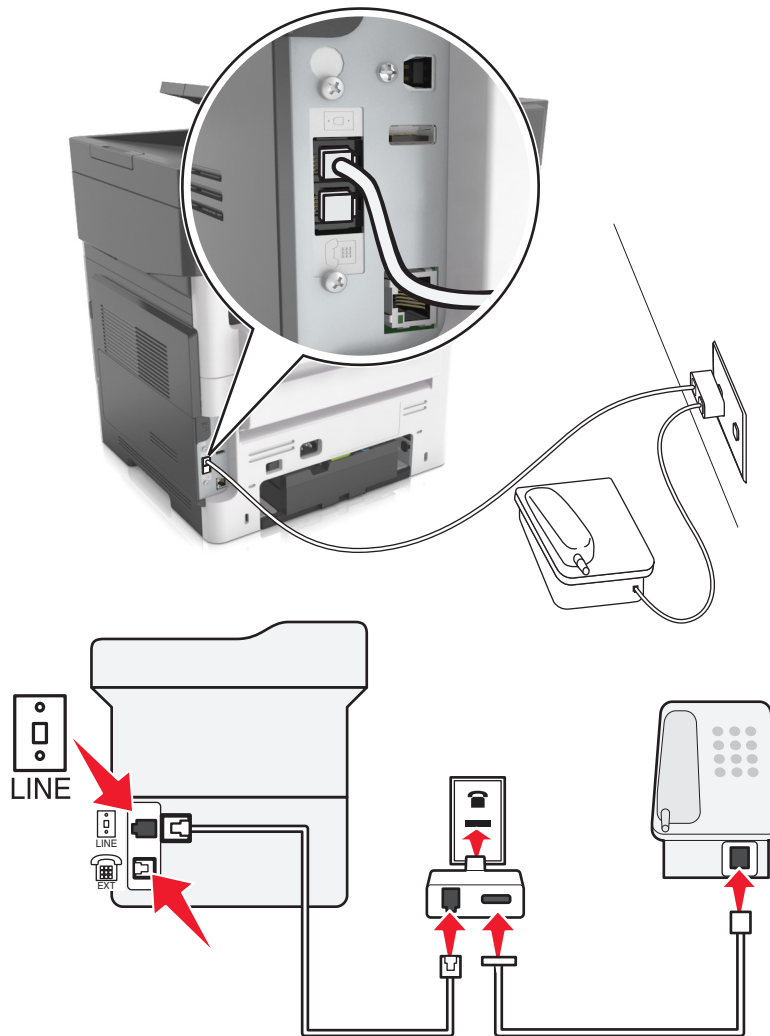

Part name	Part number
Lexmark adapter plug	40X8519

Connecting the printer to a non-RJ-11 wall jack



- 1 Connect one end of the telephone cable that came with printer to the  port of the printer.
- 2 Connect the other end of the cable to the RJ-11 adapter, and then connect the adapter to the wall jack.
- 3 If you want to connect another device (telephone or answering machine) to the same wall jack, and if the device has a non-RJ-11 connector, then connect it directly to the telephone adapter.

Notes:

- The  port of the printer may have an adapter plug for use with the adapter. Do *not* remove the plug from the  port of the printer.
- In some countries or regions, the printer may not come with a telephone adapter or an adapter plug.

Connecting the printer to a wall jack in Germany

The German wall jack has two kinds of ports. The N ports are for fax machines, modems, and answering machines. The F port is for telephones.

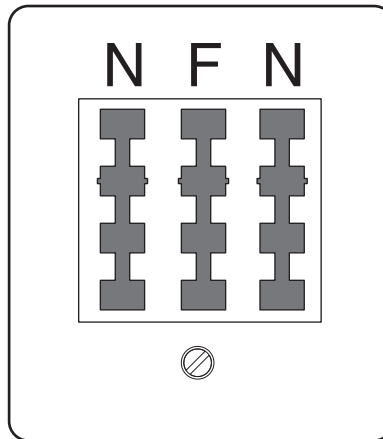

Connect the printer to any of the N ports.

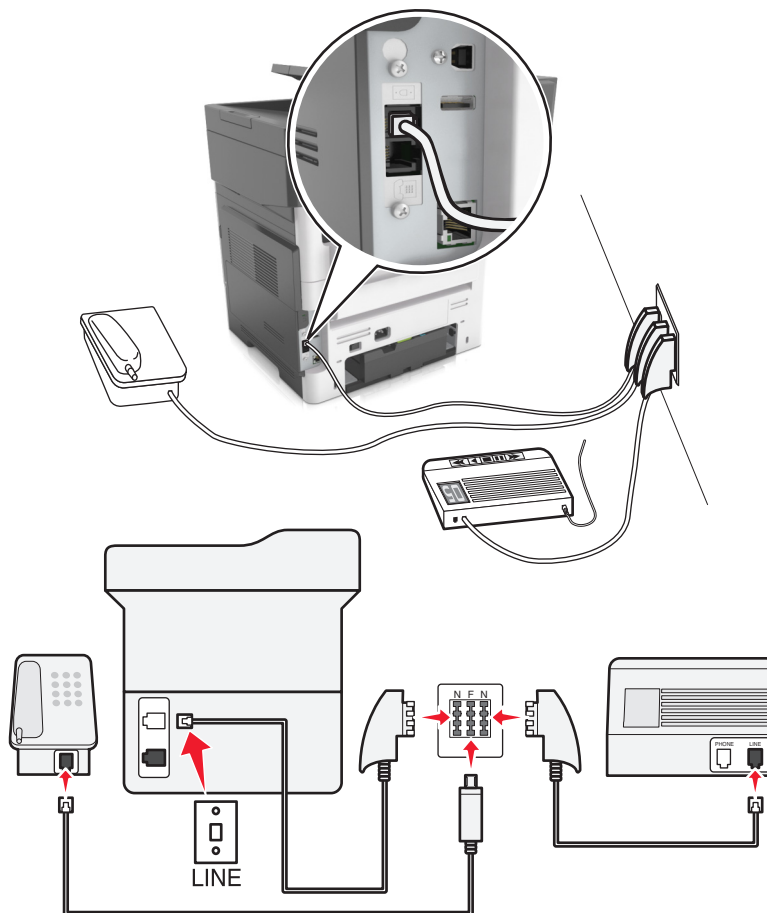

- 1 Connect one end of the telephone cable that came the printer to the  port of the printer.
- 2 Connect the other end of the telephone cable to the RJ-11 adapter, and then connect the adapter to an N port.

- 3 If you want to connect a telephone and answering machine to the same wall jack, then connect the devices as shown.

Note: Do *not* remove the adapter plug from the  port of the printer if you are connecting to a serial or cascaded telephone system.

Connecting to a distinctive ring service

A distinctive ring service may be available from your telephone company. This service lets you have multiple telephone numbers on one telephone line, with each telephone number having a different ring pattern. This may be useful for distinguishing between fax and voice calls. If you subscribe to a distinctive ring service, then follow these steps to connect the equipment:

- 1 Connect one end of the telephone cable that came with the printer to the printer LINE port .
- 2 Connect the other end of the telephone cable to an active analog telephone wall jack.

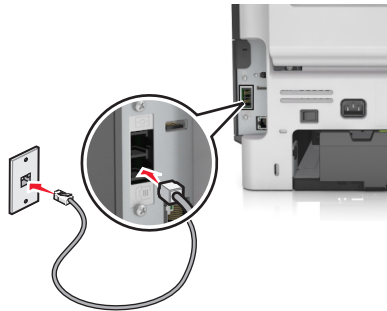

- 3 Change the distinctive rings setting to match the setting you want for the printer to answer.

Note: The factory default setting for distinctive rings is On. This sets the printer to answer single, double, and triple ring patterns.

- a From the home screen, navigate to:

 > **Settings** > **Fax Settings** > **Analog Fax Setup** > **Answer On**

- b Select the pattern setting you want to change, and then touch .

Setting the outgoing fax name and number

- 1 Open a Web browser, and then type the printer IP address in the address field.

Notes:

- View the printer IP address on the printer home screen. The IP address appears as four sets of numbers separated by periods, such as 123.123.123.123.
- If you are using a proxy server, then temporarily disable it to load the Web page correctly.

- 2 Click **Settings** > **Fax Settings** > **Analog Fax Setup**.
- 3 In the Fax Name field, type the name to be printed on all outgoing faxes.
- 4 In the Fax Number field, enter the printer fax number.
- 5 Click **Submit**.

Setting the date and time

You can set the date and time so that they are printed on every fax you send.

- 1 Open a Web browser, and then type the printer IP address in the address field.

Notes:

- View the printer IP address on the printer home screen. The IP address appears as four sets of numbers separated by periods, such as 123.123.123.123.
- If you are using a proxy server, then temporarily disable it to load the Web page correctly.

- 2 Click **Security > Set Date and Time**.

- 3 In the Manually Set Date & Time field, enter the current date and time.

- 4 Click **Submit**.

Note: It is recommended to use the network time.

Configuring the printer to observe daylight saving time

The printer can be set to automatically adjust for daylight saving time:

- 1 Open a Web browser, and then type the printer IP address in the address field.

Notes:

- View the printer IP address on the printer home screen. The IP address appears as four sets of numbers separated by periods, such as 123.123.123.123.
- If you are using a proxy server, then temporarily disable it to load the Web page correctly.

- 2 Click **Security > Set Date and Time**.

- 3 Select the **Automatically Observe DST** check box, and then enter the DST start and end dates in the Custom Time Zone Setup section.

- 4 Click **Submit**.

Sending a fax

You can use the printer to send a fax to one or more recipients in a number of ways. You can type the e-mail address, use a shortcut number, or use the address book. You can also use the Multi Send or MyShortcut application from the printer home screen. For more information, see “Activating the home screen applications” on page 22.

Sending a fax using the printer control panel

- 1 Load an original document faceup, short edge first into the ADF tray or facedown on the scanner glass.

Notes:

- Do not load postcards, photos, small items, transparencies, photo paper, or thin media (such as magazine clippings) into the ADF tray. Place these items on the scanner glass.
- The ADF indicator light comes on when the paper is loaded properly.

- 2 If you are loading a document into the ADF tray, then adjust the paper guides.

3 From the home screen, touch **Fax**.

4 Enter the fax number or a shortcut.

Note: To add recipients, touch **Next number**, and then enter the recipient's telephone number or shortcut number, or search the address book.

5 Touch **Fax It**.

Sending a fax using the computer

The printer driver fax option lets you send a print job to the printer, which sends the job as a fax. The fax option works as a normal fax machine, but is controlled through the printer driver instead of the printer control panel.

1 With a document open, click **File > Print**.

2 Select the printer, and then click **Properties, Preferences, Options, or Setup**.

3 Navigate to:

Fax tab > Enable fax

4 Enter the recipient fax number or numbers in the "Fax number(s)" field.

Note: Fax numbers can be entered manually or by using the Phone Book feature

5 If necessary, enter a prefix in the "Dialing prefix" field.

6 Select the appropriate paper size and page orientation.

7 If you want to include a cover page with the fax, then select **Include cover page with fax**, and then enter the appropriate information.

8 Click **OK**.

Notes:

- The Fax option is available for use only with the PostScript driver or the Universal Fax Driver. For information on installing these drivers, see the *Software and Documentation CD*.
- The Fax option must be configured and enabled in the PostScript driver under the Configuration tab before it can be used.
- If the **Always display settings prior to faxing** check box is selected, then you are prompted to verify the recipient information before the fax is sent. If this check box is cleared, then the queued document is sent automatically as a fax when you click **OK** on the Fax tab.

Sending a fax using a shortcut number

Fax shortcuts are like the speed dial numbers on a telephone or a fax machine. A shortcut number (1–999) can contain a single recipient or multiple recipients.

1 Load an original document faceup, short edge first into the ADF tray or facedown on the scanner glass.

Notes:

- Do not load postcards, photos, small items, transparencies, photo paper, or thin media (such as magazine clippings) into the ADF tray. Place these items on the scanner glass.

- The ADF indicator light comes on when the paper is loaded properly.
- 2 If you are loading a document into the ADF tray, then adjust the paper guides.
 - 3 From the printer control panel, press #, and then enter the shortcut number using the keypad.
 - 4 Touch **Fax It**.

Sending a fax using the address book

The address book lets you search for bookmarks and network directory servers. For more information on enabling the address book feature, contact your system support person.

- 1 Load an original document faceup, short edge first into the ADF tray or facedown on the scanner glass.

Notes:

- Do not load postcards, photos, small items, transparencies, photo paper, or thin media (such as magazine clippings) into the ADF tray. Place these items on the scanner glass.
 - The ADF indicator light comes on when the paper is loaded properly.
- 2 If you are loading a document into the ADF tray, then adjust the paper guides.
 - 3 From the home screen, navigate to:

Fax >  > type the name of the recipient > **Search**

Note: You can search only for one name at a time.

- 4 Touch the name of the recipient, and then touch **Fax It**.

Sending a fax at a scheduled time

- 1 Load an original document faceup, short edge first into the ADF tray or facedown on the scanner glass.

Notes:

- Do not load postcards, photos, small items, transparencies, photo paper, or thin media (such as magazine clippings) into the ADF tray. Place these items on the scanner glass.
 - The ADF indicator light comes on when the paper is loaded properly.
- 2 If you are loading a document into the ADF tray, then adjust the paper guides.
 - 3 From the home screen, navigate to:

Fax > enter the fax number > **Delayed Send**

Note: If Fax Mode is set to Fax Server, then the Delayed Send button will not appear. Faxes waiting for transmission are listed in the fax queue.

- 4 Specify the time the fax will be transmitted, and then touch .

The time is increased or decreased in 30-minute increments.

- 5 Touch **Fax It**.

Note: The document is scanned and then faxed at the scheduled time.

Creating shortcuts

Creating a fax destination shortcut using the Embedded Web Server

Assign a shortcut number to a single fax number or a group of fax numbers.

- 1 Open a Web browser, and then type the printer IP address in the address field.

Notes:

- View the printer IP address on the printer home screen. The IP address appears as four sets of numbers separated by periods, such as 123.123.123.123.
- If you are using a proxy server, then temporarily disable it to load the Web page correctly.

- 2 Click **Settings > Manage Shortcuts > Fax Shortcut Setup**.

Note: A password may be required. If you do not have an ID and password, then contact your system support person.

- 3 Type a name for the shortcut, and then enter the fax number.

Notes:

- To create a multiple-number shortcut, enter the fax numbers for the group.
- Separate each fax number in the group with a semicolon (;).

- 4 Assign a shortcut number.

Note: If you enter a number that is already in use, then you are prompted to select another number.

- 5 Click **Add**.

Creating a fax destination shortcut using the printer control panel

- 1 From the home screen, touch **Fax**, and then enter the fax number.

Note: To create a group of fax numbers, touch **Next number**, and then enter the next fax number.

- 2 Touch .

- 3 Type a unique name for the shortcut, and then touch **Done**.

- 4 Verify that the shortcut name and number are correct, and then touch **OK**.

Note: If the name or number is incorrect, then touch **Cancel**, and then reenter the information.

Customizing fax settings

Changing the fax resolution

- 1 Load an original document faceup, short edge first into the ADF tray or facedown on the scanner glass.

Notes:

- Do not load postcards, photos, small items, transparencies, photo paper, or thin media (such as magazine clippings) into the ADF tray. Place these items on the scanner glass.
- The ADF indicator light comes on when the paper is loaded properly.

2 If you are loading a document into the ADF tray, then adjust the paper guides.

3 From the home screen, navigate to:

Fax > enter the fax number > **Options**

4 From the Resolution area, touch the arrows to select the resolution you want.

Note: Select a resolution from Standard (fastest speed) to Ultra Fine (best quality at a reduced speed).

5 Touch **Fax It**.

Making a fax lighter or darker

1 Load an original document faceup, short edge first into the ADF tray or facedown on the scanner glass.

Notes:

- Do not load postcards, photos, small items, transparencies, photo paper, or thin media (such as magazine clippings) into the ADF tray. Place these items on the scanner glass.
- The ADF indicator light comes on when the paper is loaded properly.

2 If you are loading a document into the ADF tray, then adjust the paper guides.

3 From the home screen, navigate to:

Fax > enter the fax number > **Options**

4 Adjust the fax darkness, and then touch **Fax It**.

Viewing a fax log

1 Open a Web browser, and then type the printer IP address in the address field.

Notes:

- View the printer IP address on the printer home screen. The IP address appears as four sets of numbers separated by periods, such as 123.123.123.123.
- If you are using a proxy server, then temporarily disable it to load the Web page correctly.

2 Click **Settings** > **Reports**.

3 Click **Fax Job Log** or **Fax Call Log**.

Blocking junk faxes

1 Open a Web browser, and then type the printer IP address in the address field.

Notes:

- View the printer IP address on the printer home screen. The IP address appears as four sets of numbers separated by periods, such as 123.123.123.123.

- If you are using a proxy server, then temporarily disable it to load the Web page correctly.

2 Click **Settings > Fax Settings > Analog Fax Setup > Block No Name Fax**.

Notes:

- This option blocks all incoming faxes that have a private caller ID or have no fax name.
- In the Banned Fax List field, enter the phone numbers or type the fax names of specific fax callers you want to block.

Canceling an outgoing fax

Canceling a fax while the original documents are still scanning

- When using the ADF, touch **Cancel Job** on the printer control panel while **Scanning** appears.
- When using the scanner glass, touch **Cancel Job** on the printer control panel while **Scanning** appears or while **Scan the Next Page** and **Finish the Job** appear.

Canceling a fax after the original documents have been scanned to memory

1 On the home screen, touch **Cancel Jobs**.

The Cancel Jobs screen appears.

2 Touch the job or jobs you want to cancel.

Only three jobs appear on the screen; touch the down arrow until the job you want appears, and then touch the job you want to cancel.

3 Touch **Delete Selected Jobs**.

The Deleting Selected Jobs screen appears, the selected jobs are deleted, and then the home screen appears.

Holding and forwarding faxes

Holding faxes

This option lets you hold received faxes from printing until they are released. Held faxes can be released manually or at a scheduled day or time.

1 Open a Web browser, and then type the printer IP address in the address field.

Notes:

- View the printer IP address on the printer home screen. The IP address appears as four sets of numbers separated by periods, such as 123.123.123.123.
- If you are using a proxy server, then temporarily disable it to load the Web page correctly.

2 Click **Settings > Fax Settings > Analog Fax Setup > Holding Faxes**.

- 3 From the Held Fax Mode menu, select one of the following:
 - **Off**
 - **Always On**
 - **Manual**
 - **Scheduled**
- 4 If you selected Scheduled, then continue with the following steps:
 - a Click **Fax Holding Schedule**.
 - b From the Action menu, select **Hold faxes**.
 - c From the Time menu, select the time you want the held faxes released.
 - d From the Day(s) menu, select the day you want the held faxes released.
- 5 Click **Add**.

Forwarding a fax

This option lets you print and forward received faxes to a fax number, e-mail address, FTP site, or LDSS.

- 1 Open a Web browser, and then type the printer IP address in the address field.

Notes:

- View the printer IP address on the printer home screen. The IP address appears as four sets of numbers separated by periods, such as 123.123.123.123.
- If you are using a proxy server, then temporarily disable it to load the Web page correctly.

- 2 Click **Settings > Fax Settings**.
- 3 From the Fax Forwarding menu, select **Print**, **Print and Forward**, or **Forward**.
- 4 From the “Forward to” menu, select **Fax**, **E-mail**, **FTP**, **LDSS**, or **eSF**.
- 5 In the “Forward to Shortcut” field, enter the shortcut number where you want the fax forwarded.

Note: The shortcut number must be valid for the setting selected in the “Forward to” menu.
- 6 Click **Submit**.

Understanding the fax options

Content

This option lets you specify the content type and source of the original document.

Select from the following content types:

- **Text**—The content of the original document is mostly text or line art.
- **Text/Photo**—The original document is a mixture of text, graphics, and photos.
- **Photo**—The original document is mostly a photo or an image.
- **Graphics**—The original document is mostly business-type graphics, such as pie charts, bar charts, and animations.

Select from the following content sources:

- **Color Laser**—The original document was printed using a color laser printer.
- **Inkjet**—The original document was printed using an inkjet printer.
- **Magazine**—The original document is from a magazine.
- **Brochure**—The original document is from a brochure.
- **Black/White Laser**—The original document was printed using a mono laser printer.
- **Photo/Film**—The original document is a photo from film.
- **Newspaper**—The original document is from a newspaper.
- **Other**—The original document was printed using an alternate or unknown printer.

Resolution

This option lets you adjust the quality of the fax output. Increasing the image resolution increases the file size and the time needed to scan your original document. Decreasing the image resolution reduces the file size.

Select one of the following:

- **Standard**—Use this when faxing most documents.
- **Fine 200 dpi**—Use this when faxing documents with small prints.
- **Super fine 300 dpi**—Use this when faxing documents with fine details.
- **Ultra fine 600 dpi**—Use this when faxing documents with pictures or photos.

Darkness

This option lets you adjust how light or dark the faxes are in relation to the original document.

Delayed Send

This option lets you send a fax at a later time or date.

Page Setup

This option lets you change the following settings:

- **Sides (Duplex)**—This specifies if the original document is printed on one side or on both sides of the page (duplex). This also identifies what needs to be scanned for inclusion in the fax.
- **Orientation**—This specifies the orientation of the original document, and then changes the Sides (Duplex) and Binding settings to match the orientation.
- **Binding**—This specifies if the original document is bound on the long-edge or short-edge side.

Scan Preview

This option lets you view the first page of the image before it is included in the fax. When the first page is scanned, the scanning is paused and a preview image appears.

Note: This option appears only when a working printer hard disk is installed.

Using the advanced options

Select from the following settings:

- **Advanced Imaging**—This adjusts the Background Removal, Color Balance, Color Dropout, Contrast, Mirror Image, Negative Image, Scan Edge to Edge, Shadow Detail, and Sharpness settings before you fax the document.
- **Custom Job**—This combines multiple scanning jobs into a single job.
- **Edge Erase**—This removes smudges or marks around the edges of a document. You can choose to remove an equal area around all four sides of the paper, or pick a particular edge. Edge Erase erases whatever is within the area selected, leaving nothing on that portion of the scan.
- **Transmission Log**—This prints the transmission log or transmission error log.
- **Adjust ADF Skew**—This straightens scanned images that are slightly skewed when received from the ADF tray.

Note: This option is supported only in select printer models.

Scanning

You can use the printer to send a file to an FTP address. You can type the e-mail address, use a shortcut number, or use the address book. You can also use the Multi-send or MyShortcut application from the printer home screen. For more information, see “Activating the home screen applications” on page 22.

Using Scan to Network

Scan to Network lets you scan your documents to network destinations specified by your system support person. After the destinations (shared network folders) have been established on the network, the setup process for the application involves installing and configuring the application on the appropriate printer using its Embedded Web Server. For more information, see “Setting up Scan to Network” on page 25.

Scanning to an FTP address

Creating shortcuts

Instead of entering the entire FTP site address on the printer control panel each time you want to send a document to an FTP server, you can create a permanent FTP destination and assign a shortcut number. There are two methods for creating shortcut numbers: using the Embedded Web Server and using the printer control panel.

Creating an FTP shortcut using the Embedded Web Server

- 1 Open a Web browser, and then type the printer IP address in the address field.

Notes:

- View the printer IP address on the printer home screen. The IP address appears as four sets of numbers separated by periods, such as 123.123.123.123.
- If you are using a proxy server, then temporarily disable it to load the Web page correctly.

- 2 Navigate to:

Settings > Other Settings area > Manage Shortcuts > FTP Shortcut Setup

- 3 Enter the appropriate information.

Note: A password may be required. If you do not have an ID and password, then contact your system support person.

- 4 Enter a shortcut number.

Note: If you enter a number that is already in use, then you are prompted to select another number.

- 5 Click **Add**.

Creating an FTP shortcut using the printer control panel

1 From the home screen, navigate to:

FTP > FTP > type the FTP address >  > type a name for the shortcut > Done

2 Verify that the shortcut name and number are correct, and then touch **OK**.

Notes:

- If the name or number is incorrect, then touch **Cancel**, and then reenter the information.
- If you enter a number that is already in use, then you are prompted to select another number.

Scanning to an FTP address

Scanning to an FTP address using the printer control panel

1 Load an original document faceup, short edge first into the ADF tray or facedown on the scanner glass.

Notes:

- Do not load postcards, photos, small items, transparencies, photo paper, or thin media (such as magazine clippings) into the ADF tray. Place these items on the scanner glass.
- The ADF indicator light comes on when the paper is loaded properly.

2 If you are loading a document into the ADF tray, then adjust the paper guides.

3 From the printer control panel, navigate to:

FTP > FTP > type the FTP address > Done > Send It

Scanning to an FTP address using a shortcut number

1 Load an original document faceup, short edge first into the ADF tray or facedown on the scanner glass.

Notes:

- Do not load postcards, photos, small items, transparencies, photo paper, or thin media (such as magazine clippings) into the ADF tray. Place these items on the scanner glass.
- The ADF indicator light comes on when the paper is loaded properly.

2 If you are loading a document into the ADF tray, then adjust the paper guides.

3 From the printer control panel, press **#** on the keypad, and then enter the FTP shortcut number.



4 Touch  > **Send It**.

Scanning an FTP using the address book

1 Load an original document faceup, short edge first into the ADF tray or facedown on the scanner glass.



Notes:

- Do not load postcards, photos, small items, transparencies, photo paper, or thin media (such as magazine clippings) into the ADF tray. Place these items on the scanner glass.

- The ADF indicator light comes on when the paper is loaded properly.
- 2 If you are loading a document into the ADF tray, then adjust the paper guides.
 - 3 From the home screen, navigate to:
FTP > FTP >  > type the name of the recipient > Search
 - 4 Touch the name of the recipient.
Note: To search for additional recipients, touch **New Search**, and then type the name of the next recipient.
 - 5 Touch  > **Send It.**

Scanning to a computer or flash drive

You can use the printer to send a scanned file. You can also use Scan to Network, Multisend, and MyShortcut applications from the printer home screen. For more information, see “Activating the home screen applications” on page 22.

ADF	Scanner glass
	
<p>Use the ADF for multiple-page documents.</p>	<p>Use the scanner glass for single pages, small items (such as postcards or photos), transparencies, photo paper, or thin media (such as magazine clippings).</p>

The scanner lets you scan documents directly to a computer or a flash drive. The computer does not have to be directly connected to the printer for you to receive Scan to PC images. You can scan the document back to the computer over the network by creating a scan profile on the computer and then downloading the profile to the printer.

Scanning to a computer using the Embedded Web Server

- 1 Open a Web browser, and then type the printer IP address in the address field.
Notes:
 - View the printer IP address on the printer home screen. The IP address appears as four sets of numbers separated by periods, such as 123.123.123.123.
 - If you are using a proxy server, then temporarily disable it to load the Web page correctly.
- 2 Click **Scan Profile > Create Scan Profile.**
- 3 Select your scan settings, and then click **Next.**

4 Select a location on your computer where you want to save the scan image.

5 Type a scan name, and then a user name.

Note: The scan name is the name that appears in the Scan Profile list on the display.

6 Click **Submit**.

Note: Clicking **Submit** automatically assigns a shortcut number. You can use this shortcut number when you are ready to scan your documents.

7 Review the instructions on the Scan Profile screen.

a Load an original document faceup, short edge first into the ADF tray or facedown on the scanner glass.

Notes:

- Do not load postcards, photos, small items, transparencies, photo paper, or thin media (such as magazine clippings) into the ADF tray. Place these items on the scanner glass.
- The ADF indicator light comes on when the paper is loaded properly.

b If you are loading a document into the ADF tray, then adjust the paper guides.

c Do either of the following:

- Press #, and then enter the shortcut number using the keypad.
- From the home screen, navigate to:
Held Jobs > Profiles > select your shortcut on the list

Note: The scanner scans and sends the document to the directory you specified.

8 View the file from the computer.

Note: The output file is saved in the location or launched in the program you specified.

Setting up Scan to Computer

Notes:

- This feature is supported only in Windows Vista or later.
- Make sure that your computer and printer are connected to the same network.

1 Open the printers folder.

In Windows 8

From the Search charm, type **run**, and then navigate to:

Apps list > **Run** > type **control printers** > **OK**

In Windows 7 or earlier

- a Click  or click **Start**, and then click **Run**.
- b In the Start Search or Run dialog, type **control printers**.
- c Press **Enter**, or click **OK**.

2 Depending on your operating system, click **Add devices and printers**, **Add a device**, or **Add a printer**.

3 Select your printer from the list.

Note: To identify your printer, print a network setup page, and then look for “Fully Qualified Domain Name” in the TCP/IP section.

4 Click **Next > Close**.

5 Depending on your device, do either of the following:

- Press and hold the printer you want to configure.
- Right-click the printer you want to configure.

6 From the menu that appears, select **Scan Properties** or **Properties**, and then change the settings as necessary.

7 From the printer control panel, touch **Scan to Computer** and then select from the following options:

- **Scan**—Scan and save the document directly to a selected location on the computer.
- **Scan for Print**—Scan and automatically print the document.
- **Scan for E-mail**—Attach a scanned document to an e-mail.
- **Scan for Fax**—Attach a scanned document to be sent through fax.

8 Touch **Send It**.

Remote scan in progress appears on the printer display. The scanned image opens automatically on the computer screen.

Scanning to a flash drive

1 Load an original document faceup, short edge first into the ADF tray or facedown on the scanner glass.

Notes:

- Do not load postcards, photos, small items, transparencies, photo paper, or thin media (such as magazine clippings) into the ADF tray. Place these items on the scanner glass.
- The ADF indicator light comes on when the paper is loaded properly.

2 If you are loading a document into the ADF tray, then adjust the paper guides.

3 Insert the flash drive into the USB port on the front of the printer.

Note: The USB Drive home screen appears.

4 Select the destination folder, and then touch **Scan to USB drive**.

Note: The printer goes back to the home screen after 30 seconds of inactivity.

5 Adjust the scan settings, and then touch **Scan It**.

Using the ScanBack Utility

You can use the Lexmark ScanBack™ Utility instead of the Embedded Web Server to create scan-to-computer profiles. The ScanBack Utility can be downloaded from the Lexmark support Web site at <http://support.lexmark.com>.

1 Set up your scan-to-computer profile:

- a Launch the ScanBack Utility.
- b Select the printer.
If no printers are listed, then contact your system support person, or click **Setup** to manually search for an IP address or host name.
- c Follow the instructions on your computer screen to define the type of document being scanned and what kind of output you want to create.
- d Assign a file name of your scan profile, and then specify a location on your computer.
- e Click **Finish**.
A dialog box appears with your scan profile information and the status of the received images.

Note: You can select **Create Shortcut** to create a shortcut of the scan profile settings to your desktop.

2 Scan your original documents:

- a Load all pages into the ADF or on the scanner glass.
- b From the printer control panel, navigate to:
Held jobs > Profiles and Apps > select your scan profile

Note: Your output file is saved in a directory or launched in the application you specified.

Understanding the scan options

FTP

This option lets you enter the IP address for the FTP destination.

Note: An IP address appears as four sets of numbers separated by periods, such as 123.123.123.123.

File Name

This option lets you type a file name for the scan image.

Save As Shortcut

This option lets you save the current settings as a shortcut by assigning a number.

Original Size

This option lets you set the paper size of the documents you are going to scan. When Original Size is set to Mixed Sizes, you can scan an original document that contains mixed paper sizes (letter- and legal-size pages).

Darkness

This option lets you adjust how light or dark the scanned documents are in relation to the original document.

Resolution

This option lets you adjust the output quality of your file. Increasing the image resolution increases the file size and the time needed to scan your original document. Decreasing the image resolution reduces the file size.

Send As

This option lets you set the output type for the scan image.

Select one of the following:

- **PDF**—Use to create a single file with multiple pages.
- **Secure PDF**—Use to create an encrypted PDF file that protects the file contents from unauthorized access.
- **TIFF**—Use to create multiple files or a single file. If Multi-page TIFF is turned off in the Settings menu, then TIFF saves one page in each file. The file size is usually larger than an equivalent JPEG.
- **JPEG**—Use to create and attach a separate file for each page of the original document.
- **XPS**—Use to create a single XPS file with multiple pages.

Content

This option lets you set the original document type and source.

Select from the following content types:

- **Text**—The content of the original document is mostly text or line art.
- **Text/Photo**—The original document is a mixture of text, graphics, and photos.
- **Photo**—The original document is mostly a photo or an image.
- **Graphics**—The original document is mostly business-type graphics, such as pie charts, bar charts, and animations.

Select from the following content sources:

- **Color Laser**—The original document was printed using a color laser printer.
- **Inkjet**—The original document was printed using an inkjet printer.
- **Magazine**—The original document is from a magazine.
- **Brochure**—The original document is from a brochure.
- **Black/White Laser**—The original document was printed using a mono laser printer.
- **Photo/Film**—The original document is a photo from film.
- **Newspaper**—The original document is from a newspaper.
- **Other**—The original document was printed using an alternate or unknown printer.

Page Setup

This option lets you change the following settings:

- **Sides (Duplex)**—This specifies if the original document is printed on only one side or on both sides of the paper.
- **Orientation**—This specifies the orientation of the original document, and then changes the Sides (Duplex) and Binding settings to match the orientation.
- **Binding**—This specifies if the original document is bound on the long-edge or short-edge side.

Scan Preview

This option lets you view the first page of the image before it is included in the e-mail. When the first page is scanned, the scanning is paused and a preview image appears.

Note: This option appears only when a working printer hard disk is installed.

Using the advanced options

Select from the following settings:

- **Advanced Imaging**—This adjusts the Background Removal, Color Balance, Color Dropout, Contrast, JPEG Quality, Mirror Image, Negative Image, Scan Edge to Edge, Shadow Detail, Sharpness, and Temperature settings before you scan the document.
- **Custom Job**—This combines multiple scanning jobs into a single job.
- **Edge Erase**—This removes smudges or marks around the edges of a document. You can choose to remove an equal area around all four sides of the paper, or pick a particular edge. Edge Erase erases whatever is within the area selected, leaving nothing on that portion of the scan.
- **Transmission Log**—This prints the transmission log or transmission error log.
- **Multifeed Sensor**—This detects when the ADF picks more than one sheet of paper at a time, and then shows an error message.

Note: This option is supported only in select printer models.

Understanding the printer menus

Menus list

Paper Menu

Default Source
 Paper Size/Type
 Configure MP
 Substitute Size
 Paper Texture
 Paper Weight
 Paper Loading
 Custom Types
 Custom Names¹
 Custom Scan Sizes
 Universal Setup

Reports

Menu Settings Page
 Device Statistics
 Stapler Test
 Network Setup Page¹
 Network [x] Setup Page
 Shortcut List
 Fax Job Log
 Fax Call Log
 Copy Shortcuts
 E-mail Shortcuts
 Fax Shortcuts
 FTP Shortcuts
 Profiles List
 Print Fonts
 Print Directory
 Print Demo
 Asset Report

Network/Ports

Active NIC
 Standard Network²
 Standard USB
 Parallel [x]
 Serial [x]
 SMTP Setup

Security

Edit Security Settings
 Miscellaneous Security
 Settings
 Confidential Print Menu
 Erase Temporary Data
 Files
 Security Audit Log
 Set Date and Time

Settings

General Settings
 Copy Settings
 Fax Settings
 E-mail Settings
 FTP Settings
 Flash Drive Menu
 Print Settings

Help

Print All Guides
 Copy Guide
 E-mail Guide
 Fax Guide
 FTP Guide
 Print Defects Guide
 Information Guide
 Supplies Guide

Manage Shortcuts

Fax Shortcuts
 E-mail Shortcuts
 FTP Shortcuts
 Copy Shortcuts
 Profile Shortcuts

Option Card Menu³

A list of installed DLEs
 (Download Emulators)
 appears.

¹ Depending on the printer setup, this menu appears as Network Setup Page or Network [x] Setup Page.

² Depending on the printer setup, this menu appears as Standard Network or Network [x].

³ This menu appears only when one or more DLEs are installed.

Paper menu

Default Source menu

Use	To
Default Source Tray [x] Multipurpose Feeder Manual Paper Manual Envelope	Set a default paper source for all print jobs. Notes: <ul style="list-style-type: none"> • Tray 1 (standard tray) is the factory default setting. • From the Paper menu, set Configure MP to "Cassette" for Multipurpose Feeder to appear as a menu setting. • If two trays contain paper of the same size and type, and the trays have the same settings, then the trays are automatically linked. When one tray is empty, the print job continues using the linked tray.

Paper Size/Type menu

Use	To
Tray [x] Size A4 A5 A6 JIS-B5 Letter Legal Executive Oficio (Mexico) Folio Statement Universal 7 3/4 Envelope 9 Envelope 10 Envelope DL Envelope C5 Envelope B5 Envelope Other Envelope	Specify the paper size loaded in each tray. Notes: <ul style="list-style-type: none"> • Letter is the U.S. factory default setting. A4 is the international factory default setting. • If two trays contain paper of the same size and type, and the trays have the same settings, then the trays are automatically linked. The multipurpose feeder may also be linked. When one tray is empty, the print job continues using the linked tray. • The A6 paper size is supported only in Tray 1 and the multipurpose feeder.
Note: Only installed trays and feeders are listed in this menu.	

Use	To
<p>Tray [x] Type</p> <ul style="list-style-type: none"> Plain Paper Card Stock Transparency Recycled Labels Vinyl Labels Bond Envelope Rough Envelope Letterhead Preprinted Colored Paper Light Paper Heavy Paper Rough/Cotton Custom Type [x] 	<p>Specify the type of paper loaded in each tray.</p> <p>Notes:</p> <ul style="list-style-type: none"> • Plain Paper is the factory default setting for Tray 1. Custom Type [x] is the factory default setting for all other trays. • If available, a user-defined name will appear instead of Custom Type [x]. • Use this menu to configure automatic tray linking.
<p>Multipurpose Feeder Size</p> <ul style="list-style-type: none"> A4 A5 A6 JIS B5 Letter Legal Executive Oficio (Mexico) Folio Statement Universal 7 3/4 Envelope 9 Envelope 10 Envelope DL Envelope C5 Envelope B5 Envelope Other Envelope 	<p>Specify the paper size loaded in the multipurpose feeder.</p> <p>Notes:</p> <ul style="list-style-type: none"> • Letter is the U.S. factory default setting. A4 is the international factory default setting. • From the Paper menu, set Configure MP to “Cassette” for Multipurpose Feeder Size to appear as a menu. • The multipurpose feeder does not automatically detect paper size. Make sure to set the paper size value.
<p>Note: Only installed trays and feeders are listed in this menu.</p>	

Use	To
<p>Multipurpose Feeder Type</p> <ul style="list-style-type: none"> Plain Paper Card Stock Transparency Recycled Labels Vinyl Labels Bond Envelope Rough Envelope Letterhead Preprinted Colored Paper Light Paper Heavy Paper Rough/Cotton Custom Type [x] 	<p>Specify the paper type loaded in the multipurpose feeder.</p> <p>Notes:</p> <ul style="list-style-type: none"> • Plain Paper is the factory default setting. • From the Paper menu, set Configure to “Cassette” for Multipurpose Feeder Type to appear as a menu.
<p>Manual Paper Size</p> <ul style="list-style-type: none"> A4 A5 A6 JIS B5 Letter Legal Executive Oficio (Mexico) Folio Statement Universal 	<p>Specify the size of the paper being manually loaded.</p> <p>Note: Letter is the U.S. factory default setting. A4 is the international factory default setting.</p>
<p>Note: Only installed trays and feeders are listed in this menu.</p>	

Use	To
<p>Manual Paper Type</p> <ul style="list-style-type: none"> Plain Paper Card Stock Transparency Recycled Labels Vinyl Labels Bond Letterhead Preprinted Colored Paper Light Paper Heavy Paper Rough/Cotton Custom Type [x] 	<p>Specify the paper type being manually loaded.</p> <p>Notes:</p> <ul style="list-style-type: none"> • Plain Paper is the factory default setting. • From the Paper menu, set Configure MP to “Manual” for Manual Paper Type to appear as a menu.
<p>Manual Envelope Size</p> <ul style="list-style-type: none"> 7 3/4 Envelope 9 Envelope 10 Envelope DL Envelope C5 Envelope B5 Envelope Other Envelope 	<p>Specify the envelope size being manually loaded.</p> <p>Note: 10 Envelope is the U.S. factory default setting. DL Envelope is the international factory default setting.</p>
<p>Manual Envelope Type</p> <ul style="list-style-type: none"> Envelope Rough Envelope Custom Type [x] 	<p>Specify the envelope type being manually loaded.</p> <p>Note: Envelope is the factory default setting.</p>
<p>Note: Only installed trays and feeders are listed in this menu.</p>	

Configure MP menu

Use	To
<p>Configure MP</p> <ul style="list-style-type: none"> Cassette Manual First 	<p>Determine when the printer selects paper from the multipurpose feeder.</p> <p>Notes:</p> <ul style="list-style-type: none"> • Cassette is the factory default setting. Cassette configures the multipurpose feeder as the automatic paper source. • Manual sets the multipurpose feeder only for manual-feed print jobs. • First configures the multipurpose feeder as the primary paper source.

Substitute Size menu

Use	To
Substitute Size Off Statement/A5 Letter/A4 All Listed	Substitute a specified paper size if the requested paper size is not available. Notes: <ul style="list-style-type: none"> • All Listed is the factory default setting. All available substitutions are allowed. • Off indicates no size substitutions are allowed. • Setting a substitution lets the job print without a Change Paper message appearing.

Paper Texture menu

Use	To
Plain Texture Smooth Normal Rough	Specify the relative texture of the plain paper loaded. Note: Normal is the factory default setting.
Card Stock Texture Smooth Normal Rough	Specify the relative texture of the card stock loaded. Notes: <ul style="list-style-type: none"> • Normal is the factory default setting. • The options appear only if card stock is supported.
Transparency Texture Smooth Normal Rough	Specify the relative texture of the transparencies loaded. Note: Normal is the factory default setting.
Recycled Texture Smooth Normal Rough	Specify the relative texture of the recycled paper loaded. Note: Normal is the factory default setting.
Labels Texture Smooth Normal Rough	Specify the relative texture of the labels loaded. Note: Normal is the factory default setting.
Bond Texture Smooth Normal Rough	Specify the relative texture of the bond paper loaded. Note: Rough is the factory default setting.
Envelope Texture Smooth Normal Rough	Specify the relative texture of the envelopes loaded. Note: Normal is the factory default setting.

Use	To
Rough Envelope Texture Rough	Specify the relative texture of the rough envelopes loaded.
Letterhead Texture Smooth Normal Rough	Specify the relative texture of the letterhead loaded. Note: Normal is the factory default setting.
Preprinted Texture Smooth Normal Rough	Specify the relative texture of the preprinted paper loaded. Note: Normal is the factory default setting.
Colored Texture Smooth Normal Rough	Specify the relative texture of the colored paper loaded. Note: Normal is the factory default setting.
Light Texture Smooth Normal Rough	Specify the relative texture of the paper loaded. Note: Normal is the factory default setting.
Heavy Texture Smooth Normal Rough	Specify the relative texture of the paper loaded. Note: Normal is the factory default setting.
Rough/Cotton Texture Rough	Specify the relative texture of the cotton paper loaded.
Custom [x] Texture Smooth Normal Rough	Specify the relative texture of the custom paper loaded. Notes: <ul style="list-style-type: none"> • Normal is the factory default setting. • The options appear only if the custom type is supported.

Paper Weight menu

Use	To
Plain Weight Light Normal Heavy	Specify the relative weight of the plain paper loaded. Note: Normal is the factory default setting.
Card Stock Weight Light Normal Heavy	Specify the relative weight of the card stock loaded. Note: Normal is the factory default setting.

Use	To
Transparency Weight Light Normal Heavy	Specify the relative weight of the transparencies loaded. Note: Normal is the factory default setting.
Recycled Weight Light Normal Heavy	Specify the relative weight of the recycled paper loaded. Note: Normal is the factory default setting.
Labels Weight Light Normal Heavy	Specify the relative weight of the labels loaded. Note: Normal is the factory default setting.
Bond Weight Light Normal Heavy	Specify the relative weight of the bond paper loaded. Note: Normal is the factory default setting.
Envelope Weight Light Normal Heavy	Specify the relative weight of the envelope loaded. Note: Normal is the factory default setting.
Rough Envelope Weight Light Normal Heavy	Specify the relative weight of the rough envelope loaded. Note: Normal is the factory default setting.
Letterhead Weight Light Normal Heavy	Specify the relative weight of the letterhead loaded. Note: Normal is the factory default setting.
Preprinted Weight Light Normal Heavy	Specify the relative weight of the preprinted paper loaded. Note: Normal is the factory default setting.
Colored Weight Light Normal Heavy	Specify the relative weight of the colored paper loaded. Note: Normal is the factory default setting.
Light Weight Light	Specify that the relative weight of the paper loaded is light.
Heavy Weight Heavy	Specify the relative weight of the paper loaded is heavy.

Use	To
Rough/Cotton Weight Light Normal Heavy	Specify the relative weight of the cotton or rough paper loaded. Note: Normal is the factory default setting.
Custom [x] Weight Light Normal Heavy	Specify the relative weight of the custom paper loaded. Notes: <ul style="list-style-type: none"> • Normal is the factory default setting. • The options appear only when the custom type is supported.

Paper Loading menu

Use	To
Card Stock Loading Duplex Off	Determine and set two-sided printing for all print jobs that specify Card Stock as the paper type.
Recycled Loading Duplex Off	Determine and set two-sided printing for all print jobs that specify Recycled as the paper type.
Labels Loading Duplex Off	Determine and set two-sided printing for all print jobs that specify Labels as the paper type.
Bond Loading Duplex Off	Determine and set two-sided printing for all print jobs that specify Bond as the paper type.
Letterhead Loading Duplex Off	Determine and set two-sided printing for all print jobs that specify Letterhead as the paper type.
Preprinted Loading Duplex Off	Determine and set two-sided printing for all print jobs that specify Preprinted as the paper type.
Colored Loading Duplex Off	Determine and set two-sided printing for all print jobs that specify Colored as the paper type.
Light Loading Duplex Off	Determine and set two-sided printing for all print jobs that specify Light as the paper type.
Notes: <ul style="list-style-type: none"> • Off is the factory default setting for all Paper Loading menu selections. • Duplex sets the printer default to two-sided printing for every print job unless one-sided printing is selected from Print Preferences in Windows or the Print dialog in Macintosh. 	

Use	To
Heavy Loading Duplex Off	Determine and set two-sided printing for all print jobs that specify Heavy as the paper type.
Rough/Cotton Loading Duplex Off	Determine and set two-sided printing for all print jobs that specify Rough or Cotton as the paper type.
Custom [x] Loading Duplex Off	Determine and set two-sided printing for all print jobs that specify Custom [x] as the paper type. Note: Custom [x] Loading appears only when the custom type is supported.
Notes: <ul style="list-style-type: none"> • Off is the factory default setting for all Paper Loading menu selections. • Duplex sets the printer default to two-sided printing for every print job unless one-sided printing is selected from Print Preferences in Windows or the Print dialog in Macintosh. 	

Custom Types menu

Use	To
Custom Type [x] Paper Card Stock Transparency Rough/Cotton Labels Envelope	Associate a paper or specialty media type with a factory default custom type name or a user-defined custom name created from the Embedded Web Server or from MarkVision™ Professional.
Recycled Paper Card Stock Transparency Rough/Cotton Labels Envelope	Specify a paper type when Recycled is selected in other menus.
Notes: <ul style="list-style-type: none"> • Paper is the factory default setting. • The custom media type must be supported by the selected tray or multipurpose feeder to print from that source. 	

Custom Names menu

Use	To
Custom Name [x]	Specify a custom name for a paper type. This name replaces Custom Type [x] in the printer menus.

Custom Scan Sizes menu

Use	To
Custom Scan Size [x] Scan Size Name Width Height Orientation Portrait Landscape 2 scans per side Off On	Specify a custom scan size name and page orientation. Notes: <ul style="list-style-type: none"> • The custom scan size name replaces Custom Scan Size [x] in the printer menus. • ADF Media Type is the factory default setting for custom scan sizes 3, 4, 5, and 6. • 8.5 inches is the U.S. factory default setting for Width. 210 millimeters is the international factory default setting for Width. • 14 inches is the U.S. factory default setting for Height. 297 millimeters is the international factory default setting for Height. • Portrait is the factory default setting for Orientation. • Off is the factory default setting for “2 scans per side.”

Universal Setup menu

Use	To
Units of Measure Inches Millimeters	Identify the units of measure. Notes: <ul style="list-style-type: none"> • Inches is the U.S. factory default setting. • Millimeters is the international factory default setting.
Portrait Width 3–14.17 inches 76–360 mm	Set the portrait width. Notes: <ul style="list-style-type: none"> • If the width exceeds the maximum, then the printer uses the maximum width allowed. • 8.5 inches is the U.S. factory default setting. You can increase the width in 0.01-inch increments. • 216 mm is the international factory default setting. You can increase the width in 1-mm increments.
Portrait Height 3–14.17 inches 76–360 mm	Set the portrait height. Notes: <ul style="list-style-type: none"> • If the height exceeds the maximum, then the printer uses the maximum height allowed. • 14 inches is the U.S. factory default setting. You can increase the height in 0.01-inch increments. • 356 mm is the international factory default setting. You can increase the height in 1-mm increments.

Use	To
Feed Direction Short Edge Long Edge	Specify the feed direction if the paper can be loaded in either direction. Notes: <ul style="list-style-type: none"> • Short Edge is the factory default setting. • Long Edge appears only when the longest edge is shorter than the maximum width supported in the tray.

Reports Menu

Reports menu

Use	To
Menu Settings Page	Print a report containing information about the paper loaded in trays, installed memory, total page count, alarm settings, timeouts, printer control panel language, TCP/IP address, status of supplies, status of the network connection, and other information.
Device Statistics	Print a report containing printer statistics such as supply information and number of printed pages.
Network Setup Page	Print a report containing information about the network printer settings, such as the TCP/IP address information. Note: This menu item appears only in network printers or in printers connected to print servers.
Network [x] Setup Page	Print a report containing information about the network settings of the printer, such as the TCP/IP address information. Note: This menu item appears only in network printers or printers connected to print servers, and when there is more than one network option installed.
Shortcut List	Print a report containing information about configured shortcuts.
Fax Job Log	Print a report containing information about the last 200 completed faxes. Note: This menu item appears only when Enable Job Log is set to On in the Fax Settings menu.
Fax Call Log	Print a report containing information about the last 100 attempted, received, and blocked calls. Note: This menu item appears only when Enable Job Log is set to On in the Fax Settings menu.
Copy Shortcuts	Print a report containing information about copy shortcuts.
E-mail Shortcuts	Print a report containing information about e-mail shortcuts.
Fax Shortcuts	Print a report containing information about fax shortcuts.
FTP Shortcuts	Print a report containing information about FTP shortcuts.
Profiles List	Print a list of profiles stored in the printer.
Print Fonts	Print a report of all the fonts available for the printer language currently set in the printer.

Use	To
Print Directory	Print a list of all the resources stored in an optional flash memory card or printer hard disk. Notes: <ul style="list-style-type: none"> • Job Buffer Size must be set to 100%. • Make sure the optional flash memory or printer hard disk is working and installed correctly.
Asset Report	Print a report containing asset information including the printer serial number and model name. The report contains text and UPC bar codes that can be scanned into an asset database.

Network/Ports menu

Active NIC menu

Use	To
Active NIC Auto [list of available network cards]	Notes: <ul style="list-style-type: none"> • Auto is the factory default setting. • This menu item appears only when an optional network card is installed.

Standard Network or Network [x] menu

Note: Only active ports appear in this menu. All inactive ports are omitted.

Use	To
PCL SmartSwitch On Off	Set the printer to automatically switch to PCL emulation when a print job requires it, regardless of the default printer language. Notes: <ul style="list-style-type: none"> • On is the factory default setting. • If PCL SmartSwitch is disabled, then the printer does not examine incoming data and it uses the default printer language specified in the Setup menu.
PS SmartSwitch On Off	Set the printer to automatically switch to PS emulation when a print job requires it, regardless of the default printer language. Notes: <ul style="list-style-type: none"> • On is the factory default setting. • If PS SmartSwitch is disabled, then the printer does not examine incoming data and uses the default printer language specified in the Setup menu.

Use	To
NPA Mode Off Auto	Set the printer to perform the special processing required for bidirectional communication following the conventions defined by the NPA protocol. Notes: <ul style="list-style-type: none"> • Auto is the factory default setting. • Changing this setting from the printer control panel and then exiting the menus causes the printer to restart. The menu selection is then updated.
Network Buffer Auto 3KB to [maximum size allowed]	Set the size of the network input buffer. Notes: <ul style="list-style-type: none"> • Auto is the factory default setting. • The value can be changed in 1KB increments. • The maximum size allowed depends on the amount of memory in the printer, the size of the other link buffers, and whether Resource Save is set to On or Off. • To increase the maximum size range for the Network Buffer, disable or reduce the size of the parallel, serial, and USB buffers. • Changing this setting from the printer control panel, and then exiting the menus causes the printer to restart. The menu selection is then updated.
Mac Binary PS On Off Auto	Set the printer to process Macintosh binary PostScript print jobs. Notes: <ul style="list-style-type: none"> • Auto is the factory default setting. • Off filters print jobs using the standard protocol. • On processes raw binary PostScript print jobs.
Standard Network Setup or Network [x] Setup Reports Network Card TCP/IP IPv6 Wireless AppleTalk	Display and set the printer network settings. Note: The Wireless menu appears only when the printer is connected to a wireless network.

Reports menu

To access the menu, navigate to either of the following:

- **Network/Ports > Standard Network > Standard Network Setup > Reports**
- **Network/Ports > Network [x] > Network [x] Setup > Reports**

Use	To
Print Setup Page	Print a report containing information about the network printer settings, such as the TCP/IP address.

Network Card menu

To access the menu, navigate to either of the following:

- **Network/Ports > Standard Network > Standard Network Setup > Network Card**
- **Network/Ports > Network [x] > Network [x] Setup > Network Card**

Use	To
View Card Status Connected Disconnected	View the connection status of the network card.
View Card Speed	View the speed of an active network card.
Network Address UAA LAA	View the network addresses.
Job Timeout 0–255 seconds	Set the amount of time it takes for a network print job to be canceled. Notes: <ul style="list-style-type: none"> • 90 seconds is the factory default setting. • A setting value of 0 disables the timeout. • If a value of 1–9 is selected, then the setting is saved as 10.

TCP/IP menu

To access the menu, navigate to either of the following:

- **Network/Ports > Standard Network > Standard Network Setup > TCP/IP**
- **Network/Ports > Network [x] > Network [x] Setup > TCP/IP**

Note: This menu is available only in network printers or printers attached to print servers.

Use	To
Set Hostname	Set the current TCP/IP host name. Note: This can be changed only from the Embedded Web Server.
IP Address	View or change the current TCP/IP address. Note: Manually setting the IP address sets the Enable DHCP and Enable Auto IP settings to Off. It also sets Enable BOOTP and Enable RARP to Off on systems that support BOOTP and RARP.
Netmask	View or change the current TCP/IP netmask.
Gateway	View or change the current TCP/IP gateway.
Enable DHCP On Off	Specify the DHCP address and parameter assignment. Note: On is the factory default setting.
Enable RARP On Off	Specify the RARP address assignment setting. Note: Off is the factory default setting.

Use	To
Enable BOOTP On Off	Specify the BOOTP address assignment setting. Note: On is the factory default setting.
Enable AutoIP Yes No	Specify the Zero Configuration Networking setting. Note: Yes is the factory default setting.
Enable FTP/TFTP Yes No	Enable the built-in FTP server, which lets you send files to the printer using File Transfer Protocol. Note: Yes is the factory default setting.
Enable HTTP Server Yes No	Enable the built-in Web server (Embedded Web Server). When enabled, the printer can be monitored and managed remotely using a Web browser. Note: Yes is the factory default setting.
WINS Server Address	View or change the current WINS server address.
Enable DDNS Yes No	View or change the current DDNS setting. Note: Yes is the factory default setting.
Enable mDNS Yes No	View or change the current mDNS setting. Note: Yes is the factory default setting.
DNS Server Address	View or change the current DNS server address.
Backup DNS Server Address	View or change the backup DNS server addresses.
Backup DNS Server Address 2	
Backup DNS Server Address 3	
Enable HTTPS Yes No	View or change the current HTTPS setting. Note: Yes is the factory default setting.

IPv6 menu

To access the menu, navigate to either of the following:

- **Network/Ports > Standard Network > Standard Network Setup > IPv6**
- **Network/Ports > Network [x] > Network [x] Setup > IPv6**

Note: This menu is available only in network printers or printers that are attached to print servers.

Use	To
Enable IPv6 On Off	Enable IPv6 in the printer. Note: On is the factory default setting.

Use	To
Auto Configuration On Off	Specify whether or not the wireless network adapter accepts the automatic IPv6 address configuration entries provided by a router. Note: On is the factory default setting.
View Hostname	Set the host name.
View Address	Note: These settings can be changed only from the Embedded Web Server.
View Router Address	
Enable DHCPv6 On Off	Enable DHCPv6 in the printer. Note: On is the factory default setting.

Wireless menu

Note: This menu is available only in printers connected to an Ethernet network and printers with a wireless network adapter attached.

To access the menu, navigate to either of the following:

- **Network/Ports > Standard Network > Standard Network Setup > Wireless**
- **Network/Ports > Network [x] > Network [x] Setup > Wireless**

Use	To
Wi-Fi Protected Setup (WPS) Start Push Button Method Start PIN Method	Establish a wireless network connection and enable network security. Notes: <ul style="list-style-type: none"> • Start Push Button Method connects the printer to a wireless network when buttons on both the printer and the access point (wireless router) are pressed within a given period of time. • Start PIN Method connects the printer to a wireless network when a PIN on the printer is entered into the wireless settings of the access point.
Enable/Disable WPS Auto-detection Enable Disable	Automatically detect the connection method that an access point with WPS uses—Start Push Button Method or Start PIN Method. Note: Disable is the factory default setting.
Network Mode BSS Type Infrastructure Ad hoc	Specify the network mode. Notes: <ul style="list-style-type: none"> • Infrastructure is the factory default setting. This lets the printer access a network using an access point. • Ad hoc configures a wireless connection directly between the printer and a computer.
Compatibility 802.11b/g 802.11b/g/n	Specify the wireless standard for the wireless network. Note: The 802.11b/g/n is the factory default setting.
Choose Network	Select an available network for the printer to use.
View Signal Quality	View the quality of the wireless connection.

Use	To
View Security Mode	View the encryption method for the wireless network.

AppleTalk menu

Note: This menu appears only in printer models that are connected to an Ethernet network or when an optional wireless network adapter is installed.

To access the menu, navigate to either of the following:

- **Network/Ports > Standard Network > Standard Network Setup > AppleTalk**
- **Network/Ports > Network [x] > Network [x] Setup > AppleTalk**

Use	To
Activate Yes No	Enable or disable AppleTalk support. Note: Yes is the factory default setting.
View Name	Show the assigned AppleTalk name. Note: The AppleTalk name can be changed only from the Embedded Web Server.
View Address	Show the assigned AppleTalk address. Note: The AppleTalk address can be changed only from the Embedded Web Server.
Set Zone [list of zones available on the network]	Provide a list of AppleTalk zones available on the network. Note: The default zone for the network is the factory default setting.

Standard USB menu

Use	To
PCL SmartSwitch On Off	Set the printer to automatically switch to PCL emulation when a print job received through a USB port requires it, regardless of the default printer language. Notes: <ul style="list-style-type: none"> • On is the factory default setting. • When set to Off, the printer does not examine incoming data. The printer uses PostScript emulation if the PS SmartSwitch is set to On. It uses the default printer language specified in the Setup menu if the PS SmartSwitch is set to Off.
PS SmartSwitch On Off	Set the printer to automatically switch to PS emulation when a print job received through a USB port requires it, regardless of the default printer language. Notes: <ul style="list-style-type: none"> • On is the factory default setting. • When set to Off, the printer does not examine incoming data. The printer uses PCL emulation if the PCL SmartSwitch is set to On. It uses the default printer language specified in the Setup menu if the PCL SmartSwitch is set to Off.

Use	To
NPA Mode On Off Auto	Set the printer to perform the special processing required for bidirectional communication following the conventions defined by the NPA protocol. Notes: <ul style="list-style-type: none"> • Auto is the factory default setting. Auto sets the printer to examine data, determine the format, and then process it appropriately. • The printer automatically restarts when changing the setting from the printer control panel. The menu selection is then updated.
USB Buffer Disabled Auto 3K to [maximum size allowed]	Set the size of the USB input buffer. Notes: <ul style="list-style-type: none"> • Auto is the factory default setting. • Disabled turns off job buffering. Any jobs already buffered on the printer hard disk are printed before normal processing resumes. • The USB buffer size value can be changed in 1-K increments. • The maximum size allowed depends on the amount of memory in the printer, the size of the other link buffers, and whether Resource Save is set to On or Off. • To increase the maximum size range for the USB Buffer, disable or reduce the size of the parallel, serial, and network buffers. • The printer automatically restarts when the setting is changed from the printer control panel. The menu selection is then updated.
Job Buffering Off On Auto	Temporarily store print jobs in the printer hard disk before printing. Notes: <ul style="list-style-type: none"> • Off is the factory default setting. • On buffers jobs on the printer hard disk. • Auto buffers print jobs only if the printer is busy processing data from another input port. • Changing this setting from the printer control panel and then exiting the menus causes the printer to restart. The menu selection is then updated.
Mac Binary PS On Off Auto	Set the printer to process Macintosh binary PostScript print jobs. Notes: <ul style="list-style-type: none"> • Auto is the factory default setting. • On processes raw binary PostScript print jobs. • Off filters print jobs using the standard protocol.
ENA Address YYY.YYY.YYY.YYY	Set the network address information for an external print server. Note: This menu is available only when the printer is attached to an external print server through the USB port.
ENA Netmask YYY.YYY.YYY.YYY	Set the netmask information for an external print server. Note: This menu is available only when the printer is attached to an external print server through the USB port.

Use	To
ENA Gateway YYY.YYY.YYY.YYY	Set the gateway information for an external print server. Note: This menu is available only when the printer is attached to an external print server through the USB port.

SMTP Setup menu

Use	To
Primary SMTP Gateway	Specify SMTP server gateway and port information. Note: 25 is the default SMTP gateway port.
Primary SMTP Gateway Port	
Secondary SMTP Gateway	
Secondary SMTP Gateway Port	
SMTP Timeout 5–30	Specify the amount of time in seconds before the server stops trying to send an e-mail. Note: 30 is the factory default setting.
Reply Address	Specify a reply address of up to 128 characters in the e-mail sent by the printer.
Use SSL Disabled Negotiate Required	Set the printer to use SSL for increased security when connecting to the SMTP server. Notes: <ul style="list-style-type: none"> • Disabled is the factory default setting. • When the Negotiate setting is used, the SMTP server determines if SSL will be used.
SMTP Server Authentication No authentication required Login/Plain CRAM-MD5 Digest-MD5 NTLM Kerberos 5	Specify the type of user authentication required for scan to e-mail privileges. Note: “No authentication required” is the factory default setting.

Use	To
Device-Initiated E-mail None Use Device SMTP Credentials	Specify what credentials will be used when communicating to the SMTP server. Notes: <ul style="list-style-type: none"> • None is the factory default setting for Device-Initiated E-mail and User-Initiated E-mail. • “Device Userid” and “Device password” are used to log in to the SMTP server when Use Device SMTP Credentials is selected.
User-Initiated E-mail None Use Device SMTP Credentials Use Session User ID and Password Use Session E-mail address and Password Prompt user	
Device Userid	
Device password	
Kerberos 5 Realm	
NTLM Domain	

Security menu

Edit Security Setups menu

Note: This menu appears only in select touch-screen printer models.

Use	To
Edit Backup Password Use Backup Password <ul style="list-style-type: none"> • Off • On Password	Create a backup password. Notes: <ul style="list-style-type: none"> • Off is the factory default setting for “Use Backup Password.” • This menu appears only if a backup password exists.
Edit Building Blocks Internal Accounts NTLM Simple Kerberos Setup Kerberos Setup Active Directory LDAP LDAP+GSSAPI Password PIN	Edit settings for Internal Accounts, NTLM, Simple Kerberos Setup, Kerberos Setup, Active Directory, LDAP, Password, and PIN.
Edit Security Templates [list of available templates]	Add or edit a security template.

Use	To
<p>Edit Access Controls</p> <ul style="list-style-type: none"> Administrative Menus Function Access Management Solutions Cancel jobs at the Device 	<p>Control access to printer menus, firmware updates, held jobs, and other access points.</p>

Miscellaneous Security Settings menu

Use	To
<p>Login Restrictions</p> <ul style="list-style-type: none"> Login failures Failure time frame Lockout time Panel Login Timeout Remote Login Timeout 	<p>Limit the number and time frames of failed login attempts from the printer control panel before all users are locked out.</p> <p>Notes:</p> <ul style="list-style-type: none"> • “Login failures” specifies the number of failed login attempts before users are locked out. Settings range from 1 to 10 attempts is the factory default setting. • “Failure time frame” specifies the time frame during which failed login attempts can be made before users are locked out. Settings range from 1 to 60 minutes. 5 minutes is the factory default setting. • “Lockout time” specifies how long users are locked out after exceeding the login failures limit. Settings range from 1 to 60 minutes. 5 minutes is the factory default setting. 1 indicates the printer does not impose a lockout time. • “Panel Login Timeout” specifies how long the printer remains idle on the Home screen before automatically logging the user off. Settings range from 1 to 900 seconds. 30 seconds is the factory default setting. • “Remote Login Timeout” specifies how long a remote interface remains idle before automatically logging the user off. Settings range from 1 to 120 seconds. 10 minutes is the factory default setting.
<p>Security Reset Jumper</p> <ul style="list-style-type: none"> Access controls=“No Security” No Effect Reset factory security defaults 	<p>Change the value of the security settings.</p> <p>Notes:</p> <ul style="list-style-type: none"> • Access controls=“No Security” retains all the security information that the user has defined. “No Security” is the factory default setting. • “No Effect” means the reset has no effect on the device’s security configuration. • “Reset factory security defaults” deletes all security information that the user has defined, and assigns the factory default value to each setting in the Miscellaneous Security Settings section of both the panel and the Embedded Web Server.

Use	To
LDAP Certificate Verification Demand Try Allow Never	Allow the user to request a server certificate. Notes: <ul style="list-style-type: none"> • “Demand” means a server certificate is requested. If a bad certificate is provided or if no certificate is provided, then the session is terminated immediately. “Demand” is the factory default setting. • “Try” means a server certificate is requested. If no certificate is provided, then the session proceeds normally. If a bad certificate is provided, then the session is terminated immediately. • “Allow” means a server certificate is requested. If no certificate is provided, then the session proceeds normally. If a bad certificate is provided, then it will be ignored, and then the session proceeds normally. • “Never” means no server certificate is requested.
Minimum PIN Length 1–16	Limit the digit length of the PIN. Note: 4 is the is the factory default setting.

Confidential Print menu

Use	To
Max Invalid PIN Off 2–10	Set a limit on the number of times an invalid PIN can be entered. Notes: <ul style="list-style-type: none"> • This menu item appears only when a formatted, working printer hard disk is installed. • When the limit is reached, the print jobs for that user name and PIN are deleted.
Confidential Job Expiration Off 1 hour 4 hours 24 hours 1 week	Set a limit on how long the printer stores confidential print jobs. Notes: <ul style="list-style-type: none"> • If the “Confidential Job Expiration” setting is changed while confidential print jobs reside in the printer memory or printer hard disk, then the expiration time for those print jobs does not change to the new default value. • If the printer is turned off, then all confidential jobs held in the printer memory are deleted.
Repeat Job Expiration Off 1 hour 4 hours 24 hours 1 week	Set a limit on how long the printer stores print jobs.
Note: Off is the factory default setting.	

Use	To
Verify Job Expiration Off 1 hour 4 hours 24 hours 1 week	Set a limit on how long the printer stores print jobs needing verification.
Reserve Job Expiration Off 1 hour 4 hours 24 hours 1 week	Set a limit on how long the printer stores print jobs for printing at a later time.
Note: Off is the factory default setting.	

Erase Temporary Data Files menu

Erase Temporary Data Files deletes *only* print job data on the printer hard disk that *are not* currently in use by the file system. All permanent data on the printer hard disk are preserved, such as downloaded fonts, macros, and held jobs.

Note: This menu appears only when a formatted, working printer hard disk is installed.

Use	To
Wiping Mode Auto	Specify the mode for erasing temporary data files.
Automatic Method Single pass Multiple pass	Mark all disk space used by a previous print job. This method does not permit the file system to reuse this space until it has been cleared. Notes: <ul style="list-style-type: none"> • “Single pass” is the factory default setting. • Only automatic wiping enables users to erase temporary data files without having to turn off the printer for an extended amount of time. • Highly confidential information should be erased using <i>only</i> the Multiple pass method.

Security Audit Log menu

Use	To
Export Log	Let an authorized user export the audit log. Notes: <ul style="list-style-type: none"> • To export the audit log from the printer control panel, a flash drive must be attached to the printer. • The audit log can be downloaded from the Embedded Web Server and saved on a computer.

Use	To
Delete Log Yes No	Specify whether or not audit logs are deleted. Note: Yes is the factory default setting.
Configure Log Enable Audit Yes No Enable Remote Syslog No Yes Remote Syslog Facility 0–23 Severity of events to log 0–7	Specify how and whether or not audit logs are created. Notes: <ul style="list-style-type: none"> • Enable Audit determines if events are recorded in the secure audit log and remote syslog. No is the factory default setting. • Enable Remote Syslog determines if logs are sent to a remote server. No is the factory default setting. • Remote Syslog Facility determines the value used to send logs to the remote syslog server. 4 is the factory default setting. • If the security audit log is activated, then the severity value of each event is recorded. 4 is the factory default setting.

Set Date/Time menu

Use	To
Current Date and Time	View the current date and time settings for the printer.
Manually Set Date and Time	Enter the date and time. Note: Date/Time is set in YYYY-MM-DD HH:MM:SS format.
Time Zone	Select the time zone. Note: GMT is the factory default setting.
Automatically Observe DST On Off	Set the printer to use the applicable daylight saving time (DST) start and end times associated with the printer Time Zone setting. Note: On is the factory default setting and uses the applicable Daylight Saving Time associated with the Time Zone setting.
Custom Time Zone Setup DST Start Week DST Start Day DST Start Month DST Start Time DST End Week DST End Day DST End Month DST End Time DST Offset	Enable the user to set up the time zone.
Enable NTP On Off	Enable Network Time Protocol, which synchronizes the clocks of devices on a network. Note: On is the factory default setting.
NTP Server	View the NTP server address.

Use	To
Enable Authentication On Off	Change the authentication setting to On or Off. Note: Off is the factory default setting.

Settings menu

General Settings menu

Use	To
Display Language English Francais Deutsch Italiano Espanol Dansk Norsk Nederlands Svenska Portuguese Suomi Russian Polski Greek Magyar Turkce Cesky Simplified Chinese Traditional Chinese Korean Japanese	Set the language of the text appearing on the printer display. Note: Not all languages are available for all printers, and you may need to install special hardware for those languages to appear.
Eco-Mode Off Energy Energy/Paper Paper	Minimize the use of energy, paper, or specialty media. Notes: <ul style="list-style-type: none"> • Off is the factory default setting. This resets the printer to its factory default settings. • The Energy setting minimizes the power used by the printer. Performance may be affected, but print quality is not. • Energy/Paper minimizes the use of power and of paper and specialty media. • Paper minimizes the amount of paper and specialty media needed for a print job. Performance may be affected, but print quality is not.

Use	To
ADF Loaded Beep Enabled Disabled	Specify whether or not the ADF sounds a beep when paper is loaded. Note: Enabled is the factory default setting.
ADF Multi-feed Sensor On Off	Detect when the ADF picks more than one sheet of paper at once. Note: On is the factory default setting.
Quiet Mode Off On	Reduce the amount of noise produced by the printer. Notes: <ul style="list-style-type: none"> • Off is the factory default setting. This supports the performance specifications for your printer. • On configures the printer to produce as little noise as possible. This is best suited for printing text and line art. • For optimal printing of color-rich documents, set Quiet Mode to Off. • Selecting Photo from the printer driver may disable Quiet Mode and provide better print quality and full-speed printing.
Run Initial setup Yes No	Set the printer to run the setup wizard. Notes: <ul style="list-style-type: none"> • Yes is the factory default setting. • After completing the setup wizard by selecting Done at the “Country select” screen, the default becomes No.

Use	To
<p>Keyboard</p> <ul style="list-style-type: none"> Keyboard Type <ul style="list-style-type: none"> English Francais Francais Canadien Deutsch Italiano Espanol Greek Dansk Norsk Nederlands Svenska Suomi Portuguese Russian Polski Swiss German Swiss French Korean Magyar Turkce Cesky Simplified Chinese Traditional Chinese Japanese Custom Key [x] 	<p>Specify a language and custom key information for the printer keyboard. The additional tabs enable access to accent marks and symbols from the keyboard.</p>
<p>Paper Sizes</p> <ul style="list-style-type: none"> US Metric 	<p>Specify the default system of measurement for paper sizes.</p> <p>Notes:</p> <ul style="list-style-type: none"> • US is the factory default setting. • The initial setting is determined by your country or region selection in the initial setup wizard. • Changing this also changes the default setting for each input source in the Paper Size/Type menu.
<p>Scan to PC Port Range [port range]</p>	<p>Specify a valid port range for printers behind a port blocking firewall. The valid ports are specified by two sets of numbers separated by a semicolon.</p> <p>Note: "9751:12000" is the factory default setting.</p>

Use	To
<p>Displayed Information</p> <p>Left side</p> <p>Right side</p> <p>Custom Text [x]</p>	<p>Specify what is displayed on the upper left and right corners of the home screen.</p> <p>For the Left side and Right side menus, select from the following options:</p> <ul style="list-style-type: none"> None IP Address Hostname Contact Name Location Date/Time mDNS/DDNS Service Name Zero Configuration Name Custom Text [x] Model Name <p>Notes:</p> <ul style="list-style-type: none"> • IP Address is the factory default setting for “Left side.” • Date/Time is the factory default setting for “Right side.”
<p>Displayed Information (continued)</p> <p>Black Toner</p>	<p>Customize the displayed information for Black Toner.</p> <p>Select from the following options:</p> <ul style="list-style-type: none"> When to display <ul style="list-style-type: none"> Do not display Display Message to display <ul style="list-style-type: none"> Default Alternate Default <ul style="list-style-type: none"> [text entry] Alternate <ul style="list-style-type: none"> [text entry] <p>Notes:</p> <ul style="list-style-type: none"> • “Do not display” is the factory default setting for “When to display.” • Default is the factory default setting for “Message to display.”

Use	To
<p>Displayed Information (continued)</p> <ul style="list-style-type: none"> Paper Jam Load Paper Service Errors 	<p>Customize the displayed information for Paper Jam, Load Paper, and Service Errors menus.</p> <p>Select from the following options:</p> <ul style="list-style-type: none"> Display <ul style="list-style-type: none"> Yes No Message to display <ul style="list-style-type: none"> Default Alternate Default <ul style="list-style-type: none"> [text entry] Alternate <ul style="list-style-type: none"> [text entry] <p>Notes:</p> <ul style="list-style-type: none"> • No is the factory default setting for Display. • Default is the factory default setting for “Message to display.”
<p>Home screen customization</p> <ul style="list-style-type: none"> Change Language Copy Copy Shortcuts Fax Fax Shortcuts E-mail E-mail Shortcuts FTP FTP Shortcuts Search Held Jobs Held Jobs USB Drive Profiles and Solutions Bookmarks Jobs by user Forms and Favorites 	<p>Change the icons that appear on the home screen.</p> <p>For each icon, select from the following options:</p> <ul style="list-style-type: none"> Display Do not display <p>Notes:</p> <ul style="list-style-type: none"> • Display is the factory default setting for the Copy, Fax, E-mail, FTP, Search Held Jobs, Held Jobs, USB Drive, and Forms and Favorites menus. • “Do not display” is the factory default setting for the Change Language, Copy Shortcuts, Fax Shortcuts, E-mail Shortcuts, FTP Shortcuts, Profiles and Solutions, Bookmarks, and “Jobs by user” menus.
<p>Date Format</p> <ul style="list-style-type: none"> MM-DD-YYYY DD-MM-YYYY YYYY-MM-DD 	<p>Format the printer date.</p> <p>Notes:</p> <ul style="list-style-type: none"> • MM-DD-YYYY is the U.S. factory default setting. • DD-MM-YYYY is the international factory default setting.
<p>Time Format</p> <ul style="list-style-type: none"> 12 hour A.M./P.M. 24 hour clock 	<p>Format the printer time.</p> <p>Note: “12 hour A.M./P.M.” is the factory default setting.</p>

Use	To
Screen Brightness 20–100	Specify the brightness of the printer control panel screen. Note: 100 is the factory default setting.
One Page Copy Off On	Set copies from the scanner glass to only one page at a time. Note: Off is the factory default setting.
Output Lighting Normal/Standby Mode Off Dim Bright	Set the amount of light from the standard output bin. Notes: <ul style="list-style-type: none"> • Dim is the factory default setting if Eco-Mode is set to Energy or Energy/Paper. • Bright is the factory default setting if Eco-Mode is Off or set to Paper.
Error Lighting On Off	Determine if indicator lights blink when the printer encounters errors. Note: On is the factory default setting.
Audio Feedback Button Feedback On Off Volume 1–10	Set the audio volume for the buttons. Notes: <ul style="list-style-type: none"> • On is the factory default setting for Button Feedback. • 5 is the factory default setting for Volume.
Tactile Touchscreen Feedback On Off	Provide touch-screen sensation feedback. Note: On is the factory default setting.
Show Bookmarks Yes No	Specify whether bookmarks are displayed from the Held Jobs area. Note: Yes is the factory default setting. When Yes is selected, bookmarks appear in the Held Jobs area.
Allow Background Removal On Off	Specify whether image background removal is allowed in copy, fax, e-mail, FTP, or scan-to-USB jobs. Note: On is the factory default setting. The background of the image will be removed.
Allow Custom Job Scans On Off	Scan multiple jobs to one file. Note: On is the factory default setting. If On is selected, then the Allow Custom Job Scans setting can be enabled for specific jobs.
Scanner Jam Recovery Job level Page level	Specify how a scanned job should be reloaded if a paper jam occurs in the ADF. Notes: <ul style="list-style-type: none"> • Job level is the factory default setting. • If Job level is selected, then the entire job must be rescanned if any pages jam. • If Page level is selected, then rescan from the jammed page forward.

Use	To
Web Page Refresh Rate 30–300	Specify the number of seconds between Embedded Web Server refreshes. Note: 120 is the factory default setting.
Contact Name	Specify a contact name for the printer. Note: The contact name will be stored on the Embedded Web Server.
Location	Specify the location of the printer. Note: The location will be stored on the Embedded Web Server.
Alarms Alarm Control Cartridge Alarm Staple Alarm	Set an alarm to sound when the printer requires user intervention. When activated, Alarm Control lets you set the number of times that the alarm sounds, while Cartridge Alarm lets you stop printing when a cartridge-low condition occurs. For each alarm type, select from the following options: Off Single Continuous Notes: <ul style="list-style-type: none"> • Single is the factory default setting for Alarm Control. This sounds three quick beeps. • Off is the factory default setting for Cartridge Alarm and Staple Alarm. This means no alarm will sound. • Continuous repeats three beeps every 10 seconds.
Timeouts Standby Mode Disabled 1–240	Specify the number of minutes of inactivity before the printer enters a lower power state. Note: 15 is the factory default setting.
Timeouts Sleep Mode Disabled 1–180	Set the amount of time in minutes the printer waits after a job is printed before it goes into a reduced power state. Notes: <ul style="list-style-type: none"> • 30 is the factory default setting. • Lower settings conserve more energy, but may require longer warm-up times. • Select the lowest setting if the printer shares an electrical circuit with room lighting or you notice lights flickering in the room. • Select a high setting if the printer is in constant use. Under most circumstances, this keeps the printer ready to print with minimum warm-up time.

Use	To
Timeouts Timeout Disabled 1–3 hours 6 hours 1–3 days 1–2 weeks 1 month	Set the printer to operate at a low power state. Notes: <ul style="list-style-type: none"> • Disabled is the factory default setting in all countries except in European Union countries and Switzerland. • “3 days” is the factory default setting in European Union countries and Switzerland.
Timeouts Hibernate Timeout on Connection Hibernate Do Not Hibernate	Set the printer to Hibernate Timeout even when there is an active Ethernet or phone connection. Note: Do Not Hibernate is the factory default setting.
Timeouts Screen Timeout 15–300	Set the amount of time in seconds the printer waits before returning the printer display to Ready state. Note: 30 is the factory default setting.
Timeouts Prolong Screen Timeout On Off	Show a message that lets you reset the screen timeout timer instead of returning to the home screen. Note: Off is the factory default setting.
Timeouts Print Timeout Disabled 1–255	Set the amount of time in seconds the printer waits to receive an end-of-job message before canceling the remainder of the print job. Notes: <ul style="list-style-type: none"> • 90 is the factory default setting. • When the timer expires, any partially printed page still in the printer is printed, and then the printer checks to see if any new print jobs are waiting. • Print Timeout is available only when using PCL emulation. This setting has no effect on PostScript emulation print jobs.
Timeouts Wait Timeout Disabled 15–65535	Set the amount of time in seconds the printer waits for additional data before canceling a print job. Notes: <ul style="list-style-type: none"> • 40 is the factory default setting. • Wait Timeout is available only when the printer is using PostScript emulation. This setting has no effect on PCL emulation print jobs.

Use	To
Timeouts Job Hold Timeout 5–255	Set the amount of time the printer waits for user intervention before it holds jobs that require unavailable resources and continues to print other jobs in the print queue. Notes: <ul style="list-style-type: none"> • 30 is the factory default setting. • This menu item appears only when a formatted, working printer hard disk is installed.
Error Recovery Auto Reboot Reboot when idle Reboot always Reboot never	Automatically reboot the printer. Note: “Reboot when idle” is the factory default setting.
Error Recovery Max Auto Reboots 1–20	Determine the number of automatic reboots the printer can perform. Note: 5 is the factory default setting.
Print Recovery Auto Continue Disabled 5–255	Let the printer automatically continue printing from certain offline situations when not resolved within the specified time period. Note: Disabled is the factory default setting.
Print Recovery Jam Recovery On Off Auto	Specify whether the printer reprints jammed pages. Notes: <ul style="list-style-type: none"> • Auto is the factory default setting. The printer reprints jammed pages unless the memory required to hold the pages is needed for other printer tasks. • On sets the printer to always reprint jammed pages. • Off sets the printer to never reprint jammed pages.
Print Recovery Jam Assist On Off	Set the printer to automatically check for jammed paper. Note: On is the factory default setting.
Print Recovery Page Protect Off On	Let the printer successfully print a page that may not have printed otherwise. Notes: <ul style="list-style-type: none"> • Off is the factory default setting. This prints a partial page when there is not enough memory to print the whole page. • On sets the printer to process the whole page so that the entire page prints.
Press Sleep Button Do Nothing Sleep Hibernate	Determine how the printer responds to a short press of the Sleep button when the printer is idle. Note: Sleep is the factory default setting.

Use	To
Press and Hold Sleep Button Do Nothing Sleep Hibernate	Determine how the printer responds to a long press of the Sleep button when the printer is idle. Notes: <ul style="list-style-type: none"> • Do Nothing is the factory default setting. • Sleep or Hibernate sets the printer to operate at a lower power configuration. • If the printer is in Sleep Mode, then the touch screen appears off and the Sleep button turns amber in color. • Press and hold the Sleep button for 3 seconds or longer to enter Hibernate mode. • Touch anywhere on the touch screen or press a button on the printer control panel to exit Sleep Mode.
Factory Defaults Do Not Restore Restore Now	Return the printer settings to the factory default settings. Notes: <ul style="list-style-type: none"> • Do Not Restore is the factory default setting. This keeps the user-defined settings. • Restore Now returns all printer settings to the factory default settings except Network/Ports menu settings. All downloads stored in RAM are deleted. Downloads stored in flash memory or on a printer hard disk are not affected.

Copy Settings menu

Use	To
Content Type Text Graphics Text/Photo Photo	Specify the content of the original document. Note: Text/Photo is the factory default setting.
Content Source Black/White Laser Color Laser Inkjet Photo/Film Magazine Newspaper Press Other	Specify how the original document was produced. Note: Black/White Laser is the factory default setting.

Use	To
<p>Sides (Duplex)</p> <ul style="list-style-type: none"> 1 sided to 1 sided 1 sided to 2 sided 2 sided to 1 sided 2 sided to 2 sided 	<p>Specify whether an original document is two-sided (duplex) or one-sided, and then specify whether the copy should be two-sided or one-sided.</p> <p>Notes:</p> <ul style="list-style-type: none"> • 1 sided to 1 sided—The original document has print on one side and the copy will also have print on one side. • 1 sided to 2 sided—The original document has print on one side, while the copy will have print on both sides. • 2 sided to 1 sided—The original document has print on both sides, while the copy will have print on just one side. • 2 sided to 2 sided—The original document has print on both sides, and the copy will also have print on both sides.
<p>Paper Saver</p> <ul style="list-style-type: none"> Off 2-up Portrait 4-up Portrait 2-up Landscape 4-up Landscape 	<p>Copy two or four sheets of a document on one page.</p> <p>Note: Off is the factory default setting.</p>
<p>Print Page Borders</p> <ul style="list-style-type: none"> On Off 	<p>Specify whether or not a border is printed.</p> <p>Note: Off is the factory default setting.</p>
<p>Collate</p> <ul style="list-style-type: none"> (1,1,1) (2,2,2) (1,2,3) (1,2,3) 	<p>Keep the pages of a print job stacked in sequence when printing multiple copies.</p> <p>Note: “(1,2,3) (1,2,3)” is the factory default setting.</p>
<p>Staple</p> <ul style="list-style-type: none"> Off On 	<p>Enable or disable the staple finisher.</p> <p>Notes:</p> <ul style="list-style-type: none"> • Off is the factory default setting. • This menu item appears only when a staple finisher is installed.

Use	To
<p>Original Size</p> <ul style="list-style-type: none"> Letter Legal Executive Folio Statement Oficio (Mexico) Universal Auto Size Sense Mixed Sizes A4 A5 A6 JIS B5 Custom Scan Size [x] Book Original Business Card 3 x 5 in. 4 x 6 in. ID Card 	<p>Specify the paper size of the original document.</p> <p>Notes:</p> <ul style="list-style-type: none"> • Letter is the U.S. factory default setting. • A4 is the international factory default setting.
<p>Copy To Source</p> <ul style="list-style-type: none"> Tray [x] Auto Size Match Multipurpose Feeder 	<p>Specify the paper source for copy jobs.</p> <p>Note: Tray 1 is the factory default setting.</p>
<p>Transparency Separators</p> <ul style="list-style-type: none"> On Off 	<p>Place a sheet of paper between transparencies.</p> <p>Note: On is the factory default setting.</p>
<p>Separator Sheets</p> <ul style="list-style-type: none"> Off Between Copies Between Jobs Between Pages 	<p>Place a sheet of paper between pages, copies, or jobs.</p> <p>Note: Off is the factory default setting.</p>
<p>Separator Sheet Source</p> <ul style="list-style-type: none"> Tray [x] Multipurpose Feeder 	<p>Specify the paper source for separator sheet.</p> <p>Note: Tray 1 is the factory default setting.</p>
<p>Darkness</p> <ul style="list-style-type: none"> 1–9 	<p>Specify the level of darkness for the copy job.</p> <p>Note: 5 is the factory default setting.</p>
<p>Number of Copies</p> <ul style="list-style-type: none"> 1–999 	<p>Specify the number of copies for the copy job.</p> <p>Note: 1 is the factory default setting.</p>

Use	To
Header/Footer [Location] Off Date/Time Page number Custom text Print on All pages First page only All but first page Custom text	Specify the header or footer information and its location on the page. For the location, select from the following options: <ul style="list-style-type: none"> • Top left • Top middle • Top right • Bottom left • Bottom middle • Bottom right Notes: <ul style="list-style-type: none"> • Off is the factory default setting for the location. • “All pages” is the factory default setting for “Print on.”
Overlay Confidential Copy Draft Urgent Custom Off	Specify the overlay text printed on each page of the copy job. Note: Off is the factory default setting.
Custom Overlay	Specify the custom overlay text. Note: A maximum of 64 characters is allowed.
Allow priority copies On Off	Allow interruption of a print job to copy a page or document. Note: On is the factory default setting.
Custom Job scanning On Off	Scan a document that contains mixed paper sizes into a single copy job. Notes: <ul style="list-style-type: none"> • Off is the factory default setting. • This menu item appears only when a formatted, working printer hard disk is installed.
Allow Save as Shortcut On Off	Save custom copy settings as shortcuts. Note: On is the factory default setting.
Background Removal -4 to 4	Adjust the amount of background visible on a copy. Note: 0 is the factory default setting.
Auto Center Off On	Automatically align the content at the center of the page. Note: Off is the factory default setting.

Use	To
Color Dropout Color Dropout None Red Green Blue Default Red Threshold 0–255 Default Green Threshold 0–255 Default Blue Threshold 0–255	Specify which color to drop during scanning and to adjust the dropout setting for each color threshold. Notes: <ul style="list-style-type: none"> • None is the factory default setting for Color Dropout. • 128 is the factory default setting for each color threshold.
Contrast 0–5 Best for content	Specify the contrast used for the copy job. Note: “Best for content” is the factory default setting.
Mirror Image Off On	Create a mirror image of the original document. Note: Off is the factory default setting.
Negative Image Off On	Create a negative image of the original document. Note: Off is the factory default setting.
Shadow Detail -4 to 4	Adjust the amount of shadow detail visible on a copy. Note: 0 is the factory default setting.
Adjust ADF Skew Auto Off On	Correct slight skew in the scanned image. Note: Off is the factory default setting.
Scan edge to edge Off On	Specify if the original document is scanned edge-to-edge prior to faxing. Note: Off is the factory default setting.
Sharpness 1–5	Adjust the amount of sharpness of a copy. Note: 3 is the factory default setting.
Sample Copy Off On	Create a sample copy of the original document. Note: Off is the factory default setting.

Fax Settings menu

Fax Mode (Analog Fax Setup) menu

Analog Fax Setup mode sends the fax job through a telephone line.

Note: The fax function is available only in select printer models.

Use	To
Fax Name	Specify the name of the fax in the printer.
Fax Number	Specify the number assigned to the fax.
Fax ID Fax Name Fax Number	Specify how the fax is identified.
Enable Manual Fax On Off	Set the printer to fax manually, which requires a line splitter and a telephone handset. Notes: <ul style="list-style-type: none"> • Off is the factory default setting. • Use a regular telephone to answer an incoming fax job and to dial a fax number. • Press # 0 on the numeric keypad to go directly to the Manual Fax function.
Memory Use All receive Mostly receive Equal Mostly send All send	Define the allocation of non-volatile memory between sending and receiving fax jobs. Notes: <ul style="list-style-type: none"> • Equal is the factory default setting. This splits the memory for sending and receiving fax jobs into equal amounts. • “Mostly send” specifies that most of the memory is set to send fax jobs. • “All send” specifies that all the memory is set to send fax jobs. • “All receive” specifies that all the memory is set to receive fax jobs. • “Mostly receive” specifies that most of the memory is set to receive fax jobs.
Cancel Faxes Allow Don't Allow	Specify whether or not the printer cancels fax jobs. Note: Allow is the factory default setting.
Caller ID Off Primary Alternate	Specify the type of caller ID being used.
Fax number masking Off From left From right	Specify the direction from where digits are masked in an outgoing fax number. Notes: <ul style="list-style-type: none"> • Off is the factory default setting. • The number of characters masked is determined by the “Digits to mask” setting.
Digits to Mask 0–58	Specify the number of digits to mask in an outgoing fax number. Note: 0 is the factory default setting.

Use	To
<p>Fax Cover Page</p> <ul style="list-style-type: none"> Fax Cover Page <ul style="list-style-type: none"> Off by default On by default Never use Always use Include to Field <ul style="list-style-type: none"> On Off Include from Field <ul style="list-style-type: none"> On Off From <ul style="list-style-type: none"> Include Message Field <ul style="list-style-type: none"> On Off Message <ul style="list-style-type: none"> Include Logo <ul style="list-style-type: none"> On Off Include Footer [x] <ul style="list-style-type: none"> On Off Footer [x] 	<p>Configure the fax cover page.</p> <p>Notes:</p> <ul style="list-style-type: none"> • “Off by default” is the factory default setting for Fax Cover Page. • Off is the factory default setting for all other menu items.
<p>Resolution</p> <ul style="list-style-type: none"> Standard Fine 200 dpi Super Fine 300 dpi Ultra Fine 600 dpi 	<p>Specify quality in dots per inch (dpi). A higher resolution gives better print quality, but increases the fax transmission time for outgoing faxes.</p> <p>Note: Standard is the factory default setting.</p>

Use	To
<p>Original Size</p> <ul style="list-style-type: none"> Letter Legal Executive Folio Statement Oficio (Mexico) Universal Auto Size Sense Mixed Sizes A4 A5 A6 JIS B5 Custom Scan Size [x] Book Original Business Card 3 x 5 in. 4 x 6 in. 	<p>Specify the paper size of the original document.</p> <p>Note: Mixed Sizes is the U.S. factory default setting. A4 is the international factory default setting.</p>
<p>Sides (Duplex)</p> <ul style="list-style-type: none"> Off Long edge Short edge 	<p>Specify the page orientation of text and graphics.</p> <p>Notes:</p> <ul style="list-style-type: none"> • Off is the factory default setting. • Long edge assumes binding along the long edge of the page (left edge for portrait and top edge for landscape). • Short edge assumes binding along the short edge of the page (top edge for portrait and left edge for landscape).
<p>Content Type</p> <ul style="list-style-type: none"> Text Graphics Text/Photo Photo 	<p>Specify the content of the original document.</p> <p>Note: Text is the factory default setting.</p>
<p>Content Source</p> <ul style="list-style-type: none"> Black/White Laser Color Laser Inkjet Photo/Film Magazine Newspaper Press Other 	<p>Specify how the original document was produced.</p> <p>Note: Black/White Laser is the factory default setting.</p>
<p>Darkness</p> <ul style="list-style-type: none"> 1–9 	<p>Lighten or darken the output.</p> <p>Note: 5 is the factory default setting.</p>
<p>Dial Prefix</p>	<p>Enter a dialing prefix, such as 99. A numeric entry field is provided.</p>

Use	To
Dialing Prefix Rules Prefix Rule [x]	Establish a dialing prefix rule.
Automatic Redial 0–9	Specify the number of times the printer tries to send the fax to a specified number. Note: 5 is the factory default setting.
Redial frequency 1–200	Specify the number of minutes between redials. Note: 3 is the factory default setting.
Behind a PABX Yes No	Enable or disable switchboard blind dialing without a dial tone. Note: No is the factory default setting.
Enable ECM Yes No	Enable or disable Error Correction Mode for fax jobs. Note: Yes is the factory default setting.
Enable Fax Scans On Off	Fax files that are scanned at the printer. Note: On is the factory default setting.
Driver to fax Yes No	Allow the printer driver to send fax jobs. Note: Yes is the factory default setting.
Allow Save as Shortcut On Off	Save fax numbers as shortcuts in the printer. Note: On is the factory default setting.
Dial Mode Tone Pulse	Specify the dialing sound, either as a tone or as a pulse. Note: Tone is the factory default setting.
Max Speed 2400 4800 9600 14400 33600	Specify the maximum speed in baud at which faxes are sent. Note: 33600 is the factory default setting.
Custom Job scanning On Off	Scan a document that contains mixed paper sizes into a single file. Notes: <ul style="list-style-type: none"> • Off is the factory default setting. • This menu item appears only when a formatted, working printer hard disk is installed.
Scan Preview On Off	Specify whether a preview will appear on the display for scan jobs. Notes: <ul style="list-style-type: none"> • Off is the factory default setting. • This menu item appears only when a formatted, working printer hard disk is installed.

Use	To
Background Removal -4 to 4	Adjust the amount of background visible on a scanned image. Note: 0 is the factory default setting.
Contrast 0–5 Best for content	Specify the contrast in the scanned image. Note: “Best for content” is the factory default setting.
Mirror Image Off On	Create a mirror image of the original document. Note: Off is the factory default setting.
Negative Image Off On	Create a negative image of the original document. Note: Off is the factory default setting.
Shadow Detail -4 to 4	Adjust the amount of shadow detail visible. Note: 0 is the factory default setting.
Adjust ADF Skew Auto Off On	Correct the slight skew in the scanned image. Notes: <ul style="list-style-type: none"> • Off is the factory default setting. • This menu item is supported only in select printer models.
Scan edge to edge Off On	Specify if the original document is scanned edge-to-edge prior to faxing. Note: Off is the factory default setting.
Sharpness 1–5	Adjust the sharpness of a fax. Note: 3 is the factory default setting.
Temperature -4 to 4	Specify “warm” or “cool” outputs. “Cool” values generate a bluer output than the default while “warm” values generate a redder output than the default. Note: 0 is the factory default setting.
Auto Convert Color Faxes to Mono Faxes On Off	Convert all outgoing faxes to black and white. Note: On is the factory default setting.
Use	To
Enable Fax Receive On Off	Allow the printer to receive fax jobs. Note: On is the factory default setting.
Fax Job Waiting None Toner Toner and Supplies	Remove fax jobs from the print queue when the job requires specific unavailable resources. Note: None is the factory default setting.
Rings to Answer 1–25	Specify the number of rings before answering an incoming fax job. Note: 3 is the factory default setting.

Use	To
Auto Reduction On Off	Scale an incoming fax job so that it fits the size of the paper loaded in the designated fax source. Note: On is the factory default setting.
Paper Source Auto Tray [x] Multipurpose Feeder	Specify the paper source for printing incoming fax jobs. Note: Auto is the factory default setting.
Sides (Duplex) Off On	Enable two-sided (duplex) printing for incoming fax jobs. Notes: <ul style="list-style-type: none"> • Off is the factory default setting. • This menu item appears only when a print duplexer is installed.
Separator Sheets Off Before Job After Job	Enable the printer to include separator sheets for incoming fax jobs. Note: Off is the factory default setting.
Separator Sheet Source Tray [x] Multipurpose Feeder	Specify where the printer will pick the separator sheet. Note: Tray 1 is the factory default setting.
Fax Footer On Off	Print the transmission information at the bottom of each page from a received fax. Note: Off is the factory default setting.
Max Speed 2400 4800 9600 14400 33600	Specify the maximum speed in baud at which faxes are received. Note: 33600 is the factory default setting.
Fax Forwarding Print Print and Forward Forward	Enable forwarding of received faxes to another recipient. Note: Print is the factory default setting.
Forward to Fax E-mail FTP LDSS eSF	Specify the type of recipient to which faxes will be forwarded. Notes: <ul style="list-style-type: none"> • Fax is the factory default setting. • This menu item is available only from the Embedded Web Server.
Forward to Shortcut	Enter the shortcut number which matches the recipient type (Fax, E-mail, FTP, LDSS, or eSF). Note: You can enter up to 16 characters.

Use	To
Block No Name Fax Off On	Enable blocking of incoming faxes sent from devices with no station ID or fax ID specified. Note: Off is the factory default setting.
Banned Fax List	Enable the list of blocked fax numbers stored in the printer. Note: You can enter up to 512 characters.
Use	To
Transmission Log Print log Do not print log Print only for error	Enable printing of a transmission log after each fax job. Note: "Print log" is the factory default setting.
Receive Error Log Print Never Print on Error	Enable printing of a receive error log following a receive error. Note: Print Never is the factory default setting.
Auto Print Logs On Off	Enable automatic printing of fax logs. Notes: <ul style="list-style-type: none"> • On is the factory default setting. • Logs print after every 200 fax jobs.
Log Paper Source Tray [x] Multipurpose Feeder	Specify the source of the paper used for printing logs. Note: Tray 1 is the factory default setting.
Logs Display Remote Station Name Dialed Number	Specify whether printed logs display the dialed number or the station name or fax name returned. Note: Remote Station Name is the factory default setting.
Enable Job Log On Off	Enable access to the Fax Job log. Note: On is the factory default setting.
Enable Call Log On Off	Enable access to the Fax Call log. Note: On is the factory default setting.
Use	To
Speaker Mode Always Off On until Connected Always On	Specify the mode of the speaker. Notes: <ul style="list-style-type: none"> • On until Connected is the factory default setting. A sound is issued until the fax connection is made. • Always On turns the speaker on. • Always Off turns the speaker off.
Speaker Volume High Low	Control the volume setting. Note: High is the factory default setting.

Use	To
Ringer Volume Off On	Control the fax speaker ringer volume. Note: On is the factory default setting.
Ringer Volume All Rings Single Ring Only Double Ring Only Triple Ring Only Single or Double Rings Only Single or Triple Rings Only Double or Triple Rings Only	Specify ring patterns when the printer is answering calls. Note: All Rings is the factory default setting.

E-mail Settings menu

Use	To
E-mail Server Setup Subject Message File Name	Specify e-mail server information. Notes: <ul style="list-style-type: none"> You can enter up to 255 characters in the Subject field. You can enter up to 512 characters in the Message field. You can enter up to 53 characters in the File Name field.
E-mail Server Setup Send me a copy Never appears On by default Off by default Always On	Send a copy of the e-mail to the sender. Note: "Never appears" is the factory default setting.
E-mail Server Setup Max E-mail size 0–65535 KB	Specify the maximum e-mail size in kilobytes. Note: E-mails above the specified size are not sent.
E-mail Server Setup Size Error Message	Send a message when an e-mail is greater than the configured size limit. Note: You can enter up to 1024 characters.
E-mail Server Setup Limit destinations	Specify a domain name, such as a company domain name, and then limit e-mail destinations only to that domain name. Note: You can specify only one domain.

Use	To
E-mail Server Setup Web Link Setup Server Login Password Path File Name Web Link	Define the e-mail server path name, for example: /directory/path . Notes: <ul style="list-style-type: none"> • The characters * : ? < > are invalid entries for a path name. • You can enter up to 128 characters for Server, Login, Password, Path, and Web Link. • You can enter up to 53 characters for File Name.
Format PDF (.pdf) Secure PDF TIFF (.tif) JPEG (.jpg) XPS (.xps)	Specify the format of the scanned file. Note: "PDF (.pdf)" is the factory default setting.
PDF Version 1.2–1.7 A–1a	Set the version of the PDF file that will be scanned for e-mailing. Note: 1.5 is the factory default setting.
Content Type Text Graphics Text/Photo Photo	Specify the content of the original document. Note: Text/Photo is the factory default setting.
Content Source Black/White Laser Color Laser Inkjet Photo/Film Magazine Newspaper Press Other	Specify how the original document was produced. Note: Black/White Laser is the factory default setting.
Color Off On	Specify whether copies are printed in color.
Resolution 75 dpi 150 dpi 200 dpi 300 dpi 400 dpi 600 dpi	Specify the resolution of the scan in dots per inch. Note: "150 dpi" is the factory default setting.
Darkness 1–9	Lighten or darken the output. Note: 5 is the factory default setting.

Use	To
Orientation Portrait Landscape	Specify the page orientation of the scanned image. Note: Portrait is the factory default setting.
Original Size Letter Legal Executive Folio Statement Oficio (Mexico) Universal Auto Size Sense Mixed Sizes A4 A5 A6 JIS B5 Custom Scan Size [x] Book Original Business Card 3 x 5 in. 4 x 6 in.	Specify the paper size of the document being scanned. Notes: <ul style="list-style-type: none"> • Letter is the U.S. factory default setting. • A4 is the international factory default setting.
Sides (Duplex) Off Long edge Short edge	Specify the page orientation of text and graphics. Notes: <ul style="list-style-type: none"> • Off is the factory default setting. • “Long edge” assumes binding along the long edge of the page (left edge for portrait and top edge for landscape). • “Short edge” assumes binding along the short edge of the page (top edge for portrait and left edge for landscape).
JPEG Quality Best for content 5–90	Set the quality of a JPEG photo image in relation to file size and quality of the image. Notes: <ul style="list-style-type: none"> • “Best for content” is the factory default setting. • 5 reduces the file size and quality of the image. • 90 provides the best image quality, but the file size is very large. • This menu item applies to all scan functions.
Text Default 5–90	Set the quality of a text image in relation to file size and quality of the image. Note: 75 is the factory default setting.
Text/Photo Default 5–90	Set the quality of a text or photo image in relation to file size and the quality of the image. Note: 75 is the factory default setting.

Use	To
Photo Default 5–90	Set the quality of a photo image in relation to file size and the quality of the image. Note: 50 is the factory default setting.
E-mail images sent as Attachment Web Link	Specify how the images are sent. Note: Attachment is the factory default setting.
Use Multi-Page Tiff On Off	Provide a choice between single-page TIFF files and multiple-page TIFF files. For a multiple-page scan-to-e-mail job, either one TIFF file is created containing all the pages, or multiple TIFF files are created with one file for each page of the job. Notes: <ul style="list-style-type: none"> • On is the factory default setting. • This menu item applies to all scan functions.
Transmission Log Print log Do not print log Print only for error	Specify whether or not the transmission log prints. Note: “Print log” is the factory default setting.
Log Paper Source Tray [x] Multipurpose Feeder	Specify the paper source for printing e-mail logs. Note: Tray 1 is the factory default setting.
E-mail Bit Depth 1 bit 8 bit	Enable the Text/Photo mode to produce smaller file sizes by using 1-bit images. Note: “8 bit” is the factory default setting.
Custom Job scanning On Off	Copy a document that contains mixed paper sizes. Notes: <ul style="list-style-type: none"> • Off is the factory default setting. • This menu item appears only when a formatted, working printer hard disk is installed.
Scan Preview On Off	Specify whether or not a preview will appear on the display for scan jobs. Notes: <ul style="list-style-type: none"> • Off is the factory default setting. • This menu item appears only when a formatted, working printer hard disk is installed.
Allow Save as Shortcut On Off	Save e-mail addresses as shortcuts. Notes: <ul style="list-style-type: none"> • On is the factory default setting. • When set to Off, the Save as Shortcut button does not appear on the e-mail Destination screen.
Background Removal -4 to 4	Adjust the amount of background visible on a scanned image. Note: 0 is the factory default setting.

Use	To
Color Balance Cyan-Red Magenta-Green Yellow-Blue	Enable an equal balance of colors in the output.
Color Dropout Color Dropout None Red Green Blue Default Red Threshold 0–255 Default Green Threshold 0–255 Default Blue Threshold 0–255	Specify which color to drop during scanning and to adjust the dropout setting for each color threshold. Notes: <ul style="list-style-type: none"> • None is the factory default setting for Color Dropout. • 128 is the factory default setting for each color threshold.
Contrast 0–5 Best for content	Specify the contrast of the output. Note: “Best for content” is the factory default setting.
Mirror Image Off On	Create a mirror image of the original document. Note: Off is the factory default setting.
Negative Image Off On	Create a negative image of the original document. Note: Off is the factory default setting.
Shadow Detail -4 to 4	Adjust the amount of shadow detail visible on a scanned image. Note: 0 is the factory default setting.
Adjust ADF Skew Auto Off On	Correct slight skew in the scanned image. Notes: <ul style="list-style-type: none"> • Auto is the factory default setting. • This menu item appears only in select printer models.
Scan edge to edge Off On	Specify whether the original document is scanned edge-to-edge. Note: Off is the factory default setting.
Sharpness 1–5	Adjust the amount of sharpness on a scanned image. Note: 3 is the factory default setting.
Temperature -4 to 4	Enable the user to specify “warm” or “cool” outputs. “Cool” values generate a bluer output than the default, while “warm” values generate a redder output than the default. Note: 0 is the factory default setting.

Use	To
Use cc:/bcc: Off On	Enable the use of the cc and bcc fields. Note: Off is the factory default setting.

FTP Settings menu

Use	To
Format PDF (.pdf) Secure PDF (.pdf) TIFF (.tif) JPEG (.jpg) XPS (.xps)	Specify the format of the file for FTP sending. Note: PDF (.pdf) is the factory default setting.
PDF Version 1.2–1.7 A–1a	Set the version level of the PDF file for FTP sending. Note: 1.5 is the factory default setting.
Content Type Text Graphics Text/Photo Photo	Specify the content of the original document. Note: Text/Photo is the factory default setting.
Content Source Black/White Laser Color Laser Inkjet Photo/Film Magazine Newspaper Press Other	Specify how the original document was produced. Note: Black/White Laser is the factory default setting.
Color Off On	Specify whether or not copies are printed in color. Note: On is the factory default setting.
Resolution 75 dpi 150 dpi 200 dpi 300 dpi 400 dpi 600 dpi	Specify the quality of the scan in dots per inch (dpi). Note: “150 dpi” is the factory default setting.
Darkness 1–9	Lighten or darken the output. Note: 5 is the factory default setting.

Use	To
Orientation Portrait Landscape	Specify the page orientation of the scanned image. Note: Portrait is the factory default setting.
Original Size Letter Legal Executive Folio Statement Oficio (Mexico) Universal Auto Size Sense Mixed Sizes A4 A5 A6 JIS B5 Custom Scan Size [x] Book Original Business Card 3 x 5 in. 4 x 6 in.	Specify the paper size of the original document. Notes: <ul style="list-style-type: none"> • Letter is the U.S. factory default setting. • A4 is the international factory default setting.
Sides (Duplex) Off Long edge Short edge	Specify the page orientation of text and graphics. Notes: <ul style="list-style-type: none"> • Off is the factory default setting. • “Long edge” assumes binding along the long edge of the page (left edge for portrait and top edge for landscape). • “Short edge” assumes binding along the short edge of the page (top edge for portrait and left edge for landscape).
JPEG Quality Best for content 5–90	Set the quality of a JPEG photo image in relation to the file size and quality of the image. Notes: <ul style="list-style-type: none"> • “Best for content” is the factory default setting. • 5 reduces the file size, but the quality of the image is lessened. • 90 provides the best image quality, but the file size is very large. • This menu item applies to all scan functions.
Text Default 5–90	Set the quality of the text in relation to the file size and quality of the image. Note: 75 is the factory default setting.
Text/Photo Default 5–90	Set the quality of a text/photo image in relation to the file size and quality of the image. Note: 75 is the factory default setting.

Use	To
Photo Default 5–90	Set the quality of a photo image in relation to the file size and quality of the image. Note: 50 is the factory default setting.
Use Multi-Page TIFF On Off	Provide a choice between single-page TIFF files and multiple-page TIFF files. For a multiple-page scan-to-FTP job, either one TIFF file is created containing all the pages, or multiple TIFF files are created with one file for each page of the job. Notes: <ul style="list-style-type: none"> • On is the factory default setting. • This menu item applies to all scan functions.
Transmission Log Print log Do not print log Print only for error	Specify whether the transmission log prints. Note: “Print log” is the factory default setting.
Log Paper Source Tray [x] Multipurpose Feeder	Specify a paper source when printing FTP logs. Note: Tray 1 is the factory default setting.
FTP bit Depth 1 bit 8 bit	Enable the Text/Photo mode to have smaller file sizes by using 1-bit images. Note: 8 bit is the factory default setting.
File Name	Type a base file name. Note: You can enter up to 53 characters.
Custom Job Scanning On Off	Copy a document that contains mixed paper sizes into a single scan job. Note: Off is the factory default setting.
Scan Preview On Off	Specify whether a preview will appear on the display for scan jobs. Notes: <ul style="list-style-type: none"> • Off is the factory default setting. • This menu item appears only when a formatted, working printer hard disk is installed.
Allow Save as Shortcut On Off	Enable shortcut creation for FTP addresses. Note: On is the factory default setting.
Background Removal -4 to 4	Adjust the amount of background visible on a copy. Note: 0 is the factory default setting.
Color Balance Cyan-Red Magenta-Green Yellow-Blue	Enable an equal balance of colors in the output.

Use	To
<p>Color Dropout</p> <p>Color Dropout</p> <ul style="list-style-type: none"> None Red Green Blue <p>Default Red Threshold</p> <p>0–255</p> <p>Default Green Threshold</p> <p>0–255</p> <p>Default Blue Threshold</p> <p>0–255</p>	<p>Specify which color to drop during scanning, and how much the dropout is increased or decreased.</p> <p>Notes:</p> <ul style="list-style-type: none"> • None is the factory default setting for Color Dropout. • 128 is the factory default setting for each color threshold.
<p>Contrast</p> <p>0–5</p> <p>Best for content</p>	<p>Specify the contrast of the output.</p> <p>Note: “Best for content” is the factory default setting.</p>
<p>Mirror Image</p> <p>Off</p> <p>On</p>	<p>Create a mirror image of the original document.</p> <p>Note: Off is the factory default setting.</p>
<p>Negative Image</p> <p>Off</p> <p>On</p>	<p>Create a negative image of the original document.</p> <p>Note: Off is the factory default setting.</p>
<p>Shadow Detail</p> <p>-4 to 4</p>	<p>Adjust the amount of shadow detail visible on a scanned image.</p> <p>Note: 0 is the factory default setting.</p>
<p>Adjust ADF Skew</p> <p>Auto</p> <p>Off</p> <p>On</p>	<p>Correct slight skew in the scanned image.</p> <p>Notes:</p> <ul style="list-style-type: none"> • Auto is the factory default setting. • This menu item is supported only in select printer models.
<p>Scan edge to edge</p> <p>Off</p> <p>On</p>	<p>Specify whether the original document is scanned edge-to-edge.</p> <p>Note: Off is the factory default setting.</p>
<p>Sharpness</p> <p>1–5</p>	<p>Adjust the amount of sharpness of a scanned image.</p> <p>Note: 3 is the factory default setting.</p>
<p>Temperature</p> <p>-4 to 4</p>	<p>Enable the user to specify “warm” or “cool” outputs. “Cool” values generate a bluer output than the default while “warm” values generate a redder output than the default.</p> <p>Note: 0 is the factory default setting.</p>

Flash Drive menu

Scan Settings

Use	To
Format PDF (.pdf) Secure PDF TIFF (.tif) JPEG (.jpg) XPS (.xps)	Specify the format of the file to be sent through FTP. Note: "PDF (.pdf)" is the factory default setting.
PDF Version 1.2–1.7 A-1a	Set the version of the PDF file to be sent through FTP. Note: 1.5 is the factory default setting.
Content Type Text Graphics Text/Photo Photo	Specify the content of the original document. Note: Text/Photo is the factory default setting.
Content Source Black and White Laser Color Laser Inkjet Photo/Film Magazine Newspaper Press Other	Specify how the original document was produced. Note: "Black and White Laser" is the factory default setting.
Resolution 75 dpi 150 dpi 200 dpi 300 dpi 400 dpi 600 dpi	Specify the resolution of the scan in dots per inch (dpi). Note: "150 dpi" is the factory default setting.
Darkness 1–9	Lighten or darken the output. Note: 5 is the factory default setting.
Orientation Portrait Landscape	Specify the orientation of the scanned image. Note: Portrait is the factory default setting.

Use	To
<p>Original Size</p> <ul style="list-style-type: none"> Letter Legal Executive Folio Statement Oficio (Mexico) Auto Size Sense Mixed Sizes A4 A5 A6 JIS B5 Difficult Media Letter Difficult Media A5 Difficult Media Legal Difficult Media A4 Custom Scan Size [x] Book Original Business Card 3 x 5 in. 4 x 6 in. 	<p>Specify the paper size of the original document.</p> <p>Note: Letter is the U.S. factory default setting. A4 is the international factory default setting.</p>
<p>Sides (Duplex)</p> <ul style="list-style-type: none"> Off Long Edge Short Edge 	<p>Specify the page orientation of text and graphics.</p> <p>Notes:</p> <ul style="list-style-type: none"> • Off is the factory default setting. • Long Edge assumes binding along the long edge of the page (left edge for portrait and top edge for landscape). • Short Edge assumes binding along the short edge of the page (top edge for portrait and left edge for landscape).
<p>JPEG Quality</p> <ul style="list-style-type: none"> Best for content 5–90 	<p>Set the quality of a JPEG photo image in relation to file size and quality.</p> <p>Notes:</p> <ul style="list-style-type: none"> • “Best for content” is the factory default setting. • 5 reduces the file size, but the quality of the image is lessened. • 90 provides the best image quality, but the file size is very large. • This menu item applies to all scan functions.
<p>Text Default</p> <ul style="list-style-type: none"> 5–90 	<p>Set the quality of the text in relation to file size and the quality of the image.</p> <p>Note: 75 is the factory default setting.</p>
<p>Text/Photo Default</p> <ul style="list-style-type: none"> 5–90 	<p>Set the quality of a text/photo image in relation to file size and quality.</p> <p>Note: 75 is the factory default setting.</p>
<p>Photo Default</p> <ul style="list-style-type: none"> 5–90 	<p>Set the quality of a photo image in relation to file size and quality.</p> <p>Note: 50 is the factory default setting.</p>

Use	To
Use Multi-Page TIFF On Off	Provide a choice between single-page TIFF files and multiple-page TIFF files. For a multiple-page scan to FTP job, either one TIFF file is created containing all the pages, or multiple TIFF files are created with one file for each page. Notes: <ul style="list-style-type: none"> • On is the factory default setting. • This menu item applies to all scan functions.
File Name	Type a base file name. Note: A maximum of 53 characters is allowed.
Custom Job Scanning On Off	Copy a document containing mixed paper sizes in a single copy job. Note: Off is the factory default setting.
Scan Preview On Off	Specify whether a preview appears on the display for scan jobs. Note: Off is the factory default setting.
Background Removal -4 to 4	Adjust the amount of background visible on a copy. Note: 0 is the factory default setting.
Contrast 0–5 Best for content	Specify the contrast of the scanned image. Note: “Best for content” is the factory default setting.
Mirror Image Off On	Create a mirror image of the original document. Note: Off is the factory default setting.
Negative Image Off On	Create a negative image of the original document. Note: Off is the factory default setting.
Shadow Detail -4 to 4	Adjust the amount of shadow detail visible on a scanned image. Note: 0 is the factory default setting.
Scan edge to edge Off On	Specify whether the original document is scanned edge-to-edge. Note: Off is the factory default setting.
Sharpness 1–5	Adjust the amount of sharpness on a scanned image. Note: 3 is the factory default setting.
Temperature -4 to 4	Enable the user to specify “warm” or “cool” outputs. “Cool” values generate a bluer output than the default while “warm” values generate a redder output than the default.

Print Settings

Copies 1–999	Specify a default number of copies for each print job. Note: 1 is the factory default setting.
Paper Source Tray [x] Multipurpose Feeder Manual Paper Manual Envelope	Set a default paper source for all print jobs. Note: Tray 1 is the factory default setting.
Collate (1,1,1) (2,2,2) (1,2,3) (1,2,3)	Stack the pages of a print job in sequence when printing multiple copies. Note: “(1,2,3) (1,2,3)” is the factory default setting.
Sides (Duplex) 1 sided 2 sided	Specify whether prints are on one side or on both sides of the page. Note: “1 sided” is the factory default setting.
Staple Off On	Specify whether prints are stapled. Notes: <ul style="list-style-type: none"> • Off is the factory default setting. • This menu appears only when a staple finisher is installed.
Duplex Binding Long Edge Short Edge	Define binding for duplexed pages in relation to page orientation. Notes: <ul style="list-style-type: none"> • Long Edge assumes binding along the long edge of the page (left edge for portrait and top edge for landscape). • Short Edge assumes binding along the short edge of the page (top edge for portrait and left edge for landscape).
Paper Saver Off 2-Up 3-Up 4-Up 6-Up 9-Up 12-Up 16-Up	Specify that multiple-page images be printed on one side of a paper. Notes: <ul style="list-style-type: none"> • Off is the factory default setting. • The number selected is the number of page images that will print per side.
Paper Saver Ordering Horizontal Reverse Horizontal Reverse Vertical Vertical	Specify the positioning of multiple-page images. Notes: <ul style="list-style-type: none"> • Horizontal is the factory default setting. • Positioning depends on the number of page images and whether they are in portrait or landscape orientation.

<p>Paper Saver Orientation Auto Landscape Portrait</p>	<p>Specify the orientation of a multiple-page document. Note: Auto is the factory default setting. The printer chooses between portrait and landscape.</p>
<p>Paper Saver Border None Solid</p>	<p>Print a border on each page image. Note: None is the factory default setting.</p>
<p>Separator Sheets Off Between Copies Between Jobs Between Pages</p>	<p>Specify whether blank separator sheets are inserted. Notes:</p> <ul style="list-style-type: none"> • Off is the factory default setting. • Between Copies inserts a blank sheet between each copy of a print job if Collate is set to "(1,2,3) (1,2,3)." If Collate is set to "(1,1,1) (2,2,2)," then a blank page is inserted between each set of printed pages, such as after all page 1's and after all page 2's. • Between Jobs inserts a blank sheet between print jobs. • Between Pages inserts a blank sheet between each page of the print job. This setting is useful when printing transparencies or when inserting blank pages in a document .
<p>Separator Sheet Source Tray [x] Multipurpose Feeder</p>	<p>Specify the paper source for separator sheets. Note: Tray 1 is the factory default setting.</p>
<p>Blank Pages Do Not Print Print</p>	<p>Specify whether blank pages are inserted in a print job. Note: Do Not Print is the factory default setting.</p>

Print Settings

Setup menu

Use	To
<p>Printer Language PCL Emulation PS Emulation</p>	<p>Set the printer language. Notes:</p> <ul style="list-style-type: none"> • PCL Emulation is the factory default setting. • Setting a printer language as the default does not prevent a software program from sending print jobs that use another printer language.

Use	To
Job Waiting On Off	<p>Specify that print jobs be removed from the print queue if they require unavailable printer options or custom settings.</p> <p>Print jobs removed from the print queue are stored in a separate print queue, so other jobs print normally. When the missing information or options are obtained, the stored jobs print.</p> <p>Notes:</p> <ul style="list-style-type: none"> • Off is the factory default setting. • This menu setting appears only when a formatted, working printer hard disk is installed. This requirement ensures that stored jobs are not deleted if the printer loses power.
Print Area Normal Whole Page	<p>Set the logical and physical printable area.</p> <p>Notes:</p> <ul style="list-style-type: none"> • Normal is the factory default setting. When attempting to print data in the non-printable area defined by the Normal setting, the printer clips the image at the boundary. • Whole Page allows the image to be moved into the non-printable area defined by the Normal setting, but the printer will clip the image at the Normal setting boundary. This affects only pages printed using a PCL 5e interpreter. This has no effect on pages printed using the PCL XL or PostScript interpreter.
Download Target RAM Flash Disk	<p>Set the storage location for downloads.</p> <p>Notes:</p> <ul style="list-style-type: none"> • RAM is the factory default setting. Storing downloads in the RAM is temporary. • Storing downloads in flash memory or on a printer hard disk places them in permanent storage. Downloads remain in flash memory or on the printer hard disk even when the printer is turned off. • This menu setting appears only when a formatted, working flash drive or printer hard disk is installed.
Resource Save On Off	<p>Specify how the printer handles temporary downloads, such as fonts and macros stored in the RAM, when the printer receives a job that requires more memory than is available.</p> <p>Notes:</p> <ul style="list-style-type: none"> • Off is the factory default setting. This sets the printer to retain the downloads only until memory is needed. Downloads are deleted in order to process print jobs. • On retains the downloads during language changes and printer resets. If the printer runs out of memory, then Memory Full [38] appears, and downloads are not deleted.

Use	To
Print All Order Alphabetical Oldest First Newest First	Specify the order in which held and confidential jobs are printed when Print All is selected. Note: Alphabetical is the factory default setting. Print jobs always appear in alphabetical order on the printer control panel.

Finishing menu

Use	To
Sides (Duplex) 1 sided 2 sided	Specify whether two-sided (duplex) printing is set as the default for all print jobs. Notes: <ul style="list-style-type: none"> • “1 sided” is the factory default setting. • You can set two-sided printing from the printer software. For Windows users: Click File > Print, and then click Properties, Preferences, Options, or Setup. For Macintosh users: Choose File > Print, and then adjust the settings from the Print dialog and pop-up menus.
Duplex Binding Long Edge Short Edge	Define the way duplexed pages are bound and printed in relation to page orientation. Notes: <ul style="list-style-type: none"> • Long Edge is the factory default setting. This assumes binding along the long edge of the page (left edge for portrait and top edge for landscape). • Short Edge assumes binding along the short edge of the page (top edge for portrait and left edge for landscape).
Copies 1–999	Specify the default number of copies for each print job. Note: 1 is the factory default setting.
Blank Pages Do Not Print Print	Specify whether blank pages are inserted in a print job. Note: Do Not Print is the factory default setting.
Collate (1,1,1) (2,2,2) (1,2,3) (1,2,3)	Stack the pages of a print job in sequence when printing multiple copies. Notes: <ul style="list-style-type: none"> • “(1,1,1) (2,2,2)” is the factory default setting. • On stacks the print job in sequence.

Use	To
Separator Sheets Off Between Copies Between Jobs Between Pages	Specify whether blank separator sheets are inserted. Notes: <ul style="list-style-type: none"> • None is the factory default setting. • Between Copies inserts a blank sheet between each copy of a print job if Collate is set to "(1,2,3) (1,2,3)." If Collate is set to "(1,1,1) (2,2,2)," then a blank page is inserted between each set of printed pages, such as after all page 1's and after all page 2's. • Between Jobs inserts a blank sheet between print jobs. • Between Pages inserts a blank sheet between each page of a print job. This setting is useful when printing transparencies or when inserting blank pages in a document.
Separator Source Tray [x] Manual Feeder	Specify the paper source for separator sheets. Notes: <ul style="list-style-type: none"> • Tray 1 (standard tray) is the factory default setting. • From the Paper menu, set Configure MP to "Cassette" for Manual Feeder to appear as a menu setting.
Paper Saver Off 2-Up 3-Up 4-Up 6-Up 9-Up 12-Up 16-Up	Print multiple-page images on one side of a paper. Notes: <ul style="list-style-type: none"> • Off is the factory default setting. • The number selected is the number of page images that will print per side.
Paper Saver Ordering Horizontal Reverse Horizontal Reverse Vertical Vertical	Specify the positioning of multiple-page images when using Paper Saver. Notes: <ul style="list-style-type: none"> • Horizontal is the factory default setting. • Positioning depends on the number of page images and whether they are in portrait or landscape orientation.
Paper Saver Orientation Auto Landscape Portrait	Specify the orientation of a multiple-page document. Note: Auto is the factory default setting. The printer chooses between portrait and landscape.
Paper Saver Border None Solid	Print a border when using Paper Saver. Note: None is the factory default setting.
Staple Job Off On	Specify whether printed output is stapled. Notes: <ul style="list-style-type: none"> • Off is the factory default setting. • This menu item appears only when a supported staple finisher is installed.

Use	To
Run Stapler Test	Print a report that confirms that the stapler finisher is functioning properly. Note: This menu item appears only when a supported stapler finisher is installed.

Quality menu

Use	To
Print Resolution 300 dpi 600 dpi 1200 dpi 1200 Image Q 2400 Image Q	Specify the printed output resolution in dots per inch. Note: 600 dpi is the factory default setting.
Pixel Boost Off Fonts Horizontally Vertically Both directions Isolated	Enable more pixels to print in clusters for clarity, in order to enhance images horizontally or vertically, or to enhance fonts. Note: Off is the factory default setting.
Toner Darkness 1–10	Lighten or darken the printed output. Notes: <ul style="list-style-type: none"> • 8 is the factory default setting. • Selecting a smaller number can help conserve toner.
Enhance Fine Lines On Off	Enable a print mode preferable for files such as architectural drawings, maps, electrical circuit diagrams, and flow charts. Notes: <ul style="list-style-type: none"> • Off is the factory default setting. • You can set this option from the printer software. For Windows users, click File > Print, and then click Properties, Preferences, Options, or Setup. For Macintosh users, choose File > Print, and then adjust the settings from the Print dialog and pop-up menus. • To set this option using the Embedded Web Server, type the network printer IP address in the Web browser address field.
Gray Correction Auto Off	Automatically adjust the contrast enhancement applied to images. Note: Auto is the factory default setting.
Brightness -6 to 6	Adjust the printed output either by lightening or darkening it. You can conserve toner by lightening the output. Note: 0 is the factory default setting.
Contrast 0–5	Adjust the contrast of printed objects. Note: 0 is the factory default setting.

Job Accounting menu

Note: This menu item appears only when a formatted, working printer hard disk is installed. Make sure the printer hard disk is not read/write- or write-protected.

Use	To
Job Accounting Log Off On	Determine and set if the printer creates a log of the print jobs it receives. Note: Off is the factory default setting.
Job Accounting Utilities	Print and delete log files or export them to a flash drive.
Accounting Log Frequency Weekly Monthly	Determine and set how often a log file is created. Note: Monthly is the factory default setting.
Log Action at End of Frequency None E-mail Current Log E-mail & Delete Current Log Post Current Log Post & Delete Current Log	Determine and set how the printer responds when the frequency threshold expires. Note: None is the factory default setting.
Disk Near Full Level Off 1–99	Specify the maximum size of the log file before the printer executes the Disk Near Full Action. Note: 5 is the factory default setting.
Disk Near Full Action None E-mail Current Log E-mail & Delete Current Log E-mail & Delete Oldest Log Post Current Log Post & Delete Current Log Post & Delete Oldest Log Delete Current Log Delete Oldest Log Delete All Logs Delete All But Current	Determine and set how the printer responds when the printer hard disk is nearly full. Notes: <ul style="list-style-type: none"> • None is the factory default setting. • The value defined in Disk Near Full Level determines when this action is triggered.
Disk Full Action None E-mail & Delete Current Log E-mail & Delete Oldest Log Post & Delete Current Log Post & Delete Oldest Log Delete Current Log Delete Oldest Log Delete All Logs Delete All But Current	Determine and set how the printer responds when disk usage reaches the maximum limit (100MB). Note: None is the factory default setting.
URL to Post Logs	Determine and set where the printer posts job accounting logs.

Use	To
E-mail Address to Send Logs	Specify the e-mail address to which the printer sends job accounting logs.
Log File Prefix	Specify the prefix you want for the log file name. Note: The current host name defined in the TCP/IP menu is used as the default log file prefix.

Utilities menu

Use	To
Remove Held Jobs Confidential Held Not Restored All	Delete confidential and held jobs from the printer hard disk. Notes: <ul style="list-style-type: none"> • Selecting a setting affects only print jobs that are resident in the printer. Bookmarks, print jobs on flash drives, and other types of held jobs are not affected. • Not Restored removes all Print and Hold jobs that are <i>not</i> restored from the printer hard disk or memory.
Format Flash Yes No	Format the flash memory. Warning—Potential Damage: Do not turn off the printer while the flash memory is being formatted. Notes: <ul style="list-style-type: none"> • Yes deletes all data stored in flash memory. • No cancels the format request. • Flash memory refers to the memory added by installing a flash memory card in the printer. • The flash memory option card must not be read/write- or write-protected. • This menu item appears only when a non-defective flash memory card is installed.
Delete Downloads on Disk Delete Now Do Not Delete	Delete downloads from the printer hard disk, including all held jobs, buffered jobs, and parked jobs. Notes: <ul style="list-style-type: none"> • Delete Now sets the printer to delete the downloads and allows the display to return to the originating screen after the deletion. • Do Not Delete sets the printer display to return to the main Utilities menu for touch-screen printer models. When selected in non-touch-screen printer models, Do Not Delete sets the printer to return to the originating screen after the deletion.
Activate Hex Trace	Assist in isolating the source of a print job problem. Notes: <ul style="list-style-type: none"> • When activated, all data sent to the printer is printed in hexadecimal and character representation, and control codes are not executed. • To exit or deactivate Hex Trace, turn off or reset the printer.

Use	To
Coverage Estimator Off On	Provide an estimate of the percentage coverage of toner on a page. The estimate is printed on a separate page at the end of each print job. Note: Off is the factory default setting.

XPS menu

Use	To
Print Error Pages Off On	Print a page containing information on errors, including XML markup errors. Note: Off is the factory default setting.

PDF menu

Use	To
Scale to Fit Yes No	Scale page content to fit the selected paper size. Note: No is the factory default setting.
Annotations Do Not Print Print	Print annotations in a PDF. Note: Do Not Print is the factory default setting.

PostScript menu

Use	To
Print PS Error On Off	Print a page containing the PostScript error. Note: Off is the factory default setting.
Lock PS Startup Mode On Off	Disable the SysStart file. Note: Off is the factory default setting.
Font Priority Resident Flash/Disk	Establish the font search order. Notes: <ul style="list-style-type: none"> • Resident is the factory default setting. • This menu item is available only when a formatted flash memory option card or printer hard disk is installed and operating properly. • Make sure the flash memory option or printer hard disk is not read/write-, write-, or password-protected. • Job Buffer Size must not be set to 100%.

PCL Emul menu

Use	To
Font Source Resident Disk Download Flash All	Specify the set of fonts used by the Font Name menu. Notes: <ul style="list-style-type: none"> • “Resident” is the factory default setting. Resident shows the factory default set of fonts downloaded in the RAM. • “Flash” and “Disk” settings show all fonts resident in that option. • The flash option must be properly formatted and cannot be read/write-, write-, or password-protected. • “Download” shows all the fonts downloaded in the RAM. • “All” shows all fonts available to any option.
Font Name Courier 10	Identify a specific font and the option where it is stored. Note: Courier 10 is the factory default setting. Courier 10 shows the font name, font ID, and the storage location in the printer. The font source abbreviation is R for Resident, F for Flash, K for Disk, and D for Download.
Symbol Set 10U PC-8 12U PC-850	Specify the symbol set for each font name. Notes: <ul style="list-style-type: none"> • 10U PC-8 is the US factory default setting. 12U PC-850 is the international factory default setting. • A symbol set is a set of alphabetic and numeric characters, punctuation, and special symbols. Symbol sets support the different languages or specific programs such as math symbols for scientific text. Only the supported symbol sets are shown.
PCL Emulation Settings Point Size 1.00–1008.00	Change the point size for scalable typographic fonts. Notes: <ul style="list-style-type: none"> • 12 is the factory default setting. • Point size refers to the height of the characters in the font. One point equals approximately 0.014 inch. • Point sizes can be increased or decreased in 0.25-point increments.
PCL Emulation Settings Pitch 0.08–100	Specify the font pitch for scalable monospaced fonts. Notes: <ul style="list-style-type: none"> • 10 is the factory default setting. • Pitch refers to the number of fixed-space characters per inch (cpi). • Pitch can be increased or decreased in 0.01-cpi increments. • For nonscalable monospaced fonts, the pitch appears on the display but it cannot be changed.
PCL Emulation Settings Orientation Portrait Landscape	Specify the orientation of text and graphics on the page. Notes: <ul style="list-style-type: none"> • Portrait is the factory default setting. Portrait prints text and graphics parallel to the short edge of the page. • Landscape prints text and graphics parallel to the long edge of the page.

Use	To
PCL Emulation Settings Lines per Page 1–255	Specify the number of lines that print on each page. Notes: <ul style="list-style-type: none"> • 60 is the US factory default setting. 64 is the international default setting. • The printer sets the amount of space between each line based on the Lines per Page, Paper Size, and Orientation settings. Select the Paper Size and Orientation you want before setting Lines per Page.
PCL Emulation Settings A4 Width 198 mm 203 mm	Set the printer to print on A4-size paper. Notes: <ul style="list-style-type: none"> • “198 mm” is the factory default setting. • The 203-mm setting sets the width of the page to allow printing of eighty 10-pitch characters.
PCL Emulation Settings Auto CR after LF On Off	Specify whether the printer automatically performs a carriage return (CR) after a line feed (LF) control command. Note: Off is the factory default setting.
PCL Emulation Settings Auto LF after CR On Off	Specify whether the printer automatically performs a line feed (LF) after a carriage return (CR) control command. Note: Off is the factory default setting.
Tray Renumber Assign MP Feeder Off None 0–199 Assign Tray [x] Off None 0–199 Assign Manual Paper Off None 0–199 Assign Manual Env Off None 0–199	Configure the printer to work with printer software or programs that use different source assignments for trays and feeders. Notes: <ul style="list-style-type: none"> • “Off” is the factory default setting. • “None” ignores the Select Paper Feed command. This option appears only when it is selected by the PCL 5 interpreter. • “0–199” allows a custom setting to be assigned.

Use	To
<p>Tray Renumber</p> <ul style="list-style-type: none"> View Factory Defaults MPF Default = 8 T1 Default = 1 T1 Default = 4 T1 Default = 5 T1 Default = 20 T1 Default = 21 Env Default = 6 MPaper Default = 2 MEnv Default = 3 	<p>Display the factory default setting assigned to each tray or feeder.</p>
<p>Tray Renumber</p> <ul style="list-style-type: none"> Restore Defaults Yes No 	<p>Restore all tray and feeder assignments to the factory default settings.</p>

HTML menu

Use		To
<p>Font Name</p> <ul style="list-style-type: none"> Albertus MT Antique Olive Apple Chancery Arial MT Avant Garde Bodoni Bookman Chicago Clarendon Cooper Black Copperplate Coronet Courier Eurostile Garamond Geneva Gill Sans Goudy Helvetica Hoefler Text Intl CG Times Intl Courier Intl Univers 	<ul style="list-style-type: none"> Joanna MT Letter Gothic Lubalin Graph Marigold MonaLisa Recut Monaco New CenturySbk New York Optima Oxford Palatino StempelGaramond Taffy Times TimesNewRoman Univers Zapf Chancery NewSansMTCS NewSansMTCT New SansMTJA NewSansMTKO 	<p>Set the default font for HTML documents.</p> <p>Note: The Times font is used in HTML documents that do not specify a font.</p>

Use	To
Font Size 1–255 pt	Set the default font size for HTML documents. Notes: <ul style="list-style-type: none"> • 12 pt is the factory default setting. • Font size can be increased in 1-point increments.
Scale 1–400%	Scale the default font for HTML documents. Notes: <ul style="list-style-type: none"> • 100% is the factory default setting. • Scaling can be increased in 1% increments.
Orientation Portrait Landscape	Set the page orientation for HTML documents. Note: Portrait is the factory default setting.
Margin Size 8–255 mm	Set the page margin for HTML documents. Notes: <ul style="list-style-type: none"> • 19 mm is the factory default setting. • Margin size can be increased in 1-mm increments.
Backgrounds Do Not Print Print	Specify whether to print backgrounds on HTML documents. Note: Print is the factory default setting.

Image menu

Use	To
Auto Fit On Off	Select the optimal paper size, scaling, and orientation. Note: On is the factory default setting. It overrides scaling and orientation settings for some images.
Invert On Off	Invert bitonal monochrome images. Notes: <ul style="list-style-type: none"> • Off is the factory default setting. • This setting does not apply to GIF or JPEG images.
Scaling Anchor Top Left Best Fit Anchor Center Fit Height/Width Fit Height Fit Width	Scale the image to fit the selected paper size. Notes: <ul style="list-style-type: none"> • Best Fit is the factory default setting. • When Auto Fit is set to On, Scaling is automatically set to Best Fit.

Use	To
Orientation Portrait Landscape Reverse Portrait Reverse Landscape	Set the image orientation. Note: Portrait is the factory default setting.

Help menu

The Help menu consists of a series of Help pages that are stored in the multifunction printer (MFP) as PDF files. They contain information about using the printer and performing various tasks, including copying, scanning, and faxing.

English, French, German, and Spanish translations are stored in the printer. Other translations are available at <http://support.lexmark.com>.

Menu item	Description
Print All Guides	Prints all the guides
Copy Guide	Provides information about making copies and changing settings
E-mail Guide	Provides information about sending e-mails using addresses, shortcut numbers, or the address book, and about changing settings
Fax Guide	Provides information about sending faxes using fax numbers, shortcut numbers, or the address book, and about changing settings
FTP Guide	Provides information about scanning documents directly to an FTP server using an FTP address, shortcut numbers, or the address book, and about changing settings
Print Defects Guide	Provides help in resolving repeating defects in copies or prints
Information Guide	Provides help in locating additional information
Supplies Guide	Provides part numbers for ordering supplies

Saving money and the environment

Lexmark is committed to environmental sustainability and is continually improving its printers to reduce their impact on the environment. We design with the environment in mind, engineer our packaging to reduce materials, and provide collection and recycling programs. For more information, see:

- The Notices chapter
- The Environmental Sustainability section of the Lexmark Web site at www.lexmark.com/environment
- The Lexmark recycling program at www.lexmark.com/recycle

By selecting certain printer settings or tasks, you may be able to reduce your printer's impact even further. This chapter outlines the settings and tasks that may yield a greater environmental benefit.

Saving paper and toner

Studies show that as much as 80% of the carbon footprint of a printer is related to paper usage. You can significantly reduce your carbon footprint by using recycled paper and the following printing suggestions, such as printing on both sides of the paper and printing multiple pages on one side of a single sheet of paper.

For more information on how you can quickly save paper and energy using one printer setting, see “Using Eco-Mode” on page 211.

Conserving supplies

Use both sides of the paper

If your printer model supports duplex printing, then you can control whether print appears on one or two sides of the paper by selecting **2-sided printing** from the Print dialog or from the Lexmark Toolbar.

Place multiple pages on one sheet of paper

You can print up to 16 consecutive pages of a multiple-page document onto one side of a single sheet of paper by selecting a setting from the Multipage printing (N-Up) section of the Print dialog screen.

Check your first draft for accuracy

Before printing or making multiple copies of a document:

- Use the preview feature, which you can select from the Print dialog or from the Lexmark Toolbar to see how the document will look like before you print it.
- Print one copy of the document to check its content and format for accuracy.

Avoid paper jams

Correctly set the paper type and size to avoid paper jams. For more information, see “Avoiding jams” on page 235.

Saving energy

Using Eco-Mode

1 Open a Web browser, and then type the printer IP address in the address field.

Notes:

- View the printer IP address on the printer home screen. The IP address appears as four sets of numbers separated by periods, such as 123.123.123.123.
- If you are using a proxy server, then temporarily disable it to load the Web page correctly.

2 Click **Settings > General Settings > Eco-Mode > select a setting**

Use	To
Off	Use the factory default settings for all settings associated with Eco-Mode. Off supports the performance specifications of the printer.
Energy	Reduce energy use, especially when the printer is idle. <ul style="list-style-type: none"> • Printer engine motors do not start until it is ready to print. You may notice a short delay before the first page is printed. • The printer enters Sleep mode after one minute of inactivity.
Energy/Paper	Use all the settings associated with Energy and Paper modes.
Plain Paper	<ul style="list-style-type: none"> • Enable the automatic two-sided (duplex) feature. • Turn off print log features.

3 Click **Submit**.

Reducing printer noise

Enable Quiet Mode to reduce printer noise.

1 Open a Web browser, and then type the printer IP address in the address field.

Notes:

- View the printer IP address on the printer home screen. The IP address appears as four sets of numbers separated by periods, such as 123.123.123.123.
- If you are using a proxy server, then temporarily disable it to load the Web page correctly.

2 Click **Settings > General Settings > Quiet Mode > select a setting**

Use	To
On	Reduce printer noise. Notes: <ul style="list-style-type: none"> • Print jobs are processed at a reduced speed. • Printer engine motors do not start until a document is ready to print. There will be a short delay before the first page is printed.
Off	Use factory default settings. Note: This setting supports the performance specifications of the printer.

3 Click **Submit**.

Adjusting Sleep mode

To save energy, decrease the number of minutes the printer waits before it enters Sleep mode.

Available settings range from 1–180 minutes. The factory default setting is 30 minutes.

Using the Embedded Web Server

1 Open a Web browser, and then type the printer IP address in the address field.

Notes:

- View the printer IP address on the printer home screen. The IP address appears as four sets of numbers separated by periods, such as 123.123.123.123.
- If you are using a proxy server, then temporarily disable it to load the Web page correctly.

2 Click **Settings > General Settings > Timeouts**.

3 In the Sleep Mode field, enter the number of minutes you want for the printer to wait before it enters Sleep Mode.

4 Click **Submit**.

Using the printer control panel

1 From the home screen, navigate to:



> **Settings > General Settings > Timeouts > Sleep Mode**

2 In the Sleep Mode field, select the number of minutes you want for the printer to wait before it enters Sleep Mode.

3 Touch .

Using Hibernate Mode

Hibernate is an ultra-low power operating mode. When operating in Hibernate mode, the printer is essentially off, and all other systems and devices are powered down safely.

Note: The Hibernate and Sleep modes can be scheduled.

Using the Embedded Web Server

- 1 Open a Web browser, and then type the printer IP address in the address field.

Notes:

- View the printer IP address on the printer home screen. The IP address appears as four sets of numbers separated by periods, such as 123.123.123.123.
- If you are using a proxy server, then temporarily disable it to load the Web page correctly.

- 2 Click **Settings > General Settings > Sleep Button Settings**.
- 3 From the Press Sleep Button or Press and Hold Sleep Button drop-down menu, select **Hibernate**.
- 4 Click **Submit**.

Using the printer control panel

- 1 From the home screen, navigate to:



> **Settings > General Settings**

- 2 Touch **Press Sleep Button** or **Press and Hold Sleep Button**.
- 3 Touch **Hibernate** > .

Setting Hibernate Timeout

Hibernate Timeout lets you set the amount of time the printer waits after a print job is processed before it goes into a reduced power state.

Using the Embedded Web Server

- 1 Open a Web browser, and then type the printer IP address in the address field.

Notes:

- View the printer IP address on the printer home screen. The IP address appears as four sets of numbers separated by periods, such as 123.123.123.123.
- If you are using a proxy server, then temporarily disable it to load the Web page correctly.

- 2 Click **Settings > General Settings > Timeouts**.
- 3 From the Hibernate Timeout menu, select the number of hours, days, weeks, or months you want for the printer to wait before it goes into a reduced power state.
- 4 Click **Submit**.

Using the printer control panel

- 1 From the printer control panel, navigate to:



> **Settings** > **General Settings** > **Timeouts** > **Hibernate Timeout**

- 2 Select the amount of time the printer waits after a print job is processed before it enters Hibernate mode.
- 3 Touch .

Using Schedule Power Modes

Schedule Power Modes lets you schedule when the printer goes into a reduced power state or into Ready state.

Note: This feature is available only in network printers or printers connected to print servers.

Using the Embedded Web Server

- 1 Open a Web browser, and then type the printer IP address in the address field.

Notes:

- View the printer IP address on the printer home screen. The IP address appears as four sets of numbers separated by periods, such as 123.123.123.123.
- If you are using a proxy server, then temporarily disable it to load the Web page correctly.

- 2 Click **Settings** > **General Settings** > **Schedule Power Modes**.
- 3 From the Action menu, select the power mode.
- 4 From the Time menu, select the time.
- 5 From the Day(s) menu, select the day or days.
- 6 Click **Add**.

Adjusting the brightness of the display

To save energy, or if you are have trouble reading your display, adjust the brightness of the display.

Available settings range from 20–100. The factory default setting is 100.

Using the Embedded Web Server

- 1 Open a Web browser, and then type the printer IP address in the address field.

Notes:

- View the printer IP address on the home screen. The IP address appears as four sets of numbers separated by periods, such as 123.123.123.123.
- If you are using a proxy server, then temporarily disable it to load the Web page correctly.

- 2 Click **Settings** > **General Settings**.
- 3 In the Screen Brightness field, enter the brightness percentage you want for the display.
- 4 Click **Submit**.

Using the printer control panel

1 From the home screen, navigate to:

 > **Settings** > **General Settings** > **Screen Brightness**

2 In the Screen Brightness field, enter the brightness percentage you want for the display.

3 Touch .

Recycling

Recycling Lexmark products

To return Lexmark products for recycling:

- 1 Go to www.lexmark.com/recycle.
- 2 Find the product type you want to recycle, and then select your country or region from the list.
- 3 Follow the instructions on the computer screen.

Note: Printer supplies and hardware not listed in the Lexmark collection program may be recycled through your local recycling center. Contact your local recycling center to determine the items they accept.

Recycling Lexmark packaging

Lexmark continually strives to minimize packaging. Less packaging helps to ensure that Lexmark printers are transported in the most efficient and environmentally sensitive manner and that there is less packaging to dispose of. These efficiencies result in fewer greenhouse emissions, energy savings, and natural resource savings.

Lexmark cartons are 100% recyclable where corrugated recycling facilities exist. Facilities may not exist in your area.

The foam used in Lexmark packaging is recyclable where foam recycling facilities exist. Facilities may not exist in your area.

When you return a cartridge to Lexmark, you can reuse the box that the cartridge came in. Lexmark will recycle the box.

Returning Lexmark cartridges for reuse or recycling

Lexmark Cartridge Collection Program diverts millions of Lexmark cartridges from landfills annually by making it both easy and free for Lexmark customers to return used cartridges to Lexmark for reuse or recycling. One hundred percent of the empty cartridges returned to Lexmark are either reused or demanufactured for recycling. Boxes used to return the cartridges are also recycled.

To return Lexmark cartridges for reuse or recycling, follow the instructions that came with your printer or cartridge and use the prepaid shipping label. You can also do the following:

- 1 Go to www.lexmark.com/recycle.
- 2 From the Toner Cartridges section, select your country or region.
- 3 Follow the instructions on the computer screen.

Securing the printer

Statement of Volatility

Your printer contains various types of memory that can store device and network settings, and user data.

Types of memory	Description
Volatile memory	Your printer uses standard <i>Random Access Memory</i> (RAM) to temporarily buffer user data during simple print and copy jobs.
Non-volatile memory	Your printer may use two forms of non-volatile memory: EEPROM and NAND (flash memory). Both types are used to store the operating system, device settings, network information, scanner and bookmark settings, and embedded solutions.
Hard disk memory	Some printers have a hard disk drive installed. The printer hard disk is designed for device-specific functionality. This lets the device retain buffered user data from complex scan, print, copy, and fax jobs, as well as form data, and font data.

Erase the content of any installed printer memory in the following circumstances:

- The printer is being decommissioned.
- The printer hard disk is being replaced.
- The printer is being moved to a different department or location.
- The printer is being serviced by someone from outside your organization.
- The printer is being removed from your premises for service.
- The printer is being sold to another organization.

Disposing of a printer hard disk

Note: Some printer models may not have a printer hard disk installed.

In high-security environments, it may be necessary to take additional steps to make sure that confidential data stored in the printer hard disk cannot be accessed when the printer—or its hard disk—is removed from your premises.

- **Degaussing**—Flushes the hard disk with a magnetic field that erases stored data
- **Crushing**—Physically compresses the hard disk to break component parts and render them unreadable
- **Milling**—Physically shreds the hard disk into small metal bits

Note: Most data can be erased electronically, but the only way to guarantee that all data is completely erased is to physically destroy each hard disk where data is stored.

Erasing volatile memory

The volatile memory (RAM) installed in your printer requires a power source to retain information. To erase the buffered data, simply turn off the printer.

Erasing non-volatile memory

- **Individual settings, device and network settings, security settings, and embedded solutions**—Erase information and settings by selecting **Wipe All Settings** in the Configuration menu.
- **Fax data**—Erase fax settings and data by selecting **Wipe All Settings** in the Configuration menu.

1 Turn off the printer.

2 Hold down **2** and **6** while turning the printer on. Release the buttons only when the screen with the progress bar appears.

The printer performs a power-on sequence, and then the Configuration menu appears. When the printer is fully powered up, the touch screen displays a list of functions, instead of the standard home screen icons.

3 Touch **Wipe All Settings**.

The printer will restart several times during this process.

Note: Wipe All Settings securely removes device settings, solutions, jobs, faxes, and passwords from the printer memory.

4 Touch **Back > Exit Config Menu**.

The printer will perform a power-on reset, and then return to normal operating mode.

Erasing printer hard disk memory

Notes:

- Some printer models may not have a printer hard disk installed.
- Configuring Erase Temporary Data Files in the printer menus lets you remove residual confidential material left by print jobs by securely overwriting files that have been marked for deletion.

Using the printer control panel

1 Turn off the printer.

2 Hold down **2** and **6** while turning the printer on. Release the buttons only when the screen with the progress bar appears.

The printer performs a power-on sequence, and then the Configuration menu appears. When the printer is fully turned on, the touch screen displays a list of functions.

3 Touch **Wipe Disk**, and then touch one of the following:

- **Wipe disk (fast)**—This lets you overwrite the disk with all zeroes in a single pass.
- **Wipe disk (secure)**—This lets you overwrite the disk with random bit patterns several times, followed by a verification pass. A secure overwrite is compliant with the DoD 5220.22-M standard for securely erasing data from a hard disk. Highly confidential information should be wiped using this method.

4 Touch **Yes** to proceed with disk wiping.

Notes:

- A status bar will indicate the progress of the disk wiping task.

- Disk wiping can take from several minutes to more than an hour, during which the printer will be unavailable for other user tasks.

5 Touch **Back** > **Exit Config Menu**.

The printer will perform a power-on reset, and then return to normal operating mode.

Configuring printer hard disk encryption

Enable hard disk encryption to prevent loss of sensitive data in the event the printer or its hard disk is stolen.

Note: Some printer models may not have a printer hard disk installed.

Using the Embedded Web Server

1 Open a Web browser, and then type the printer IP address in the address field.

Notes:

- View the printer IP address on the printer home screen. The IP address appears as four sets of numbers separated by periods, such as 123.123.123.123.
- If you are using a proxy server, then temporarily disable it to load the Web page correctly.

2 Click **Settings** > **Security** > **Disk Encryption**.

Note: Disk Encryption appears in the Security Menu only when a formatted, non-defective printer hard disk is installed.

3 From the Disk encryption menu, select **Enable**.

Notes:

- Enabling disk encryption will erase the contents of the printer hard disk.
- Disk encryption can take from several minutes to more than an hour, during which the printer will be unavailable for other user tasks.

4 Click **Submit**.

Using the printer control panel

1 Turn off the printer.

2 Hold down **2** and **6** while turning the printer on. Release the buttons only when the screen with the progress bar appears.

The printer performs a power-on sequence, and then the Configuration menu appears. When the printer is fully turned on, a list of functions appears on the printer display.

3 Touch **Disk Encryption** > **Enable**.

Note: Enabling disk encryption will erase the contents of the printer hard disk.

4 Touch **Yes** to proceed with disk wiping.

Notes:

- Do not turn off the printer during the encryption process. Doing so may result in loss of data.
- Disk encryption can take from several minutes to more than an hour, during which the printer will be unavailable for other user tasks.

- A status bar will indicate the progress of the disk wiping task. After the disk has been encrypted, the printer will return to the Enable/Disable screen.

5 Touch **Back** > **Exit Config Menu**.

The printer will perform a power-on reset, and then return to normal operating mode.

Finding printer security information

In high-security environments, it may be necessary to take additional steps to make sure that confidential data stored in the printer cannot be accessed by unauthorized persons. For more information, visit the

[Lexmark security Web page](#).

You can also see the *Embedded Web Server — Security: Administrator's Guide* for additional information:

- 1** Go to www.lexmark.com, and then navigate to **Support & Downloads** > select your printer.
- 2** Click the **Manuals** tab, and then select *Embedded Web Server — Security: Administrator's Guide*.

Maintaining the printer

Warning—Potential Damage: Failure to maintain optimum printer performance, or to replace parts and supplies, may cause damage to your printer.

Cleaning the printer parts

Cleaning the printer

Note: You may need to perform this task after every few months.

Warning—Potential Damage: Damage to the printer caused by improper handling is not covered by the printer warranty.

- 1 Make sure that the printer is turned off and unplugged from the electrical outlet.



CAUTION—SHOCK HAZARD: To avoid the risk of electrical shock when cleaning the exterior of the printer, unplug the power cord from the electrical outlet and disconnect all cables from the printer before proceeding.

- 2 Remove paper from the standard bin and multipurpose feeder.
- 3 Remove any dust, lint, and pieces of paper around the printer using a soft brush or vacuum.
- 4 Dampen a clean, lint-free cloth with water, and use it to wipe the outside of the printer.

Warning—Potential Damage: Do not use household cleaners or detergents to prevent damage to the exterior of the printer.

- 5 Make sure all areas of the printer are dry before sending a new print job.

Cleaning the scanner glass

Clean the scanner glass if you encounter print quality problems, such as streaks on copied or scanned images.

- 1 Slightly dampen a soft, lint-free cloth or paper towel with water.
- 2 Open the scanner cover.



- 3 Clean all the areas shown, and then let them dry.



1	White underside of the scanner cover
2	Scanner glass
3	ADF glass
4	White underside of the ADF cover

- 4 Close the scanner cover.

Checking the status of parts and supplies

Checking the status of parts and supplies on the printer control panel

From the home screen, touch **Status/Supplies** > **View Supplies**.

Checking the status of parts and supplies from the Embedded Web Server

Note: Make sure the computer and the printer are connected to the same network.

- 1 Open a Web browser, and then type the printer IP address in the address field.

Notes:

- View the printer IP address on the home screen. The IP address appears as four sets of numbers separated by periods, such as 123.123.123.123.
- If you are using a proxy server, then temporarily disable it to load the Web page correctly.

- 2 Click **Device Status** > **More Details**.

Estimated number of remaining pages

The estimated number of remaining pages is based on the recent printing history of the printer. Its accuracy may vary significantly and is dependent on many factors, such as actual document content, print quality settings, and other printer settings.

The accuracy of the estimated number of remaining pages may decrease when the actual printing consumption is different from the historical printing consumption. Consider the variable level of accuracy before purchasing or replacing supplies based on the estimate. Until an adequate print history is obtained on the printer, initial estimates assume future supplies consumption based on the International Organization for Standardization* test methods and page content.

* Average continuous black declared cartridge yield in accordance with ISO/IEC 19752.

Ordering supplies

To order supplies in the U.S., contact Lexmark at 1-800-539-6275 for information about Lexmark authorized supplies dealers in your area. In other countries or regions, visit the Lexmark Web site at www.lexmark.com or contact the place where you purchased the printer.

Note: All life estimates for printer supplies assume printing on letter- or A4-size plain paper.

Using genuine Lexmark parts and supplies

Your Lexmark printer is designed to function best with genuine Lexmark supplies and parts. Use of third-party supplies or parts may affect the performance, reliability, or life of the printer and its imaging components. Use of third-party supplies or parts can affect warranty coverage. Damage caused by the use of third-party supplies or parts is not covered by the warranty. All life indicators are designed to function with Lexmark supplies and parts, and may deliver unpredictable results if third-party supplies or parts are used. Imaging component usage beyond the intended life may damage your Lexmark printer or its associated components.

Ordering toner cartridges

Notes:

- The estimated cartridge yield is based on the ISO/IEC 19752 standard.
- Extremely low print coverage for extended periods of time may negatively affect actual yield.

Item	Return Program cartridge
United States and Canada	
Toner Cartridge	601
High Yield Toner Cartridge	601H
Extra High Yield Toner Cartridge	601X
European Union, European Economic Area, and Switzerland	
Toner Cartridge	602
High Yield Toner Cartridge	602H
Extra High Yield Toner Cartridge	602X
Asia Pacific region (includes Australia and New Zealand)	
Toner Cartridge	603
High Yield Toner Cartridge	603H
Extra High Yield Toner Cartridge	603X
Latin America (includes Puerto Rico and Mexico)	
Toner Cartridge	604
High Yield Toner Cartridge	604H
Extra High Yield Toner Cartridge	604X
Africa, Middle East, Central Eastern Europe, and Commonwealth of Independent States	
Toner Cartridge	605
High Yield Toner Cartridge	605H
Extra High Yield Toner Cartridge	605X
For more information on countries located in each region, visit www.lexmark.com/regions .	
Item	Regular cartridge
Worldwide	
Extra High Yield Toner Cartridge	600XA

Ordering an imaging unit

Extremely low print coverage for extended periods of time may cause imaging unit parts to fail prior to exhaustion of toner from toner cartridge.

For more information on replacing the imaging unit, see the instruction sheet that came with the supply.

Part name	Lexmark Return Program	Regular
Imaging unit	500Z	500ZA

Ordering staple cartridges

Part name	Part number
Staple cartridges	35S8500

Ordering a maintenance kit

Notes:

- Using certain types of paper may require more frequent replacement of the maintenance kit.
- The separator roller, fuser, pick rollers, transfer roller, and redrive assembly are all included in the maintenance kit and can be individually ordered and replaced if necessary.
- Contact your service representative to replace the maintenance kit.

Maintenance kit	Part number
100-V maintenance kit*	40X9147
110-V maintenance kit	40X9137
220-V maintenance kit	40X9138
* This is available only in Japan.	

Ordering an ADF separator roller

Order an ADF separator roller when the ADF fails to pick paper or picks more than one sheet of paper at a time.

For information on replacing the ADF separator roller, see the instruction sheet that came with the part.

Part name	Part number
Separator roller	40X9108

Storing supplies

Choose a cool, clean storage area for the printer supplies. Store supplies right side up in their original packing until you are ready to use them.

Do not expose supplies to:

- Direct sunlight
- Temperatures above 35°C (95°F)
- High humidity above 80%
- Salty air
- Corrosive gases
- Heavy dust

Replacing supplies

Replacing the toner cartridge

- 1 Press the button on the right side of the printer, and then open the front door.

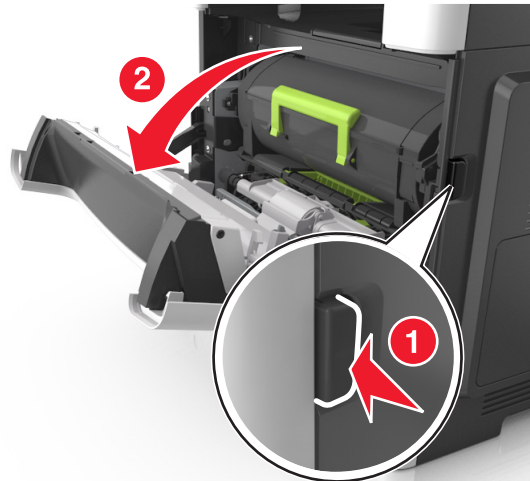

- 2 Pull the toner cartridge out using the handle.

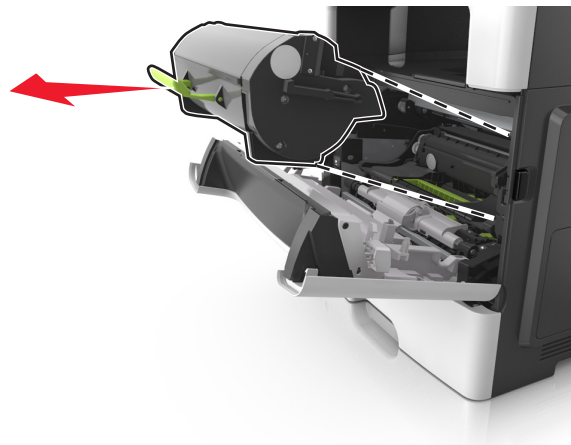

- 3 Unpack the toner cartridge, and then remove all packing materials.
- 4 Shake the new cartridge to redistribute the toner.

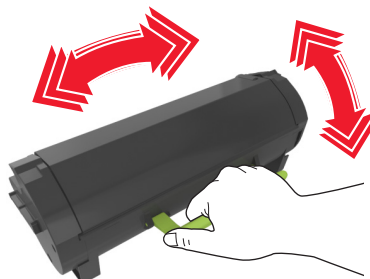

- 5 Insert the toner cartridge into the printer by aligning the side rails of the cartridge with the arrows on the side rails inside the printer.

Warning—Potential Damage: Do not expose the imaging unit to direct light for more than 10 minutes. Extended exposure to light may cause print quality problems.

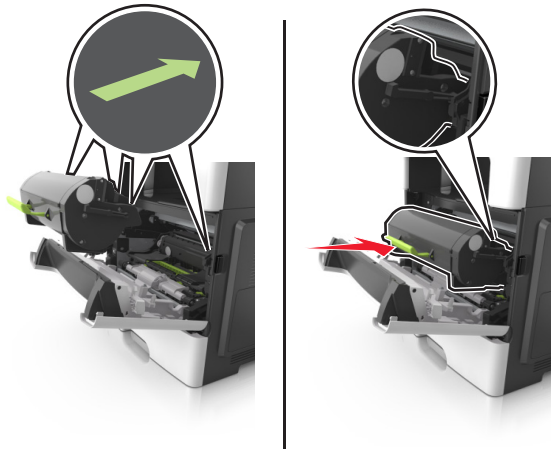

- 6 Close the front door.

Replacing the imaging unit

- 1 Press the button on the right side of the printer, and then open the front door.

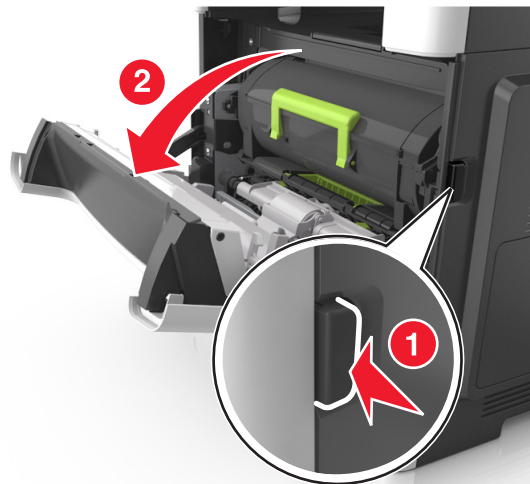

-
- 2 Pull the toner cartridge out using the handle.

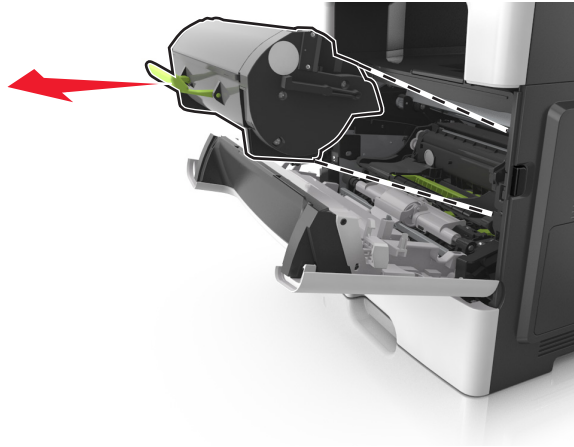

-
-
- 3 Lift the green handle, and then pull the imaging unit out of the printer.

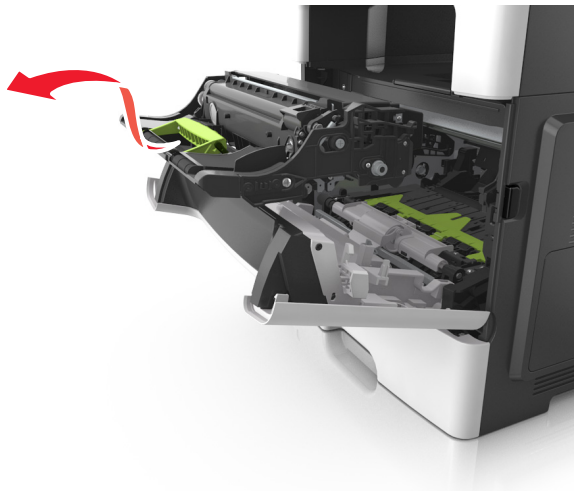

-
-
-
- 4 Unpack the new imaging unit, and then shake it.

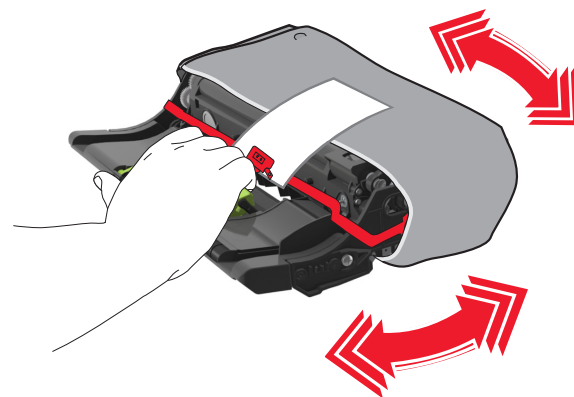

-
-
-
-
- 5 Remove all packing materials from the imaging unit.

Warning—Potential Damage: Do not expose the imaging unit to direct light for more than 10 minutes. Extended exposure to light may cause print quality problems.

Warning—Potential Damage: Do not touch the photoconductor drum. Doing so may affect the print quality of future print jobs.

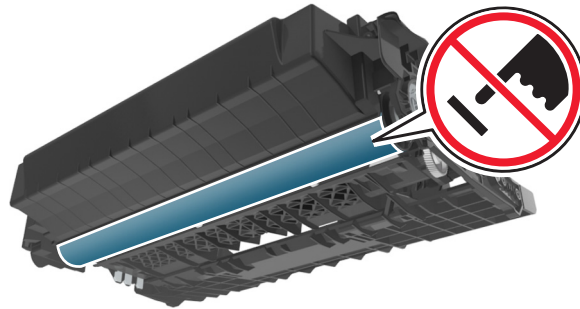

- 6** Insert the imaging unit into the printer by aligning the arrows on the side rails of the imaging unit with the arrows on the side rails inside the printer.

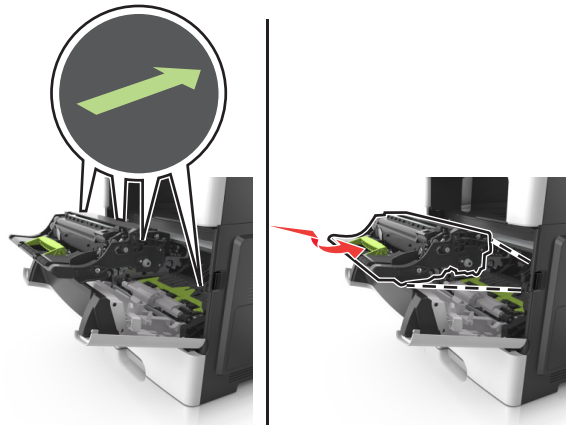

- 7** Insert the toner cartridge into the printer by aligning the side rails of the cartridge with the arrows on the side rails inside the printer.

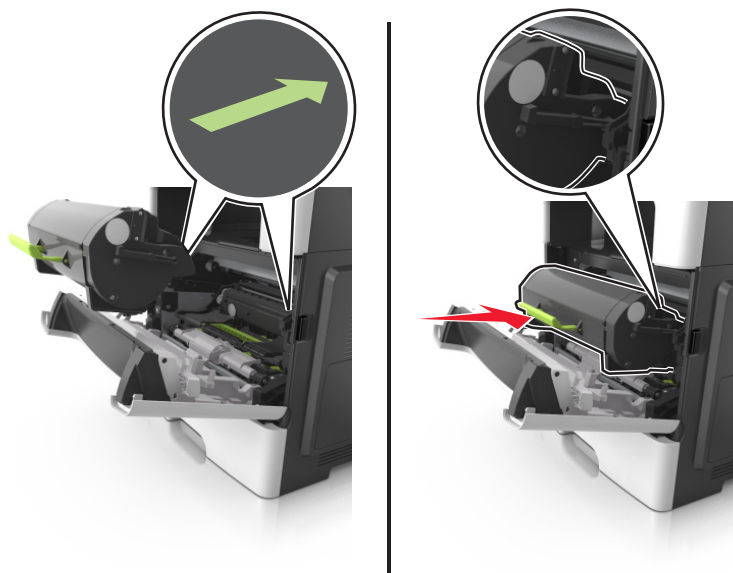

- 8** Close the front door.

Replacing the staple cartridge

- 1 Open the stapler door.

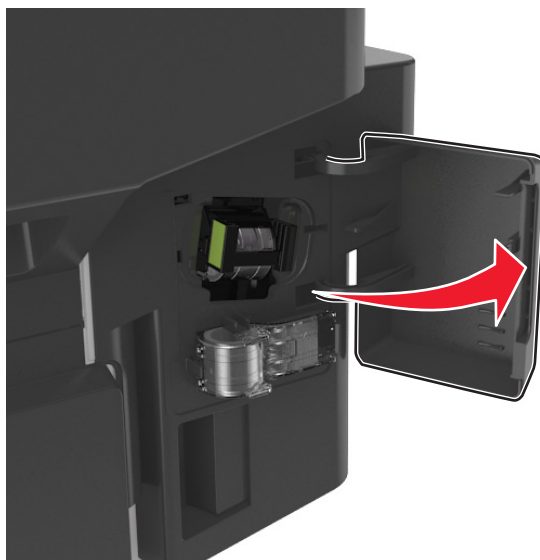

- 2 Pull out the staple cartridge from the finisher.

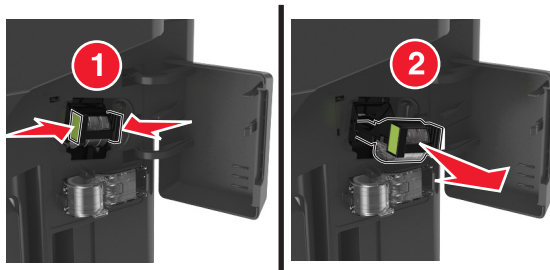

- 3 Hold both sides of the empty staple case with your fingers, pull, and then lift the empty staple case from the cartridge.

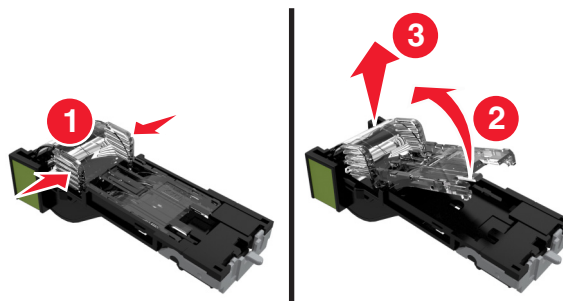

4 Remove the spare staple case from its holder.

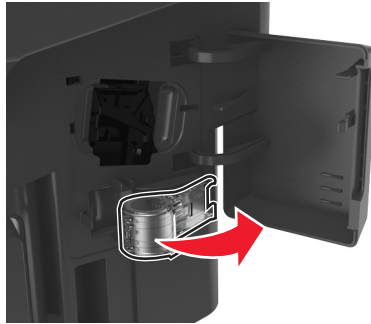

5 Insert the spare staple case into the staple cartridge.

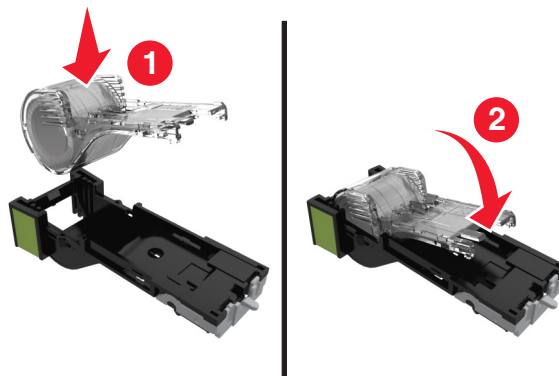

6 Push the staple cartridge into the finisher until it *clicks* into place.

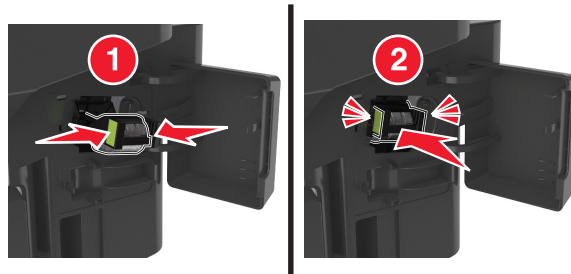

7 Replace the spare staple case for future use.

8 Close the stapler door.

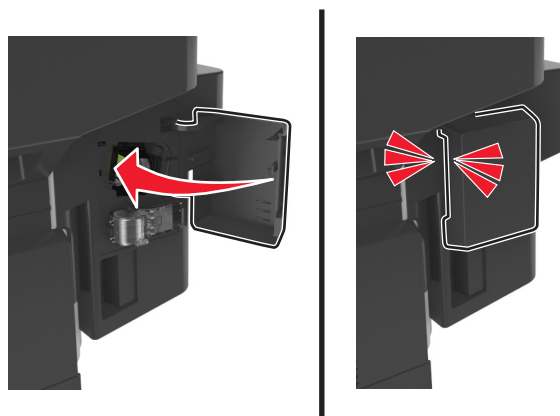

Moving the printer

Before moving the printer

⚠ CAUTION—POTENTIAL INJURY: The printer weight is greater than 18 kg (40 lb) and requires two or more trained personnel to lift it safely.

⚠ CAUTION—POTENTIAL INJURY: Before moving the printer, follow these guidelines to avoid personal injury or printer damage:

- Turn the printer off using the power switch, and then unplug the power cord from the electrical outlet.
- Disconnect all cords and cables from the printer before moving it.
- If an optional tray is installed, then remove it from the printer. To remove the optional tray, slide the latch on the right side of the tray toward the front of the tray until it *clicks* into place.



- Use the handholds located on both sides of the printer to lift it.
- Make sure your fingers are not under the printer when you set it down.
- Before setting up the printer, make sure there is adequate clearance around it.

Use only the power cord provided with this product or the manufacturer's authorized replacement.

Warning—Potential Damage: Damage to the printer caused by improper moving is not covered by the printer warranty.

Moving the printer to another location

The printer and its hardware options can be safely moved to another location by following these precautions:

- Any cart used to move the printer must have a surface able to support the full footprint of the printer.
- Any cart used to move the hardware options must have a surface able to support the dimensions of the hardware options.
- Keep the printer in an upright position.
- Avoid severe jarring movements.

Shipping the printer

When shipping the printer, use the original packaging or call the place of purchase for a relocation kit.

Managing the printer

Finding advanced networking and administrator information

This chapter covers basic administrative support tasks using the Embedded Web Server. For more advanced system support tasks, see the *Networking Guide* on the *Software and Documentation CD* or the *Embedded Web Server — Security: Administrator's Guide* on the Lexmark support Web site at <http://support.lexmark.com>.

Checking the virtual display

- 1 Open a Web browser, and then type the printer IP address in the address field.

Notes:

- View the printer IP address in the TCP/IP section in the Network/Ports menu. The IP address appears as four sets of numbers separated by periods, such as 123.123.123.123.
- If you are using a proxy server, then temporarily disable it to load the Web page correctly.

- 2 Check the virtual display that appears at the top left corner of the screen.

The virtual display works as an actual display would work on a printer control panel.

Setting up e-mail alerts

Configure the printer to send you e-mail alerts when the supplies are getting low or when the paper needs to be changed or added, or when there is a paper jam.

- 1 Open a Web browser, and then type the printer IP address in the address field.

Notes:

- View the printer IP address on the printer home screen. The IP address appears as four sets of numbers separated by periods, such as 123.123.123.123.
- If you are using a proxy server, then temporarily disable it to load the Web page correctly.

- 2 Click **Settings**.

- 3 From the Other Settings menu, click **E-mail Alert Setup**.

- 4 Select the items you want to be notified on, and then type the e-mail addresses.

- 5 Click **Submit**.

Note: For information on setting up the e-mail server, contact your system support person.

Viewing reports

You can view some reports from the Embedded Web Server. These reports are useful for assessing the status of the printer, network, and supplies.

- 1 Open a Web browser, and then type the printer IP address in the address field.

Notes:

- View the printer IP address on the printer home screen. The IP address appears as four sets of numbers separated by periods, such as 123.123.123.123.
- If you are using a proxy server, then temporarily disable it to load the Web page correctly.

2 Click **Reports**, and then click the type of report you want to view.

Configuring supply notifications from the Embedded Web Server

You can determine how you would like to be notified when supplies run nearly low, low, very low, or reach their end-of-life by setting the selectable alerts.

Notes:

- Selectable alerts can be set on the toner cartridge, imaging unit, and maintenance kit.
- All selectable alerts can be set for nearly low, low, and very low supply conditions. Not all selectable alerts can be set for the end-of-life supply condition. E-mail selectable alert is available for all supply conditions.
- The percentage of estimated remaining supply that prompts the alert can be set on some supplies for some supply conditions.

1 Open a Web browser, and then type the printer IP address in the address field.

Notes:

- View the printer IP address on the printer home screen. The IP address appears as four sets of numbers separated by periods, such as 123.123.123.123.
- If you are using a proxy server, then temporarily disable it to load the Web page correctly.

2 Click **Settings > Print Settings > Supply Notifications**.

3 From the drop-down menu for each supply, select one of the following notification options:

Notification	Description
Off	The normal printer behavior for all supplies occurs.
E-mail Only	The printer generates an e-mail when the supply condition is reached. The status of the supply appears on the menus page and status page.
Warning	The printer displays the warning message and generates an e-mail about the status of the supply. The printer does not stop when the supply condition is reached.
Continuable Stop ¹	The printer stops processing jobs when the supply condition is reached, and the user needs to press a button to continue printing.
Non Continuable Stop ^{1,2}	The printer stops processing jobs when the supply condition is reached. The supply must be replaced to continue printing.
¹ The printer generates an e-mail about the status of the supply when supply notification is enabled.	
² The printer stops when some supplies become empty to prevent damage.	

4 Click **Submit**.

Restoring factory default settings

If you want to keep a list of the current menu settings for reference, then print a menu settings page before restoring the factory default settings. For more information, see “Printing a menu settings page” on page 58.

If you want a more comprehensive method of restoring the printer factory default settings, then perform the Wipe All Settings option. For more information, see “Erasing non-volatile memory” on page 217.

Warning—Potential Damage: Restoring factory defaults returns most printer settings to the original factory default settings. Exceptions include the display language, custom sizes and messages, and network/port menu settings. All downloads stored in the RAM are deleted. Downloads stored in the flash memory or in a printer hard disk are not affected.

From the home screen, navigate to:



> **Settings** > **General Settings** > **Factory Defaults** > **Restore Now** > 

Clearing jams

Jam error messages appear on the printer display and include the area of the printer where the jam occurred. When there is more than one jam, the number of jammed pages is displayed.

Avoiding jams

Load paper properly

- Make sure paper lies flat in the tray.

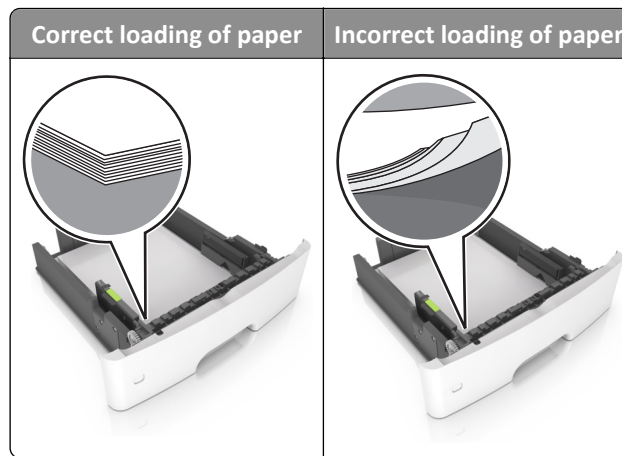

- Do not remove a tray while the printer is printing.
- Do not load a tray while the printer is printing. Load it before printing, or wait for a prompt to load it.
- Do not load too much paper. Make sure the stack height is below the maximum paper fill indicator.
- Do not slide the paper into the tray. Load paper as shown in the illustration.

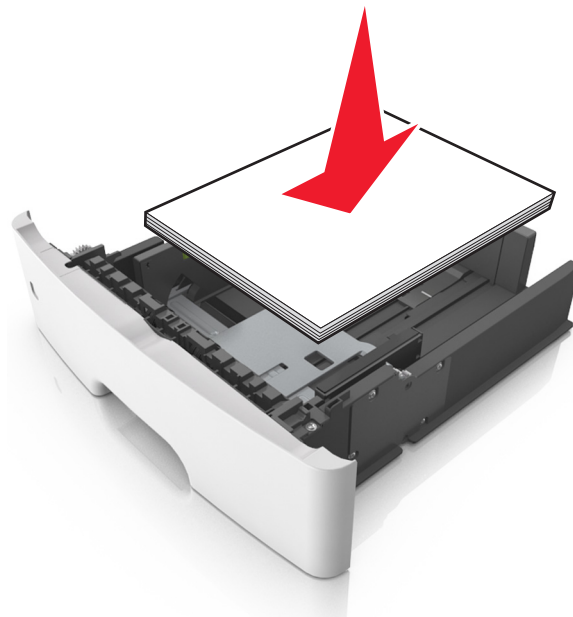

- Make sure the guides in the tray or the multipurpose feeder are properly positioned and are not pressing tightly against the paper or envelopes.
- Push the tray firmly into the printer after loading paper.

Use recommended paper

- Use only recommended paper or specialty media.
- Do not load wrinkled, creased, damp, bent, or curled paper.
- Flex, fan, and straighten paper before loading it.

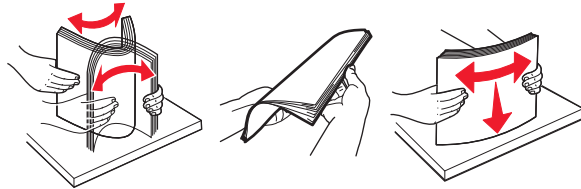

- Do not use paper that has been cut or trimmed by hand.
- Do not mix paper sizes, weights, or types in the same tray.
- Make sure the paper size and type are set correctly on the computer or printer control panel.
- Store paper according to manufacturer recommendations.

Understanding jam messages and locations

When a jam occurs, a message indicating the jam location and information to clear the jam appears on the printer display. Open the doors, covers, and trays indicated on the display to remove the jam.

Notes:

- When Jam Assist is set to On, the printer automatically flushes blank pages or pages with partial prints to the standard bin after a jammed page has been cleared. Check your printed output stack for discarded pages.
- When Jam Recovery is set to On or Auto, the printer reprints jammed pages. However, the Auto setting does not guarantee that the page will print.

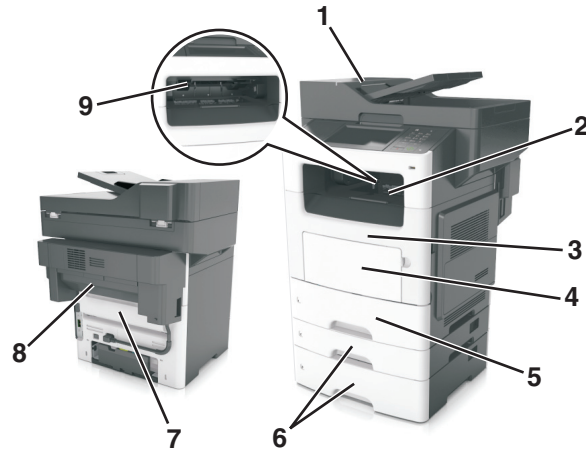

	Jam access area	Printer control panel message	What to do
1	Automatic document feeder (ADF)	[x]-page jam, open ADF to clear jam. [28y.xx]	Remove all paper from the ADF tray, and then remove the jammed paper.
2	Standard bin	[x]-page jam, clear standard bin. [20y.xx]	Remove the jammed paper.
3	Front door	[x]-page jam, open front door. [20y.xx]	Open the front door, then remove the toner cartridge and imaging unit, and then the jammed paper.
4	Multipurpose feeder	[x]-page jam, clear manual feeder. [25y.xx]	Remove all paper from the multipurpose feeder, and then remove the jammed paper.
5	Tray 1	[x]-page jam, remove tray 1 to clear duplex. [23y.xx]	Pull out tray 1 completely, then push the front duplex flap down, and then remove the jammed paper. Note: You may need to open the rear door to clear some 23y.xx paper jams.
6	Tray [x]	[x]-page jam, open tray [x]. [24y.xx]	Pull the indicated tray out, and then remove the jammed paper.
7	Rear door	[x]-page jam, open rear door. [20y.xx]	Open the rear door, and then remove the jammed paper.
8	Finisher rear door	[x]-page jam, remove all pages from the finisher's output bin. Leave paper in bin [45y.xx]	<ul style="list-style-type: none"> • Open the finisher rear door, and then remove the jammed paper. • Open the narrow door, and then remove the jammed paper.
9	Finisher output bin	[x]-page jam, remove all pages from the output bin. Leave paper in bin [45y.xx]	<ul style="list-style-type: none"> • Move the left paper guide to the left and the right paper guide to the right, and then remove the jammed paper from the finisher bin. • Open the finisher rear door and the narrow door, and then remove any jammed pages.

[x]-page jam, open automatic feeder top cover. [28y.xx]

- 1 Remove all original documents from the ADF tray.

Note: The message is cleared when the pages are removed from the ADF tray.

- 2 Open the ADF cover.

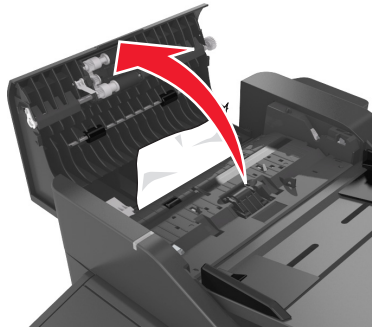

- 3 Firmly grasp the jammed paper on each side, and then gently pull it out.

Note: Make sure all paper fragments are removed.

- 4 Close the ADF cover.

- 5 Straighten the edges of the original documents, then load the documents into the ADF, and then adjust the paper guide.

- 6 From the printer control panel, touch **Done** to clear the message and continue printing.

[x]-page jam, clear standard bin. [20y.xx]

- 1 Firmly grasp the jammed paper on each side, and then gently pull it out.

Note: Make sure all paper fragments are removed.

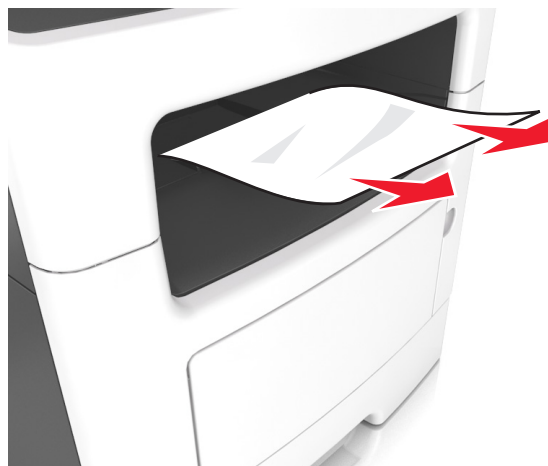

- 2 From the printer control panel, touch **Done** to clear the message and continue printing.

[x]-page jam, open rear door. [20y.xx]

- 1 Open the front door to loosen the jammed paper in the rear door.

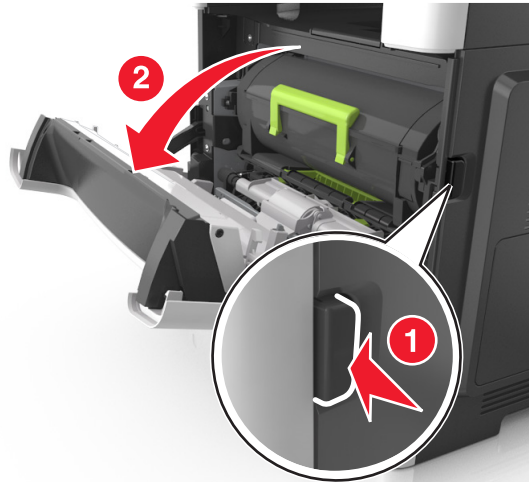

- 2 Gently pull down the rear door.



CAUTION—HOT SURFACE: The inside of the printer might be hot. To reduce the risk of injury from a hot component, allow the surface to cool before touching it.

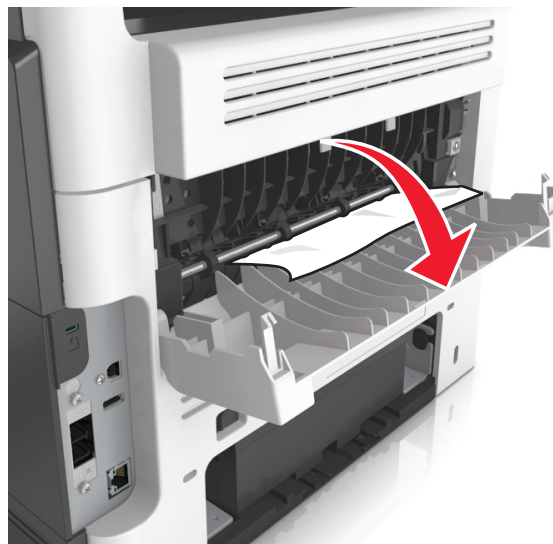

- 3 Firmly grasp the jammed paper on each side, and then gently pull it out.

Note: Make sure all paper fragments are removed.

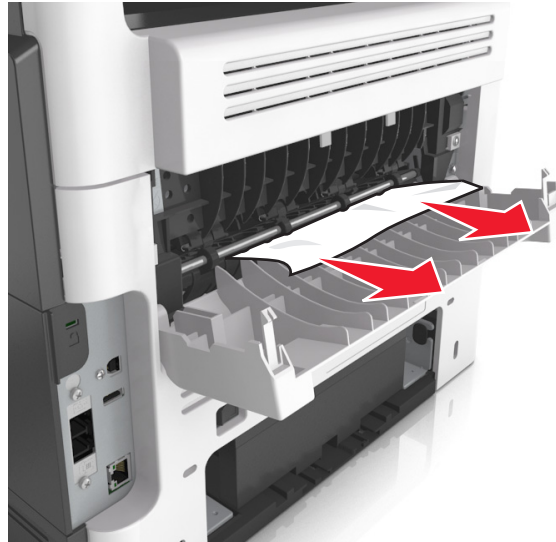

- 4 Close the front and rear door.
- 5 From the printer control panel, select **Done** to clear the message and continue printing.

[x]-page jam, open front door. [20y.xx]

 **CAUTION—HOT SURFACE:** The inside of the printer might be hot. To reduce the risk of injury from a hot component, allow the surface to cool before touching it.

- 1 Press the button on the right side of the printer, and then open the front door.

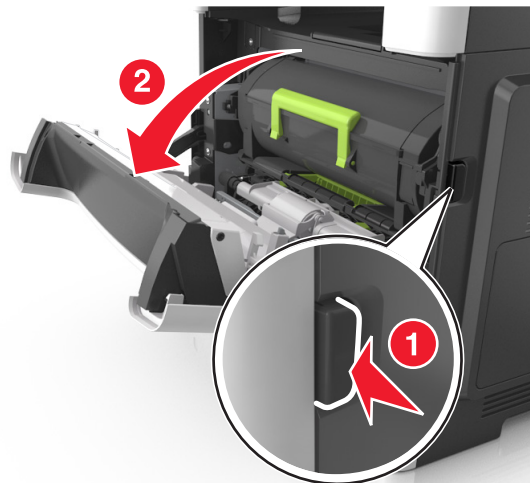

- 2 Pull out the toner cartridge using the handle.

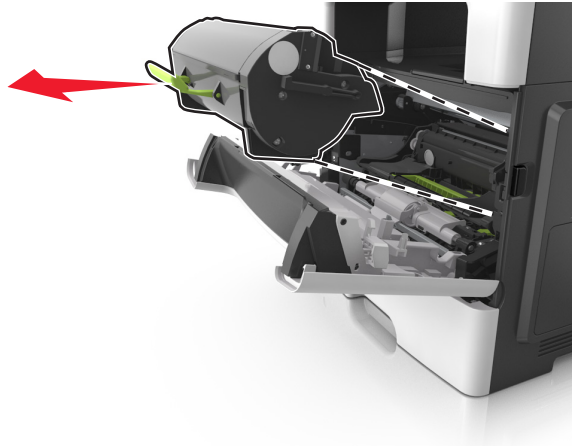

- 3 Lift the green handle, and then pull out the imaging unit from the printer.

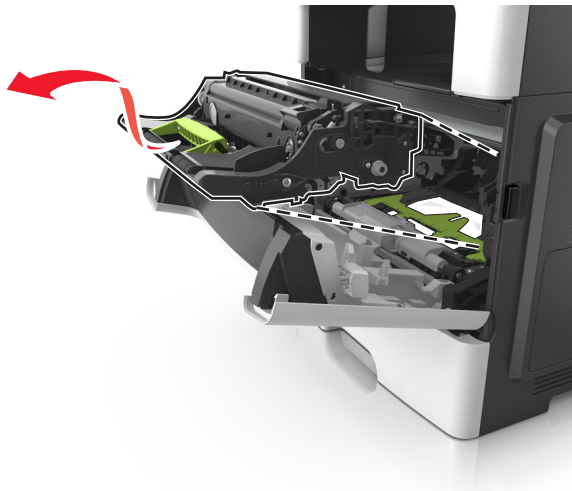

Warning—Potential Damage: Do not touch the shiny blue photoconductor drum under the imaging unit. Doing so may affect the quality of future print jobs.

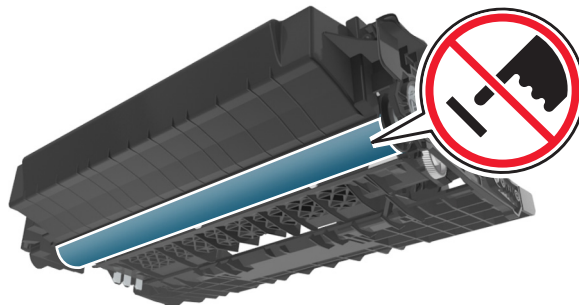

- 4 Place the imaging unit aside on a flat, smooth surface.

Warning—Potential Damage: Do not expose the imaging unit to direct light for more than 10 minutes. Extended exposure to light may cause print quality problems.

- 5 Lift the green flap in front of the printer.

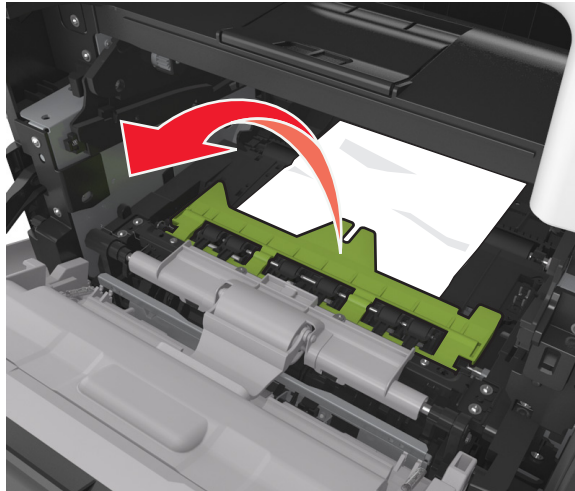

- 6 Firmly grasp the jammed paper on each side, and then gently pull it out.

Note: Make sure all paper fragments are removed.

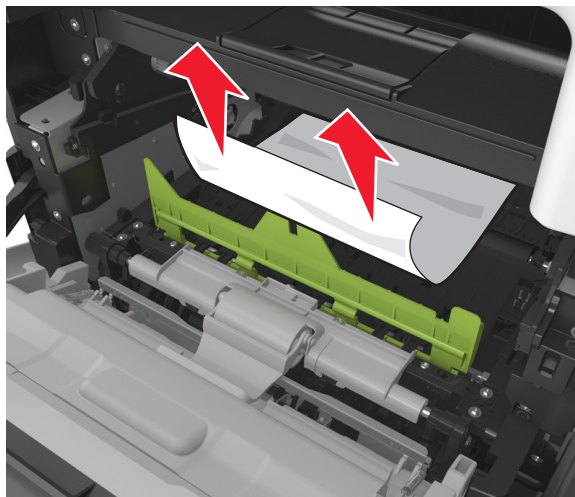

- 7 Insert the imaging unit by aligning the arrows on the side rails of the unit with the arrows on the side rails inside the printer, and then insert the imaging unit into the printer.

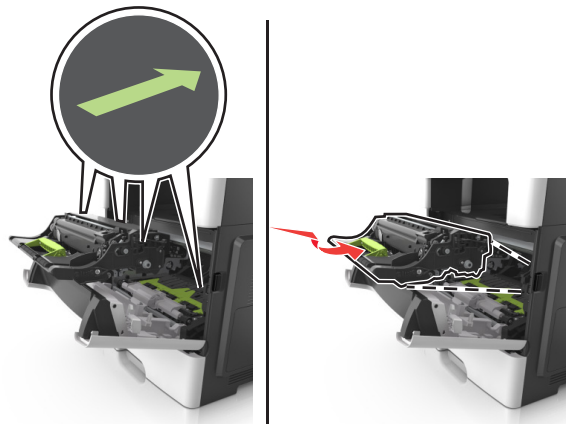

- 8 Insert the toner cartridge by aligning the side rails of the cartridge with the arrows on the side rails inside the printer, and then insert the cartridge into the printer.

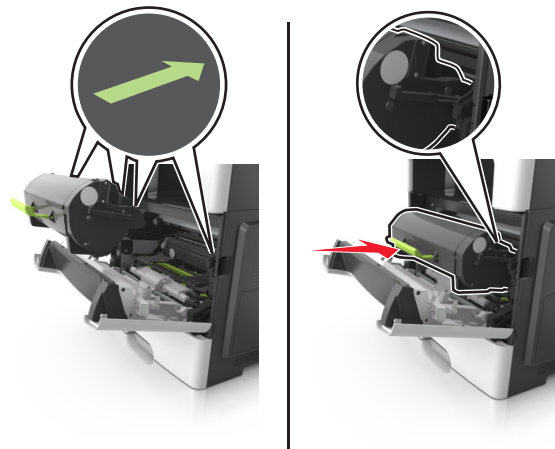

- 9 Close the front door.
- 10 From the printer control panel, select **Continue** to clear the message and continue printing.

[x]-page jam, remove tray 1 to clear duplex. [23y.xx]

- 1 Pull out the tray completely.

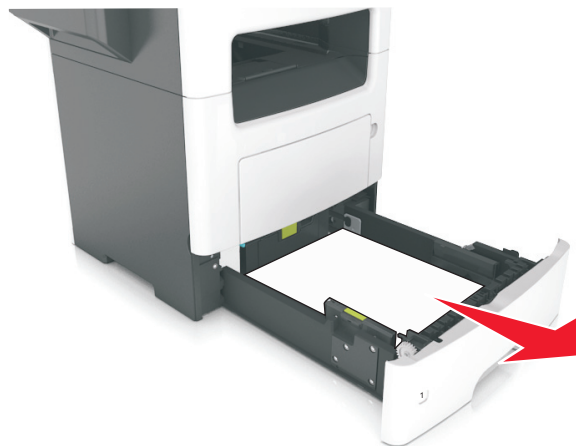

- 2 Locate the lever, and then pull it down to release the jam.

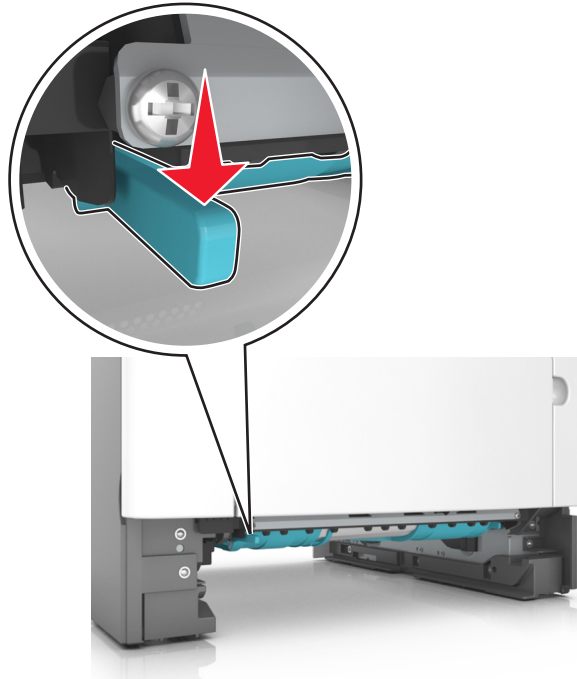

- 3 Firmly grasp the jammed paper on each side, and then gently pull it out.

Note: Make sure all paper fragments are removed.

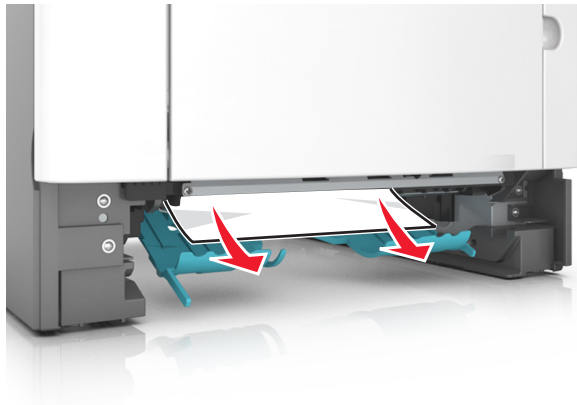

- 4 Insert the tray.

- 5 From the printer control panel, touch **Done** to clear the message and continue printing.

[x]-page jam, clear manual feeder. [25y.xx]

- 1 From the multipurpose feeder, firmly grasp the jammed paper on each side, and then gently pull it out.

Note: Make sure all paper fragments are removed.



- 2 Flex the sheets back and forth to loosen them, and then fan them. Do not fold or crease the paper. Straighten the edges on a level surface.

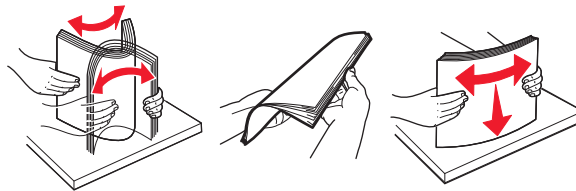

- 3 Reload paper into the multipurpose feeder.



Note: Make sure the paper guide lightly rests against the edge of the paper.

- 4 From the printer control panel, touch **Done** to clear the message and continue printing.

[x]-page jam, open tray [x]. [24y.xx]

- 1 Pull out the tray completely.

Note: The message on the printer display indicates the tray where the jammed paper is located.

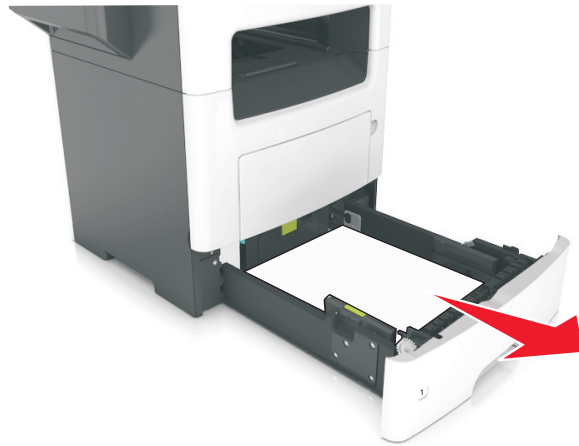

2 Firmly grasp the jammed paper on each side, and then gently pull it out.

Note: Make sure all paper fragments are removed.

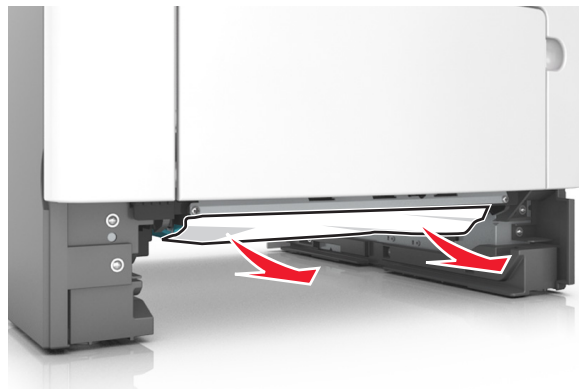

3 Insert the tray.

4 From the printer control panel, touch **Done** to clear the message and continue printing.

[x]-page jam, remove all pages from the output bin. Leave paper in bin. [45y.xx]

Paper jam in the finisher bin

- 1 Empty the standard bin.



- 2 Move the paper guides to the sides.



- 3 Remove all jammed pages from inside the access areas.

Note: Make sure all paper fragments are removed.



4 If necessary, touch **Done** from the printer control panel to clear the message and continue printing.

Paper jam in the finisher rear door

1 Open the finisher rear door.



2 Firmly grasp the jammed paper on each side, and then gently pull it out.

Note: Make sure all paper fragments are removed.



3 Open the finisher narrow door, and then remove any paper fragments inside the narrow door.

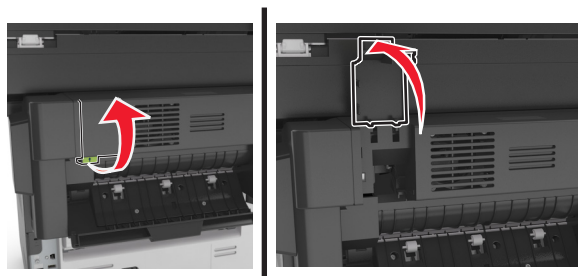

4 Close the narrow door.

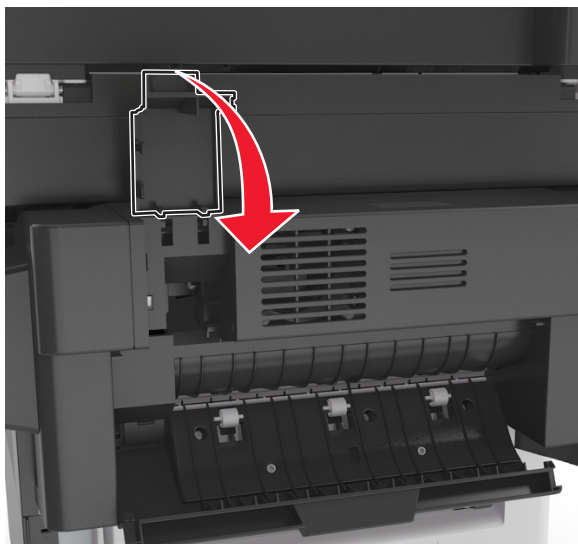

- 5 Close the finisher rear door.



- 6 If necessary, touch **Done** from the printer control panel to clear the message and continue printing.

Staple jam in the finisher

- 1 Open the staple access door.

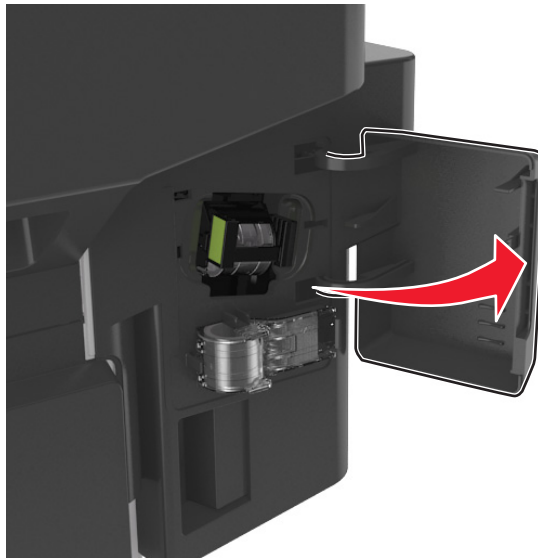

- 2 Pull out the staple cartridge from the finisher.

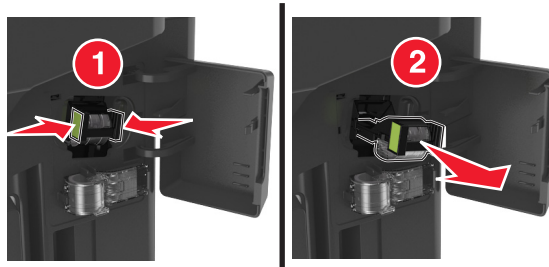

3 Lift the staple guard, and then remove any jammed or loose staples.

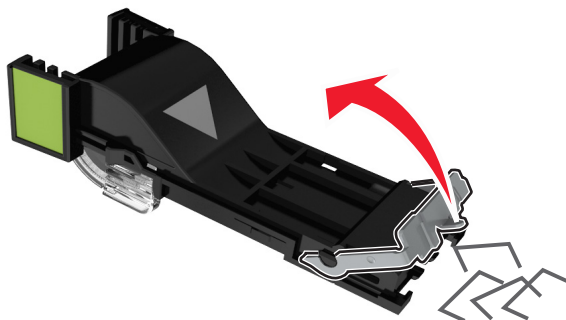

4 Press down the staple guard until it *clicks* into place.

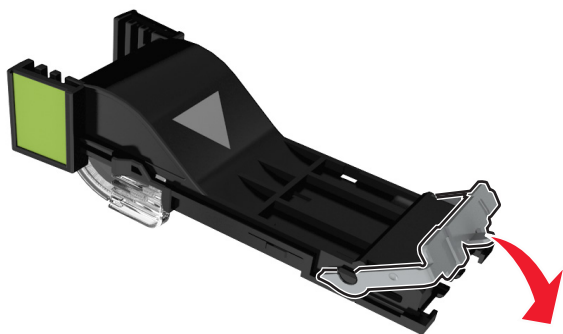

5 Insert staple cartridge back into the finisher until it *clicks* into place.

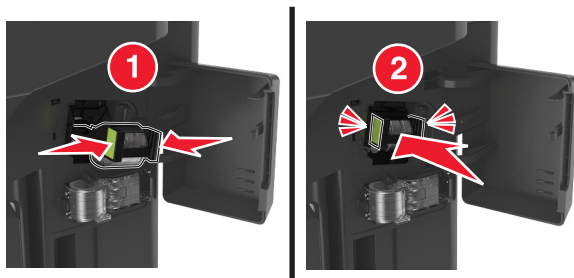

6 Close the staple access door.

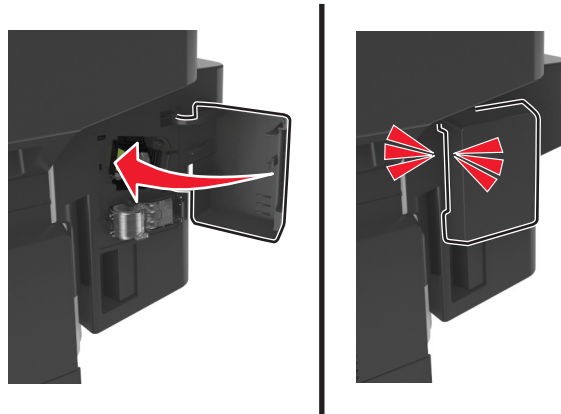

7 If necessary, touch **Done** from the printer control panel to clear the message and continue printing.

Troubleshooting

- “Understanding the printer messages” on page 253
- “Solving printer problems” on page 268
- “Solving print problems” on page 274
- “Solving copy problems” on page 299
- “Solving fax problems” on page 303
- “Solving scanner problems” on page 309
- “Solving home screen applications problems” on page 314
- “Embedded Web Server does not open” on page 314
- “Contacting customer support” on page 315

Understanding the printer messages

Cartridge, imaging unit mismatch [41.xy]

Install a toner cartridge that matches the region number of the printer. x indicates the value of the printer region. y indicates the value of the cartridge region. x and y can have the following values:

List of printer and toner cartridge regions

Region number	Region
0	Global
1	United States, Canada
2	European Economic Area (EEA), Switzerland
3	Asia Pacific, Australia, New Zealand
4	Latin America
5	Africa, Middle East, rest of Europe
9	Invalid region

Notes:

- The x and y values are the .xy of the error code shown on the printer control panel.
- The x and y values must match for printing to continue.

Cartridge low [88.xy]

You may need to order a replacement toner cartridge. If necessary, touch **Continue** on the printer control panel to clear the message and continue printing.

Cartridge nearly low [88.xy]

If necessary, touch **Continue** on the printer control panel to clear the message and continue printing.

Cartridge very low, [x] estimated pages remain [88.xy]

You may need to replace the toner cartridge very soon. For more information, see the “Replacing supplies” section of the *User’s Guide*.

If necessary, touch **Continue** on the printer control panel to clear the message and continue printing.

Change [paper source] to [custom type name] load [orientation]

Try one or more of the following:

- Load the correct size and type of paper in the tray or feeder, specify the paper size and type in the Paper menu on the printer control panel, and then touch **Finished changing paper**.
- Touch **Reset active bin** to reset the active bin for a linked set of bins.
- Cancel the print job.

Change [paper source] to [custom string] load [orientation]

Try one or more of the following:

- Load the correct size and type of paper in the tray or feeder, specify the paper size and type in the Paper menu on the printer control panel, and then touch **Finished changing paper**.
- Touch **Reset active bin** to reset the active bin for a linked set of bins.
- Cancel the print job.

Change [paper source] to [paper size] load [orientation]

Try one or more of the following:

- Load the correct size and type of paper in the tray or feeder, specify the paper size and type in the Paper menu on the printer control panel, and then touch **Finished changing paper**.
- Touch **Reset active bin** to reset the active bin for a linked set of bins.
- Cancel the print job.

Change [paper source] to [paper type] [paper size] load [orientation]

Try one or more of the following:

- Load the correct size and type of paper in the tray or feeder, specify the paper size and type in the Paper menu on the printer control panel, and then touch **Finished changing paper**.
- Touch **Reset active bin** to reset the active bin for a linked set of bins.
- Cancel the print job.

Check tray [x] connection

Try one or more of the following:

- Turn off the printer, and then turn it back on.

If the error occurs a second time, then:

- 1 Turn off the printer.
- 2 Unplug the power cord from the electrical outlet.
- 3 Remove the indicated tray.
- 4 Reattach the tray.
- 5 Connect the power cord to a properly grounded electrical outlet.
- 6 Turn the printer back on.

If the error occurs again, then:

- 1 Turn off the printer.
 - 2 Unplug the power cord from the electrical outlet.
 - 3 Remove the tray.
 - 4 Contact customer support.
- From the printer control panel, touch **Continue** to clear the message and resume the job.

Close rear door

Close the rear door of the printer.

Close finisher rear door

Close the rear door of the finisher.

Close front door

Close the front door of the printer.

Close flatbed cover and load originals if restarting job [2yy.xx]

Try one or more of the following:

- Touch **Scan from automatic feeder** to continue scanning from the ADF immediately after the last successful scan job.
- Touch **Scan from flatbed** to continue scanning from the scanner glass immediately after the last successful scan job.
- Touch **Finish job without further scanning** to end the last successful scan job.

Note: This does not cancel the scan job. All successfully scanned pages will be processed further for copying, faxing, or e-mailing.

- Touch **Cancel job** to clear the message and cancel the scan job.

Complex page, some data may not have printed [39]

Try one or more of the following:

- From the printer control panel, touch **Continue** to ignore the message and continue printing.
- Cancel current print job.
- Install additional printer memory.

Configuration change, some held jobs were not restored [57]

Held jobs are invalidated because of the following possible changes in the printer:

- The printer firmware has been updated.
- The tray for the print job has been removed.
- The print job is sent from a flash drive that is no longer attached to the USB port.
- The printer hard disk contains print jobs that were stored when the hard disk was installed in a different printer model.

From the printer control panel, touch **Continue** to clear the message.

Defective flash detected [51]

Try one or more of the following:

- Replace the defective flash memory card.
- From the printer control panel, touch **Continue** to ignore the message and continue printing.
- Cancel the current print job.

Disk full [62]

Try one or more of the following:

- From the printer control panel, touch **Continue** to clear the message and continue processing.
- Delete fonts, macros, and other data stored in the printer hard disk.
- Install a printer hard disk with larger capacity.

Disk must be formatted for use in this device

From the printer control panel, touch **Format disk** to format the printer hard disk and clear the message.

Note: Formatting deletes all the files stored in the printer hard disk.

Disk near full. Securely clearing disk space.

Try one or more of the following:

- Touch **Continue** to clear the message and continue printing.
- Delete fonts, macros, and other data stored on the printer hard disk.
- Install a hard disk with higher capacity.

Error reading USB drive. Remove USB.

An unsupported USB device is inserted. Remove the USB device, and then insert a supported one.

Error reading USB hub. Remove hub.

An unsupported USB hub has been inserted. Remove the USB hub, and then install a supported one.

Fax memory full

From the printer control panel, touch **Continue** to clear the message.

Fax partition inoperative. Contact system administrator.

Try one or more of the following:

- From the printer control panel, touch **Continue** to clear the message.
- Turn off the printer, and then turn it back on. If the message appears again, then contact your system support person.

Fax server 'To Format' not set up. Contact system administrator.

Try one or more of the following:

- From the printer control panel, touch **Continue** to clear the message.
- Complete the Fax Server setup. If the message appears again, then contact your system support person.

Fax Station Name not set up. Contact system administrator.

Try either of the following:

- From the printer control panel, touch **Continue** to clear the message.
- Complete the Analog Fax setup. If the message appears again after completing the setup, then contact your system support person.

Fax Station Number not set up. Contact system administrator.

Try one or more of the following:

- From the printer control panel, touch **Continue** to clear the message.
- Complete the Analog Fax setup. If the message appears again after completing the setup, then contact your system support person.

Imaging unit low [84.xy]

You may need to order a replacement imaging unit. If necessary, select **Continue** on the printer control panel to clear the message and continue printing.

Imaging unit nearly low [84.xy]

If necessary, touch **Continue** on the printer control panel to clear the message and continue printing.

Imaging unit very low, [x] estimated pages remain [84.xy]

You may need to replace the imaging unit very soon. For more information, see the “Replacing supplies” section of the *User’s Guide*.

If necessary, touch **Continue** on the printer control panel to clear the message and continue printing.

Incompatible tray [x] [59]

Try one or more of the following:

- Remove the indicated tray.
- From the printer control panel, touch **Continue** to clear the message and continue printing without using the indicated tray.

Incorrect paper size, open [paper source] [34]

Try one or more of the following:

- Load the correct size and type of paper in the tray, and then specify the paper size and type in the Paper menu on the printer control panel.
- Make sure the correct paper size and type are specified in Print Properties or the Print dialog settings.
- Check if the paper size is correctly set. For example, if MP Feeder Size is set to Universal, then make sure the paper is large enough for the data being printed.
- Check the length and width guides and make sure the paper is loaded properly in the tray.
- From the printer control panel, touch **Continue** to clear the message and print using a different tray.
- Cancel the print job.

Insufficient memory to collate job [37]

Try one or more of the following:

- From the printer control panel, touch **Continue** to print the part of the job already stored and begin collating the rest of the print job.
- Cancel the current print job.

Insufficient memory for Flash Memory Defragment operation [37]

Try one or more of the following:

- From the printer control panel, touch **Continue** to stop the defragmentation and continue printing.
- Delete fonts, macros, and other data in the printer memory.
- Install additional printer memory.

Insufficient memory, some Held Jobs were deleted [37]

From the printer control panel, touch **Continue** to clear the message.

Insufficient memory, some held jobs will not be restored [37]

Try one or more of the following:

- From the printer control panel, touch **Continue** to clear the message.
- Delete other held jobs to free up additional printer memory.

Insufficient memory to support Resource Save feature [35]

Install additional printer memory or touch **Continue** to disable Resource Save, clear the message, and continue printing.

Load [paper source] with [custom type name] [paper orientation]

Try one or more of the following:

- Load the tray or feeder with the correct size and type of paper.
- To use the tray with the correct paper size or type, touch **Finished loading paper** on the printer control panel.

Note: If the printer detects a tray that has the correct paper size and type, then it feeds from that tray. If the printer cannot detect a tray that has the correct paper size and type, then it prints from the default paper source.

- Cancel the current job.

Load [paper source] with [custom string] [paper orientation]

Try one or more of the following:

- Load the indicated tray or feeder with the correct size and type of paper.
- To use the tray with the correct paper size or type, touch **Finished loading paper** on the printer control panel.

Note: If the printer finds a tray that has the correct paper size and type, then it feeds from that tray. If the printer cannot find a tray with the correct paper type and size, then it prints from the default paper source.

- Cancel the current job.

Load [paper source] with [paper size] [paper orientation]

Try one or more of the following:

- Load the specified tray or feeder with the correct size of paper.
- To use the tray or feeder with the correct size of paper, touch **Finished loading paper** on the printer control panel.

Note: If the printer finds a tray or feeder that has the correct size of paper, then it feeds from that tray or feeder. If the printer cannot find a tray or feeder with the correct size of paper, then it prints from the default paper source.

- Cancel the current job.

Load [paper source] with [paper type] [paper size] [paper orientation]

Try one or more of the following:

- Load the specified tray or feeder with the correct size and type of paper.
- To use the tray or feeder with the correct size and type of paper, touch **Finished loading paper** on the printer control panel.
Note: If the printer finds a tray or feeder that has the correct size and type of paper, then it feeds from that tray or feeder. If the printer cannot find a tray or feeder with the correct size and type of paper, then it prints from the default paper source.
- Cancel the current job.

Load Manual Feeder with [custom type name] [paper orientation]

Try one or more of the following:

- Load the feeder with the correct size and type of paper.
- From the printer control panel, touch **Prompt each page, paper loaded** or **Do not prompt, paper loaded** to clear the message and continue printing.
- From the printer control panel, touch **Automatically select paper** to use the paper loaded in the tray.
- Cancel the print job.

Load Manual Feeder with [custom string] [paper orientation]

Try one or more of the following:

- Load the feeder with the correct size and type of paper.
- From the printer control panel, touch **Prompt each page, paper loaded** or **Do not prompt, paper loaded** to clear the message and continue printing.
- From the printer control panel, touch **Automatically select paper** to use the paper loaded in the tray.
- Cancel the print job.

Load Manual Feeder with [paper size] [paper orientation]

Try one or more of the following:

- Load the feeder with the correct size of paper.
- From the printer control panel, touch **Prompt each page, paper loaded** or **Do not prompt, paper loaded** to clear the message and continue printing.
- From the printer control panel, touch **Automatically select paper** to use the paper loaded in the tray.
- Cancel the print job.

Load Manual Feeder with [paper type] [paper size] [paper orientation]

Try one or more of the following:

- Load the feeder with the correct size and type of paper.
- From the printer control panel, touch **Prompt each page, paper loaded** or **Do not prompt, paper loaded** to clear the message and continue printing.

- From the printer control panel, touch **Automatically select paper** to use the paper loaded in the tray.
- Cancel the print job.

Maintenance kit low [80.xy]

You may need to order a maintenance kit. For more information, visit the Lexmark support Web site at <http://support.lexmark.com> or contact customer support, and then report the message.

If necessary, touch **Continue** to clear the message and continue printing.

Maintenance kit nearly low [80.xy]

For more information, visit the Lexmark support Web site at <http://support.lexmark.com> or contact customer support, and then report the message.

If necessary, touch **Continue** to clear the message and continue printing.

Maintenance kit very low, [x] estimated pages remain [80.xy]

You may need to replace the maintenance kit very soon. For more information, visit the Lexmark support Web site at <http://support.lexmark.com> or contact customer support, and then report the message.

If necessary, touch **Continue** to clear the message and continue printing.

Memory full [38]

Try one or more of the following:

- From the printer control panel, touch **Cancel job** to clear the message.
- Install additional printer memory.

Memory full, cannot print faxes

From the printer control panel, touch **Continue** to clear the message without printing. Held faxes attempt to print after the printer is restarted.

Memory full, cannot send faxes

- 1 From the printer control panel, touch **Continue** to clear the message and cancel the fax job.
- 2 Try one or more of the following:
 - Reduce the fax resolution, and then resend the fax job.
 - Reduce the number of pages in the fax, and then resend the fax job.

Network [x] software error [54]

Try one or more of the following:

- From the printer control panel, touch **Continue** to continue printing.
- Turn off the printer, wait for about 10 seconds, and then turn the printer back on.

- Update the network firmware in the printer or print server. For more information, visit the Lexmark support Web site at <http://support.lexmark.com>.

No analog phone line connected to modem, fax is disabled.

Connect the printer to an analog phone line.

Non-Lexmark [supply type], see *User's Guide* [33.xy]

Note: The supply type can be a toner cartridge or the imaging unit.

The printer has detected a non-Lexmark supply or part installed in the printer.

Your Lexmark printer is designed to function best with genuine Lexmark supplies and parts. Use of third-party supplies or parts may affect the performance, reliability, or life of the printer and its imaging components.

All life indicators are designed to function with Lexmark supplies and parts, and may deliver unpredictable results if third-party supplies or parts are used. Imaging component usage beyond the intended life may damage your Lexmark printer or associated components.

Warning—Potential Damage: Use of third-party supplies or parts can affect warranty coverage. Damage caused by the use of third-party supplies or parts may not be covered by the warranty.

To accept any and all of these risks, and to proceed with the use of non-genuine supplies or parts in your printer, press and hold  and # on the printer control panel simultaneously for 15 seconds to clear the message and continue printing.

If you do not wish to accept these risks, then remove the third-party supply or part from your printer, and then install a genuine Lexmark supply or part.

Note: For the list of supported supplies, see the “Ordering supplies” section of the *User's Guide* or visit www.lexmark.com.

Not enough free space in flash memory for resources [52]

Try one or more of the following:

- From the printer control panel, touch **Continue** to clear the message and continue printing.
- Delete fonts, macros, and other data stored in the flash memory.
- Install a flash memory card with larger capacity.

Note: Downloaded fonts and macros not previously stored in the flash memory are deleted.

Paper changes needed

Try one or more of the following:

- From the printer control panel, touch **Prompt for each page** to continue printing.
- Touch **Use current supplies** to continue printing using the paper loaded in the tray.
- Cancel the current print job.

Parallel port [x] disabled [56]

Try one or more of the following:

- From the printer control panel, touch **Continue** to clear the message.
- Enable the parallel port. From the printer control panel, navigate to:
Network/Ports > Parallel [x] > Parallel Buffer > Auto

Note: The printer discards any data received through the parallel port.

Printer had to restart. Last job may be incomplete.

From the printer control panel, touch **Continue** to clear the message and continue printing.

For more information, visit <http://support.lexmark.com> or contact customer support.

Remove defective disk [61]

Remove and replace the defective printer hard disk.

Remove paper from standard output bin

Remove the paper stack from the standard bin.

Replace defective imaging unit [31.xy]

Replace the defective imaging unit to clear the message. For more information, see the instruction sheet that came with the supply.

Note: If you do not have a replacement imaging unit, then see the “Ordering supplies” section of the *User’s Guide* or visit www.lexmark.com.

Replace cartridge, 0 estimated pages remain [88.xy]

Replace the toner cartridge to clear the message and continue printing. For more information, see the instruction sheet that came with the supply or see the “Replacing supplies” section of the *User’s Guide*.

Note: If you do not have a replacement cartridge, then see the “Ordering supplies” section of the *User’s Guide* or visit www.lexmark.com.

Replace imaging unit, 0 estimated pages remain [84.xy]

Replace the imaging unit to clear the message and continue printing. For more information, see the instruction sheet that came with the supply or see the “Replacing supplies” section of the *User’s Guide*.

Note: If you do not have a replacement imaging unit, then see the “Ordering supplies” section of the *User’s Guide* or visit www.lexmark.com.

Replace maintenance kit, 0 estimated pages remain [80.xy]

The printer is scheduled for maintenance. For more information, visit the Lexmark support Web site at <http://support.lexmark.com> or contact your service representative, and then report the message.

Replace all originals if restarting job.

Try one or more of the following:

- Touch **Cancel job** to clear the message and cancel the scan job.
- Touch **Scan from automatic feeder** to continue scanning from the ADF immediately after the last successful scan job.
- Touch **Scan from flatbed** to continue scanning from the scanner immediately after the last successful scan job.
- Touch **Finish job without further scanning** to end the last successful scan job.
- Touch **Restart job** to restart the scan job with the same settings from the previous scan job.

Reinstall missing or unresponsive cartridge [31.xy]

Try one or more of the following:

- Check if the toner cartridge is missing. If missing, install the toner cartridge.
For information on installing the cartridge, see the “Replacing supplies” section of the *User’s Guide*.
- If the toner cartridge is installed, then remove the unresponsive toner cartridge, and then reinstall it.
Note: If the message appears after reinstalling the supply, then the cartridge is defective. Replace the toner cartridge.

Reinstall missing or unresponsive imaging unit [31.xy]

Try one or more of the following:

- Check if the imaging unit is missing. If missing, install the imaging unit.
For information on installing the imaging unit, see the “Replacing supplies” section of the *User’s Guide*.
- If the imaging unit is installed, then remove the unresponsive imaging unit, and then reinstall it.
Note: If the message appears after reinstalling the supply, then the imaging unit is defective. Replace the imaging unit.

Replace unsupported cartridge [32.xy]

Remove the toner cartridge, and then install a supported one to clear the message and continue printing. For more information, see the instruction sheet that came with the supply or see the “Replacing supplies” section of the *User’s Guide*.

Note: If you do not have a replacement cartridge, then see the “Ordering supplies” section of the *User’s Guide* or visit www.lexmark.com.

Replace unsupported imaging unit [32.xy]

Remove the imaging unit, and then install a supported one to clear the message and continue printing. For more information, see the instruction sheet that came with the supply or see the “Replacing supplies” section of the *User’s Guide*.

Note: If you do not have a replacement imaging unit, then see the “Ordering supplies” section of the *User’s Guide* or visit www.lexmark.com.

Restore held jobs?

Try one or more of the following:

- From the printer control panel, touch **Restore** to restore all held jobs stored in the printer hard disk.
- From the printer control panel, touch **Do not restore** if you do not want to restore any of the print jobs.

Scanner automatic feeder cover open

Close the ADF cover.

Scanner disabled by admin [840.01]

Print without the scanner, or contact your system support person.

Scanner disabled. Contact system administrator if problem persists. [840.02]

Try one or more of the following:

- Touch **Continue with scanner disabled** to return to the home screen, and then contact your system support person.
- Touch **Reboot and automatically enable scanner** to cancel the job.

Note: This attempts to enable the scanner.

Scanner jam, remove all originals from the scanner [2yy.xx]

Remove the jammed paper from the scanner.

Scanner jam, remove jammed originals from the scanner [2yy.xx]

Remove the jammed paper from the scanner.

Serial port [x] disabled [56]

Try one or more of the following:

- From the printer control panel, touch **Continue** to clear the message.
The printer discards any data received through the specified serial port.
- Make sure Serial Buffer is not set to Disabled.
- From the printer control panel, set Serial Buffer to Auto in the Serial [x] menu.

SMTP server not set up. Contact system administrator.

From the printer control panel, touch **Continue** to clear the message.

Note: If the message appears again, then contact your system support person.

Some held jobs were not restored

From the printer control panel, touch **Continue** to delete the indicated job.

Note: Held jobs that are not restored remain in the printer hard disk and are inaccessible.

Standard network software error [54]

Try one or more of the following:

- From the printer control panel, touch **Continue** to continue printing.
- Turn off the printer, and then turn it back on.
- Update the network firmware in the printer or print server. For more information, visit the Lexmark support Web site at <http://support.lexmark.com> or contact customer support, and then report the message.

Standard USB port disabled [56]

Try one or more of the following:

- From the printer control panel, touch **Continue** to clear the message.
- Enable the USB port. From the printer control panel, navigate to:
Network/Ports > USB Buffer > Auto

Note: The printer discards any data received through the USB port.

Supply needed to complete job

Do either of the following:

- Install the missing supply to complete the job.
- Cancel the current job.

Too many flash options installed [58]

- 1 Turn off the printer.
- 2 Unplug the power cord from the electrical outlet.
- 3 Remove the extra flash memory.
- 4 Connect the power cord to a properly grounded electrical outlet.
- 5 Turn the printer back on.

Too many trays attached [58]

- 1 Turn off the printer.
- 2 Unplug the power cord from the electrical outlet.
- 3 Remove the extra trays.
- 4 Connect the power cord to a properly grounded electrical outlet.
- 5 Turn the printer back on.

Unformatted flash detected [53]

Try one or more of the following:

- From the printer control panel, touch **Continue** to stop the defragmentation and continue printing.
- Format the flash memory.

Note: If the error message remains, then the flash memory may be defective and needs to be replaced.

Unsupported disk

Remove the unsupported printer hard disk, and then insert a supported one.

Unsupported option in slot [x] [55]

- 1 Turn off the printer.
- 2 Unplug the power cord from the electrical outlet.
- 3 Remove the unsupported option card from the printer controller board, and then replace it with a supported card.
- 4 Connect the power cord to a properly grounded electrical outlet.
- 5 Turn the printer back on.

USB port [x] disabled [56]

From the printer control panel, touch **Continue** to clear the message.

Notes:

- The printer discards any data received through the USB port.
- Make sure the USB Buffer menu is not set to Disabled.

Weblink server not set up. Contact system administrator.

From the printer control panel, touch **Continue** to clear the message.

Note: If the message appears again, then contact your system support person.

Solving printer problems

- “Basic printer problems” on page 268
- “Option problems” on page 270
- “Paper feed problems” on page 273

Basic printer problems

The printer is not responding

Action	Yes	No
<p>Step 1 Make sure the printer is turned on.</p> <p>Is the printer turned on?</p>	Go to step 2.	Turn on the printer.
<p>Step 2 Check if the printer is in Sleep mode or Hibernate mode.</p> <p>Is the printer in Sleep mode or Hibernate mode?</p>	Press the Sleep button to wake the printer from Sleep mode or Hibernate mode.	Go to step 3.
<p>Step 3 Check if one end of the power cord is plugged into the printer and the other to a properly grounded electrical outlet.</p> <p>Is the power cord plugged into the printer and a properly grounded electrical outlet?</p>	Go to step 4.	Plug one end of the power cord into the printer and the other to a properly grounded electrical outlet.
<p>Step 4 Check other electrical equipment plugged into the electrical outlet.</p> <p>Does other electrical equipment work?</p>	Unplug the other electrical equipment, and then turn on the printer. If the printer does not work, then reconnect the other electrical equipment.	Go to step 5.
<p>Step 5 Check if the cables connecting the printer and the computer are inserted in the correct ports.</p> <p>Are the cables inserted in the correct ports?</p>	Go to step 6.	<p>Make sure to match the following:</p> <ul style="list-style-type: none"> • The USB symbol on the cable with the USB symbol on the printer • The appropriate Ethernet cable with the Ethernet port
<p>Step 6 Make sure the electrical outlet is not turned off by a switch or breaker.</p> <p>Is the electrical outlet turned off by a switch or breaker?</p>	Turn on the switch or reset the breaker.	Go to step 7.

Action	Yes	No
<p>Step 7 Check if the printer is plugged into any surge protectors, uninterruptible power supplies, or extension cords.</p> <p>Is the printer plugged into any surge protectors, uninterruptible power supplies, or extension cords?</p>	<p>Connect the printer power cord directly to a properly grounded electrical outlet.</p>	<p>Go to step 8.</p>
<p>Step 8 Check if one end of the printer cable is plugged into a port on the printer and the other to the computer, print server, option, or other network device.</p> <p>Is the printer cable securely attached to the printer and the computer, print server, option, or other network device?</p>	<p>Go to step 9.</p>	<p>Connect the printer cable securely to the printer and the computer, print server, option, or other network device.</p>
<p>Step 9 Make sure to install all hardware options properly and remove any packing material.</p> <p>Are all hardware options properly installed and all packing material removed?</p>	<p>Go to step 10.</p>	<p>Turn off the printer, remove all packing materials, then reinstall the hardware options, and then turn on the printer.</p>
<p>Step 10 Check if you have selected the correct port settings in the printer driver.</p> <p>Are the port settings correct?</p>	<p>Go to step 11.</p>	<p>Use correct printer driver settings.</p>
<p>Step 11 Check the installed printer driver.</p> <p>Is the correct printer driver installed?</p>	<p>Go to step 12.</p>	<p>Install the correct printer driver.</p>
<p>Step 12 Turn off the printer, then wait for about 10 seconds, and then turn the printer back on.</p> <p>Is the printer working?</p>	<p>The problem is solved.</p>	<p>Contact customer support.</p>

Printer display is blank

Action	Yes	No
<p>Step 1 Press the Sleep button on the printer control panel.</p> <p>Does Ready appear on the printer display?</p>	The problem is solved.	Go to step 2.
<p>Step 2 Turn off the printer, then wait for about 10 seconds, and then turn the printer back on.</p> <p>Do Please wait and Ready appear on the printer display?</p>	The problem is solved.	Turn off the printer, and then contact customer support .

Option problems

Cannot detect internal option

Action	Yes	No
<p>Step 1 Turn off the printer, then wait for about 10 seconds, and then turn on the printer.</p> <p>Does the internal option operate correctly?</p>	The problem is solved.	Go to step 2.
<p>Step 2 Check if the internal option is properly installed in the controller board.</p> <ul style="list-style-type: none"> a Turn off the printer using the power switch, and then unplug the power cord from the electrical outlet. b Make sure the internal option is installed in the appropriate connector in the controller board. c Connect the power cord to the printer, then to a properly grounded electrical outlet, and then turn on the printer. <p>Is the internal option properly installed in the controller board?</p>	Go to step 3.	Connect the internal option to the controller board.
<p>Step 3 Print a menu settings page, and then check to see if the internal option is listed in the Installed Features list.</p> <p>Is the internal option listed in the menu settings page?</p>	Go to step 4.	Reinstall the internal option.

Action	Yes	No
<p>Step 4</p> <p>a Check if the internal option is selected. It may be necessary to manually add the internal option in the printer driver to make it available for print jobs. For more information, see “Updating available options in the printer driver” on page 49.</p> <p>b Resend the print job.</p> <p>Does the internal option operate correctly?</p>	The problem is solved.	Contact customer support .

Tray problems

Action	Yes	No
<p>Step 1</p> <p>a Pull out the tray, and then do one or more of the following:</p> <ul style="list-style-type: none"> • Check for paper jams or misfeeds. • Check if the paper size indicators on the paper guides are aligned with the paper size indicators on the tray. • If you are printing on custom-size paper, then make sure that the paper guides rest against the edges of the paper. • Make sure the paper is below the maximum paper fill indicator. • Make sure paper lies flat in the tray. <p>b Check if the tray closes properly.</p> <p>Is the tray working?</p>	The problem is solved.	Go to step 2.
<p>Step 2</p> <p>a Turn off the printer, then wait about 10 seconds, and then turn the printer back on.</p> <p>b Resend the print job.</p> <p>Is the tray working?</p>	The problem is solved.	Go to step 3.
<p>Step 3</p> <p>Check if the tray is installed and recognized by the printer. Print a menu settings page, and then check if the tray is listed in the Installed Features list.</p> <p>Is the tray listed in the menu settings page?</p>	Go to step 4.	Reinstall the tray. For more information, see the setup documentation that came with the tray.
<p>Step 4</p> <p>Check if the tray is available in the printer driver.</p> <p>Note: If necessary, manually add the tray in the printer driver to make it available for print jobs. For more information, see “Updating available options in the printer driver” on page 49.</p> <p>Is the tray available in the printer driver?</p>	The problem is solved.	Contact customer support .

Cannot detect memory card

Action	Yes	No
<p>Make sure the memory card is installed.</p> <p>a Install the memory card. For more information, see “Installing a memory card” on page 30.</p> <p>Note: Check if the memory card is securely connected to the printer controller board.</p> <p>b Print a menu settings page, and then check if the card is listed in the Installed Options list.</p> <p>Is the card listed in the Installed Options list?</p>	<p>The problem is solved.</p>	<p>Contact customer support.</p>

Internal Solutions Port does not operate correctly

Action	Yes	No
<p>Step 1</p> <p>Make sure the Internal Solutions Port (ISP) is installed.</p> <p>a Install the ISP. For more information, see “Installing an Internal Solutions Port” on page 33.</p> <p>b Print a menu settings page, and then check if the ISP is listed in the Installed Features list.</p> <p>Is the ISP listed in the Installed Features list?</p>	<p>Go to step 2.</p>	<p>Check if you have a supported ISP.</p> <p>Note: An ISP from another printer may not work on this printer.</p>
<p>Step 2</p> <p>Check the cable and the ISP connection.</p> <p>a Use the correct cable, and then make sure it is securely connected to the ISP.</p> <p>b Check if the ISP solution interface cable is securely connected into the receptacle of the controller board.</p> <p>Note: The ISP solution interface cable and the receptacle on the controller board are color-coded.</p> <p>Does the Internal Solutions Port operate correctly?</p>	<p>The problem is solved.</p>	<p>Contact customer support.</p>

USB/parallel interface card does not operate correctly

Action	Yes	No
<p>Step 1</p> <p>Make sure the USB or parallel interface card is installed.</p> <p>a Install the USB or parallel interface card. For more information, see “Installing an Internal Solutions Port” on page 33.</p> <p>b Print a menu settings page, and then check if the USB or parallel interface card is listed in the Installed Features list.</p> <p>Is the USB or parallel interface card listed in the Installed Features list?</p>	<p>Go to step 2.</p>	<p>Check if you have a supported USB or parallel interface card.</p> <p>Note: A USB or parallel interface card from another printer may not work on this printer.</p>

Action	Yes	No
<p>Step 2</p> <p>Check the cable and the USB or parallel interface card connection. Use the correct cable, and then make sure it is securely connected to the USB or parallel interface card.</p> <p>Does the USB or parallel interface card operate correctly?</p>	<p>The problem is solved.</p>	<p>Contact customer support.</p>

Paper feed problems

Paper frequently jams

Action	Yes	No
<p>Step 1</p> <p>a Pull out the tray, and then do one or more of the following:</p> <ul style="list-style-type: none"> • Make sure paper lies flat in the tray. • Check if the paper size indicators on the paper guides are aligned with the paper size indicators on the tray. • Check if the paper guides are aligned against the edges of the paper. • Make sure the paper is below the maximum paper fill indicator. • Check if you are printing on a recommended paper size and type. <p>b Insert the tray properly. If jam recovery is enabled, then the print jobs will reprint automatically.</p> <p>Do paper jams still occur frequently?</p>	<p>Go to step 2.</p>	<p>The problem is solved.</p>
<p>Step 2</p> <p>a Load paper from a fresh package. Note: Paper absorbs moisture due to high humidity. Store paper in its original wrapper until you use it.</p> <p>b Resend the print job.</p> <p>Do paper jams still occur frequently?</p>	<p>Go to step 3.</p>	<p>The problem is solved.</p>
<p>Step 3</p> <p>a Review the tips on avoiding jams. For more information, see “Avoiding jams” on page 235.</p> <p>b Follow the recommendations, and then resend the print job.</p> <p>Do paper jams still occur frequently?</p>	<p>Contact customer support.</p>	<p>The problem is solved.</p>

Paper jam message remains after jam is cleared

Action	Yes	No
<p>Check the entire paper path for jammed paper.</p> <ul style="list-style-type: none"> a Remove any jammed paper. b From the printer control panel, touch Continue to clear the message. <p>Does the paper jam message remain?</p>	Contact customer support .	The problem is solved.

Jammed pages are not reprinted

Action	Yes	No
<p>Turn on Jam Recovery.</p> <ul style="list-style-type: none"> a From the home screen, navigate to: <ul style="list-style-type: none">  > Settings > General Settings > Print Recovery b From the Jam Recovery menu, touch the arrows to scroll to On or Auto. c Touch Submit. <p>Do pages reprint after a jam?</p>	The problem is solved.	Contact customer support .

Solving print problems

Printing problems

Multiple-language PDF files do not print

Action	Yes	No
<p>Step 1</p> <ul style="list-style-type: none"> a Check if the print options for the PDF output are set to embed all fonts. For more information, see the documentation that came with Adobe Acrobat. b Generate a new PDF file, and then resend the print job. <p>Do the files print?</p>	The problem is solved.	Go to step 2.
<p>Step 2</p> <ul style="list-style-type: none"> a Open the document you want to print in Adobe Acrobat. b Click File > Print > Advanced > Print As Image > OK > OK. <p>Do the files print?</p>	The problem is solved.	Contact customer support .

Error message about reading the flash drive appears

Action	Yes	No
<p>Step 1 Check if the flash drive is inserted into the front USB port. Note: The flash drive will not work if it is inserted into the rear USB port.</p> <p>Is the flash drive inserted into the front USB port?</p>	Go to step 2.	Insert the flash drive into the front USB port.
<p>Step 2 Check if the indicator light on the printer control panel is blinking green. Note: A green blinking light indicates that the printer is busy.</p> <p>Is the indicator light blinking green?</p>	Wait until the printer is ready, then view the held jobs list, and then print the documents.	Go to step 3.
<p>Step 3 a Check for an error message on the display. b Clear the message.</p> <p>Does the error message still appear?</p>	Go to step 4.	The problem is solved.
<p>Step 4 Check if the flash drive is supported. For more information on tested and approved USB flash drives, see “Supported flash drives and file types” on page 84.</p> <p>Does the error message still appear?</p>	Go to step 5.	The problem is solved.
<p>Step 5 Check if the USB port is disabled by the system support person.</p> <p>Does the error message still appear?</p>	Contact customer support .	The problem is solved.

Print jobs do not print

Action	Yes	No
<p>Step 1 a From the document you are trying to print, open the Print dialog and check if you have selected the correct printer. Note: If the printer is not the default printer, then you must select the printer for each document that you want to print. b Resend the print job.</p> <p>Do the jobs print?</p>	The problem is solved.	Go to step 2.



Action	Yes	No
<p>Step 2</p> <p>a Check if the printer is plugged in and turned on, and if Ready appears on the printer display.</p> <p>b Resend the print job.</p> <p>Do the jobs print?</p>	The problem is solved.	Go to step 3.
<p>Step 3</p> <p>If an error message appears on the printer display, then clear the message.</p> <p>Note: The printer continues to print after clearing the message.</p> <p>Do the jobs print?</p>	The problem is solved.	Go to step 4.
<p>Step 4</p> <p>a Check if the ports (USB, serial, or Ethernet) are working and if the cables are securely connected to the computer and the printer.</p> <p>Note: For more information, see the setup documentation that came with the printer.</p> <p>b Resend the print job.</p> <p>Do the jobs print?</p>	The problem is solved.	Go to step 5.
<p>Step 5</p> <p>a Turn off the printer, then wait for about 10 seconds, and then turn the printer back on.</p> <p>b Resend the print job.</p> <p>Do the jobs print?</p>	The problem is solved.	Go to step 6.
<p>Step 6</p> <p>a Remove, and then reinstall the printer software. For more information, see “Installing the printer software” on page 48.</p> <p>Note: The printer software is available at http://support.lexmark.com.</p> <p>b Resend the print job.</p> <p>Do the jobs print?</p>	The problem is solved.	Contact customer support .

Confidential and other held jobs do not print

Note: Confidential, Verify, Reserve, and Repeat print jobs may be deleted if the printer requires extra memory to process additional held jobs.

Action	Yes	No
<p>Step 1 Open the held jobs folder on the printer display, and then verify that your print job is listed.</p> <p>Is your print job listed in the held jobs folder?</p>	<p>Go to step 2.</p>	<p>Select one of the Print and Hold options, and then resend the print job. For more information, see “Printing confidential and other held jobs” on page 86.</p>
<p>Step 2 The print job may contain a formatting error or invalid data.</p> <ul style="list-style-type: none"> • Delete the print job, and then send it again. • For PDF files, generate a new PDF, and then print it again. <p>If you are printing from the Internet, then the printer may be reading multiple job titles as duplicates and deleting all jobs except the first one.</p> <p>For Windows users</p> <ol style="list-style-type: none"> a Open the Print Properties folder. b From the Print and Hold dialog, select the “Keep duplicate documents” check box. c Enter a PIN number. <p>For Macintosh users Save each print job, name each job differently, and then send the individual jobs to the printer.</p> <p>Does the job print?</p>	<p>The problem is solved.</p>	<p>Go to step 3.</p>
<p>Step 3 Free up additional printer memory by deleting some of the held jobs.</p> <p>Does the job print?</p>	<p>The problem is solved.</p>	<p>Add additional printer memory.</p>

Print job takes longer than expected

Action	Yes	No
<p>Step 1 Change the environmental settings of the printer.</p> <p>a From the printer control panel, navigate to:</p> <p> > Settings > General Settings</p> <p>b Select Eco-Mode or Quiet Mode, and then select Off.</p> <p>Note: Disabling Eco-Mode or Quiet Mode may increase the consumption of energy or supplies, or both.</p> <p>Did the job print?</p>	The problem is solved.	Go to step 2.
<p>Step 2 Reduce the number and size of fonts, the number and complexity of images, and the number of pages in the print job, and then resend the job</p> <p>Did the job print?</p>	The problem is solved.	Go to step 3.
<p>Step 3</p> <p>a Remove held jobs stored in the printer memory.</p> <p>b Resend the print job.</p> <p>Did the job print?</p>	The problem is solved.	Go to step 4.
<p>Step 4</p> <p>a Disable the Page Protect feature. From the printer control panel, navigate to:</p> <p> >Settings > General Settings > Print Recovery > Page Protect > Off</p> <p>b Resend the print job.</p> <p>Did the job print?</p>	The problem is solved.	Go to step 5.
<p>Step 5</p> <p>a Check if the cable connections to the printer and print server are secure. For more information, see the setup documentation that came with the printer.</p> <p>b Resend the print job.</p> <p>Did the job print?</p>	The problem is solved.	Go to step 6.
<p>Step 6 Install additional printer memory, and then resend the print job.</p> <p>Did the job print?</p>	The problem is solved.	Contact customer support .

Job prints from the wrong tray or on the wrong paper

Action	Yes	No
<p>Step 1</p> <p>a Check if you are printing on paper that is supported by the tray.</p> <p>b Resend the print job.</p> <p>Did the job print from the correct tray or on the correct paper?</p>	The problem is solved.	Go to step 2.
<p>Step 2</p> <p>a From the Paper menu on the printer control panel, set the paper size and type to match the paper loaded in the tray.</p> <p>b Resend the print job.</p> <p>Did the job print from the correct tray or on the correct paper?</p>	The problem is solved.	Go to step 3.
<p>Step 3</p> <p>a Depending on your operating system, open Printing Preferences or the Print dialog, and then specify the paper type.</p> <p>b Resend the print job.</p> <p>Did the job print from the correct tray or on the correct paper?</p>	The problem is solved.	Go to step 4.
<p>Step 4</p> <p>a Check if the trays are not linked.</p> <p>b Resend the print job.</p> <p>Did the job print from the correct tray or on the correct paper?</p>	The problem is solved.	Contact customer support .

Incorrect characters print

Action	Yes	No
<p>Step 1</p> <p>Make sure the printer is not in Hex Trace mode.</p> <p>Note: If Ready Hex appears on the printer display, then turn off the printer, and then turn it back on to deactivate Hex Trace mode.</p> <p>Is the printer in Hex Trace mode?</p>	Deactivate Hex Trace mode.	Go to step 2.
<p>Step 2</p> <p>a From the printer control panel, select Standard Network or Network [x], and then set SmartSwitch to On.</p> <p>b Resend the print job.</p> <p>Do incorrect characters print?</p>	Contact customer support .	The problem is solved.

Tray linking does not work

Notes:

- The trays can detect paper length.
- The multipurpose feeder does not automatically detect the paper size. You must set the size from the Paper Size/Type menu.

Action	Yes	No
<p>Step 1</p> <p>a Open the trays, and then check if they contain paper of the same size and type.</p> <ul style="list-style-type: none"> • Check if the paper guides are in the correct positions for the size of the paper loaded in each tray. • Check if the paper size indicators on the paper guides are aligned with the paper size indicators on the tray. <p>b Resend the print job.</p> <p>Do the trays link correctly?</p>	The problem is solved.	Go to step 2.
<p>Step 2</p> <p>a From the printer control panel, set the paper size and type in the Paper menu to match the paper loaded in the trays to be linked.</p> <p>Note: The paper size and type must match for trays to be linked.</p> <p>b Resend the print job.</p> <p>Do the trays link correctly?</p>	The problem is solved.	Contact customer support .

Large jobs do not collate

Action	Yes	No
<p>Step 1</p> <p>a From the Finishing menu on the printer control panel, set Collate to (1,2,3) (1,2,3).</p> <p>b Resend the print job.</p> <p>Did the job print and collate correctly?</p>	The problem is solved.	Go to step 2.
<p>Step 2</p> <p>a From the printer software, set Collate to (1,2,3) (1,2,3).</p> <p>Note: Setting Collate to (1,1,1) (2,2,2) in the software overrides the setting in the Finishing menu.</p> <p>b Resend the print job.</p> <p>Did the job print and collate correctly?</p>	The problem is solved.	Go to step 3.

Action	Yes	No
<p>Step 3 Reduce the complexity of the print job by eliminating the number and size of fonts, the number and complexity of images, and the number of pages in the job.</p> <p>Did the job print and collate correctly?</p>	The problem is solved.	Contact customer support .

Unexpected page breaks occur

Action	Yes	No
<p>Increase the printing timeout.</p> <p>a From the home screen, navigate to:</p> <p> > Settings > General Settings > Timeouts</p> <p>b Increase the Print Timeout setting, and then touch Submit.</p> <p>c Resend the print job.</p> <p>Did the file print correctly?</p>	The problem is solved.	Check the original file for manual page breaks.

Print quality problems

Characters have jagged or uneven edges

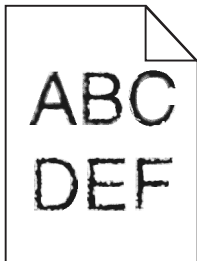

Action	Yes	No
<p>Step 1</p> <p>a Print a font sample list to check if the fonts you are using are supported by the printer.</p> <p>1 From the printer control panel, navigate to:</p> <p> > Reports > Print Fonts</p> <p>2 Touch PCL Fonts or PostScript Fonts.</p> <p>b Use a font that is supported by the printer or install the font that you want to use. For more information, contact your system support person.</p> <p>c Resend the print job.</p> <p>Do prints still contain characters that have jagged or uneven edges?</p>	Go to step 2.	The problem is solved.

Action	Yes	No
<p>Step 2</p> <p>a Use a font that is supported by the printer or install the font that you want to use on your computer. For more information, contact your system support person.</p> <p>b Resend the print job.</p> <p>Do prints still contain characters that have jagged or uneven edges?</p>	<p>Contact customer support.</p>	<p>The problem is solved.</p>

Printer is printing blank pages

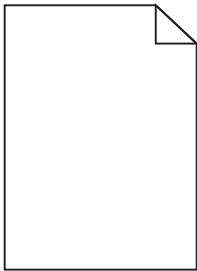

Action	Yes	No
<p>Step 1</p> <p>a Check if there is packing material left on the imaging unit.</p> <ol style="list-style-type: none"> 1 Remove the toner cartridge, and then the imaging unit. 2 Check if the packing material is properly removed from the imaging unit. <p>Warning—Potential Damage: Do not expose the imaging unit to direct light for more than 10 minutes. Extended exposure to light may cause print quality problems.</p> <ol style="list-style-type: none"> 3 Reinstall the imaging unit, and then the cartridge. <p>b Resend the print job.</p> <p>Is the printer still printing blank pages?</p>	<p>Go to step 2.</p>	<p>The problem is solved.</p>
<p>Step 2</p> <p>a Redistribute the toner in the imaging unit.</p> <ol style="list-style-type: none"> 1 Remove the toner cartridge, and then the imaging unit. 2 Firmly shake the imaging unit. <p>Warning—Potential Damage: Do not expose the imaging unit to direct light for more than 10 minutes. Extended exposure to light may cause print quality problems.</p> <ol style="list-style-type: none"> 3 Reinstall the imaging unit, and then the cartridge. <p>b Resend the print job.</p> <p>Is the printer still printing blank pages?</p>	<p>Go to step 3.</p>	<p>The problem is solved.</p>

Action	Yes	No
<p>Step 3 Replace the imaging unit, and then resend the print job.</p> <p>Is the printer still printing blank pages?</p>	Contact customer support .	The problem is solved.

Clipped pages or images

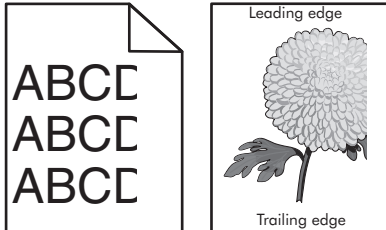

Action	Yes	No
<p>Step 1</p> <p>a Move the width and length guides in the tray to the correct positions for the paper loaded.</p> <p>b Resend the print job.</p> <p>Is the page or image clipped?</p>	Go to step 2.	The problem is solved.
<p>Step 2</p> <p>From the printer control panel, set the paper size and type in the Paper menu to match the paper loaded in the tray.</p> <p>Do the paper size and type match the paper loaded in the tray?</p>	Go to step 3.	<p>Do one or more of the following:</p> <ul style="list-style-type: none"> Specify the paper size from the tray settings to match the paper loaded in the tray. Change the paper loaded in the tray to match the paper size specified in the tray settings.
<p>Step 3</p> <p>a Depending on your operating system, specify the paper size from Printing Preferences or from the Print dialog.</p> <p>b Resend the print job.</p> <p>Is the page or image clipped?</p>	Go to step 4.	The problem is solved.

Action	Yes	No
<p>Step 4</p> <p>a Reinstall the imaging unit.</p> <ol style="list-style-type: none"> 1 Remove the toner cartridge. 2 Remove the imaging unit. <p>Warning—Potential Damage: Do not expose the imaging unit to direct light for more than 10 minutes. Extended exposure to light may cause print quality problems.</p> <ol style="list-style-type: none"> 3 Install the imaging unit, and then the cartridge. <p>b Resend the print job.</p> <p>Is the page or image clipped?</p>	<p>Contact customer support.</p>	<p>The problem is solved.</p>

Prints on color transparencies appear dark when projected

Note: This problem occurs when projecting transparencies with reflective overhead projectors. To obtain the highest projected color quality, transmissive overhead projectors are recommended.

Action	Yes	No
<p>Step 1</p> <p>From the printer control panel, make sure the paper type setting is set to Transparency.</p> <p>Is the paper type setting correct?</p>	<p>Go to step 2.</p>	<p>Set the paper type to Transparency.</p>
<p>Step 2</p> <p>Reduce the toner darkness, and then resend the print job.</p> <p>Does the print on the color transparency look lighter?</p>	<p>The problem is solved.</p>	<p>Go to step 3.</p>
<p>Step 3</p> <p>Make sure you are using a recommended type of color transparency, and then resend the print job.</p> <p>Does the print on the color transparency look lighter?</p>	<p>The problem is solved.</p>	<p>Contact customer support.</p>

Shadow images appear on prints

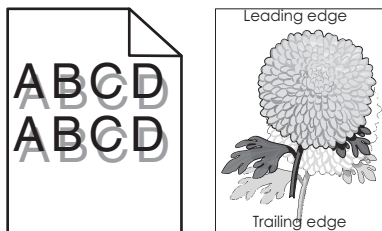

Action	Yes	No
<p>Step 1 Load paper with the correct paper type and weight in the tray.</p> <p>Is paper with the correct paper type and weight loaded in the tray?</p>	Go to step 2.	Load paper with the correct paper type and weight in the tray.
<p>Step 2 From the printer control panel, set the paper type and weight in the Paper menu to match the paper loaded in the tray.</p> <p>Is the tray set to the type and weight of the paper loaded?</p>	Go to step 3.	Change the paper loaded in the tray to match the paper type and weight specified in the tray settings.
<p>Step 3</p> <ul style="list-style-type: none"> a Depending on your operating system, specify the paper type and weight from Printing Preferences or from the Print dialog. b Resend the print job. <p>Do shadow images still appear on prints?</p>	Go to step 4.	The problem is solved.
<p>Step 4 Replace the imaging unit, and then resend the print job.</p> <p>Do shadow images still appear on prints?</p>	Contact customer support .	The problem is solved.

Gray background on prints

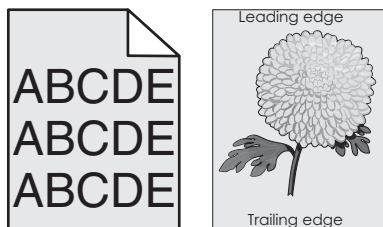

Action	Yes	No
<p>Step 1 Check if Allow Background Removal is set to Off.</p> <ul style="list-style-type: none"> a From the General Settings menu, set Allow Background Removal to On. b Resend the print job. <p>Did the background disappear from the prints?</p>	The problem is solved.	Go to step 2.

Action	Yes	No
<p>Step 2 Adjust the toner darkness to a lighter setting.</p> <p>a From the Quality Menu, select a lower value to reduce toner density.</p> <ul style="list-style-type: none"> • 4 is the factory default setting. • If Print Mode is set to Black Only, then a setting of 5 increases toner density and darkness for all print jobs. <p>b Resend the print job.</p> <p>Did the background disappear from the prints?</p>	The problem is solved.	Go to step 3.
<p>Step 3 Reinstall the toner cartridge.</p> <p>a Remove the cartridge.</p> <p>b Install the cartridge.</p> <p>c Resend the print job.</p> <p>Did the background disappear from the prints?</p>	The problem is solved.	Go to step 4.
<p>Step 4 Check if off-white background is selected.</p> <p>a Depending on your operating system, set off-white background from Print Properties or the Print dialog.</p> <p>b Resend the print job.</p> <p>Did the background disappear from the prints?</p>	The problem is solved.	Contact customer support .

Incorrect margins on prints

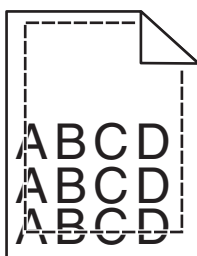

Action	Yes	No
<p>Step 1</p> <p>a Move the width and length guides in the tray to the correct positions for the paper size loaded.</p> <p>b Resend the print job.</p> <p>Are the margins correct?</p>	The problem is solved.	Go to step 2.

Action	Yes	No
<p>Step 2</p> <p>From the printer control panel, set the paper size in the Paper menu to match the paper loaded in the tray.</p> <p>Does the paper size match the paper loaded in the tray?</p>	Go to step 3.	<p>Do one or more of the following:</p> <ul style="list-style-type: none"> Specify the paper size from the tray settings to match the paper loaded in the tray. Change the paper loaded in the tray to match the paper size specified in the tray settings.
<p>Step 3</p> <p>a Depending on your operating system, specify the paper size from Printing Preferences or from the Print dialog.</p> <p>b Resend the print job.</p> <p>Are the margins correct?</p>	The problem is solved.	Contact customer support .

Paper curl

Action	Yes	No
<p>Step 1</p> <p>Move the width and length guides in the tray to the correct positions for the size of the paper loaded.</p> <p>Are the width and length guides positioned correctly?</p>	Go to step 2.	Adjust the width and length guides.
<p>Step 2</p> <p>From the printer control panel, set the paper type and weight in the Paper menu to match the paper loaded in the tray.</p> <p>Do the paper type and weight match the type and weight of the paper in the tray?</p>	Go to step 3.	Specify the paper type and weight from the tray settings to match the paper loaded in the tray.
<p>Step 3</p> <p>a Depending on your operating system, specify the paper type and weight from Printing Preferences or from the Print dialog.</p> <p>b Resend the print job.</p> <p>Is the paper still curled?</p>	Go to step 4.	The problem is solved.
<p>Step 4</p> <p>a Remove the paper from the tray, and then turn it over.</p> <p>b Resend the print job.</p> <p>Is the paper still curled?</p>	Go to step 5.	The problem is solved.

Action	Yes	No
<p>Step 5</p> <p>a Load paper from a fresh package.</p> <p>Note: Paper absorbs moisture due to high humidity. Store paper in its original wrapper until you use it.</p> <p>b Resend the print job.</p> <p>Is the paper still curled?</p>	<p>Contact customer support.</p>	<p>The problem is solved.</p>

Print irregularities

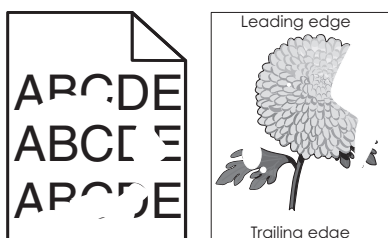

Action	Yes	No
<p>Step 1</p> <p>a Move the width and length guides in the tray to the correct positions for the size of the paper loaded in the tray.</p> <p>b Resend the print job.</p> <p>Do print irregularities still appear?</p>	<p>Go to step 2.</p>	<p>The problem is solved.</p>
<p>Step 2</p> <p>From the printer control panel, set the paper size and type in the Paper menu to match the paper loaded in the tray.</p> <p>Do the printer settings match the type and weight of the paper loaded in the tray?</p>	<p>Go to step 3.</p>	<p>Specify the paper size and type from the tray settings to match the paper loaded in the tray.</p>
<p>Step 3</p> <p>a Depending on your operating system, specify the paper type and weight from Printing Preferences or from the Print dialog.</p> <p>b Resend the print job.</p> <p>Do print irregularities still appear?</p>	<p>Go to step 4.</p>	<p>The problem is solved.</p>
<p>Step 4</p> <p>Check if the paper loaded in the tray has texture or rough finishes.</p> <p>Are you printing on textured or rough paper?</p>	<p>From the printer control panel, set the paper texture in the Paper menu to match the paper loaded in the tray.</p>	<p>Go to step 5.</p>

Action	Yes	No
<p>Step 5</p> <p>a Load paper from a fresh package.</p> <p>Note: Paper absorbs moisture due to high humidity. Store paper in its original wrapper until you use it.</p> <p>b Resend the print job.</p> <p>Do print irregularities still appear?</p>	Go to step 6.	The problem is solved.
<p>Step 6</p> <p>Replace the imaging unit, and then resend the print job.</p> <p>Do print irregularities still appear?</p>	Contact customer support at http://support.lexmark.com or your service representative.	The problem is solved.

Repeating defects appear on prints

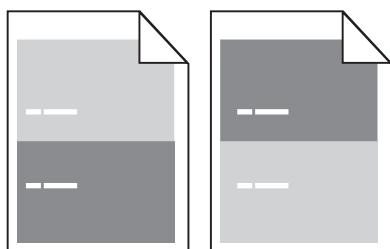

Action	Yes	No
<p>Step 1</p> <p>Measure the distance between the defects.</p> <p>Check for a distance between the defects that equals:</p> <ul style="list-style-type: none"> • 97 mm (3.82 in.) • 47 mm (1.85 in.) • 38 mm (1.5 in.) <p>Is the distance between defects equal to one of the listed measurements?</p>	Go to step 2.	<p>1 Check if the distance between the defects equal to 80 mm (3.15 in.)</p> <p>2 Take note of the distance, and then contact customer support at http://support.lexmark.com or your service representative.</p>
<p>Step 2</p> <p>Replace the imaging unit, and then resend the print job.</p> <p>Do the repeating defects still appear?</p>	Contact customer support at http://support.lexmark.com or your service representative.	The problem is solved.

Print is too dark

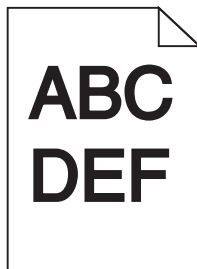

Action	Yes	No
<p>Step 1</p> <p>a From the Quality menu on the printer control panel, reduce the toner darkness.</p> <p>Note: 8 is the factory default setting.</p> <p>b Resend the print job.</p> <p>Is the print still too dark?</p>	Go to step 2.	The problem is solved.
<p>Step 2</p> <p>a From the printer control panel, set the paper type, texture and weight in the Paper menu to match the paper loaded in the tray.</p> <p>b Resend the print job.</p> <p>Is the tray set to the type, texture, and weight of the paper loaded?</p>	Go to step 3.	<p>Do one or more of the following:</p> <ul style="list-style-type: none"> Specify the paper type, texture, and weight from the tray settings to match the paper loaded in the tray. Change the paper loaded in the tray to match the paper type, texture and weight specified in the tray settings.
<p>Step 3</p> <p>a Depending on your operating system, specify the paper type, texture and weight from Printing Preferences or from the Print dialog.</p> <p>b Resend the print job.</p> <p>Is the print still too dark?</p>	Go to step 4.	The problem is solved.
<p>Step 4</p> <p>Check if the paper loaded in the tray has texture or rough finishes.</p> <p>Are you printing on textured or rough paper?</p>	From the printer control panel, change the texture settings in the Paper Texture menu to match the paper you are printing on.	Go to step 5.

Action	Yes	No
<p>Step 5</p> <p>a Load paper from a fresh package.</p> <p>Note: Paper absorbs moisture due to high humidity. Store paper in its original wrapper until you use it.</p> <p>b Resend the print job.</p> <p>Is the print still too dark?</p>	Go to step 6.	The problem is solved.
<p>Step 6</p> <p>Replace the imaging unit, and then resend the print job.</p> <p>Is the print still too dark?</p>	Contact customer support .	The problem is solved.

Print is too light



Action	Yes	No
<p>Step 1</p> <p>a From the Quality menu on the printer control panel, increase the toner darkness.</p> <p>Note: 8 is the factory default setting.</p> <p>b Resend the print job.</p> <p>Is the print still too light?</p>	Go to step 2.	The problem is solved.
<p>Step 2</p> <p>From the printer control panel, set the paper type, texture, and weight in the Paper menu to match the paper loaded in the tray.</p> <p>Is the tray set to the type, texture, and weight of the paper loaded?</p>	Go to step 3.	Change the paper type, texture, and weight to match the paper loaded in the tray.
<p>Step 3</p> <p>a Depending on your operating system, specify the paper type, texture, and weight from Printing Preferences or from the Print dialog.</p> <p>b Resend the print job.</p> <p>Is the print still too light?</p>	Go to step 4.	The problem is solved.

Action	Yes	No
<p>Step 4 Make sure that the paper has no texture or rough finishes.</p> <p>Are you printing on textured or rough paper?</p>	<p>From the printer control panel, change the texture settings in the Paper Texture menu to match the paper you are printing on.</p>	<p>Go to step 5.</p>
<p>Step 5 a Load paper from a fresh package. Note: Paper absorbs moisture due to high humidity. Store paper in its original wrapper until you use it. b Resend the print job.</p> <p>Is the print still too light?</p>	<p>Go to step 6.</p>	<p>The problem is solved.</p>
<p>Step 6 a Redistribute the toner in the imaging unit. 1 Remove the toner cartridge, and then the imaging unit. 2 Firmly shake the imaging unit. Warning—Potential Damage: Do not expose the imaging unit to direct light for more than 10 minutes. Extended exposure to light may cause print quality problems. 3 Install the imaging unit, and then the cartridge. b Resend the print job.</p> <p>Is the print still too light?</p>	<p>Go to step 7.</p>	<p>The problem is solved.</p>
<p>Step 7 Replace the imaging unit, and then resend the print job.</p> <p>Is the print still too light?</p>	<p>Contact customer support.</p>	<p>The problem is solved.</p>

Skewed print

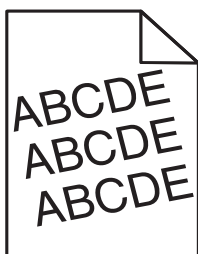

Action	Yes	No
<p>Step 1</p> <ul style="list-style-type: none"> a Move the width and length guides in the tray to the correct positions for the size of the paper loaded. b Resend the print job. <p>Is the print still skewed?</p>	Go to step 2.	The problem is solved.
<p>Step 2</p> <ul style="list-style-type: none"> a Check if you are printing on a paper that is supported by the tray. b Resend the print job. <p>Is the print still skewed?</p>	Contact customer support .	The problem is solved.

Printer is printing solid black pages



Action	Yes	No
<p>Step 1</p> <ul style="list-style-type: none"> a Reinstall the imaging unit. <ul style="list-style-type: none"> 1 Remove the toner cartridge, and then the imaging unit. <p>Warning—Potential Damage: Do not expose the imaging unit to direct light for more than 10 minutes. Extended exposure to light may cause print quality problems.</p> 2 Install the imaging unit, and then the cartridge. b Resend the print job. <p>Is the printer printing solid black pages?</p>	Go to step 2.	The problem is solved.
<p>Step 2</p> <p>Replace the imaging unit, and then resend the print job.</p> <p>Is the printer printing solid black pages?</p>	Contact customer support .	The problem is solved.

Transparency print quality is poor

Action	Yes	No
<p>Step 1 From the printer control panel, set the paper type in the Paper menu to match the paper loaded in the tray.</p> <p>Is the paper type for the tray set to Transparency?</p>	Go to step 2.	Set the paper type to Transparency.
<p>Step 2 <ul style="list-style-type: none"> a Check if you are using a recommended type of transparency. b Resend the print job. </p> <p>Is the print quality still poor?</p>	Contact customer support .	The problem is solved.

Streaked horizontal lines appear on prints

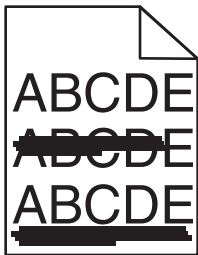

Action	Yes	No
<p>Step 1 <ul style="list-style-type: none"> a Depending on your operating system, specify the tray or feeder from Printing Preferences or the Print dialog. b Resend the print job. </p> <p>Do streaked horizontal lines appear on prints?</p>	Go to step 2.	The problem is solved.
<p>Step 2 From the printer control panel, set the paper type and weight in the Paper menu to match the paper loaded in the tray.</p> <p>Do the paper type and weight match the type and weight of the paper in the tray?</p>	Go to step 3.	Change the paper type and weight to match the paper loaded in the tray.
<p>Step 3 <ul style="list-style-type: none"> a Load paper from a fresh package. Note: Paper absorbs moisture due to high humidity. Store paper in its original wrapper until you use it. b Resend the print job. </p> <p>Do streaked horizontal lines appear on prints?</p>	Go to step 4.	The problem is solved.

Action	Yes	No
<p>Step 4</p> <p>a Reinstall the imaging unit.</p> <p>1 Remove the toner cartridge, and then the imaging unit.</p> <p>Warning—Potential Damage: Do not expose the imaging unit to direct light for more than 10 minutes. Extended exposure to light may cause print quality problems.</p> <p>2 Install the imaging unit, and then the cartridge.</p> <p>b Resend the print job.</p> <p>Do streaked horizontal lines appear on prints?</p>	Go to step 5.	The problem is solved.
<p>Step 5</p> <p>Replace the imaging unit, and then resend the print job.</p> <p>Do streaked horizontal lines appear on prints?</p>	Contact customer support .	The problem is solved.

Streaked vertical lines appear on prints

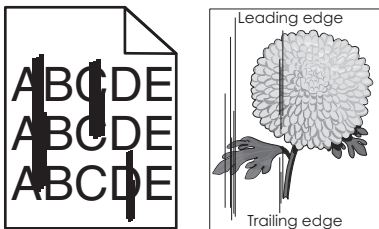

Action	Yes	No
<p>Step 1</p> <p>a Depending on your operating system, specify the paper type, texture, and weight from Printing Preferences or from the Print dialog.</p> <p>b Resend the print job.</p> <p>Do streaked vertical lines appear on prints?</p>	Go to step 2.	The problem is solved.
<p>Step 2</p> <p>From the printer control panel, set the paper texture, type, and weight in the Paper menu to match the paper loaded in the tray.</p> <p>Do the paper texture, type, and weight match the paper in the tray?</p>	Go to step 3.	<p>Do one or more of the following:</p> <ul style="list-style-type: none"> Specify the paper texture, type, and weight from the tray settings to match the paper loaded in the tray. Change the paper loaded in the tray to match the paper texture, type, and weight specified in the tray settings.

Action	Yes	No
<p>Step 3</p> <p>a Load paper from a fresh package. Note: Paper absorbs moisture due to high humidity. Store paper in its original wrapper until you use it.</p> <p>b Resend the print job.</p> <p>Do streaked vertical lines appear on prints?</p>	Go to step 4.	The problem is solved.
<p>Step 4</p> <p>a Reinstall the imaging unit.</p> <p>1 Remove the toner cartridge, and then the imaging unit. Warning—Potential Damage: Do not expose the imaging unit to direct light for more than 10 minutes. Extended exposure to light may cause print quality problems.</p> <p>2 Install the imaging unit, and then the cartridge.</p> <p>b Resend the print job.</p> <p>Do streaked vertical lines appear on prints?</p>	Go to step 5.	The problem is solved.
<p>Step 5</p> <p>Replace the imaging unit, and then resend the print job.</p> <p>Do streaked vertical lines appear on prints?</p>	Contact customer support at http://support.lexmark.com or your service representative.	The problem is solved.

Horizontal voids appear on prints

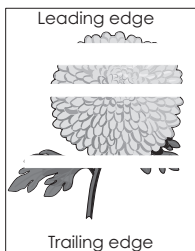

Action	Yes	No
<p>Step 1</p> <p>a Make sure your software program is using a correct fill pattern.</p> <p>b Resend the print job.</p> <p>Do horizontal voids appear on prints?</p>	Go to step 2.	The problem is solved.
<p>Step 2</p> <p>a Load the specified tray or feeder with a recommended type of paper.</p> <p>b Resend the print job.</p> <p>Do horizontal voids appear on prints?</p>	Go to step 3.	The problem is solved.

Action	Yes	No
<p>Step 3</p> <p>a Redistribute the toner in the imaging unit.</p> <ol style="list-style-type: none"> 1 Remove the toner cartridge, and then the imaging unit. 2 Firmly shake the imaging unit. <p>Warning—Potential Damage: Do not expose the imaging unit to direct light for more than 10 minutes. Extended exposure to light may cause print quality problems.</p> <ol style="list-style-type: none"> 3 Reinstall the imaging unit, and then the cartridge. <p>b Resend the print job.</p> <p>Do horizontal voids appear on prints?</p>	Go to step 4.	The problem is solved.
<p>Step 4</p> <p>Replace the imaging unit, and then resend the print job.</p> <p>Do horizontal voids appear on prints?</p>	Contact customer support .	The problem is solved.

Vertical voids appear on prints

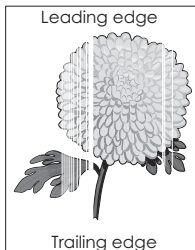

Action	Yes	No
<p>Step 1</p> <p>a Make sure your software program is using a correct fill pattern.</p> <p>b Resend the print job.</p> <p>Do vertical voids appear on prints?</p>	Go to step 2.	The problem is solved.
<p>Step 2</p> <p>a From the printer control panel, set the paper type and weight in the Paper menu to match the paper loaded in the tray.</p> <p>b Resend the print job.</p> <p>Do vertical voids appear on prints?</p>	Go to step 3.	The problem is solved.
<p>Step 3</p> <p>Check if you are using a recommended type of paper.</p> <p>a Load the specified tray or feeder with a recommended type of paper.</p> <p>b Resend the print job.</p> <p>Do vertical voids appear on prints?</p>	Go to step 4.	The problem is solved.

Action	Yes	No
<p>Step 4</p> <p>a Redistribute the toner in the imaging unit.</p> <ol style="list-style-type: none"> 1 Remove the toner cartridge, and then the imaging unit. 2 Firmly shake the imaging unit. <p>Warning—Potential Damage: Do not expose the imaging unit to direct light for more than 10 minutes. Extended exposure to light may cause print quality problems.</p> <ol style="list-style-type: none"> 3 Reinstall the imaging unit, and then the cartridge. <p>b Resend the print job.</p> <p>Do vertical voids appear on prints?</p>	Go to step 5.	The problem is solved.
<p>Step 5</p> <p>Replace the imaging unit, and then resend the print job.</p> <p>Do vertical voids appear on prints?</p>	Contact customer support .	The problem is solved.

Toner specks appear on prints

Action	Yes	No
<p>Replace the imaging unit, and then resend the print job.</p> <p>Do toner specks appear on prints?</p>	Contact customer support .	The problem is solved.

Toner fog or background shading appears on prints

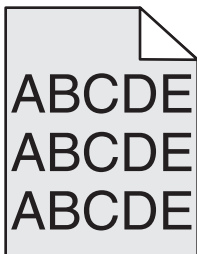

Action	Yes	No
<p>Step 1</p> <p>Reinstall the imaging unit.</p> <ol style="list-style-type: none"> a Remove, and then install the imaging unit. b Resend the print job. <p>Does fog or shading appear on prints?</p>	Go to step 2.	The problem is solved.

Action	Yes	No
<p>Step 2 Replace the imaging unit, and then resend the print job.</p> <p>Does fog or shading appear on prints?</p>	<p>Contact customer support at http://support.lexmark.com or your service representative.</p>	<p>The problem is solved.</p>

Toner rubs off

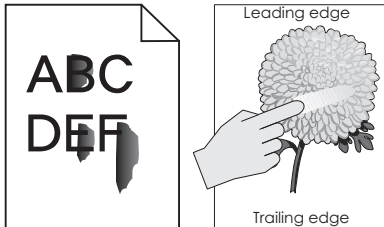

Action	Yes	No
<p>Step 1 From the Paper menu on the printer control panel, check the paper type and weight.</p> <p>Do the paper type and texture match the paper loaded in the tray?</p>	<p>Go to step 2.</p>	<p>Specify the paper type and weight from the tray settings to match the paper loaded in the tray.</p>
<p>Step 2 Check if you are printing on paper with texture or rough finishes.</p> <p>Are you printing on textured or rough paper?</p>	<p>From the Paper menu on the printer control panel, set the paper texture.</p>	<p>Contact customer support.</p>

Uneven print density

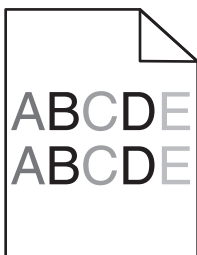

Action	Yes	No
<p>Replace the imaging unit, and then resend the print job.</p> <p>Is the print density uneven?</p>	<p>Contact customer support.</p>	<p>The problem is solved.</p>

Solving copy problems

- “Copier does not respond” on page 300

- “Scanner unit does not close” on page 300
- “Poor copy quality” on page 301
- “Partial document or photo copies” on page 302

Copier does not respond

Action	Yes	No
<p>Step 1 Check if an error or status message appears on the display.</p> <p>Does an error or status message appear?</p>	Clear the error or status message.	Go to step 2.
<p>Step 2 Check if the power cord is plugged into the printer and a properly grounded electrical outlet.</p> <p>Is the power cord plugged into the printer and a properly grounded electrical outlet?</p>	Go to step 3.	Connect the power cord to the printer and a properly grounded electrical outlet.
<p>Step 3 Turn off the printer, then wait for about 10 seconds, and then turn it back on.</p> <p>Did Performing Self Test and Ready appear?</p>	The problem is solved.	Contact customer support .

Scanner unit does not close

Action	Yes	No
<p>Check if there are no obstructions between the scanner unit and the printer.</p> <p>a Lift the scanner unit. b Remove any obstruction that keeps the scanner unit open. c Lower the scanner unit.</p> <p>Did the scanner unit close properly?</p>	The problem is solved.	Contact customer support .

Poor copy quality

Action	Yes	No
<p>Step 1 Check if an error or status message appears on the display.</p> <p>Does an error or status message appear?</p>	Clear the error or status message.	Go to step 2.
<p>Step 2 Check the quality of the original document.</p> <p>Is the quality of the original document satisfactory?</p>	Go to step 3.	Increase the scan resolution setting for a higher-quality output.
<p>Step 3 If dark marks appear on prints, then clean the scanner glass and the ADF glass using a clean, lint-free cloth dampened with water.</p> <p>Is the scanner glass clean?</p>	Go to step 4.	See “Cleaning the scanner glass” on page 221.
<p>Step 4 Send a print job, and then check for print quality problems.</p> <ul style="list-style-type: none"> a From the General Settings menu, adjust the Eco-Mode settings. b From the Copy menu, adjust the toner darkness. c If the print remains faded, then replace the toner cartridge. <p>Is the print quality satisfactory?</p>	Go to step 5.	See “Print quality problems” on page 281.
<p>Step 5 Check the placement of the document or photo.</p> <p>Make sure the document or photo is loaded facedown on the scanner glass in the upper left corner.</p> <p>Is the document or photo loaded correctly?</p>	Go to step 6.	Place the document or photo facedown on the scanner glass in the upper left corner.
<p>Step 6 Increase the scan resolution setting for a higher-quality output.</p> <p>Did the increased resolution produce a higher-quality output?</p>	The problem is solved.	Go to step 7.
<p>Step 7 Check the copy settings.</p> <p>From the Copy screen, check if the Content Type and Content Source settings are correct for the document being scanned.</p> <p>Are the Content Type and Content Source settings correct for the document being scanned?</p>	Go to step 8.	Change the Content Type and Content Source settings to match the document being scanned.

Action	Yes	No
<p>Step 8</p> <p>Check for patterns on print.</p> <p>a From the Copy screen, navigate to: Advanced Options > Advanced Imaging > Sharpness > select a lower setting</p> <p>b On the Copy screen, make sure no scaling is being selected.</p> <p>Do patterns appear on prints?</p>	Go to step 9.	The problem is solved.
<p>Step 9</p> <p>Check for missing or faded text on prints.</p> <p>a From the Copy screen, navigate to: Advanced Options > Advanced Imaging</p> <p>b Adjust the settings:</p> <ul style="list-style-type: none"> • Improve sharpness—Increase the sharpness setting. • Remove background—Reduce the current background removal setting. • Increase contrast—Increase the current setting. • Decrease shadow—Reduce the current setting. <p>Do prints have missing or faded text?</p>	Go to step 10.	The problem is solved.
<p>Step 10</p> <p>Check for washed-out or overexposed output.</p> <p>a From the Copy screen, navigate to: Advanced Options > Advanced Imaging</p> <p>b Adjust the settings of the following:</p> <ul style="list-style-type: none"> • Background removal—Reduce the current setting. • Shadow detail—Reduce the current background removal setting. <p>c Resend the copy job.</p> <p>Do pages show washed-out or overexposed prints?</p>	Contact customer support .	The problem is solved.

Partial document or photo copies

Action	Yes	No
<p>Step 1</p> <p>Check the placement of the document or photo.</p> <p>Make sure the document or photo is loaded facedown on the scanner glass in the upper left corner.</p> <p>Is the document or photo loaded correctly?</p>	Go to step 2.	Place the document or photo facedown on the scanner glass in the upper left corner.

Action	Yes	No
<p>Step 2</p> <p>Check if the paper size setting matches the size of the paper loaded in the tray.</p> <p>From the Paper menu on the printer control panel, check the Paper Size setting.</p> <p>Does the paper size setting match the size of the paper loaded in the tray.</p>	Go to step 3.	Change the paper size setting to match the paper loaded in the tray, or load the tray with paper that matches the paper size setting.
<p>Step 3</p> <p>a Specify the paper size. Depending on your operating system, specify the paper size in Printing Preferences or the Print dialog.</p> <p>b Resend the print job.</p> <p>Do copies print properly?</p>	The problem is solved.	Contact customer support .



Solving fax problems

- “Fax and e-mail functions are not set up” on page 303
- “Caller ID is not shown” on page 304
- “Cannot send or receive a fax” on page 304
- “Can send but not receive faxes” on page 306
- “Can receive but not send faxes” on page 307
- “Received fax has poor print quality” on page 308

Fax and e-mail functions are not set up

Notes:

- Before you troubleshoot, check if the fax cables are connected.
- The indicator light is blinking red until you set up fax and e-mail.

Action	Yes	No
<p>a From the home screen, navigate to:</p> <p> > Settings > General Settings > Run initial setup > Yes > Submit</p> <p>b Turn off the printer, and then turn it back on.</p> <p>The “Select your language” screen appears on the printer display.</p> <p>c Select a language, and then touch .</p> <p>d Select a country or region, and then touch Next.</p> <p>e Select a time zone, and then touch Next.</p> <p>f Select Fax and E-mail, and then touch Next.</p> <p>Are fax and e-mail functions set up?</p>	The problem is solved.	Contact customer support .

Caller ID is not shown

Action	Yes	No
<p>Contact your telephone company to check if your telephone line is subscribed to the caller ID service.</p> <p>Notes:</p> <ul style="list-style-type: none"> • If your region supports multiple caller ID patterns, then you may have to change the default setting. There are two settings available: FSK (pattern 1) and DTMF (pattern 2). • The availability of these settings in the Fax menu depends on whether your country or region supports multiple caller ID patterns. • Contact your telephone company to determine which pattern or switch setting to use. <p>Does the caller ID appear?</p>	<p>The problem is solved.</p>	<p>Contact customer support.</p>

Cannot send or receive a fax

Action	Yes	No
<p>Step 1</p> <p>Check if an error or status message appears on the display.</p> <p>Is there an error or status message on the display?</p>	<p>Clear the error or status message.</p>	<p>Go to step 2.</p>
<p>Step 2</p> <p>Check if the power cord is plugged into the printer and a properly grounded electrical outlet.</p> <p>Is the power cord plugged into the printer and a properly grounded electrical outlet?</p>	<p>Go to step 3.</p>	<p>Connect the power cord to the printer and a properly grounded electrical outlet.</p>
<p>Step 3</p> <p>Check the power.</p> <p>Check if the printer is plugged in and turned on, and if Ready appears on the display.</p> <p>Is the printer turned on, and does Ready appear on the display?</p>	<p>Go to step 4.</p>	<p>Turn on the printer, and then wait until Ready appears on the display.</p>
<p>Step 4</p> <p>Check the printer connections.</p> <p>If applicable, check if the cable connections for the following equipment are secure:</p> <ul style="list-style-type: none"> • Telephone • Handset • Answering machine <p>Are the cable connections secure?</p>	<p>Go to step 5.</p>	<p>Securely connect the cables.</p>

Action	Yes	No
<p>Step 5</p> <p>a Check the telephone wall jack.</p> <ol style="list-style-type: none"> 1 Plug the telephone cable into the wall jack. 2 Listen for a dial tone. 3 If you do not hear a dial tone, then plug a different telephone cable into the wall jack. 4 If you still do not hear a dial tone, then plug the telephone cable into a different wall jack. 5 If you hear a dial tone, then connect the printer to that wall jack. <p>b Try sending or receiving a fax.</p> <p>Can you send or receive a fax?</p>	<p>The problem is solved.</p>	<p>Go to step 6.</p>
<p>Step 6</p> <p>Check if the printer is connected to an analog phone service or the correct digital connector.</p> <p>The fax modem is an analog device. Certain devices can be connected to the printer so that digital telephone services can be used.</p> <ul style="list-style-type: none"> • If you are using an ISDN telephone service, then connect the printer to an analog telephone port (an R-interface port) on an ISDN terminal adapter. For more information and to request an R-interface port, contact your ISDN provider. • If you are using DSL, then connect to a DSL filter or router that will support analog use. For more information, contact your DSL provider. • If you are using a PBX telephone service, then make sure you are connecting to an analog connection on the PBX. If none exists, then consider installing an analog telephone line for the fax machine. <p>Is the printer connected to an analog phone service or the correct digital connector?</p>	<p>Go to step 7.</p>	<p>Connect the printer to an analog phone service or the correct digital connector.</p>
<p>Step 7</p> <p>Check for a dial tone.</p> <p>Did you hear a dial tone?</p>	<p>Go to step 8.</p>	<ul style="list-style-type: none"> • Try calling the fax number to make sure that it is working properly. • If the telephone line is being used by another device, then wait until the other device is finished before sending a fax. • If you are using the On Hook Dial feature, then turn up the volume to check if you hear a dial tone.

Action	Yes	No
<p>Step 8 Temporarily disconnect other equipment (such as answering machines, computers with modems, or telephone line splitters) between the printer and the telephone line, and then try sending or receiving a fax.</p> <p>Can you send or receive a fax?</p>	The problem is solved.	Go to step 9.
<p>Step 9 a Temporarily disable call waiting. Contact your telephone company to obtain the keypad sequence for temporarily disabling call waiting. b Try sending or receiving a fax.</p> <p>Can you send or receive a fax?</p>	The problem is solved.	Go to step 10.
<p>Step 10 a Temporarily disable voice mail service. For more information, contact your telephone company. Note: If you want to use both voice mail and the printer, then consider adding a second telephone line for the printer. b Try sending or receiving a fax.</p> <p>Can you send or receive a fax?</p>	The problem is solved.	Go to step 11.
<p>Step 11 Scan the original document one page at a time. a Dial the fax number. b Scan the document one page at a time.</p> <p>Can you send or receive a fax?</p>	The problem is solved.	Contact customer support .

Can send but not receive faxes

Action	Yes	No
<p>Step 1 Check the tray or feeder. If empty, then load paper in the tray or feeder.</p> <p>Can you receive faxes?</p>	The problem is solved.	Go to step 2.

Action	Yes	No
<p>Step 2 Check the ring count delay settings.</p> <p>a Open a Web browser, and then type the printer IP address in the address field.</p> <p>Notes:</p> <ul style="list-style-type: none"> View the printer IP address on the printer home screen. The IP address appears as four sets of numbers separated by periods, such as 123.123.123.123. If you are using a proxy server, then temporarily disable it to load the Web page correctly. <p>b Click Settings > Fax Settings > Analog Fax Setup.</p> <p>c In the “Rings to Answer” field, enter the number of times you want the phone to ring before the printer answers.</p> <p>d Click Submit.</p> <p>Can you receive faxes?</p>	<p>The problem is solved.</p>	<p>Go to step 3.</p>
<p>Step 3 Replace the toner cartridge. For more information, see the instruction sheet that came with the supply.</p> <p>Can you receive faxes?</p>	<p>The problem is solved.</p>	<p>Contact customer support.</p>

Can receive but not send faxes

Action	Yes	No
<p>Step 1 Check if the printer is in Fax mode.</p> <p>From the home screen, touch Fax to put the printer in Fax mode, and then send the fax.</p> <p>Note: The Multi Send application does not support the XPS output type. To use XPS, use the regular faxing method.</p> <p>Can you send faxes?</p>	<p>The problem is solved.</p>	<p>Go to step 2.</p>
<p>Step 2 Load the original document properly.</p> <p>Load the original document faceup, short edge first into the ADF tray or facedown on the scanner glass in the upper left corner.</p> <p>Note: Do not load postcards, photos, small items, transparencies, photo paper, or thin media (such as magazine clippings) into the ADF tray. Place these items on the scanner glass.</p> <p>Can you send faxes?</p>	<p>The problem is solved.</p>	<p>Go to step 3.</p>

Action	Yes	No
<p>Step 3 Set up the shortcut number properly.</p> <ul style="list-style-type: none"> • Check if the shortcut number has been set for the telephone number that you want to dial. • Dial the telephone number manually. <p>Can you send faxes?</p>	The problem is solved.	Contact customer support .

Received fax has poor print quality

Action	Yes	No
<p>Step 1 Ask the person who sent you the fax to:</p> <ol style="list-style-type: none"> Check if the quality of the original document is satisfactory. Increase the fax scan resolution, if possible. Resend the fax. <p>Is the fax print quality satisfactory?</p>	The problem is solved.	Go to step 2.
<p>Step 2 Decrease the incoming fax transmission speed.</p> <ol style="list-style-type: none"> Open a Web browser, and then type the printer IP address in the address field. <p>Notes:</p> <ul style="list-style-type: none"> • View the printer IP address on the printer home screen. The IP address appears as four sets of numbers separated by periods, such as 123.123.123.123. • If you are using a proxy server, then temporarily disable it to load the Web page correctly. • Print a network setup page or menu settings page, and then locate the IP address in the TCP/IP section. <ol style="list-style-type: none"> Click Settings > Fax Settings > Analog Fax Setup. In the Max Speed menu, click one of the following: <ul style="list-style-type: none"> • 2400 • 4800 • 9600 • 14400 • 33600 Click Submit, and then resend the fax. <p>Is the fax print quality satisfactory?</p>	The problem is solved.	Go to step 3.

Action	Yes	No
<p>Step 3 Replace the toner cartridge. When Cartridge low [88.xy] appears, replace the cartridge, and then resend the fax.</p> <p>Is the fax print quality satisfactory?</p>	<p>The problem is solved.</p>	<p>Contact customer support.</p>

Solving scanner problems

- “The scanner does not respond” on page 309
- “Scan job was not successful” on page 310
- “Scanner unit does not close” on page 311
- “Scanning takes too long or freezes the computer” on page 311
- “Poor scanned image quality” on page 312
- “Partial document or photo scans” on page 313
- “Cannot scan from a computer” on page 313

The scanner does not respond

Action	Yes	No
<p>Step 1 Check if the printer is turned on.</p> <p>Is the printer turned on?</p>	<p>Go to step 2.</p>	<p>Turn on the printer.</p>
<p>Step 2 Check if the printer cable is securely attached to the printer and the computer, print server, option, or other network device.</p> <p>Is the printer cable securely attached to the printer and the computer, print server, option, or other network device?</p>	<p>Go to step 3.</p>	<p>Connect the printer cable securely to the printer and the computer, print server, option, or other network device.</p>
<p>Step 3 Check if the power cord is plugged into the printer and a properly grounded electrical outlet.</p> <p>Is the power cord plugged into the printer and a properly grounded electrical outlet?</p>	<p>Go to step 4.</p>	<p>Connect the power cord to the printer and a properly grounded electrical outlet.</p>
<p>Step 4 Check if the electrical outlet is turned off by a switch or breaker.</p> <p>Is the electrical outlet turned off by a switch or breaker?</p>	<p>Turn on the switch or reset the breaker.</p>	<p>Go to step 5.</p>

Action	Yes	No
<p>Step 5 Check if the printer is plugged into any surge protectors, uninterruptible power supplies, or extension cords.</p> <p>Is the printer plugged into any surge protectors, uninterruptible power supplies, or extension cords?</p>	Connect the printer power cord directly to a properly grounded electrical outlet.	Go to step 6.
<p>Step 6 Check other electrical equipment plugged into the outlet.</p> <p>Are the other electrical equipment working?</p>	Unplug the other electrical equipment and turn on the printer. If the printer does not work, then reconnect the other electrical equipment and then go to step 6.	Go to step 7.
<p>Step 7 Turn off the printer, then wait for about 10 seconds, and then turn the printer back on.</p> <p>Are the printer and scanner working?</p>	The problem is solved.	Contact customer support .

Scan job was not successful

Action	Yes	No
<p>Step 1 Check the cable connections. Make sure the Ethernet or USB cable is securely connected to the computer and the printer.</p> <p>Are the cables securely connected?</p>	Go to step 2.	Connect the cables properly.
<p>Step 2 Check if the file name is already in use.</p> <p>Is the file name already in use?</p>	Change the file name.	Go to step 3.
<p>Step 3 Check if the document or photo you want to scan is open in another application or being used by another user.</p> <p>Is the file you want to scan open in another application or being used by another user?</p>	Close the file you are scanning.	Go to step 4.
<p>Step 4 Check if either the Append time stamp or the Overwrite existing file check box is selected in the destination configuration settings.</p> <p>Is the Append time stamp or Overwrite existing file check box selected in the destination configuration settings?</p>	Go to step 5.	Select the Append time stamp or Overwrite existing file check box in the destination configuration settings.

Action	Yes	No
<p>Step 5 From the Flash Drive menu, reduce the scan resolution settings, and then resend the scan job.</p> <p>Does the job scan?</p>	The problem is solved.	Go to step 6.
<p>Step 6 Check the scan settings. From the Scan screen, make sure the Content Type and Content Source settings are correct for the document being scanned.</p> <p>Are the Content Type and Content Source settings correct for the document being scanned?</p>	The problem is solved.	Change the Content Type and Content Source settings to match the document being scanned.

Scanner unit does not close

Action	Yes	No
<p>Check if there are obstructions in the scanner unit.</p> <ul style="list-style-type: none"> a Lift the scanner unit. b Remove any obstruction keeping the scanner unit open. c Lower the scanner unit. <p>Did the scanner unit close correctly?</p>	The problem is solved.	Contact customer support .

Scanning takes too long or freezes the computer

Action	Yes	No
<p>Step 1 Check if other applications are interfering with the scan. Close all applications that are not being used.</p> <p>Does scanning still take too long or freeze the computer?</p>	Go to step 2.	The problem is solved.
<p>Step 2 Select a lower scan resolution.</p> <p>Does scanning still take too long or freeze the computer?</p>	Contact customer support .	The problem is solved.

Poor scanned image quality

Action	Yes	No
<p>Step 1 Check if an error message appears on the display.</p> <p>Is there an error message on the printer display?</p>	Clear the error message.	Go to step 2.
<p>Step 2 Check the quality of the original document.</p> <p>Is the quality of the original document satisfactory?</p>	Go to step 3.	Increase the scan resolution settings for a higher-quality output.
<p>Step 3 Clean the scanner glass and the ADF glass using a clean, lint-free cloth dampened with water.</p> <p>Is the scanner glass clean?</p>	Go to step 4.	See “Cleaning the scanner glass” on page 221.
<p>Step 4 Check the placement of the document or photo. Make sure the document or photo is loaded facedown on the scanner glass in the upper left corner.</p> <p>Is the document or photo loaded correctly?</p>	Go to step 5.	Place the document or photo facedown on the scanner glass in the upper left corner.
<p>Step 5 Send a print job, and then check for print quality problems.</p> <ul style="list-style-type: none"> • From the General Settings menu, adjust the Eco-Mode settings. • From the Copy menu, adjust the toner darkness. • When the print becomes faded, replace the toner cartridge. <p>Is the print quality satisfactory?</p>	Go to step 6.	See “Print quality problems” on page 281.
<p>Step 6 Increase the scan resolution settings for a higher-quality output.</p> <p>Did the increased resolution produce a higher-quality output?</p>	Problem solved.	Go to step 7.
<p>Step 7 Check the scan settings. From the Scan screen, make sure the Content Type and Content Source settings are correct for the document being scanned.</p> <p>Are the Content Type and Content Source settings correct for the document being scanned?</p>	Contact customer support .	Change the Content Type and Content Source settings to match the document being scanned.

Partial document or photo scans

Action	Yes	No
<p>Check the placement of the document or photo. Make sure the document or photo is loaded facedown on the scanner glass in the upper left corner.</p> <p>Is the document or photo loaded correctly?</p>	<p>Contact customer support.</p>	<p>Load the document or photo facedown on the scanner glass in the upper left corner.</p>

Cannot scan from a computer

Action	Yes	No
<p>Step 1 Make sure the printer is turned on and that Ready appears on the printer display before scanning a job.</p> <p>Does Ready appear before scanning the job?</p>	<p>Go to step 3.</p>	<p>Go to step 2.</p>
<p>Step 2 Turn off the printer, then wait for about 10 seconds, and then turn the printer back on.</p> <p>Is there an error message on the printer display?</p>	<p>Clear the error message.</p>	<p>Go to step 3.</p>
<p>Step 3 Check the cable connections between the printer and the print server to make sure they are secure. For more information, see the setup documentation that came with the printer.</p> <p>Are the cable connections between the printer and the print server secure?</p>	<p>Contact customer support.</p>	<p>Tighten the cable connections.</p>

Solving home screen applications problems

An application error has occurred

Action	Yes	No
<p>Step 1 Check the system log for relevant details.</p> <p>a Open a Web browser, and then type the printer IP address in the address field.</p> <p>If you do not know the IP address of the printer, then you can:</p> <ul style="list-style-type: none"> • View the IP address on the printer home screen. • Print a network setup page or the menu settings pages, and then locate the IP address in the TCP/IP section. <p>Note: An IP address appears as four sets of numbers separated by periods, such as 123.123.123.123.</p> <p>b Click Settings > Apps > Apps Management > System tab > Log.</p> <p>c From the Filter menu, select an application status.</p> <p>d From the Application menu, select an application, and then click Submit.</p> <p>Does an error message appear in the log?</p>	Go to step 2.	Contact customer support .
<p>Step 2 Resolve the error.</p> <p>Is the application working now?</p>	The problem is solved.	Contact customer support .

Embedded Web Server does not open

Action	Yes	No
<p>Step 1 Make sure the printer IP address is correct.</p> <p>View the printer IP address:</p> <ul style="list-style-type: none"> • From the printer home screen • From the TCP/IP section in the Network/Ports menu • By printing a network setup page or menu settings page, and then finding the TCP/IP section <p>Note: An IP address appears as four sets of numbers separated by periods, such as 123.123.123.123.</p> <p>Is the printer IP address correct?</p>	Go to step 2.	Type the correct printer IP address in the address field of your Web browser. <p>Note: Depending on the network settings, you may need to type “https://” instead of “http://” before the printer IP address to access the Embedded Web Server.</p>
<p>Step 2 Check if the printer is turned on.</p> <p>Is the printer turned on?</p>	Go to step 3.	Turn on the printer.

Action	Yes	No
<p>Step 3 Check if the network connection is working.</p> <p>Is the network connection working?</p>	Go to step 4.	Contact your system support person.
<p>Step 4 Make sure the cable connections to the printer and print server are secure. For more information, see the setup documentation that came with the printer.</p> <p>Are the cable connections to the printer and print server secure?</p>	Go to step 5.	Tighten the cable connection.
<p>Step 5 Temporarily disable the Web proxy servers.</p> <p>Note: Proxy servers may block or restrict you from accessing certain Web sites including the Embedded Web Server.</p> <p>Are the Web proxy servers disabled?</p>	Go to step 6.	Contact your system support person.
<p>Step 6 Access the Embedded Web Server again by typing the correct IP address in the address field.</p> <p>Did the Embedded Web Server open?</p>	The problem is solved.	Contact customer support .

Contacting customer support

When you contact customer support, you will need to be able to describe the problem you are experiencing, the message on the printer display, and the troubleshooting steps you have already taken to find a solution.

You need to know your printer model type and serial number. For more information, see the label at the back of the printer. The serial number is also listed on the menu settings page.

Lexmark has various ways to help you solve your printing problem. Visit the Lexmark Web site at <http://support.lexmark.com>, and then select one of the following:

Tech Library	You can browse our library of manuals, support documentation, drivers, and other downloads to help you solve common problems.
E-mail	You can send an e-mail to the Lexmark team, describing your problem. A service representative will respond and provide you with information to solve your problem.
Live chat	You can chat directly with a service representative. They can work with you to solve your printer problem or provide assistance through Assisted Service where the service representative can remotely connect to your computer through the Internet to troubleshoot problems, install updates, or complete other tasks to help you successfully use your Lexmark product.

Telephone support is also available. In the U.S. or Canada, call 1-800-539-6275. For other countries or regions, visit <http://support.lexmark.com>.

Notices

Product information

Product name:

Lexmark MX610de, MX611de, and MX611dhe

Machine type:

7016

Model(s):

630, 670, 675

Edition notice

May 2013

The following paragraph does not apply to any country where such provisions are inconsistent with local law:

LEXMARK INTERNATIONAL, INC., PROVIDES THIS PUBLICATION "AS IS" WITHOUT WARRANTY OF ANY KIND, EITHER EXPRESS OR IMPLIED, INCLUDING, BUT NOT LIMITED TO, THE IMPLIED WARRANTIES OF MERCHANTABILITY OR FITNESS FOR A PARTICULAR PURPOSE. Some states do not allow disclaimer of express or implied warranties in certain transactions; therefore, this statement may not apply to you.

This publication could include technical inaccuracies or typographical errors. Changes are periodically made to the information herein; these changes will be incorporated in later editions. Improvements or changes in the products or the programs described may be made at any time.

References in this publication to products, programs, or services do not imply that the manufacturer intends to make these available in all countries in which it operates. Any reference to a product, program, or service is not intended to state or imply that only that product, program, or service may be used. Any functionally equivalent product, program, or service that does not infringe any existing intellectual property right may be used instead. Evaluation and verification of operation in conjunction with other products, programs, or services, except those expressly designated by the manufacturer, are the user's responsibility.

For Lexmark technical support, visit <http://support.lexmark.com>.

For information on supplies and downloads, visit www.lexmark.com.

© 2013 Lexmark International, Inc.

All rights reserved.

GOVERNMENT END USERS

The Software Program and any related documentation are "Commercial Items," as that term is defined in 48 C.F.R. 2.101, "Computer Software" and "Commercial Computer Software Documentation," as such terms are used in 48 C.F.R. 12.212 or 48 C.F.R. 227.7202, as applicable. Consistent with 48 C.F.R. 12.212 or 48 C.F.R. 227.7202-1 through 227.7202-4, as applicable, the Commercial Computer Software and Commercial Software Documentation are licensed to the U.S. Government end users (a) only as Commercial Items and (b) with only those rights as are granted to all other end users pursuant to the terms and conditions herein.

Trademarks

Lexmark, Lexmark with diamond design, and MarkVision are trademarks of Lexmark International, Inc., registered in the United States and/or other countries.

Mac and the Mac logo are trademarks of Apple Inc., registered in the U.S. and other countries.

PCL® is a registered trademark of the Hewlett-Packard Company. PCL is Hewlett-Packard Company's designation of a set of printer commands (language) and functions included in its printer products. This printer is intended to be compatible with the PCL language. This means the printer recognizes PCL commands used in various application programs, and that the printer emulates the functions corresponding to the commands.

All other trademarks are the property of their respective owners.

AirPrint and the AirPrint logo are trademarks of Apple, Inc.

Federal Communications Commission (FCC) compliance information statement

This product has been tested and found to comply with the limits for a Class B digital device, pursuant to Part 15 of the FCC Rules. Operation is subject to the following two conditions: (1) this device may not cause harmful interference, and (2) this device must accept any interference received, including interference that may cause undesired operation.

The FCC Class B limits are designed to provide reasonable protection against harmful interference when the equipment is operated in a residential installation. This equipment generates, uses, and can radiate radio frequency energy and, if not installed and used in accordance with the instructions, may cause harmful interference to radio communications. However, there is no guarantee that interference will not occur in a particular installation. If this equipment does cause harmful interference to radio or television reception, which can be determined by turning the equipment off and on, the user is encouraged to try to correct the interference by one or more of the following measures:

- Reorient or relocate the receiving antenna.
- Increase the separation between the equipment and receiver.
- Connect the equipment into an outlet on a circuit different from that to which the receiver is connected.
- Consult your point of purchase or service representative for additional suggestions.

The manufacturer is not responsible for radio or television interference caused by using other than recommended cables or by unauthorized changes or modifications to this equipment. Unauthorized changes or modifications could void the user's authority to operate this equipment.

Note: To assure compliance with FCC regulations on electromagnetic interference for a Class B computing device, use a properly shielded and grounded cable such as Lexmark part number 1021231 for parallel attach or 1021294 for USB attach. Use of a substitute cable not properly shielded and grounded may result in a violation of FCC regulations.

Any questions regarding this compliance information statement should be directed to:

Director of Lexmark Technology & Services
Lexmark International, Inc.
740 West New Circle Road
Lexington, KY 40550
(859) 232-3000

Noise emission levels

The following measurements were made in accordance with ISO 7779 and reported in conformance with ISO 9296.

Note: Some modes may not apply to your product.

1-meter average sound pressure, dBA	
Printing	55 dBA
Scanning	45 dBA
Copying	56 dBA
Ready	N/A dBA

Values are subject to change. See www.lexmark.com for current values.

Temperature information

Ambient operating temperature	15.6 to 32.2°C (60 to 90°F)
Shipping temperature	-40 to 43.3°C (-40 to 110°F)
Storage temperature and relative humidity	1 to 35°C (34 to 95°F) 8 to 80% RH

Waste from Electrical and Electronic Equipment (WEEE) directive



The WEEE logo signifies specific recycling programs and procedures for electronic products in countries of the European Union. We encourage the recycling of our products.

If you have further questions about recycling options, visit the Lexmark Web site at www.lexmark.com for your local sales office phone number.

Product disposal

Do not dispose of the printer or supplies in the same manner as normal household waste. Consult your local authorities for disposal and recycling options.

Static sensitivity notice



This symbol identifies static-sensitive parts. Do not touch in the areas near these symbols without first touching the metal frame of the printer.

ENERGY STAR

Any Lexmark product bearing the ENERGY STAR emblem on the product or on a start-up screen is certified to comply with Environmental Protection Agency (EPA) ENERGY STAR requirements as configured when shipped by Lexmark.



Laser notice

The printer is certified in the U.S. to conform to the requirements of DHHS 21 CFR, Chapter I, Subchapter J for Class I (1) laser products, and elsewhere is certified as a Class I laser product conforming to the requirements of IEC 60825-1.

Class I laser products are not considered to be hazardous. The printer contains internally a Class IIIb (3b) laser that is nominally a 7 milliwatt gallium arsenide laser operating in the wavelength of 655-675 nanometers. The laser system and printer are designed so there is never any human access to laser radiation above a Class I level during normal operation, user maintenance, or prescribed service condition.

Laser advisory label

A laser notice label may be affixed to this printer as shown:

DANGER - Invisible laser radiation when cartridges are removed and interlock defeated. Avoid exposure to laser beam.

PERIGO - Radiação a laser invisível será liberada se os cartuchos forem removidos e o lacre rompido. Evite a exposição aos feixes de laser.

Opasnost - Nevidljivo lasersko zračenje kada su kasete uklonjene i poništena sigurnosna veza. Izbjegavati izlaganje zracima.

NEBEZPEČÍ - Když jsou vyjmuty kazety a je odblokována pojistka, ze zařízení je vysíláno neviditelné laserové záření. Nevystavujte se působení laserového paprsku.

FARE - Usynlig laserstråling, når patroner fjernes, og spærreanordningen er slået fra. Undgå at blive udsat for laserstrålen.

GEVAAR - Onzichtbare laserstraling wanneer cartridges worden verwijderd en een vergrendeling wordt genegeerd. Voorkom blootstelling aan de laser.

DANGER - Rayonnements laser invisibles lors du retrait des cartouches et du déverrouillage des loquets. Eviter toute exposition au rayon laser.

VAARA - Näkymätöntä lasersäteilyä on varottava, kun värikasetit on poistettu ja lukitus on auki. Vältä lasersäteelle altistumista.

GEFAHR - Unsichtbare Laserstrahlung beim Herausnehmen von Druckkassetten und offener Sicherheitssperre. Laserstrahl meiden.

ΚΙΝΔΥΝΟΣ - Εκκυσση αόρατης ακτινοβολίας laser κατά την αφαίρεση των κασετών και την απασφάλιση της μανδάλωσης. Αποφεύγετε την έκθεση στην ακτινοβολία laser.

VESZÉLY - Nem látható lézersugárzás fordulhat elő a patronok eltávolításakor és a zárószekerek felbontásakor. Kerülje a lézersugárnak való kitettséget.

PERICOLO - Emissioni di radiazioni laser invisibili durante la rimozione delle cartucce e del blocco. Evitare l'esposizione al raggio laser.

FARE - Usynlig laserstråling når kassetene tas ut og sperren er satt ut av spill. Unngå eksponering for laserstrålen.

NIEBEZPIECZEŃSTWO - niewidzialne promieniowanie laserowe podczas usuwania kaset i blokady. Należy unikać naświetlenia promieniami lasera.

ОПАСНО! Невидимое лазерное излучение при извлеченных картриджах и снятии блокировки. Избегайте воздействия лазерных лучей.

Pozor - Nebezpečenstvo neviditeľného laserového žiarenia pri odobratých kazetách a odblokovanej poistke. Nevystavujte sa lúčom.

PELIGRO: Se producen radiaciones láser invisibles al extraer los cartuchos con el interbloqueo desactivado. Evite la exposición al haz de láser.

FARA - Osynlig laserstrålning när patroner tas ur och spärrmekanismen är upphävd. Undvik exponering för laserstrålen.

危険 - 当移除碳粉盒及互锁失效时会产生看不见的激光辐射, 请避免暴露在激光光束下。

危険 - 移除碳粉匣與安全連續開關失效時會產生看不見的雷射輻射。請避免暴露在雷射光束下。

危険 - カートリッジが取り外され、内部ロックが無効になると、見えないレーザー光が放射されます。このレーザー光に当たらないようにしてください。

Power consumption

Product power consumption

The following table documents the power consumption characteristics of the product.

Note: Some modes may not apply to your product.

Mode	Description	Power consumption (Watts)
Printing	The product is generating hard-copy output from electronic inputs.	640 W
Copy	The product is generating hard-copy output from hard-copy original documents.	660 W
Scan	The product is scanning hard-copy documents.	40 W
Ready	The product is waiting for a print job.	20 W
Sleep Mode	The product is in a high-level energy-saving mode.	7 W
Hibernate	The product is in a low-level energy-saving mode.	0.5 W
Off	The product is plugged into an electrical outlet, but the power switch is turned off.	0 W

The power consumption levels listed in the previous table represent time-averaged measurements. Instantaneous power draws may be substantially higher than the average.

Values are subject to change. See www.lexmark.com for current values.

Sleep Mode

This product is designed with an energy-saving mode called *Sleep Mode*. The Sleep Mode saves energy by lowering power consumption during extended periods of inactivity. The Sleep Mode is automatically engaged after this product is not used for a specified period of time, called the *Sleep Mode Timeout*.

Factory default Sleep Mode Timeout for this product (in minutes):	30 minutes
---	------------

By using the configuration menus, the Sleep Mode Timeout can be modified between 1 minute and 180 minutes. Setting the Sleep Mode Timeout to a low value reduces energy consumption, but may increase the response time of the product. Setting the Sleep Mode Timeout to a high value maintains a fast response, but uses more energy.

Hibernate Mode

This product is designed with an ultra-low power operating mode called *Hibernate mode*. When operating in Hibernate Mode, all other systems and devices are powered down safely.

The Hibernate mode can be entered in any of the following methods:

- Using the Hibernate Timeout
- Using the Schedule Power modes
- Using the Sleep/Hibernate button

Factory default Hibernate Timeout for this product in all countries or regions except for EU countries and Switzerland	Disabled
Factory default value for this product in EU countries or regions and Switzerland	3 days

The amount of time the printer waits after a job is printed before it enters Hibernate mode can be modified between one hour and one month.

Off mode

If this product has an off mode which still consumes a small amount of power, then to completely stop product power consumption, disconnect the power supply cord from the electrical outlet.

Total energy usage

It is sometimes helpful to calculate the total product energy usage. Since power consumption claims are provided in power units of Watts, the power consumption should be multiplied by the time the product spends in each mode in order to calculate energy usage. The total product energy usage is the sum of each mode's energy usage.

Industry Canada compliance statement

This Class B digital apparatus meets all requirements of the Canadian Interference-Causing Equipment Standard ICES-003.

Avis de conformité aux normes de l'industrie du Canada

Cet appareil numérique de classe B est conforme aux exigences de la norme canadienne relative aux équipements pouvant causer des interférences NMB-003.

Licensing notices

All licensing notices associated with this product can be viewed from the root directory of the installation software CD.

日本の VCCI 規定

製品にこのマークが表示されている場合、次の要件を満たしています。



この装置は、クラス B 情報技術装置です。この装置は、家庭環境で使用することを目的としていますが、この装置がラジオやテレビジョン受信機に近接して使用されると、受信障害を引き起こすことがあります。

取扱説明書に従って正しい取り扱いをしてください。

VCCI-B

European Community (EC) directives conformity

This product is in conformity with the protection requirements of EC Council directives 2004/108/EC, 2006/95/EC and 2009/125/EC on the approximation and harmonization of the laws of the Member States relating to electromagnetic compatibility, safety of electrical equipment designed for use within certain voltage limits and the ecodesign of energy-related products.

The manufacturer of this product is: Lexmark International, Inc., 740 West New Circle Road, Lexington, KY, 40550 USA. The authorized representative is: Lexmark International Technology Hungária Kft., 8 Lechner Ödön fasor, Millennium Tower III, 1095 Budapest HUNGARY, A declaration of conformity to the requirements of the Directives is available upon request from the Authorized Representative.

This product satisfies the Class B limits of EN 55022 and safety requirements of EN 60950.

Regulatory notices for telecommunication terminal equipment

This section contains regulatory information pertaining to products that contain telecommunication terminal equipment such as facsimile.

Notice to users of the US telephone network: FCC requirements

This equipment complies with Part 68 of the FCC rules and the requirements adopted by the Administrative Council for Terminal Attachments (ACTA). On the back of this equipment is a label that contains, among other information, a product identifier in the format US:AAAEQ##TXXXX. If requested, this number must be provided to your telephone company.

This equipment uses the RJ-11C Universal Service Order Code (USOC) jack.

A plug and jack used to connect this equipment to the premises' wiring and telephone network must comply with the applicable FCC Part 68 rules and requirements adopted by the ACTA. A compliant telephone cord and modular plug is provided with this product. It is designed to be connected to a compatible modular jack that is also compliant. See your setup documentation for more information.

The Ringer Equivalence Number (REN) is used to determine the number of devices that may be connected to a telephone line. Excessive RENs on a telephone line may result in the devices not ringing in response to an incoming call. In most but not all areas, the sum of RENs should not exceed five (5.0). To be certain of the number of devices that may be connected to a line, as determined by the total RENs, contact your local telephone company. For products approved after July 23, 2001, the REN for this product is part of the product identifier that has the format US:AAAEQ##TXXXX. The digits represented by ## are the REN without a decimal point (for example, 03 is a REN of 0.3). For earlier products, the REN is shown separately on the label.

If this equipment causes harm to the telephone network, the telephone company will notify you in advance that temporary discontinuance of service may be required. If advance notice is not practical, the telephone company will notify the customer as soon as possible. You will also be advised of your right to file a complaint with the FCC.

The telephone company may make changes in its facilities, equipment, operations or procedures that could affect the operation of this equipment. If this happens, the telephone company will provide advance notice in order for you to make necessary modifications to maintain uninterrupted service.

If you experience trouble with this equipment, for repair or warranty information, contact Lexmark International, Inc. at www.lexmark.com or your Lexmark representative. If the equipment is causing harm to the telephone network, the telephone company may request that you disconnect the equipment until the problem is resolved.

This equipment contains no user serviceable parts. For repair and warranty information, contact Lexmark International, Inc. See the previous paragraph for contact information.

Connection to party line service is subject to state tariffs. Contact the state public utility commission, public service commission, or corporation commission for information.

If your home has specially wired alarm equipment connected to the telephone line, ensure the installation of this equipment does not disable your alarm equipment. If you have questions about what will disable alarm equipment, consult your telephone company or a qualified installer.

Telephone companies report that electrical surges, typically lightning transients, are very destructive to customer terminal equipment connected to AC power sources. This has been identified as a major nationwide problem. It is recommended that the customer install an appropriate AC surge arrester in the AC outlet to which this device is connected. An appropriate AC surge arrester is defined as one that is suitably rated, and certified by UL (Underwriter's Laboratories), another NRTL (Nationally Recognized Testing Laboratory), or a recognized safety certification body in the country/region of use. This is to avoid damage to the equipment caused by local lightning strikes and other electrical surges.

The Telephone Consumer Protection Act of 1991 makes it unlawful for any person to use a computer or other electronic device, including fax machines, to send any message unless said message clearly contains in a margin at the top or bottom of each transmitted page or on the first page of the transmission, the date and time it is sent and an identification of the business or other entity, or other individual sending the message, and the telephone number of the sending machine or such business, other entity, or individual. (The telephone number provided may not be a 900 number or any other number for which charges exceed local or long-distance transmission charges.)

See your user documentation in order to program this information into your fax machine.

Notice to users of the Canadian telephone network

This product meets the applicable Industry Canada technical specifications. The Ringer Equivalence Number (REN) is an indication of the maximum number of terminals allowed to be connected to a telephone interface. The terminus of an interface may consist of any combination of devices, subject only to the requirement that the sum of the RENs of all the devices does not exceed five. The modem REN is located on the rear of the equipment on the product labeling.

Telephone companies report that electrical surges, typically lightning transients, are very destructive to customer terminal equipment connected to AC power sources. This has been identified as a major nationwide problem. It is

recommended that the customer install an appropriate AC surge arrestor in the AC outlet to which this device is connected. An appropriate AC surge arrestor is defined as one that is suitably rated, and certified by UL (Underwriter's Laboratories), another NRTL (Nationally Recognized Testing Laboratory), or a recognized safety certification body in the country/region of use. This is to avoid damage to the equipment caused by local lightning strikes and other electrical surges.

This equipment uses CA11A telephone jacks.

Avis réservé aux utilisateurs du réseau téléphonique du Canada

Ce produit est conforme aux spécifications techniques d'Industrie Canada. Le numéro REN (ringer equivalence number : numéro d'équivalence de sonnerie) fournit une indication du nombre maximum de terminaux pouvant être connectés à l'interface téléphonique. En bout de ligne, le nombre d'appareils qui peuvent être connectés n'est pas directement limité, mais la somme des REN de ces appareils ne doit pas dépasser cinq. Le numéro REN du modem est indiqué sur l'étiquette produit située à l'arrière de l'équipement.

Les compagnies de téléphone constatent que les surtensions électriques, en particulier celles dues à la foudre, entraînent d'importants dégâts sur les terminaux privés connectés à des sources d'alimentation CA. Il s'agit-là d'un problème majeur d'échelle nationale. En conséquence, il vous est recommandé de brancher un parasurtenseur dans la prise de courant à laquelle l'équipement est connecté. Utilisez un parasurtenseur répondant à des caractéristiques nominales satisfaisantes et certifié par le laboratoire d'assureurs UL (Underwriter's Laboratories), un autre laboratoire agréé de type NRTL (Nationally Recognized Testing Laboratory) ou un organisme de certification agréé dans votre région ou pays. Ceci prévient tout endommagement de l'équipement causé par les orages et autres surtensions électriques.

Cet équipement utilise des prises de téléphone CA11A.

Notice to users of the New Zealand telephone network

The following are special conditions for the Facsimile User Instructions. The grant of a telepermit for any item of terminal equipment indicates only that Telecom has accepted that the item complies with minimum conditions for connection to its network. It indicates no endorsement of the product by Telecom, nor does it provide any sort of warranty. Above all, it provides no assurance that any item will work correctly in all respects with another item of telepermitted equipment of a different make or model, nor does it imply that any product is compatible with all of Telecom's network services.

This equipment shall not be set up to make automatic calls to the Telecom's 111 Emergency Service.

This equipment may not provide for the effective hand-over of a call to another device connected to the same line.

This equipment should not be used under any circumstances that may constitute a nuisance to other Telecom customers.

Some parameters required for compliance with Telecom's telepermit requirements are dependent on the equipment associated with this device. The associated equipment shall be set to operate within the following limits for compliance to Telecom's specifications:

- There shall be no more than 10 call attempts to the same number within any 30 minute period for any single manual call initiation, and
- The equipment shall go on-hook for a period of not less than 30 seconds between the end of one attempt and the beginning of the next call attempt.
- The equipment shall be set to ensure that automatic calls to different numbers are spaced such that there is not less than 5 seconds between the end of one call attempt and the beginning of another.

Japanese telecom notice

The installed optional modem is in compliance with Japanese Telecommunication Law and has been Certified by JATE, with Certification Number A11-0160001.

	Lexmark International, Inc.
	LEX-M03-002
	A11-0160001JP

Using this product in Switzerland

This product requires a Swiss billing tone filter (Lexmark part number 80D1877) to be installed on any line which receives metering pulses in Switzerland. The filter must be used, as metering pulses are present on all analog telephone lines in Switzerland.

Utilisation de ce produit en Suisse

Cet appareil nécessite l'utilisation d'un filtre de tonalité de facturation suisse (n° de référence Lexmark : 80D1877) devant être installé sur toute ligne recevant des impulsions de comptage en Suisse. Ce filtre doit être utilisé pour toute installation car ces impulsions existent sur toutes les lignes téléphoniques suisses.

Verwendung dieses Produkts in der Schweiz

Für dieses Produkt muss ein schweizerischer Billing Tone Filter zur Zählzeichenübertragung (Lexmark Teilenummer 80D1877) für jede Leitung installiert werden, über die in der Schweiz Zeitsteuertakte übertragen werden. Die Verwendung des Filters ist obligatorisch, da in allen analogen Telefonleitungen in der Schweiz Zeitsteuertakte vorhanden sind.

Uso del prodotto in Svizzera

Questo prodotto richiede un filtro toni Billing svizzero, (codice Lexmark 80D1877) da installare su tutte le linee che ricevono impulsi remoti in Svizzera. È necessario utilizzare il filtro poiché gli impulsi remoti sono presenti su tutte le linee analogiche in Svizzera.

Notice to Users in the European Union

Products bearing the CE mark are in conformity with the protection requirements of EC Council directives 2004/108/EC, 2006/95/EC, 1999/5/EC, and 2009/125/EC on the approximation and harmonization of the laws of the Member States relating to electromagnetic compatibility, safety of electrical equipment designed for use within certain voltage limits, radio equipment and telecommunications terminal equipment and on the ecodesign of energy-related products.

Compliance is indicated by the CE marking.



The manufacturer of this product is: Lexmark International, Inc., 740 West New Circle Road, Lexington, KY, 40550 USA. The authorized representative is: Lexmark International Technology Hungária Kft., 8 Lechner Ödön fasor, Millennium Tower III, 1095 Budapest HUNGARY, A declaration of conformity to the requirements of the Directives is available upon request from the Authorized Representative.

This product satisfies the Class B limits of EN 55022 and safety requirements of EN 60950.

Refer to the table at the end of the Notices section for further compliance information.

Regulatory notices for wireless products

This section contains the following regulatory information pertaining to wireless products that contain transmitters, for example, but not limited to, wireless network cards or proximity card readers.

Modular component notice

Wireless-equipped models contain the following modular component(s):

Lexmark Regulatory Type Model Number LEX-M01-005; FCC ID:IYLLEXM01005; IC:2376A-M01005

Exposure to radio frequency radiation

The radiated output power of this device is far below the radio frequency exposure limits of the FCC and other regulatory agencies. A minimum separation of 20 cm (8 inches) must be maintained between the antenna and any persons for this device to satisfy the RF exposure requirements of the FCC and other regulatory agencies.

Notice to users in Brazil

Este equipamento opera em caráter secundário, isto é, não tem direito a proteção contra interferência prejudicial, mesmo de estações do mesmo tipo, e não pode causar interferência a sistemas operando em caráter primário. (Res. ANATEL 282/2001).

Industry Canada (Canada)

This device complies with Industry Canada specification RSS-210. Operation is subject to the following two conditions: (1) this device may not cause interference, and (2) this device must accept any interference, including interference that may cause undesired operation of the device.

This device has been designed to operate only with the antenna provided. Use of any other antenna is strictly prohibited per regulations of Industry Canada.

To prevent radio interference to the licensed service, this device is intended to be operated indoors and away from windows to provide maximum shielding. Equipment (or its transmit antenna) that is installed outdoors is subject to licensing.

The installer of this radio equipment must ensure that the antenna is located or pointed such that it does not emit RF fields in excess of Health Canada limits for the general population; consult Safety Code 6, obtainable from Health Canada's Web site www.hc-sc.gc.ca/rpb.

The term "IC:" before the certification/registration number only signifies that the Industry Canada technical specifications were met.

Industry Canada (Canada)

Cet appareil est conforme à la norme RSS-210 d'Industry Canada. Son fonctionnement est soumis aux deux conditions suivantes :

(1) cet appareil ne doit pas provoquer d'interférences et (2) il doit accepter toute interférence reçue, y compris celles risquant d'altérer son fonctionnement.

Cet appareil a été conçu pour fonctionner uniquement avec l'antenne fournie. L'utilisation de toute autre antenne est strictement interdite par la réglementation d'Industry Canada.

En application des réglementations d'Industry Canada, l'utilisation d'une antenne de gain supérieur est strictement interdite.

Pour empêcher toute interférence radio au service faisant l'objet d'une licence, cet appareil doit être utilisé à l'intérieur et loin des fenêtres afin de garantir une protection optimale.

Si le matériel (ou son antenne d'émission) est installé à l'extérieur, il doit faire l'objet d'une licence.

L'installateur de cet équipement radio doit veiller à ce que l'antenne soit implantée et dirigée de manière à n'émettre aucun champ HF dépassant les limites fixées pour l'ensemble de la population par Santé Canada. Reportez-vous au Code de sécurité 6 que vous pouvez consulter sur le site Web de Santé Canada www.hc-sc.gc.ca/rpb.

Le terme « IC » précédant le numéro de d'accréditation/inscription signifie simplement que le produit est conforme aux spécifications techniques d'Industry Canada.

Taiwan NCC RF notice statement

NCC型式認證設備注意事項 台灣低功率射頻電機設備之使用注意事項

經型式認證合格之低功率射頻電機，非經許可，公司、商號或使用者均不得擅自變更頻率、加大功率或變更原設計之特性及功能。

低功率射頻電機之使用不得影響飛航安全及干擾合法通信；經發現有干擾現象時，應立即停用，並改善至無干擾時方得繼續使用。前項合法通信，指依電信規定作業之無線電信。低功率射頻電機須忍受合法通信或工業、科學及醫療用電波輻射性電機設備之干擾。

Notice to users in the European Union

This product is in conformity with the protection requirements of EC Council directives 2004/108/EC, 2006/95/EC, 1999/5/EC, and 2009/125/EC on the approximation and harmonization of the laws of the Member States relating to electromagnetic compatibility, safety of electrical equipment designed for use within certain voltage limits, radio equipment and telecommunications terminal equipment and on the ecodesign of energy-related products.

Compliance is indicated by the CE marking.



The manufacturer of this product is: Lexmark International, Inc., 740 West New Circle Road, Lexington, KY, 40550 USA. The authorized representative is: Lexmark International Technology Hungária Kft., 8 Lechner Ödön fasor, Millennium Tower III, 1095 Budapest HUNGARY, A declaration of conformity to the requirements of the Directives is available upon request from the Authorized Representative.

This product satisfies the Class B limits of EN 55022 and safety requirements of EN 60950.

Products equipped with 2.4GHz Wireless LAN option are in conformity with the protection requirements of EC Council directives 2004/108/EC, 2006/95/EC, 1999/5/EC, and 2009/125/EC on the approximation and harmonization of the laws of the Member States relating to electromagnetic compatibility, safety of electrical equipment designed for use within certain voltage limits and on radio equipment and telecommunications terminal equipment and on the ecodesign of energy-related products.

Compliance is indicated by the CE marking.



Operation is allowed in all EU and EFTA countries, but is restricted to indoor use only.

The manufacturer of this product is: Lexmark International, Inc., 740 West New Circle Road, Lexington, KY, 40550 USA. The authorized representative is: Lexmark International Technology Hungária Kft., 8 Lechner Ödön fasor, Millennium Tower III, 1095 Budapest HUNGARY, A declaration of conformity to the requirements of the Directives is available upon request from the Authorized Representative.

This product may be used in the countries indicated in the table below.

AT	BE	BG	CH	CY	CZ	DE	DK	EE
EL	ES	FI	FR	HR	HU	IE	IS	IT
LI	LT	LU	LV	MT	NL	NO	PL	PT
RO	SE	SI	SK	TR	UK			

Česky	Společnost Lexmark International, Inc. tímto prohlašuje, že výrobek tento výrobek je ve shodě se základními požadavky a dalšími příslušnými ustanoveními směrnice 1999/5/ES.
Dansk	Lexmark International, Inc. erklærer herved, at dette produkt overholder de væsentlige krav og øvrige relevante krav i direktiv 1999/5/EF.
Deutsch	Hiermit erklärt Lexmark International, Inc., dass sich das Gerät dieses Gerät in Übereinstimmung mit den grundlegenden Anforderungen und den übrigen einschlägigen Bestimmungen der Richtlinie 1999/5/EG befindet.
Ελληνική	ΜΕ ΤΗΝ ΠΑΡΟΥΣΑ Η LEXMARK INTERNATIONAL, INC. ΔΗΛΩΝΕΙ ΟΤΙ ΑΥΤΟ ΤΟ ΠΡΟΪΟΝ ΣΥΜΜΟΡΦΩΝΕΤΑΙ ΠΡΟΣ ΤΙΣ ΟΥΣΙΩΔΕΙΣ ΑΠΑΙΤΗΣΕΙΣ ΚΑΙ ΤΙΣ ΛΟΙΠΕΣ ΣΧΕΤΙΚΕΣ ΔΙΑΤΑΞΕΙΣ ΤΗΣ ΟΔΗΓΙΑΣ 1999/5/ΕΚ.
English	Hereby, Lexmark International, Inc., declares that this type of equipment is in compliance with the essential requirements and other relevant provisions of Directive 1999/5/EC.

Español	Por medio de la presente, Lexmark International, Inc. declara que este producto cumple con los requisitos esenciales y cualesquiera otras disposiciones aplicables o exigibles de la Directiva 1999/5/CE.
Eesti	Käesolevaga kinnitab Lexmark International, Inc., et seade see toode vastab direktiivi 1999/5/EÜ põhinõuetele ja nimetatud direktiivist tulenevatele muudele asjakohastele sätetele.
Suomi	Lexmark International, Inc. vakuuttaa täten, että tämä tuote on direktiivin 1999/5/EY oleellisten vaatimusten ja muiden sitä koskevien direktiivin ehtojen mukainen.
Français	Par la présente, Lexmark International, Inc. déclare que l'appareil ce produit est conforme aux exigences fondamentales et autres dispositions pertinentes de la directive 1999/5/CE.
Magyar	Alulírott, Lexmark International, Inc. nyilatkozom, hogy a termék megfelel a vonatkozó alapvető követelményeknek és az 1999/5/EC irányelv egyéb előírásainak.
Íslenska	Hér með lýsir Lexmark International, Inc. yfir því að þessi vara er í samræmi við grunnkröfur og aðrar kröfur, sem gerðar eru í tilskipun 1999/5/EC.
Italiano	Con la presente Lexmark International, Inc. dichiara che questo prodotto è conforme ai requisiti essenziali ed alle altre disposizioni pertinenti stabilite dalla direttiva 1999/5/CE.
Latviski	Ar šo Lexmark International, Inc. deklarē, ka šis izstrādājums atbilst Direktīvas 1999/5/EK būtiskajām prasībām un citiem ar to saistītajiem noteikumiem.
Lietuvių	Šiuo Lexmark International, Inc. deklaruoja, kad šis produktas atitinka esminius reikalavimus ir kitas 1999/5/EB direktyvos nuostatas.
Malti	Bil-preżenti, Lexmark International, Inc., jiddikjara li dan il-prodott huwa konformi mal-ħtiġijiet essenzjali u ma dispożizzjonijiet oħrajn relevanti li jinsabu fid-Direttiva 1999/5/KE.
Nederlands	Hierbij verklaart Lexmark International, Inc. dat het toestel dit product in overeenstemming is met de essentiële eisen en de andere relevante bepalingen van richtlijn 1999/5/EG.
Norsk	Lexmark International, Inc. erklærer herved at dette produktet er i samsvar med de grunnleggende krav og øvrige relevante krav i direktiv 1999/5/EF.
Polski	Niniejszym Lexmark International, Inc. oświadcza, że niniejszy produkt jest zgodny z zasadniczymi wymogami oraz pozostałymi stosownymi postanowieniami Dyrektywy 1999/5/EC.
Português	A Lexmark International Inc. declara que este produto está conforme com os requisitos essenciais e outras disposições da Diretiva 1999/5/CE.
Slovensky	Lexmark International, Inc. týmto vyhlasuje, že tento produkt spĺňa základné požiadavky a všetky príslušné ustanovenia smernice 1999/5/ES.
Slovensko	Lexmark International, Inc. izjavlja, da je ta izdelek v skladu z bistvenimi zahtevami in ostalimi relevantnimi določili direktive 1999/5/ES.
Svenska	Härmed intygar Lexmark International, Inc. att denna produkt står i överensstämmelse med de väsentliga egenskapskrav och övriga relevanta bestämmelser som framgår av direktiv 1999/5/EG.

Patent acknowledgment

The use of this product or service is subject to the reasonable, non-discriminatory terms in the Intellectual Property Rights (IPR) Disclosure of Certicom Corp. at the IETF for Elliptic Curve Cryptography (ECC) Cipher Suites for Transport Layer Security (TLS) implemented in the product or service.

The use of this product or service is subject to the reasonable, non-discriminatory terms in the Intellectual Property Rights (IPR) Disclosure of Certicom Corp. at the IETF for TLS Elliptic Curve Cipher Suites with SHA-256/382 and AES Galois Counter Mode (GCM) implemented in the product or service.

The use of this product or service is subject to the reasonable, non-discriminatory terms in the Intellectual Property Rights (IPR) Disclosure of Certicom Corp. at the IETF for TLS Suite B Profile for Transport Layer Security (TLS) implemented in the product or service.

The use of this product or service is subject to the reasonable, non-discriminatory terms in the Intellectual Property Rights (IPR) Disclosure of Certicom Corp. at the IETF for Addition of the Camellia Cipher Suites to Transport Layer Security (TLS) implemented in the product or service.

The use of certain patents in this product or service is subject to the reasonable, non-discriminatory terms in the Intellectual Property Rights (IPR) Disclosure of Certicom Corp. at the IETF for AES-CCM ECC Cipher Suites for TLS implemented in the product or service.

The use of this product or service is subject to the reasonable, non-discriminatory terms in the Intellectual Property Rights (IPR) Disclosure of Certicom Corp. at the IETF for IKE and IKEv2 Authentication Using the Elliptic Curve Digital Signature Algorithm (ECDSA) implemented in the product or service.

The use of this product or service is subject to the reasonable, non-discriminatory terms in the Intellectual Property Rights (IPR) Disclosure of Certicom Corp. at the IETF for Suite B Cryptographic Suites for IPsec implemented in the product or service.

The use of this product or service is subject to the reasonable, non-discriminatory terms in the Intellectual Property Rights (IPR) Disclosure of Certicom Corp. at the IETF for Algorithms for Internet Key Exchange version 1 (IKEv1) implemented in the product or service.

STATEMENT OF LIMITED WARRANTY FOR LEXMARK LASER PRINTERS, LEXMARK LED PRINTERS, AND LEXMARK MULTIFUNCTION LASER PRINTERS

Lexmark International, Inc., Lexington, KY

This limited warranty applies to the United States and Canada. For customers outside the U.S., refer to the country-specific warranty information that came with your product.

This limited warranty applies to this product only if it was originally purchased for your use, and not for resale, from Lexmark or a Lexmark Remarketer, referred to in this statement as "Remarketer."

Limited warranty

Lexmark warrants that this product:

- Is manufactured from new parts, or new and serviceable used parts, which perform like new parts
- Is, during normal use, free from defects in material and workmanship

If this product does not function as warranted during the warranty period, contact a Remarketer or Lexmark for repair or replacement (at Lexmark's option).

If this product is a feature or option, this statement applies only when that feature or option is used with the product for which it was intended. To obtain warranty service, you may be required to present the feature or option with the product.

If you transfer this product to another user, warranty service under the terms of this statement is available to that user for the remainder of the warranty period. You should transfer proof of original purchase and this statement to that user.

Limited warranty service

The warranty period starts on the date of original purchase as shown on the purchase receipt and ends 12 months later provided that the warranty period for any supplies and for any maintenance items included with the printer shall end earlier if it, or its original contents, are substantially used up, depleted, or consumed. Fuser Units, Transfer/Transport Units, Paper Feed items, if any, and any other items for which a Maintenance Kit is available are substantially consumed when the printer displays a “Life Warning” or “Scheduled Maintenance” message for such item.

To obtain warranty service you may be required to present proof of original purchase. You may be required to deliver your product to the Remarketer or Lexmark, or ship it prepaid and suitably packaged to a Lexmark designated location. You are responsible for loss of, or damage to, a product in transit to the Remarketer or the Lexmark designated location.

When warranty service involves the exchange of a product or part, the item replaced becomes the property of the Remarketer or Lexmark. The replacement may be a new or repaired item.

The replacement item assumes the remaining warranty period of the original product.

Replacement is not available to you if the product you present for exchange is defaced, altered, in need of a repair not included in warranty service, damaged beyond repair, or if the product is not free of all legal obligations, restrictions, liens, and encumbrances.

As part of your warranty service and/or replacement, Lexmark may update the firmware in your printer to the latest version. Firmware updates may modify printer settings and cause counterfeit and/or unauthorized products, supplies, parts, materials (such as toners and inks), software, or interfaces to stop working. Authorized use of genuine Lexmark products will not be impacted.

Before you present this product for warranty service, remove all print cartridges, programs, data, and removable storage media (unless directed otherwise by Lexmark).

For further explanation of your warranty alternatives and the nearest Lexmark authorized servicer in your area contact Lexmark on the World Wide Web.

Remote technical support is provided for this product throughout its warranty period. For products no longer covered by a Lexmark warranty, technical support may not be available or only be available for a fee.

Extent of limited warranty

Lexmark does not warrant uninterrupted or error-free operation of any product or the durability or longevity of prints produced by any product.

Warranty service does not include repair of failures caused by:

- Modification or unauthorized attachments
- Accidents, misuse, abuse or use inconsistent with Lexmark user’s guides, manuals, instructions or guidance
- Unsuitable physical or operating environment
- Maintenance by anyone other than Lexmark or a Lexmark authorized servicer
- Operation of a product beyond the limit of its duty cycle
- Use of printing media outside of Lexmark specifications
- Refurbishment, repair, refilling or remanufacture by a third party of products, supplies or parts
- Products, supplies, parts, materials (such as toners and inks), software, or interfaces not furnished by Lexmark

TO THE EXTENT PERMITTED BY APPLICABLE LAW, NEITHER LEXMARK NOR ITS THIRD PARTY SUPPLIERS OR REMARKETERS MAKE ANY OTHER WARRANTY OR CONDITION OF ANY KIND, WHETHER EXPRESS OR IMPLIED, WITH RESPECT TO THIS PRODUCT, AND SPECIFICALLY DISCLAIM THE IMPLIED WARRANTIES OR CONDITIONS OF

MERCHANTABILITY, FITNESS FOR A PARTICULAR PURPOSE, AND SATISFACTORY QUALITY. ANY WARRANTIES THAT MAY NOT BE DISCLAIMED UNDER APPLICABLE LAW ARE LIMITED IN DURATION TO THE WARRANTY PERIOD. NO WARRANTIES, EXPRESS OR IMPLIED, WILL APPLY AFTER THIS PERIOD. ALL INFORMATION, SPECIFICATIONS, PRICES, AND SERVICES ARE SUBJECT TO CHANGE AT ANY TIME WITHOUT NOTICE.

Limitation of liability

Your sole remedy under this limited warranty is set forth in this document. For any claim concerning performance or nonperformance of Lexmark or a Remarketer for this product under this limited warranty, you may recover actual damages up to the limit set forth in the following paragraph.

Lexmark's liability for actual damages from any cause whatsoever will be limited to the amount you paid for the product that caused the damages. This limitation of liability will not apply to claims by you for bodily injury or damage to real property or tangible personal property for which Lexmark is legally liable. **IN NO EVENT WILL LEXMARK BE LIABLE FOR ANY LOST PROFITS, LOST SAVINGS, INCIDENTAL DAMAGE, OR OTHER ECONOMIC OR CONSEQUENTIAL DAMAGES.** This is true even if you advise Lexmark or a Remarketer of the possibility of such damages. Lexmark is not liable for any claim by you based on a third party claim.

This limitation of remedies also applies to claims against any Suppliers and Remarketers of Lexmark. Lexmark's and its Suppliers' and Remarketers' limitations of remedies are not cumulative. Such Suppliers and Remarketers are intended beneficiaries of this limitation.

Additional rights

Some states do not allow limitations on how long an implied warranty lasts, or do not allow the exclusion or limitation of incidental or consequential damages, so the limitations or exclusions contained above may not apply to you.

This limited warranty gives you specific legal rights. You may also have other rights that vary from state to state.

Index

Numerics

- 250-sheet tray
 - installing 44
- 550-sheet tray
 - installing 44

Symbols

- [x]-page jam, remove all pages from the output bin. Leave paper in bin. [45y.xx] 247
- [x]-page jam, clear manual feeder. [25y.xx] 244
- [x]-page jam, clear standard bin. [20y.xx] 238
- [x]-page jam, open automatic feeder top cover. [28y.xx] 238
- [x]-page jam, open front door. [20y.xx] 240
- [x]-page jam, open rear door. [20y.xx] 239
- [x]-page jam, open tray [x]. [24y.xx] 245
- [x]-page jam, remove tray 1 to clear duplex. [23y.xx] 243

A

- accessing the Embedded Web Server 21
- Active NIC menu 150
- adapter plug 116
- ADF
 - copying using 89
- ADF separator roller
 - ordering 224
- adjusting brightness
 - Embedded Web Server 214
 - printer control panel 214
- adjusting copy quality 94
- adjusting display brightness 214
- adjusting Sleep mode 212
- adjusting toner darkness 82
- administrator settings
 - Embedded Web Server 232
- advanced options
 - fax 129
 - FTP 99
 - FTP options 137

- advanced options, touch-screen
 - e-mail 106
- answering machine
 - setting up 109
- AppleTalk menu 155
- applications
 - home screen 22
 - understanding 22
- attaching cables 47
- available internal options 28
- avoiding jams 77
- avoiding paper jams 235

B

- blocking junk faxes 125
- buttons, printer control panel 15
- buttons, touch screen
 - using 18

C

- cables
 - Ethernet 47
 - USB 47
- canceling
 - print job, from computer 87
- canceling a print job
 - from a computer 87
 - from the printer control panel 87
- canceling an e-mail 104
- cannot open Embedded Web Server 314
- Card Copy
 - setting up 23
- card stock
 - loading, multipurpose feeder 64
 - tips 74
- Cartridge low [88.xy] 253
- Cartridge nearly low [88.xy] 254
- Cartridge very low, [x] estimated pages remain [88.xy] 254
- Cartridge, imaging unit mismatch [41.xy] 253
- Change [paper source] to [custom string] load [orientation] 254
- Change [paper source] to [custom type name] load [orientation] 254
- Change [paper source] to [paper size] load [orientation] 254
- Change [paper source] to [paper type] [paper size] load [orientation] 254
- Check tray [x] connection 255
- checking an unresponsive printer 268
- checking status of parts and supplies 222
- checking the status of parts and supplies 222
- checking the virtual display
 - using the Embedded Web Server 232
- cleaning
 - exterior of the printer 220
 - scanner glass 221
- cleaning the printer 220
- Close finisher rear door 255
- Close flatbed cover and load originals if restarting job [2yy.xx] 255
- Close front door 255
- Close rear door 255
- collate
 - copy options 99
- collating copies 94
- color quality troubleshooting
 - prints on color transparencies appear dark when projected 284
- Complex page, some data may not have printed [39] 256
- confidential data
 - information on securing 219
- confidential jobs
 - modifying print settings 86
- confidential print jobs 85
 - printing from a Macintosh computer 86
 - printing from Windows 86
- Confidential Print menu 160
- Configuration change, some held jobs were not restored [57] 256
- configuration information
 - wireless network 52
- Configure MP menu 142
- configuring
 - supply notifications, imaging unit 233

- supply notifications, maintenance kit 233
 - supply notifications, toner cartridge 233
 - configuring e-mail settings 100
 - configuring port settings 55
 - configuring supply notifications 233
 - connecting printer to distinctive ring service 120
 - connecting to a wireless network
 - using PIN (Personal Identification Number) method 53
 - using Push Button Configuration method 53
 - using the Embedded Web Server 54
 - using wireless setup wizard 53
 - conservation settings
 - brightness, adjusting 214
 - conserving supplies 210
 - Eco-Mode 211
 - Hibernate Mode 213
 - Hibernate Timeout 213
 - Quiet Mode 211
 - Schedule Power Modes 214
 - Sleep Mode 212
 - conserving supplies 210
 - contacting customer support 315
 - content
 - e-mail settings 105
 - content source
 - e-mail settings 105
 - fax options 127
 - content type
 - e-mail settings 105
 - fax options 127
 - control panel, printer 15
 - indicator light 15
 - Sleep button light 15
 - controller board
 - accessing 29
 - copies
 - copy options 99
 - copy job, canceling
 - using the ADF 97
 - using the scanner glass 97
 - copy options
 - collate 99
 - copies 99
 - darkness 98
 - save as shortcut 99
 - sides (duplex) 98
 - copy quality
 - adjusting 94
 - copy screen
 - content source 99
 - content type 99
 - options 98
 - Copy Settings menu 172
 - copy troubleshooting
 - copier does not respond 300
 - partial document or photo copies 302
 - poor copy quality 301
 - poor scanned image quality 312
 - scanner unit does not close 300, 311
 - copying
 - adding an overlay message 97
 - adjusting quality 94
 - canceling a copy job 97, 98
 - collating copies 94
 - custom job 96
 - different paper sizes 92
 - enlarging 93
 - inserting a header or footer 97
 - multiple pages on one sheet 95
 - on both sides of the paper (duplexing) 93
 - on letterhead 91
 - on transparencies 90
 - photos 90
 - placing separator sheets between copies 95
 - quick copy 89
 - reducing 93
 - selecting a tray 92
 - to a different size 91
 - using the ADF 89
 - using the scanner glass 90
 - copying different paper sizes 92
 - copying multiple pages on one sheet 95
 - copying on both sides of the paper (duplexing) 93
 - copying on transparencies 90
 - creating a fax destination shortcut
 - using the Embedded Web Server 124
 - creating an FTP shortcut
 - using the Embedded Web Server 130
 - creating custom name paper type 70
 - creating profiles
 - using the ScanBack Utility 135
 - custom name
 - configuring 71
 - Custom Names menu 147
 - custom paper type name
 - assigning 71
 - Custom Scan Sizes menu 148
 - Custom Type [x]
 - changing paper type 71
 - creating custom name 70
 - Custom Types menu 147
 - customer support
 - contacting 315
- ## D
- darkness
 - copy options 98
 - e-mail options 105
 - fax options 128
 - scan options 136
 - date and time, fax setting 121
 - daylight saving time, setting 121
 - Default Source menu 139
 - Defective flash detected [51] 256
 - delayed send
 - fax options 128
 - different paper sizes, copying 92
 - Digital Subscriber Line (DSL)
 - fax setup 113
 - digital telephone service
 - fax setup 115
 - directory list
 - printing 87
 - Disk full 62 256
 - Disk must be formatted for use in this device 256
 - disk wiping 217
 - display troubleshooting
 - printer display is blank 270
 - display, printer control panel 15
 - adjusting brightness 214
 - disposing of printer hard disk 216
 - distinctive ring service, fax
 - connecting to 120
 - documents, printing
 - from Macintosh 82
 - from Windows 82
 - DSL filter 113
 - duplexing 93

E

Eco-Mode setting 211
 Edit Security Setups menu 158
 Embedded Web Server
 accessing 13, 21
 administrator settings 232
 checking the status of parts 222
 checking the status of supplies 222
 creating a fax destination shortcut 124
 creating an FTP shortcut 130
 creating e-mail shortcuts 101
 functions 13
 initial fax setup 108
 modifying confidential print settings 86
 networking settings 232
 problem accessing 314
 scanning to a computer using 132
 setting up e-mail alerts 232
 using 13
 Embedded Web Server — Security: Administrator's Guide
 where to find 232
 Embedded Web Server — Security: Administrator's Guide
 where to find 219
 emission
 notices 317, 321, 322, 326, 327
 encrypting the printer hard disk 218
 enlarging a copy 93
 envelopes
 loading, multipurpose feeder 64
 tips on using 73
 environmental settings
 conserving supplies 210
 display brightness, adjusting 214
 Eco-Mode 211
 Hibernate Mode 213
 Hibernate Timeout 213
 Quiet Mode 211
 Schedule Power Modes 214
 Sleep Mode 212
 Erase Temporary Data Files menu 161
 erasing hard disk memory 217
 erasing non-volatile memory 217
 erasing volatile memory 216

Error reading USB drive. Remove USB. 257
 Error reading USB hub. Remove hub. 257
 Ethernet network
 preparing to set up for Ethernet printing 50
 Ethernet network setup
 using Macintosh 50
 using Windows 50
 Ethernet networking
 Macintosh 50
 Windows 50
 Ethernet port 47
 Ethernet setup
 preparing for an 50
 exporting a configuration using the Embedded Web Server 26
 exterior of the printer
 cleaning 220
 e-mail
 canceling 104
 e-mail alerts
 low supply levels 232
 paper jam 232
 setting up 232
 e-mail function
 setting up 100
 e-mail options
 darkness 105
 message 104
 original size 104
 page setup 106
 recipient(s) 104
 resolution 105
 send as 105
 subject 104
 e-mail screen
 advanced options 106
 options 104, 106
 E-mail Settings menu 184
 e-mail shortcuts, creating using the Embedded Web Server 101
 e-mail, sending
 using a shortcut number 102
 using the address book 103
 e-mailing
 adding message line 103
 adding subject line 103
 changing output file type 103

configuring e-mail settings 100
 creating shortcuts using the Embedded Web Server 101
 creating shortcuts using the printer control panel 101
 setting up e-mail function 100
 using a shortcut number 102
 using the address book 103
 using the printer control panel 102

F

factory defaults
 restoring 234
 fax
 sending 122, 123
 fax and e-mail functions
 setting up 303
 fax and e-mail functions are not set up 303
 fax log
 viewing 125
 Fax memory full 257
 Fax Mode (Analog Fax Setup) menu 176
 fax name, setting 120
 fax number, setting 120
 fax options
 content source 127
 content type 127
 darkness 128
 delayed send 128
 page setup 128
 resolution 128
 scan preview 128
 Fax partition inoperative. Contact system administrator. 257
 fax ports 47
 fax screen
 advanced options 129
 Fax server 'To Format' not set up. Contact system administrator. 257
 fax setup
 country- or region-specific 116
 digital telephone service 115
 DSL connection 113
 standard telephone line connection 109
 VoIP 114
 Fax Station Name not set up. Contact system administrator. 257

- Fax Station Number not set up. Contact system administrator. 257
 - fax troubleshooting
 - caller ID is not shown 304
 - can receive but not send faxes 307
 - can send but not receive faxes 306
 - cannot send or receive a fax 304
 - received fax has poor print quality 308
 - faxing
 - blocking junk faxes 125
 - canceling a fax job 126
 - changing resolution 124
 - configuring the printer to observe daylight saving time 121
 - creating shortcuts using the Embedded Web Server 124
 - creating shortcuts using the printer control panel 124
 - distinctive ring service 120
 - fax setup 108
 - forwarding faxes 127
 - holding faxes 126
 - making a fax lighter or darker 125
 - sending a fax at a scheduled time 123
 - sending using the printer control panel 121
 - setting the date and time 121
 - setting the fax number 120
 - setting the outgoing fax name 120
 - viewing a fax log 125
 - FCC notices 317, 322, 326
 - file name
 - scan options 135
 - finding more information about the printer 9
 - finding printer IP address 21
 - finisher
 - finishing features 80
 - supported paper sizes 80
 - finisher features 80
 - Finishing menu 199
 - firmware card 28
 - flash drive
 - printing from 83
 - Flash Drive menu 193
 - flash drives
 - supported file types 84
 - font sample list
 - printing 87
 - Forms and Favorites
 - setting up 22
 - forwarding faxes 127
 - FTP
 - FTP options 135
 - FTP address
 - creating shortcuts using the printer control panel 131
 - FTP address, scanning to
 - using a shortcut number 131
 - using the printer control panel 131
 - FTP options
 - advanced options 137
 - FTP 135
 - FTP screen
 - advanced options 99
 - FTP Settings menu 189
- G**
- General Settings menu 163
 - green settings
 - Eco-Mode 211
 - Hibernate Mode 213
 - Hibernate Timeout 213
 - Quiet Mode 211
 - Schedule Power Modes 214
- H**
- held jobs 85
 - printing from a Macintosh computer 86
 - printing from Windows 86
 - Help menu 209
 - Hibernate Mode
 - using 213
 - Hibernate Timeout
 - setting 213
 - hiding icons on the home screen 21
 - holding faxes 126
 - home screen
 - customizing 21
 - hiding icons 21
 - showing icons 21
 - home screen applications
 - configuring 22
 - finding information 22
 - home screen buttons and icons
 - description 16
 - HTML menu 207
- I**
- icons on the home screen
 - hiding 21
 - showing 21
 - Image menu 208
 - imaging unit
 - ordering 223
 - replacing 226
 - Imaging unit low [84.xy] 257
 - Imaging unit nearly low [84.xy] 258
 - Imaging unit very low, [x] estimated pages remain [84.xy] 258
 - importing a configuration
 - using the Embedded Web Server 26
 - in finisher rear door
 - paper jams, clearing 247
 - Incompatible tray [x] [59] 258
 - Incorrect paper size, open [paper source] [34] 258
 - initial fax setup 108
 - using the Embedded Web Server 108
 - inserting a header or footer 97
 - installing an Internal Solutions Port 33
 - installing an optional card 32
 - installing options
 - order of installation 44
 - installing printer hard disk 40
 - installing printer on a network
 - Ethernet networking 50
 - installing printer software
 - adding options 49
 - installing printer software (Windows) 48
 - installing the 250-sheet tray 44
 - installing the 550-sheet tray 44
 - Insufficient memory for Flash Memory Defragment operation [37] 258
 - Insufficient memory to collate job [37] 258
 - Insufficient memory to support Resource Save feature [35] 259
 - Insufficient memory, some Held Jobs were deleted [37] 259
 - Insufficient memory, some held jobs will not be restored [37] 259
 - internal options 28

Internal Solutions Port
 changing port settings 55
 installing 33
 troubleshooting 272
 IP address of computer
 finding 20
 IP address, printer
 finding 21
 IPv6 menu 153

J

jams
 accessing 236
 avoiding 235
 understanding messages 236
 jams, clearing
 finisher bin 247
 in automatic document feeder top
 cover 238
 in duplex area 243
 in front door 240
 in manual feeder 244
 in rear door 239
 in standard bin 238
 in staple access door 247
 in tray [x] 245
 Job Accounting menu 202

L

labels, paper
 tips 74
 letterhead
 copying on 91
 loading, multipurpose feeder 64
 tips on using 73
 light, indicator 15
 line filter 113
 linking trays 70, 71
 Load [paper source] with [custom
 string] [paper orientation] 259
 Load [paper source] with [custom
 type name] [paper orientation] 259
 Load [paper source] with [paper
 size] [paper orientation] 259
 Load [paper source] with [paper
 type] [paper size] [paper
 orientation] 260
 Load Manual Feeder with [custom
 string] [paper orientation] 260
 Load Manual Feeder with [custom
 type name] [paper orientation] 260

Load Manual Feeder with [paper
 size] [paper orientation] 260
 Load manual feeder with [paper
 type] [paper size] [paper
 orientation] 260
 loading
 multipurpose feeder 64
 trays 59
 loading the optional tray 59
 loading the standard tray 59

M

maintenance kit
 ordering 224
 Maintenance kit low [80.xy] 261
 Maintenance kit nearly low
 [80.xy] 261
 Maintenance kit very low, [x]
 estimated pages remain
 [80.xy] 261
 making copies using paper from
 selected tray 92
 memory
 types installed on printer 216
 memory card 28
 installing 30
 troubleshooting 272
 Memory full [38] 261
 Memory full, cannot print
 faxes 261
 Memory full, cannot send
 faxes 261
 menu settings page
 printing 58
 menus
 Active NIC 150
 AppleTalk 155
 Confidential Print 160
 Configure MP 142
 Copy Settings 172
 Custom Names 147
 Custom Scan Sizes 148
 Custom Types 147
 Default Source 139
 Edit Security Setups 158
 Erase Temporary Data Files 161
 E-mail Settings 184
 Fax Mode (Analog Fax Setup) 176
 Finishing 199
 Flash Drive 193
 FTP Settings 189
 General Settings 163

Help 209
 HTML 207
 Image 208
 IPv6 153
 Job Accounting 202
 list of 138
 Miscellaneous Security
 Settings 159
 Network [x] 150
 Network Card 152
 Network Reports 151
 Paper Loading 146
 Paper Size/Type 139
 Paper Texture 143
 Paper Weight 144
 PCL Emul 205
 PDF 204
 PostScript 204
 Quality 201
 Reports 149
 Security Audit Log 161
 Set Date/Time 162
 Settings 197
 SMTP Setup menu 157
 Standard Network 150
 Standard USB 155
 Substitute Size 143
 TCP/IP 152
 Universal Setup 148
 Utilities 203
 Wireless 154
 XPS 204
 message
 e-mail options 104
 Miscellaneous Security Settings
 menu 159
 mobile device
 printing from 84
 moving the printer 10, 231
 Multi Send
 adding a profile 24
 setting up 24
 multipurpose feeder
 loading 64
 MyShortcut
 about 24
N
 Network [x] menu 150
 Network [x] software error
 [54] 261
 Network Card menu 152

- Network Reports menu 151
- network settings
 - Embedded Web Server 232
- network setup page
 - printing 58
- Networking Guide
 - where to find 232
- No analog phone line connected to modem, fax is disabled. 262
- noise emission levels 317
- Non-Lexmark [supply type], see User's Guide [33.xy] 262
- non-volatile memory 216
 - erasing 217
- Not enough free space in flash memory for resources [52] 262
- notices 317, 318, 319, 320, 321, 322, 323, 324, 325, 326, 327, 328
- number of remaining pages
 - estimate 222
- O**
- optional card
 - installing 32
- optional tray
 - loading 59
- options
 - 250-sheet tray, installing 44
 - 550-sheet tray, installing 44
 - firmware cards 28
 - Internal Solutions Port, installing 33
 - memory card 30
 - memory cards 28
 - printer hard disk, installing 40
 - printer hard disk, removing 43
 - updating in printer driver 49
- options, copy screen
 - copy from 98
 - scale 98
- options, touch-screen
 - copy 98
 - e-mail 104, 106
- ordering
 - imaging unit 223
 - maintenance kit 224
 - staple cartridges 224
- ordering supplies
 - toner cartridges 223
- original size
 - e-mail options 104
 - scan options 135
- output file type
 - changing 103
- P**
- page setup
 - e-mail options 106
 - fax options 128
 - scan options 137
- paper
 - characteristics 75
 - different sizes, copying 92
 - letterhead 76
 - loading, multipurpose feeder 64
 - preprinted forms 76
 - recycled 77
 - saving 95
 - selecting 76
 - storing 77
 - unacceptable 76
 - Universal size setting 59
- Paper changes needed 262
- paper feed troubleshooting
 - message remains after jam is cleared 274
- paper jams
 - avoiding 235
- paper jams, clearing
 - finisher bin 247
 - in automatic document feeder top cover 238
 - in duplex area 243
 - in finisher rear door 247
 - in front door 240
 - in manual feeder 244
 - in rear door 239
 - in standard bin 238
 - in staple access door 247
 - in tray [x] 245
- paper labels
 - loading, multipurpose feeder 64
- Paper Loading menu 146
- paper size
 - setting 59
- Paper Size/Type menu 139
- paper sizes
 - supported 78
- paper stop, using 69
- Paper Texture menu 143
- paper type
 - setting 59
- paper types
 - supported by printer 79
 - where to load 79
- Paper Weight menu 144
- paper weights
 - supported by printer 79
- Parallel port [x] disabled [56] 263
- parts
 - checking status 222
 - checking, from printer control panel 222
 - checking, using the Embedded Web Server 222
 - using genuine Lexmark 222
- PCL Emul menu 205
- PDF menu 204
- Personal Identification Number method
 - using 53
- phone splitter 114
- photos
 - copying 90
- placing separator sheets between copies 95
- port settings
 - configuring 55
- PostScript menu 204
- preparing to set up the printer on an Ethernet network 50
- print irregularities 288
- print job
 - canceling, from computer 87
- print quality
 - cleaning the scanner glass 221
- print quality troubleshooting
 - blank pages 282
 - characters have jagged edges 281
 - clipped pages or images 283
 - gray background on prints 285
 - horizontal voids appear on prints 296
 - print irregularities 288
 - print is too dark 290
 - print is too light 291
 - printer is printing solid black pages 293
 - repeating print defects appear on prints 289
 - shadow images appear on prints 284
 - skewed print 292
 - streaked horizontal lines appear on prints 294
 - streaked vertical lines 295

- toner fog or background shading 298
- toner rubs off 299
- toner specks appear on prints 298
- transparency print quality is poor 294
- uneven print density 299
- white streaks 297
- print troubleshooting
 - error reading flash drive 275
 - held jobs do not print 277
 - incorrect characters print 279
 - incorrect margins on prints 286
 - jammed pages are not reprinted 274
 - job prints from wrong tray 279
 - job prints on wrong paper 279
 - jobs do not print 275
 - Large jobs do not collate 280
 - multiple-language PDF files do not print 274
 - paper curl 287
 - paper frequently jams 273
 - print job takes longer than expected 278
 - tray linking does not work 280
 - unexpected page breaks occur 281
- printer
 - basic model 11
 - finishing features 80
 - fully configured 11
 - minimum clearances 10
 - moving 10, 231
 - selecting a location 10
 - shipping 231
- printer configurations 11
- printer control panel 15
 - factory defaults, restoring 234
 - indicator light 15
 - Sleep button light 15
- printer control panel, virtual display
 - using the Embedded Web Server 232
- Printer had to restart. Last job may be incomplete. 263
- printer hard disk
 - disposing of 216
 - encrypting 218
 - installing 40
 - removing 43
 - wiping 217
- printer hard disk encryption 218
- printer hard disk memory erasing 217
- printer information
 - where to find 9
- printer IP address finding 21
- printer is printing blank pages 282
- printer messages
 - [x]-page jam, remove all pages from the output bin. Leave paper in bin. [45y.xx] 247
 - [x]-page jam, clear manual feeder. [25y.xx] 244
 - [x]-page jam, clear standard bin. [20y.xx] 238
 - [x]-page jam, open automatic feeder top cover. [28y.xx] 238
 - [x]-page jam, open front door. [20y.xx] 240
 - [x]-page jam, open rear door. [20y.xx] 239
 - [x]-page jam, open tray [x]. [24y.xx] 245
 - [x]-page jam, remove tray 1 to clear duplex. [23y.xx] 243
- Cartridge low [88.xy] 253
- Cartridge nearly low [88.xy] 254
- Cartridge very low, [x] estimated pages remain [88.xy] 254
- Cartridge, imaging unit mismatch [41.xy] 253
- Change [paper source] to [custom string] load [orientation] 254
- Change [paper source] to [custom type name] load [orientation] 254
- Change [paper source] to [paper size] load [orientation] 254
- Change [paper source] to [paper type] [paper size] load [orientation] 254
- Check tray [x] connection 255
- Close finisher rear door 255
- Close flatbed cover and load originals if restarting job [2yy.xx] 255
- Close front door 255
- Close rear door 255
- Complex page, some data may not have printed [39] 256
- Configuration change, some held jobs were not restored [57] 256
- Defective flash detected [51] 256
- Disk full 62 256
- Disk must be formatted for use in this device 256
- Disk near full. Securely clearing disk space. 256
- Error reading USB drive. Remove USB. 257
- Error reading USB hub. Remove hub. 257
- Fax memory full 257
- Fax partition inoperative. Contact system administrator. 257
- Fax server 'To Format' not set up. Contact system administrator. 257
- Fax Station Name not set up. Contact system administrator. 257
- Fax Station Number not set up. Contact system administrator. 257
- Imaging unit low [84.xy] 257
- Imaging unit nearly low [84.xy] 258
- Imaging unit very low, [x] estimated pages remain [84.xy] 258
- Incompatible tray [x] [59] 258
- Incorrect paper size, open [paper source] [34] 258
- Insufficient memory for Flash Memory Defragment operation [37] 258
- Insufficient memory to collate job [37] 258
- Insufficient memory to support Resource Save feature [35] 259
- Insufficient memory, some Held Jobs were deleted [37] 259
- Insufficient memory, some held jobs will not be restored [37] 259
- Load [paper source] with [custom string] [paper orientation] 259
- Load [paper source] with [custom type name] [paper orientation] 259
- Load [paper source] with [paper size] [paper orientation] 259

- Load [paper source] with [paper type] [paper size] [paper orientation] 260
 - Load Manual Feeder with [custom string] [paper orientation] 260
 - Load Manual Feeder with [custom type name] [paper orientation] 260
 - Load Manual Feeder with [paper size] [paper orientation] 260
 - Load manual feeder with [paper type] [paper size] [paper orientation] 260
 - Maintenance kit low [80.xy] 261
 - Maintenance kit nearly low [80.xy] 261
 - Maintenance kit very low, [x] estimated pages remain [80.xy] 261
 - Memory full [38] 261
 - Memory full, cannot print faxes 261
 - Memory full, cannot send faxes 261
 - Network [x] software error [54] 261
 - No analog phone line connected to modem, fax is disabled. 262
 - Non-Lexmark [supply type], see User's Guide [33.xy] 262
 - Not enough free space in flash memory for resources [52] 262
 - Paper changes needed 262
 - Parallel port [x] disabled [56] 263
 - Printer had to restart. Last job may be incomplete. 263
 - Reinstall missing or unresponsive cartridge [31.xy] 264
 - Reinstall missing or unresponsive imaging unit [31.xy] 264
 - Remove defective disk [61] 263
 - Remove paper from standard output bin 263
 - Replace all originals if restarting job. 264
 - Replace cartridge, 0 estimated pages remain [88.xy] 263
 - Replace defective imaging unit [31.xy] 263
 - Replace imaging unit, 0 estimated pages remain [84.xy] 263
 - Replace maintenance kit, 0 estimated pages remain [80.xy] 264
 - Replace unsupported cartridge [32.xy] 264
 - Replace unsupported imaging unit [32.xy] 265
 - Restore held jobs? 265
 - Scanner automatic feeder cover open 265
 - Scanner disabled by admin [840.01] 265
 - Scanner disabled. Contact system administrator if problem persists. [840.02] 265
 - Scanner jam, remove all originals from the scanner [2yy.xx] 265
 - Scanner jam, remove jammed originals from the scanner [2yy.xx] 265
 - Serial port [x] disabled [56] 265
 - SMTP server not set up. Contact system administrator. 266
 - Some held jobs were not restored 266
 - Standard network software error [54] 266
 - Standard USB port disabled [56] 266
 - Supply needed to complete job 266
 - Too many flash options installed [58] 266
 - Too many trays attached [58] 267
 - Unformatted flash detected [53] 267
 - Unsupported disk 267
 - Unsupported option in slot [x] [55] 267
 - Unsupported USB hub, please remove 257
 - USB port [x] disabled [56] 267
 - Weblink server not set up. Contact system administrator. 267
 - printer options troubleshooting
 - internal option is not detected 270
 - Internal Solutions Port 272
 - memory card 272
 - tray problems 271
 - USB/parallel interface card 272
 - printer problems, solving basic 268
 - printer security
 - information on 219
 - printer software, installing (Windows) 48
 - printing
 - canceling, from the printer control panel 87
 - directory list 87
 - font sample list 87
 - forms 82
 - from a mobile device 84
 - from flash drive 83
 - from Macintosh 82
 - from Windows 82
 - menu settings page 58
 - network setup page 58
 - printing a directory list 87
 - printing a document 82
 - printing a font sample list 87
 - printing a menu settings page 58
 - printing a network setup page 58
 - printing confidential and other held jobs
 - from a Macintosh computer 86
 - from Windows 86
 - printing forms 82
 - printing from a flash drive 83
 - printing from a mobile device 84
 - publications
 - where to find 9
 - Push Button Configuration method using 53
- ## Q
- Quality menu 201
 - Quiet Mode 211
- ## R
- recipient(s)
 - e-mail options 104
 - recycled paper
 - using 77
 - recycling
 - Lexmark packaging 215
 - Lexmark products 215
 - toner cartridges 215
 - reducing a copy 93
 - reducing noise 211
 - Reinstall missing or unresponsive cartridge [31.xy] 264

Reinstall missing or unresponsive imaging unit [31.xy] 264
Remote Operator Panel
 setting up 26
Remove defective disk [61] 263
Remove paper from standard output bin 263
removing printer hard disk 43
repeat print jobs 85
 printing from a Macintosh computer 86
 printing from Windows 86
repeating print defects appear on prints 289
Replace all originals if restarting job. 264
Replace cartridge, 0 estimated pages remain [88.xy] 263
Replace defective imaging unit [31.xy] 263
Replace imaging unit, 0 estimated pages remain [84.xy] 263
Replace maintenance kit, 0 estimated pages remain [80.xy] 264
Replace unsupported cartridge [32.xy] 264
Replace unsupported imaging unit [32.xy] 265
replacing
 imaging unit 226
 toner cartridge 225
replacing supplies
 staple cartridge 229
replacing the staple cartridge 229
reports
 viewing 232
Reports menu 149
reserve print jobs 85
 printing from a Macintosh computer 86
 printing from Windows 86
resolution
 e-mail options 105
 fax options 128
 scan options 136
resolution, fax
 changing 124
Restore held jobs? 265
restoring factory default settings 234
RJ-11 adapter 116

S

safety information 7, 8
save as shortcut
 copy options 99
 scan options 135
saving paper 95
scan options
 darkness 136
 file name 135
 original size 135
 page setup 137
 resolution 136
 save as shortcut 135
 scan preview 137
 send as 136
scan preview
 fax options 128
 scan options 137
scan screen
 content source 136
 content type 136
Scan to Computer
 setting up 133
Scan to Network
 setting up 25
 using 130
scan troubleshooting
 cannot scan from a computer 313
 partial document or photo scans 313
 scan job was not successful 310
 scanner unit does not close 300, 311
 scanning takes too long or freezes the computer 311
ScanBack Utility
 using 135
scanner
 automatic document feeder (ADF) 14
 functions 14
 scanner glass 14
Scanner automatic feeder cover open 265
Scanner disabled by admin [840.01] 265
Scanner disabled. Contact system administrator if problem persists. [840.02] 265
scanner glass
 cleaning 221
 copying using 90
Scanner jam, remove all originals from the scanner [2yy.xx] 265
Scanner jam, remove jammed originals from the scanner [2yy.xx] 265
scanning
 from a flash drive 134
 quick copy 89
 to a computer 133
 to a computer using the Embedded Web Server 132
 to an FTP address 131
scanning to a computer 133
 using the Embedded Web Server 132
scanning to a flash drive 134
scanning to an FTP address
 creating shortcuts using the computer 130
 using a shortcut number 131
 using the address book 131
 using the printer control panel 131
scanning to network destinations 130
Schedule Power Modes
 using 214
security
 modifying confidential print settings 86
Security Audit Log menu 161
security slot 47
security Web page
 where to find 219
selecting a location for the printer 10
selecting paper 76
send as
 e-mail options 105
 scan options 136
sending a fax 122
sending a fax using the printer control panel 121
sending an e-mail using the printer control panel 102
sending fax
 using shortcuts 122
 using the address book 123
sending fax at a scheduled time 123

- sending fax using the address
 - book 123
 - Serial port [x] disabled [56] 265
 - serial printing
 - setting up 56
 - Set Date/Time menu 162
 - setting
 - TCP/IP address 152
 - setting Hibernate Timeout 213
 - setting the fax number 120
 - setting the outgoing fax name 120
 - setting the paper size 59
 - setting the paper type 59
 - setting the Universal paper size 59
 - setting up e-mail alerts 232
 - setting up fax
 - country- or region-specific 116
 - digital telephone service 115
 - DSL connection 113
 - standard telephone line connection 109
 - VoIP connection 114
 - setting up fax and e-mail functions 303
 - setting up serial printing 56
 - setting up the printer
 - on an Ethernet network (Macintosh only) 50
 - on an Ethernet network (Windows only) 50
 - Settings menu 197
 - shipping the printer 231
 - shortcuts, creating
 - e-mail 101
 - fax destination 124
 - FTP address 131
 - FTP destination 130
 - showing icons on the home screen 21
 - sides (duplex)
 - copy options 98
 - Sleep Mode
 - adjusting 212
 - SMTP server not set up. Contact system administrator. 266
 - SMTP Setup menu 157
 - Some held jobs were not restored 266
 - standard bin, using 69
 - Standard Network menu 150
 - Standard network software error [54] 266
 - standard tray
 - loading 59
 - Standard USB menu 155
 - Standard USB port disabled [56] 266
 - staple cartridge
 - replacing 229
 - staple cartridges
 - ordering 224
 - statement of volatility 216
 - status of parts
 - checking 222
 - status of supplies
 - checking 222
 - storing
 - paper 77
 - supplies 224
 - storing print jobs 85
 - streaked horizontal lines appear on prints 294
 - streaked vertical lines appear on prints 295
 - streaks appear 297
 - subject and message information
 - adding to e-mail 103
 - Substitute Size menu 143
 - supplies
 - checking status 222
 - checking, from printer control panel 222
 - checking, using the Embedded Web Server 222
 - conserving 210
 - storing 224
 - using genuine Lexmark 222
 - supplies, ordering
 - ADF separator roller 224
 - imaging unit 223
 - maintenance kit 224
 - staple cartridges 224
 - toner cartridges 223
 - Supply needed to complete job 266
 - supply notifications
 - configuring 233
 - supported flash drives 84
 - supported paper sizes 78
- T**
- TCP/IP menu 152
 - telecommunication notices 322, 323, 324, 325
 - the scanner does not respond 309
 - tips
 - card stock 74
 - labels, paper 74
 - letterhead 73
 - on using envelopes 73
 - transparencies 73
 - tips on using envelopes 73
 - toner cartridge
 - replacing 225
 - toner cartridges
 - ordering 223
 - recycling 215
 - toner darkness
 - adjusting 82
 - Too many flash options installed [58] 266
 - Too many trays attached [58] 267
 - touch screen
 - buttons 18
 - transparencies
 - copying on 90
 - loading, multipurpose feeder 64
 - tips 73
 - trays
 - linking 70, 71
 - loading 59
 - unlinking 70, 71
 - troubleshooting
 - an application error has occurred 314
 - cannot open Embedded Web Server 314
 - checking an unresponsive printer 268
 - contacting customer support 315
 - fax and e-mail functions are not set up 303
 - solving basic printer problems 268
 - the scanner does not respond 309
 - troubleshooting, color quality
 - prints on color transparencies appear dark when projected 284
 - troubleshooting, copy
 - copier does not respond 300
 - partial document or photo copies 302
 - poor copy quality 301
 - poor scanned image quality 312
 - scanner unit does not close 300, 311

- troubleshooting, display
 - printer display is blank 270
 - troubleshooting, fax
 - caller ID is not shown 304
 - can receive but not send
 - faxes 307
 - can send but not receive
 - faxes 306
 - cannot send or receive a fax 304
 - received fax has poor print
 - quality 308
 - troubleshooting, paper feed
 - message remains after jam is
 - cleared 274
 - troubleshooting, print
 - error reading flash drive 275
 - held jobs do not print 277
 - incorrect characters print 279
 - incorrect margins on prints 286
 - jammed pages are not
 - reprinted 274
 - job prints from wrong tray 279
 - job prints on wrong paper 279
 - jobs do not print 275
 - Large jobs do not collate 280
 - multiple-language PDF files do not
 - print 274
 - paper curl 287
 - paper frequently jams 273
 - print job takes longer than
 - expected 278
 - tray linking does not work 280
 - unexpected page breaks
 - occur 281
 - troubleshooting, print quality
 - blank pages 282
 - characters have jagged edges 281
 - clipped pages or images 283
 - gray background on prints 285
 - horizontal voids appear on
 - prints 296
 - print irregularities 288
 - print is too dark 290
 - print is too light 291
 - printer is printing solid black
 - pages 293
 - repeating print defects appear on
 - prints 289
 - shadow images appear on
 - prints 284
 - skewed print 292
 - streaked horizontal lines appear
 - on prints 294
 - streaked vertical lines 295
 - toner fog or background
 - shading 298
 - toner rubs off 299
 - toner specks appear on prints 298
 - transparency print quality is
 - poor 294
 - uneven print density 299
 - white streaks on a page 297
 - troubleshooting, printer options
 - internal option is not
 - detected 270
 - Internal Solutions Port 272
 - memory card 272
 - tray problems 271
 - USB/parallel interface card 272
 - troubleshooting, scan
 - cannot scan from a computer 313
 - partial document or photo
 - scans 313
 - scan job was not successful 310
 - scanner unit does not
 - close 300, 311
 - scanning takes too long or freezes
 - the computer 311
- U**
- unacceptable paper 76
 - understanding the home screen
 - buttons and icons 16
 - uneven print density 299
 - Unformatted flash detected
 - [53] 267
 - Universal Paper Size
 - setting 59
 - Universal paper size
 - setting 59
 - Universal Setup menu 148
 - unlinking trays 70, 71
 - Unsupported option in slot [x]
 - [55] 267
 - Unsupported USB hub, please
 - remove 257
 - updating options in printer
 - driver 49
 - USB port 47
 - USB port [x] disabled [56] 267
 - USB/parallel interface card
 - troubleshooting 272
 - using a shortcut number
 - scanning to an FTP address 131
 - using Forms and Favorites 82
 - using Hibernate Mode 213
 - using Schedule Power Modes 214
 - using shortcuts
 - sending fax 122
 - using the address book 103
 - sending fax 123
 - using the Embedded Web
 - Server 13
 - using the ScanBack Utility 135
 - using the touch-screen buttons 18
 - Utilities menu 203
- V**
- verify print jobs 85
 - printing from a Macintosh
 - computer 86
 - printing from Windows 86
 - vertical voids appear 297
 - viewing
 - reports 232
 - viewing a fax log 125
 - virtual display
 - checking, using Embedded Web
 - Server 232
 - voice mail
 - setting up 109
 - Voice over Internet Protocol (VoIP)
 - fax setup 114
 - voids appear 297
 - VoIP adapter 114
 - volatile memory 216
 - erasing 216
 - volatility
 - statement of 216
- W**
- Weblink server not set up. Contact
 - system administrator. 267
 - wiping the printer hard disk 217
 - Wireless menu 154
 - wireless network
 - configuration information 52
 - wireless network setup
 - using the Embedded Web
 - Server 54
 - wireless setup wizard
 - using 53

X

XPS menu 204