

# TABLE OF CONTENTS

<b>1</b>	<b>Before driving</b>	Adjusting and operating features such as door locks, mirrors, and steering column.
<b>2</b>	<b>When driving</b>	Driving, stopping and safe-driving information.
<b>3</b>	<b>Interior features</b>	Air conditioning and audio systems, as well as other interior features for a comfortable driving experience.
<b>4</b>	<b>Maintenance and care</b>	Cleaning and protecting your vehicle, performing do-it-yourself maintenance, and maintenance information.
<b>5</b>	<b>When trouble arises</b>	What to do if the vehicle needs to be towed, gets a flat tire, or is involved in an accident.
<b>6</b>	<b>Vehicle specifications</b>	Detailed vehicle information.
<b>7</b>	<b>For owners</b>	Reporting safety defects for US owners, and seat belt and SRS airbag instructions for Canadian owners.
	<b>Index</b>	Alphabetical listing of information contained in this manual.

For vehicles with a navigation system, refer to the “Navigation System Owner’s Manual” for information regarding the equipment listed below.

- Navigation system
- Air conditioning
- Climate control
- Rear view monitor system
- Audio/video system
- Rear window and outside rear view mirror defogging
- Intuitive parking assist

**1 Before driving**

<p><b>1-1. Key information</b></p> <p>Keys ..... 28</p> <p><b>1-2. Opening, closing and locking the doors and trunk</b></p> <p>Smart access system with push-button start ..... 33</p> <p>Wireless remote control ..... 45</p> <p>Doors..... 48</p> <p>Trunk..... 52</p> <p><b>1-3. Adjustable components (seats, mirrors, steering wheel)</b></p> <p>Front seats ..... 56</p> <p>Driving position memory ..... 58</p> <p>Head restraints..... 62</p> <p>Seat belts ..... 65</p> <p>Steering wheel (manually adjustable type)..... 72</p> <p>Steering wheel (power-adjustable type)..... 73</p>	<p>Anti-glare inside rear view mirror ..... 75</p> <p>Outside rear view mirrors..... 77</p> <p><b>1-4. Opening and closing the windows and moon roof</b></p> <p>Power windows..... 80</p> <p>Moon roof ..... 83</p> <p><b>1-5. Refueling</b></p> <p>Opening the fuel tank cap..... 87</p> <p><b>1-6. Theft deterrent system</b></p> <p>Engine immobilizer system..... 90</p> <p>Alarm..... 92</p> <p>Theft prevention labels (U.S.A.)..... 95</p> <p><b>1-7. Safety information</b></p> <p>Correct driving posture ..... 96</p> <p>SRS airbags ..... 98</p> <p>Front passenger occupant classification system..... 109</p> <p>Child restraint systems ..... 114</p> <p>Installing child restraints..... 118</p>
---	---

## 2 When driving

### 2-1. Driving procedures

Driving the vehicle.....	130
Engine (ignition) switch .....	141
Automatic transmission.....	146
Manual transmission.....	152
Turn signal lever .....	154
Parking brake .....	155
Horn.....	157

### 2-2. Instrument cluster

Gauges and meters .....	158
Indicators and warning lights.....	164
Multi-information display.....	167

### 2-3. Operating the lights and windshield wipers

Headlight switch.....	172
Fog light switch .....	176
Windshield wipers and washer.....	178
Headlight cleaner switch .....	185

### 2-4. Using other driving systems

Cruise control .....	186
Intuitive parking assist .....	190
Driving assist systems.....	196

### 2-5. Driving information

Cargo and luggage.....	202
Vehicle load limits.....	205
Winter driving tips .....	206
Trailer towing.....	210
Dinghy towing (vehicles with an automatic transmission).....	211
Dinghy towing (vehicles with a manual transmission).....	212

1

2

3

4

5

6

7

**3 Interior features**

**3-1. Using the air conditioning system and defogger**

Automatic air conditioning system ..... 216

Rear window and outside rear view mirror defoggers ..... 224

Windshield wiper de-icer ..... 225

**3-2. Using the audio system**

Audio system type ..... 226

Using the radio ..... 229

Using the CD player ..... 237

Playing back MP3 and WMA discs ..... 244

Operating an iPod ..... 252

Operating a USB memory ..... 260

Optimal use of the audio system ..... 269

Using the AUX port ..... 271

Using the steering wheel audio switches ..... 273

**3-3. Using the Bluetooth® audio system**

Bluetooth® audio system ..... 276

Using the Bluetooth® audio system ..... 279

Operating a Bluetooth® enabled portable player ..... 284

Setting up a Bluetooth® enabled portable player ..... 287

Bluetooth® audio system setup ..... 293

**3-4. Using the hands-free phone system (for mobile phones)**

Hands-free system for mobile phones ..... 294

Using the hands-free system (for mobile phones) ..... 298

Making a phone call ..... 306

Setting a mobile phone ..... 310

Security and system setup ..... 315

Using the phone book ..... 319

**3-5. Using the interior lights**

Interior lights list ..... 325

- Interior lights ..... 327
- Personal lights ..... 327

### 3-6. Using the storage features

List of storage features.....	329
• Glove box .....	330
• Console boxes .....	330
• Overhead console .....	332
• Cup holders.....	332
• Bottle holders/ door pockets.....	334
• Auxiliary box .....	335

### 3-7. Other interior features

Sun visors.....	336
Vanity mirrors.....	337
Clock.....	338
Satellite switches .....	339
Ashtrays .....	342
Cigarette lighter .....	343
Power outlet.....	344
Seat heaters.....	345
Seat heaters and ventilators.....	348
Armrest .....	351
Rear sunshade.....	352
Trunk storage extension .....	354
Coat hooks .....	355
Floor mat.....	356
Trunk features.....	357
Garage door opener.....	360
Compass.....	366
Safety Connect .....	370

## 4 Maintenance and care

### 4-1. Maintenance and care

Cleaning and protecting the vehicle exterior.....	378
Cleaning and protecting the vehicle interior .....	382

### 4-2. Maintenance

Maintenance requirements.....	385
General maintenance.....	387
Emission inspection and maintenance (I/M) programs .....	390

### 4-3. Do-it-yourself maintenance

Do-it-yourself service precautions.....	391
Hood .....	394
Positioning a floor jack.....	395
Engine compartment.....	397
Tires .....	412
Tire inflation pressure.....	424
Wheels .....	428
Air conditioning filter.....	430
Electronic key battery .....	433
Checking and replacing fuses .....	435
Headlight aim .....	449
Light bulbs.....	451

**5 When trouble arises**

**5-1. Essential information**

Emergency flashers..... 462  
 If your vehicle needs to be  
 towed..... 463  
 If you think something is  
 wrong ..... 469  
 Fuel pump shut off system ..... 470

**5-2. Steps to take in an emergency**

If a warning light turns on  
 or a warning buzzer  
 sounds... ..... 471  
 If a warning message is  
 displayed..... 481  
 If you have a flat tire..... 492  
 If the engine will not start ..... 501  
 If the shift lever cannot be  
 shifted from P ..... 503  
 If you lose your keys ..... 504  
 If the electronic key does  
 not operate properly ..... 505  
 If the vehicle battery is  
 discharged ..... 510  
 If your vehicle overheats ..... 513  
 If the vehicle becomes  
 stuck..... 516  
 If your vehicle has to be  
 stopped in an emergency ..... 518

**6 Vehicle specifications**

**6-1. Specifications**

Maintenance data  
 (fuel, oil level, etc.)..... 520  
 Fuel information..... 537  
 Tire information..... 541

**6-2. Customization**

Customizable features..... 553

**6-3. Initialization**

Items to initialize ..... 559

**7 For owners**

Reporting safety defects  
 for U.S. owners..... 562  
 Seat belt instructions  
 for Canadian owners  
 (in French)..... 563  
 SRS airbag instructions  
 for Canadian owners  
 (in French)..... 565

---

## Index

---

Abbreviation list ..... 576

Alphabetical index..... 578

What to do if... ..... 590

1

2

3

4

5

6

7





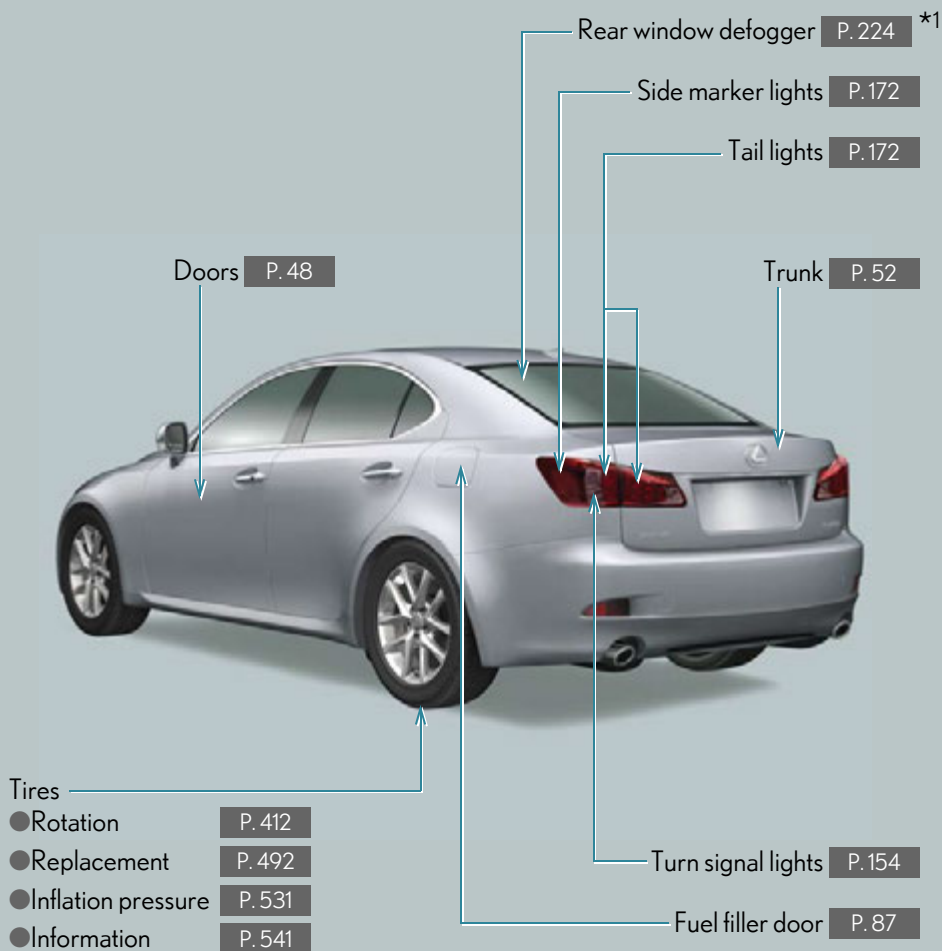

\*: If equipped

\*1: For vehicles with a navigation system, refer to the "Navigation System Owner's Manual".

# Pictorial index

# Interior

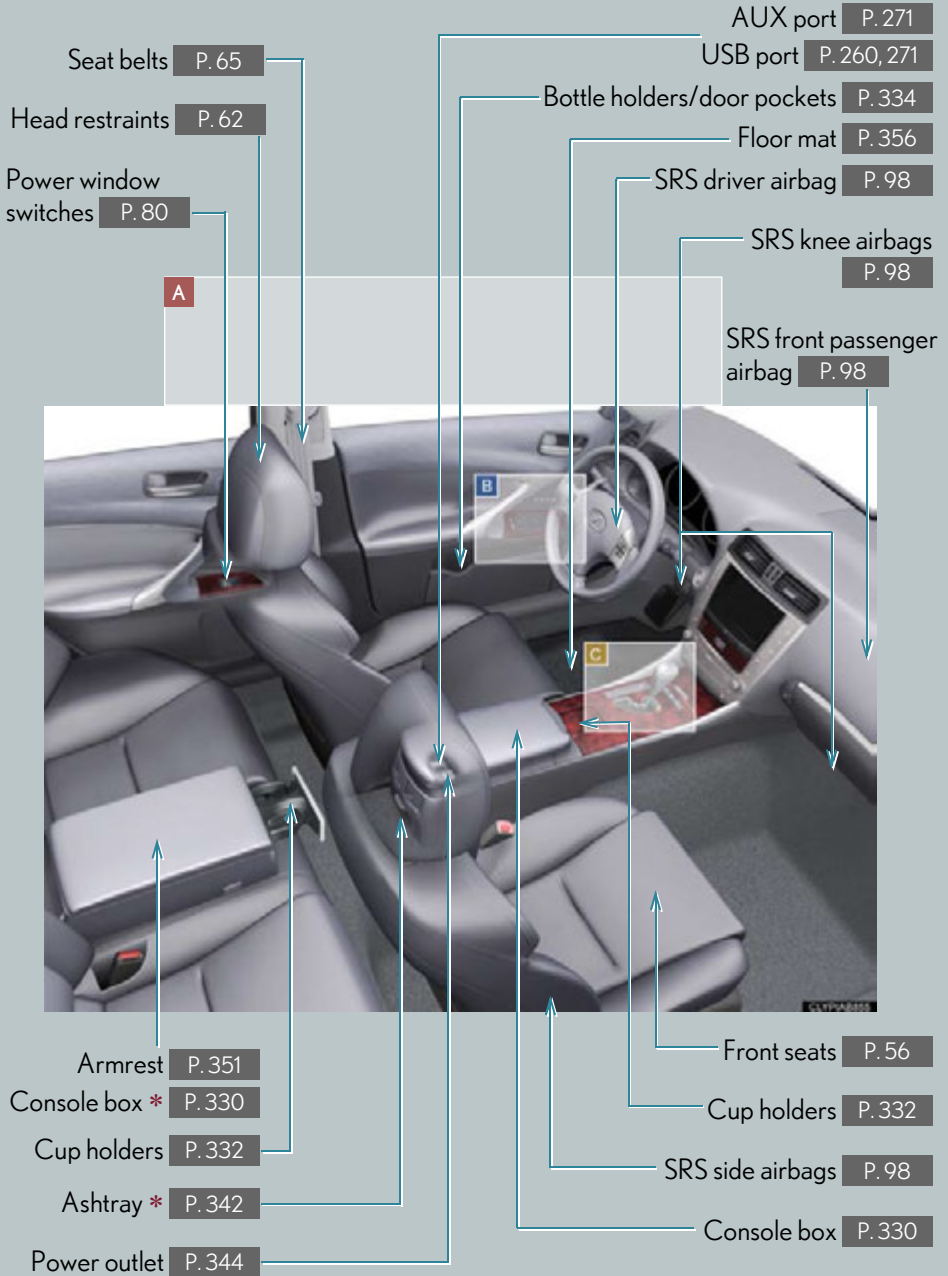

A

Anti-glare inside rear view mirror P. 75

Personal lights P. 327

Moon roof switches \* P. 83

"SOS" button \* P. 370

Personal lights P. 327

Interior lights P. 327



Coat hooks P. 355

SRS curtain shield airbags P. 98

Interior lights P. 327

Vanity mirrors P. 337

Sun visors P. 336

Garage door opener switches P. 360

Compass \* P. 366

\*: If equipped

B

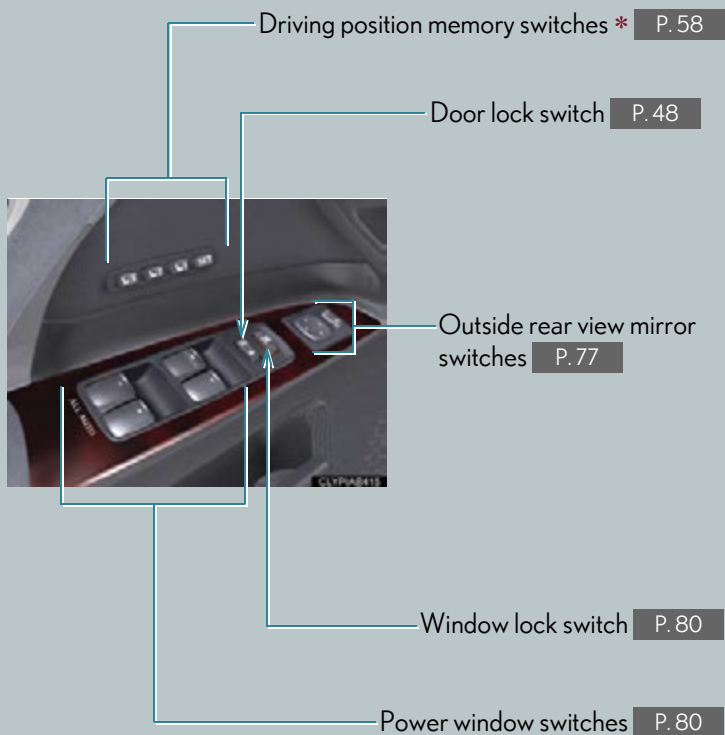

C

► **Automatic transmission**

Automatic transmission shift lever P. 146



Seat heater switches \* P. 345

Seat heater/ventilator switches \* P. 348

Shift lock override button P. 503

Cigarette lighter \* P. 343

Ashtray \* P. 342

Auxiliary box \* P. 335

► **Manual transmission**

Manual transmission shift lever P. 152



Parking brake lever P. 155

Seat heater switches \* P. 345

Seat heater/ventilator switches \* P. 348

Cigarette lighter \* P. 343

Ashtray \* P. 342

Auxiliary box \* P. 335

\*: If equipped

# Pictorial index

# Instrument panel

- Headlight switch P. 172
- Turn signal lever P. 154
- Fog light switch P. 176

- Shift paddle switches (automatic transmission) P. 147, 149
- Gauges and meters P. 158
- Multi-information display P. 167
- Windshield wiper and washer switch P. 178
- Engine (ignition) switch P. 141

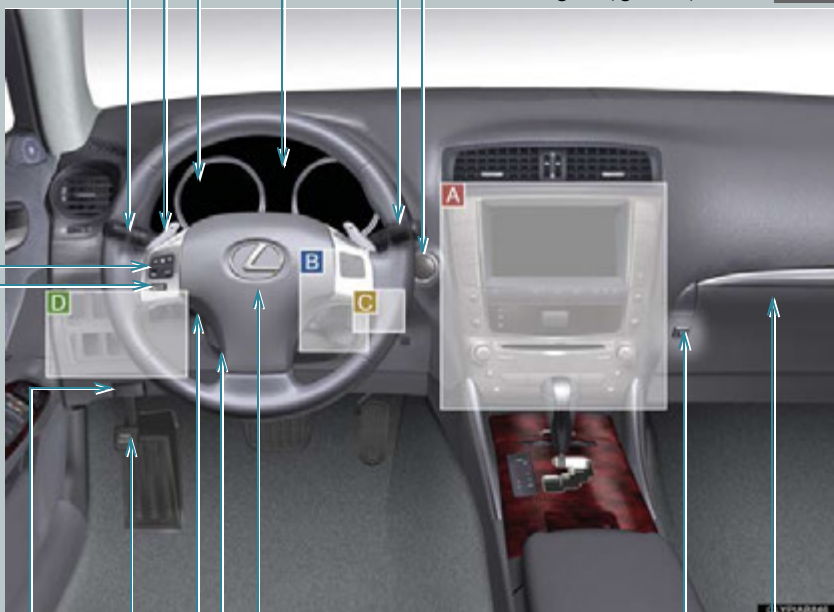

- Trunk opener main switch P. 52
- Glove box P. 329

- Horn P. 157
- Tilt and telescopic steering lock release lever \* P. 72

- Tilt and telescopic steering control switch \* P. 73

- Parking brake pedal (automatic transmission) P. 155

- Hood release lever P. 394

- Audio remote control switches P. 273

A

► Without navigation system

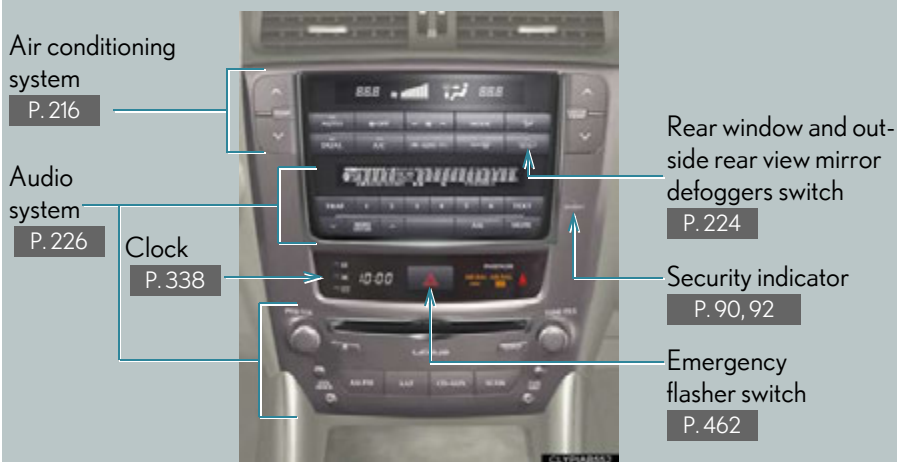

\*: If equipped

## A

► With navigation system

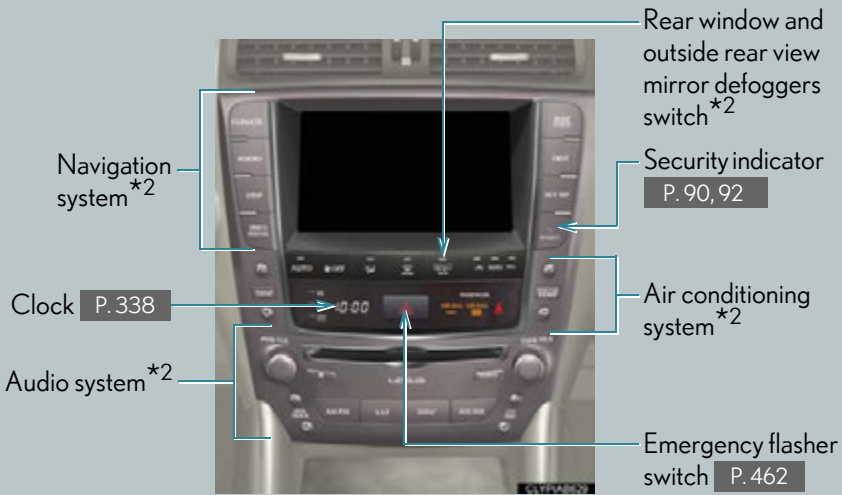

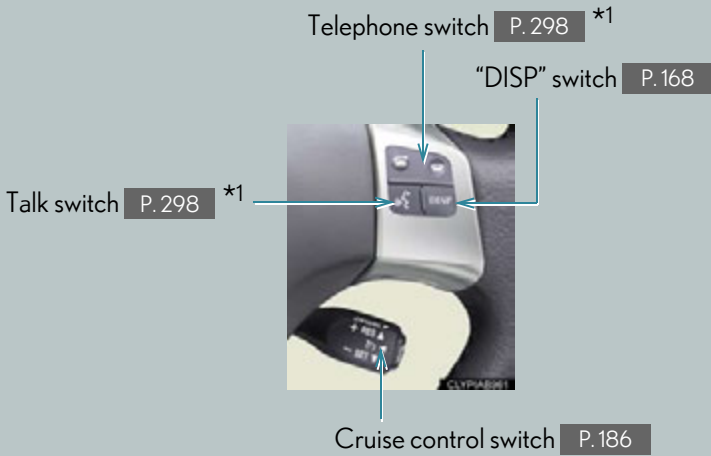

**B****C**▶ **Automatic transmission**

Windshield wiper  
de-icer \* P. 225

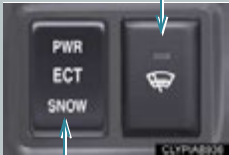

ECT switch P. 147

▶ **Manual transmission**

Windshield wiper  
de-icer \* P. 225



ETCS switch P. 153

\*: If equipped

\*1: For vehicles with a navigation system, refer to the "Navigation System Owner's Manual".

\*2: Refer to "Navigation System Owner's Manual".

D

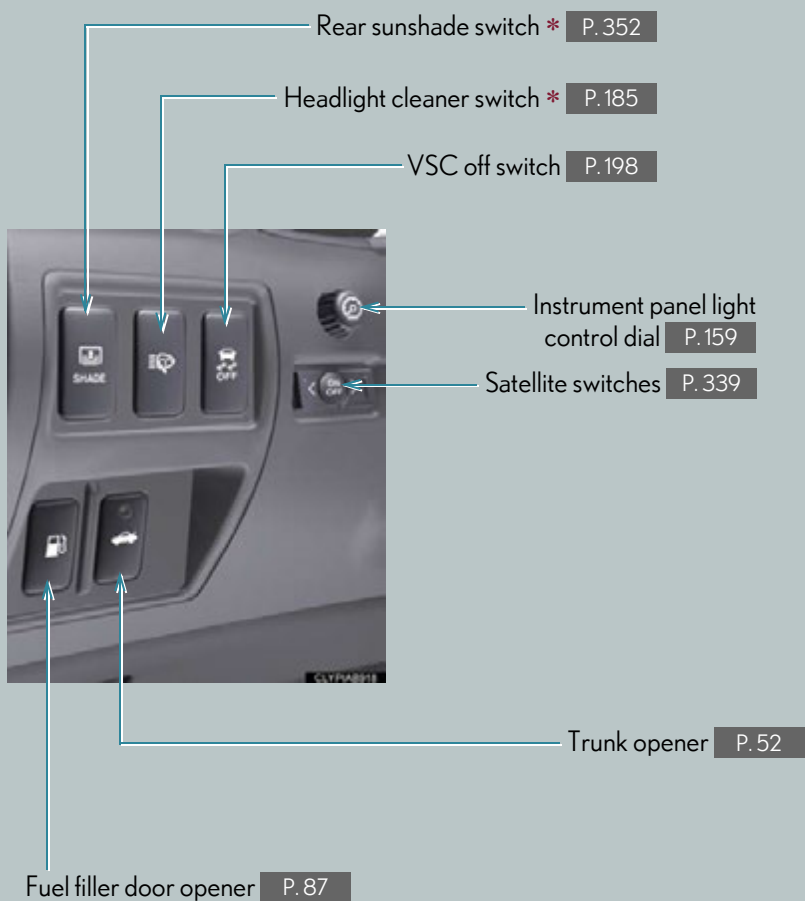

\*: If equipped

## For your information

### Main Owner's Manual

Please note that this manual applies to all models and explains all equipment, including options. Therefore, you may find some explanations for equipment not installed on your vehicle.

All specifications provided in this manual are current at the time of printing. However, because of the Lexus policy of continual product improvement, we reserve the right to make changes at any time without notice.

Depending on specifications, the vehicle shown in the illustration may differ from your vehicle in terms of color and equipment.

### Noise from under vehicle after turning off the engine

Approximately five hours after the engine is turned off, you may hear sound coming from under the vehicle for several minutes. This is the sound of a fuel evaporation leakage check and, it does not indicate a malfunction.

### Accessories, spare parts and modification of your Lexus

A wide variety of non-genuine spare parts and accessories for Lexus vehicles are currently available in the market. You should know that Toyota does not warrant these products and is not responsible for their performance, repair, or replacement, or for any damage they may cause to, or adverse effect they may have on, your Lexus vehicle.

This vehicle should not be modified with non-genuine Lexus products. Modification with non-genuine Lexus products could affect its performance, safety or durability, and may even violate governmental regulations. In addition, damage or performance problems resulting from the modification may not be covered under warranty.

## Installation of a mobile two-way radio system

The installation of a mobile two-way radio system in your vehicle could affect electronic systems such as:

- Multiport fuel injection system/sequential multiport fuel injection system
- Cruise control system
- Anti-lock brake system
- SRS airbag system
- Seat belt pretensioner system

Be sure to check with your Lexus dealer for precautionary measures or special instructions regarding installation of a mobile two-way radio system.

## Scraping of your Lexus

The SRS airbag and seat belt pretensioner devices in your Lexus contain explosive chemicals. If the vehicle is scrapped with the airbags and seat belt pretensioners left as they are, this may cause an accident such as fire. Be sure to have the systems of the SRS airbag and seat belt pretensioner removed and disposed of by a qualified service shop or by your Lexus dealer before you scrap your vehicle.

## Perchlorate Material

Special handling may apply, See [www.dtsc.ca.gov/hazardouswaste/perchlorate](http://www.dtsc.ca.gov/hazardouswaste/perchlorate).

Your vehicle has components that may contain perchlorate. These components may include airbag, seat belt pretensioners, and wireless remote control batteries.

## Vehicle control and operation data recording

Your Lexus is equipped with sophisticated computers that record certain information about your vehicle's operation, such as:

- Engine speed
- Accelerator status
- Brake status
- Vehicle speed
- Shift position (except manual transmission)

The data recorded varies according to the grade level and options the vehicle is equipped with. The computers do not record conversations, sound or pictures.

### ● Data usage

Lexus may use the data recorded in these computers to diagnose malfunctions, conduct research and development, and improve quality.

Lexus will not disclose the recorded data to a third party except:

- With the consent of the vehicle owner or with the consent of the lessee if the vehicle is leased
- In response to an official request by the police, a court of law or a government agency
- For research purposes where the data is not tied to a specific vehicle or vehicle owner

## ● Event data recorder

Your vehicle has computers that monitor and control certain aspects of your vehicle. These computers assist in driving and maintaining optimal vehicle performance.

Besides storing data useful for troubleshooting, there is an event data recorder (EDR) that records data in a crash or near crash event.

The SRS airbag sensor assembly contains the EDR. In a crash or near crash event, this device may record the following information:

- Engine speed
- Whether the brake pedal was depressed or not
- Vehicle speed
- To what extent the accelerator pedal was depressed
- The transmission shift position
- Whether the driver and front passenger wore seat belts or not
- Driver's seat position
- SRS airbag deployment data
- SRS airbag system diagnostic data
- Front passenger's occupant classification

The information above is intended to be used for the purpose of improving vehicle safety performance. Unlike general data recorders, the EDR does not record sound data such as conversation between passengers.

● Disclosure of the EDR data

Lexus will not disclose the data recorded in an EDR to a third party except when:

- An agreement from the vehicle's owner (or the leasing company for a leased vehicle) is obtained
- Officially requested to by the police or other authorities
- Necessary, for use as a defense for Lexus in a lawsuit
- Ordered to by a court of law

However, if necessary, Lexus will:

- Use the data for research on Lexus vehicle safety performance
- Disclose the data to a third party for research purposes without disclosing details of the vehicle owner, and that only when deemed necessary
- Disclose summarized data cleared of vehicle identification information to a non-Lexus organization for research purposes

● Safety Connect/Lexus Enform (U.S. mainland only)

If your Lexus has Safety Connect or Lexus Enform and if you have subscribed to those services, please refer to the Safety Connect/Lexus Enform Telematics Subscription Service Agreement for information on data collected and its usage.

 **CAUTION**

■ **General precautions while driving**

**Driving under the influence:** Never drive your vehicle when under the influence of alcohol or drugs that have impaired your ability to operate your vehicle. Alcohol and certain drugs delay reaction time, impair judgment and reduce coordination, which could lead to an accident that could result in death or serious injury.

**Defensive driving:** Always drive defensively. Anticipate mistakes that other drivers or pedestrians might make and be ready to avoid accidents.

**Driver distraction:** Always give your full attention to driving. Anything that distracts the driver, such as adjusting controls, talking on a cellular phone or reading can result in a collision with resulting death or serious injury to you, your occupants or others.

■ **General precaution regarding children's safety**

Never leave children unattended in the vehicle, and never allow children to have or use the key.

Children may be able to start the vehicle or shift the vehicle into neutral. There is also a danger that children may injure themselves by playing with the cigarette lighter, the windows, the moon roof, or other features of the vehicle. In addition, heat build-up or extremely cold temperatures inside the vehicle can be fatal to children.



## Symbols used throughout this manual

### Cautions & Notices

#### CAUTION

This is a warning against anything which may cause injury to people if the warning is ignored. You are informed about what you must or must not do in order to reduce the risk of injury to yourself and others.

#### NOTICE

This is a warning against anything which may cause damage to the vehicle or its equipment if the warning is ignored. You are informed about what you must or must not do in order to avoid or reduce the risk of damage to your Lexus and its equipment.

### Symbols used in illustrations



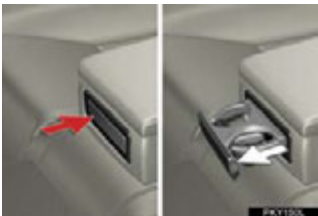

#### Safety symbol

The symbol of a circle with a slash through it means “Do not”, “Do not do this”, or “Do not let this happen.”



#### Arrows indicating operations

 Indicates the action (pushing, turning, etc.) used to operate switches and other devices.

 Indicates the outcome of an operation (e.g. a lid opens).



<b>1-1. Key information</b>		<b>1-4. Opening and closing the windows and moon roof</b>	
Keys .....	28	Power windows .....	80
<b>1-2. Opening, closing and locking the doors and trunk</b>		Moon roof .....	83
Smart access system with push-button start .....	33	<b>1-5. Refueling</b>	
Wireless remote control .....	45	Opening the fuel tank cap .....	87
Doors .....	48	<b>1-6. Theft deterrent system</b>	
Trunk .....	52	Engine immobilizer system .....	90
<b>1-3. Adjustable components (seats, mirrors, steering wheel)</b>		Alarm .....	92
Front seats .....	56	Theft prevention labels (U.S.A.) .....	95
Driving position memory .....	58	<b>1-7. Safety information</b>	
Head restraints .....	62	Correct driving posture .....	96
Seat belts .....	65	SRS airbags .....	98
Steering wheel (manually adjustable type) .....	72	Front passenger occupant classification system .....	109
Steering wheel (power-adjustable type) .....	73	Child restraint systems .....	114
Anti-glare inside rear view mirror .....	75	Installing child restraints .....	118
Outside rear view mirrors .....	77		

## 1-1. Key information

# Keys

### ■ Key with the wireless remote control function



#### 1 Electronic keys

- Operating the smart access system with push-button start (→P. 33)
- Operating the wireless remote control function (→P. 45)

#### 2 Mechanical keys

#### 3 Key number plate

### ■ Card key without the wireless remote control function (if equipped)



#### 1 Electronic key

Operating the smart access system with push-button start (→P. 33)

#### 2 Mechanical key

## Using the mechanical key



Take out the mechanical key.

The mechanical key can only be inserted in one direction, as the key only has grooves on one side. If the key cannot be inserted in a lock cylinder, turn it over and re-attempt to insert it.

After using the mechanical key, store it in the electronic key. Carry the mechanical key together with the electronic key. If the electronic key battery is depleted or the entry function does not operate properly, you will need the mechanical key. (→P. 505)

1

Before driving

### ■ Card key

- The mechanical key that is stored inside the card key should be used only if a problem arises, such as when the key does not operate properly.
- If it is difficult to take out the mechanical key, push down the lock release button using a pen tip etc. If it is difficult to pull it out, use a coin etc.



- To store the mechanical key in the card key, insert it inside while pressing the lock release button.



- If the battery was removed, reinstall the battery with the positive terminal facing the Lexus emblem.

- The card key is not waterproof.

### ■ When required to leave a key to the vehicle with a parking attendant

Turn the trunk opener main switch off and lock the glove box as circumstances demand. (→P. 52, 330)

Remove the mechanical key for your own use and provide the attendant with the electronic key only.

### ■ Key number plate

Keep the plate in a safe place, not in the vehicle. In the event that a mechanical key is lost, a new key can be made at your Lexus dealer using the key number plate.

(→P. 504)

### ■ When riding in an aircraft

When bringing an electronic key onto an aircraft, make sure you do not press any buttons on the electronic key while inside the aircraft cabin. If you are carrying an electronic key in your bag etc, ensure that the buttons are not likely to be pressed accidentally. Pressing a button may cause the electronic key to emit radio waves that could interfere with the operation of the aircraft.

 NOTICE**■ To prevent key damage**

Observe the following.

- Do not drop the keys, subject them to strong shocks or bend them.
- Do not expose the keys to high temperatures for a long period of time.
- Do not get the keys wet or wash them in an ultrasonic washer etc.
- Do not attach metallic or magnetic materials to the keys or place the keys close to such materials.
- Do not disassemble the electronic keys.
- Do not attach stickers that contain materials that block radio waves, such as metallic materials, to the key.
- Do not place the keys near objects that produce magnetic fields, such as TVs, audio systems, glass top ranges, or medical electrical equipment, such as low-frequency therapy equipment.

**■ Precautions for handling the card keys**

- Do not apply excess force when inserting the mechanical key to the card key. Doing so may damage the card key.
- If the battery or card key terminals get wet, the battery may corrode and the card key may stop working.  
If the key is dropped into water, or if drinking water etc. is spilled on the key, immediately remove the battery cover and wipe the battery and terminals. (To remove the battery cover, lightly grasp it and pull.) If the battery is corroded, have your Lexus dealer replace the battery.
- Do not crush the battery cover or use a screwdriver to remove the battery cover. Forcibly removing the battery cover may bend or damage the key.
- If the battery cover is frequently removed, the battery cover may become loose.
- When installing the battery, make sure to check the direction of the battery. Installing the battery in the wrong direction may cause the battery to deplete rapidly.

### NOTICE

- The surface of the card key may be damaged, or its coating may peel off in the following situations.
  - The card key is carried together with hard objects, such as coins or keys.
  - The card key is scraped with a sharp object, such as a tip of mechanical pencil.
  - The surface of the card key is wiped with thinners or benzene.

#### ■ Carrying the electronic key on your person

When carrying the key, maintain a distance of at least 3.9 in. (10 cm) from any of the following electrical appliances with their power on. If a distance of 3.9 in. (10 cm) is not kept, radio waves may be interfered with, causing the key to not function correctly.

- A portable radio, cellular phone, cordless phone or other wireless communication device
- Personal computers or personal digital assistants (PDAs)
- Digital audio players
- Portable game systems



## 1-2. Opening, closing and locking the doors and trunk Smart access system with push-button start

The following operations can be performed simply by carrying the electronic key (including the card key\*) on your person, for example in your pocket.

(The driver should always carry the electronic key.)

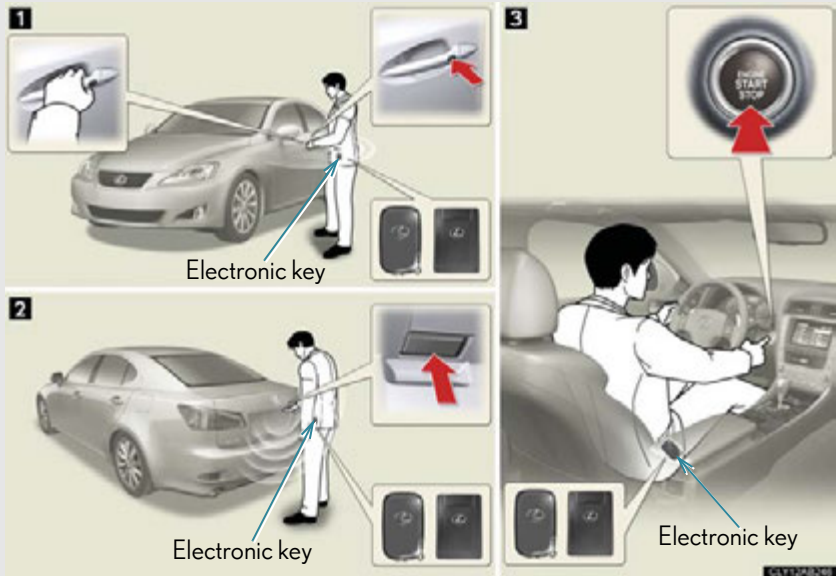

**1** Locks and unlocks the doors (→P. 34)

**2** Unlocks the trunk (→P. 34)

**3** Starts the engine (→P. 141)

\*: If equipped

1

Before driving

### Unlocking and locking the doors (front door handles only)



Grip the handle to unlock the door.

Make sure to touch the sensor on the back of the handle.

The door cannot be unlocked for 3 seconds after the door is locked.



Press the lock button to lock the door.

### Unlocking the trunk



Press the button to unlock the trunk.

## Antenna location and effective range

### ■ Antenna location

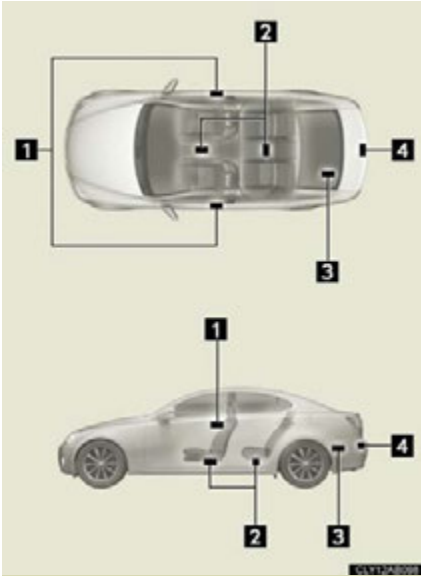

1 Antennas outside cabin

2 Antennas inside cabin

3 Antenna inside trunk

4 Antenna outside trunk

1

Before driving

■ Effective range (areas within which the electronic key is detected)

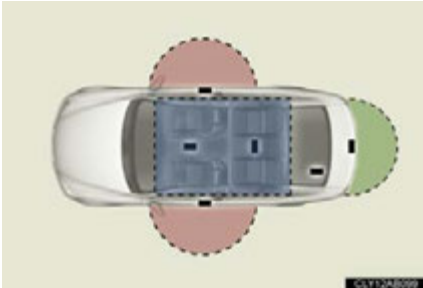

- When locking or unlocking the doors

The system can be operated when the electronic key is within about 2.3 ft. (70 cm) of either of the outside front door handles. (Only the doors detecting the key can be operated.)

- When unlocking the trunk

The system can be operated when the electronic key is within about 2.3 ft. (70 cm) of the trunk release button.

- When starting the engine or changing “ENGINE START STOP” switch modes

The system can be operated when the electronic key is inside the vehicle.

### ■ Operation signals

A buzzer sounds and the emergency flashers flash to indicate that the doors have been locked/unlocked. (Locked: Once; Unlocked: Twice)

### ■ Conditions affecting operation

The smart access system with push-button start uses weak radio waves. In the following situations, the communication between the electronic key and the vehicle may be affected, preventing the smart access system with push-button start from operating properly:





(Ways of coping: →P. 505)

- When the electronic key battery is depleted
- Near a TV tower, electric power plant, gas station, radio station, large display, airport or other facility that generates strong radio waves or electrical noise
- When carrying a portable radio, cellular phone, cordless phone or other wireless communication devices
- When the electronic key is in contact with, or is covered by the following metallic objects
  - Cards to which aluminum foil is attached
  - Cigarette boxes that have aluminum foil inside
  - Metallic wallets or bags
  - Coins
  - Hand warmers made of metal
  - Media such as CDs and DVDs
- When multiple electronic keys are in the vicinity
- When another wireless key (that emits radio waves) is being used nearby
- When carrying or using the electronic key together with the following devices that emit radio waves
  - Another vehicle's electronic key or a wireless key that emits radio waves
  - Personal computer or personal digital assistant (PDA)
  - Digital audio player
  - Portable game system
- If window tint with a metallic content or metallic objects are attached to the rear window



### ■ Switching the door unlock function

It is possible to set which doors the entry function unlocks.

**STEP 1** Turn the “ENGINE START STOP” switch OFF.

**STEP 2** When the indicator on the key surface is turned off, push and hold  ,  or  for approximately 5 seconds while pushing  on the key.

The setting changes each time an operation is performed, as shown below. (When changing the setting continuously, release the buttons, wait for at least 5 seconds, and repeat step 2.)

Multi-information display	Unlocking doors	Beep
	Hold the driver's door handle to unlock only the driver's door.	Exterior: Beeps three times Interior: Pings once
	Hold the front passenger's door handle to unlock all doors.	
	Hold either front door handle to unlock all doors.	Exterior: Beeps twice Interior: Pings once

To prevent unintended triggering of the alarm, unlock the doors using the electronic key and open and close a door once after the settings have been changed. (If a door is not opened within 60 seconds after  is pressed, the doors will be locked again and the alarm will automatically be set.)

In case that the alarm is triggered, immediately stop the alarm. (→P. 92)

### ■ Battery-saving function

In the following circumstances, the entry function is disabled in order to prevent the vehicle and electronic key batteries from discharging.

- When the entry function has not been used for a month or more
- When the electronic key has been left within approximately 3 ft. (1 m) of the vehicle for 10 minutes or more

The system will resume operation when

- The vehicle is locked using the door handle lock switch.
- The vehicle is locked/unlocked using the wireless remote control function. (→P. 45)
- The vehicle is locked/unlocked using the mechanical key. (→P. 505)

### ■ Electronic key battery depletion

- The standard battery life is 1 to 2 years. (The card key battery life is about a year and a half.)
- If the battery becomes low, an alarm will sound in the cabin when the engine stops. (→P. 488)
- The battery becomes depleted even if the electronic key is not used because the key always receives radio waves. If the smart access system with push-button start or the wireless remote control does not operate, or the detection area becomes smaller, the battery may be depleted. Replace the battery when necessary. (→ P. 433)
- To avoid serious deterioration, do not leave the electronic key within 3 ft. (1 m) of the following electrical appliances that produce a magnetic field.
  - TVs
  - Personal computers
  - Cellular phones, cordless phones and battery chargers
  - Recharging cellular phones or cordless phones
  - Glass top ranges
  - Table lamps

### ■ To operate the system properly

Make sure to carry the electronic key when operating the system. Do not get the electronic key too close to the vehicle when operating the system from the outside of the vehicle.

Depending on the position and holding condition of the electronic key, the key may not be detected correctly and the system may not operate properly. (The alarm may go off accidentally, or the door lock prevention may not function.)

### ■ Note for the entry function

- Even when the electronic key is within the effective range (detection areas), the system may not operate properly in the following cases.
  - The electronic key is too close to the window or outside door handle, near the ground, or in a high place when the doors are locked or unlocked.
  - The electronic key is near the ground or in a high place, or too close to the rear bumper center when the trunk is unlocked.
  - The electronic key is on the instrument panel, rear package tray or floor, or in the glove box when the engine is started or “ENGINE START STOP” switch modes are changed.
- Do not leave the electronic key on top of the instrument panel or near the door pockets when exiting the vehicle. Depending on the radio wave reception conditions, it may be detected by the antenna outside the cabin and the door will become lockable from the outside, possibly trapping the electronic key inside the vehicle.
- As long as the electronic key is within the effective range, the doors may be locked or unlocked by anyone.
- Even if the electronic key is not inside the vehicle, it may be possible to start the engine if the electronic key is near the window.
- The doors may unlock if a large amount of water splashes on the door handle, such as in the rain or in a car wash. (The doors will automatically be locked after approximately 60 seconds if the doors are not opened and closed.)
- Gripping the door handle when wearing a glove may not unlock the door.
- If the wireless remote control is used to lock the doors when the electronic key is near the vehicle, there is a possibility that the door may not be unlocked by the entry function. (Use the wireless remote control to unlock the doors.)
- A sudden approach to the effective range or door handle operation may prevent the doors from being unlocked. In this case, return the door handle to the original position and check that the doors unlock before pulling the door handle again.



### ■ When the vehicle is not driven for extended periods

To prevent theft of the vehicle, do not leave the electronic key within 6 ft. (2 m) of the vehicle.

### ■ Security feature

If a door is not opened within approximately 60 seconds after the vehicle is unlocked, the anti-theft system automatically locks the vehicle again.

### ■ Alarms and warning indicators

A combination of exterior and interior alarms as well as warnings displayed on the multi-information display is used to prevent theft of the vehicle and unforeseeable accidents resulting from erroneous operation. Take appropriate measures in response to any warning indications on the multi-information display. (→P. 481)

The following table describes circumstances and correction procedures when only alarms are sounded.

Alarm	Situation	Correction procedure
Exterior alarm sounds once for 2 seconds	Tried to lock the doors using the entry function while the electronic key is still inside the passenger compartment	Retrieve the electronic key from the passenger compartment and lock the doors again.
	Closed the trunk while the electronic key is still inside and all doors are locked	Retrieve the electronic key from the trunk and close the trunk lid.
Exterior alarm sounds once for 60 seconds	Tried to exit the vehicle with the electronic key and lock the doors without first turning the "ENGINE START STOP" switch OFF	Turn the "ENGINE START STOP" switch OFF and lock the doors again.
Exterior alarm sounds once for 10 seconds	Tried to lock the vehicle using the entry function while a door is open	Close all of the doors and lock the doors again.
Interior alarm sounds continuously*	Tried to open the door and exit the vehicle without shifting the shift lever to P	Shift the shift lever to P.

Alarm	Situation	Correction procedure
Interior alarm pings continuously	Switched to ACCESSORY mode while the driver's door is open (Opened the driver's door when the "ENGINE START STOP" switch is in ACCESSORY mode.)	Close the driver's door.
	Turned the "ENGINE START STOP" switch OFF while the driver's door is open	Close the driver's door.

\*: Vehicles with an automatic transmission only

### ■ If the smart access system with push-button start does not operate properly

- Locking and unlocking the doors and trunk: Use the mechanical key. (→P. 505)
- Starting the engine: →P. 505

### ■ When the electronic key battery is fully depleted

→P. 433

### ■ Customization that can be configured at Lexus dealer

It is possible to deactivate the operation signals of the system, such as the emergency flashers. (Customizable features →P. 553)

### ■ Certification for the smart access system with push-button start

▶ For vehicles sold in the U.S.A.

FCC ID: NI4TMLF-1

FCC ID: HYQ14AAB

FCC ID: HYQ14AEM

FCC ID: HYQ14ABB

FCC ID: HYQ13BZH

FCC ID: HYQ14ABK

FCC ID: HYQ14ABS

FCC ID: HYQ13BZW

### NOTE:

This device complies with part 15 of the FCC Rules. Operation is subject to the following two conditions: (1) This device may not cause harmful interference, and (2) this device must accept any interference received, including interference that may cause undesired operation.

### FCC WARNING:

Changes or modifications not expressly approved by the party responsible for compliance could void the user's authority to operate the equipment.

► For vehicles sold in Canada

### NOTE:

Operation is subject to the following two conditions: (1) this device may not cause interference, and (2) this device must accept any interference, including interference that may cause undesired operation of the device.

### NOTE:

L'utilisation de ce dispositif est autorisée seulement aux deux conditions suivantes: (1) il ne doit pas produire de brouillage, et (2) l'utilisateur du dispositif doit être prêt à accepter tout brouillage radioélectrique reçu, même si ce brouillage est susceptible de compromettre le fonctionnement du dispositif.

### CAUTION

#### ■ Caution regarding interference with electronic devices

- People with implanted pacemakers or cardiac defibrillators should keep away from the smart access system antennas. (→P. 35)

The radio waves may affect the operation of such devices. If necessary, the entry function can be disabled. Ask your Lexus dealer for details, such as the frequency of radio waves and timing of emitting the radio waves. Then, consult your doctor to see if you should disable the entry function.

- User of any electrical medical device other than implanted pacemakers and implanted cardiac defibrillators should consult the manufacturer of the device for information about its operation under the influence of radio waves.

Radio waves could have unexpected effects on the operation of such medical devices.

Ask your Lexus dealer for details for disabling the entry function.

## 1-2. Opening, closing and locking the doors and trunk

# Wireless remote control

The wireless remote control can be used to lock and unlock the vehicle and the trunk from outside the vehicle.



- 1 Locks all doors
- 2 One short press: Unlocks all doors  
Press and hold: Opens the windows and moon roof\*
- 3 Unlocks the trunk (press and hold)
- 4 Sounds alarm (press and hold) (→P. 46)

\*: This setting must be customized at your Lexus dealer.

### ■ Operation signals

Doors: A buzzer sounds and the emergency flashers flash to indicate that the doors have been locked/unlocked. (Locked: Once; Unlocked: Twice)

Trunk: A buzzer sounds to indicate that the trunk has been unlocked.

Windows and moon roof: A buzzer sounds to indicate that the windows and moon roof are operating.

### ■ Door lock buzzer

If a door is not fully closed, a buzzer sounds if an attempt to lock the door is made. Fully close the door to stop the buzzer, and lock the vehicle once more.

### ■ Alarm

Using the wireless remote control to lock the doors will set the alarm system.

### ■ Panic mode



When  is pushed for longer than about one second, an alarm will sound for about 60 seconds and the vehicle lights will flash to deter any person from trying to break into or damage your vehicle.

To stop the alarm, push any button on the wireless remote control.

### ■ Electronic key battery depletion

→P. 39

### ■ When the electronic key battery is fully depleted

→P. 433

### ■ Security feature

→P. 41

### ■ Conditions affecting operation

→P. 37

### ■ Customization that can be configured at Lexus dealer

Settings (e.g. trunk unlocking function) can be changed.  
(Customizable features →P. 553)

### ■ Certification for wireless remote control

- ▶ For vehicles sold in the U.S.A.

FCC ID: HYQ14AAB

FCC ID: HYQ14AEM

FCC ID: HYQ14ABB

FCC ID: HYQ13BZH

FCC ID: HYQ14ABK

FCC ID: HYQ14ABS

FCC ID: HYQ13BZW

NOTE:

This device complies with part 15 of the FCC Rules. Operation is subject to the following two conditions: (1) This device may not cause harmful interference, and (2) this device must accept any interference received, including interference that may cause undesired operation.

FCC WARNING:

Changes or modifications not expressly approved by the party responsible for compliance could void the user's authority to operate the equipment.

- ▶ For vehicles sold in Canada

NOTE:

Operation is subject to the following two conditions: (1) this device may not cause interference, and (2) this device must accept any interference, including interference that may cause undesired operation of the device.

NOTE:

L'utilisation de ce dispositif est autorisée seulement aux deux conditions suivantes: (1) il ne doit pas produire de brouillage, et (2) l'utilisateur du dispositif doit être prêt à accepter tout brouillage radioélectrique reçu, même si ce brouillage est susceptible de compromettre le fonctionnement du dispositif.

## 1-2. Opening, closing and locking the doors and trunk

### Doors

The vehicle can be locked and unlocked using the entry function, wireless remote control or door lock switch.

#### ■ Entry function

→P. 34

#### ■ Wireless remote control

→P. 45

#### ■ Door lock switch



1 Locks all doors

2 Unlocks all doors

#### ■ Inside lock button



1 Locks the door

2 Unlocks the door

The front doors can be opened by pulling the inside handle even if the lock buttons are in the lock position.



### Locking the front doors from the outside without a key

The door cannot be locked if the “ENGINE START STOP” switch is in ACCESSORY or IGNITION ON mode, or the electronic key is left inside the vehicle.

Depending on the position of the electronic key, the key may not be detected correctly and the door may be locked.

### Rear door child-protector lock



The door cannot be opened from inside the vehicle when the locks are set.

These locks can be set to prevent children from opening the rear doors. Push down on each rear door switch to lock both rear doors.

### Automatic door locking and unlocking systems

The following functions can be set or cancelled:

Function	Operation
Shift position linked door locking function*	Shifting the shift lever out of P locks all doors.
Shift position linked door unlocking function*	Shifting the shift lever to P unlocks all doors.
Speed linked door locking function	All doors are locked when the vehicle speed is approximately 12 mph (20 km/h) or higher.
Driver's door linked door unlocking function	All doors are unlocked when the driver's door is opened within approximately 45 seconds after turning the “ENGINE START STOP” switch OFF.



\*: Vehicles with an automatic transmission only

### ■ Setting and canceling the functions

To switch between setting and canceling, follow the procedure below:





**STEP 1** Close all the doors and switch the “ENGINE START STOP” switch to IGNITION ON mode. (Perform the step 2 within 10 seconds.)



Shift the shift lever to P or N, press and hold the driver's door lock switch (  or  ) for about 5 seconds then release.

The shift lever and switch positions corresponding to the desired function to be set are shown as follows.

Use the same procedure to cancel the function.

Function	Shift lever position	Driver's door lock switch position
Shift position linked door locking function*	P	
Shift position linked door unlocking function*		
Speed linked door locking function	N	
Driver's door linked door unlocking function		

\*: Vehicles with an automatic transmission only

When the setting or canceling operation is complete, all doors are locked and then unlocked.

### ■ Impact detection door lock release system

In the event that the vehicle is subject to a strong impact, all the doors are unlocked. Depending on the force of the impact or the type of accident, however, the system may not operate.

### ■ Using the mechanical key

The doors can also be locked and unlocked with the mechanical key. (→P. 505)

### ■ Customization that can be configured at Lexus dealer

Settings (e.g. unlocking function using a key) can be changed.  
(Customizable features →P. 553)

## CAUTION

### ■ To prevent an accident

Observe the following precautions while driving the vehicle.

Failing to do so may result in a door opening and an occupant falling out, resulting in death or serious injury.

- Always use a seat belt.
- Always lock all doors.
- Ensure that all doors are properly closed.
- Do not pull the inside handle of the doors while driving.  
The doors may be opened and the passengers may be thrown out of the vehicle, resulting in death or serious injury.

Be especially careful for the front doors, as the doors may be opened even if the inside lock buttons are in locked position.

- Set the rear door child protector locks when children are seated in the rear seat.

## 1-2. Opening, closing and locking the doors and trunk

### Trunk

The trunk can be opened using the trunk opener, entry function or wireless remote control.

#### ■ Opening the trunk from inside the vehicle



Press the opener switch.

#### ■ Opening the trunk from outside the vehicle

##### ▶ Entry function

→P. 34

##### ▶ Wireless remote control

→P. 45

### Locking the trunk opener feature

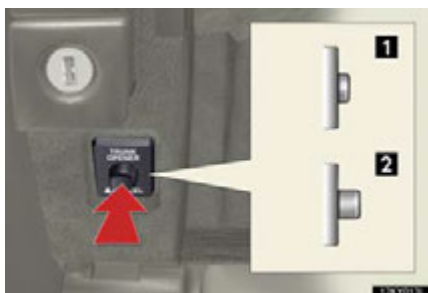

Turn the trunk opener main switch in the glove box off to disable the trunk opener.

1 On

2 Off

The trunk lid cannot be opened even with the wireless remote control or the entry function.

### ■ Trunk light

When the trunk light switch is set to on, the trunk light turns on when the trunk is opened.

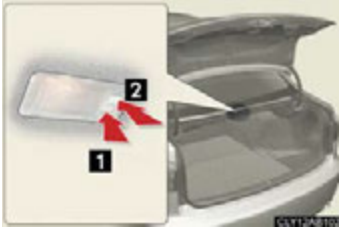

1 On

2 Off

### ■ Trunk handle



Use the trunk handle when closing the trunk.

### ■ Internal trunk release lever



The trunk lid can be opened by pulling down on the glow-in-the-dark lever located on the inside of the trunk lid.

The lever will continue to glow for some time after the trunk lid is closed.

### ■ Using the mechanical key

The trunk can be also opened using the mechanical key. (→P. 505)

### ■ Which key to the vehicle is to leave with a parking attendant after disabling the trunk opener main switch

→P. 30

### CAUTION

#### ■ Caution while driving

- Keep the trunk lid closed while driving.

If the trunk lid is left open, it may hit near-by objects while driving or luggage in the trunk may be unexpectedly thrown out, causing an accident.

In addition, exhaust gases may enter the vehicle, causing death or a serious health hazard. Make sure to close the trunk lid before driving.

- Before driving the vehicle, make sure that the trunk lid is fully closed. If the trunk lid is not fully closed, it may open unexpectedly while driving, causing an accident.
- Never let anyone sit in the trunk. In the event of sudden braking or a collision, they are susceptible to death or serious injury.

#### ■ When children are in the vehicle

Observe the following precautions.

Failure to do so may result in death or serious injury.

- Do not allow children to enter the trunk.

If a child is accidentally locked in the trunk, they could overheat or suffocate.

- Do not allow a child to open or close the trunk lid.

Doing so may cause the trunk lid to operate unexpectedly, or cause the child's hands, head, or neck to be caught by the closing trunk lid.

**! CAUTION****■ Using the trunk**

Observe the following precautions.

Failure to do so may cause parts of the body to be caught, resulting in serious injury.

- Remove any heavy loads, such as snow and ice, from the trunk lid before opening it. Failure to do so may cause the trunk lid to fall closed again after it is opened.
- When opening or closing the trunk lid, thoroughly check to make sure the surrounding area is safe.
- If anyone is in the vicinity, make sure they are safe and let them know that the trunk is about to open or close.
- Use caution when opening or closing the trunk lid in windy weather as it may move abruptly in strong wind.



- The trunk lid may fall if it is not opened fully. It is more difficult to open or close the trunk lid on an incline than on a level surface, so beware of the trunk lid unexpectedly opening or closing by itself. Make sure that the trunk lid is fully open and secure before using the trunk.
- When closing the trunk lid, take extra care to prevent your fingers etc. from being caught.
- When closing the trunk lid, make sure to press it lightly on its outer surface. If the trunk handle is used to fully close the trunk lid, it may result in hands or arms being caught.
- Do not attach any accessories other than genuine Lexus parts to the trunk lid. Such additional weight on the trunk lid may cause the lid to fall closed again after it is opened.

## 1-3. Adjustable components (seats, mirrors, steering wheel)

### Front seats

#### ► Manual seat



- 1 Seat position lever
- 2 Seatback angle lever
- 3 Vertical height adjustment lever
- 4 Seat cushion (front) angle knob



## ► Power seat

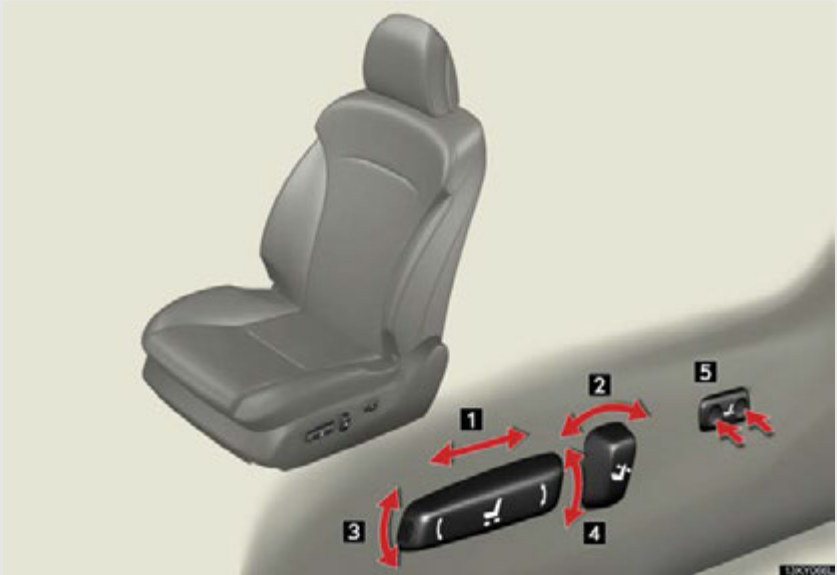

- 1 Seat position switch
- 2 Seatback angle switch
- 3 Seat cushion (front) angle switch
- 4 Vertical height adjustment switch
- 5 Lumbar support switch (driver's seat only)

**CAUTION**
**■ Seat adjustment**

- Do not recline the seat more than necessary when the vehicle is in motion to reduce the risk of sliding under the lap belt.  
If the seat is too reclined, the lap belt may slide past the hips and apply restraint forces directly to the abdomen or your neck may contact the shoulder belt, increasing the risk of death or serious injury in the event of an accident.
- Manual seat only: After adjusting the seat, make sure that the seat is locked in position.

## 1-3. Adjustable components (seats, mirrors, steering wheel)

### Driving position memory (driver's seat)\*

Your preferred driving position (the position of the driver's seat, steering wheel and outside rear view mirrors) can be memorized and recalled with the touch of a button. It is also possible to set this function to activate automatically when the doors are unlocked.

Three different driving positions can be entered into memory.

#### ■ Entering a position to memory

**STEP 1** Switch to IGNITION ON mode.

**STEP 2** Adjust the driver's seat, steering wheel, and outside rear view mirrors to the desired positions.

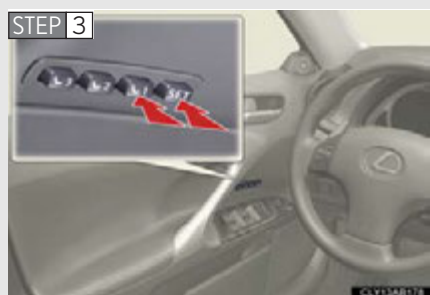

Push the "SET" button, then within 3 seconds push button "1", "2" or "3" until the signal beeps.

If the selected button has already been preset, the previously recorded position will be overwritten.

\*: If equipped

### ■ Recalling the memorized position

Vehicles with an automatic transmission: Check that the shift lever is set in P.

Vehicles with a manual transmission: Check that the parking brake is set.

**STEP 1** Switch to IGNITION ON mode.

**STEP 2**



Push button "1", "2" or "3" to recall the memorized position.

1

Before driving

### Linking driving position memory with door unlock operation

Record your driving position to button "1", "2" or "3" before performing the following.

Carry only the key (including the card key<sup>\*</sup>) to which you want to link the driving position. If 2 or more keys are in the vehicle, the driving position cannot be linked properly.

\*: If equipped

► Using the wireless remote control

**STEP 1** Turn the “ENGINE START STOP” switch OFF and close the driver's door.

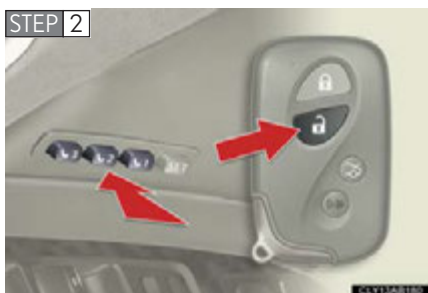

While the desired button (“1”, “2” or “3”) press  on the wireless remote control until the signal beeps.

The driving position is recalled when the driver's door is unlocked using the entry function or wireless remote control and the driver's door is opened.

To prevent unintended triggering of the alarm, open and close a door once after a driving position has been recorded. (If a door is not opened within 60 seconds after  is pressed, the doors will be locked again and the alarm will automatically be set.)

In case that the alarm is triggered, immediately stop the alarm. (→P. 92)

► Using the door lock switch

**STEP 1** Turn the “ENGINE START STOP” switch OFF and close the driver's door.

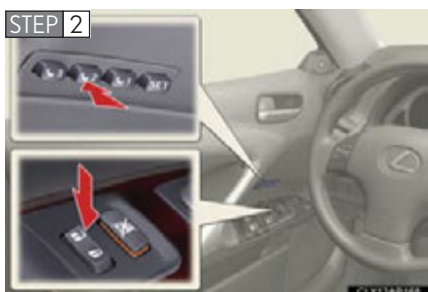

While pressing the desired button (“1”, “2” or “3”), press the lock or unlock side on the driver's door lock switch until the signal beeps.

The driving position is recalled when the driver's door is unlocked using the entry function or wireless remote control and the driver's door is opened.

### ■ Canceling the linked door unlock operation

**STEP 1** Turn the “ENGINE START STOP” switch OFF and close the driver's door.

**STEP 2** Using the wireless remote control: While pushing the “SET” button, press  on the wireless remote control until the signal beeps.  
Using the door lock switch: While pressing the “SET” button, press the lock or unlock side on the door lock switch until the signal beeps.

### ■ Operating the driving position memory after turning the “ENGINE START STOP” switch OFF

Memorized positions (except for the steering wheel position) can be activated up to 180 seconds after the driver's door is opened and another 60 seconds after it is closed again, even after turning the “ENGINE START STOP” switch OFF.

### ■ To cancel seat position recall

Perform any of the following operations.

- Push the “SET” button.
- Push button “1”, “2” or “3”.
- Adjust the seat using the switches (only cancels seat position recall).

### ■ If the battery is disconnected

The memorized positions are erased when the battery is disconnected.

## CAUTION

### ■ Seat adjustment caution

Take care during seat adjustment that the seat does not strike the rear passenger or squeeze your body against the steering wheel.

## 1-3. Adjustable components (seats, mirrors, steering wheel)

### Head restraints

Head restraints are provided for all seats.

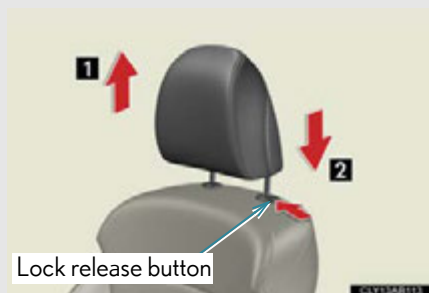

Vertical adjustment

#### 1 Up

Pull the head restraints up.

#### 2 Down

Front and center rear seats:  
Push the head restraint down while pushing the lock release button.



Folding operation (outside rear seats only)

To stow the head restraint by folding it forward, pull the head restraint up while pushing the lock release button. Only the button on the right stay (when facing the front of the vehicle) can be used to fold the head restraint forward.

#### ■ Removing the head restraints (front seats)



Pull the head restraint up while pushing the lock release button.

■ Installing the head restraints (front seats)



Align the head restraint with the installation holes and push it down to the lock position.

Press and hold the lock release button when lowering the head restraint.

■ Removing the head restraint (center rear seat)

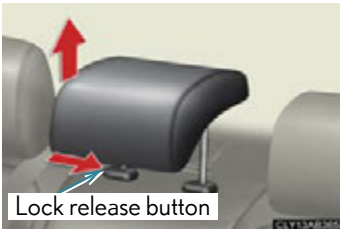

Pull the head restraint up while pushing the lock release button.

■ Installing the head restraint (center rear seat)



Align the head restraint with the installation holes and push it down to the lock position.

Press and hold the lock release button when lowering the head restraint.

■ Removing the head restraints (outside rear seats)

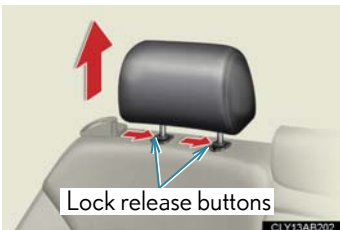

Pull the head restraint up while pushing both of the lock release buttons.

### ■ Installing the head restraints (outside rear seats)



Align the head restraint with the installation holes and push it down to the lock position.

### ■ Adjusting the height of the head restraints

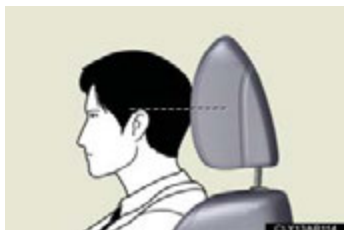

Make sure that the head restraints are adjusted so that the center of the head restraint is closest to the top of your ears.

### ■ When using the rear seat head restraints

Center rear seat: Always raise the head restraint one level from the stowed position when using.

Outside rear seats: Make sure the head restraints are not in the stowed/folded position while in use.

### ⚠ CAUTION

#### ■ Head restraint precautions

Observe the following precautions regarding the head restraints. Failure to do so may result in death or serious injury.

- Use the head restraints designed for each respective seat.
- Adjust the head restraints to the correct position at all times.
- After adjusting the head restraints, push down on them and make sure they are locked in position.
- Do not drive with the head restraints removed.



## Seat belts

Make sure that all occupants are wearing their seat belts before driving the vehicle.

### ■ Correct use of the seat belts



- Extend the shoulder belt so that it comes fully over the shoulder, but does not come into contact with the neck or slide off the shoulder.
- Position the lap belt as low as possible over the hips.
- Adjust the position of the seatback. Sit up straight and well back in the seat.
- Do not twist the seat belt.

### ■ Fastening and releasing the seat belt

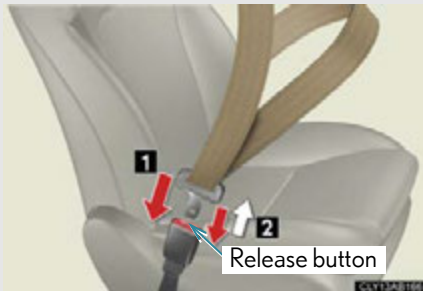

- 1** Fastening the belt  
Push the tab into the buckle until a clicking sound is heard.
- 2** Releasing the belt  
Press the release button.

### ■ Adjusting the height of the belt (front seats)

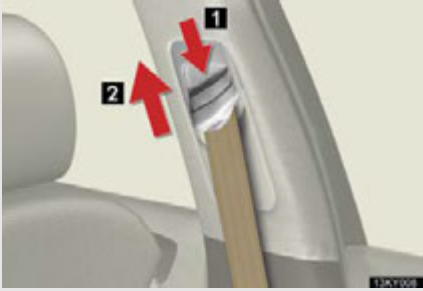

1 Down

2 Up

Move the height adjuster up and down as needed until you hear a click.

### Seat belt comfort guide (outside rear seats)

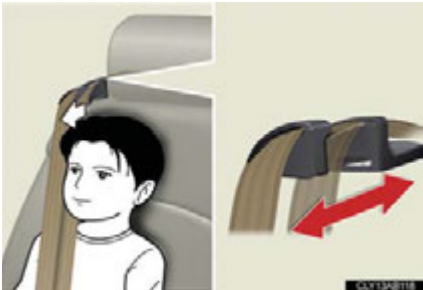

If the shoulder belt sits close to a person's neck, slide the seat belt comfort guide forward.

### Seat belt pretensioners (front and outside rear seats)



The pretensioner helps the seat belt to quickly restrain the occupant by retracting the seat belt when the vehicle is subjected to certain types of severe frontal collision.

The pretensioner may not activate in the event of a minor frontal impact, a side impact or a rear impact.

### ■ Emergency locking retractor (ELR)

The retractor will lock the belt during a sudden stop or on impact. It may also lock if you lean forward or pull out the belt too quickly. Allow the belt to fully retract, and then slowly extend the belt. If the belt cannot be pulled out of the retractor, firmly pull the belt and release it. You will then be able to smoothly pull the belt out of the retractor.

### ■ Automatic locking retractor (ALR)

When a passenger's shoulder belt is completely extended and then retracted even slightly, the belt is locked in that position and cannot be extended. This feature is used to hold the child restraint system (CRS) firmly. To free the belt again, fully retract the belt and then pull the belt out once more. (→P. 118)

### ■ Pregnant women

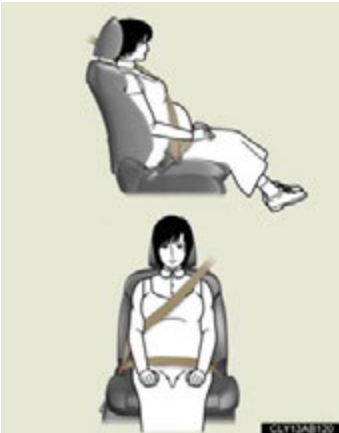

Obtain medical advice and wear the seat belt in the proper way. (→P. 65)

Women who are pregnant should position the lap belt as low as possible over the hips in the same manner as other occupants. Extend the shoulder belt completely over the shoulder and position the belt across the chest. Avoid belt contact over the rounding of the abdominal area.

If the seat belt is not worn properly, not only a pregnant woman, but also the fetus could suffer death or serious injury as a result of sudden braking or a collision.

### ■ People suffering illness

Obtain medical advice and wear the seat belt in the proper way.

### ■ Child seat belt usage

The seat belts of your vehicle are principally designed for persons of adult size.

- Use a child restraint system appropriate for the child, until the child becomes large enough to properly wear the vehicle's seat belt. (→P. 114)
- When the child becomes large enough to properly wear the vehicle's seat belt, follow the instructions on P. 65 regarding seat belt usage.

### ■ Replacing the belt after the pretensioner has been activated

If the vehicle is involved in multiple collisions, the pretensioner will activate for the first collision, but will not activate for the second or subsequent collisions.

### ■ Seat belt extender



If your seat belts cannot be fastened securely because they are not long enough, a personalized seat belt extender is available from your Lexus dealer free of charge.

 **CAUTION**

Observe the following precautions to reduce the risk of injury in the event of sudden braking, sudden swerving or an accident.

Failing to do so may cause death or severe injury.

**■ Wearing a seat belt**

- Ensure that all passengers wear a seat belt.
- Always wear a seat belt properly.
- Each seat belt should be used by one person only. Do not use a seat belt for more than one person at once, including children.
- Lexus recommends that children be seated in the rear seat and always use a seat belt and/or an appropriate child restraint system.
- Do not recline the seat any more than necessary to achieve a proper seating position. The seat belt is most effective when the occupants are sitting up straight and well back in the seats.
- Do not wear the shoulder belt under your arm.
- Always wear your seat belt low and snug across your hips.

**■ When children are in the vehicle**

Do not allow children to play with the seat belt. If the seat belt becomes twisted around a child's neck, it may lead to choking or other serious injuries that could result in death.

If this occurs and the buckle cannot be unfastened, scissors should be used to cut the belt.

**■ Adjustable shoulder anchor**

Always make sure the shoulder belt is positioned across the center of your shoulder. The belt should be kept away from your neck, but not falling off your shoulder. Failure to do so could reduce the amount of protection in an accident and cause death or serious injuries in the event of a sudden stop, sudden swerve or accident. (→P. 66)

### CAUTION

#### ■ Seat belt pretensioners

- Do not place anything, such as a cushion, on the front passenger's seat. Doing so will disperse the passenger's weight, which prevents the sensor from detecting the passenger's weight properly. As a result, the seat belt pretensioner for the front passenger's seat may not activate in the event of a collision.
- If the pretensioner has activated, the SRS warning light will come on. In that case, the seat belt cannot be used again and must be replaced at your Lexus dealer.

#### ■ Seat belt damage and wear

Inappropriate handling of the pretensioner may prevent it from operating properly resulting in death or serious injury.

- Do not damage the seat belts by allowing the belt, plate, or buckle to be jammed in the door.
- Inspect the seat belt system periodically. Check for cuts, fraying, and loose parts. Do not use a damaged seat belt until it is replaced. Damaged seat belts cannot protect an occupant from death or serious injury.
- Ensure that the belt and tab are locked and the belt is not twisted. If the seat belt does not function correctly, immediately contact your Lexus dealer.
- Replace the seat assembly, including the belts, if your vehicle has been involved in a serious accident, even if there's no obvious damage.
- Do not attempt to install, remove, modify, disassemble or dispose of the seat belts. Have any necessary repairs carried out by your Lexus dealer.

#### ■ Using a seat belt extender

- Do not wear the seat belt extender if you can fasten the seat belt without the extender.
- Do not use the seat belt extender when installing a child restraint system because the belt will not securely hold the child restraint system, increasing the risk of death or serious injury in the event of an accident.
- The personalized extender may not be safe on another vehicle, when used by another person, or at a different seating position other than the one originally intended.

 CAUTION

■ **Using a seat belt comfort guide**

Failure to observe the following precautions could reduce the effectiveness of the seat belt in an accident, causing death or serious injury.

Always make sure the shoulder belt is positioned across the center of the shoulder. The belt should be kept away from the neck, and should not fall off the shoulder.

 NOTICE

■ **When using a seat belt extender**

When releasing the seat belt, press on the buckle release button on the extender, not on the seat belt.

This helps prevent damage to the vehicle interior and the extender itself.

## 1-3. Adjustable components (seats, mirrors, steering wheel)

### Steering wheel (manually adjustable type)

The steering wheel can be adjusted to a comfortable position.

STEP 1



Hold the steering wheel and press the lever down.

STEP 2



Adjust to the ideal position by moving the steering wheel horizontally and vertically.

After adjustment, pull the lever up to secure the steering wheel.

#### CAUTION

##### ■ Caution while driving

Do not adjust the steering wheel while driving.

Doing so may cause the driver to mishandle the vehicle and an accident, resulting in death or serious injury.

##### ■ After adjusting the steering wheel

Make sure that the steering wheel is securely locked.

Otherwise, the steering wheel may move suddenly, possibly causing an accident.



# 1-3. Adjustable components (seats, mirrors, steering wheel)

## Steering wheel (power-adjustable type)

The steering wheel can be adjusted to a comfortable position.

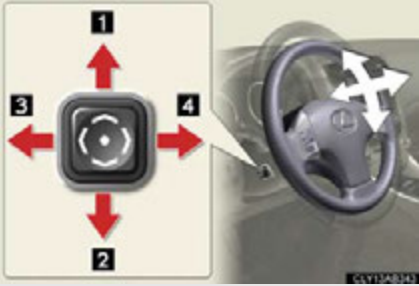

- 1 Up
- 2 Down
- 3 Away from the driver
- 4 Toward the driver

1  
Before driving

### Auto tilt away



When the “ENGINE START STOP” switch is turned OFF, the steering wheel returns to its stowed position by moving up and away to enable easier driver entry and exit.

Switching to ACCESSORY or IGNITION ON mode will return the steering wheel to the original position.

### ■ The steering wheel can be adjusted when

The "ENGINE START STOP" switch is in ACCESSORY or IGNITION ON mode.

### ■ Automatic adjustment of the steering position (vehicles with driving position memory)

A desired steering position can be entered to memory and recalled automatically by the driving position memory. (→P. 58)

### ■ Customization that can be configured at Lexus dealer

It is possible to deactivate the auto tilt-away function.  
(Customizable features→P. 553)

## CAUTION

### ■ Caution while driving

Do not adjust the steering wheel while driving.

Doing so may cause the driver to mishandle the vehicle and cause an accident, resulting in death or serious injury.

## Anti-glare inside rear view mirror

In automatic mode, sensors are used to detect the headlights of vehicles behind and automatically reduce the reflected light.

► Vehicles without compass

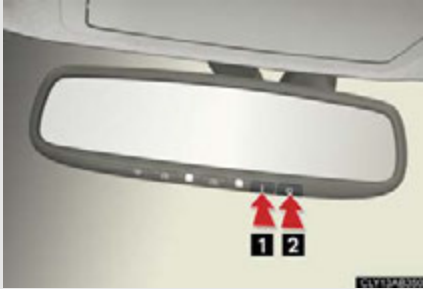

- 1 Turns automatic mode on
- 2 Turns automatic mode off

The indicator comes on when automatic mode is turned on.

The anti-glare mirror default mode is automatic. The anti-glare mirror is automatically set to automatic whenever the “ENGINE START STOP” switch is turned to IGNITION ON mode.

► Vehicles with compass

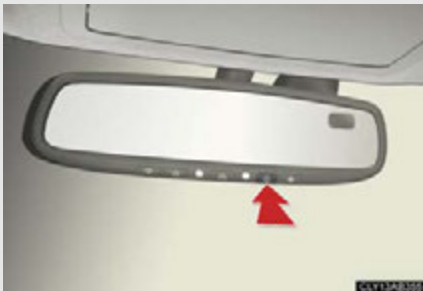

Turns automatic mode on/off

The indicator comes on when automatic mode is turned on.

The anti-glare mirror default mode is automatic. The anti-glare mirror is automatically set to automatic whenever the “ENGINE START STOP” switch is turned to IGNITION ON mode.

### Adjusting the height of rear view mirror



Adjust the height of the rear view mirror by moving it up and down.

#### ■ To prevent sensor error



To ensure that the sensors operate properly, do not touch or cover them.

### ⚠ CAUTION

#### ■ Caution while driving

Do not adjust the position of the mirror while driving. Doing so may lead to mishandling of the vehicle and an accident, resulting in death or serious injury.

## Outside rear view mirrors

Mirror angle can be adjusted using the switch.



- 1 Select a mirror to adjust (“L”: left or “R”: right)
- 2 Adjust the mirror up, down, in, or out using the switch

1

Before driving

### ■ The mirrors can be adjusted when

The “ENGINE START STOP” switch is in ACCESSORY or IGNITION ON mode.

### ■ When the mirrors are fogged up

Turn on the mirror defoggers to defog the mirrors. (→P. 224)

### ■ Folding back the mirrors



Push back in the direction of the vehicle's rear.

### ■ One-touch adjustment of the mirror angle (vehicles with driving position memory)

A desired mirror face angle can be entered to memory and adjusted with the touch of a button. (→P. 58)

### ■ **Linked mirror function when reversing (vehicles with driving position memory)**

The outside rear view mirrors will automatically angle downwards when the vehicle is reversing in order to give a better view of the ground. However, this function will not operate when the mirror select switch is in the neutral position (between "L" and "R").

### ■ **Auto anti-glare function (if equipped)**

When the anti-glare inside rear view mirror is set to automatic mode, the outside rear view mirrors will activate in conjunction with the anti-glare inside rear view mirror to reduce reflected light. (→P. 75)

### ■ **Rain clearing mirrors (if equipped)**

When water droplets collect on the mirror surface, for example when it rains, the rain clearing (hydrophilic) effect of the mirrors causes the droplets to be spread out into a film making the rear view clearer. In the following cases, the rain clearing effect will be reduced temporarily, but will return after 1 or 2 days' exposure to direct sunlight.

- After wiping dirt off the mirrors
- When the mirrors fog up
- After waxing your vehicle in an automatic car wash
- After your vehicle has been parked for a long period in underground parking lots, etc. where there is no direct sunlight

 CAUTION**■ When driving the vehicle**

Observe the following precautions while driving.

Failing to do so may result in loss of control of the vehicle and cause an accident, resulting in death or serious injury.

- Do not adjust the mirrors while driving.
- Do not drive with the mirrors folded back.
- Both the driver and passenger side mirrors must be extended and properly adjusted before driving.

**■ When the mirror defoggers are operating**

Do not touch the rear view mirror surfaces, as they can become very hot and burn you.

 NOTICE**■ If the mirrors become iced up**

In order to retain the rain-clearing properties of the mirror, do not attempt to scrape the ice off. Instead, remove it by turning on the mirror defoggers or by applying warm water.

## 1-4. Opening and closing the windows and moon roof

### Power windows

The power windows can be opened and closed using the following switches.



- 1 Closing
- 2 One-touch closing\*
- 3 Opening
- 4 One-touch opening\*

\*: Pushing the switch in the opposite direction will stop window travel partway.

### Lock switch



Press the switch down to lock the passenger window switches.

Use this switch to prevent children from accidentally opening or closing a passenger window.

The passenger windows can still be opened and closed using the driver's switch even if the lock switch is on.



**■ The power windows can be operated when**

The “ENGINE START STOP” switch is in IGNITION ON mode.

**■ Operating the power windows after turning the “ENGINE START STOP” switch OFF**

The power windows can be operated for approximately 45 seconds even after the “ENGINE START STOP” switch is switched to ACCESSORY mode or turned OFF. They cannot, however, be operated once either front door is opened.

**■ Jam protection function**

If an object becomes caught between the window and the window frame, window travel is stopped and the window is opened slightly.

**■ When the power window does not close normally**

If the jam protection function is operating abnormally and a window cannot be closed, perform the following operations using the power window switch on the relevant door.

- After stopping the vehicle, the window can be closed by holding the power window switch in the one-touch closing position while the “ENGINE START STOP” switch is turned to IGNITION ON mode.
- If the window still cannot be closed even by carrying out the operation explained above, initialize the function by performing the following procedure.

**STEP 1** Hold the power window switch in the one-touch closing position. Continue holding the switch for a further 6 seconds after the window has closed.

**STEP 2** Hold the power window switch in the one-touch opening position. Continue holding the switch for a further 2 seconds after the window has opened completely.

**STEP 3** Hold the power window switch in the one-touch closing position once again. Continue holding the switch for a further 2 seconds after the window has closed.

If you release the switch while the window is moving, start again from the beginning. If the window continues to close but then re-open slightly even after performing the above procedure correctly, have the vehicle inspected by your Lexus dealer.

### ■ Door lock linked window operation

The power windows can be opened and closed using the mechanical key.  
(→P. 505)

### ■ Customization that can be configured at Lexus dealer

Settings (e.g. linked door lock operation) can be changed.  
(Customizable features →P. 553)

## CAUTION

### ■ Closing the windows

Observe the following precautions.

Failing to do so may result in death or serious injury.

- Check to make sure that all passengers do not have any part of their body in a position where it could be caught when a window is being operated.

- Do not allow children to operate the power windows.

Closing a power window on someone can cause serious injury, and in some instances, even death.

### ■ Jam protection function

- Never try jamming any part of your body to activate the jam protection function intentionally.

- The jam protection function may not work if something gets caught just before the window fully closes.

## 1-4. Opening and closing the windows and moon roof

### Moon roof\*

Use the overhead switches to open, close, and tilt the moon roof up and down.

#### ■ Opening and closing

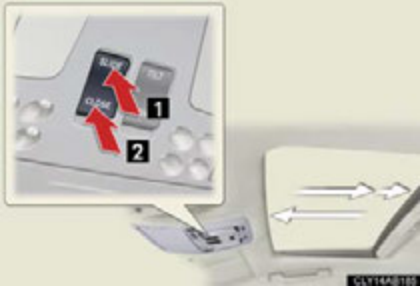

#### 1 Open\*

The moon roof stops slightly before the fully opened position. Push the switch again to fully open.

#### 2 Close\*

\*: Lightly press either of the moon roof switches to stop the moon roof partway.

#### ■ Tilting up and down

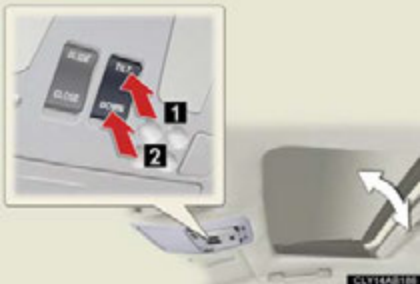

#### 1 Tilt up\*

#### 2 Tilt down\*

\*: Lightly press either of the moon roof switches to stop the moon roof partway.

### ■ The moon roof can be operated when

The “ENGINE START STOP” switch is in IGNITION ON mode.

### ■ Moon roof open warning buzzer

The buzzer sounds and a message is shown on the multi-information display in the instrument panel when the “ENGINE START STOP” switch is turned OFF and the driver’s door is opened with the moon roof open.

### ■ Door lock linked moon roof operation

The moon roof can be opened and closed using the mechanical key. (→P. 505)

### ■ Operating the moon roof after turning the “ENGINE START STOP” switch OFF

The moon roof can be operated for approximately 45 seconds even after the “ENGINE START STOP” switch is switched to ACCESSORY mode or turned OFF. It cannot, however, be operated once either front door is opened.

### ■ Jam protection function

If an object is detected between the moon roof and the frame while closing or tilting down, travel is stopped and the moon roof opens slightly.

### ■ To reduce moon roof wind noise

When the moon roof is opened automatically, it will stop slightly before the fully open position. Driving with the moon roof in this position can help reduce wind noise.

### ■ Sunshade

The sunshade can be opened and closed manually. However, the sunshade will open automatically when the moon roof is opened.

### ■ If the moon roof closes but then re-opens slightly

**STEP 1** Stop the vehicle.

**STEP 2** Press and hold the “CLOSE” switch until the moon roof completely closes.

During the operation, the moon roof will move in the manner outlined below. If the switch is released during the operation, the operation will have to be performed again from the beginning.

The moon roof will close, open and then pause for approximately 10 seconds. Then it will close, tilt up and pause for approximately 1 second, after which it will tilt down and open and then close.

If the moon roof does not fully close even after performing the above procedure correctly, have the vehicle inspected by your Lexus dealer.

### ■ If the moon roof tilts down but then tilts back up

**STEP 1** Stop the vehicle.

**STEP 2** Press and hold the “TILT” switch until the moon roof moves into the tilt up position and stops.

**STEP 3** Release the “TILT” switch once and then press and hold the “TILT” switch until the moon roof completely closes.

After moving to the tilt up position, the moon roof will move in the following manner. If the switch is released during the operation, the operation will have to be performed again from the beginning.

The moon roof will pause for approximately 10 seconds while in the tilt up position and then make some fine adjustments. Following this, it will pause for approximately 1 second, tilt down, open and then close.

If the moon roof does not fully close even after performing the above procedure correctly, have the vehicle inspected by your Lexus dealer.

### ■ Customization that can be configured at Lexus dealer

Settings (e.g. linked door lock operation) can be changed.  
(Customizable features →P. 553)

### CAUTION

#### ■ Opening the moon roof

Observe the following precautions.

Failing to do so may cause death or serious injury.

- Do not allow any passengers to put their hands or heads outside the vehicle while it is moving.
- Do not sit on top of the moon roof.

#### ■ Closing the moon roof

Observe the following precautions.

Failing to do so may result in death or serious injury.

- Check to make sure that all passengers do not have any part of their bodies in a position where they could be caught when the moon roof is being operated.
- Do not allow children to operate the moon roof.  
Closing the moon roof on someone can cause death or serious injury.

#### ■ Jam protection function

- Never try jamming any part of your body to activate the jam protection function intentionally.
- The jam protection function may not work if something gets caught just before the moon roof fully closes.

## 1-5. Refueling

### Opening the fuel tank cap

Perform the following steps to open the fuel tank cap.

#### ■ Before refueling the vehicle

Turn the “ENGINE START STOP” switch OFF and ensure that all the doors and windows are closed.

#### ■ Opening the fuel tank cap



Press the opener switch.

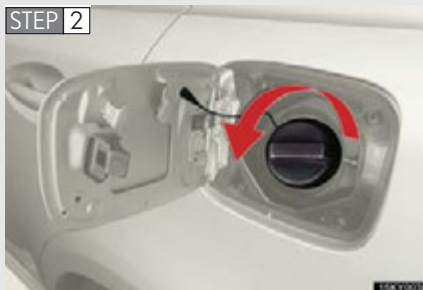

Turn the fuel tank cap slowly to open.



Hang the fuel tank cap on the back of the fuel filler door.

## Closing the fuel tank cap



When replacing the fuel tank cap, turn it until a clicking sound is heard.

After releasing your hand, the cap will turn slightly in the opposite direction.

### ■ Fuel types

Use unleaded gasoline. (Octane rating 91 [Research Octane Number 96] or higher)

### ■ Fuel tank capacity (reference)

17.2 gal. (65 L, 14.3 Imp. gal.)

### ■ When the fuel filler door opener is inoperable

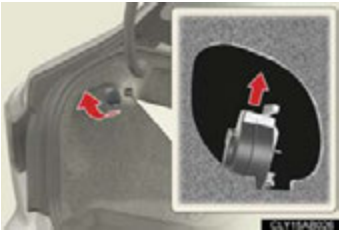

The lever can be used to open the fuel filler door if the fuel filler door cannot be opened using the inside switch because the battery is discharged or for any other reason.



 **CAUTION**
**■ Refueling the vehicle**

Observe the following precautions while refueling the vehicle. Failure to do so may result in death or serious injury.

- Touch the vehicle or some other metal surface to discharge any static electricity. Sparks resulting from discharging static electricity may cause the fuel vapors to ignite.
- Always hold the grips on the fuel tank cap and turn it slowly to remove it. A whooshing sound may be heard when the fuel tank cap is loosened. Wait until the sound cannot be heard before fully removing the cap. In hot weather, pressurized fuel may spray out of the filler neck and cause injury.
- Do not allow anyone that has not discharged static electricity from their bodies to come close to an open fuel tank.
- Do not inhale vaporized fuel. Fuel contains substances that are harmful if inhaled.
- Do not smoke while refueling the vehicle. Doing so may cause the fuel to ignite and cause a fire.
- Do not return to the vehicle or touch any person or object that is statically charged. This may cause static electricity to build up, resulting in a possible ignition hazard.

**■ When replacing the fuel cap**

Do not use anything but a genuine Lexus fuel tank cap designed for your vehicle. Failure to do so may cause a fire or other incident which may result in death or serious injury.

 **NOTICE**
**■ Refueling**

Do not spill fuel during refueling.

Failing to do so may damage the vehicle, such as causing the exhaust systems to operate abnormally or damaging fuel system components or the vehicle's painted surface.

## 1-6. Theft deterrent system

### Engine immobilizer system

The vehicle's keys have built-in transponder chips that prevent the engine from starting if the key has not been previously registered in the vehicle's on-board computer.

Never leave the keys inside the vehicle when you leave the vehicle.



The indicator light flashes after the “ENGINE START STOP” switch has been turned OFF to indicate that the system is operating.

The indicator light stops flashing after the “ENGINE START STOP” switch has been turned to ACCESSORY or IGNITION ON mode to indicate that the system has been canceled.

### ■ System maintenance

The vehicle has a maintenance-free type engine immobilizer system.

### ■ Conditions that may cause the system to malfunction

- If the grip portion of the key is in contact with a metallic object
- If the key is in close proximity to or touching a key to the security system (key with a built-in transponder chip) of another vehicle

### ■ Certifications for the engine immobilizer system

- ▶ For vehicles sold in the U.S.A.

FCC ID: NI4TMIMB-1

NOTE:

This device complies with part 15 of the FCC Rules. Operation is subject to the following two conditions: (1) This device may not cause harmful interference, and (2) this device must accept any interference received, including interference that may cause undesired operation.

FCC WARNING:

Changes or modifications not expressly approved by the party responsible for compliance could void the user's authority to operate the equipment.

- ▶ For vehicles sold in Canada

NOTE:

Operation is subject to the following two conditions: (1) this device may not cause interference, and (2) this device must accept any interference, including interference that may cause undesired operation of the device.

NOTE:

L'utilisation de ce dispositif est autorisée seulement aux deux conditions suivantes: (1) il ne doit pas produire de brouillage, et (2) l'utilisateur du dispositif doit être prêt à accepter tout brouillage radioélectrique reçu, même si ce brouillage est susceptible de compromettre le fonctionnement du dispositif.

### NOTICE

#### ■ To ensure the system operates correctly

Do not modify or remove the system. If modified or removed, the proper operation of the system cannot be guaranteed.

## 1-6. Theft deterrent system

# Alarm

The system sounds the alarm and flashes the lights when forcible entry is detected.

### ■ Triggering of the alarm

The alarm is triggered in the following situations when the alarm is set:

- A locked door or trunk is unlocked or opened in any way other than using the entry function, wireless remote door lock function or mechanical key.
- The hood is opened.

### ■ Setting the alarm system



Close the doors, trunk and hood, and lock all doors.

The system will be set automatically after 30 seconds.

The indicator light changes from being on to flashing when the system is set.

### ■ Deactivating or stopping the alarm

Do one of the following to deactivate or stop the alarm.

- Unlock the doors or trunk.
- Turn the “ENGINE START STOP” switch to ACCESSORY or IGNITION ON mode or start the engine by pressing the “ENGINE START STOP” switch. (The alarm will be deactivated or stopped after a few seconds.)

### ■ System maintenance

The vehicle has a maintenance-free type alarm system.

### ■ Points to remember before locking the doors

To prevent unexpected triggering of the alarm, make sure to check the following before locking the doors:

- Nobody is in the vehicle.
- The windows and moon roof are closed before the alarm is set.
- The alarm system does not guarantee absolute security. To help prevent theft, make sure to check that no valuables and so forth are left in the vehicle.

### ■ Unexpected triggering of the alarm

In the following situations, perform an operation that will deactivate or stop the alarm (→P. 92)



- When someone without a key is left in the vehicle and the doors are locked.

When a door, the trunk or hood is opened from inside the vehicle, the alarm may be triggered.



- When the battery is recharged or replaced, due to battery discharge and so forth, after locking the doors.

The alarm may be activated when the hood is opened and the battery is reconnected after the mechanical key has been used to unlock the doors.

### ■ When the battery is disconnected

Be sure to deactivate the alarm system.

If the battery is disconnected before deactivating the alarm system, the alarm may be triggered when the battery is reconnected.

### ■ Alarm-operated door lock

- When the alarm is operating, the doors are locked automatically to prevent intruders.
- Do not leave the key inside the vehicle when the alarm is operating, and make sure the key is not inside the vehicle when recharging or replacing the battery.



### NOTICE

#### ■ To ensure the system operates correctly

Do not modify or remove the system. If modified or removed, the proper operation of the system cannot be guaranteed.

## 1-6. Theft deterrent system

### Theft prevention labels (U.S.A.)



These labels are attached to the vehicle to reduce vehicle theft by facilitating the tracing and recovery of parts from stolen vehicles. Do not remove under penalty of law.

1

Before driving

### Correct driving posture

Drive in a good posture as follows:



- 1 Sit upright and well back in the seat. (→P. 56)
- 2 Adjust the position of the seat forward or backward to ensure the pedals can be reached and easily depressed to the extent required. (→P. 56)
- 3 Adjust the seatback so that the controls are easily operable. (→P. 56)
- 4 Adjust the tilt and telescopic positions of the steering wheel downward so the air-bag is facing your chest. (→P. 72, 73)
- 5 Lock the head restraint in place with the center of the head restraint closest to the top of your ears. (→P. 62)
- 6 Wear the seat belt correctly. (→P. 65)



 **CAUTION****■ While driving**

- Do not adjust the position of the driver's seat while driving.  
Doing so could cause the driver to lose control of the vehicle.
- Do not place a cushion between the driver or passenger and the seatback.  
A cushion may prevent correct posture from being achieved, and reduce the effectiveness of the seat belt and head restraint, increasing the risk of death or serious injury to the driver or passenger.
- Do not place anything under the front seats.  
Objects placed under the front seats may become jammed in the seat tracks and stop the seat from locking in place. This may lead to an accident. The adjustment mechanism may also be damaged.

**■ Adjusting the seat position:**

- Take care when adjusting the seat position to ensure that other passengers are not injured by the moving seat.
- Do not put your hands under the seat or near the moving parts to avoid injury.  
Fingers or hands may become jammed in the seat mechanism.

### SRS airbags

The SRS airbags inflate when the vehicle is subjected to certain types of severe impacts that may cause significant injury to the occupants. They work together with the seat belts to help reduce the risk of death or serious injury.



#### ► SRS front airbags

##### 1 SRS driver airbag/front passenger airbag

Can help protect the head and chest of the driver and front passenger from impact with interior components.

##### 2 SRS knee airbags

Can help provide driver and front passenger protection.

#### ► SRS side and curtain shield airbags

##### 3 SRS side airbags

Can help protect the torso of the front seat occupants.

##### 4 SRS curtain shield airbags

Can help protect primarily the head of outside occupants.

## Airbag system components

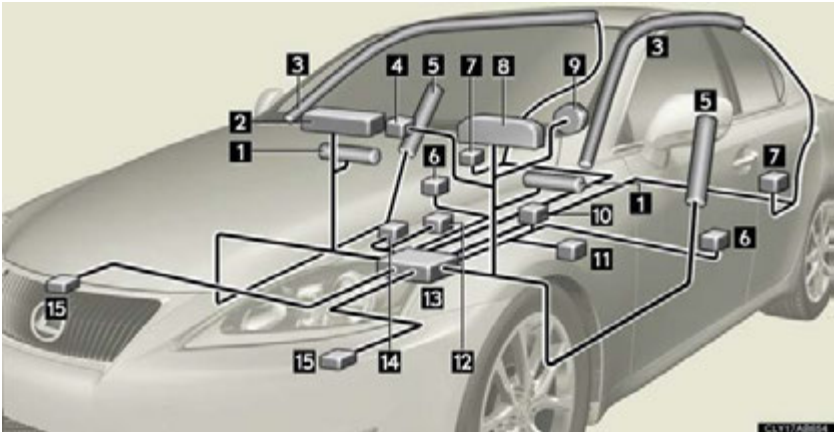

- |   |  |
|---|--|
| 1 Knee airbags                                    | 8 SRS warning light                            |
| 2 Front passenger airbag                          | 9 Driver airbag                                |
| 3 Curtain shield airbags                          | 10 Driver's seat belt buckle switch            |
| 4 "AIR BAG ON" and "AIR BAG OFF" indicator lights | 11 Driver's seat position sensor               |
| 5 Side airbags                                    | 12 Front passenger's seat belt buckle switch   |
| 6 Side and curtain shield airbag sensors          | 13 Airbag sensor assembly                      |
| 7 Curtain shield airbag sensors                   | 14 Occupant detection system (ECU and sensors) |
|   | 15 Front airbag sensors                        |

Your vehicle is equipped with ADVANCED AIRBAGS designed based on US motor vehicle safety standards (FMVSS208). The airbag system controls airbag deployment power for the driver and front passenger. The driver airbag system consists of the driver seat's position sensor etc. The front passenger's airbag system consists of the front passenger occupant classification sensor etc.

The main SRS airbag system components are shown above. The SRS airbag system is controlled by the airbag sensor assembly. The airbag sensor assembly consists of a safing sensor and an airbag sensor.

In certain types of severe frontal or side impacts, the SRS airbag system triggers the airbag inflators. A chemical reaction in the inflators quickly fills the airbags with non-toxic gas to help restrain the motion of the occupants.

---

### ■ SRS warning light

This warning light system monitors the airbag sensor assembly, front airbag sensors, side and curtain shield airbag sensor assemblies, curtain shield airbag sensor assemblies, driver's seat position sensor, driver's seat belt buckle switch, seat belt pretensioner assemblies, inflators, interconnecting wiring and power sources. (→P. 472)

### ■ If the SRS airbags deploy (inflate)

- Bruising and slight abrasions may result from contact with a deploying (inflating) SRS airbag.
- A loud noise and white powder will be emitted.
- Parts of the airbag module (steering wheel, airbag cover and inflator) as well as the front seats, and parts of the front pillar, rear pillar and roof side rail, may be hot for several minutes. The airbag itself may also be hot.
- The windshield may crack.
- For Safety Connect subscribers, if the SRS airbags deploy or in the event of a severe rear-end collision, the system is designed to send an emergency call to the response center, notifying them of the vehicle's location (without needing to push the "SOS" button) and an agent will attempt to speak with the occupants to ascertain the level of emergency and assistance required. If the occupants are unable to communicate, the agent automatically treats the call as an emergency and helps to dispatch the necessary emergency services. (→P. 370)

### ■ SRS airbag deployment conditions (front airbags)

- The SRS front airbags will deploy in the event of an impact that exceeds the set threshold level (the level of force corresponding to an approximately 12 - 18 mph [20 - 30 km/h] frontal collision with a fixed wall that does not move or deform).

However, this threshold velocity will be considerably higher if the vehicle strikes an object, such as a parked vehicle or sign pole, which can move or deform on impact, or if the vehicle is involved in an underride collision (e.g. a collision in which the front of the vehicle “underrides”, or goes under, the bed of a truck, etc.).

- It is possible that in some collisions where the forward deceleration of the vehicle is very close to the designed threshold level, the SRS front airbags and the seat belt pretensioners may not activate together.
- The SRS front passenger airbag will not activate if there is no passenger sitting in the front passenger seat. However, the front passenger airbag may deploy if luggage is put in the seat, or the seat belt is fastened, even if the seat is unoccupied. (→P. 109)

### ■ SRS airbag deployment conditions (side and curtain shield airbags)

- The SRS side airbags and SRS curtain shield airbags will deploy in the event of an impact that exceeds the set threshold level (the level of force corresponding to the impact force produced by an approximately 3300 lb. [1500 kg] vehicle colliding with the vehicle cabin from a direction perpendicular to the vehicle orientation at an approximate speed of 12 - 18 mph [20 - 30 km/h]).
- The SRS side airbag on the passenger seat will not activate if there is no passenger sitting in the front passenger seat. However, the side airbag on the passenger seat may deploy if luggage is put in the seat, even if the seat is unoccupied. (→P. 109)

### ■ Conditions under which the SRS airbags may deploy (inflate), other than a collision

The SRS front airbags may also deploy if a serious impact occurs to the underside of your vehicle. Some examples are shown in the illustration.

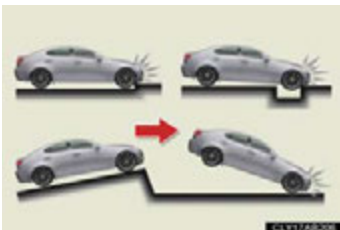

- Hitting a curb, edge of pavement or hard surface
- Falling into or jumping over a deep hole
- Landing hard or vehicle falling

■ **Types of collisions that may not deploy the SRS airbags (front airbags)**

The SRS front airbags are generally not designed to inflate if the vehicle is involved in a side or rear collision, if it rolls over, or if it is involved in a low-speed frontal collision. But, whenever a collision of any type causes sufficient forward deceleration of the vehicle, deployment of the SRS front airbags may occur.

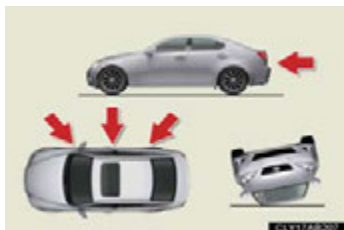

- Collision from the side
- Collision from the rear
- Vehicle rollover

■ **Types of collisions that may not deploy the SRS airbags (side and curtain shield airbags)**

The SRS side airbag and curtain shield airbag system may not activate if the vehicle is subjected to a collision from the side at certain angles, or a collision to the side of the vehicle body other than the passenger compartment.

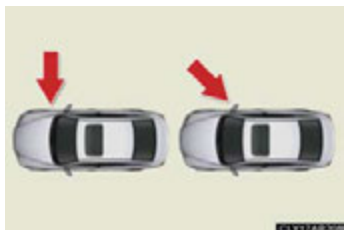

- Collision from the side to the vehicle body other than the passenger compartment
- Collision from the side at an angle

The SRS side airbags and curtain shield airbags are not generally designed to inflate if the vehicle is involved in a frontal or rear collision, if it rolls over, or if it is involved in a low-speed side collision.

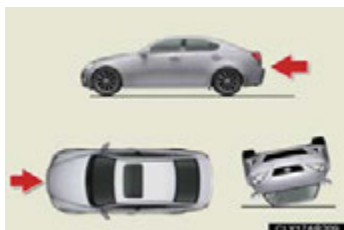

- Collision from the front
- Collision from the rear
- Vehicle rollover

## ■ When to contact your Lexus dealer

In the following cases, contact your Lexus dealer as soon as possible.

- Any of the SRS airbags have been inflated.

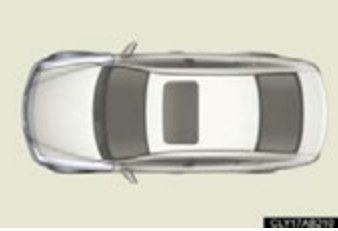

- The front of the vehicle is damaged or deformed, or was involved in an accident that was not severe enough to cause the SRS airbags to inflate.



- A portion of the doors is damaged or deformed, or the vehicle was involved in an accident that was not severe enough to cause the SRS side airbags and curtain shield airbags to inflate.



- The pad section of the steering wheel, dashboard or lower portion of the instrument panel is scratched, cracked, or otherwise damaged.



- The surface of the seats with the side airbag is scratched, cracked, or otherwise damaged.
- The portion of the front pillars, rear pillars or roof side rail garnishes (padding) containing the curtain shield airbags inside is scratched, cracked, or otherwise damaged.

### CAUTION

#### ■ SRS airbag precautions

Observe the following precautions regarding the airbags.

Failure to do so may cause death or serious injury.

- The driver and all passengers in the vehicle must wear their seat belts properly. The SRS airbags are supplemental devices to be used with the seat belts.
- The SRS driver airbag deploys with considerable force, and can cause death or serious injury especially if the driver is very close to the airbag. The National Highway Traffic Safety Administration (“NHTSA”) advises:

Since the risk zone for driver airbag is the first 2 - 3 in. (50 - 75 mm) of inflation, placing yourself 10 in. (250 mm) from your driver airbag provides you with a clear margin of safety. This distance is measured from the center of the steering wheel to your breastbone. If you sit less than 10 in. (250 mm) away now, you can change your driving position in several ways:

- Move your seat to the rear as far as you can while still reaching the pedals comfortably.
- Slightly recline the back of the seat.  
Although vehicle designs vary, many drivers can achieve the 10 in. (250 mm) distance, even with the driver seat all the way forward, simply by reclining the back of the seat somewhat. If reclining the back of your seat makes it hard to see the road, raise yourself by using a firm, non-slippery cushion, or raise the seat if your vehicle has that feature.
- If your steering wheel is adjustable, tilt it downward. This points the airbag toward your chest instead of your head and neck.

The seat should be adjusted as recommended by NHTSA above, while still maintaining control of the foot pedals, steering wheel, and your view of the instrument panel controls.



## ! CAUTION

### ■ SRS airbag precautions



- If the seat belt extender has been connected to the driver's seat belt buckle but the seat belt extender has not also been fastened to the latch plate of the driver's seat belt, the SRS driver's airbag system will judge that the driver is wearing the seat belt even though the seat belt has not been connected. In this case, the driver's airbag may not activate correctly in a collision, resulting in death or serious injury in the event of collision. Be sure to wear the seat belt with the seat belt extender.
- The SRS front passenger airbag also deploys with considerable force, and can cause death or serious injury especially if the front passenger is very close to the airbag. The front passenger seat should be as far from the airbag as possible with the seatback adjusted, so the front passenger sits upright.
- Improperly seated and/or restrained infants and children can be killed or seriously injured by a deploying airbag. An infant or child who is too small to use a seat belt should be properly secured using a child restraint system. Lexus strongly recommends that all infants and children be placed in the rear seats of the vehicle and properly restrained. The rear seats are the safest for infants and children. (→P. 114)

**CAUTION**

**SRS airbag precautions**



- Do not sit on the edge of the seat or lean against the dashboard.



- Do not allow a child to stand in front of the SRS front passenger airbag unit or sit on the knees of a front passenger.
- Do not drive the vehicle while the driver or passenger have items resting on their knees.



- Do not lean against the door, the roof side rail or the front, side and rear pillars.



- Do not allow anyone to kneel on the passenger seat toward the door or put their head or hands outside the vehicle.

## ⚠ CAUTION

### ■ SRS airbag precautions



- Do not attach anything to or lean anything against areas such as the dashboard, steering wheel pad and lower portion of the instrument panel.  
These items can become projectiles when SRS driver, front passenger and knee airbags deploy.
- Do not attach anything to areas such as the door, windshield glass, side door glass, front and rear pillars, roof side rail or assist grip.
- Do not hang coat hangers or other hard objects on the coat hooks. All of these items could become projectiles and seriously injure or kill you, should the SRS curtain shield airbag deploy.
- If a vinyl cover is put on the area where the SRS knee airbag will deploy, be sure to remove it.
- Do not use seat accessories which cover the parts where the SRS side airbags inflate as they may interfere with inflation of the airbags.
- Do not strike or apply significant levels of force to the area of the SRS airbag components shown on P. 99.  
Doing so can cause the SRS airbags to malfunction.
- Do not touch any of the component parts immediately after the SRS airbags have deployed (inflated) as they may be hot.
- If breathing becomes difficult after the SRS airbag has deployed, open a door or window to allow fresh air in, or leave the vehicle if it is safe to do so. Wash off any residue as soon as possible to prevent skin irritation.
- If the areas where the SRS airbags are stored, such as the steering wheel pad and front pillar garnish, are damaged or cracked, have them replaced by your Lexus dealer.

 **CAUTION**

**■ Modification and disposal of SRS airbag system components**

Do not dispose of your vehicle or perform any of the following modifications without consulting your Lexus dealer.

The SRS airbag may malfunction or deploy (inflate) accidentally, causing death or serious injury.

- Installation, removal, disassembly and repair of the SRS airbags
- Repairs, modifications, removal or replacement of the steering wheel, instrument panel, dashboard, seats or seat upholstery, front, side and rear pillars or roof side rails
- Repairs or modifications of the front fender, front bumper, or side of the occupant compartment
- Installation of snow plows, winches, etc. to the front grille (bull bars, kangaroo bar etc.)
- Modifications to the vehicle's suspension system
- Installation of electronic devices such as mobile two-way radios or CD players
- Modifications to your vehicle for a person with a physical disability

## Front passenger occupant classification system

Your vehicle is equipped with a front passenger occupant classification system. This system detects the conditions of the front passenger seat and activates or deactivates the devices for the front passenger.



- 1 SRS warning light
- 2 "AIR BAG OFF" indicator light
- 3 "AIR BAG ON" indicator light
- 4 Front passenger's seat belt reminder light

### Condition and operation in the front passenger occupant classification system

#### ■ Adult<sup>\*1</sup>

Indicator/ warning light	"AIR BAG ON" and "AIR BAG OFF" indicator lights	"AIR BAG ON"
	SRS warning light	Off
	Front passenger's seat belt reminder light	Flashing <sup>*2</sup>
Devices	Front passenger airbag	Activated
	Side airbag on the front passenger seat	
	Curtain shield airbag in the front passenger side	
	Front passenger knee airbag	
	Front passenger's seat belt pretensioner	

#### ■ Child<sup>\*3</sup> or child restraint system<sup>\*4</sup>

Indicator/ warning light	"AIR BAG ON" and "AIR BAG OFF" indicator lights	"AIR BAG OFF" <sup>*5</sup>
	SRS warning light	Off
	Front passenger's seat belt reminder light	Flashing <sup>*2</sup>
Devices	Front passenger airbag	Deactivated
	Side airbag on the front passenger seat	
	Curtain shield airbag in the front passenger side	Activated
	Front passenger knee airbag	Deactivated
	Front passenger's seat belt pretensioner	Activated

## ■ Unoccupied

Indicator/ warning light	"AIR BAG ON" and "AIR BAG OFF" indicator lights	Not illuminated
	SRS warning light	Off
	Front passenger's seat belt reminder light	
Devices	Front passenger airbag	Deactivated
	Side airbag on the front passenger seat	
	Curtain shield airbag in the front passenger side	Activated
	Front passenger knee airbag	Deactivated
	Front passenger's seat belt pretensioner	

1

Before driving

## ■ There is a malfunction in the system

Indicator/ warning light	"AIR BAG ON" and "AIR BAG OFF" indicator lights	"AIR BAG OFF"
	SRS warning light	On
	Front passenger's seat belt reminder light	Off
Devices	Front passenger airbag	Deactivated
	Side airbag on the front passenger seat	
	Curtain shield airbag in the front passenger side	Activated
	Front passenger knee airbag	Deactivated
	Front passenger's seat belt pretensioner	Activated

- \*1: The system judges a person of adult size as an adult. When a smaller adult sits in the front passenger seat, the system may recognize him/her as a child depending on his/her physique and posture.
- \*2: In the event the front passenger does not wear a seat belt.
- \*3: When a larger child who has outgrown a child restraint system sits in the front passenger seat, the system may recognize him/her as an adult depending on his/her physique or posture.

- \*4: Never install a rear-facing child restraint system on the front passenger seat. A forward-facing child restraint system should only be installed on the front passenger seat when it is unavoidable. (→P. 114)
- \*5: In case the indicator is not illuminated, consult this manual as for installing the child restraint system properly. (→P. 118)

### CAUTION

#### ■ Front passenger occupant classification system precautions

Observe the following precautions regarding the front passenger occupant classification system.

Failure to do so may cause death or serious injury.

- Wear the seat belt properly.
- Make sure the front passenger's seat belt tab has not been left inserted into the buckle before someone sits in the front passenger seat.
- Make sure the "AIR BAG OFF" indicator light is not illuminated when using the seat belt extender for the front passenger seat. If the "AIR BAG OFF" indicator light is illuminated, disconnect the extender tongue from the seat belt buckle, then reconnect the seat belt. Reconnect the seat belt extender after making sure the "AIR BAG ON" indicator light is illuminated. If you use the seat belt extender while the "AIR BAG OFF" indicator light is illuminated, the front passenger airbag, side airbag on the front passenger side and front passenger knee airbag may not activate correctly, which could cause death or serious injury in the event of collision.
- Do not put weight on the front passenger seat by putting your hands or feet on the front passenger seat seatback from the rear passenger seat.
- Do not let a rear passenger lift the front passenger seat with their feet or press on the seatback with their legs.
- Do not put objects under the front passenger seat.



 **CAUTION****■ Front passenger occupant classification system precautions**

- Do not recline the front passenger seatback so far that it touches a rear seat. This may cause the "AIR BAG OFF" indicator light to be illuminated, which indicates that the passenger's airbags will not deploy in the event of a severe accident. If the seatback touches the rear seat, return the seatback to a position where it does not touch the rear seat. Keep the front passenger seatback as upright as possible when the vehicle is moving. Reclining the seatback excessively may lessen the effectiveness of the seat belt system.
- If an adult sits in the front passenger seat, the "AIR BAG ON" indicator light is illuminated. If the "AIR BAG OFF" indicator is illuminated, ask the passenger to sit up straight, well back in the seat, feet on the floor, and with the seat belt worn correctly. If the "AIR BAG OFF" indicator still remains illuminated, either ask the passenger to move to the rear seat, or if that is not possible, move the front passenger seat fully rearward.
- When it is unavoidable to install a forward-facing child restraint system on the front passenger seat, install the child restraint system on the front passenger seat in the proper order. (→P. 118)
- Do not modify or remove the front seats.
- Do not kick the front passenger seat or subject it to severe impact. Otherwise, the SRS warning light may come on to indicate a malfunction of the detection system. In this case, contact your Lexus dealer immediately.
- Child restraint systems installed on the rear seat should not contact the front seatbacks.
- Do not use a seat accessory, such as a cushion or seat cover, that covers the seat cushion surface.
- Do not modify or replace the upholstery of the front seat.

# Child restraint systems

A child restraint system for a small child or baby must itself be properly restrained on the seat with the lap portion of the lap/shoulder belt.

The laws of all 50 states of the U.S.A. and Canada now require the use of child restraint systems.

### Points to remember

Studies have shown that installing a child restraint on a rear seat is safer than installing one to the front passenger seat.

- Choose a child restraint system that suits your vehicle and is appropriate to the age and size of the child.
- For installation details, follow the instructions provided with the child restraint system.

General installation instructions are provided in this manual.  
(→P. 118)

### Types of child restraints

Child restraint systems are classified into the following 3 types according to the age and size of the child.

- ▶ Rear facing — Infant seat/convertible seat



► Forward facing — Convertible seat



► Booster seat



■ Selecting an appropriate child restraint system

- Use a child restraint system appropriate for the child until the child becomes large enough to properly wear the vehicle's seat belt.
- If a child is too large for a child restraint system, sit the child on a rear seat and use the vehicle's seat belt. (→P. 65)

**!** CAUTION

■ Child restraint precautions

- For effective protection in automobile accidents and sudden stops, a child must be properly restrained, using a seat belt or child restraint system depending on the age and size of the child. Holding a child in your arms is not a substitute for a child restraint system. In an accident, the child can be crushed against the windshield, or between you and the vehicle's interior. This may cause death or serious injury to the child in the event of a sudden stop or an accident.

### CAUTION

#### ■ Child restraint precautions

- Lexus strongly urges the use of a proper child restraint system that conforms to the size of the child, installed on the rear seat. According to accident statistics, the child is safer when properly restrained in the rear seat than in the front seat.
- Never install a rear-facing child restraint system on the front passenger seat even if the "AIR BAG OFF" indicator light is illuminated. In the event of an accident, the force of the rapid inflation of the front passenger airbag can cause death or serious injury to the child if the rear-facing child restraint system is installed on the front passenger seat.
- A forward-facing child restraint system may be installed on the front passenger seat only when it is unavoidable. A child restraint system that requires a top tether strap should not be used in the front passenger seat since there is no top tether strap anchor for the front passenger seat. Adjust the seatback as upright as possible and always move the seat as far back as possible even if the "AIR BAG OFF" indicator light is illuminated, because the front passenger airbag could inflate with considerable speed and force. Otherwise, the child may be killed or seriously injured.
- Do not use the seat belt extender when installing a child restraint system on the front or rear passenger seat. If installing a child restraint system with the seat belt extender connected to the seat belt, the seat belt will not securely hold the child restraint system, which could cause death or serious injury to the child or other passengers in the event of a sudden stop, sudden swerve or collision.
- Do not allow the child to lean his/her head or any part of his/her body against the door or the area of the seat, front pillar, rear pillar or roof side rail from which the side airbags or curtain shield airbags deploy even if the child is seated in the child restraint system. It is dangerous if the side airbags and curtain shield airbags inflate, and the impact could cause death or serious injury to the child.
- Make sure you have complied with all installation instructions provided by the child restraint manufacturer and that the system is properly secured. If it is not secured properly, it may cause death or serious injury to the child in the event of a sudden stop, sudden swerve or an accident.

 **CAUTION****■ When children are in the vehicle**

Do not allow children to play with the seat belt. If the seat belt becomes twisted around a child's neck, it may lead to choking or other serious injuries that could result in death.

If this occurs and the buckle cannot be unfastened, scissors should be used to cut the belt.

**■ When the child restraint system is not in use**

- Keep the child restraint system properly secured on the seat even if it is not in use. Do not store the restraint unsecured in the passenger compartment.
- If it is necessary to detach the child restraint system, remove it from the vehicle or store it securely in the trunk. This will prevent it from injuring passengers in the event of a sudden stop, sudden swerve or an accident.

## 1-7. Safety information

### Installing child restraints

Follow the child restraint system manufacturer's instructions. Firmly secure child restraints to the rear seats using the LATCH anchors or a seat belt. Attach the top tether strap when installing a child restraint.

The lap/shoulder belt can be used if your child restraint system is not compatible with the LATCH (Lower Anchors and Tethers for Children) system.



Child restraint LATCH anchors

LATCH anchors are provided for the outside rear seats. (Buttons displaying the location of the anchors are attached to the seats.)



Seat belts equipped with a child restraint locking mechanism (ALR/ELR belts except driver's seat belt) (→P. 65)



Anchor bracket (for top tether strap)

Anchor brackets are provided for all rear seats.

## Installation with LATCH system

### ► Type A

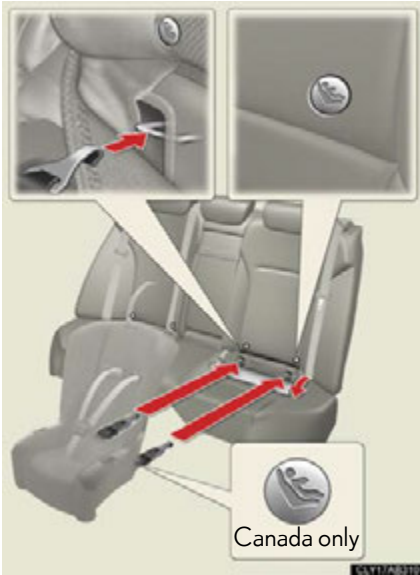

**STEP 1** Flip the cover.

**STEP 2** Latch the hooks of the lower straps onto the LATCH anchors.

**STEP 3** If the child restraint has a top tether strap, the top tether strap should be latched onto the top tether strap anchors.

For owners in Canada:  
The symbol on a child restraint system indicates the presence of a lower connector system.

1

Before driving

► Type B

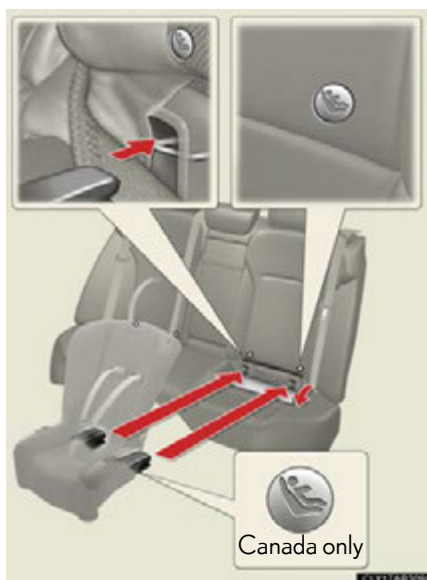

**STEP 1** Flip the cover.

**STEP 2** Latch the buckles onto the LATCH anchors.

**STEP 3** If the child restraint has a top tether strap, the top tether strap should be latched onto the top tether strap anchors.

For owners in Canada:

The symbol on a child restraint system indicates the presence of a lower connector system.



## Installing child restraints using a seat belt (child restraint lock function belt)

### ■ Rear facing — Infant seat/convertible seat

STEP 1



Place the child seat on the rear seat facing the rear of the vehicle.

STEP 2

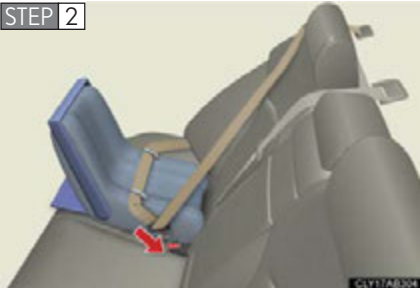

Run the seat belt through the child seat and insert the plate into the buckle. Make sure that the belt is not twisted.

STEP 3



Fully extend the shoulder belt and then allow it to retract slightly in order to activate the ALR lock mode.

Lock mode allows the seat belt to retract only.

1

Before driving

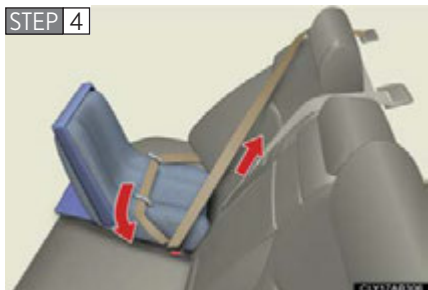

While pushing the child seat down into the rear seat, allow the shoulder belt to retract until the child seat is securely in place.

After the shoulder belt has retracted to a point where there is no slack in the belt, pull the belt to check that it cannot be extended.

### ■ Forward facing — Convertible seat



Place the child seat on the seat facing the front of the vehicle.



Run the seat belt through the child seat and insert the plate into the buckle. Make sure that the belt is not twisted.



Fully extend the shoulder belt and allow it to retract to put it in lock mode.

Lock mode allows the seat belt to retract only.



While pushing the child seat into the rear seat, allow the shoulder belt to retract until the child seat is securely in place.

After the shoulder belt has retracted to a point where there is no slack in the belt, pull the belt to check that it cannot be extended.

**STEP 5** If the child restraint has a top tether strap, the top tether strap should be latched onto the top tether strap anchors.

### ■ Booster seat



Place the booster seat on the seat facing the front of the vehicle.



Sit the child in the booster seat. Fit the seat belt to the booster seat according to the manufacturer's instructions and insert the plate into the buckle. Make sure that the belt is not twisted.

Check that the shoulder belt is correctly positioned over the child's shoulder, and that the lap belt is as low as possible. (→P. 65)

### Removing a child restraint installed with a seat belt



Push the buckle release button and fully retract the seat belt.

### Child restraint systems with a top tether strap



Secure the child restraint using a seat belt or the lower anchors, and lock the head restraint in place at the original position.



Open the anchor bracket cover, latch the hook onto the anchor bracket and tighten the top tether strap.

Make sure the top tether strap is securely latched.

### ■ Laws and regulations pertaining to anchorages

The LATCH system conforms to FMVSS225 or CMVSS210.2.

Child restraint systems conforming to FMVSS213 or CMVSS213 specifications can be used.

This vehicle is designed to conform to the SAE J1819.

### CAUTION

#### ■ When installing a booster seat

Do not fully extend the shoulder belt to prevent the belt from going to ALR lock mode: (→P. 67)

ALR mode causes the belt to tighten only which could cause injury or discomfort to the child.

## ⚠ CAUTION

### ■ When installing a child restraint system

Follow the directions given in the child restraint system installation manual and fix the child restraint system securely in place.

If the child restraint system is not correctly fixed in place, the child or other passengers may be injured or even killed in the event of sudden braking, sudden swerving or an accident.



- If the driver's seat interferes with the child restraint system and prevents it from being attached correctly, attach the child restraint system to the right-hand rear seat.

- Only put a forward facing or booster child seat on the front seat when unavoidable. When installing a forward facing or booster child seat on the front passenger seat, move the seat as far back as possible even if the "AIR BAG OFF" indicator light is illuminated. Failing to do so may result in death or serious injury if the airbags deploy (inflate).

- When a booster seat is installed, always ensure that the shoulder belt is positioned across the center of the child's shoulder. The belt should be kept away from the child's neck, but not so that it could fall off the child's shoulder. Failing to do so may result in death or serious injury in the event of sudden braking, sudden swerving or an accident.
- Make sure the outside rear seat head restraints are not in the folded position.
- Ensure that the belt and tab are securely locked and the seat belt is not twisted.
- Push and pull the child seat from side to side and forward to be sure it is secure.
- After securing a child restraint system, never adjust the seat.
- Follow all installation instructions provided by the child restraint system manufacturer.

 **CAUTION****■ Do not use a seat belt extender**

If a seat belt extender is used when installing a child restraint system, the seat belt will not securely hold the child restraint system, which could cause death or serious injury to the child or other passengers in the event of sudden braking, sudden swerving or an accident.

**■ To correctly attach a child restraint system to the anchors**

When using the LATCH anchors, be sure that there are no foreign objects around the anchors and that the seat belt is not caught behind the child restraint system. Make sure the child restraint system is securely attached, or it may cause death or serious injury to the child or other passengers in the event of a sudden stop, sudden swerve or accident.





**2-1. Driving procedures**

Driving the vehicle.....	130
Engine (ignition) switch.....	141
Automatic transmission.....	146
Manual transmission.....	152
Turn signal lever.....	154
Parking brake.....	155
Horn.....	157

**2-2. Instrument cluster**

Gauges and meters.....	158
Indicators and warning lights.....	164
Multi-information display.....	167

**2-3. Operating the lights and windshield wipers**

Headlight switch.....	172
Fog light switch.....	176
Windshield wipers and washer.....	178
Headlight cleaner switch.....	185

**2-4. Using other driving systems**

Cruise control.....	186
Intuitive parking assist.....	190
Driving assist systems.....	196

**2-5. Driving information**

Cargo and luggage.....	202
Vehicle load limits.....	205
Winter driving tips.....	206
Trailer towing.....	210
Dinghy towing (vehicles with an automatic transmission).....	211
Dinghy towing (vehicles with a manual transmission).....	212

## 2-1. Driving procedures

# Driving the vehicle

The following procedures should be observed to ensure safe driving.

### ■ Starting the engine (→P. 141)

#### ■ Driving

##### ▶ Automatic transmission

**STEP 1** With the brake pedal depressed, shift the shift lever to D. (→P.146)

**STEP 2** Release the parking brake. (→P.155)

**STEP 3** Gradually release the brake pedal and gently depress the accelerator pedal to accelerate the vehicle.

##### ▶ Manual transmission

**STEP 1** While depressing the clutch pedal, shift the shift lever into 1. (→P.152)

**STEP 2** Release the parking brake. (→P.155)

**STEP 3** Gradually release the clutch pedal. At the same time, gently depress the accelerator pedal to accelerate the vehicle.

### ■ Stopping

##### ▶ Automatic transmission

**STEP 1** With the shift lever in D, depress the brake pedal.

**STEP 2** If necessary, set the parking brake.

When the vehicle is stopped for an extended period of time, shift the shift lever to P or N. (→P.146)

##### ▶ Manual transmission

**STEP 1** While depressing the clutch pedal, depress the brake pedal.

**STEP 2** If necessary, set the parking brake.

When the vehicle is stopped for an extended period of time, shift the shift lever into N. (→P.152)

## ■ Parking the vehicle

### ▶ Automatic transmission

**STEP 1** With the shift lever in D, depress the brake pedal.

**STEP 2** Set the parking brake. (→P.155)

**STEP 3** Shift the shift lever to P. (→P.146)

**STEP 4** Press the “ENGINE START STOP” switch to stop the engine.

**STEP 5** Lock the door, making sure that you have the electronic key on your person.

### ▶ Manual transmission

**STEP 1** While depressing the clutch pedal, depress the brake pedal.

**STEP 2** Set the parking brake. (→P.155)

**STEP 3** Shift the shift lever into N. (→P.152)

**STEP 4** Press the “ENGINE START STOP” switch to stop the engine.

**STEP 5** Lock the door, making sure that you have the electronic key on your person.

## Starting on a steep uphill

### ▶ Automatic transmission

**STEP 1** Firmly set the parking brake and shift the shift lever to D.

**STEP 2** Gently depress the accelerator pedal.

**STEP 3** Release the parking brake.

### ▶ Manual transmission

**STEP 1** With the parking brake firmly set and the clutch pedal fully depressed, shift the shift lever into 1.

**STEP 2** Lightly depress the accelerator pedal at the same time as gradually releasing the clutch pedal.

**STEP 3** Release the parking brake.

### ■ Starting off on a hill (vehicles with an automatic transmission)

Hill-start assist control will operate. (→P. 196)

### ■ Driving in the rain

- Drive carefully when it is raining, because visibility will be reduced, the windows may become fogged-up, and the road will be slippery.
- Drive carefully when it starts to rain, because the road surface will be especially slippery.
- Refrain from high speeds when driving on an expressway in the rain, because there may be a layer of water between the tires and the road surface, preventing the steering and brakes from operating properly.

### ■ Engine speed while driving

In the following conditions, the engine speed may become high while driving. This is due to automatic up-shifting control or down-shifting implementation to meet driving conditions. It does not indicate sudden acceleration.

- The vehicle is judged to be driving uphill or downhill
- When the accelerator pedal is released

### ■ Breaking in your new Lexus

To extend the life of the vehicle, the following precautions are recommended to observe:

- For the first 186 miles (300 km):  
Avoid sudden stops.
- For the first 621 miles (1000 km):
  - Do not drive at extremely high speeds.
  - Avoid sudden acceleration.
  - Do not drive continuously in the low gears.
  - Do not drive at a constant speed for extended periods.

### ■ Drum-in-disc type parking brake system

Your vehicle has a drum-in-disc type parking brake system. This type of brake system needs bedding-down of the brake shoes periodically or whenever the parking brake shoes and/or drum are replaced. Have your Lexus dealer perform the bedding down.

## ■ Operating your vehicle in a foreign country

Comply with the relevant vehicle registration laws and confirm the availability of the correct fuel. (→P. 523)

### CAUTION

#### ■ When starting the vehicle

With automatic transmission vehicles, always keep your foot on the brake pedal while stopped with the engine running. This prevents the vehicle from creeping.

#### ■ When driving the vehicle

- Do not drive if you are unfamiliar with the location of the brake and accelerator pedals to avoid depressing the wrong pedal.
  - Accidentally depressing the accelerator pedal instead of the brake pedal will result in sudden acceleration that may lead to an accident that could result in death or serious injury.
  - When backing up, you may twist your body around, leading to a difficulty in operating the pedals. Make sure to operate the pedals properly.
  - Make sure to keep a correct driving posture even when moving the vehicle only slightly, allowing you to depress the brake and accelerator pedals properly.
  - Depress the brake pedal using your right foot. Depressing the brake pedal using your left foot may delay response in an emergency, resulting in an accident.
- Do not drive the vehicle over or stop the vehicle near flammable materials.
- With automatic transmission vehicles, do not let the vehicle roll backwards while the shift lever is in a driving position, or roll forward while the shift lever is in R. Doing so may cause the engine to stall or lead to poor brake and steering performance, resulting in an accident or damage to the vehicle.
- If the smell of exhaust is noticed inside the vehicle, open the windows and check that the trunk is closed. Large amounts of exhaust in the vehicle can cause driver drowsiness and an accident, resulting in death or a serious health hazard. Have the vehicle inspected by your Lexus dealer immediately.

### CAUTION

- With automatic transmission vehicles, do not shift the shift lever to P while the vehicle is moving.  
Doing so can damage the transmission and may result in a loss of vehicle control.
- Do not shift the shift lever to R while the vehicle is moving forward.  
Doing so can damage the transmission and may result in a loss of vehicle control.
- Do not shift the shift lever to D (vehicles with an automatic transmission) or 1 (vehicles with a manual transmission) while the vehicle is moving backward.  
Doing so can damage the transmission and may result in a loss of vehicle control.
- Moving the shift lever to N while the vehicle is moving will disengage the engine from the transmission. Engine braking is not available when N is selected.
- During normal driving, do not turn off the engine. Turning the engine off while driving will not cause loss of steering or braking control, but the power assist to these systems will be lost. This will make it more difficult to steer and brake, so you should pull over and stop the vehicle as soon as it is safe to do so.  
However, in the event of an emergency, such as if it becomes impossible to stop the vehicle in the normal way: →P. 518
- Use engine braking (downshift) to maintain a safe speed when driving down a steep hill.  
Using the brakes continuously may cause the brakes to overheat and lose effectiveness. (→P. 147)
- When stopped on an inclined surface, use the brake pedal and parking brake to prevent the vehicle from rolling backward or forward and causing an accident.
- Do not adjust the position of the steering wheel, the seat, or the inside or outside rear view mirrors while driving.  
Doing so may result in a loss of vehicle control that can cause accidents that may result in death or serious injury.

 **CAUTION**

- Always check that all passengers' arms, heads or other parts of their bodies are not outside the vehicle, as this may result in death or serious injury.
  - Do not drive the vehicle off-road.  
This is not a AWD vehicle designed for real off-road driving. Proceed with all due caution if it becomes unavoidable to drive off-road.
  - Do not drive across river crossings or through other bodies of water.  
This may cause electric/electronic components to short circuit, damage the engine or cause other serious damage to the vehicle.
  - Do not drive in excess of the speed limit. Even if the legal speed limit permits it, do not drive over 85 mph (140 km/h) unless your vehicle has high-speed capability tires. Driving over 85 mph (140 km/h) may result in tire failure, loss of control and possible injury. Be sure to consult a tire dealer to determine whether the tires on your vehicle are high-speed capability tires or not before driving at such speeds.
- **When driving on slippery road surfaces**
- Sudden braking, acceleration and steering may cause tire slippage and reduce your ability to control the vehicle, resulting in an accident.
  - Sudden changes in engine speed, such as engine braking caused by up-shifting or down-shifting, may cause the vehicle to skid, resulting in an accident.
  - After driving through a puddle, lightly depress the brake pedal to make sure that the brakes are functioning properly. Wet brake pads may prevent the brakes from functioning properly. If the brakes on only one side are wet and not functioning properly, steering control may be affected, resulting in an accident.

### CAUTION

#### ■ When shifting the shift lever

With automatic transmission vehicles, be careful not to shift the shift lever with the accelerator pedal depressed.

This may lead to unexpected rapid acceleration of the vehicle that may cause an accident and result in death or serious injury.

#### ■ If you hear a squealing or scraping noise (brake pad wear limit indicators)

Have your Lexus dealer check and replace the brake pads as soon as possible. Rotor damage can result if the pads are not replaced when needed.

Front brake only: Moderate levels of brake pad and disc wear allow enhanced front braking power. As a result, the discs may wear more quickly than conventional brake discs. Therefore, when replacing the brake pads, Lexus recommends that you also have the thickness of the discs measured.

It is dangerous to drive the vehicle when the wear limits of the brake pads and/or those of the brake discs are exceeded.

#### ■ When the vehicle is stopped

- Do not race the engine.

If the vehicle is in any gear other than P (vehicles with an automatic transmission only) or N the vehicle may accelerate suddenly and unexpectedly, and may cause an accident.

- Do not leave the vehicle with the engine running for a long time.

If such a situation cannot be avoided, park the vehicle in an open space and check that exhaust fumes do not enter the vehicle interior.

- With automatic transmission vehicles, in order to prevent accidents due to the vehicle rolling away, always keep depressing the brake pedal while the engine is running, and apply the parking brake as necessary.

- If the vehicle is stopped on an incline, in order to prevent accidents caused by the vehicle rolling forward or backward, always depress the brake pedal and securely apply the parking brake as needed.

- Avoid revving or racing the engine.

Running the engine at high speed while the vehicle is stopped may cause the exhaust system to overheat, which could result in a fire if combustible material is nearby.



 **CAUTION****■ When the vehicle is parked**

- Do not leave glasses, cigarette lighters, spray cans, or soft drink cans in the vehicle when it is in the sun.  
Doing so may result in the following.
  - Gas may leak from a cigarette lighter or spray can, and may lead to a fire.
  - The temperature inside the vehicle may cause the plastic lenses and plastic material of eye glasses to deform or crack.
  - Soft drink cans may fracture, causing the contents to spray over the interior of the vehicle, and may also cause a short circuit in the vehicle's electrical components.
- Always apply the parking brake, shift the shift lever to P (vehicles with an automatic transmission only), stop the engine and lock the vehicle.  
Do not leave the vehicle unattended while the engine is running.
- Do not touch the exhaust pipe while the engine is running or immediately after turning the engine off.  
Doing so may cause burns.
- Do not leave the engine running in an area with snow build-up, or where it is snowing. If snowbanks build up around the vehicle while the engine is running, exhaust gases may collect and enter the vehicle. This may lead to death or a serious health hazard.

**■ Exhaust gases**

Exhaust gases include harmful carbon monoxide (CO) that is colorless and odorless. Inhaling exhaust gases may lead to death or a serious health hazard.

- If the vehicle is in a poorly ventilated area, stop the engine. In a closed area, such as a garage, exhaust gases may collect and enter the vehicle. This may lead to death or a serious health hazard.
- The exhaust should be checked occasionally. If there is a hole or crack caused by corrosion, damage to a joint or abnormal exhaust noise, be sure to have the vehicle inspected and repaired by your Lexus dealer. Failure to do so may allow exhaust gases to enter the vehicle, resulting in death or a serious health hazard.

### CAUTION

#### ■ When taking a nap in the vehicle

Always turn the engine off. Otherwise, you may accidentally move the shift lever or depress the accelerator pedal, which could cause an accident or fire due to engine overheating. Additionally, if the vehicle is parked in a poorly ventilated area, exhaust gases may collect and enter the vehicle, leading to death or a serious health hazard.

#### ■ When braking the vehicle

- When the brakes are wet, drive more cautiously.

Braking distance increases when the brakes are wet, and may cause one side of the vehicle to brake differently than the other side. Also the parking brake may not securely hold the vehicle.

- If the power brake assist function does not operate, do not follow other vehicles closely and avoid downhills or sharp turns that require braking.

In this case, braking is still possible, but it will require more force on the pedal than usual. Braking distance may also increase.

- Do not pump the brake pedal if the engine stalls.

Each push on the brake pedal uses up the reserve for the power-assisted brakes.

- The brake system consists of 2 individual hydraulic systems: if one of the systems fails, the other will still operate. In this case, the brake pedal should be depressed more firmly than usual and braking distance becomes longer.

Do not drive your vehicle with only a single brake system. Have your brakes fixed immediately.

#### ■ If the vehicle becomes stuck or bogged (AWD models)

Do not spin the wheels recklessly when any of the tires is up in the air, or stuck in sand or mud, etc. This may damage the drive system components or propel the vehicle forward (or in another direction) and cause an accident.

 NOTICE**■ When driving the vehicle**

- Do not depress the accelerator and brake pedals at the same time during driving. If the brake pedal is depressed while driving with the accelerator pedal depressed, driving torque may be restrained.
- ▶ With automatic transmission vehicles
  - Do not use the accelerator pedal or depress the accelerator and brake pedals together to hold the vehicle on a hill.
- ▶ With manual transmission vehicles
  - Do not rest your foot on the clutch pedal while driving. Doing so may cause clutch trouble.
  - Do not use any gear other than the first gear when starting off and moving forward. Doing so may damage the clutch.
  - Do not use the clutch to hold the vehicle when stopping on an uphill grade. Doing so may damage the clutch.

**■ When parking the vehicle**

With automatic transmission vehicles, always put the shift lever in P. Failure to do so may cause the vehicle to move or the vehicle may accelerate suddenly if the accelerator pedal is accidentally depressed.

**■ Avoiding damage to vehicle parts**

- Do not turn the steering wheel fully in either direction and hold it there for a long time. Doing so may damage the power steering motor.
- When driving over bumps in the road, drive as slowly as possible to avoid damaging the wheels, underside of the vehicle, etc.

### NOTICE

#### ■ If you get a flat tire while driving

A flat or damaged tire may cause the following situations. Hold the steering wheel firmly and gradually press the brake pedal to slow down the vehicle.

- It may be difficult to control your vehicle.
- The vehicle will make abnormal sounds.
- The vehicle will behave abnormally.

Information on what to do in case of a flat tire (→P. 492)

#### ■ When encountering flooded roads

Do not drive on a road that has flooded after heavy rain etc. Doing so may cause the following serious damage to the vehicle.

- Engine stalling
- Short in electrical components
- Engine damage caused by water immersion

In the event that you drive on a flooded road and the vehicle is flooded, be sure to have your Lexus dealer check the following.

- Brake function
- Changes in quantity and quality of oil and fluid used for the engine, transmission, transfer (AWD vehicles), differential, etc.
- Lubricant condition for the propeller shaft (AWD vehicles), bearings and suspension joints (where possible) and the function of all joints, bearings, etc.

## 2-1. Driving procedures

# Engine (ignition) switch

Performing the following operations when carrying the electronic key on your person starts the engine or changes “ENGINE START STOP” switch modes.

### ■ Starting the engine

#### ▶ Automatic transmission

**STEP 1** Check that the parking brake is set.

**STEP 2** Check that the shift lever is set in P.

**STEP 3** Sit in the driver’s seat and firmly depress the brake pedal.

The “ENGINE START STOP” switch indicator turns green.

**STEP 4**



Press the “ENGINE START STOP” switch.

The engine will crank until it starts or for up to 30 seconds, whichever is less.

Continue depressing the brake pedal until the engine is completely started.

The engine can be started from any “ENGINE START STOP” switch mode.

► Manual transmission

**STEP 1** Check that the parking brake is set.

**STEP 2** Check that the shift lever is set in N.

**STEP 3** Firmly depress the clutch pedal.

The “ENGINE START STOP” switch indicator turns green.

**STEP 4**



Press the “ENGINE START STOP” switch.

The engine will crank until it starts or for up to 30 seconds, whichever is less.

Continue depressing the clutch pedal until the engine is completely started.

The engine can be started from any “ENGINE START STOP” switch mode.

### ■ Changing “ENGINE START STOP” switch mode

Modes can be changed by pressing the “ENGINE START STOP” switch with the brake pedal (vehicles with an automatic transmission) or clutch pedal (vehicles with a manual transmission) released. (The mode changes each time the switch is pressed.)



#### 1 OFF\*

The emergency flashers can be used.

#### 2 ACCESSORY mode

Some electrical components such as the audio system can be used.

The “ENGINE START STOP” switch indicator turns amber.

#### 3 IGNITION ON mode

All electrical components can be used.

The “ENGINE START STOP” switch indicator turns amber.

\*: If the shift lever is in a position other than P when turning off the engine, the “ENGINE START STOP” switch will be turned to ACCESSORY mode, not to OFF. (vehicles with automatic transmission)

### ■ If the engine does not start

The engine immobilizer system may not have been deactivated. (→P. 90)

### ■ When the steering lock cannot be released



The “ENGINE START STOP” switch indicator will flash in green and a message will be shown on the multi-information display. Press the “ENGINE START STOP” switch again while turning the steering wheel left and right.

### ■ When the “ENGINE START STOP” switch indicator flashes in amber

The system may be malfunctioning. Have the vehicle inspected by your Lexus dealer immediately.

### ■ Auto power off function

If the vehicle is left in ACCESSORY mode for more than an hour with the shift lever in P (vehicles with an automatic transmission), the “ENGINE START STOP” switch will automatically turn OFF.

### ■ Electronic key battery depletion

→P. 39

### ■ When the electronic key battery is fully discharged

→P. 433

### ■ Conditions affecting operation

→P. 37

### ■ Note for the entry function

→P. 40



 CAUTION**■ When starting the engine**

Always start the engine while sitting in the driver's seat. Do not press the accelerator while starting the engine under any circumstances.

Doing so may cause an accident resulting in death or serious injury.

**■ Stopping the engine in an emergency**

If you want to stop the engine in an emergency while driving the vehicle, push and hold the "ENGINE START STOP" switch for more than 3 seconds.

However, do not touch the "ENGINE START STOP" switch while driving except in an emergency. Turning the engine off while driving will not cause loss of steering or braking control, but the power assist to these systems will be lost. This will make it more difficult to steer and brake, so you should pull over and stop the vehicle as soon as it is safe to do so.

 NOTICE**■ To prevent battery discharge**

Do not leave the "ENGINE START STOP" switch in ACCESSORY or IGNITION ON mode for long periods without the engine running.

**■ When starting the engine**

- Do not race a cold engine.
- If the engine becomes difficult to start or stalls frequently, have the engine checked immediately.

## 2-1. Driving procedures

# Automatic transmission \*

Select a shift position appropriate for the driving conditions.

### ■ Shifting the shift lever



← While the “ENGINE START STOP” switch is in IGNITION ON mode, depress the brake pedal and move the shift lever.

### ■ Shift position uses

Shift position	Function
P	Parking the vehicle or starting the engine
R	Reversing
N	Neutral
D	Normal driving*
S	S mode driving (→P.149)

\*: To improve fuel consumption and reduce noises, set the shift lever in the D position for normal driving.

\*: If equipped

## ■ Selecting a driving mode

The following patterns can be selected to suit current driving and operating conditions.



- 1** Power mode  
For powerful acceleration and driving in mountainous regions.
- 2** Normal mode
- 3** Snow mode  
For accelerating and driving on slippery road surfaces, such as on snow.

Press "SNOW" to return to normal mode.

2

When driving

## Selecting shift ranges in the D position

To drive using temporary shift range selection, operate the "-" shift paddle switch. The shift range can then be selected by operating the "-" and "+" shift paddle switches. Changing the shift range allows restriction of the upper limit of the gears to be used, preventing unnecessary upshifting and enabling the level of engine braking force to be selected.



- 1** Higher shift range
- 2** Lower shift range

The selected shift range, from 1 to 6, will be displayed in the meter cluster.

To return to normal D position driving, the "+" shift paddle switch must be held down for a period of time.

### ■ Shift ranges and their functions

Shift range	Function
6	Automatically selecting gears between 1 and 6 according to vehicle speed and driving conditions.
5	Automatically selecting gears between 1 and 5 according to vehicle speed and driving conditions.
4	Automatically selecting gears between 1 and 4 according to vehicle speed and driving conditions.
3	Automatically selecting gears between 1 and 3 according to vehicle speed and driving conditions.
2	Automatically selecting gears between 1 and 2 according to vehicle speed and driving conditions.
1	Setting the gear at 1.

A lower shift range will provide greater engine braking force than a higher shift range.

## Changing shift ranges in S mode

To enter S mode, shift the shift lever to the S position. The shift range can then be selected by operating the “-” and “+” shift paddle switches or the shift lever. Changing the shift range allows restriction of the upper limit of the gears to be used, preventing unnecessary upshifting and enabling the level of engine braking force to be selected.



1 Higher shift range

2 Lower shift range

The selected shift range, from 1 to 6, will be displayed in the meter cluster.

The initial shift range in S mode is automatically set to 5 or 4 according to vehicle speed. However, the initial shift range may be set to 3 or 2 if the AI-SHIFT has operated while the shift lever was in the D position.

(→P. 151)

### ■ Shift ranges and their functions

→P. 148

### ■ When the “-” shift paddle switch is operated in the D position

When the “-” shift paddle switch is operated in the D position, a shift range will be automatically selected. The highest gear of the first shift range will be one gear lower than the gear in use during normal D position driving.

### ■ Automatic deactivation of shift range selection in the D position

Shift range selection in the D position will be deactivated in the following situations:

- When the vehicle comes to a stop
- When range 6 is selected and the accelerator pedal is depressed
- If the accelerator pedal is depressed for more than a certain period of time

### ■ To protect automatic transmission

A function is adopted that automatically selects a higher shift range when the fluid temperature is high.

### ■ Gear position display when driving

The current gear is displayed on the multi-information display. (→P. 170)

### ■ Downshifting restrictions warning buzzer

To help ensure safety and driving performance, downshifting operation may sometimes be restricted. In some circumstances, downshifting may not be possible even when the shift lever or shift paddle switch is operated. (The warning buzzer will sound twice.)

### ■ When driving with the cruise control system

Engine braking will not occur during shift range selection in the D position or S mode, even when downshifting to range 5 or 4. (→P. 186)

### ■ Snow mode automatic deactivation

Snow mode is automatically deactivated if the “ENGINE START STOP” switch is turned off after driving in snow mode.

### ■ If the shift lever cannot be shifted from P

→P. 503

■ If **S** does not come on even after shifting the shift lever to S

This may indicate a malfunction in the automatic transmission system. Have the vehicle inspected by your Lexus dealer immediately.

(In this situation, the vehicle will operate as if the shift lever is in D.)

■ **AI-SHIFT**

The AI-SHIFT automatically shifts the gear to the suitable position according to the driver performance and driving conditions.

The AI-SHIFT automatically operates when the shift lever is in the D position. However, operating the “-” shift paddle switch will restrict the function’s operation. (Shifting the shift lever to the S position cancels the function.)

 **CAUTION**

■ **When driving on slippery road surfaces**

Be careful of downshifting and sudden acceleration, as this could result in the vehicle skidding to the side or spinning.

## 2-1. Driving procedures

# Manual transmission \*

### ■ Shifting the shift lever



Fully depress the clutch pedal before operating the shift lever, and then release it slowly.



### ■ Shifting the shift lever into R



Shift the shift lever into the R position while lifting up the ring section.



## Snow mode



The snow mode is used for accelerating and driving on slippery road surfaces, such as on snow.

Push the switch once more to return to normal mode.

2

When driving

### ■ Maximum downshifting speed

Adhere to the downshifting speeds in the following table in order to prevent over-revving the engine.

mph (km/h)

Shift position	Maximum speed
1	33 (54)
2	56 (90)
3	83 (134)
4	108 (172)

## 2-1. Driving procedures

### Turn signal lever

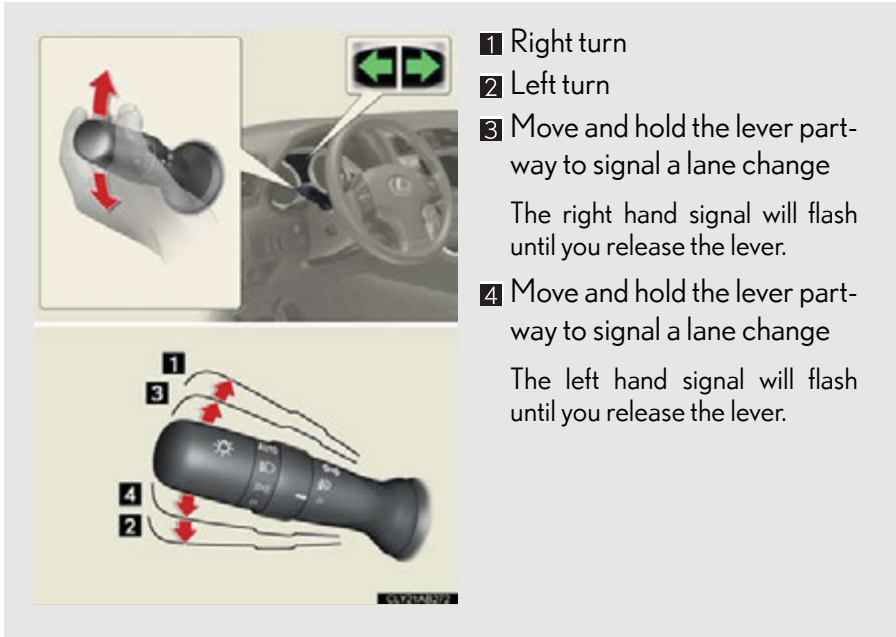

#### ■ Turn signals can be operated when

The "ENGINE START STOP" switch is in IGNITION ON mode.

#### ■ If the indicators flash faster than usual

Check that a light bulb in the turn signal lights has not burned out.

## 2-1. Driving procedures

### Parking brake

#### ▶ Vehicles with an automatic transmission



Sets the parking brake\*  
(Depressing the pedal again releases the parking brake.)

\*: Fully depress the parking brake pedal with your left foot while depressing the brake pedal with your right foot.

#### ▶ Vehicles with a manual transmission



#### 1 Sets the parking brake

Fully set the parking brake while depressing the brake pedal.

#### 2 3 4 Releases the parking brake

Slightly raise the lever and lower it completely while pressing the button.

#### ■ Usage in winter time

See "Winter driving tips" for parking brake usage in winter time. (→P. 206)

### NOTICE

#### ■ Before driving

Fully release the parking brake.

Driving the vehicle with the parking brake set will lead to brake components overheating, which may affect braking performance and increase brake wear.

# Horn



To sound the horn, press on or close to the  mark.

- **After adjusting the steering wheel (vehicles with manually adjustable type steering wheel)**

Make sure that the steering wheel is securely locked.

The horn may not sound if the steering wheel is not securely locked. (→P.72)

## 2-2. Instrument cluster

### Gauges and meters



The units used on the speedometer and the tachometer gauge display may differ depending on the model/type.

The following gauges, meters and display illuminate when the “ENGINE START STOP” switch is in IGNITION ON mode.

#### 1 Speedometer

Displays the vehicle speed.

#### 2 Multi-information display

→P.167

#### 3 Tachometer

Displays the engine speed in revolutions per minute.

#### 4 Tacho indicator

When the set engine speed is reached, this ring-shaped indicator comes on in yellow. The indicator comes on in red when the engine speed reaches a dangerous range.

#### 5 Engine coolant temperature gauge

Displays the engine coolant temperature.

**6** Odometer and trip meter

Odometer: Displays the total distance the vehicle has been driven.

Trip meter: Displays the distance the vehicle has been driven since the meter was last reset. Trip meters "A" and "B" can be used to record and display different distances independently.

**7** Speed indicator

When the set speed is reached while driving, this ring-shaped indicator comes on in yellow. The indicator comes on in red when the vehicle speed reaches the dangerous range.

**8** Fuel gauge

Displays the quantity of fuel remaining in the tank.

**9** Odometer/trip meter and trip meter reset button

Switches between odometer and trip meter displays. Pushing and holding the button will reset the trip meter when the trip meter is being displayed.

## Instrument panel light control

The brightness of the instrument panel lights can be adjusted.



**1** Darker

**2** Brighter

## Speed and tacho indicators

### ■ Turning the indicator on/off

STEP 1



Bring up the satellite switch mode on the multi-information display.

Press “<”, “>” or the “ON/OFF” button.

STEP 2

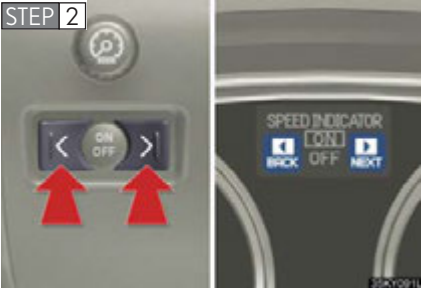

Select the item whose setting is to be changed.

Press “<” or “>” to display the item whose setting is to be changed.

STEP 3

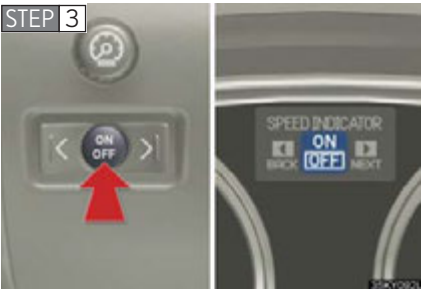

Change the settings.

Press the “ON/OFF” button to change the settings.



## ■ Changing the indicator setting

The satellite switch can be used to change the set speed at which the yellow speed or tacho indicator ring comes on.

The setting can be made only when the “ENGINE START STOP” switch is in IGNITION ON mode and the vehicle is stopped.

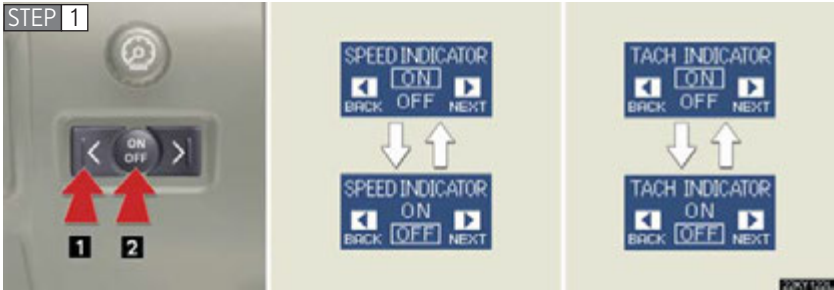

Push “<” or “>” to select the speed or tacho indicator set mode. (1) Turn the speed or tacho indicator to “OFF” and then “ON” by pushing the “ON/OFF” button. (2)

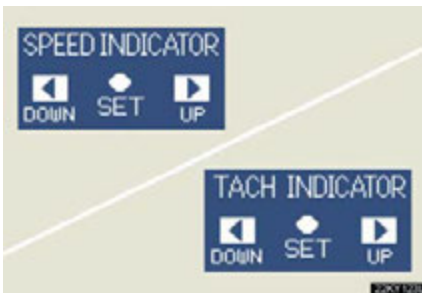

After one second, the mode enters the indicator setting mode.

The speedometer or tachometer needle moves to the previously set speed.



Push “<” or “>” within 6 seconds of the speedometer or tachometer needle moving to change the setting of the desired speed, then turn the indicator mode to “ON” by pushing the “ON/OFF” button.

Pushing and holding the button changes values at a faster rate.

If the satellite switch is not operated for some time, the multi-information display returns to its previously displayed content.



The yellow indicator is displayed to indicate that the desired speed has been set.

### ■ Speed indicator display conditions and vehicle speed setting range

Vehicle speed setting range: Approximately 30 to 100 mph  
(approximately 50 to 160 km/h)

When the maximum speed is selected, the speed indicator comes on only in red.

### ■ Tacho indicator display conditions and engine speed setting range

Engine rpm setting range: Approximately 2000 to 6500 rpm (r/min)

When the maximum rpm is selected, the tacho indicator comes on only in red.

 NOTICE**■ To prevent damage to the engine and its components**

- Do not let the indicator needle of the tachometer enter the red zone, which indicates the maximum engine speed.
- The engine may be overheating if the temperature gauge is in the red zone (H). In this case, immediately stop the vehicle in a safe place, and check the engine after it has cooled completely. (→P. 513)

## 2-2. Instrument cluster

# Indicators and warning lights

The indicator and warning lights on the instrument cluster and center panel inform the driver of the status of the vehicle's various systems.

### ► Instrument cluster



The units used on the speedometer and the tachometer gauge display may differ depending on the model/type.

### ► Center panel



**Indicators**

The indicators inform the driver of the operating state of the vehicle's various systems.



Turn signal indicator  
(→P. 154)



Headlight high beam indicator (→P. 174)



Headlight indicator  
(U.S.A.) (→P. 172)



(Canada)

Tail light indicator  
(→P. 172)



Front fog light indicator  
(→P. 176)



(vehicles with an automatic transmission)

Shift position and shift range indicators (→P. 146)



(vehicles with an automatic transmission)

"ECT SNOW" indicator  
(→P. 147)



(vehicles with a manual transmission)

"ETCS SNOW" indicator  
(→P. 153)



(vehicles with an automatic transmission)

"ECT PWR" indicator  
(→P. 147)



Cruise control indicator  
(→P. 186)



(if equipped)

Intuitive parking assist indicator (→P. 190)



\*1,2

Slip indicator (→P. 197)



\*1

VSC off indicator  
(→P. 198)



\*1

SRS airbag on-off indicator (→P. 109)

\*1: These lights turn on when the “ENGINE START STOP” switch is turned to IGNITION ON mode to indicate that a system check is being performed. They will turn off after the engine is started, or after a few seconds. There may be a malfunction in a system if a light does not come on, or if the lights do not turn off. Have the vehicle inspected by your Lexus dealer.

\*2: The light flashes to indicate that the system is operating.

**Warning lights**

Warning lights inform the driver of malfunctions in any of the vehicle’s systems. (→P. 471)



\*: These lights turn on when the “ENGINE START STOP” switch is turned to IGNITION ON mode to indicate that a system check is being performed. They will turn off after the engine is started, or after a few seconds. There may be a malfunction in a system if a light does not come on, or if the lights do not turn off. Have the vehicle inspected by your Lexus dealer.

**CAUTION**

**If a safety system warning light does not come on**

Should a safety system light such as the ABS and SRS warning light not come on when you start the engine, this could mean that these systems are not available to help protect you in an accident, which could result in death or serious injury. Have the vehicle inspected by your Lexus dealer immediately if this occurs.

## Multi-information display

The multi-information display presents the driver with a variety of driving-related data, including the current outside air temperature.



- Trip information (→P. 168)

Displays driving range, fuel consumption and other cruising related information.

- Satellite switch mode display (→P. 339)

This switch is used to configure various function settings.

- Intuitive parking assist display (if equipped) (→P. 190)

Automatically displayed when using intuitive parking assist.

- Warning messages (→P. 481)

Automatically displayed when a malfunction occurs in one of the vehicle's systems.

## Trip information



Display items can be switched by pushing the “DISP” switch.

### ■ Outside temperature

OUTSIDE  
75 °F

Displays the outside air temperature.

The temperature range that can be displayed is from -40°F (-40°C) to 122°F (50°C).

When the temperature drops to 37°F (3°C), the digits of the display will flash for 10 seconds.

### ■ Driving range

RANGE APPROX  
274 MI

Displays the estimated maximum distance that can be driven with the quantity of fuel remaining.

- This distance is computed based on your average fuel consumption. As a result, the actual distance that can be driven may differ from that displayed.
- When only a small amount of fuel is added to the tank, the display may not be updated. When refueling, turn the “ENGINE START STOP” switch off. If the vehicle is refueled without turning the “ENGINE START STOP” switch off, the display may not be updated.



### ■ Average fuel consumption



Displays the average fuel consumption since the function was reset.

- The function can be reset by pushing the “DISP” switch for longer than one second when the average fuel consumption is displayed.
- Use the displayed average fuel consumption as a reference.

### ■ Average fuel consumption after refueling



Displays the average fuel consumption since the vehicle was last refueled.

Use the displayed average fuel consumption as a reference.

### ■ Current fuel consumption

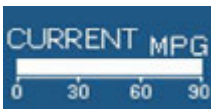

Displays the current rate of fuel consumption.

### ■ Average vehicle speed



Displays the average vehicle speed since the engine was started or the function was reset.

The function can be reset by pushing the “DISP” switch for longer than one second when the average vehicle speed is displayed.

■ **Gear position display**  
(vehicles with an automatic transmission only)



Indicates the current gear, and the range of gears that is available when the shift lever is in the D or S position. The gear range is shown by the number of dots (●) and the current gear is shown as a number. The transmission automatically selects the gears within the driver selected gear range.

In the illustration to the left, a range of 6 available gears (1 through 6) has been selected by the driver. (The shift lever is in the D or S position with 6 ranges enabled.) It is possible for the transmission to automatically select between all 6 of the gears. In this case, the transmission has selected third gear.

---

■ **System check display**

After switching the “ENGINE START STOP” switch to IGNITION ON mode, “CHECK” is displayed while system operation is checked. When the system check is complete, “COMPLETED” is displayed before returning to the normal screen.

■ **Outside temperature display**

In the following situations, the correct outside temperature may not be displayed, or the display may take longer than normal to change.

- When stopped, or driving at low speeds (less than 12 mph [20 km/h])
- When the outside temperature has changed suddenly (at the entrance/exit of a garage, tunnel, etc.)

 **CAUTION****■ The information display at low temperatures**

Allow the interior of the vehicle to warm up before using the liquid crystal information display. At extremely low temperatures, the information display monitor may respond slowly, and display changes may be delayed.

For example, there is a lag between the driver's downshifting and the new gear number appearing on the display. In this case, wait until the display changes and take care not to downshift again, causing rapid and excessive engine braking and possibly an accident resulting in death or serious injury.



## 2-3. Operating the lights and windshield wipers

### Headlight switch

The headlights can be operated manually or automatically.

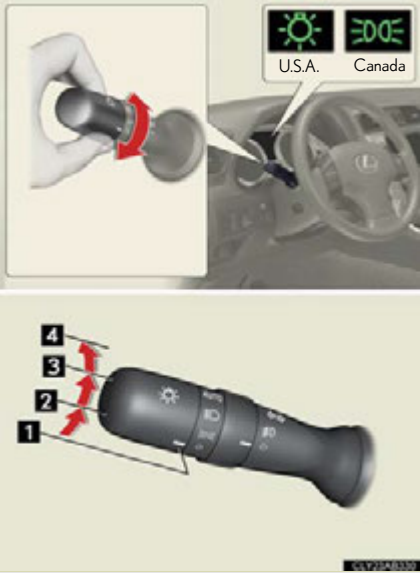

#### ► Type A

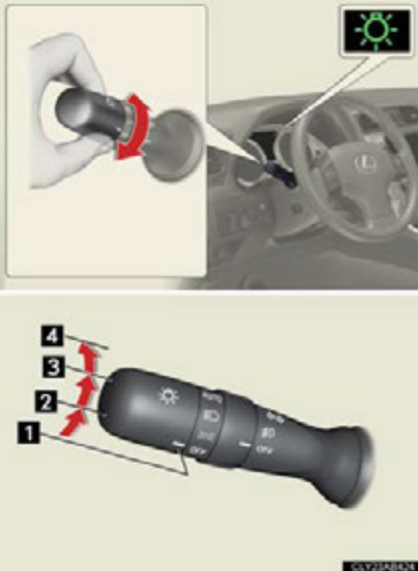

- 1**  The daytime running lights turn on
- 2**  The side marker, parking (vehicles with halogen headlights), daytime running lights, tail, license plate and instrument panel lights turn on.
- 3**  The headlights and all lights listed above (except daytime running lights) turn on.
- 4** **AUTO** The headlights, parking lights, daytime running lights and other lights turn on and off automatically. (When the “ENGINE START STOP” switch is in IGNITION ON mode)

## ► Type B



- 1 **OFF** The daytime running lights turn on.
- 2  The side marker, parking (vehicles with halogen headlights), daytime running lights, tail, license plate and instrument panel lights turn on.
- 3  The headlights and all lights listed above (except daytime running lights) turn on.
- 4 **AUTO** The headlights, parking lights, daytime running lights and other lights turn on and off automatically. (When the “ENGINE START STOP” switch is in IGNITION ON mode)

### Turning on the high beam headlights

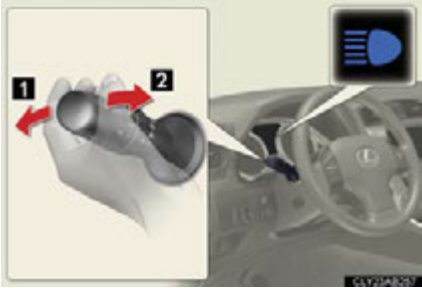

**1** With the headlights on, push the lever forward to turn on the high beams.

Pull the lever back to the center position to turn the high beams off.

**2** Pull the lever toward you to turn on the high beams.

Release to turn them off. You can flash the high beams with the headlights on or off.

### Daytime running light system

- Vehicles with halogen headlights: to make your vehicle more visible to other drivers, the headlights turn on automatically (at a reduced intensity) whenever the engine is started and the parking brake is released. Daytime running lights are not designed for use at night.

Vehicles with discharge headlights: to make your vehicle more visible to other drivers, the parking lights turn on automatically (at a increased intensity) whenever the engine is started and the parking brake is released. Daytime running lights are not designed for use at night.

- Compared to turning on the headlights, the daytime running light system offers greater durability and consumes less electricity, so it can help improve fuel economy.

### Headlight control sensor

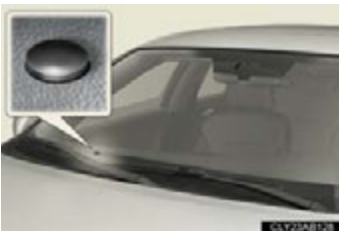

The sensor may not function properly if an object is placed on the sensor, or anything that blocks the sensor is affixed to the windshield.

Doing so interferes with the sensor detecting the level of ambient light and may cause the automatic headlight system to malfunction.

### ■ Automatic light off system

This system is active when the “ENGINE START STOP” switch is in IGNITION ON mode and the headlight lever is in any position other than  or **OFF**.

- When the headlights come on: The headlights and tail lights turn off 30 seconds after a door is opened and closed if the “ENGINE START STOP” switch has been switched to ACCESSORY mode or turned OFF. (The lights turn off immediately if  on the key is pressed after all doors are locked.)
- When only the tail lights come on: The tail lights turn off automatically if the “ENGINE START STOP” switch is switched to ACCESSORY mode or turned OFF and driver’s door is opened.

To turn the lights on again, switch to IGNITION ON mode, or turn the light switch off once and then back to  or .

### ■ Automatic headlight leveling system (vehicles with discharge headlights)

The level of the headlights is automatically adjusted according to the number of passengers and the loading condition of the vehicle to ensure that the headlights do not interfere with other road users.

### ■ Customization that can be configured at Lexus dealer

Settings (e.g. light sensor sensitivity) can be changed.  
(Customizable features →P. 553)

#### NOTICE

#### ■ To prevent battery discharge

Do not leave the lights on longer than necessary when the engine is not running.

## 2-3. Operating the lights and windshield wipers

### Fog light switch

The fog lights improve visibility in difficult driving conditions, such as in rain or fog. They can be turned on only when the headlights are on low beam.

► Type A

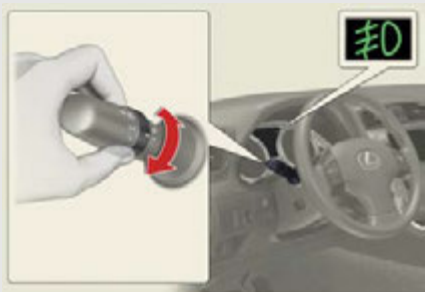

1 **0** Turns the front fog lights off

2 **⊘** Turns the front fog lights on

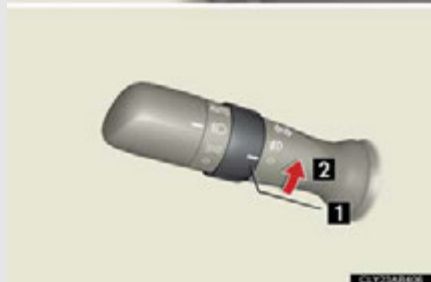



## ► Type B

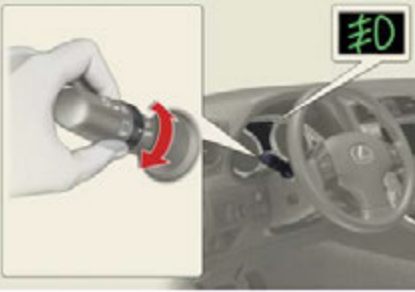

1 **OFF** Turns the front fog lights off

2 **☞** Turns the front fog lights on

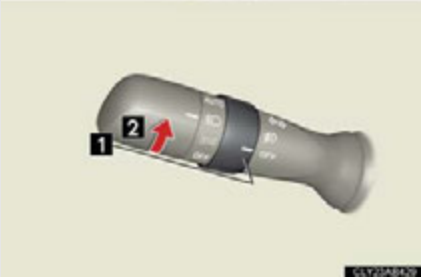

## 2-3. Operating the lights and windshield wipers





### Windshield wipers and washer

#### ■ Intermittent wiper with interval adjuster (if equipped)

Wiper intervals can be adjusted for intermittent operation (wiper operate at a set interval).

#### ▶ Type A



- 1  Off
- 2  Intermittent windshield wiper operation
- 3  Low speed windshield wiper operation
- 4  High speed windshield wiper operation
- 5  Temporary operation

Releasing the lever returns to



► Type B

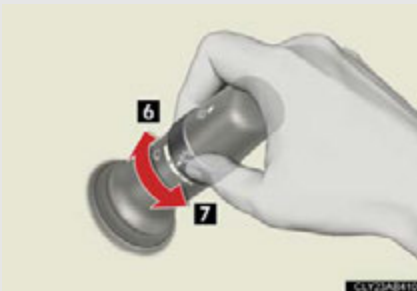

- 1 **OFF** Off
- 2 **INT** Intermittent windshield wiper operation
- 3 **LO** Low speed windshield wiper operation
- 4 **HI** High speed windshield wiper operation
- 5 **MIST** Temporary operation  
Releasing the lever returns to **OFF**.

- 6 Increases the intermittent windshield wiper frequency
- 7 Decreases the intermittent windshield wiper frequency



**8** Washer/wiper operation

Wipers operate automatically. (After operating several times, the wipers operate one more time after a short delay to prevent dripping.)

**■** Rain-sensing windshield wipers (if equipped)





When **AUTO** is selected, the wipers will operate automatically when the sensor detects falling rain. The system automatically adjusts wiper timing according to rain volume and vehicle speed.

The wiper operation is selected as follows by turning the switch ring.

When **AUTO** is selected, the sensor sensitivity can be also adjusted:

► Type A



- 1**  Off
- 2** **AUTO** Rain-sensing windshield wiper operation
- 3**  Low speed windshield wiper operation
- 4**  High speed windshield wiper operation
- 5**  Temporary operation

Releasing the lever returns to



► Type B



- 1 **OFF** Off
- 2 **AUTO** Rain-sensing windshield wiper operation
- 3 **LO** Low speed windshield wiper operation
- 4 **HI** High speed windshield wiper operation
- 5 **MIST** Temporary operation  
Releasing the lever returns to **OFF**.

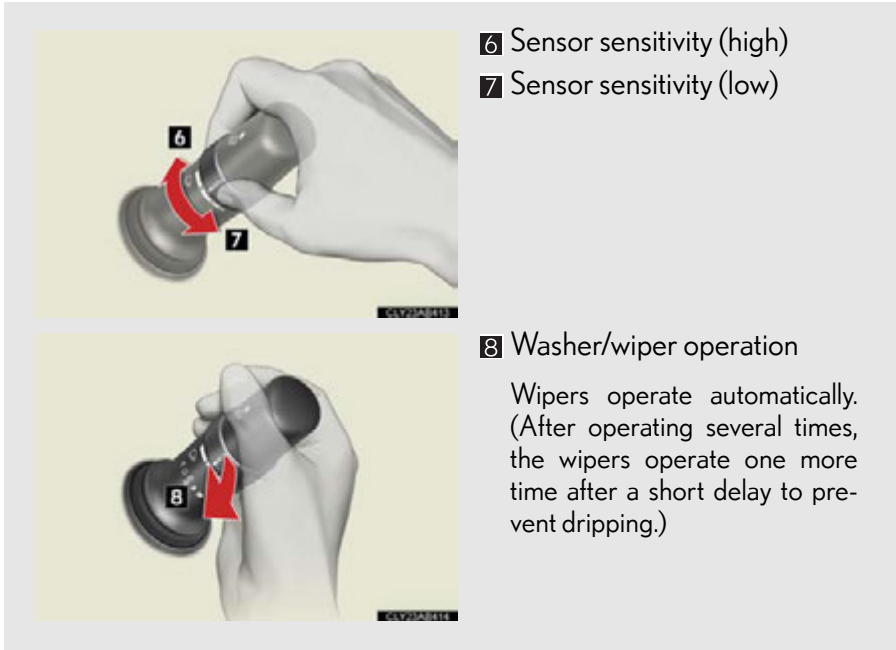

■ **The windshield wipers and washer can be operated when**

The “ENGINE START STOP” switch is in IGNITION ON mode.

■ **Effects of vehicle speed on wiper operation**

Vehicle speed affects the following even when the wipers are not in “AUTO” mode.

- Intermittent wiper interval
- Wiper operation when the washer is being used (delay until drip prevention wiper sweep occurs)

Low speed wiper operation selected, wiper operation will be switched from low speed to intermittent wiper operation only when the vehicle is stationary.

(However, the mode cannot be switched when the adjustment dial for the intermittent wiper interval is set to the lowest setting.)

### ■ Raindrop sensor (vehicles with rain-sensing windshield wipers)



- The sensor judges the amount of rain-drops.

- If the wiper switch is turned to the “AUTO” position while the “ENGINE START STOP” switch is in IGNITION ON mode, the wiper will operate once to show that auto mode is activated.
- If the temperature of the raindrop sensor is 194°F (90°C) or higher, or -22°F (-30°C) or lower, automatic operation may not occur. In this case, operate the wipers in any mode other than “AUTO”.

### ■ Outside rear view mirror defogger activation linked to windshield wiper operation

The outside rear view mirror defogger automatically turns on when you operate the windshield wipers.

### ■ If no windshield washer fluid sprays

If there is washer fluid in the windshield washer fluid reservoir and no washer fluid sprays, the nozzle may be blocked. In this case, contact your Lexus dealer.

### ■ Customization that can be configured at Lexus dealer

Settings (e.g. drip prevention function) can be changed.  
(Customizable features →P. 553)

### CAUTION

#### ■ Caution regarding the use of windshield wipers in “AUTO” mode (vehicles with rain-sensing windshield wipers)

The windshield wipers may operate unexpectedly if the sensor is touched or the windshield is subjected vibration in “AUTO” mode. Take care that your fingers etc. do not become caught in the windshield wipers.

#### ■ Caution regarding the use of washer fluid

When it is cold, do not use the washer fluid until the windshield becomes warm. The fluid may freeze on the windscreen and cause low visibility. This may lead to an accident, resulting in death or serious injury.

### NOTICE

#### ■ When the windshield is dry

Do not use the wipers, as they may damage the windshield.

#### ■ When a nozzle becomes blocked

Do not try to clear it with a pin or other object. The nozzle will be damaged.

#### ■ When there is no washer fluid spray from the nozzle

Damage to the washer fluid pump may be caused if the lever is pulled toward you and held continually.



## 2-3. Operating the lights and windshield wipers

### Headlight cleaner switch\*

Washer fluid can be sprayed on the headlights.



Press the switch to clean the headlights.

2

When driving

#### ■ The headlight cleaner can be operated when

The “ENGINE START STOP” switch is in IGNITION ON mode and the headlight switch is turned on.

#### ■ Windshield washer linked operation

Only for the first time when the windshield washer is operated with the “ENGINE START STOP” switch in IGNITION ON mode and the headlights on, the headlight cleaner will operate once. (→P. 178)

#### ■ When using the headlight cleaner

The washer fluid will spray out into the surrounding area and may get on clothes, items etc. Therefore, check the surrounding area before using the headlight cleaner.

#### NOTICE

#### ■ When the washer fluid tank is empty

Do not use this function when the washer fluid tank is empty. This may cause the washer fluid pump to overheat.

\*: If equipped

## 2-4. Using other driving systems

# Cruise control

Use the cruise control to maintain a set speed without depressing the accelerator pedal.



- 1 Indicator
- 2 Cruise control switch

### ■ Setting the vehicle speed



Press the “ON-OFF” button to activate the cruise control.

Cruise control indicator will come on.

Press the button again to deactivate the cruise control.



Accelerate or decelerate the vehicle to the desired speed, and push the lever down to set the speed.

The vehicle speed at the moment the lever is released becomes the set speed.

## ■ Adjusting the set speed

To change the set speed, operate the lever until the desired set speed is obtained.



- 1 Increases the speed
- 2 Decreases the speed

Fine adjustment: Momentarily move the lever in the desired direction.

Large adjustment: Hold the lever in the desired direction.

The set speed will be increased or decreased as follows:

Fine adjustment: By approximately 1 mph (1.6 km/h) each time the lever is operated.

Large adjustment: The set speed can be increased or decreased continually until the lever is released.

## ■ Canceling and resuming the constant speed control



- 1 Pulling the lever toward you cancels the constant speed control.

The speed setting is also canceled when the brakes are applied or the clutch pedal (manual transmission only) is depressed.

- 2 Pushing the lever up resumes the constant speed control.

Resuming is available when the vehicle speed is more than approximately 25 mph (40 km/h)

### ■ Cruise control can be set when

- The shift lever is in the D or range 4 or higher of S has been selected.
- Range 4 or higher has been selected by using the paddle shift.  
(vehicles with an automatic transmission)
- Vehicle speed is above approximately 25 mph (40 km/h).

### ■ Accelerating after setting the vehicle speed

- The vehicle can be accelerated normally. After acceleration, the set speed resumes.
- Even without canceling the cruise control, the set speed can be increased by first accelerating the vehicle to the desired speed and then pushing the lever down to set the new speed.

### ■ Automatic cruise control cancelation

Cruise control will stop maintaining the vehicle speed in any of the following situations.

- Actual vehicle speed falls more than approximately 10 mph (16 km/h) below the preset vehicle speed.  
At this time, the memorized set speed is not retained.
- Actual vehicle speed is below approximately 25 mph (40 km/h).
- VSC is activated.

### ■ If the cruise control indicator light flashes

Press the "ON-OFF" button once to deactivate the system, and then press the button again to reactivate the system.

If the cruise control speed cannot be set or if the cruise control cancels immediately after being activated, there may be a malfunction in the cruise control system. Have the vehicle inspected by your Lexus dealer.

 **CAUTION****■ To avoid operating the cruise control by mistake**

Switch the cruise control off using the “ON-OFF” button when not in use.

**■ Situations unsuitable for cruise control**

Do not use cruise control in any of the following situations.

Doing so may result in loss of control and could cause an accident resulting in death or serious injury.

- In heavy traffic
- On roads with sharp bends
- On winding roads
- On slippery roads, such as those covered with rain, ice or snow
- On steep hills  
Vehicle speed may exceed the set speed when driving down a steep hill.
- During emergency towing

## 2-4. Using other driving systems

### Intuitive parking assist\*

The distance to obstacles measured by the sensors is communicated via the multi-information display and a buzzer when parallel parking or maneuvering into a garage. Always check the surrounding area when using this system.

#### ▶ With navigation system

For vehicles equipped with a navigation system, refer to the separate “Navigation System Owner’s Manual” for further details.

#### ▶ Without navigation system

#### ■ Types of sensors



- 1 Front corner sensors
- 2 Rear corner sensors
- 3 Back sensors

#### ■ Multi-information display (→P. 167)



- 1 Front corner sensor operation
- 2 Rear corner sensor operation
- 3 Back sensor operation

\*: If equipped

### ■ Intuitive parking assist switch (→P. 339)

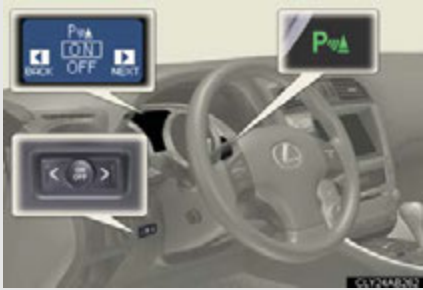



When on, an indicator is displayed to inform the driver that the function is operational.



### The distance display and buzzer

When a sensor detects an obstacle, the direction of and the approximate distance to the obstacle are displayed and the buzzer sounds.





#### ■ Front corner sensors

Multi-information display	Approximate distance to obstacle	Buzzer
	1.6 to 1.3 ft. (50 to 40 cm)	Medium
	1.3 to 1.0 ft. (40 to 30 cm)	Fast
	1.0 ft. (30 cm) or less	Continuous

**Rear corner sensors**

Multi-information display	Approximate distance to obstacle	Buzzer
	1.6 to 1.2 ft. (50 to 37.5 cm)	Medium
	1.2 to 0.8 ft. (37.5 to 25 cm)	Fast
	0.8 ft. (25 cm) or less	Continuous

**Back sensors**

Multi-information display	Approximate distance to obstacle	Buzzer
	4.9 to 2.0 ft. (150 to 60 cm)	Slow
	2.0 to 1.5 ft. (60 to 45 cm)	Medium
	1.5 to 1.1 ft. (45 to 35 cm)	Fast
	1.1 ft. (35 cm) or less	Continuous



## Detection range of the sensors

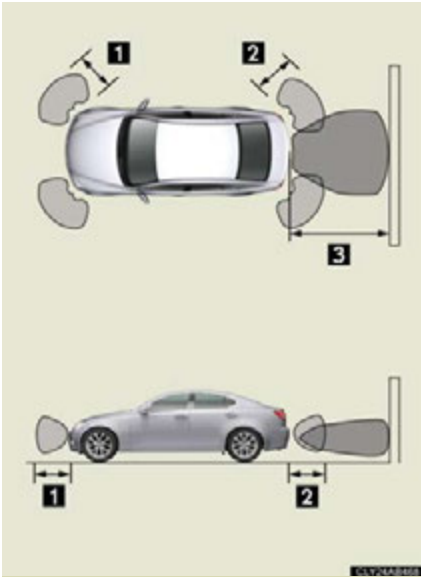

- ❶ Approximately 1.6 ft. (50 cm)
- ❷ Approximately 1.6 ft. (50 cm)
- ❸ Approximately 4.9 ft. (150 cm)

The diagram shows the detection range of the sensors. Note that the sensors cannot detect obstacles that are extremely close to the vehicle.

The range of the sensors may change depending on the shape of the object etc.

### ■ Sensor detection information

- Certain vehicle conditions and the surrounding environment may affect the ability of the sensor to correctly detect obstacles. Particular instances where this may occur are listed below.
  - There is dirt, snow or ice on the sensor.
  - The sensor is frozen.
  - The sensor is covered in any way.
  - The vehicle is leaning considerably to one side.
  - On an extremely bumpy road, on an incline, on gravel, or on grass.
  - The vicinity of the vehicle is noisy due to vehicle horns, motorcycle engines, air brakes of large vehicles, or other loud noises producing ultrasonic waves.
  - There is another vehicle equipped with parking assist sensors in the vicinity.
  - The sensor is coated with a sheet of spray or heavy rain.
  - The vehicle is equipped with a fender pole or wireless antenna.
  - Towing eyelets are installed.
  - The bumper or sensor receives a strong impact.
  - The vehicle is approaching a tall or curved curb.
  - In harsh sunlight or intense cold weather.

In addition to the examples above, there are instances in which, because of their shapes, signs and other objects may be judged by the sensor to be closer than they are.

- The shape of the obstacle may prevent the sensor from detecting it. Pay particular attention to the following obstacles.
  - Wires, fences, ropes etc.
  - Cotton, snow and other materials that absorb radio waves
  - Sharply-angled objects
  - Low obstacles
  - Tall obstacles with upper sections projecting outwards in the direction of your vehicle

### ■ When the display flashes and a message is displayed

→P. 481

### ■ Certification

- ▶ For vehicles sold in the U.S.A.

This device complies with Part 15 of the FCC Rules. Operation is subject to the following two conditions: (1) this device may not cause harmful interference, and (2) this device must accept any interference received, including interference that may cause undesired operation.

- ▶ For vehicles sold in Canada

This ISM device complies with Canadian ICES-001.

Cet appareil ISM est conforme à la norme NMB-001 du Canada.

### ■ Customization that can be configured at Lexus dealer

Settings (e.g. buzzer volume) can be changed. (Customizable features →P. 553)

#### CAUTION

##### ■ Caution when using the intuitive parking sensor

Observe the following precautions.

Failing to do so may result in the vehicle being unable to be driven safely and possibly cause an accident.

- Do not use the sensor at speeds in excess of 6 mph (10 km/h).
- Do not attach any accessories within the sensor range.

#### NOTICE

##### ■ Notes when washing the vehicle

Do not apply intensive bursts of water or steam to the sensor area.  
Doing so may result in the sensor malfunctioning.

## 2-4. Using other driving systems

### Driving assist systems

To help enhance driving safety and performance, the following systems operate automatically in response to various driving situations. Be aware, however, that these systems are supplementary and should not be relied upon too heavily when operating the vehicle.

#### ■ ABS (Anti-lock Brake System)

Helps to prevent wheel lock when the brakes are applied suddenly, or if the brakes are applied while driving on a slippery road surface.

#### ■ Brake assist

Generates an increased level of braking force after the brake pedal is depressed, when the system detects a panic stop situation.

#### ■ VSC (Vehicle Stability Control)

Helps the driver to control skidding when swerving suddenly or turning on slippery road surfaces.

#### ■ TRAC (Traction Control)

Maintains drive power and prevents the rear wheels (2WD models) or all wheels (AWD models) from spinning when starting the vehicle or accelerating on slippery roads.

#### ■ Hill-start assist control (vehicles with an automatic transmission)

Helps to prevent the vehicle from rolling backward when starting on an incline or slippery slope.

#### ■ EPS (Electric Power Steering)

Employs an electric motor to reduce the amount of effort needed to turn the steering wheel.

### ■ VDIM (Vehicle Dynamics Integrated Management)

Provides integrated control of the ABS, brake assist, TRAC, VSC, hill-start assist control, and EPS systems.

Helps to maintain vehicle stability when swerving on slippery road surfaces by controlling the brakes, engine output and steering assist.

### When the VSC/TRAC/hill-start assist control systems are operating



The slip indicator light flashes to indicate that the VSC/TRAC/hill-start assist control systems have been engaged.

The stop lights and high mounted stoplight turn on when the hill-start assist control system is operating.

## To disable TRAC/VSC

If the vehicle gets stuck in fresh snow or mud, TRAC and VSC may reduce power from the engine to the wheels. You may need to turn the system off to enable you to rock the vehicle in order to free it.

### ■ Turning off TRAC



Quickly push and release the switch to turn off TRAC.

A message will be shown on the multi-information display.

Push the switch again to turn the system back on.

### ■ Turning off TRAC and VSC



Push and hold the switch for more than 3 seconds or more while the vehicle is stopped to turn off TRAC and VSC.

A message will be shown on the multi-information display and the VSC off indicator light will come on.

Push the switch again to turn the system back on.

■ **When the message is displayed on the multi-information display showing that TRAC has been disabled even if the VSC off switch has not been pressed**

TRAC and hill-start assist control cannot be operated. Contact your Lexus dealer.

■ **Automatic reactivation of the TRAC/VSC systems**

If the TRAC/VSC systems are turned off, re-starting the engine will automatically reactivate them.

■ **Automatic TRAC reactivation**

If only the TRAC system is turned off, the TRAC system will turn on when vehicle speed increases.

■ **Automatic TRAC and VSC reactivation**

If the TRAC and VSC systems are turned off, the systems will not turn on even when vehicle speed increases.

■ **Sounds and vibrations caused by the ABS, brake assist, VSC, TRAC and hill-start assist control systems**

- A sound may be heard from the engine compartment if the brake pedal is depressed repeatedly when the engine is started or just after the vehicle begins to move. This sound does not indicate that a malfunction has occurred in any of these systems.
- Any of the following conditions may occur when the above systems are operating. None of these indicates that a malfunction has occurred.
  - Vibrations may be felt through the vehicle body and steering.
  - A motor sound may be heard after the vehicle comes to a stop.
  - The brake pedal may pulsate slightly when the ABS is activated.
  - The brake pedal may move down slightly after the ABS is activated.

### ■ Hill-start assist control is operational when

- The shift lever is in the D or S position.
- The brake pedal is not depressed.
- The vehicle rolls backward.

### ■ EPS operation sound

When the steering wheel operates, a motor sound (whirring sound) may be heard. This does not indicate a malfunction.

### ■ Reduced effectiveness of EPS

The effectiveness of EPS is reduced to prevent the system from overheating when there is frequent steering input over an extended period of time. The steering wheel may feel heavy as a result. Should this occur, refrain from excessive steering input or stop the vehicle and turn the engine OFF. The system should return to normal within 10 minutes.

### ■ If the slip indicator comes on

It may indicate a malfunction in the VSC, TRAC or hill start assist control function. Contact your Lexus dealer.

### CAUTION

#### ■ The ABS does not operate effectively when

- The limits of tire gripping performance have been exceeded.
- The vehicle hydroplanes while driving at high speed on the wet or slick road.

#### ■ Stopping distance when the ABS is operating may exceed that of normal conditions

The ABS is not designed to shorten the vehicle's stopping distance. Always maintain a safe distance from the vehicle in front of you in the following situations.

- When driving on dirt, gravel or snow-covered roads
- When driving with tire chains
- When driving over bumps in the road
- When driving over roads with potholes or roads with uneven surfaces



 **CAUTION****■ TRAC may not operate effectively when**

Directional control and power may not be achievable while driving on slippery road surfaces, even if the TRAC system is operating.

Do not drive the vehicle in conditions where stability and power may be lost.

**■ If hill-start assist control does not operate effectively (vehicles with an automatic transmission)**

Do not overly rely on the hill-start assist control. The hill-start assist control may not operate effectively on steep inclines and roads covered in ice.

**■ When the VSC is activated**

The slip indicator light flashes. Always drive carefully. Reckless driving may cause an accident, resulting in death or serious injury. Exercise particular care when the indicator light flashes.

**■ When TRAC and VSC are off**

Be especially careful and drive at a speed appropriate to the road conditions. As these are systems to help enhance vehicle stability and driving force, do not turn off TRAC and VSC unless necessary.

**■ Replacing tires**

Make sure that all tires are of the specified size, brand, tread pattern and total load capacity. In addition, make sure that the tires are inflated to the recommended tire pressure level.

The ABS, VSC and TRAC systems will not function correctly if different tires are fitted on the vehicle.

Contact your Lexus dealer for further information when replacing tires or wheels.

**■ Handling of tires and suspension**

Using tires with any kind of problem or modifying the suspension will affect the driving assist systems, and may cause the system to malfunction.

## 2-5. Driving information

# Cargo and luggage

Take notice of the following information about storage precautions, cargo capacity and load.

- Stow cargo and luggage in the trunk whenever possible. Be sure all items are secured in place.
- Be careful to keep the vehicle level. Placing the weight as far forward as possible helps maintain vehicle balance.
- For better fuel economy, do not carry unnecessary weight.

### Capacity and distribution

Cargo capacity depends on the total weight of the occupants.

(Cargo capacity) = (Total load capacity) – (Total weight of occupants)

#### Steps for Determining Correct Load Limit—

- (1) Locate the statement “The combined weight of occupants and cargo should never exceed XXX kg or XXX lbs.” on your vehicle’s placard.
- (2) Determine the combined weight of the driver and passengers that will be riding in your vehicle.
- (3) Subtract the combined weight of the driver and passengers from XXX kg or XXX lbs.
- (4) The resulting figure equals the available amount of cargo and luggage load capacity.

For example, if the “XXX” amount equals 1400 lbs. and there will be five 150 lb passengers in your vehicle, the amount of available cargo and luggage load capacity is 650 lbs. (1400 – 750 (5 × 150) = 650 lbs.)

- (5) Determine the combined weight of luggage and cargo being loaded on the vehicle. That weight may not safely exceed the available cargo and luggage load capacity calculated in Step 4.

(6) If your vehicle will be towing a trailer, load from your trailer will be transferred to your vehicle. Consult this manual to determine how this reduces the available cargo and luggage load capacity of your vehicle.

Lexus does not recommend towing a trailer with your vehicle. Your vehicle is not designed for trailer towing.

### Example on your vehicle

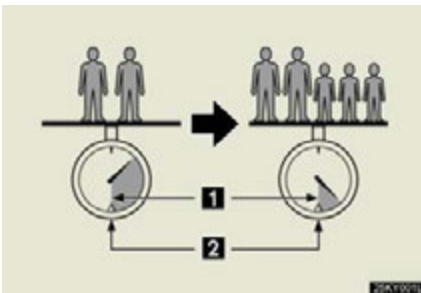

- 1 Cargo capacity
- 2 Total load capacity

When 2 people with the combined weight of 366 lb. (166 kg) are riding in your vehicle, which has a total load capacity of 825 lb. (375 kg), the available amount of cargo and luggage load capacity will be as follows:

$$825 \text{ lb.} - 366 \text{ lb.} = 459 \text{ lb.} \quad (375 \text{ kg} - 166 \text{ kg} = 209 \text{ kg})$$

In this condition, if 3 more passengers with the combined weight of 388 lb. (176 kg) get on, the available cargo and luggage load will be reduced as follows:

$$459 \text{ lb.} - 388 \text{ lb.} = 71 \text{ lb.} \quad (209 \text{ kg} - 176 \text{ kg} = 33 \text{ kg})$$

As shown in the example above, if the number of occupants increases, the cargo and luggage load will be reduced by an amount that equals the increased weight due to the additional occupants. In other words, if an increase in the number of occupants causes an excess of the total load capacity (combined weight of occupants plus cargo and luggage load), you must reduce the cargo and luggage on your vehicle.

### CAUTION

#### ■ Things that must not be carried in the trunk

The following things may cause a fire if loaded in the trunk.

- Receptacles containing gasoline
- Aerosol cans

#### ■ Storage precautions

Observe the following precautions.

Failing to do so may result in death or serious injury.

- Do not place cargo or luggage in or on the following locations as the item may get under the clutch, brake or accelerator pedal and prevent the pedals from being depressed properly, block the driver's vision, or hit the driver or passengers, causing an accident.
  - The feet of the driver
  - The front passenger or rear seats (when stacking items)
  - The package tray
  - The instrument panel
  - The dashboard
- Secure all items in the occupant compartment, as they may shift and injure someone during sudden braking, sudden swerving or an accident.

#### ■ Capacity and distribution

- Do not exceed the maximum axle weight rating or the total vehicle weight rating.
- Even if the total load of occupant's weight and the cargo load is less than the total load capacity, do not apply the load unevenly. Improper loading may cause deterioration of steering or braking control which may cause death or serious injury.

## 2-5. Driving information

# Vehicle load limits

Vehicle load limits include total load capacity, seating capacity, towing capacity and cargo capacity.

### ■ Total load capacity: 825 lb. (375 kg)

Total load capacity means the combined weight of occupants, cargo and luggage.

### ■ Seating capacity: 5 occupants (Front 2, Rear 3)

Seating capacity means the maximum number of occupants whose estimated average weight is 150 lb. (68 kg) per person.

### ■ Towing capacity

Lexus does not recommend towing a trailer with your vehicle.

### ■ Cargo capacity

Cargo capacity may increase or decrease depending on the weight and the number of occupants.

2

When driving

### ■ Total load capacity and seating capacity

These details are also described on the tire and loading information label. (→P. 424)

## CAUTION

### ■ Overloading the vehicle

Do not overload the vehicle.

It may not only cause damage to the tires, but also degrade steering and braking ability, resulting in an accident.

### Winter driving tips

Carry out the necessary preparations and inspections before driving the vehicle in winter. Always drive the vehicle in a manner appropriate to the prevailing weather conditions.

#### ■ Pre-winter preparations

- Use fluids that are appropriate to the prevailing outside temperatures.
  - Engine oil
  - Engine coolant
  - Washer fluid
- Have a service technician inspect the level and specific gravity of battery electrolyte.
- Have the vehicle fitted with four snow tires or purchase a set of tire chains for the rear tires.

Ensure that all tires are the specified size and the same brand, and that chains match the size of the tires.

#### ■ Before driving the vehicle

Perform the following according to the driving conditions.

- Do not try to forcibly open a window or move a wiper that is frozen. Pour warm water over the frozen area to melt the ice. Wipe away the water immediately to prevent it from freezing.
- To ensure proper operation of the climate control system fan, remove any snow that has accumulated on the air inlet vents in front of the windshield.
- Remove any ice that has accumulated on the vehicle chassis.
- Periodically check for and remove any excess ice or snow that may have accumulated in the wheel well or on the brakes.

### ■ When driving the vehicle

Accelerate the vehicle slowly and drive at a reduced speed suitable to road conditions.

### ■ When parking the vehicle

Park the vehicle and move the shift lever to P (automatic transmission) or 1 or R (manual transmission) without setting the parking brake. The parking brake may freeze up, preventing it from being released. If necessary, block the wheels to prevent inadvertent sliding or creeping.

## Selecting tire chains

Tire chains can be mounted on 16- and 17-inch tires. They cannot be mounted on 18-inch tires. Use the correct tire chain size when mounting the tire chains. Chain size is regulated for each tire size.

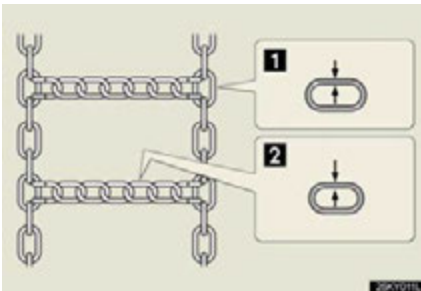

- 1 Side chain  
(0.12 in. [3 mm] in diameter)
- 2 Cross chain  
(0.16 in. [4 mm] in diameter)

## Regulations on the use of tire chains

- Regulations regarding the use of tire chains vary according to location and type of road. Always check local regulations before installing chains.
- Install the chains on the rear tires.
- Retighten the chains after driving 1/4—1/2 mile (0.5—1.0 km).

### ■ Snow chain installation

Observe the following precautions when installing and removing chains.

- Install and remove tire chains in a safe location.
- Install tire chains on the rear tires only. Do not install tire chains on front tires.
- Install the tire chains on rear tires as tightly as possible. Retighten chains after driving 1/4 - 1/2 mile (0.5 - 1.0 km).
- Install tire chains following the instructions provided in the accompanying instructions.

### CAUTION

#### ■ Driving with snow tires

Observe the following precautions to reduce the risk of accidents.

Failing to do so may result in a loss of vehicle control and cause death or serious injury.

- Use tires of the size specified for your vehicle.
- Maintain the recommended level of air pressure.
- Do not drive in excess of 75 mph (120 km/h), regardless of the type of snow tires being used.
- Use snow tires on all, not just some wheels.

#### ■ Driving with tire chains

Observe the following precautions to reduce the risk of accidents.

Failing to do so may result in the vehicle being unable to be driven safely, and may cause death or serious injury.

- Do not drive in excess of the speed limit specified for the tire chains being used, or 30 mph (50 km/h), whichever is lower.
- Avoid driving on bumpy road surfaces or over potholes.
- Avoid sudden turns and braking, as use of chains may adversely affect vehicle handling.
- Slow down sufficiently before entering a curve to ensure that vehicle control is maintained.



 NOTICE**■ Repairing or replacing snow tires**

Request repairs of and obtain replacement snow tires from Lexus dealers or legitimate tire retailers.

This is because the removal and attachment of snow tires affects the operation of the tire pressure warning system.

**■ Fitting tire chains**

The tire pressure warning system may not function correctly when tire chains are fitted.

## 2-5. Driving information

### Trailer towing

Lexus does not recommend towing a trailer with your vehicle. Lexus also does not recommend the installation of a tow hitch or the use of a tow hitch carrier for a wheelchair, scooter, bicycle, etc. Your Lexus is not designed for trailer towing or for the use of tow hitch mounted carriers.



## 2-5. Driving information

### Dinghy towing (vehicles with an automatic transmission)

Your vehicle is not designed to be dinghy towed (with 4 wheels on the ground) behind a motor home.



#### NOTICE

■ **To avoid serious damage to your vehicle**

Do not tow your vehicle with four wheels on the ground.

## 2-5. Driving information

### Dinghy towing (vehicles with a manual transmission)

Your vehicle can be dinghy towed in a forward direction (with 4 wheels on the ground) behind a motor home.

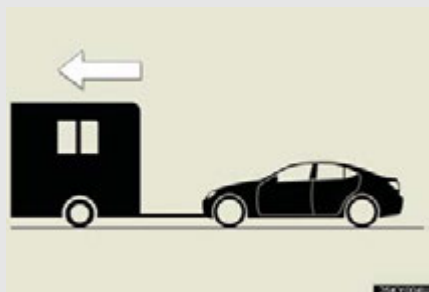

#### Towing your vehicle with 4 wheels on the ground

To prevent damage to your vehicle, perform the following procedures before towing.

**STEP 1** Shift the shift lever to neutral.

**STEP 2** Switch to ACCESSORY mode. (→P.143)

Ensure that the audio system and other powered devices have been turned off.

**STEP 3** Release the parking brake.

After towing, leave the engine in idle for at least 3 minutes before driving the vehicle.

#### ■ Necessary equipment and accessories

Specialized equipment and accessories are required for dinghy towing. Contact the service branch of the motor home manufacturer regarding recommended equipment.

 NOTICE**■ Dinghy towing direction**

Do not tow the vehicle backwards.  
Doing so may cause serious damage.

**■ To prevent the steering from locking**

Ensure the "ENGINE START STOP" switch is in ACCESSORY mode.

**3-1. Using the air conditioning system and defogger**

Automatic air conditioning system .....	216
Rear window and outside rear view mirror defoggers .....	224
Windshield wiper de-icer .....	225

**3-2. Using the audio system**

Audio system type .....	226
Using the radio .....	229
Using the CD player .....	237
Playing back MP3 and WMA discs .....	244
Operating an iPod .....	252
Operating a USB memory .....	260
Optimal use of the audio system .....	269
Using the AUX port .....	271
Using the steering wheel audio switches .....	273

**3-3. Using the Bluetooth® audio system**

Bluetooth® audio system .....	276
Using the Bluetooth® audio system .....	279
Operating a Bluetooth® enabled portable player .....	284
Setting up a Bluetooth® enabled portable player ...	287
Bluetooth® audio system setup .....	293

**3-4. Using the hands-free phone system (for mobile phones)**

Hands-free system for mobile phones .....	294
Using the hands-free system (for mobile phones) .....	298
Making a phone call .....	306
Setting a mobile phone .....	310
Security and system setup .....	315
Using the phone book .....	319

**3-5. Using the interior lights**

Interior lights list.....	325
• Interior lights .....	327
• Personal lights.....	327

**3-6. Using the storage features**

List of storage features .....	329
• Glove box .....	330
• Console boxes .....	330
• Overhead console .....	332
• Cup holders .....	332
• Bottle holders/ door pockets.....	334
• Auxiliary box.....	335

**3-7. Other interior features**

Sun visors .....	336
Vanity mirrors .....	337
Clock .....	338
Satellite switches .....	339
Ashtrays.....	342
Cigarette lighter .....	343
Power outlet .....	344
Seat heaters .....	345
Seat heaters and ventilators .....	348
Armrest .....	351
Rear sunshade .....	352
Trunk storage extension .....	354
Coat hooks .....	355
Floor mat .....	356
Trunk features .....	357
Garage door opener .....	360
Compass .....	366
Safety Connect .....	370

### 3-1. Using the air conditioning system and defogger

## Automatic air conditioning system

Air outlets and fan speed are automatically adjusted according to the temperature setting.

► With navigation system

Owners of models equipped with a navigation system should refer to the “Navigation System Owner’s Manual”.

► Without navigation system

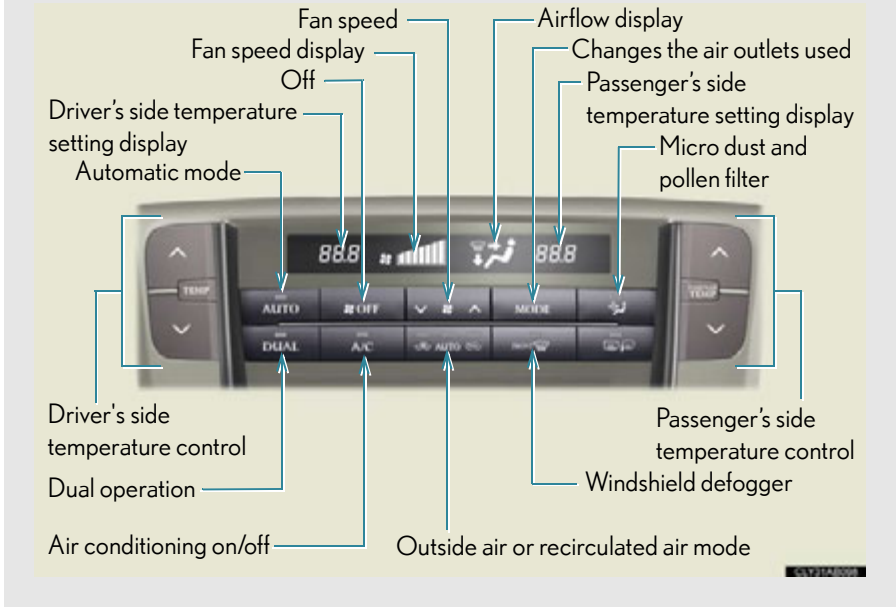

### Using the automatic mode

**STEP 1** Press .

The air conditioning system will begin to operate. Air outlets and fan speed are automatically adjusted according to the temperature setting.

**STEP 2** Press  to switch to automatic mode. (IS350 only)

Automatically switches between outside air and recirculated air modes.





**STEP 3** Press “^” on  to increase the temperature and “v” to decrease the temperature.

The temperature for the driver and passenger seats can be set separately.



## Adjusting the settings

### ■ Adjusting the temperature setting

Press “^” on  to increase the temperature and “v” to decrease the temperature.

The air conditioning system switches between individual and simultaneous modes each time  is pressed.

Dual mode (the indicator on  is on): The temperature for the left-hand seat and right-hand seat can be adjusted separately. Operating the passenger's side temperature control will enter dual mode.

Simultaneous mode (the indicator on  is off): Only  (driver's side) can be used to adjust the temperature for all seats.

### ■ Adjusting the fan speed

Press “^” (increase) or “v” (decrease) on .

Press  to turn the fan off.

#### ■ Changing the air outlets

Press **MODE** .

The air outlets switch each time **MODE** is pressed. The air flow shown on the display indicates the following.

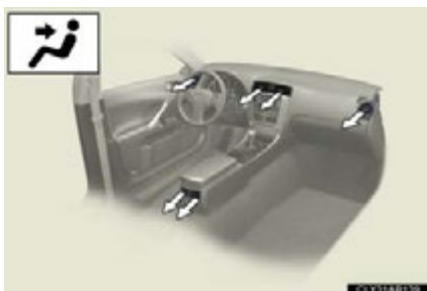

Upper body

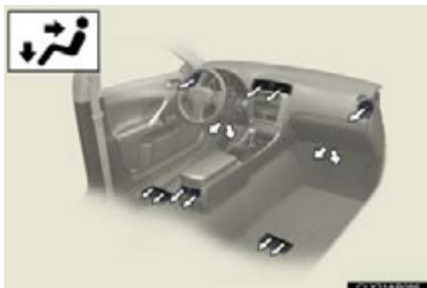

Upper body and feet

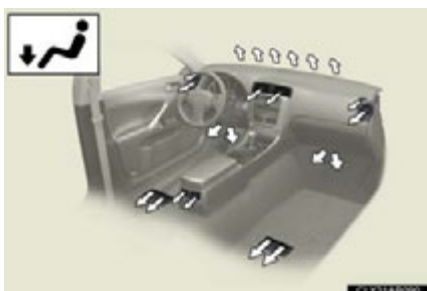

Feet

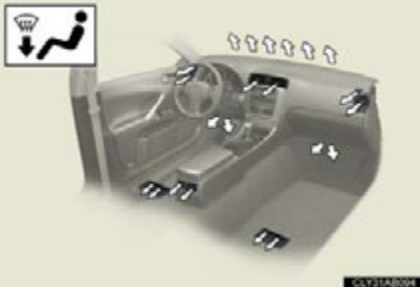



Feet and windshield

### ■ Switching between outside air and recirculated air modes



#### ▶ IS250

Press  .

The mode switches between  (recycles air inside the vehicle) and  (introduces air from outside the vehicle) modes each time  is pressed.

#### ▶ IS350

Press  .

The mode switches among  (recycles air inside the vehicle), "AUTO" and  (introduces air from outside the vehicle) modes each time  is pressed.

When the system is switched to automatic mode, the air conditioning system operates automatically.

### Defogging the windshield



Press  .

The air conditioning system operates automatically.

Recirculated air mode may automatically switch to  (outside air) mode when the ambient temperature is low.

### Micro dust and pollen filter



Press  .

Outside air mode switches to  (recirculated air) mode. Pollen is removed from the air and the air flows to the upper part of the body.

Usually the system will turn off automatically after approximately 1 to 3 minutes.

To stop the operation, press  again.

### Adjusting the sensitivity of the air intake control in automatic mode (IS350 only)

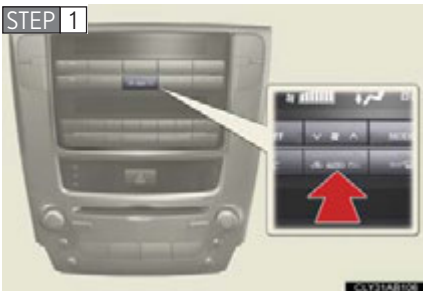

Press  for 2 or more seconds.



Press “^” (increase) or “v” (decrease) on  .

From -3 (low) to 3 (high) can be set.

### Adjusting the position of and opening and closing the air outlets

#### ► Front outlets (center)



- 1 Direct air flow to the left or right, up or down
- 2 Turn the knob to open or close the vent

#### ► Front outlets (right and left side)

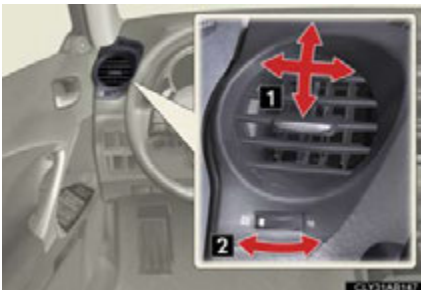

- 1 Direct air flow to the left or right, up or down
- 2 Turn the knob to open or close the vent

### ► Rear outlets

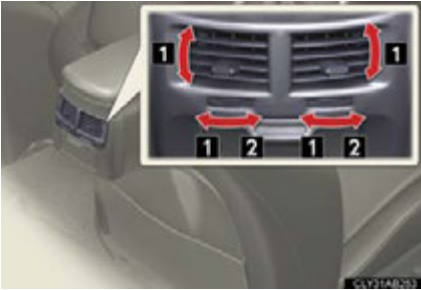

- 1 Direct air flow to the left or right, up or down
- 2 Turn the knob fully to the outside of the vehicle to close the vent

### ■ Using the automatic mode

Fan speed is adjusted automatically in accordance with the temperature setting and ambient conditions. As a result, the following may occur.

- Immediately after  is pressed, the fan may stop for a while until warm or cool air is ready to flow.
- Cool air may flow to the area around the upper body when the heater is on.

### ■ Using the system in recirculated air mode

The windows will fog up more easily if recirculated air mode is used for an extended period.

### ■ Switching between outside air and recirculated air modes

Recirculated air mode or outside air mode may be automatically switched in accordance with the temperature setting and the inside temperature.

### ■ Window defogger feature

Recirculated air mode may automatically switch to  (outside air) mode in situations where the windows need to be defogged.

### ■ When outside air temperature approaches 32°F (0°C)

The air conditioning system may not operate even when  is pressed.

### ■ When the indicator light on flashes

Press  and turn off the air conditioning system before turning it on once more. There may be a problem in the air conditioning system if the indicator light continues to flash. Turn the air conditioning system off and have it inspected by your Lexus dealer.

### ■ Automatic mode for air intake control (IS350 only)

In automatic mode, the system detects exhaust gas and other pollutants and automatically switches between outside air and recirculated air modes.

### ■ Micro dust and pollen filter

● In order to prevent the windshield from fogging up when the outside air is cold, the following may occur.

- Outside air mode does not switch to .
- The air conditioning system operates automatically.
- The operation cancels after 1 minute.

● In rainy weather, the windows may fog up. Press .

### ■ Air conditioning odors

● During use, various odors from inside and outside the vehicle may enter into and accumulate in the air conditioning system. This may then cause odor to be emitted from the vents.

● To reduce potential odors from occurring:

- It is recommended that the air conditioning system be set to outside air mode prior to turning the vehicle off.
- The start timing of the blower may be delayed for a short period of time immediately after the air conditioning system is started in automatic mode.

## CAUTION

### ■ To prevent the windshield from fogging up

Do not use  during cool air operation in extremely humid weather. The difference between the temperature of the outside air and that of the windshield can cause the outer surface of the windshield to fog up, blocking your vision.

## NOTICE

### ■ To prevent battery discharge

Do not leave the air conditioning system on longer than necessary when the engine is off.

### 3-1. Using the air conditioning system and defogger

## Rear window and outside rear view mirror defoggers

These features are used to defog the rear window, and to remove raindrops, dew and frost from the outside rear view mirrors.

► With navigation system

Owners of models equipped with a navigation system should refer to the “Navigation System Owner's Manual”.

► Without navigation system



#### On/off

The defoggers will automatically turn off after 15 to 60 minutes. The operation time changes according to the ambient temperature and vehicle speed.

■ The defogger can be operated when

The “ENGINE START STOP” switch is in IGNITION ON mode.

**! CAUTION**

■ When the outside rear view mirror defoggers are on

Do not touch the outside surface of the rear view mirror, as it can become very hot and burn you.



### 3-1. Using the air conditioning system and defogger

## Windshield wiper de-icer\*

This feature is used to prevent ice from building up on the windshield and wiper blades.



#### On/off

The windshield wiper de-icer will automatically turn off after approximately 15 minutes.

#### ■ The windshield wiper de-icer

The "ENGINE START STOP" switch is in IGNITION ON mode.

#### ⚠ CAUTION

#### ■ When the windshield wiper de-icer is on

The surface of the glass at the lower part and sides of the windshield become very hot. To prevent burning yourself, do not touch these areas.

## 3-2. Using the audio system

### Audio system type

▶ With navigation system

Owners of models equipped with a navigation system should refer to the “Navigation System Owner's Manual”.

▶ Without navigation system (type A)

CD player with changer and AM/FM radio



CLY24B024

▶ Without navigation system (type B)

CD player with changer and AM/FM radio



CLY24B024

Title	Page
Using the radio	P. 229
Using the CD player	P. 237
Playing back MP3 and WMA discs	P. 244
Operating an iPod	P. 252
Operating a USB memory	P. 260
Optimal use of the audio system	P. 269
Using the AUX port	P. 271
Using the steering wheel audio switches	P. 273

### ■ Using cellular phones

Interference may be heard through the audio system's speakers if a cellular phone is being used inside or close to the vehicle while the audio system is operating.

### CAUTION

#### ■ For vehicles sold in U.S.A. and Canada

##### ● Part 15 of the FCC Rules

FCC Warning:

Any unauthorized changes or modifications to this equipment will void the user's authority to operate this device.

##### ● Laser products

- Do not take this unit apart or attempt to make any changes yourself. This is an intricate unit that uses a laser pickup to retrieve information from the surface of compact discs. The laser is carefully shielded so that its rays remain inside the cabinet. Therefore, never try to disassemble the player or alter any of its parts since you may be exposed to laser rays and dangerous voltages.
- This product utilizes a laser. Use of controls or adjustments or performance of procedures other than those specified herein may result in hazardous radiation exposure.

### NOTICE

#### ■ To prevent battery discharge

Do not leave the audio system on longer than necessary with the engine off.

#### ■ To avoid damaging the audio system

Take care not to spill drinks or other fluids over the audio system.

## 3-2. Using the audio system

### Using the radio

#### ▶ Type A

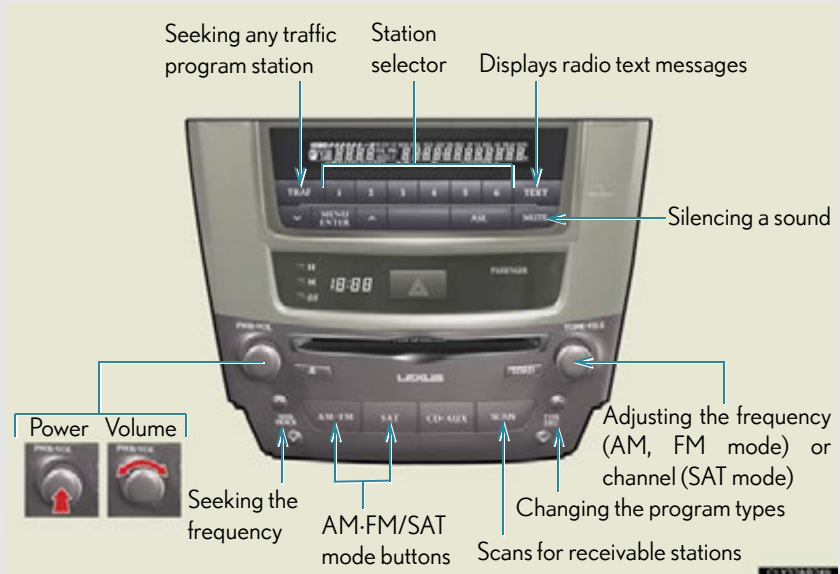

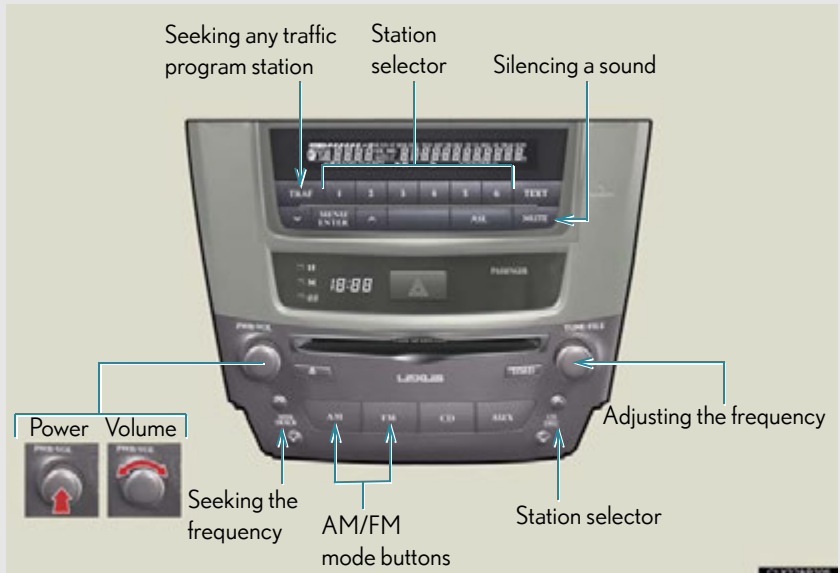

#### ▶ Type B



### Setting station presets (excluding XM<sup>®</sup> Satellite Radio)

**STEP 1** Search for desired stations by turning  or pressing “^” or



**STEP 2** Press and hold the button (from  to ) the station is to be set to until you hear a beep.

### Scanning radio stations (excluding XM<sup>®</sup> Satellite Radio) (type A only)

#### ■ Scanning the preset radio stations

**STEP 1** Press and hold  until you hear a beep.

Preset stations will be played for 5 seconds each.

**STEP 2** When the desired station is reached, press  once again.

#### ■ Scanning all radio stations within range

**STEP 1** Press .

All stations with reception will be played for 5 seconds each.

**STEP 2** When the desired station is reached, press  once again.

## RDS (Radio Data System) (type A)

This feature allows your radio to receive station identification information and program information (classical, jazz, etc.) from radio stations which broadcast this information.



### ■ Receiving RDS broadcasts

**STEP 1** Press “^” or “v” on  during FM reception.

The type of program changes each time  is pressed.

- “ROCK”
- “EASYLIS” (Easy listening)
- “CLS/JAZZ” (Classical music and Jazz)
- “R & B” (Rhythm and Blues)
- “INFORM” (Information)
- “RELIGION”
- “MISC” (Miscellaneous)
- “ALERT” (Emergency messages)

If the system receives no RDS stations, “NO PTY” appears on the display.

**STEP 2** Press , or “^” or “v” on .

The radio seeks or scans the stations by the relevant program type.



■ **Displaying radio station names**

Press .

■ **Displaying radio text messages**

Press  twice.

If “MSG” shows in the display, a text message will be displayed.

If the text continues past the end of the display,  is displayed. Press and hold  until you hear a beep.

## XM<sup>®</sup> Satellite Radio (type A)

■ **Receiving XM<sup>®</sup> Satellite Radio**

**STEP 1** Press .



The display changes as follows each time  is pressed.

“SAT1” → “SAT2” → “SAT3”

**STEP 2** Turn  to select the desired channel in all categories or press

“^” or “v” on  to select the desired channel in the current category.

■ **Setting XM<sup>®</sup> Satellite Radio channel presets**

Select the desired channel. Press the button the channel is to be set to (from  to ) until you hear a beep.

■ **Changing the channel category**

Press “^” or “v” on .



### ■ Scanning XM<sup>®</sup> Satellite Radio channels

- Scanning channels in the current category

**STEP 1** Press .

**STEP 2** When the desired channel is reached, press  again.

- Scanning preset channels

**STEP 1** Press and hold  until you hear a beep.

**STEP 2** When the desired channel is reached, press  again.

### ■ Displaying text information

Press .

The display will show up to 10 characters.

The display changes as follows each time  is pressed.

- CH NAME
- TITLE (SONG/PROGRAM TITLE)
- NAME (ARTIST NAME/FEATURE)
- CH NUMBER

### ■ When the battery is disconnected

Station presets are erased.

### ■ Reception sensitivity

- Maintaining perfect radio reception at all times is difficult due to the continually changing position of the antenna, differences in signal strength and surrounding objects, such as trains, transmitters, etc.
- The radio antenna is mounted inside the rear window. To maintain clear radio reception, do not attach metallic window tinting or other metallic objects to the antenna wire mounted inside the rear window.

### ■ XM<sup>®</sup> Satellite Radio

An XM<sup>®</sup> Satellite Radio is a tuner designed exclusively to receive broadcasts provided under a separate subscription. Availability is limited to the 48 contiguous states and 10 Canadian provinces.

#### ● XM<sup>®</sup> subscriptions

For detailed information about XM<sup>®</sup> Satellite Radio or to subscribe:  
U.S.A. —

Visit on the web at [www.xmradio.com](http://www.xmradio.com) or call 1-877-515-3987.

Canada —

Visit on the web at [www.xmradio.ca](http://www.xmradio.ca) or call 1-877-515-3987.

#### ● Radio ID

You will need the radio ID when activating XM<sup>®</sup> service or reporting a problem. Select "CH000" using , and the receiver's 8-character ID number

will appear.

#### ● Satellite tuner

The tuner supports only Audio Services (Music and Talk) and the accompanying Text Information of XM<sup>®</sup> Satellite Radio.

### ■ If the satellite radio does not operate normally

If a problem occurs with the XM<sup>®</sup> tuner, a message will appear on the display. Refer to the table below to identify the problem, and take the suggested corrective action.

"ANTENNA"	The XM <sup>®</sup> antenna is not connected. Check whether the XM <sup>®</sup> antenna cable is attached securely.
	There is a short-circuit in the antenna or the surrounding antenna cable. See a Lexus certified dealer.
"UNAUTH"	You have not subscribed to the XM <sup>®</sup> Satellite Radio. The radio is being updated with the latest encryption code. Contact the XM <sup>®</sup> Satellite Radio for subscription information. When a contract is canceled, you can choose the "CH000" and all free-to-air channels.
	The premium channel you selected is not authorized. Wait for about 2 seconds until the radio returns to the previous channel or "CH001". If it does not change automatically, select another channel. If you want to listen to the premium channel, contact XM <sup>®</sup> Satellite Radio.
"NO SIGNAL"	The XM <sup>®</sup> signal is too weak at the current location. Wait until your vehicle reaches a location with a stronger signal.
"LOADING"	The unit is acquiring audio or program information. Wait until the unit has received the information.
"OFF AIR"	The channel you selected is not broadcasting any programming. Select another channel.
"-----"	There is no song/program title or artist name/feature associated with the channel at that time. No action needed.

“CH UNAVL”

The channel you selected is no longer available. Wait for about 2 seconds until the radio returns to the previous channel or “CH001”. If it does not change automatically, select another channel.

Contact the XM<sup>®</sup> Listener Care Center at 1-877-515-3987.

### ■ Certifications for the radio tuner

This equipment has been tested and found to comply with the limits for a class B digital device, pursuant to Part 15 of the FCC Rules. These limits are designed to provide reasonable protection against harmful interference in a residential installation. This equipment generates, uses and can radiate radio frequency energy and, if not installed and used in accordance with the instructions, may cause harmful interference to radio communications. However, there is no guarantee that interference will not occur in a particular installation.

If this equipment does cause harmful interference to radio or television reception, which can be determined by turning the equipment off and on, the user is encouraged to try to correct the interference by trying one or more of the following:

- Reorienting or relocate the receiving antenna.
- Increasing the separation between the equipment and receiver.
- Connecting the equipment into an outlet on a circuit different from that to which the receiver is connected.
- Consulting the dealer or an experienced radio/TV technician for help.

## 3-2. Using the audio system Using the CD player

### ▶ Type A



### ▶ Type B

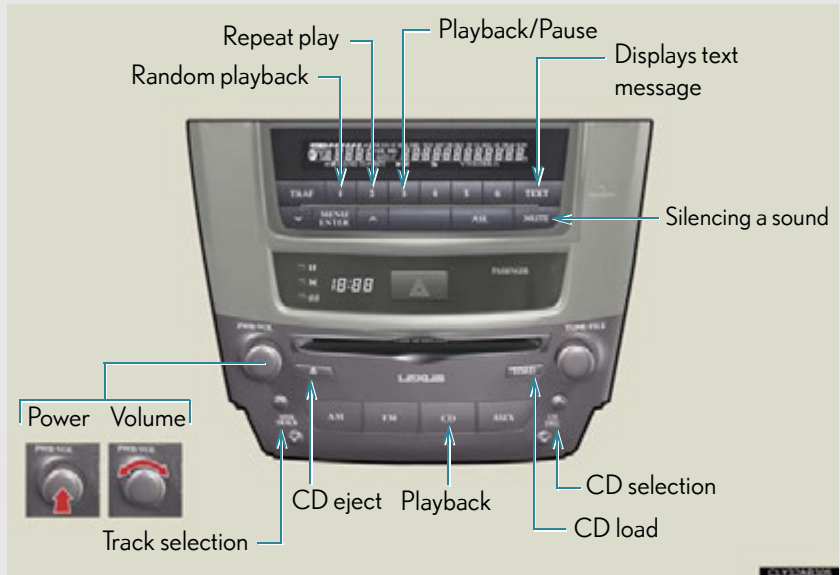

## Loading CDs

### ■ Loading a CD

**STEP 1** Push .

“WAIT” is shown on the display.

**STEP 2** Insert a CD when the indicator on the slot turns from amber to green.

The display changes from “WAIT” to “LOAD”.

### ■ Loading multiple CDs

**STEP 1** Press and hold  until you hear a beep.

“WAIT” is shown on the display.



**STEP 2** Insert a CD when the indicator on the slot turns from amber to green.

The display changes from “WAIT” to “LOAD”.

The indicator on the slot turns to amber when the CD is inserted.

**STEP 3** Insert the next CD when the indicator on the slot turns from amber to green again.

Repeat the procedure for the remaining CDs.

To stop the operation, press  or .

## Ejecting CDs

### Ejecting a CD



To select the CD to be ejected, press “^” or “v” on  or



The number of the CD selected is shown on the display.

STEP 2 Press  and remove the CD.

### Ejecting all the CDs

Press and hold  until you hear a beep, and then remove the CDs.

## Selecting, fast-forwarding, reversing and scanning tracks

### Selecting a track

Press “^” to move up and “v” to move down using  until the desired track number is displayed.

To fast forward or reverse, press and hold “^” or “v” on  until you hear a beep.

### Scanning a CD (type A only)

STEP 1 Press .

The first ten seconds of each track will be played.

STEP 2 Press  again when the desired track is reached.

### Selecting a CD

#### ■ To select a CD to play

To select the desired CD, press “^” or “v” on



#### ■ To scan loaded CDs (type A only)

**STEP 1** Press and hold  until you hear a beep.

The first ten seconds of the first track on each CD will be played.

**STEP 2** Press  again when the desired CD is reached.

### Random playback

#### ■ Current CD

Press  (RAND).

#### ■ All CDs

Press and hold  (RAND) until you hear a beep.

### Repeat play

#### ■ To repeat a track

Press  (RPT).

#### ■ To repeat all of the tracks on a CD

Press and hold  (RPT) until you hear a beep.

### Playing and pausing tracks

To play or pause a track, press  (   ).

### Switching the display

Press .

Each time  is pressed, the display changes in the order of Track no./ Elapsed time → CD title → Track title.



## ■ Display

Up to 12 characters can be displayed at a time.

If there are 13 characters or more, pressing and holding  until you hear a beep will display the remaining characters.

A maximum of 24 characters can be displayed.

If  is pressed until you hear a beep again or has not been pressed for 6 seconds or more, the display will return to the first 12 characters.

Depending on the contents recorded, the characters may not be displayed properly or may not be displayed at all.



## ■ Canceling random, repeat and scan playback

Press  (RAND),  (RPT),  again.

## ■ When “LOAD”, “ERROR” or “WAIT” is shown on the display

“LOAD”: This indicates that the CD player has completed loading the CD.

“ERROR”: This indicates a trouble either in the CD or inside the player. The CD may be dirty, damaged, or inserted up-side down.

“WAIT”: Operation is stopped due to a high temperature inside the player. Wait for a while and then press  or . Contact your Lexus dealer if the CD still cannot be played back.

## ■ Discs that can be used

Discs with the marks shown below can be used.

Playback may not be possible depending on recording format or disc features, or due to scratches, dirt or deterioration.



CDs with copy-protection features may not play correctly.

### ■ CD player protection feature

To protect the internal components, playback is automatically stopped when a problem is detected.

### ■ If CDs are left inside the CD player or in the ejected position for extended periods

CDs may be damaged and may not play properly.

### ■ Lens cleaners

Do not use lens cleaners. Doing so may damage the CD player.

### ⚠ NOTICE

#### ■ CDs and adapters that cannot be used

Do not use the following types of CDs, 3 in. (8 cm) CD adapters or Dual Disc. Doing so may damage the CD player and/or the CD insert/eject function.



- CDs that have a diameter that is not 4.7 in. (12 cm).



- Low-quality and deformed CDs.

 NOTICE

- CDs with a transparent or translucent recording area.



- CDs that have had tape, stickers or CD-R labels attached to them, or that have had the label peeled off.

### ■ CD player precautions

Failure to follow the precautions below may result in serious damage to the CDs or the player itself.

- Do not insert anything other than CDs into the CD slot.
- Do not apply oil to the CD player.
- Store CDs away from direct sunlight.
- Never try to disassemble any part of the CD player.



- Do not insert more than one CD at a time.

## 3-2. Using the audio system

# Playing back MP3 and WMA discs

### ▶ Type A

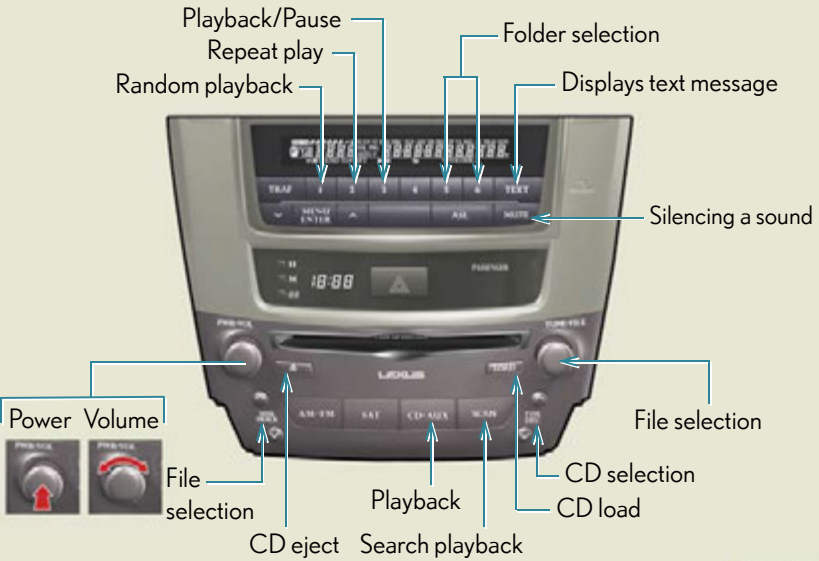

### ▶ Type B

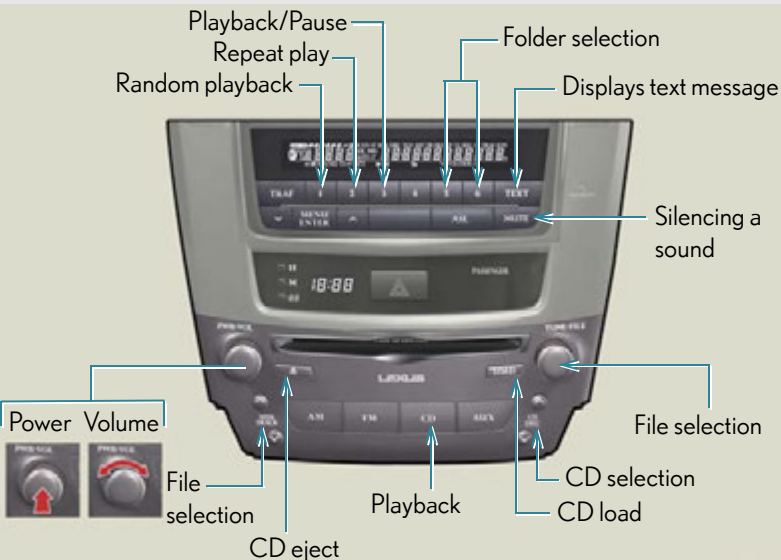







**Loading and ejecting MP3 and WMA discs**

→P. 238, 239

**Selecting MP3 and WMA discs**

→P. 240

**Selecting a folder****■ Selecting folders one at a time**Press  (∧) or  (∨) to select the desired folder.**■ Selecting the desired folder by cueing the first file of each folder (type A only)**Press and hold  until you hear a beep. When the desired folder is reached, press  once again.**■ Returning to the first folder**Press and hold  (∨) until you hear a beep.**Fast-forwarding and reversing files**To fast-forward or reverse, press and hold “∧” or “∨” on  until you hear a beep.

## Selecting and scanning files

### ■ Selecting one file at a time

Turn  or press “^” or “v” on  to select the desired file.

### ■ Selecting the desired file by cueing the files in the folder (type A only)

Press .

When the desired file is reached, press  once again.

## Repeat play

### ■ Repeating a file

Press  (RPT).

### ■ Repeating all of the files in a folder

Press and hold  (RPT) until you hear a beep.

## Random playback

### ■ To play files from a particular folder in random order

Press  (RAND).

### ■ To play all of the files on a disc in random order

Press and hold  (RAND) until you hear a beep.

## Playing and pausing files

To play or pause a file, press  (▶||).

## Switching the display

Press .

Each time  is pressed, the display changes in the order of Folder no./ File no./Elapsed time → Folder name → File name → Album title (MP3 only) → Track title → Artist name.

### ■ Display

Up to 12 characters can be displayed at a time.

If there are 13 characters or more, pressing and holding  until you hear a beep will display the remaining characters.

A maximum of 24 characters can be displayed.

If  is pressed until you hear a beep again or has not been pressed for 6 seconds or more, the display will return to the first 12 characters.

Depending on the contents recorded, the characters may not be displayed properly or may not be displayed at all.



### ■ Canceling random, repeat and scan playback

Press  (RAND),  (RPT),  again.

### ■ When “LOAD”, “ERROR”, “WAIT” or “NO MUSIC” is shown on the display

“LOAD”: This indicates that the CD player has completed loading the CD.

“ERROR”: This indicates a trouble either in the CD or inside the player. The CD may be dirty, damaged, or inserted up-side down.

“WAIT”: Operation is stopped due to a high temperature inside the player. Wait for a while and then press  or . Contact your Lexus dealer if the CD still cannot be played back.

“NO MUSIC”: This indicates that the MP3/WMA file is not included in the CD.

### ■ Discs that can be used

Discs with the marks shown below can be used.

Playback may not be possible depending on recording format or disc features, or due to scratches, dirt or deterioration.



### ■ CD player protection feature

To protect the internal components, playback is automatically stopped when a problem is detected while the CD player is being used.

### ■ If CDs are left inside the CD player or in the ejected position for extended periods

CDs may be damaged and may not play properly.

### ■ Lens cleaners

Do not use lens cleaners. Doing so may damage the CD player.

### ■ MP3 and WMA files

MP3 (MPEG Audio LAYER 3) is a standard audio compression format.

Files can be compressed to approximately 1/10 of their original size by using MP3 compression.

WMA (Windows Media Audio) is a Microsoft audio compression format.

This format compresses audio data to a size smaller than that of the MP3 format.

There is a limit to the MP3 and WMA file standards and to the media/formats recorded by them that can be used.

#### ● MP3 file compatibility

- Compatible standards  
MP3 (MPEG1 LAYER3, MPEG2 LSF LAYER3)
- Compatible sampling frequencies  
MPEG1 LAYER3: 32, 44.1, 48 (kHz)  
MPEG2 LSF LAYER3: 16, 22.05, 24 (kHz)
- Compatible bit rates (compatible with VBR)  
MPEG1 LAYER3: 64, 80, 96, 112, 128, 160, 192, 224, 256, 320 (kbps)  
MPEG2 LSF LAYER3: 64, 80, 96, 112, 128, 144, 160 (kbps)
- Compatible channel modes: stereo, joint stereo, dual channel and monaural



- WMA file compatibility

- Compatible standards  
WMA Ver. 7, 8, 9
- Compatible sampling frequencies  
32, 44.1, 48 (kHz)
- Compatible bit rates (only compatible with 2-channel playback)  
Ver. 7, 8: CBR 48, 64, 80, 96, 128, 160, 192 (kbps)  
Ver. 9: CBR 48, 64, 80, 96, 128, 160, 192, 256, 320 (kbps)

- Compatible media

Media that can be used for MP3 and WMA playback are CD-Rs and CD-RWs.

Playback in some instances may not be possible, depending on the status of the CD-R or CD-RW. Playback may not be possible or the audio may jump if the disc is scratched or marked with fingerprints.

- Compatible disc formats

The following disc formats can be used.

- Disc formats: CD-ROM Mode 1 and Mode 2  
CD-ROM XA Mode 2, Form 1 and Form 2
- File formats: ISO9660 Level 1, Level 2, (Romeo, Joliet)  
MP3 and WMA files written in any format other than those listed above may not play correctly, and their file names and folder names may not be displayed correctly.

Items related to standards and limitations are as follows.

- Maximum directory hierarchy: 8 levels
- Maximum length of folder names/file names: 32 characters
- Maximum number of folders: 192 (including the root)
- Maximum number of files per disc: 255

- File names

The only files that can be recognized as MP3/WMA and played are those with the extension .mp3 or .wma.

- Multi-sessions

As the audio system is compatible with multi-sessions, it is possible to play discs that contain MP3 and WMA files. However, only the first session can be played.

### ● ID3 and WMA tags

ID3 tags can be added to MP3 files, making it possible to record the track title, artist name, etc.

The system is compatible with ID3 Ver. 1.0, 1.1, and Ver. 2.2, 2.3 ID3 tags. (The number of characters is based on ID3 Ver. 1.0 and 1.1.)

WMA tags can be added to WMA files, making it possible to record the track title and artist name in the same way as with ID3 tags.

### ● MP3 and WMA playback

When a disc containing MP3 or WMA files is inserted, all files on the disc are first checked. Once the file check is finished, the first MP3 or WMA file is played. To make the file check finish more quickly, we recommend you do not write in any files other than MP3 or WMA files or create any unnecessary folders.

Discs that contain a mixture of music data and MP3 or WMA format data cannot be played.

### ● Extensions

If the file extensions .mp3 and .wma are used for files other than MP3 and WMA files, they will be mistakenly recognized and played as MP3 and WMA files. This may result in large amounts of interference and damage to the speakers.

### ● Playback

- To play MP3 file with steady sound quality, we recommend a fixed bit rate of 128 kbps and a sampling frequency of 44.1 kHz.
- CD-R or CD-RW playback may not be possible in some instances, depending on the characteristics of the disc.
- There is a wide variety of freeware and other encoding software for MP3 and WMA files on the market, and depending on the status of the encoding and the file format, poor sound quality or noise at the start of playback may result. In some cases, playback may not be possible at all.
- When files other than MP3 or WMA files are recorded on a disc, it may take more time to recognize the disc and in some cases, playback may not be possible at all.
- Microsoft, Windows, and Windows Media are registered trademarks of Microsoft Corporation in the U.S.A. and other countries.

 NOTICE

■ **CDs and adapters that cannot be used**

→P. 242

■ **CD player precautions**

→P. 243

## 3-2. Using the audio system

### Operating an iPod

Connecting an iPod enables you to enjoy music from the vehicle speakers.

#### ■ Connecting an iPod

STEP 1



Open the cover and connect the portable audio device.

Turn on the power of the iPod if it is not turned on.

▶ Type A

STEP 2



Press  .

▶ Type B

STEP 2



Press  .

■ Control panel

► Type A

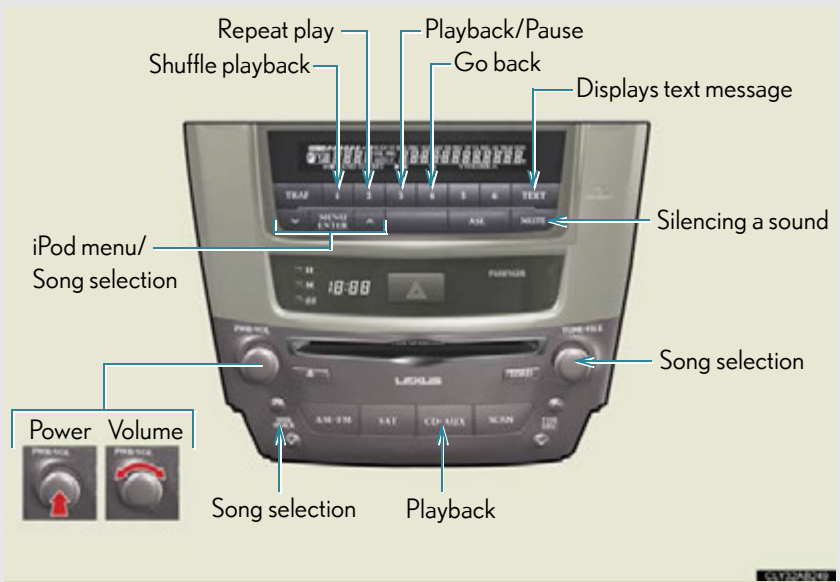

► Type B

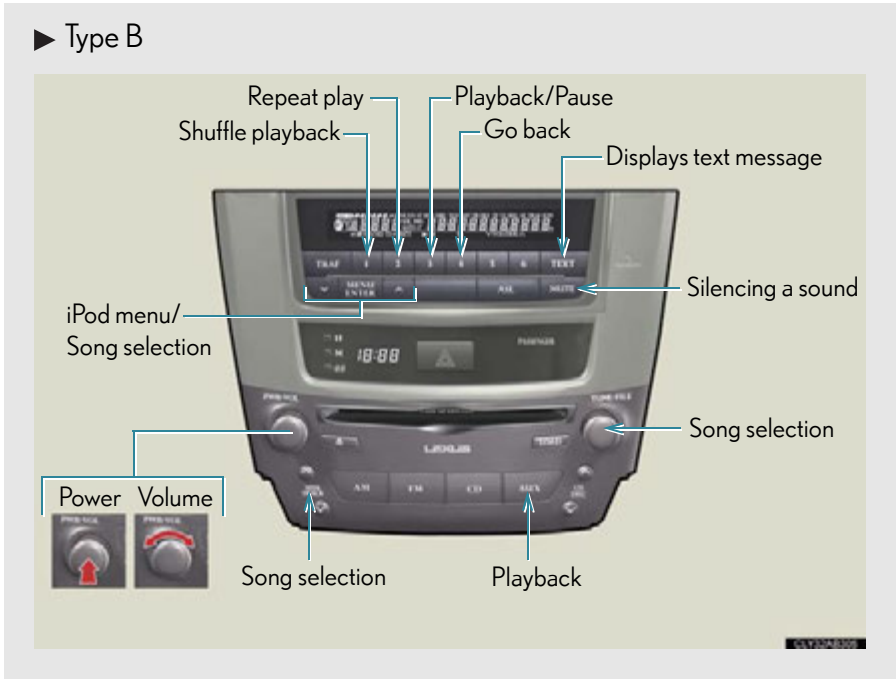

**Selecting a play mode**

**STEP 1** Press **MENU ENTER** to select iPod menu mode.



**STEP 2** Pressing **▼** or **▲** changes the play mode in the following order:  
"PLAYLISTS" → "ARTISTS" → "ALBUMS" → "SONGS" →  
"PODCASTS" → "GENRES" → "COMPOSERS" →  
"AUDIOBOOKS"

**STEP 3** Press **MENU ENTER** to select the desired play mode.

### ■ Play mode list

Play mode	First selection	Second selection	Third selection	Fourth selection
"PLAYLISTS"	Playlists select	Songs select	-	-
"ARTISTS"	Artists select	Albums select	Songs select	-
"ALBUMS"	Albums select	Songs select	-	-
"SONGS"	Songs select	-	-	-
"PODCASTS"	Albums select	Songs select	-	-
"GENRES"	Genre select	Artists select	Albums select	Songs select
"COMPOSERS"	Composers select	Albums select	Songs select	-
"AUDIOBOOKS"	Songs select	-	-	-



### ■ Selecting a list

**STEP 1** Press  or  to display the first selection list.

**STEP 2** Press  to select the desired item.

Pressing  changes to the second selection list.



**STEP 3** Repeat the same procedure to select the desired item.

To return to the previous selection list, select "GO BACK" or press  (  ).

## Selecting songs

Turn  or press “^” or “v” on  to select the desired song.

## Playing and pausing songs

To play or pause a song, press  (  ).

## Fast-forwarding and rewinding songs

To fast-forward or rewind, press and hold “^” or “v” on  until you hear a beep.

## Shuffle playback

### ■ Playing songs from one playlist or album in random order

Press  (RAND).

### ■ Playing songs from all the playlists or albums in random order

Press and hold  (RAND) until you hear a beep.

## Repeat play

Press  (RPT).

## Switching the display

Press .

Each time  is pressed, the display changes in the order of Elapsed time → Album title → Track title → Artist name.



## Adjusting sound quality and volume balance

**STEP 1** Press  to enter iPod menu mode.

**STEP 2** Pressing  changes sound modes. (→P. 270)

### ■ About iPod

- Apple is not responsible for the operation of this device or its compliance with safety and regulatory standards.
- iPod is a trademark of Apple Inc., registered in the U.S. and other countries.

### ■ iPod functions

- When an iPod is connected and the audio source is changed to iPod mode, the iPod will resume play from the same point in which it was last used.
- Depending on the iPod that is connected to the system, certain functions may not be available. If a function is unavailable due to a malfunction (as opposed to a system specification), disconnecting the device and reconnecting it once again may resolve the problem.
- While connected to the system, the iPod cannot be operated with its own controls. It is necessary to use the controls of the vehicle's audio system instead.

### ■ iPod problems

To resolve most problems encountered when using your iPod, disconnect your iPod from the vehicle iPod connection and reset it.

For instructions on how to reset your iPod, refer to your iPod Owner's Manual.

### ■ Display

Up to 12 characters can be displayed at a time.



If there are 13 characters or more, pressing and holding  until you hear a beep will display the remaining characters.

A maximum of 24 characters can be displayed.

If  is pressed until you hear a beep again or has not been pressed for 6 seconds or more, the display will return to the first 12 characters.

Depending on the contents recorded, the characters may not be displayed properly or may not be displayed at all.

### ■ Canceling shuffle and repeat playback

Press  (RAND) or  (RPT) again.

### ■ Error messages

“ERROR”: This indicates a problem in the iPod or its connection.

“NO MUSIC”: This indicates that there is no music data in the iPod.

“EMPTY”: This indicates that some available songs are not found in a selected playlist.

“UPDATE”: This indicates that the version of the iPod is not compatible. Upgrade your iPod software to the latest version.

### Compatible models

Model	Generation	Software version
iPod	5th generation	Ver. 1.2.0 or higher
iPod nano	1st generation	Ver. 1.3.0 or higher
	2nd generation	Ver. 1.1.2 or higher
	3rd generation	Ver. 1.0.0 or higher
iPod touch	1st generation	Ver. 1.1.0 or higher
iPod classic	1st generation	Ver. 1.0.0 or higher

Depending on differences between models or software version etc., some models listed above might be incompatible with this system.

iPod 4th generation and earlier models are not compatible with this system.

iPhone, iPod mini, iPod shuffle and iPod photo are not compatible with this system.

Items related to standards and limitations are as follows:

- Maximum number of lists in device: 9999
- Maximum number of songs in device: 65535
- Maximum number of songs per list: 65535

#### CAUTION

##### ■ Caution while driving

Do not connect iPod or operate the controls.

#### NOTICE

##### ■ To prevent damage to iPod

- Do not leave iPod in the vehicle. The temperature inside the vehicle may become high, resulting in damage to the player.
- Do not push down on or apply unnecessary pressure to the iPod while it is connected as this may damage the iPod or its terminal.
- Do not insert foreign objects into the port as this may damage the iPod or its terminal.

## 3-2. Using the audio system

### Operating a USB memory

Connecting a USB memory enables you to enjoy music from the vehicle speakers.

#### ■ Connecting a USB memory

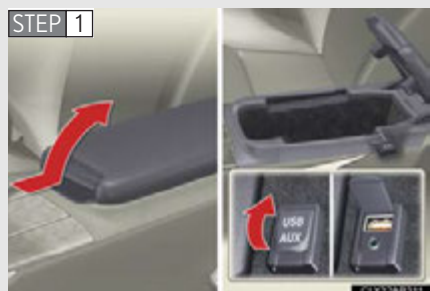

Open the cover and connect the portable audio device.

Turn on the power of the USB memory if it is not turned on.

#### ▶ Type A



Press  .

#### ▶ Type B



Press  .

■ Control panel

▶ Type A

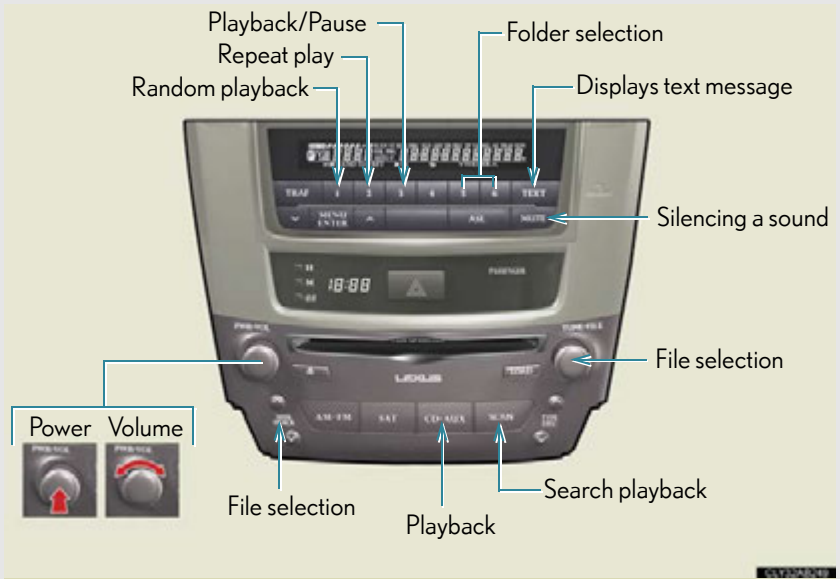

▶ Type B

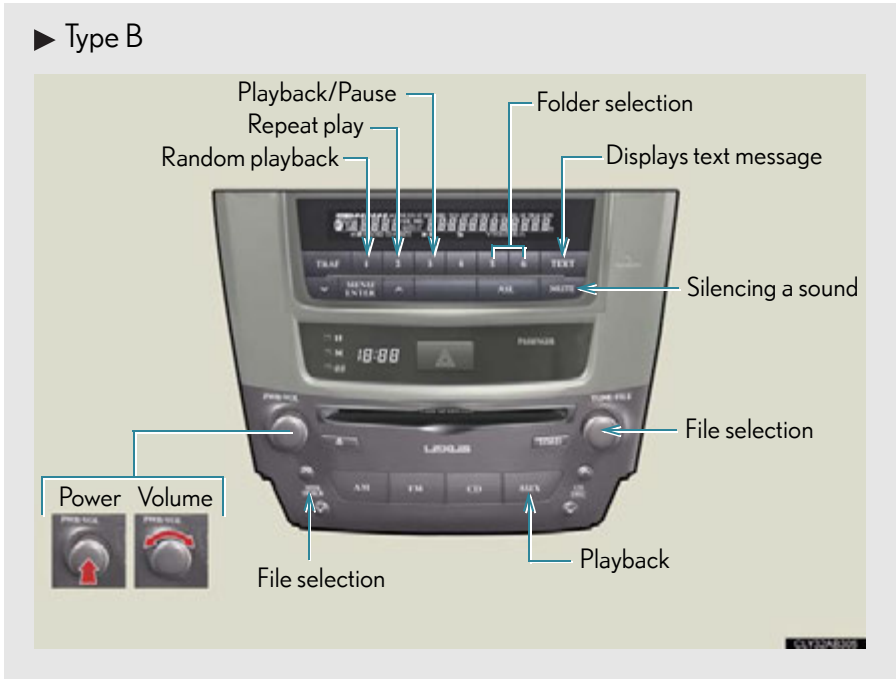

**Selecting a folder**

■ **Selecting folders one at a time**

Press **6** (^) or **5** (v) to select the desired folder.

■ **Selecting the desired folder by cueing the first file of each folder (type A only)**

Press and hold **SCAN** until you hear a beep. When the desired folder is reached, press **SCAN** once again.

■ **Returning to the first folder**

Press and hold **5** (v) until you hear a beep.

## Selecting files

### ■ Selecting one file at a time



Turn  or press “^” or “v” on  to select the desired file.

### ■ Selecting the desired file by cueing the files in the folder (type A only)

Press .

When the desired file is reached, press  once again.

## Playing and pausing files

To play or pause a file, press  (  ).

## Fast-forwarding and rewinding files

To fast-forward or rewind, press and hold “^” or “v” on  until you hear a beep.

## Random playback

### ■ Playing files from a folder in random order

Press  (RAND).

### ■ Playing all the files from a USB memory in random order

Press and hold  (RAND) until you hear a beep.

## Repeat play

### ■ Repeating a file

Press  (RPT).

### ■ Repeating all the files in a folder

Press and hold  (RPT) until you hear a beep.

### Switching the display

Press .

Each time  is pressed, the display changes in the order of Elapsed time → Folder name → File name → Album title (MP3 only) → Track title → Artist name.

---

#### ■ USB memory functions

- Depending on the USB memory that is connected to the system, the device itself may not be operable and certain functions may not be available. If the device is inoperable or a function is unavailable due to a malfunction (as opposed to a system specification), disconnecting the device and reconnecting it once again may resolve the problem.
- If the USB memory still does not begin operation after being disconnected and reconnected, format the memory.

#### ■ Display

Up to 12 characters can be displayed at a time.

If there are 13 characters or more, pressing and holding  until you hear a beep will display the remaining characters.

A maximum of 24 characters can be displayed.

If  is pressed until you hear a beep again or has not been pressed for 6 seconds or more, the display will return to the first 12 characters.

Depending on the contents recorded, the characters may not be displayed properly or may not be displayed at all.

#### ■ Canceling random, repeat and scan playback

Press  (RAND),  (RPT),  again.

#### ■ Error messages

“ERROR”: This indicates a problem in the USB memory or its connection.

“NO MUSIC”: This indicates that no MP3/WMA files are included in the USB memory.



## ■ USB memory

### ● Compatible devices

USB memory that can be used for MP3 and WMA playback

### ● Compatible device formats

The following device formats can be used:

- USB communication formats: USB2.0 FS (12 mbps)
- File formats: FAT16/32 (Windows)
- Correspondence class: Mass storage class

MP3 and WMA files written in any format other than those listed above may not play correctly, and their file names and folder names may not be displayed correctly.

Items related to standards and limitations are as follows:

- Maximum directory hierarchy: 8 levels
- Maximum number of folders in a device: 999 (including the root)
- Maximum number of files in a device: 65025
- Maximum number of files per folder: 255

### ● MP3 and WMA files

MP3 (MPEG Audio LAYER 3) is a standard audio compression format.

Files can be compressed to approximately 1/10 of their original size using MP3 compression.

WMA (Windows Media Audio) is a Microsoft audio compression format.

This format compresses audio data to a size smaller than that of the MP3 format.

There is a limit to the MP3 and WMA file standards that can be used and to the media/formats on which the files are recorded.

### ● MP3 file compatibility

- Compatible standards  
MP3 (MPEG1 AUDIO LAYERII, III, MPEG2 AUDIO LAYERII, III, MPEG2.5)
- Compatible sampling frequencies  
MPEG1 AUDIO LAYERII, III: 32, 44.1, 48 (kHz)  
MPEG2 AUDIO LAYERII, III: 16, 22.05, 24 (kHz)  
MPEG2.5: 8, 11.025, 12 (kHz)
- Compatible bit rates (compatible with VBR)  
MPEG1 AUDIO LAYERII, III: 32-320 (kbps)  
MPEG2 AUDIO LAYERII, III: 32-160 (kbps)  
MPEG2.5: 32-160 (kbps)
- Compatible channel modes: stereo, joint stereo, dual channel and monaural

### ● WMA file compatibility

- Compatible standards  
WMA Ver. 9
- Compatible sampling frequencies  
HIGH PROFILE 32, 44.1, 48 (kHz)
- Compatible bit rates  
HIGH PROFILE 32-320 (kbps, VBR)

### ● File names

The only files that can be recognized as MP3/WMA and played are those with the extension .mp3 or .wma.

### ● ID3 and WMA tags

ID3 tags can be added to MP3 files, making it possible to record the track title, artist name, etc.

The system is compatible with ID3 Ver. 1.0, 1.1, and Ver. 2.2, 2.3, 2.4 ID3 tags. (The number of characters is based on ID3 Ver. 1.0 and 1.1.)

WMA tags can be added to WMA files, making it possible to record the track title and artist name in the same way as with ID3 tags.

### ● MP3 and WMA playback

- When a USB memory containing MP3 or WMA files is connected, all files in the USB memory are checked. Once the file check is finished, the first MP3 or WMA file is played. To make the file check finish more quickly, we recommend that you do not include any files other than MP3 or WMA files or create any unnecessary folders.
- When the USB memory is connected and the audio source is changed to USB memory mode, the USB memory will start playing the first file in the first folder. If the same device is removed and reinserted (and the contents have not been changed), the USB memory will resume play from the same point in which it was last used.

### ● Extensions

If the file extensions .mp3 and .wma are used for files other than MP3 and WMA files, they will be skipped (not played).

### ● Playback

- To play MP3 files with steady sound quality, we recommend a fixed bit rate of at least 128 kbps and a sampling frequency of 44.1 kHz.
- There is a wide variety of freeware and other encoding software for MP3 and WMA files on the market, and depending on the status of the encoding and the file format, poor sound quality or noise at the start of playback may result. In some cases, playback may not be possible at all.
- Microsoft, Windows, and Windows Media are registered trademarks of Microsoft Corporation in the U.S.A. and other countries.

## CAUTION

### ■ Caution while driving

Do not connect USB memory or operate the controls.

### NOTICE

#### ■ To prevent damage to USB memory

- Do not leave USB memory in the vehicle. The temperature inside the vehicle may become high, resulting in damage to the player.
- Do not push down on or apply unnecessary pressure to the USB memory while it is connected as this may damage the USB memory or its terminal.
- Do not insert foreign objects into the port as this may damage the USB memory or its terminal.

## 3-2. Using the audio system

### Optimal use of the audio system

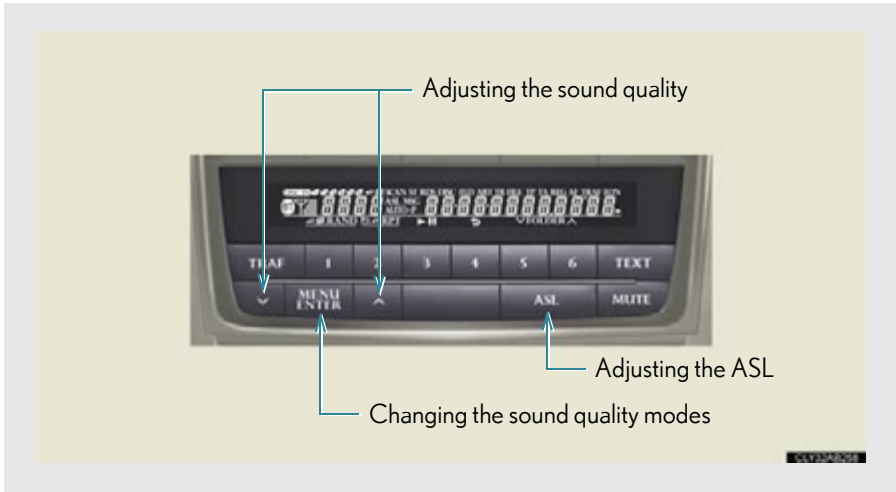

## Adjusting the Automatic Sound Levelizer (ASL)

Press .

The ASL switches between on and off modes each time  is pressed.

ASL automatically adjusts the volume and tone quality according to the noise level as you drive your vehicle.

## Adjusting sound quality and volume balance

### ■ Changing sound quality modes



Press .

Pressing  changes the sound mode in the following order:

“BAS”→“MID”→“TRE”→“FAD”→“BAL”

### ■ Adjusting sound quality

Press  or  to adjust the level.

Mode displayed	Sound quality mode	Level	Press 	Press 
“BAS”*	Bass	-5 to 5	Low	High
“MID”*	Mid-range	-5 to 5		
“TRE”*	Treble	-5 to 5		
“FAD”	Front/rear volume balance	F7 to R7	Shifts to rear	Shifts to front
“BAL”	Left/right volume balance	L7 to R7	Shifts to left	Shifts to right

\*: The sound quality level is adjusted individually in each audio mode.

## 3-2. Using the audio system

### Using the AUX port

This port can be used to connect a portable audio device and listen to it through the vehicle's speakers.

STEP 1

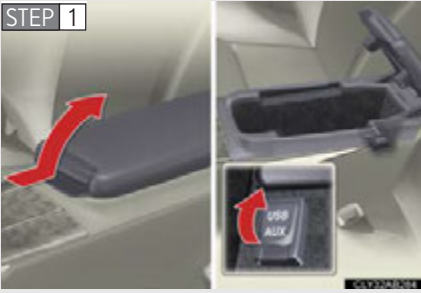

Open the cover and connect the portable audio device.

► Type A

STEP 2



Press  .

► Type B

STEP 2

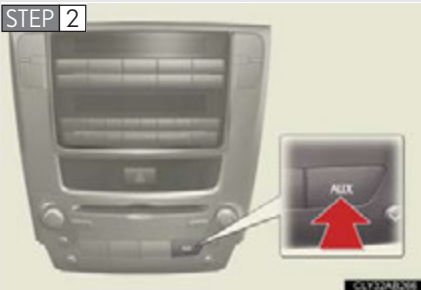

Press  .

### ■ **Operating portable audio devices connected to the audio system**

The volume can be adjusted using the vehicle's audio controls. All other adjustments must be made on the portable audio device itself.

### ■ **When using a portable audio device connected to the power outlet**

Noise may occur during playback. Use the power source of the portable audio device.



## 3-2. Using the audio system

### Using the steering wheel audio switches

Some audio features can be controlled using the switches on the steering wheel.



**1** Turns the power on, selects an audio source

**2** Increases/decreases volume

**3** Radio mode: Selects a radio station

CD mode: Selects a track, file (MP3 and WMA) and disc

Bluetooth® audio mode:  
Selects a track and album

iPod mode:  
Selects a song

USB memory mode:  
Selects a file and folder

#### Turning on the power

Press **MODE** when the audio system is turned off.

The audio system can be turned off by holding **MODE** down until you hear a beep.

### Changing the audio source

Press **MODE** when the audio system is turned on. The audio source changes as follows each time **MODE** is pressed. If no discs are inserted in the player, or if the external device is not connected, that mode will be skipped.

Type A:

FM1→FM2→SAT1→SAT2→SAT3→CD player→  
Bluetooth<sup>®</sup> audio→AUX→iPod or USB memory→AM

Type B:

FM1→FM2→CD player→Bluetooth<sup>®</sup> audio→AUX→  
iPod or USB memory→AM

### Adjusting the volume

Press “+” on  to increase the volume and “-” to decrease the volume.

Hold down  to continue increasing or decreasing the volume.

### Selecting a radio station

**STEP 1** Press **MODE** to select radio mode.

**STEP 2** Press “^” or “v” on  to select a radio station.

To scan for receivable stations, press and hold  until you hear a beep.

### Selecting a track/file or song

**STEP 1** Press **MODE** to select CD, Bluetooth<sup>®</sup> audio, iPod or USB memory mode.

**STEP 2** Press “^” or “v” on  to select the desired track/file or song.

### Selecting an album

**STEP 1** Press **MODE** to select Bluetooth<sup>®</sup> audio mode.

**STEP 2** Press and hold “^” or “v” on  until you hear a beep.

### Selecting a folder

**STEP 1** Press **MODE** to select USB memory mode.

**STEP 2** Press and hold “^” or “v” on  until you hear a beep.

### Selecting a disc in the CD player

**STEP 1** Press **MODE** to select CD mode.

**STEP 2** Press and hold “^” or “v” on  until you hear a beep.

### CAUTION

#### To reduce the risk of an accident

Exercise care when operating the audio switches on the steering wheel.

### 3-3. Using the Bluetooth® audio system

## Bluetooth® audio system

The Bluetooth® audio system enables you to enjoy music played on a portable digital audio player (portable player) from the vehicle speakers via wireless communication.

This audio system supports Bluetooth®, a wireless data system capable of playing portable audio music without cables. If your portable player does not support Bluetooth®, the Bluetooth® audio system will not function.

▶ Vehicles with a navigation system

Owners of models equipped with a navigation system should refer to the "Navigation System Owner's Manual".

▶ Vehicles without a navigation system

Title	Page
Using the Bluetooth® audio system	P. 279
Operating a Bluetooth® enabled portable player	P. 284
Setting up a Bluetooth® enabled portable player	P. 287
Bluetooth® audio system setup	P. 293

#### ■ Conditions under which the system will not operate

- If using a portable player that does not support Bluetooth®
- If the portable player is switched off
- If the portable player is not connected
- If the portable player's battery is low
- If the portable player is behind the seat or in the glove box or console box
- If metal is covering or touching the portable player

### ■ When transferring ownership of the vehicle

Be sure to initialize the system to prevent personal data from being improperly accessed. (→P. 317)

### ■ About Bluetooth®



Bluetooth is a registered trademark of Bluetooth SIG, Inc.

### ■ Compatible models

- Bluetooth® specifications:  
Ver. 1.1 or higher (Recommended: Ver. 1.2 or higher)
- Following profiles:
  - A2DP (Advanced Audio Distribution Profile) Ver. 1.0, or higher (Conformed: Ver. 1.2)
  - AVRCP (Audio/Video Remote Control Profile) Ver. 1.0 or higher (Conformed: Ver. 1.3)

Portable players must correspond to the above specifications in order to be connected to the Bluetooth® audio system. However, please note that some functions may be limited depending on the type of portable player.

### ■ Certification for the Bluetooth® audio system

FCC ID: AJDK018  
IC ID: 775E-K018  
MADE IN JAPAN

This device complies with Part 15 of the FCC Rules and RSS-Gen and RSS-210 of IC Rules. Operation is subject to the following two conditions: (1) this device may not cause harmful interference, and (2) this device must accept any interference received, including interference that may cause undesired operation.

 **CAUTION**

■ **FCC WARNING**

Changes or modifications not expressly approved by the party responsible for compliance could void the user's authority to operate the equipment.

**Radio Frequency Radiation Exposure.** This equipment complies with FCC radiation exposure limits set forth for uncontrolled equipment and meets the FCC radio frequency (RF) Exposure Guidelines in Supplement C to OET65. This equipment has very low levels of RF energy that it deemed to comply without maximum permissive exposure evaluation (MPE). But it is desirable that it should be installed and operated with at least 7.9 in. (20 cm) and more between the radiator and person's body (excluding extremities: hands, wrists, feet and ankles).

This transmitter must not be co-located or operated in conjunction with any other antenna or transmitter.

■ **Caution while driving**

Do not connect portable players or operate the controls.

 **NOTICE**

■ **To prevent damage to portable players**

Do not leave portable players in the vehicle. The temperature inside the vehicle may become high, resulting in damage to the player.

### 3-3. Using the Bluetooth® audio system

## Using the Bluetooth® audio system

#### ■ Audio unit

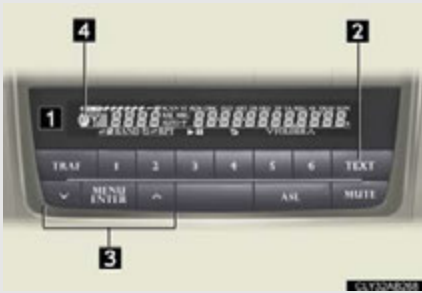

- 1** Display  
A message, name, number, etc. is displayed.

Lower-case characters and special characters cannot be displayed.

- 2** Displays information that is too long to be displayed at one time on the display (press and hold)

- 3** Selects items such as menu and number



: Selects an item





: Inputs the selected item

- 4** Bluetooth® connection condition

If "BT" is not displayed, the Bluetooth® audio system cannot be used.

#### Operating the system using voice commands

By following voice guidance instructions output from the speaker, voice commands enable the operation of the Bluetooth® audio system without the need to check the display or operate  ,  and  .

##### ■ Operation procedure when using voice commands

Press the talk switch and follow voice guidance instructions.

##### ■ Auxiliary commands when using voice commands

The following auxiliary commands can be used when operating the system using a voice command:

“Cancel”: Exits the Bluetooth® audio system

“Repeat”: Repeats the previous voice guidance instruction

“Go back”: Returns to the previous procedure



“Help”: Reads aloud the function summary if a help comment is registered for the selected function





## Using the Bluetooth® audio system for the first time

Before using the Bluetooth® audio system, it is necessary to register a Bluetooth® enabled portable player in the system. Follow the procedure below to register (pair) a portable player:



**STEP 1** Press  and select “BT•A MENU” using ,  and .

**STEP 2** Press the talk switch or select “BT•A Setup” using ,  and .

The introductory guidance and portable player name registration instructions are heard.

**STEP 3** Select “Pair Audio Player (Pair Audio)” using a voice command or ,  and .

**STEP 4** Register a portable player name by either of the following methods:

- a. Select “Record Name” using ,  and , and say the name to be registered.
- b. Press the talk switch and say the name to be registered.

A voice guidance instruction to confirm the input is heard.

**STEP 5** Select “Confirm” using a voice command or ,  and .



A passkey is displayed and heard, and a voice guidance instruction for inputting the passkey into the portable player is heard.

**STEP 6** Input the passkey into the portable player.

Refer to the manual that comes with the portable player for the operation of the portable player.

Guidance for registration completion is heard.

If the portable player has a Bluetooth® phone, the phone can be registered at the same time. A voice guidance instruction to register a Bluetooth® phone is heard.

**STEP 7** Select “Yes” or “No” using a voice command or ,  and . (Bluetooth® phone →P. 298)

#### Menu list of the Bluetooth® audio system

First menu	Second menu	Third menu	Operation detail
“Setup”	“BT·A Setup”	“Pair Audio”	Registering a portable player
		“Connect”	Selecting a portable player to be used
		“Change Name”	Changing the registered name of a portable player
		“List Audios”	Listing the registered portable players
		“Set Passkey”	Changing the passkey
		“Delete Audio”	Deleting a registered portable player
	“System Setup”	“Guidance Vol”	Setting voice guidance volume
		“Device Name”	Displaying the Bluetooth® device address and name
		“Initialize”	Initializing the system

**■ When using a voice command**

For numbers, say a combination of single digits from zero to nine.

Say the command correctly and clearly.

**■ Situations in which the system may not recognize your voice**

- When driving on rough roads
- When driving at high speeds
- When air is blowing out of the vents onto the microphone
- When the air conditioning fan emits a loud noise

**■ Operations that cannot be performed while driving**

- Operating the system with ,  and 
- Registering a portable player to the system

**■ Changing the passkey**

→P. 291

### 3-3. Using the Bluetooth® audio system

## Operating a Bluetooth® enabled portable player

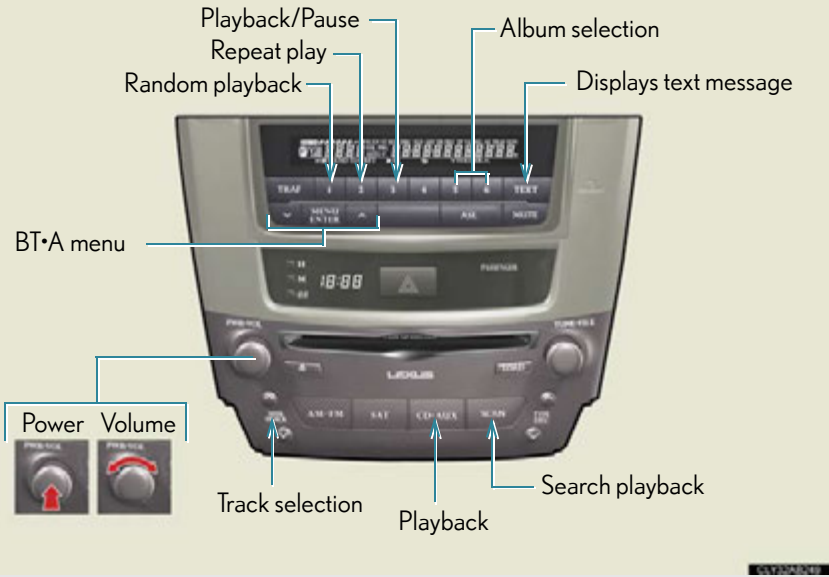

#### ▶ Type A

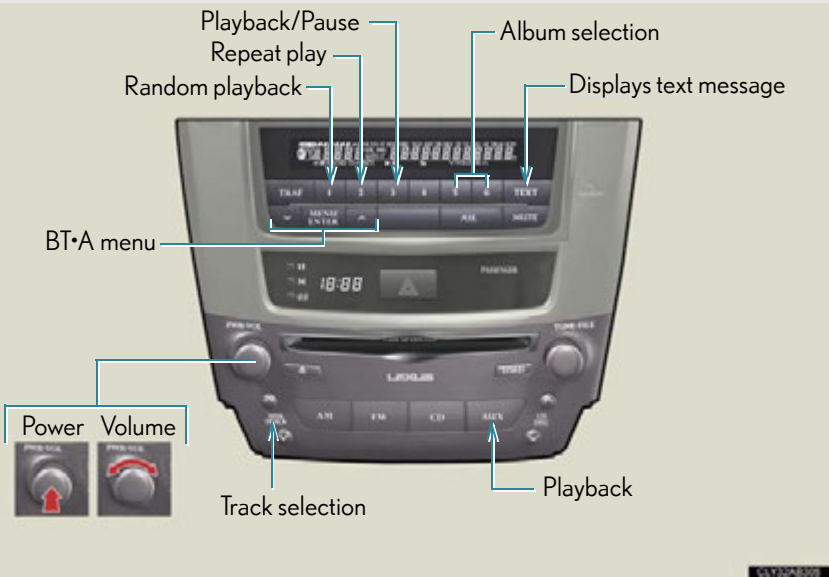

#### ▶ Type B



### Selecting an album

To select the desired album, press  (∧) or  (∨).

### Selecting tracks

Press “∧” or “∨” on  to select the desired track.

### Playing and pausing tracks

To play or pause a track, press  (▶||).

### Fast-forwarding and rewinding tracks

To fast-forward or rewind, press and hold “∧” or “∨” on  until you hear a beep.

### Random playback

Press  (RAND).

### Repeat play

Press  (RPT).

### Scanning tracks (type A)

Press .

### Switching the display

Press .

Each time  is pressed, the display changes in the order of Elapsed time → Album title → Track title → Artist name.

## Using the steering wheel audio switches

→P. 273

### ■ Bluetooth® audio system functions

Depending on the portable player that is connected to the system, certain functions may not be available.

### ■ Display

Up to 12 characters can be displayed at a time.



If there are 13 characters or more, pressing and holding  until you hear a beep will display the remaining characters.

A maximum of 24 characters can be displayed.

If  is pressed until you hear a beep again or has not been pressed for 6 seconds or more, the display will return to the first 12 characters.

Depending on the contents recorded, the characters may not be displayed properly or may not be displayed at all.

### ■ Canceling random, repeat and scan playback

Press  (RAND),  (RPT) or  (type A) again.

### ■ Error messages



“Memory Error”: This indicates a problem in the system.

## Setting up a Bluetooth® enabled portable player

Registering a portable player in the Bluetooth® audio system allows the system to function. The following functions can be used for registered portable players:

#### ■ Functions and operation procedures



##### ▶ Pattern A



To enter the menu for each function, follow the steps below using a voice command or ,  and  :

- Registering a portable player
  1. "Setup" → 2. "Bluetooth Audio Setup (BT•A Setup)" →
  3. "Pair Audio Player (Pair Audio)"
- Selecting a portable player to be used
  1. "Setup" → 2. "Bluetooth Audio Setup (BT•A Setup)" →
  3. "Connect Audio Player (Connect)"
- Changing the registered name of a portable player
  1. "Setup" → 2. "Bluetooth Audio Setup (BT•A Setup)" →
  3. "Change Name"
- Listing the registered portable players
  1. "Setup" → 2. "Bluetooth Audio Setup (BT•A Setup)" →
  3. "List Audio Players (List Audios)"
- Changing the passkey
  1. "Setup" → 2. "Bluetooth Audio Setup (BT•A Setup)" →
  3. "Set Passkey"
- Deleting a registered portable player
  1. "Setup" → 2. "Bluetooth Audio Setup (BT•A Setup)" →
  3. "Delete Audio Player (Delete Audio)"

#### ► Pattern B



**STEP 1** Press  to select “BT•A MENU”.

**STEP 2** Press the talk switch or select “BT•A Setup” using ,  and .

**STEP 3** Select one of the following functions using a voice command or ,  and .

- Registering a portable player  
“Pair Audio Player (Pair Audio)”
- Selecting a portable player to be used  
“Connect Audio Player (Connect)”
- Changing the registered name of a portable player  
“Change Name”
- Listing the registered portable players  
“List Audio Players (List Audios)”
- Changing the passkey  
“Set Passkey”
- Deleting a registered portable player  
“Delete Audio Player (Delete Audio)”

#### Registering a portable player



Select “Pair Audio Player (Pair Audio)” using a voice command or ,  and , and perform the procedure for registering a portable player. (→P. 281)



## Selecting a portable player to be used



**STEP 1** Select “Connect Audio Player (Connect)” using a voice command or ,  and .

### ► Pattern A



**STEP 2** Select the portable player to be used by either of the following methods, and select “Confirm” by using a voice command or ,  and .

- Press the talk switch and say the name of the desired portable player.
- Press the talk switch and say “List Audio Players”. When the name of the desired portable player is read aloud, press the talk switch.

### ► Pattern B

**STEP 2** Select the portable player to be used using ,  and .

### ► Pattern A



**STEP 3** Press the talk switch and say “From Car” or “From Audio player”, and select “Confirm” by using a voice command or ,  and .

### ► Pattern B



**STEP 3** Select “From Car” or “From Audio”, using ,  and .

If “From Car” is selected, the portable player will be automatically connected whenever the “ENGINE START STOP” switch is in either ACCESSORY or IGNITION ON mode.

## Changing the registered name of a portable player



**STEP 1** Select “Change Name” using a voice command or  ,  and  .



### ► Pattern A



**STEP 2** Select the name of the portable player to be changed by either of the following methods, and select “Confirm” using a voice command or  ,  and  :

- a. Press the talk switch and say the name of desired portable player.
- b. Press the talk switch and say “List Audio Players”. When the name of the desired portable player is read aloud, press the talk switch.



### ► Pattern B

**STEP 2** Select the desired portable player name to be changed using  ,  and  .

**STEP 3** Press the talk switch or select “Record Name” using  ,  and  , and say the new name.

**STEP 4** Select “Confirm” using a voice command or  ,  and  .

### Listing the registered portable players



Select “List Audio Players (List Audios)” using a voice command or ,  and . The list of registered portable players will be read aloud.

When listing is complete, the system returns to “BT•A Setup”.



Pressing the talk switch while the name of a portable player is being read aloud selects the portable player, and the following functions will become available:

- Selecting a portable player: “Connect Audio Player (Connect)”
- Changing a registered name: “Change Name”
- Deleting a portable player: “Delete Audio Player (Delete Audio)”



### Changing the passkey

**STEP 1** Select “Set Passkey” using a voice command or ,  and .

▶ Pattern A

**STEP 2** Press the talk switch, say a 4 to 8-digit number, and select “Confirm” using a voice command or ,  and .



▶ Pattern B

**STEP 2** Select a 4 to 8-digit number using ,  and . The number should be input 1 digit at a time.



**STEP 3** When the entire number to be registered as a passkey has been input, press  again.

If the number to be registered has 8 digits, pressing  is not necessary.

## Deleting a registered portable player



**STEP 1** Select “Delete Audio Player (Delete Audio)” using a voice command or  ,  and  .

### ► Pattern A



**STEP 2** Select the portable player to be deleted by either of the following methods and select “Confirm” using a voice command or  ,  and  :

- a. Press the talk switch and say the name of the desired portable player.
- b. Press the talk switch and say “List Audio Players”. When the name of the desired portable player is read aloud, press the talk switch.

### ► Pattern B

**STEP 2** Select the desired portable player to be deleted using  ,  and  .

If the portable player to be deleted is paired as a Bluetooth® phone, the registration of the mobile phone can be deleted at the same time. A voice guidance instruction to delete a mobile phone is heard.

**STEP 3** Select “Yes” or “No” using a voice command or  ,  and  . (Bluetooth® phone →P. 298)

### ■ The number of portable players that can be registered



Up to 2 portable players can be registered in the system.

### 3-3. Using the Bluetooth® audio system

## Bluetooth® audio system setup



#### ■ System setup items and operation procedures



##### ▶ Pattern A

To enter the menu for each function, follow the steps below using a voice command or ,  and  :  
(→P. 315)

##### ▶ Pattern B

**STEP 1** Press  to select “BT•A MENU”.

**STEP 2** Select “System Setup” using ,  and .

**STEP 3** Select one of the following items using ,  and  :

- Setting voice guidance volume  
“Guidance Vol” (→P. 317)
- Displaying the Bluetooth® device address and name  
“Device Name” (→P. 317)
- Initializing the system  
“Initialize” (→P. 317)

### 3-4. Using the hands-free phone system (for mobile phones)

## Hands-free system for mobile phones

The hands-free system is a function that allows you to use your mobile phone without touching it.

This system supports Bluetooth® mobile phones. Bluetooth® is a wireless data system that allows the mobile phone to wirelessly connect to the hands-free system and make/receive calls.

▶ Vehicles with a navigation system

Owners of models equipped with a navigation system should refer to the “Navigation System Owner's Manual”.

▶ Vehicles without a navigation system

Title	Page
Using the hands-free system	P. 298
Making a phone call	P. 306
Setting a mobile phone	P. 310
Security and system setup	P. 315
Using the phone book	P. 319

**■ Conditions under which the system will not operate**

- If using a mobile phone that does not support Bluetooth®
- If the mobile phone is switched off
- If you are outside service range
- If the mobile phone is not connected
- If the mobile phone's battery is low
- If the mobile phone is behind the seat or in the glove box or console box
- If metal is covering or touching the phone

**■ When using the hands-free system**

- The audio system and voice guidance are muted when making a call.
- If both parties speak at the same time, it may be difficult to hear.
- If the incoming call volume is overly loud, an echo may be heard.
- Try to face toward the microphone as much as possible when speaking.
- In the following circumstances, it may be difficult to hear the other party:
  - When driving on unpaved roads
  - When driving at high speeds
  - When a window is open
  - When the air conditioning is blowing directly on the microphone
  - When the air conditioning is set to high

**■ When transferring ownership of the vehicle**

Be sure to initialize the system to prevent personal data from being improperly accessed. (→P. 317)

**■ About Bluetooth®**

Bluetooth is a registered trademark of Bluetooth SIG, Inc.

## 3-4. Using the hands-free phone system (for mobile phones)

### ■ Compatible models

Compatible with HFP (Hands Free Profile) Ver. 1.0 or higher (Conformed: Ver. 1.5) and OPP (Object Push Profile) Ver. 1.1.

If your mobile phone does not support HFP, you cannot enter the Bluetooth<sup>®</sup> phone. If your mobile phone supports OPP alone, you cannot use the Bluetooth<sup>®</sup> phone.

### ■ Certification for the hands-free system

FCC ID: AJDK018

IC ID: 775E-K018

MADE IN JAPAN

This device complies with Part 15 of the FCC Rules and RSS-Gen and RSS-210 of IC Rules. Operation is subject to the following two conditions: (1) this device may not cause harmful interference, and (2) this device must accept any interference received, including interference that may cause undesired operation.

### CAUTION

#### ■ FCC WARNING

Changes or modifications not expressly approved by the party responsible for compliance could void the user's authority to operate the equipment.

Radio Frequency Radiation Exposure. This equipment complies with FCC radiation exposure limits set forth for uncontrolled equipment and meets the FCC radio frequency (RF) Exposure Guidelines in Supplement C to OET65. This equipment has very low levels of RF energy that it deemed to comply without maximum permissive exposure evaluation (MPE). But it is desirable that it should be installed and operated with at least 7.9 in. (20 cm) and more between the radiator and person's body (excluding extremities: hands, wrists, feet and ankles).

This transmitter must not be co-located or operated in conjunction with any other antenna or transmitter.

#### ■ Caution while driving

Do not use a mobile phone or connect the Bluetooth<sup>®</sup> phone.



 NOTICE

■ **To prevent damage to mobile phones**

Do not leave mobile phones in the vehicle. The temperature inside the vehicle may become high, resulting in damage to the phone.

### 3-4. Using the hands-free phone system (for mobile phones)

## Using the hands-free system (for mobile phones)

#### ■ Audio unit

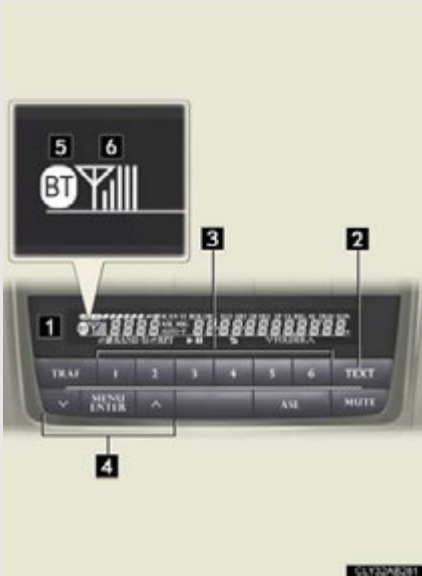

#### 1 Display

A message, name, phone number, etc. is displayed.

Lower-case characters and special characters cannot be displayed.

#### 2 Displays information that is too long to be displayed at one time on the display (press and hold)

#### 3 Selects speed dials

#### 4 Selects items such as menu and number

  : Selects an item

 : Inputs the selected item

#### 5 Bluetooth<sup>®</sup> connection condition

If “BT” is not displayed, the hands-free phone system cannot be used.

#### 6 Reception level

### ■ Steering wheel switches

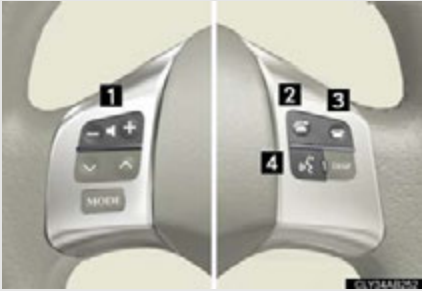

#### 1 Volume

During an incoming call:  
Adjusts the ring tone volume

During an ongoing call:  
Adjusts the receiver volume

The voice guidance volume cannot be adjusted using this button.

#### 2 Off-hook switch

Turns the hands-free system on/starts a call

#### 3 On-hook switch

Turns the hands-free system off/ends a call/refuses a call



#### 4 Talk switch

Turns the voice command system on (press)/turns the voice command system off (press and hold)

### ■ Microphone



## Operating the system using voice commands

By following voice guidance instructions output from the speaker, voice commands enable the operation of the hands-free phone system without the need to check the display or operate  ,  and  .

### ■ Operation procedure when using voice commands

Press the talk switch and follow the voice guidance instructions.

### ■ Auxiliary commands when using voice commands

The following auxiliary commands can be used when operating the system using a voice command:

“Cancel”: Exits the hands-free phone system

“Repeat”: Repeats the previous voice guidance instruction

“Go back”: Returns to the previous procedure

“Help”: Reads aloud the function summary if a help comment is registered for the selected function

## Using the hands-free phone system for the first time

Before using the hands-free phone system, it is necessary to register a mobile phone in the system. The system will enter phone registration mode automatically when starting the system with no mobile phone registered. Follow the procedure below to register (pair) a mobile phone:



**STEP 1** Press the off-hook switch or the talk switch.

The introductory guidance and phone name registration instructions are heard.

**STEP 2** Select “Pair Phone” using a voice command or  ,  and



**STEP 3** Register a phone name by either of the following methods:

- a. Select “Record Name” using  ,  and  , and say the name to be registered.
- b. Press the talk switch and say the name to be registered.

A voice guidance instruction to confirm the input is heard.

**STEP 4** Select “Confirm” using a voice command or  ,  and





A passkey is displayed and heard, and a voice guidance instruction for inputting the passkey into the mobile phone is heard.

**STEP 5** Input the passkey into the mobile phone.

Refer to the manual that comes with the mobile phone for the operation of the phone.

Guidance for registration completion is heard.

If the mobile phone has a Bluetooth<sup>®</sup> audio player, the audio player can be registered at the same time. A voice guidance instruction to register a Bluetooth<sup>®</sup> audio player is heard.

**STEP 6** Select “Yes” or “No” using a voice command or  ,  and  . (Bluetooth<sup>®</sup> audio player →P. 276)

**Menu list of the hands-free phone system**

■ Normal operation

First menu	Second menu	Third menu	Operation detail
"Callback"	-	-	Dialing a number stored in the incoming call history memory
"Redial"	-	-	Dialing a number stored in the outgoing call history memory
"Phonebook"	"Add Entry"	-	Adding a new phone number
	"Change Name"	-	Changing the registered name in the phone book
	"Delete Entry"	-	Deleting the registered data
	"Del Spd Dial"	-	Deleting speed dials
	"List Names"	-	Listing the registered data
	"Speed Dial"	-	Setting speed dials

First menu	Second menu	Third menu	Operation detail
"Setup"	"Security"	"Set PIN"	Setting a PIN code
		"Phbk Lock"	Locking the phone book
		"Phbk Unlock"	Unlocking the phone book
	"Phone Setup"	"Pair Phone"	Registering the mobile phone to be used
		"Connect"	Selecting a mobile phone to be used
		"Change Name"	Changing the registered name of a mobile phone
		"List Phones"	Listing the registered mobile phones
		"Set Passkey"	Changing the passkey
		"Delete Phone"	Deleting a registered mobile phone
	"System Setup"	"Guidance Vol"	Setting voice guidance volume
		"Device Name"	Displaying the Bluetooth <sup>®</sup> device address and name
"Initialize"		Initializing the system	

■ Short cut key operation

First menu	Second menu	Operation detail
"Dial XXX (name)"	-	Dialing a name registered in the phone book
"Phone book add Entry"	-	Adding a new phone number
"Phone book Change name"	-	Changing a registered name in the phone book
"Phone book Delete Entry"	-	Deleting the registered data
"Phone book List names"	-	Listing the registered data
"Phone book Set Speed Dial"	-	Setting speed dials
"Phone book Delete Speed Dial"	-	Deleting speed dials
"Dial XXX (number)"	-	Dialing by inputting a number
"Phonebook"	"Phonebook Unlock"	Unlocking the phone book
	"Phonebook Lock"	Locking the phone book



### ■ Automatic volume adjustment

When vehicle speed reaches 50 mph (80 km/h) or more, the volume automatically increases. The volume returns to the previous volume setting when vehicle speed drops to 43 mph (70 km/h) or less.

### ■ When using a voice command

For numbers, say a combination of single digits from zero to nine, # (pound), \* (star), and + (plus).

Say the command correctly and clearly.

### ■ Situations in which the system may not recognize your voice

- When driving on rough roads
- When driving at high speeds
- When air is blowing out of the vents onto the microphone
- When the air conditioning fan emits a loud noise

### ■ Operations that cannot be performed while driving

- Operating the system with  ,  and 
- Registering a mobile phone to the system

### ■ Changing the passkey

→P. 313

### Making a phone call

#### ■ Making a phone call

- Dialing by inputting a number  
“Dial by number”
- Dialing by inputting a name  
“Dial by name”
- Speed dialing
- Dialing a number stored in the outgoing history memory  
“Redial”
- Dialing a number stored in the incoming history memory  
“Call back”

#### ■ Receiving a phone call

- Answering a phone call
- Refusing a phone call



#### ■ Transferring a phone call

#### ■ Call waiting



#### ■ Using the call history memory

- Dialing
- Storing data in the phone book
- Deleting

### Dialing by inputting a number

- STEP 1** Press the talk switch and say “Dial by number”.
- STEP 2** Press the talk switch and say the phone number.
- STEP 3** Dial by one of the following methods:
- Press the off-hook switch.
  - Press the talk switch and say “Dial”.
  - Select “Dial” using  ,  and .

### Dialing by inputting a name

- STEP 1** Press the talk switch and say “Dial by name”.
- STEP 2** Select a registered name to be input by either of the following methods:
- Press the talk switch and say a registered name.
  - Press the talk switch and say “List Names”. Press the talk switch when the desired name is read aloud.
- STEP 3** Dial by one of the following methods:
- Press the off-hook switch.
  - Press the talk switch and say “Dial”.
  - Select “Dial” using  ,  and .

### Speed dialing

- STEP 1** Press the off-hook switch.
- STEP 2** Press the preset button in which the desired number is registered.
- STEP 3** Press the off-hook switch.

### When receiving a phone call

#### ■ Answering a phone call

Press the off-hook switch.

#### ■ Refusing a phone call

Press the on-hook switch.

### Transferring a phone call

A call can be transferred between the mobile phone and system while dialing, receiving a call, or during a call. Use one of the following methods:

- a. Operate the mobile phone.

Refer to the manual that comes with the mobile phone for the operation of the phone.

- b. Press the off-hook switch<sup>\*1</sup>.

- c. Press the talk switch and say "Call Transfer"<sup>\*2</sup>.

<sup>\*1</sup>: This operation can be performed only when transferring a call from the mobile phone to the system during a call.

<sup>\*2</sup>: While the vehicle is in motion, calls cannot be transferred from the system to the mobile phone.

### Call waiting

When a call is interrupted by an incoming call from a third party, the following options will become available:



- Answer the incoming call: Press the off-hook switch. (Press the off-hook switch again as necessary to switch back and forth between calls.)
- Refuse the incoming call: Press the on-hook switch.

## Using the call history memory



Follow the procedure below to use a number stored in the call history memory:



**STEP 1** Press the talk switch and say “Redial” (when using a number stored in the outgoing call history memory) or “Call back” (when using a number stored in the incoming call history memory).



**STEP 2** Select the number by either of the following methods:

- a. Say “Previous” or “Go back” until the desired number is displayed.
- b. Select the desired number using  ,  and  .

**STEP 3** The following operations can be performed:

**Dialing:** Press the off-hook switch or select “Dial” using a voice command or  ,  and  .

**Storing the number in the phone book:** Select “Store” and then “Confirm” using a voice command or  ,  and  .

**Deleting:** Select “Delete” and then “Confirm” using a voice command or  ,  and  .

### ■ Call waiting

- If your phone does not support HFP Ver. 1.5, this function cannot be used.
- Call waiting operation may differ depending on your mobile phone and service provider.

### ■ Call history

Up to 5 numbers can be stored in each of the outgoing and incoming call history memories.

### ■ When talking on the phone



- Do not talk at the same time as the other party.
- Keep the volume of the incoming voice down. Otherwise, voice echo will increase.

## 3-4. Using the hands-free phone system (for mobile phones)

### Setting a mobile phone



Registering a mobile phone in the hands-free phone system allows the system to function. The following functions can be used for registered mobile phones:

#### ■ Functions and operation procedures



To enter the menu for each function, follow the steps below using a voice command or ,  and  :

- Registering a mobile phone
  1. "Setup" → 2. "Phone Setup" → 3. "Pair Phone"
- Selecting a mobile phone to be used
  1. "Setup" → 2. "Phone Setup" → 3. "Connect Phone (Connect)"
- Changing the registered name of a mobile phone
  1. "Setup" → 2. "Phone Setup" → 3. "Change Name"
- Listing the registered mobile phones
  1. "Setup" → 2. "Phone Setup" → 3. "List Phones"
- Changing the passkey
  1. "Setup" → 2. "Phone Setup" → 3. "Set Passkey"
- Deleting a registered mobile phone
  1. "Setup" → 2. "Phone Setup" → 3. "Delete Phone"



#### Registering a mobile phone

Select "Pair Phone" using a voice command or ,  and , and perform the procedure for registering a mobile phone. (→P. 301)

## Selecting a mobile phone to be used



**STEP 1** Select “Connect Phone (Connect)” using a voice command or  ,  and  .

### ► Pattern A



**STEP 2** Select the mobile phone to be used by either of the following methods, and select “Confirm” by using a voice command or  ,  and  :

- a. Press the talk switch and say the name of the desired mobile phone.
- b. Press the talk switch and say “List Phones”. When the name of the desired mobile phone is read aloud, press the talk switch.



### ► Pattern B

**STEP 2** Select the mobile phone to be used using  ,  and  .

## Changing the registered name of a mobile phone



**STEP 1** Select “Change Name” using a voice command or  ,  and  .



### ► Pattern A

**STEP 2** Select the name of the mobile phone to be changed by either of the following methods, and select “Confirm” using a voice command or  ,  and  :

- a. Press the talk switch and say the name of the desired mobile phone.
- b. Press the talk switch and say “List Phones”. When the name of the desired mobile phone is read aloud, press the talk switch.

### ► Pattern B



**STEP 2** Select the desired mobile phone name to be changed using  ,  and  .

**STEP 3** Press the talk switch or select “Record Name” using  ,  and  , and say the new name.

**STEP 4** Select “Confirm” using a voice command or  ,  and  .



## Listing the registered mobile phones



Select “List Phones” using a voice command or ,  and . The list of registered mobile phones will be read aloud.

When listing is complete, the system returns to “Phone Setup”.



Pressing the talk switch while the name of a mobile phone is being read aloud selects the mobile phone, and the following functions will become available:

- Selecting a mobile phone: “Connect Phone (Connect)”
- Changing a registered name: “Change Name”
- Deleting a mobile phone: “Delete Phone”



## Changing the passkey

**STEP 1** Select “Set Passkey” using a voice command or ,  and .

▶ Pattern A

**STEP 2** Press the talk switch, say a 4 to 8-digit number, and select “Confirm” using a voice command or ,  and .



▶ Pattern B

**STEP 2** Select a 4 to 8-digit number using ,  and . The number should be input 1 digit at a time.



**STEP 3** When the entire number to be registered as a passkey has been input, press  again.

If the number to be registered has 8 digits, pressing  is not necessary.

## Deleting a registered mobile phone



**STEP 1** Select “Delete Phone” using a voice command or  ,   
and .

### ► Pattern A



**STEP 2** Select the mobile phone to be deleted by either of the following methods and select “Confirm” using a voice command or ,  and .

- Press the talk switch and say the name of the desired mobile phone.
- Press the talk switch and say “List Phones”. When the name of the desired mobile phone is read aloud, press the talk switch.

### ► Pattern B

**STEP 2** Select the desired mobile phone to be deleted using ,  and .

If the mobile phone to be deleted is paired as a Bluetooth<sup>®</sup> audio player, the registration of the audio player can be deleted at the same time. A voice guidance instruction to delete a Bluetooth<sup>®</sup> audio player is heard.



**STEP 3** Select “Yes” or “No” using a voice command or ,   
and . (Bluetooth<sup>®</sup> audio player →P. 276)

## ■ The number of mobile phones that can be registered

Up to 6 mobile phones can be registered in the system.



## Security and system setup

### ■ Security setting items and operation procedures

To enter the menu for each function, follow the steps below using a voice command or ,  and  :

- Setting or changing the PIN (Personal Identification Number)
  1. "Setup" → 2. "Security" → 3. "Set PIN"
- Locking the phone book
  1. "Setup" → 2. "Security" → 3. "Phonebook Lock (Phbk Lock)"
- Unlocking the phone book
  1. "Setup" → 2. "Security" → 3. "Phonebook Unlock (Phbk Unlock)"



### ■ System setup items and operation procedures

To enter the menu for each function, follow the steps below using ,  and  :

- Setting voice guidance volume
  1. "Setup" → 2. "System Setup" → 3. "Guidance Vol"
- Displaying the Bluetooth<sup>®</sup> device address and name
  1. "Setup" → 2. "System Setup" → 3. "Device Name"
- Initializing the system
  1. "Setup" → 2. "System Setup" → 3. "Initialize"

## Setting or changing the PIN



### ■ Setting a PIN



**STEP 1** Select “Set PIN” using a voice command or ,  and .



**STEP 2** Enter a PIN using a voice command or ,  and .

When using ,  and , input the code 1 digit at a time.

### ■ Changing the PIN



**STEP 1** Select “Set PIN” using a voice command or ,  and .



**STEP 2** Enter the registered PIN using a voice command or ,  and .

**STEP 3** Enter a new PIN using a voice command or ,  and .

When using ,  and , input the code 1 digit at a time.

## Locking or unlocking the phone book



**STEP 1** Select “Phonebook Lock (Phbk Lock)” or “Phonebook Unlock (Phbk Unlock)” using a voice command or ,  and .



**STEP 2** Input the PIN by either of the following methods and select “Confirm” using a voice command or ,  and .

a. Press the talk switch and say the registered PIN.



b. Input a new PIN using ,  and .

### Setting voice guidance volume

**STEP 1** Select “Guidance Vol” using ,  and .

**STEP 2** Change the voice guidance volume using ,  and .



### Displaying the Bluetooth<sup>®</sup> device address and name



**STEP 1** Select “Device Name” using ,  and .

**STEP 2** Press  or  to display the Bluetooth<sup>®</sup> device address and name.

**STEP 3** Select “Go Back” using ,  and  to return to “System Setup”.

### Initializing the system

**STEP 1** Select “Initialize” and then “Confirm” using ,  and .

**STEP 2** Select “Confirm” again using ,  and .

### ■ Initialization

- The following data in the system can be initialized:
  - Phone book
  - Outgoing and incoming call history
  - Speed dials
  - Registered mobile phone data
  - Security code
  - Registered Bluetooth<sup>®</sup> enabled portable player data
  - Passkey for the mobile phones
  - Passkey for the Bluetooth<sup>®</sup> audio players
  - Guidance volume
  - Receiver volume
  - Ring tone volume
- Once the initialization has been completed, the data cannot be restored to its original state.



### ■ When the phone book is locked

The following functions cannot be used:

- Dialing by inputting a name
- Speed dialing
- Dialing a number stored in the call history memory
- Using the phone book

### 3-4. Using the hands-free phone system (for mobile phones)



## Using the phone book

To enter the menu for each function, follow the steps below using a voice command or ,  and  :



- Adding a new phone number
  1. "Phonebook" → 2. "Add Entry"
- Changing the registered name in the phone book
  1. "Phonebook" → 2. "Change Name"
- Listing the registered data
  1. "Phonebook" → 2. "List Names"
- Setting speed dials
  1. "Phonebook" → 2. "Set Speed Dial (Speed Dial)"
- Deleting the registered data
  1. "Phonebook" → 2. "Delete Entry"
- Deleting speed dials
  1. "Phonebook" → 2. "Delete Speed Dial (Del Spd Dial)"

#### Adding a new phone number



The following methods can be used to add a new phone number:

- Inputting a phone number using a voice command
- Transferring data from the mobile phone
- Inputting a phone number using ,  and 
- Selecting a phone number from outgoing or incoming call history

## ■ Adding procedure



**STEP 1** Select “Add Entry” using a voice command or  ,  and  .

**STEP 2** Use one of the following methods to input a telephone number:  
Inputting a telephone number using a voice command:

STEP2-1 Select “By Voice” using a voice command or  ,  and  .

STEP2-2 Press the talk switch, say the desired number, and select “Confirm” using a voice command.

Transferring data from the mobile phone:



STEP2-1 Select “By Phone” and then “Confirm” using a voice command or  ,  and  .

STEP2-2 Transfer the data from the mobile phone.



Refer to the manual that comes with the mobile phone for details on transferring data.



STEP2-3 Select the data to be registered by either of the following methods:





a. Say “Previous” or “Next” until the desired data is displayed, and select “Confirm” using a voice command.

b. Select the desired data using  ,  and  .





Inputting a phone number using ,  and  :



STEP2-1 Select “Manual Input” using ,  and .

STEP2-2 Input a phone number using ,  and , and press  again.

Input the phone number 1 digit at a time.



Selecting a phone number from the outgoing or incoming call history:



STEP2-1 Select “Call History” using a voice command or ,  and .

STEP2-2 Select “Outgoing” or “Incoming” using a voice command or ,  and .

STEP2-3 Select the data to be registered by either of the following methods:



a. Say “Previous” or “Go back” until the desired data is displayed, and select “Confirm” using a voice command.

b. Select the desired data using ,  and .

**STEP 3** Select the name to be registered by either of the following methods, and select “Confirm” using a voice command or ,  and .



a. Press the talk switch and say the desired name.

b. Select “Record Name” using ,  and , and say the desired name.



**STEP 4** Select “Confirm” using a voice command or ,  and .

In **STEP 4**, selecting “Set Speed Dial (Speed Dial)” instead of “Confirm” registers the newly added phone number as a speed dial.

## Changing the registered name in the phone book



**STEP 1** Select “Change Name” using a voice command or ,  and .



### ► Pattern A

**STEP 2** Select the name to be changed by either of the following methods, and select “Confirm” using a voice command or ,  and .

- a. Press the talk switch and say the desired name.
- b. Press the talk switch and say “List Names”. When the desired name is read aloud, press the talk switch.



### ► Pattern B

**STEP 2** Select the desired name to be changed using ,  and .

**STEP 3** Press the talk switch or select “Record Name” using ,  and , and say the new name.

**STEP 4** Select “Confirm” using a voice command or ,  and .

## Listing the registered data

Select “List Names” using a voice command or ,  and .



The list of the registered data will be read aloud.

When listing is complete, the system returns to the “Phonebook”.



Pressing the talk switch while the desired data is being read aloud selects the data, and the following function will become available:

- Dialing: “Dial”
- Changing a registered name: “Change Name”
- Deleting an entry: “Delete Entry”
- Setting a speed dial: “Set Speed Dial (Speed Dial)”

## Setting speed dials



**STEP 1** Select “Set Speed Dial (Speed Dial)” using a voice command or ,  and .

### ► Pattern A



**STEP 2** Select the data to be registered as a speed dial by either of the following methods and select “Confirm” using a voice command or ,  and .

- Press the talk switch and say the desired name.
- Press the talk switch and say “List Names”. When the desired name is read aloud, press the talk switch.



### ► Pattern B

**STEP 2** Select the desired data using ,  and .



**STEP 3** Select the desired preset button and register the data into speed dial by either of the following methods:

- Press the desired preset button and select “Confirm” by using a voice command or ,  and .
- Press and hold the desired preset button.

## Deleting the registered data



**STEP 1** Select “Delete Entry” using a voice command or  ,  and .

### ► Pattern A

**STEP 2** Select the data to be deleted by either of the following methods and select “Confirm” using a voice command or  ,  and .



- a. Press the talk switch and say the name of the desired phone number.
- b. Press the talk switch and say “List Names”. When the name of the desired phone number is read aloud, press the talk switch.

### ► Pattern B

**STEP 2** Select the desired data to be deleted using  ,  and .

## Deleting speed dials

**STEP 1** Select “Delete Speed Dial (Del Spd Dial)” using a voice command or  ,  and .

**STEP 2** Press the preset button to which the desired speed dial is registered and select “Confirm” using a voice command or  ,  and .

### ■ Limitation of number of digits

A phone number that exceeds 24 digits cannot be registered.

### 3-5. Using the interior lights

## Interior lights list

Your Lexus is equipped with the illuminated entry system to assist in entering the vehicle. Owing to the function of the system, the lights shown in the following illustration automatically turn on/off according to the presence of the electronic key, whether the doors are locked/unlocked, whether the doors are opened/closed, and the “ENGINE START STOP” switch mode.

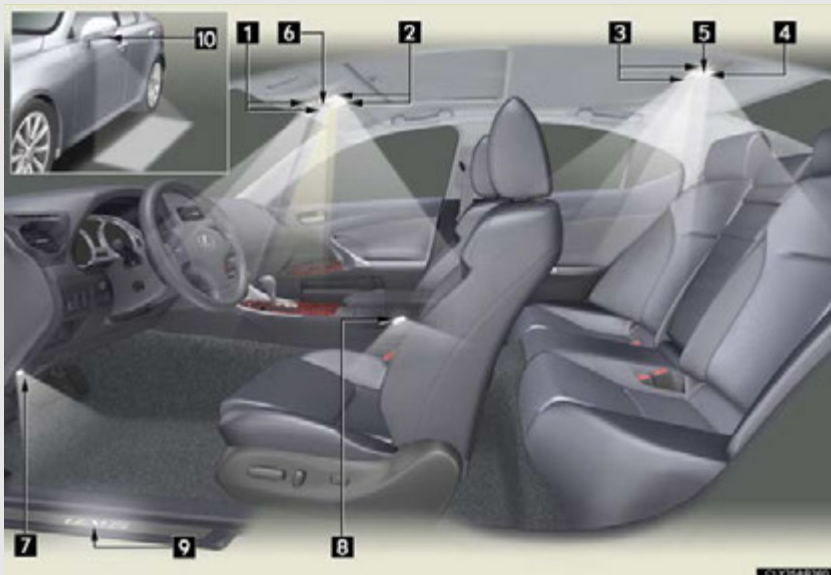

- 1 Front personal lights (→P. 327)
- 2 Front interior lights (→P. 327)
- 3 Rear personal lights (→P. 327)
- 4 Rear interior light
- 5 Rear overhead courtesy light
- 6 Shift lever light (when the “ENGINE START STOP” switch is in ACCESSORY or IGNITION ON mode)
- 7 Front footwell lights

- 8 Front door courtesy light
- 9 Front scuff lights (if equipped)
- 10 Outer foot lights

Turning the instrument panel light control knob fully to the left disables the shift lever lights and front footwell lights.

---

### ■ To prevent the battery from being discharged

If the interior lights remain on when the door is not fully closed and the interior light switch (door position on/off) is on, the lights will go off automatically after 20 minutes.

### ■ Customization that can be configured at Lexus dealer

Setting (e.g. The time elapsed before lights turn off) can be changed. (Customizable features →P. 553)

## Interior lights

### ► Models without a moon roof



- 1 Door position on/off
- 2 On/off

### ► Models with a moon roof



- 1 Door position on/off
- 2 On/off

## Personal lights

### ► Front (models without a moon roof)



On/off

► Front (models with a moon roof)



On/off

► Rear



On/off



## 3-6. Using the storage features

### List of storage features

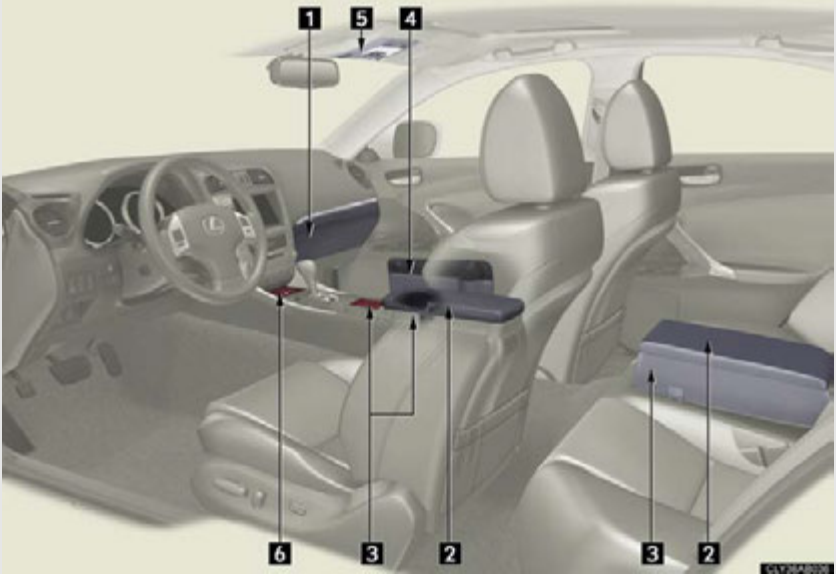

- 1 Glove box
- 2 Console boxes
- 3 Cup holders
- 4 Bottle holders/door pockets
- 5 Overhead console
- 6 Auxiliary box (if equipped)

#### CAUTION

##### **■ Items that should not be left in the storage spaces**

Do not leave glasses, lighters or spray cans in the storage spaces, as this may cause the following when cabin temperature becomes high:

- Glasses may be deformed by heat or cracked if they come into contact with other stored items.
- Lighters or spray cans may explode. If they come into contact with other stored items, the lighter may catch fire or the spray can may release gas, causing a fire hazard.

## Glove box

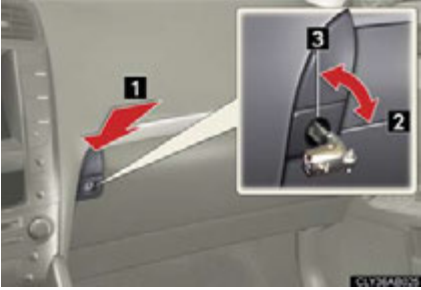

- 1 Open (push button)
- 2 Lock with the mechanical key
- 3 Unlock with the mechanical key

### Glove box light

The glove box light turns on when the “ENGINE START STOP” switch is in IGNITION ON mode.

### Trunk opener main switch

The trunk opener main switch is located in the glove box. (→ P. 52)

## ⚠ CAUTION

### ■ Caution while driving

Keep the glove box closed.

Injuries may result in the event of an accident or sudden braking.

## Console boxes

### ► Front



- 1 Pull up the knob to release the lock.
- 2 Slide the armrest.
- 3 Pull up the knob to release the lock.
- 4 Lift the armrest to open.

► Rear (if equipped)

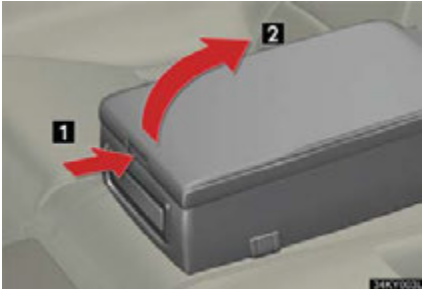

**1** Press the button to release the lock.

**2** Lift the armrest to open.

■ Console box light (front)

The console box light turns on when the “ENGINE START STOP” switch is in IGNITION ON mode.

■ Using the front console box to store CD cases



Store a CD case with the hinged portion facing either the front or back of the console box.

**!** CAUTION

■ Caution while driving

Keep the console box closed.

Injuries may result in the event of an accident or sudden braking.

## Overhead console



The overhead console is useful for temporarily storing sunglasses and similar small items.

### **!** CAUTION

#### ■ Caution while driving

Do not leave the overhead console open while driving. Items may fall out and cause injury.

## Cup holders

### ► Front (press-in type)



To open, press down and release the front of the cup holder lid.

▶ Front (slide type)

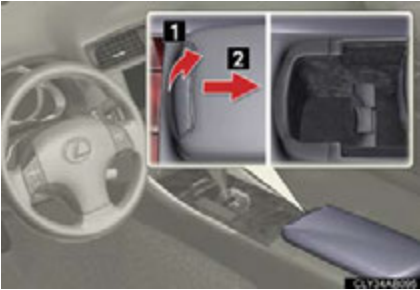

- 1 Press the knob to release the lock.
- 2 Slide the armrest.

▶ Rear

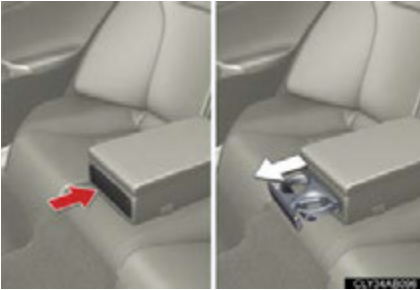

To open, press in and release the rear cup holder on the rear center armrest.

■ Using the front cup holder (slide type) to store small items



Remove the cup holder insert by holding the base part.

**! CAUTION**

**■ Items unsuitable for the cup holder**

Do not place anything other than cups or aluminum cans in the cup holders. Other items may be thrown out of the holders in the event of an accident or sudden braking and cause injury. If possible, cover hot drinks to prevent burns.

**■ When not in use**

Keep the cup holders closed. Injuries may result in the event of an accident or sudden braking.

**Bottle holders/door pockets**

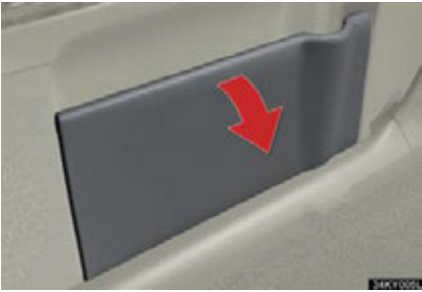

The door pockets can be opened and closed.

When installing the bottle, close the cap of the bottle.

**! CAUTION**

**■ Caution while driving**

Keep the door pockets closed. Injuries may result in the event of an accident or sudden braking.

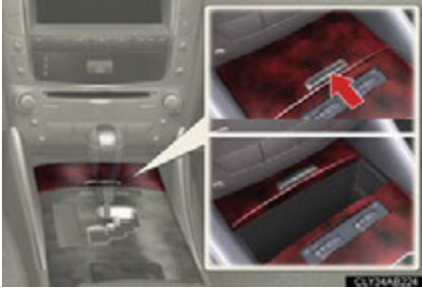
**Auxiliary box (if equipped)**

Push the back part of the lid to open. Push the lid again to close.

**! CAUTION****■ Caution while driving**

Do not leave open while driving.

Items stored in the auxiliary box may fall out and cause death or serious injury in case of an accident or sudden stop.

### 3-7. Other interior features

## Sun visors



- 1 Forward position:  
Flip down.
- 2 Side position:  
Flip down, unhook, and swing  
to the side.



### 3-7. Other interior features

## Vanity mirrors

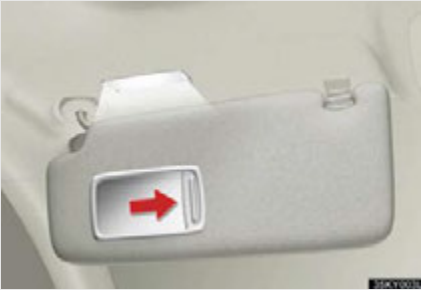

Slide the cover.

The light turns on when the cover is opened.

## 3-7. Other interior features

### Clock



- 1 Adjusts the hour.
- 2 Adjusts the minutes.
- 3 Rounds to the nearest hour.\*

\*: e.g. 1:00 to 1:29 → 1:00

1:30 to 1:59 → 2:00

#### ■ The clock is displayed when

The "ENGINE START STOP" switch is in ACCESSORY or IGNITION ON mode.

## 3-7. Other interior features

### Satellite switches

The satellite switches can be used to change the settings of various features. Settings are shown on the multi-information display.

#### ■ Operating the satellite switches

##### STEP 1



Bring up satellite switch mode on the multi-information display.

Press “<”, “>” or the “ON/OFF” button.

##### STEP 2

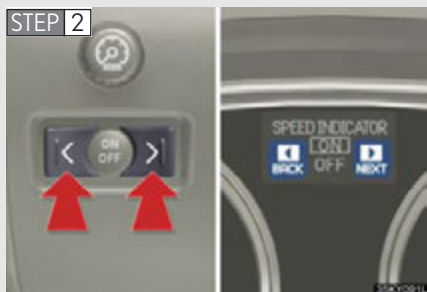

Select the item whose setting is to be changed.

Press “<” or “>” to display the item whose setting is to be changed.

STEP 3



Change the settings.

Press the “ON/OFF” button to change the settings (e.g. on/off).

### ■ Items that can be set using the satellite switches



Intuitive parking assist (→P. 190) on/off (if equipped)



Tire pressure warning system initialization (→P. 414)



ID code selection for the tire pressure warning system (→P. 416)



Vehicle speed indicator on/off and speed setting (→P. 160)



Tacho indicator on/off and engine speed (rpm) setting (→P. 160)

---

### ■ Changing the settings

Each item is displayed and its setting can be changed only in the following conditions:

- Intuitive parking assist: When the “ENGINE START STOP” switch is in IGNITION ON mode.
- Items other than the above: When the “ENGINE START STOP” switch is in IGNITION ON mode and the vehicle is stopped.

### ■ Display

The display will return to the original display if the satellite switches are not operated for an extended period.

Even if the display is in satellite switch mode, it will switch in the event of a warning is used. If this occurs, press any of the satellite switches or “DISP” switch on the steering wheel to return the display to satellite switch mode.

### 3-7. Other interior features

## Ashtrays\*

#### ► Front



Push the back part of the lid to open. Push the lid again to close.

Push the lever to remove the ashtray.

#### ► Rear

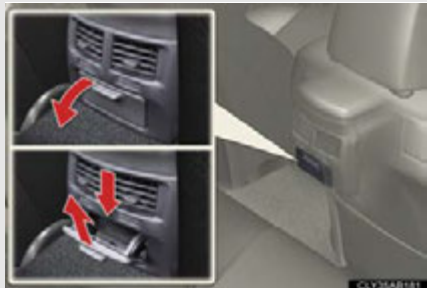

Pull the ashtray lid to open.

Hold the plate down and pull the ashtray upwards to remove.

### ⚠ CAUTION

#### ■ When not in use

Keep the ashtray closed.

Injuries may result in the event of sudden braking, sudden swerving or an accident.

#### ■ To prevent fire

● Fully extinguish matches and cigarettes before putting them in the ashtray, then make sure the ashtray is fully closed.

● Do not place paper or any other type of flammable object in the ashtray.

\*: If equipped

### 3-7. Other interior features

## Cigarette lighter\*

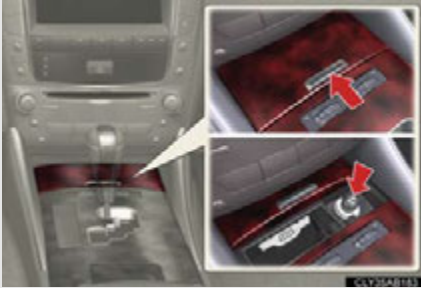

Push the back part of the lid to open, and push the cigarette lighter down.

The cigarette lighter will pop up when it is ready for use.

#### ■ The cigarette lighter can be used when

The "ENGINE START STOP" switch is in ACCESSORY or IGNITION ON mode.

#### ⚠ CAUTION

##### ■ When not in use

Keep the lid closed.

Injuries may result in the event of an accident or sudden braking.

##### ■ To avoid burns or fires

- Do not touch the metal parts of the cigarette lighter.
- Do not hold the cigarette lighter down. It could overheat and cause a fire.
- Do not insert anything other than the cigarette lighter into the outlet.

\*: If equipped

### 3-7. Other interior features

## Power outlet

The power outlet can be used for 12 V accessories that run on less than 10 A.



#### ■ The power outlet can be used when

The “ENGINE START STOP” switch is in ACCESSORY or IGNITION ON mode.

#### NOTICE

##### ■ To avoid damaging the power outlet

Close the power outlet lid when the power outlet is not in use.  
Foreign objects or liquids that enter the power outlet may cause a short circuit.

##### ■ To prevent the fuse from being blown

Do not use an accessory that uses more than 12 V 10 A.

##### ■ To prevent the battery from being discharged

Do not use the power outlet longer than necessary when the engine is off.



### 3-7. Other interior features

## Seat heaters\*

- ▶ Vehicles with an automatic transmission

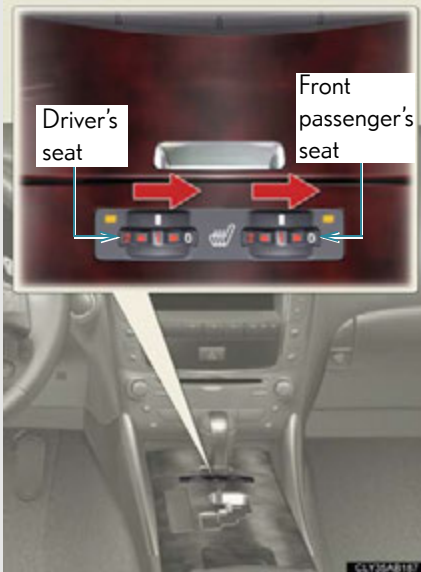

### Heats the seats

The indicator light comes on.  
The higher the number, the warmer the seats become.

\*: If equipped

► Vehicles with a manual transmission

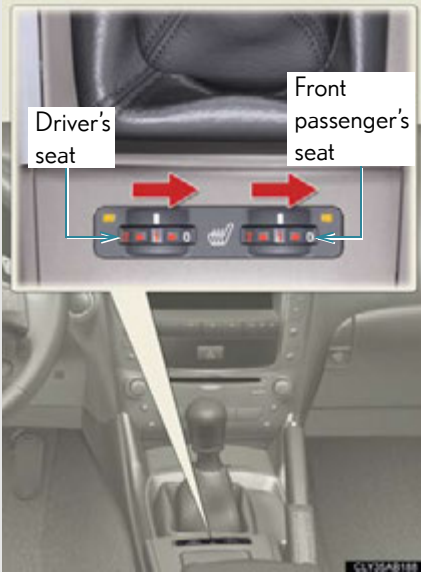

Heats the seats

The indicator light comes on.  
The higher the number, the warmer the seats become.

■ The seat heaters can be used when

The "ENGINE START STOP" switch is in IGNITION ON mode.

■ When not in use

Set the dial to "0". The indicator light turns off.

 **CAUTION****■ Burns**

- Use caution when seating the following persons in a seat with the seat heater on to avoid the possibility of burns:
  - Babies, small children, the elderly, the sick and the disabled
  - Persons with sensitive skin
  - Persons who are fatigued
  - Persons who have taken alcohol or drugs that induce sleep (sleeping drugs, cold remedies, etc.)
- Do not cover the seat with anything when using the seat heater.  
Using the seat heater with a blanket or cushion increases the temperature of the seat and may lead to overheating.

 **NOTICE****■ To prevent seat heater damage**

Do not put unevenly weighted objects on the seat and do not stick sharp objects (needles, nails, etc.) into the seat.

**■ To prevent battery discharge**

Turn the switches off when the engine is off.

### 3-7. Other interior features

## Seat heaters and ventilators\*

The seat heaters and ventilators heat the seats and maintain good airflow by blowing air from the seats.

► Vehicles with an automatic transmission

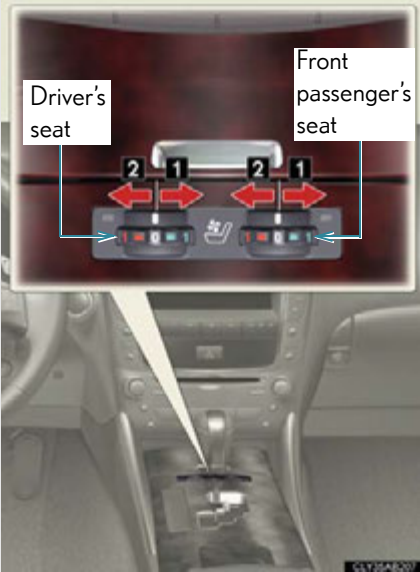

#### 1 Heats the seats

The indicator light (amber) comes on.

The higher the number, the warmer the seats become.

#### 2 Blows air from the seats

The indicator light (green) comes on.

The higher the number, the stronger the airflow becomes.

► Vehicles with a manual transmission

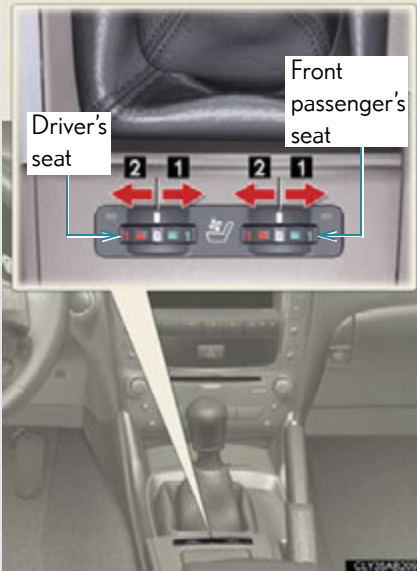

**1** Heats the seats

The indicator light (amber) comes on.

The higher the number, the warmer the seats become.

**2** Blows air from the seats

The indicator light (green) comes on.

The higher the number, the stronger the airflow becomes.

■ The seat heaters and ventilators can be used when

The “ENGINE START STOP” switch is in IGNITION ON mode.

■ When not in use

Set the dial to “0”. The indicator light turns off.

 **CAUTION**

**■ Burns**

- Use caution when seating the following persons in a seat with the seat heater on to avoid the possibility of burns:
  - Babies, small children, the elderly, the sick and the disabled
  - Persons with sensitive skin
  - Persons who are fatigued
  - Persons who have taken alcohol or drugs that induce sleep (sleeping drugs, cold remedies, etc.)
- Do not cover the seat with anything when using the seat heater.  
Using the seat heater with a blanket or cushion increases the temperature of the seat and may lead to overheating.

 **NOTICE**

**■ To prevent seat heaters and ventilators damage**

Do not put unevenly weighted objects on the seat and do not stick sharp objects (needles, nails, etc.) into the seat.

**■ To prevent battery discharge**

Turn the switches off when the engine is off.

## Armrest

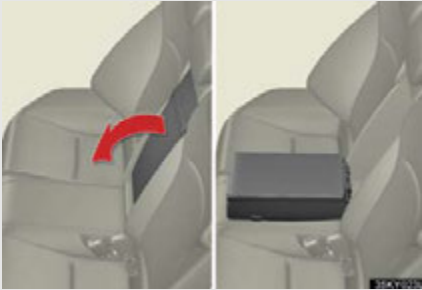

Pull the armrest down for use.

 NOTICE

■ **To prevent damage to the armrest**

Do not place too much strain on the armrest.

### 3-7. Other interior features

## Rear sunshade\*

The rear sunshade can be raised and lowered by operating the switch shown below.



Raise/lower

#### ■ Reverse operation feature

This function will become operational after the vehicle has been driven at 9 mph (15 km/h) or more with the rear sunshade in the raised position.

To ensure adequate rear visibility, the sunshade automatically lowers when the shift lever is shifted to R and the function is in an operational condition.

However, the rear sunshade is raised again if either of the following occurs:

- The switch is pressed again.
- The shift lever is shifted out of R, and the vehicle reaches a speed of 9 mph (15 km/h).

If the engine is turned off when the rear sunshade has been lowered due to the reverse operation feature, it will not be raised even when the engine is turned on again and the vehicle reaches a speed of 9 mph (15 km/h). To raise the sunshade again, press the switch.

#### ■ The rear sunshade can be used when

The "ENGINE START STOP" switch is in IGNITION ON mode.

\*: If equipped



 **CAUTION****■ When the rear sunshade is being raised or lowered**

Do not place fingers or other objects in the fastener section or in the opening. They may get caught, causing injury.

 **NOTICE****■ To prevent the battery from being discharged**

Do not operate the rear sunshade when the engine is not running.

**■ To ensure normal operation of the sunshade**

Observe the following precautions.

- Do not place excessive load on the motor or other components.
- Do not place objects where they may hinder opening and closing operations.
- Do not attach items to the rear sunshade.
- Keep the opening clean and clear of obstructions.
- Do not operate the rear sunshade continuously over long periods of time.

### 3-7. Other interior features

## Trunk storage extension

Long objects can be loaded in the vehicle by utilizing the trunk space and rear seat area.

STEP 1



Pull down the rear seat armrest.

STEP 2



Open the inside trunk door from the trunk and load baggage or other items.

### CAUTION

#### When not in use

Ensure that the inside trunk door is closed.

In the event of sudden braking, items stored in the trunk may be thrown forward into the cabin, resulting in injury.

### 3-7. Other interior features

## Coat hooks

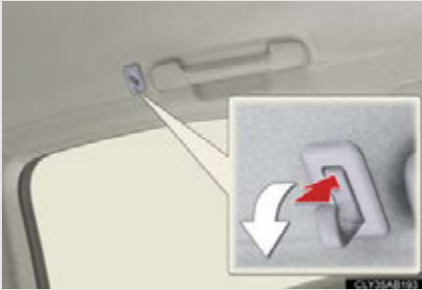

To use the coat hook, push it on.

#### CAUTION

##### ■ Items that must not be hung on the hook

Do not hang a coat hanger or other hard or sharp object on the hook. If the SRS curtain shield airbags deploy, these items may become projectiles that cause death or serious injury.

## 3-7. Other interior features

### Floor mat

Use only floor mats designed specifically for vehicles of the same model and model year as your vehicle. Fix them securely in place onto the carpet.



Fix the floor mat in place using the retaining hooks (clips) provided.

The shape of the retaining hooks (clips) and the fixing procedure of the floor mat for your vehicle may differ from those shown in the illustration. For details, refer to the floor mat retention clip installation instructions supplied with the clips.

#### CAUTION

Observe the following precautions.

Failure to do so may cause the driver's floor mat to slip, possibly interfering with the pedals while driving. An unexpectedly high speed may result or it may become difficult to stop the vehicle, leading to a serious accident.

#### ■ When installing the driver's floor mat

- Do not use floor mats designed for other models or different model year vehicles, even if they are Lexus Genuine floor mats.
- Only use floor mats designed for the driver's seat.
- Always install the floor mat securely using the retaining hooks (clips) provided.
- Do not use two or more floor mats on top of each other.
- Do not place the floor mat bottom-side up or upside-down.

#### ■ Before driving



- Check that the floor mat is securely fixed in the correct place with all the provided retaining hooks (clips). Be especially careful to perform this check after cleaning the floor.
- With the engine stopped and the shift lever in P (automatic transmission) or N (manual transmission), fully depress each pedal to the floor to make sure it does not interfere with the floor mat.

### 3-7. Other interior features

## Trunk features

#### ■ Cargo hooks



Cargo hooks are provided for securing loose items.

#### ■ Shopping bag hooks



#### ■ First-aid kit storage belt



- 1 Loosen
- 2 Tighten

### ■ Warning triangle storage belt

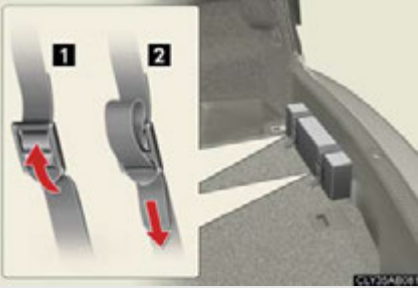

- 1 Loosen
- 2 Tighten

### ■ Luggage mat



Pull the lever upwards when lifting the luggage mat up.

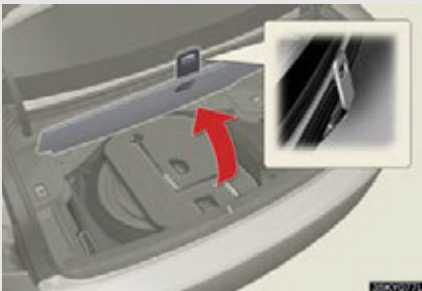

The lever can be hooked on the edge of the trunk.

### ⚠ CAUTION

#### ■ When the cargo hooks are not in use

To avoid injury, always return the cargo hooks to their positions when they are not in use.

 NOTICE**■ When closing the trunk**

Do not leave the luggage mat lever hooked on the edge of the trunk.  
The luggage mat may get damaged.

### 3-7. Other interior features

## Garage door opener

The garage door opener can be programmed to operate garage doors, gates, entry doors, door locks, home lighting systems, security systems, and other devices.

The garage door opener (HomeLink<sup>®</sup> Universal Transceiver) is manufactured under license from HomeLink<sup>®</sup>.

### Programming the HomeLink<sup>®</sup> (for U.S.A. owners)

The HomeLink<sup>®</sup> compatible transceiver in your vehicle has 3 buttons which can be programmed to operate 3 different devices. Refer to the programming method below appropriate for the device.

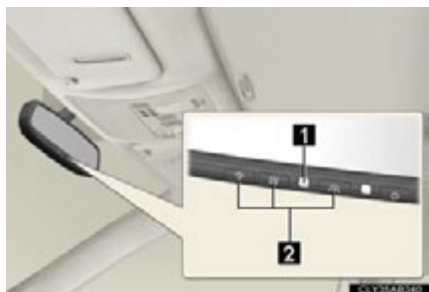

1 Indicator

2 Buttons

### Programming the HomeLink<sup>®</sup>



Point the remote control transmitter for the device 1 to 3 in. (25 to 75 mm) from the HomeLink<sup>®</sup> buttons.

Keep the HomeLink<sup>®</sup> indicator light in view while programming.



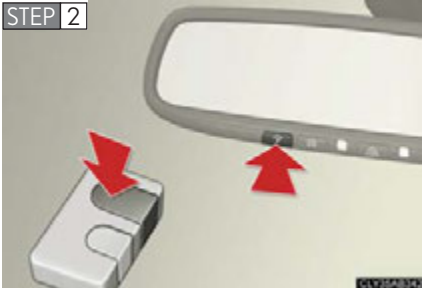

Press and hold one of the HomeLink<sup>®</sup> buttons and the transmitter button. When the HomeLink<sup>®</sup> indicator light changes from a slow to a rapid flash, you can release both buttons.

If the HomeLink<sup>®</sup> indicator light comes on but does not flash, or flashes rapidly for 2 seconds and remains lit, the HomeLink<sup>®</sup> button is already programmed. Use the other buttons or follow the “Reprogramming a HomeLink<sup>®</sup> button” instructions. (→P. 363)



Test the HomeLink<sup>®</sup> operation by pressing the newly programmed button.

If a HomeLink<sup>®</sup> button has been programmed for a garage door, check to see if the garage door opens and closes. If the garage door does not operate, see if your remote control transmitter is of the rolling code type. Press and hold the programmed HomeLink<sup>®</sup> button. The remote control transmitter is of the rolling code type if the HomeLink<sup>®</sup> indicator light flashes rapidly for 2 seconds and then remains lit. If your transmitter is of the rolling code type, proceed to the heading “Programming a rolling code system”.

**STEP 4** Repeat the steps above to program another device for each of the remaining HomeLink<sup>®</sup> buttons.

### ■ Programming a Rolling Code system (for U.S.A. owners)

If your device is Rolling Code equipped, follow the steps under the heading “Programming the HomeLink<sup>®</sup>” before proceeding with the steps listed below.

**STEP 1** Locate the learn button on the ceiling mounted garage door opener motor. The exact location and color of the button may vary by brand of garage door opener motor.

Refer to the operation manual supplied with the garage door opener motor for the location of the learn button.

**STEP 2** Press the learn button.

Following this step, you have 30 seconds in which to initiate step 3 below.

**STEP 3** Press and hold the vehicle's programmed HomeLink<sup>®</sup> button for 2 seconds and release it. Repeat this step once again. The garage door may open.

If the garage door opens, the programming process is complete. If the door does not open, press and release the button a third time. This third press and release will complete the programming process by opening the garage door.

The ceiling mounted garage door opener motor should now recognize the HomeLink<sup>®</sup> signal and operate the garage door.

**STEP 4** Repeat the steps above to program another rolling code system for any of the remaining HomeLink<sup>®</sup> buttons.

### ■ Programming an entry gate (for U.S.A. owners)/Programming all devices in the Canadian market

**STEP 1** Place your transmitter 1 to 3 in. (25 to 75 mm) away from the surface of the HomeLink<sup>®</sup>.

Keep the HomeLink<sup>®</sup> indicator light in view while programming.

**STEP 2** Press and hold the selected HomeLink<sup>®</sup> button.

**STEP 3** Repeatedly press and release (cycle) the device's remote control button for two seconds each until step 4 is complete.

**STEP 4** When the indicator light on the HomeLink<sup>®</sup> compatible transceiver start to flashing rapidly, release the buttons.

**STEP 5** Test the operation of the HomeLink<sup>®</sup> by pressing the newly programmed button. Check to see if the gate/device operates correctly.

**STEP 6** Repeat the steps above to program another device for each of the remaining HomeLink<sup>®</sup> buttons.

### ■ Programming other devices

To program other devices such as home security systems, home door locks or lighting, contact your authorized Lexus dealer for assistance.

### ■ Reprogramming a button

The individual HomeLink<sup>®</sup> buttons cannot be erased but can be reprogrammed. To reprogram a button, follow the “Reprogramming a HomeLink<sup>®</sup> button” instructions.

## Operating the HomeLink<sup>®</sup>

Press the appropriate HomeLink<sup>®</sup> button. The HomeLink<sup>®</sup> indicator light should come on.

The HomeLink<sup>®</sup> compatible transceiver in your vehicle continues to send a signal for up to 20 seconds as long as the button is pressed.

## Reprogramming a HomeLink<sup>®</sup> button

Press and hold the desired HomeLink<sup>®</sup> button. After 20 seconds, the HomeLink<sup>®</sup> indicator light will start flashing slowly. Next, while still pressing and holding the HomeLink<sup>®</sup> button, press and hold the button on the transmitter until the HomeLink<sup>®</sup> indicator light changes from a slow to a rapid flash.

### Erasing the entire HomeLink® memory (all three programs)



Press and hold the 2 outside buttons for 10 seconds until the indicator light flashes.

If you sell your vehicle, be sure to erase the programs stored in the HomeLink® memory.

#### ■ Before programming

- Install a new battery in the remote control transmitter.
- The battery side of the remote control transmitter must be pointed away from the HomeLink® button.

#### ■ Certification for the garage door opener

► For vehicles sold in the U.S.A.

FCC ID: NZLWZLHL4

FCC ID: NZLOBIHL4

#### NOTE:

This device complies with Part 15 of the FCC Rules. Operation is subject to the following two conditions: (1) this device may not cause harmful interference, and (2) this device must accept any interference received, including interference that may cause undesired operation.

#### FCC WARNING:

Changes or modifications not expressly approved by the party responsible for compliance could void the user's authority to operate the equipment.

► For vehicles sold in Canada

**NOTE:**

Operation is subject to the following two conditions: (1) this device may not cause interference, and (2) this device must accept any interference, including interference that may cause undesired operation of the device.

**NOTE:**

L'utilisation de ce dispositif est autorisée seulement aux deux conditions suivantes: (1) il ne doit pas produire de brouillage, et (2) l'utilisateur du dispositif doit être prêt à accepter tout brouillage radioélectrique reçu, même si ce brouillage est susceptible de compromettre le fonctionnement du dispositif.

■ **When support is necessary**

Visit on the web at [www.homelink.com](http://www.homelink.com) or call 1-800-355-3515.

 **CAUTION**

■ **When programming a garage door or other remote control device**

The garage door or other devices may operate, so ensure people and objects are out of danger to prevent potential harm.

■ **Conforming to federal safety standards**

Do not use the HomeLink<sup>®</sup> Compatible Transceiver with any garage door opener or device that lacks safety stop and reverse features as required by federal safety standards.

This includes any garage door that cannot detect an interfering object. A door or device without these features increases the risk of death or serious injury.

### 3-7. Other interior features

## Compass\*

The compass on the inside rear view mirror indicates the direction in which the vehicle is heading.

#### ■ Operation



To turn the compass on or off, press the switch.

#### ■ Displays and directions

Display	Direction
"N"	North
"NE"	Northeast
"E"	East
"SE"	Southeast
"S"	South
"SW"	Southwest
"W"	West
"NW"	Northwest

\*: If equipped

## Calibrating the compass

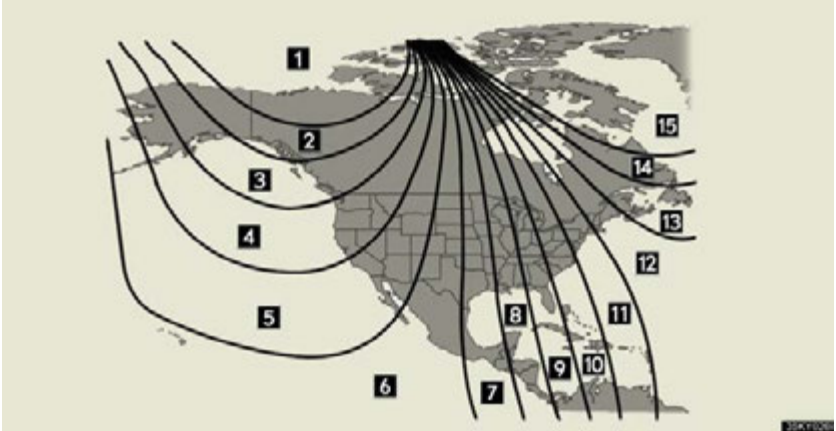

The direction display deviates from the true direction determined by the earth's magnetic field. The amount of deviation varies according to the geographic position of the vehicle.

If you cross over a map boundary shown in illustration, the compass will deviate.

To obtain higher precision or perfect calibration, refer to the following.

### ■ Deviation calibration

**STEP 1** Stop the vehicle.

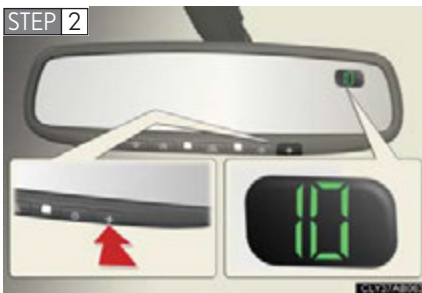

**STEP 2** Press the switch until a number (1 to 15) appears on the compass display.

**STEP 3** Press the switch, and referring to the map above, select the number of the zone where you are.

If the direction is displayed several seconds after adjustment, the calibration is complete.

### ■ Circling calibration

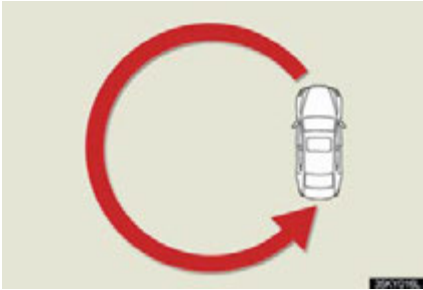

When “C” appears on the display, drive the vehicle at 5 mph (8 km/h) or less in a circle until a direction is displayed.

If there is not enough space to drive in a circle, drive around the block until the direction is displayed.

---

### ■ Conditions unfavorable to correct operation

The compass may not show the correct direction in the following conditions:

- The vehicle is stopped immediately after turning.
- The vehicle is on an inclined surface.
- The vehicle is in a place where the earth’s magnetic field is subject to interference by artificial magnetic fields (underground car park/parking lot, under a steel tower, between buildings, roof car park/parking lot, near an intersection, near a large vehicle, etc.).
- The vehicle has become magnetized.  
(There is a magnet or metal object near the inside rear view mirror.)
- The battery has been disconnected.
- A door is open.



 **CAUTION****■ While driving the vehicle**

Do not adjust the display. Be sure to adjust the display only when the vehicle is stopped.

**■ When doing the circling calibration**

Be sure to secure a wide space, and watch out for people and vehicles in the neighborhood. Do not violate any local traffic rules while performing circling calibration.

 **NOTICE****■ To avoid compass malfunctions**

Do not place magnets or any metal objects near the inside rear view mirror. Doing this may cause a malfunction of the compass sensor.

**■ To ensure normal operation of the compass**

- Do not perform circling calibration of the compass in a place where the earth's magnetic field is subject to interference by artificial magnetic fields.
- During calibration, do not operate electric systems (moon roof, power windows, etc.) as they may interfere with the calibration.

### 3-7. Other interior features

## Safety Connect\*

Safety Connect is a subscription-based telematics service that uses Global Positioning System (GPS) data and embedded cellular technology to provide safety and security features to subscribers. Safety Connect is supported by Lexus' designated response center, which operates 24 hours per day, 7 days per week.

Safety Connect service is available by subscription on select, telematics hardware-equipped vehicles.

By using the Safety Connect service, you are agreeing to be bound by the Telematics Subscription Service Agreement and its Terms and Conditions, as in effect and amended from time to time, a current copy of which is available at [Lexus.com](http://Lexus.com). All use of the Safety Connect service is subject to such then-applicable Terms and Conditions.

#### ■ System components



- 1 Microphone
- 2 LED light indicators
- 3 "SOS" button

## ■ Services

Subscribers have the following Safety Connect services available:

- Automatic Collision Notification\*

Helps drivers receive necessary response from emergency service providers. (→P. 373)

\*: U.S. Patent No. 7,508,298 B2

- Stolen Vehicle Location

Helps drivers in the event of vehicle theft. (→P. 374)

- Emergency Assistance Button (SOS)

Connects drivers to response-center support. (→P. 374)

- Enhanced Roadside Assistance

Provides drivers various on-road assistance. (→P. 374)

## ■ Subscription

After you have signed the Telematics Subscription Service Agreement and are enrolled, you can begin receiving services.

A variety of subscription terms is available for purchase. Contact your Lexus dealer, call 1-800-25-LEXUS (1-800-255-3987) or push the “SOS” button in your vehicle for further subscription details.

### ■ Safety Connect Services Information

- Phone calls using the vehicles Bluetooth® technology will not be possible during Safety Connect.
- Safety Connect is available beginning Fall 2009 on select Lexus models. Contact with the Safety Connect response center is dependent upon the telematics device being in operative condition, cellular connection availability, and GPS satellite signal reception, which can limit the ability to reach the response center or receive emergency service support. Enrollment and Telematics Subscription Service Agreement required. A variety of subscription terms is available; charges vary by subscription term selected.
- Automatic Collision Notification, Emergency Assistance and Stolen Vehicle Location will function in the United States, including Hawaii and Alaska, and in Canada, and Enhanced Roadside Assistance will function in the United States (except Hawaii) and in Canada. No Safety Connect services will function outside of the United States in countries other than Canada.
- Safety Connect services are not subject to section 255 of the Telecommunications Act and the device is not TTY compatible.

### ■ Languages

The Safety Connect response center will offer support in multiple languages. The Safety Connect system will offer voice prompts in English and Spanish. Please indicate your language of choice when enrolling.

### ■ When contacting the response center

You may be unable to contact the response center if the network is busy.

## Safety Connect LED light Indicators

When the “ENGINE START STOP” switch is turned to IGNITION ON mode, the red indicator light comes on for 2 seconds then turns off. Afterward, the green indicator light comes on, indicating that the service is active.

The following indicator light patterns indicate specific system usage conditions:

- Green indicator light on = Active service
- Green indicator light flashing = Safety Connect call in process
- Red indicator light (except at vehicle start-up) = System malfunction (contact your Lexus dealer)
- No indicator light (off) = Safety Connect service not active

## Safety Connect services

### ■ Automatic Collision Notification

In case of either airbag deployment or severe rear-end collision, the system is designed to automatically call the response center. The responding agent receives the vehicle’s location and attempts to speak with the vehicle occupants to assess the level of emergency. If the occupants are unable to communicate, the agent automatically treats the call as an emergency, contacts the nearest emergency services provider to describe the situation, and requests that assistance be sent to the location.

### ■ Stolen Vehicle Location

If your vehicle is stolen, Safety Connect can work with local authorities to assist them in locating and recovering the vehicle. After filing a police report, call the Safety Connect response center at 1-800-25-LEXUS (1-800-255-3987) and follow the prompts for Safety Connect to initiate this service.

In addition to assisting law enforcement with recovery of a stolen vehicle, Safety-Connect-equipped vehicle location data may, under certain circumstances, be shared with third parties to locate your vehicle. Further information is available at [Lexus.com](http://Lexus.com).

### ■ Emergency Assistance Button (“SOS”)

In the event of an emergency on the road, push the “SOS” button to reach the Safety Connect response center. The answering agent will determine your vehicle’s location, assess the emergency, and dispatch the necessary assistance required.

If you accidentally press the “SOS” button, tell the response-center agent that you are not experiencing an emergency.

### ■ Enhanced Roadside Assistance

Enhanced Roadside Assistance adds GPS data to the already included warranty-based Lexus road side service.

Subscribers can press the “SOS” button to reach a Safety Connect response-center agent, who can help with a wide range of needs, such as: towing, flat tire, fuel delivery, etc. For a description of the Enhanced Roadside Assistance services and their limitations, please see the Safety Connect Terms and Conditions, which are available at [Lexus.com](http://Lexus.com).

## Safety information for Safety Connect

Important! Read this information before using Safety Connect.

### ■ Exposure to radio frequency signals

The Safety Connect system installed in your vehicle is a low-power radio transmitter and receiver. It receives and also sends out radio frequency (RF) signals.

In August 1996, the Federal Communications Commission (FCC) adopted RF exposure guidelines with safety levels for mobile wireless phones. Those guidelines are consistent with the safety standards previously set by the following U.S. and international standards bodies.

- ANSI (American National Standards Institute) C95.1 [1992]
- NCRP (National Council on Radiation Protection and Measurement) Report 86 [1986]
- ICNIRP (International Commission on Non-Ionizing Radiation Protection) [1996]

Those standards were based on comprehensive and periodic evaluations of the relevant scientific literature. Over 120 scientists, engineers, and physicians from universities, and government health agencies and industries reviewed the available body of research to develop the ANSI Standard (C95.1).

The design of Safety Connect complies with the FCC guidelines in addition to those standards.

■ **License**

Licensed by QUALCOMM Incorporated under one or more of the following United States Patents and/or their counterparts in other nations:

4,901,307 5,490,165 5,056,109 5,504,773 5,101,501  
5,506,865 5,109,390 5,511,073 5,228,054 5,535,239  
5,267,261 5,544,196 5,267,262 5,568,483 5,337,338  
5,600,754 5,414,796 5,657,420 5,416,797 5,659,569  
5,710,784 5,778,338

■ **Certification for Lexus Enform with Safety Connect**

FCC ID: O9EGTM1

FCC ID: O6Y-CDMRF101

NOTE:

This device complies with Part 15 of the FCC Rules. Operation is subject to the following two conditions: (1) this device may not cause harmful interference, and (2) this device must accept any interference received, including interference that may cause undesired operation.

FCC WARNING:

Changes or modifications not expressly approved by the party responsible for compliance could void the user's authority to operate the equipment.



**4-1. Maintenance and care**

Cleaning and protecting  
the vehicle exterior..... 378

Cleaning and protecting  
the vehicle interior..... 382

**4-2. Maintenance**

Maintenance  
requirements..... 385

General maintenance..... 387

Emission inspection and  
maintenance (I/M)  
programs..... 390

**4-3. Do-it-yourself  
maintenance**

Do-it-yourself service  
precautions..... 391

Hood..... 394

Positioning a floor jack..... 395

Engine compartment..... 397

Tires..... 412

Tire inflation pressure..... 424

Wheels..... 428

Air conditioning filter..... 430

Electronic key battery..... 433

Checking and replacing  
fuses..... 435

Headlight aim..... 449

Light bulbs..... 451

# Cleaning and protecting the vehicle exterior

Perform the following to protect the vehicle and maintain it in prime condition.

- Working from top to bottom, liberally apply water to the vehicle body, wheel wells and underside of the vehicle to remove any dirt and dust.
- Wash the vehicle body using a sponge or soft cloth, such as a chamois.
- For hard-to-remove marks, use car wash soap and rinse thoroughly with water.
- Wipe away any water.
- Wax the vehicle when the waterproof coating deteriorates.

If water does not bead on a clean surface, apply wax when the vehicle body is cool.

---

### ■ Automatic car washes

- Fold the mirrors back before washing the vehicle.
- Brushes used in automatic car washes may scratch the vehicle surface and harm your vehicle's paint.

### ■ High pressure car washes

- Do not allow the nozzles of the car wash to come within close proximity of the windows.
- Before car wash, check that the fuel filler door on your vehicle is closed properly.

**■ Aluminum wheels**

- Remove any dirt immediately by using a neutral detergent. Do not use hard brushes or abrasive cleaners. Do not use strong or harsh chemical cleaners. Use the same mild detergent and wax as used on the paint.
- Do not use detergent on the wheels when they are hot, for example after driving for long distance in the hot weather.
- Wash detergent from the wheels immediately after use.

**■ Bumpers**

Do not scrub with abrasive cleaners.

**■ Outside rear view mirror rain-clearing coating (if equipped)**

Observe the following precautions in order to retain the rain-clearing properties of the mirror.

- Clean the mirrors using car shampoo or glass cleaner that does not contain silicone or an abrasive compound, and rinse thoroughly with water.
- Allow the mirrors to be exposed to direct sunlight for 1 to 2 days.

**! CAUTION**

**■ When cleaning the windshield (vehicles with rain-sensing windshield wipers)**



Set the wiper switch to off.

If the wiper switch is in "AUTO", the wipers may operate unexpectedly in the following situations, and may result in hands being caught or other serious injuries and cause damage to the wiper blades.

- When the upper part of the windshield where the raindrop sensor is located is touched by hand
- When a wet rag or similar is held close to the raindrop sensor
- If something bumps against the windshield
- If you directly touch the raindrop sensor body or if something bumps into the raindrop sensor

**■ Caution about the exhaust pipe**

Exhaust gasses cause the exhaust pipe to become quite hot.

When washing the vehicle, be careful not to touch the pipe until it has cooled sufficiently, as touching a hot exhaust pipe can cause burns.

 NOTICE**■ To prevent paint deterioration and corrosion on the body and components (aluminum wheels etc.)****● Wash the vehicle immediately in the following cases:**

- After driving near the sea coast
- After driving on salted roads
- If you see coal tar or tree sap on the paint surface
- If you see dead insects, insect droppings or bird droppings on the paint
- After driving in an area contaminated with soot, oily smoke, mine dust, iron powder or chemical substances
- If the vehicle becomes heavily soiled in dust or mud
- If liquids such as benzene and gasoline are spilled on the paint surface

**● If the paint is chipped or scratched, have it repaired immediately.****● To prevent the wheels from corroding, remove any dirt and store in a place with low humidity when storing the wheels.****■ Cleaning the exterior lights****● Wash carefully. Do not use organic substances or scrub with a hard brush. This may damage the surfaces of the lights.****● Do not apply wax on the surfaces of the lights. Wax may cause damage to the lenses.****■ To prevent damage to the windshield wiper arms**

When lifting the wiper arms away from the windshield, pull the driver side wiper arm upward first, and repeat for the passenger side. When returning the wipers to their original position, do so from the passenger side first.

**■ When using an automatic car wash (vehicles with rain-sensing windshield wipers only)**

Set the wiper switch to the off position.

If the wiper switch is in "AUTO", the wipers may operate and the wiper blades may be damaged.

# Cleaning and protecting the vehicle interior

The following procedures will help protect your vehicle's interior and keep it in top condition:

### ■ Protecting the vehicle interior

Remove dirt and dust using a vacuum cleaner. Wipe dirty surfaces with a cloth dampened with lukewarm water.

### ■ Cleaning the leather areas

- Remove dirt and dust using a vacuum cleaner.
- Wipe any excess dirt and dust with a soft cloth dampened with diluted detergent.

Use a diluted water solution of approximately 5% neutral wool detergent.

- Wring out any excess water from the cloth and thoroughly wipe off all remaining traces of detergent.
- Wipe the surface with a dry, soft cloth to remove any remaining moisture. Allow the leather to dry in a shaded and ventilated area.

### ■ Synthetic leather areas

- Remove loose dirt using a vacuum cleaner.
- Apply a mild soap solution to the synthetic leather using a sponge or soft cloth.
- Allow the solution to soak in for a few minutes. Remove the dirt and wipe off the solution with a clean, damp cloth.

### ■ Caring for leather areas

Lexus recommends cleaning the interior of the vehicle at least twice a year to maintain the quality of the vehicle's interior.

### ■ Shampooing the carpets

There are several commercial foaming-type cleaners available. Use a sponge or brush to apply the foam. Rub in overlapping circles. Do not apply water. Excellent results are obtained by keeping the carpet as dry as possible.

### ■ Seat belts

Clean with mild soap and lukewarm water using a cloth or sponge. Also check the belts periodically for excessive wear, fraying or cuts.

## CAUTION

### ■ Water in the vehicle

- Do not splash or spill liquid in the vehicle.

Doing so may cause electrical components etc. to malfunction or catch fire.

- Do not get any of the SRS components or wiring in the vehicle interior wet. (→P. 98)

Electrical malfunction may cause the airbags to deploy or not function properly, resulting in death or severe injury.

### ■ Cleaning the interior (especially instrument panel)

Do not use polish wax or polish cleaner. The instrument panel may reflect off the windshield, obstructing the driver's view and leading to an accident, resulting in death or serious injury.

### NOTICE

#### ■ **Cleaning detergents**

- Do not use organic substances such as benzene or gasoline, acidic or alkaline solutions, dye, bleach or other detergent. Doing so may discolor the vehicle interior or cause streaks or damage to painted surfaces.
- Do not use polish wax or polish cleaner. The instrument panel's or other interior part's painted surface may be damaged.

#### ■ **Preventing damage to leather surfaces**

Observe the following precautions to avoid damage to and deterioration of leather surfaces.

- Remove any dust or dirt on leather surfaces immediately.
- Do not expose the vehicle to direct sunlight for extended periods of time. Park the vehicle in the shade, especially during summer.
- Do not place items made of vinyl, plastic, or that contain wax on the upholstery, as they may stick to the leather surface if the vehicle interior heats up significantly.

#### ■ **Water on the floor**

Do not wash the vehicle floor with water.

Vehicle systems such as the audio system may be damaged if water comes into contact with electrical components under the floor of the vehicle, and may also cause the body to rust.

#### ■ **Cleaning the inside of the rear window**

- Be careful not to scratch or damage the heater wires or antenna.
- Do not use glass cleaner to clean the rear window, as this may cause damage to the rear window defogger heater wires or antenna. Use a cloth dampened with lukewarm water to gently wipe the window clean. Wipe the window in strokes running parallel to the heater wires or antenna.



# Maintenance requirements

To ensure safe and economical driving, day-to-day care and regular maintenance is essential. It is the owner's responsibility to perform regular checks. Lexus recommends the following maintenance.

### ■ General maintenance

Should be performed on a daily basis. This can be done by yourself or by a Lexus dealer.

### ■ Scheduled maintenance

Should be performed at specified intervals according to the maintenance schedule.

For details about maintenance items and schedules, refer to the "Warranty and Services Guide/Owner's Manual Supplement/Scheduled Maintenance".

### ■ Do-it-yourself maintenance

You can perform some maintenance procedures yourself. Please be aware that do-it-yourself maintenance may affect warranty coverage.

The use of Lexus Repair Manuals is recommended.

For details about warranty coverage, see the separate "Owner's Guide", "Warranty and Services Guide", "Owner's Manual Supplement" or "Warranty Booklet".

---

### ■ Repair and replacement

It is recommended that genuine Lexus parts be used for repair to ensure performance of each system. If non-Lexus parts are used in replacement or if a repair shop other than a Lexus dealer performs repairs, confirm the warranty coverage.

### ■ Reset the maintenance data (U.S.A. only)

After the required maintenance is performed according to the maintenance schedule, please reset the maintenance data.

To reset the data, follow the procedures described below:

**STEP 1** Switch the display to the odometer (→P. 158) when the engine is running.

**STEP 2** Turn the “ENGINE START STOP” switch OFF.

**STEP 3** While pressing the trip meter reset button, set the “ENGINE START STOP” switch to IGNITION ON mode (but do not start the engine because otherwise the reset mode will be cancelled). Continue to press and hold the button until the trip meter displays “000000”.

### ■ Allow inspection and repairs to be performed by a Lexus dealer

- Lexus technicians are well-trained specialists and are kept up to date with the latest service information. They are well informed about the operations of all systems on your vehicle.
- Keep a copy of the repair order. It proves that the maintenance that has been performed is under warranty coverage. If any problem should arise while your vehicle is under warranty, your Lexus dealer will promptly take care of it.

### CAUTION

#### ■ If your vehicle is not properly maintained

It could result in serious damage to the vehicle and possible serious injury or death.

#### ■ Warning in handling of battery

- Engine exhaust, some of its constituents, and a wide variety of automobile components contain or emit chemicals known to the State of California to cause cancer and birth defects and other reproductive harm. Work in a well ventilated area.
- Oils, fuels and fluids contained in vehicles as well as waste produced by component wear contain or emit chemicals known to the State of California to cause cancer and birth defects or other reproductive harm. Avoid exposure and wash any affected area immediately.
- Battery posts, terminals and related accessories contain lead and lead compounds which are known to cause brain damage. Wash your hands after handling. (→P. 408)

## 4-2. Maintenance

### General maintenance

Listed below are the general maintenance items that should be performed at the intervals specified in the “Warranty and Services Guide” or “Owners Manual Supplement”. It is recommended that any problem you notice should be brought to the attention of your Lexus dealer or qualified service shop for advice.

#### Engine compartment

Items	Check points
Battery	Maintenance-free. (→P. 408)
Brake fluid	At the correct level? (→P. 406)
Engine coolant	At the correct level? (→P. 404)
Engine oil	At the correct level? (→P. 401)
Exhaust system	No fumes or strange sounds?
Radiator/condenser/hoses	Not blocked with foreign matter? (→P. 406)
Washer fluid	At the correct level? (→P. 411)

## Vehicle interior

Items	Check points
Accelerator pedal	<ul style="list-style-type: none"> <li>• Moves smoothly (without uneven pedal effort or catching)?</li> </ul>
Automatic transmission “Park” mechanism	<ul style="list-style-type: none"> <li>• Can the vehicle be held securely on an incline with the shift lever in P?</li> </ul>
Brake pedal	<ul style="list-style-type: none"> <li>• Moves smoothly?</li> <li>• Does it have appropriate clearance and correct amount of free play?</li> </ul>
Clutch pedal	<ul style="list-style-type: none"> <li>• Moves smoothly?</li> </ul>
Brakes	<ul style="list-style-type: none"> <li>• Not pull to one side when applied?</li> <li>• Loss of brake effectiveness?</li> <li>• Spongy feeling brake pedal?</li> <li>• Pedal almost touches floor?</li> </ul>
Head restraints	<ul style="list-style-type: none"> <li>• Move smoothly and lock securely?</li> </ul>
Indicators/buzzers	<ul style="list-style-type: none"> <li>• Function properly?</li> </ul>
Lights	<ul style="list-style-type: none"> <li>• Do all the lights come on?</li> <li>• Headlights aimed correctly? (→P. 449)</li> </ul>
Parking brake	<ul style="list-style-type: none"> <li>• Moves smoothly?</li> <li>• Can hold the vehicle securely on an incline?</li> </ul>
Seat belts	<ul style="list-style-type: none"> <li>• Does the seat belt system operate smoothly?</li> <li>• Are the belts undamaged?</li> </ul>
Seats	<ul style="list-style-type: none"> <li>• Do the seat controls operate properly?</li> </ul>

Items	Check points
Steering wheel	<ul style="list-style-type: none"> <li>• Moves smoothly?</li> <li>• Has correct free play?</li> <li>• No strange noises?</li> </ul>

### Vehicle exterior

Items	Check points
Door/trunk	<ul style="list-style-type: none"> <li>• Operates smoothly?</li> </ul>
Engine hood	<ul style="list-style-type: none"> <li>• The lock system works properly?</li> </ul>
Fluid leaks	<ul style="list-style-type: none"> <li>• Is there any leakage after parking?</li> </ul>
Tire	<ul style="list-style-type: none"> <li>• Inflation pressure is correct?</li> <li>• Tire surfaces not worn or damaged?</li> <li>• Tires rotated according to the maintenance schedule?</li> <li>• Wheel nuts are not loose?</li> </ul>

### CAUTION

#### ■ If the engine is running

Turn the engine off and ensure that there is adequate ventilation before performing maintenance checks.

### Emission inspection and maintenance (I/M) programs

Some states have vehicle emission inspection programs which include OBD (On Board Diagnostics) checks. The OBD system monitors the operation of the emission control system.

#### ■ If the malfunction indicator lamp comes on

The OBD system determines that a problem exists somewhere in the emission control system. Your vehicle may not pass the I/M test and may need to be repaired. Contact your Lexus dealer to service the vehicle.

#### ■ Your vehicle may not pass the I/M test:

- When the battery is disconnected or discharged

Readiness codes that are set during ordinary driving are erased. Also, depending on your driving habits, the readiness codes may not be completely set.

- When the fuel tank cap is loose

The malfunction indicator lamp comes on as a temporary malfunction and your vehicle may not pass the I/M test.

#### ■ When the malfunction indicator lamp goes off after several driving trips

The error code in the OBD system will not be cleared unless the vehicle is driven 40 or more times.

#### ■ If your vehicle does not pass the I/M test

Contact your Lexus dealer to prepare the vehicle for re-testing.

### 4-3. Do-it-yourself maintenance

## Do-it-yourself service precautions

If you perform maintenance yourself, be sure to follow the correct procedure given in these sections.

Items	Parts and tools
Battery condition (→P. 408)	<ul style="list-style-type: none"><li>• Warm water</li><li>• Baking soda</li><li>• Grease</li><li>• Conventional wrench (for terminal clamp bolts)</li></ul>
Brake fluid level (→P. 406)	<ul style="list-style-type: none"><li>• FMVSS No.116 DOT 3 or SAE J1703 brake fluid</li><li>• Rag or paper towel</li><li>• Funnel (used only for adding brake fluid)</li></ul>
Engine coolant level (→P. 404)	<ul style="list-style-type: none"><li>• “Toyota Super Long Life Coolant” or similar high-quality ethylene glycol-based non-silicate, non-amine, non-nitrite and non-borate coolant with long-life hybrid organic acid technology. For the U.S.A.: “Toyota Super Long Life Coolant” is pre-mixed with 50% coolant and 50% deionized water. For Canada: “Toyota Super Long Life Coolant” is pre-mixed with 55% coolant and 45% deionized water.</li><li>• Funnel (used only for adding engine coolant)</li></ul>

Items	Parts and tools
Engine oil level (→P. 401)	<ul style="list-style-type: none"> <li>• “Toyota Genuine Motor Oil” or equivalent</li> <li>• Rag or paper towel, funnel (used only for adding engine oil)</li> </ul>
Fuses (→P. 435)	<ul style="list-style-type: none"> <li>• Fuse with same amperage rating as original</li> </ul>
Tire inflation pressure (→P. 424)	<ul style="list-style-type: none"> <li>• Tire pressure gauge</li> <li>• Compressed air source</li> </ul>
Headlight aim (→P. 449)	<ul style="list-style-type: none"> <li>• Phillips-head screwdriver</li> </ul>
Radiator and condenser (→P. 406)	—
Washer fluid (→P. 411)	<ul style="list-style-type: none"> <li>• Water washer fluid containing anti-freeze (for winter use)</li> <li>• Funnel</li> </ul>



 CAUTION

The engine compartment contains many mechanisms and fluids that may move suddenly, become hot, or become electrically energized. To avoid death or serious injury, observe the following precautions.

■ **When working on the engine compartment**

- Keep hands, clothing, and tools away from the moving fan and engine drive belt.
- Be careful not to touch the engine, radiator, exhaust manifold, etc. right after driving as they may be hot. Oil and other fluids may also be hot.
- Do not leave anything that may burn easily, such as paper or rags, in the engine compartment.
- Do not smoke, cause sparks or expose an open flame to fuel or the battery. Fuel and battery fumes are flammable.
- Be extremely cautious when working on the battery. It contains poisonous and corrosive sulfuric acid.

■ **When working near the electric cooling fan or radiator grille**

Be sure the “ENGINE START STOP” switch is OFF.

With the “ENGINE START STOP” switch in IGNITION ON mode, the electric cooling fan may automatically start to run if the air conditioning is on and/or the coolant temperature is high. (→P. 406)

■ **Safety glasses**

Wear safety glasses to prevent flying or falling material, fluid spray, etc. from getting in the eyes.

 NOTICE

■ **If you remove the air cleaner filter**

Driving with the air cleaner filter removed may cause excessive engine wear due to dirt in the air. Also, a backfire could cause a fire in the engine compartment.

## 4-3. Do-it-yourself maintenance

### Hood

Release the lock from the inside of the vehicle to open the hood.

STEP 1



Pull the hood release lever.

The hood will pop up slightly.

STEP 2



Lift the auxiliary catch lever and lift the hood.

#### CAUTION

##### ■ Pre-driving check

Check that the hood is fully closed and locked.

If the hood is not locked properly it may open while the vehicle is in motion and cause an accident, which may result in death or serious injury.

## 4-3. Do-it-yourself maintenance

### Positioning a floor jack

When raising your vehicle with a floor jack, position the jack correctly. Improper placement may damage your vehicle or cause injury.

#### ■ Front

##### ▶ 2WD

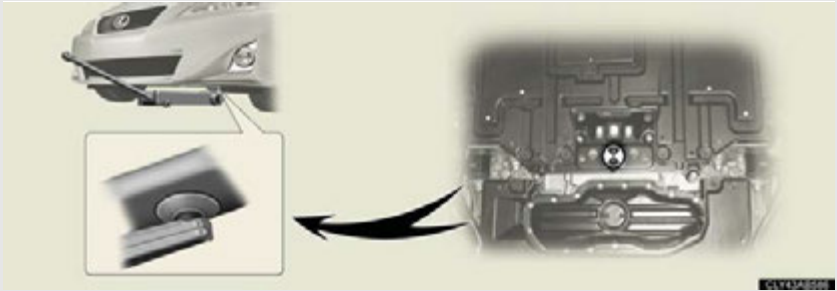

##### ▶ AWD



#### ■ Rear



**⚠ CAUTION**

**■ When raising your vehicle**

Make sure to observe the following to reduce the possibility of death or serious injury.



● Lift up the vehicle using a floor jack such as the one shown in the illustration.

- When using a floor jack, follow the instructions of the manual provided with the jack.
- Do not use the jack that was supplied with your vehicle.
- Do not put any part of your body or get underneath the vehicle supported only by the floor jack.
- Always use floor jack and/or automotive jack stands on a solid, flat, level surface.
- Do not start the engine while the vehicle is supported by the floor jack.
- Stop the vehicle on level firm ground, firmly set the parking brake and put the shift lever in P (automatic) or R (manual).
- Make sure to set the floor jack properly at the jack point.  
Raising the vehicle with an improperly positioned floor jack will damage the vehicle and may cause the vehicle to fall off the floor jack.
- Do not raise the vehicle while someone is in the vehicle.
- When raising the vehicle, do not place any objects on top of or underneath the floor jack.

## 4-3. Do-it-yourself maintenance

### Engine compartment

#### ► IS350



- |                                    |           |                                    |           |
|------------------------------------|-----------|------------------------------------|-----------|
| <b>1</b> Battery                   | (→P. 408) | <b>6</b> Washer fluid tank         | (→P. 411) |
| <b>2</b> Engine oil level dipstick | (→P. 401) | <b>7</b> Electric cooling fans     |           |
| <b>3</b> Engine oil filler cap     | (→P. 401) | <b>8</b> Condenser                 | (→P. 406) |
| <b>4</b> Brake fluid reservoir     | (→P. 406) | <b>9</b> Radiator                  | (→P. 406) |
| <b>5</b> Fuse boxes                | (→P. 435) | <b>10</b> Engine coolant reservoir | (→P. 404) |

► IS250

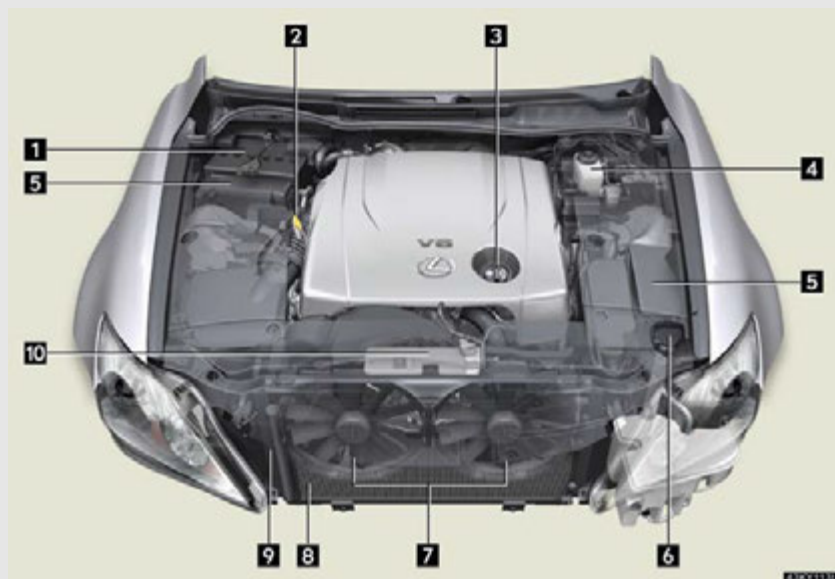

- |                                    |           |                                    |           |
|------------------------------------|-----------|------------------------------------|-----------|
| <b>1</b> Battery                   | (→P. 408) | <b>6</b> Washer fluid tank         | (→P. 411) |
| <b>2</b> Engine oil level dipstick | (→P. 401) | <b>7</b> Electric cooling fans     |           |
| <b>3</b> Engine oil filler cap     | (→P. 401) | <b>8</b> Condenser                 | (→P. 406) |
| <b>4</b> Brake fluid reservoir     | (→P. 406) | <b>9</b> Radiator                  | (→P. 406) |
| <b>5</b> Fuse boxes                | (→P. 435) | <b>10</b> Engine coolant reservoir | (→P. 404) |

## Engine compartment cover

### ■ Removing the engine compartment cover

#### ▶ Front

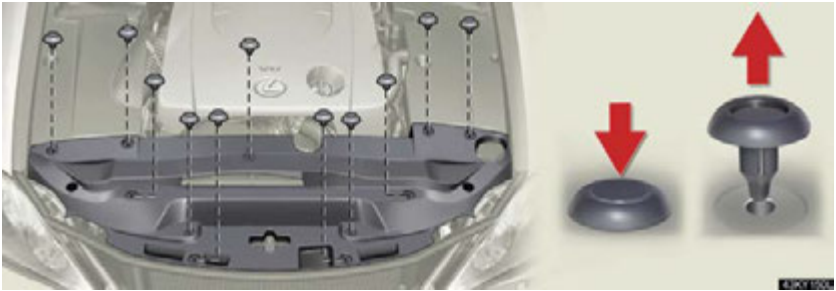

#### ▶ Outside



### ■ Installing the clips

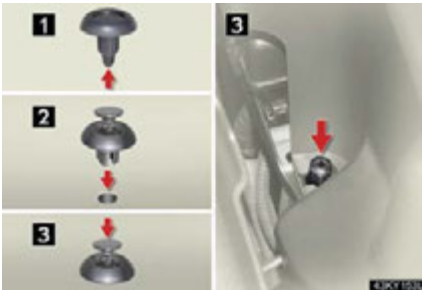

**1** Press the tip of the clip against a hard surface, such as a desk, to allow the center part of the clip to be pushed up.

**2** Insert

**3** Press

#### NOTICE

#### ■ After installing an engine compartment cover

Make sure that the cover is securely installed in its original position.



## Engine oil

With the engine at operating temperature and turned off, check the oil level on the dipstick.

### ■ Checking the engine oil

**STEP 1** Park the vehicle on level ground. After warming up the engine and turning it off, wait more than five minutes for the oil to drain back into the bottom of the engine.

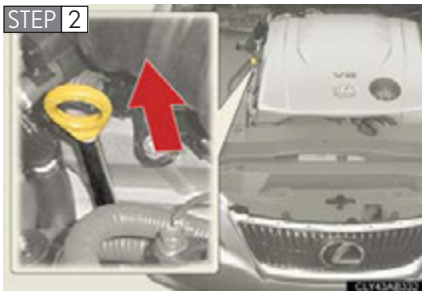

Hold a rag under the end and pull the dipstick out.

**STEP 3** Wipe the dipstick clean.

**STEP 4** Reinsert the dipstick fully.

**STEP 5** Holding a rag under the end, pull the dipstick out and check the oil level.

**STEP 6** Wipe the dipstick and reinsert it fully.

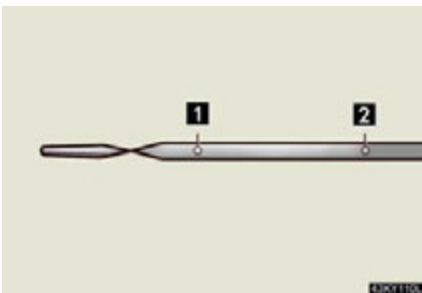

**1** Low

**2** Full

### ■ Adding engine oil



If the oil level is below or near the low level mark, add engine oil of the same type as already in the engine.

Make sure to check the oil type and prepare the items needed before adding oil.

Engine oil selection	→P. 524
Oil quantity (Low → Full)	1.6 qt. (1.5 L, 1.3 Imp. qt.)
Items	Clean funnel

**STEP 1** Remove the oil filler cap by turning it counterclockwise.

**STEP 2** Add engine oil slowly, checking the dipstick.

**STEP 3** Install the oil filler cap by turning it clockwise.

### ■ Engine oil consumption

- The amount of engine oil consumed depends on the oil viscosity, the quality of the oil and the way the vehicle is driven.
- More oil is consumed under driving conditions such as high speeds and frequent acceleration and deceleration.
- A new engine consumes more oil.
- When judging the amount of oil consumption, keep in mind that the oil may have become diluted, making it difficult to judge the true level accurately.
- Oil consumption: Max. 1.1 qt./600 miles (0.9 Imp. qt./600 miles, 1.0 L/1000 km)
- If your vehicle consumes more than 1.1 qt. (1.0 L, 0.9 Imp. qt.) every 600 miles (1000 km), contact your Lexus dealer.

### CAUTION

#### ■ Used engine oil

- Used engine oil contains potentially harmful contaminants which may cause skin disorders such as inflammation or skin cancer, so care should be taken to avoid prolonged and repeated contact. To remove used engine oil from your skin, wash thoroughly with soap and water.
- Dispose of used oil and filters only in a safe and acceptable manner. Do not dispose of used oil and filters in household trash, in sewers or onto the ground. Call your Lexus dealer, service station or auto parts store for information concerning recycling or disposal.
- Do not leave used engine oil within the reach of children.

 NOTICE

■ **To prevent serious engine damage**

Check the oil level on a regular basis.

■ **When replacing the engine oil**

- Be careful not to spill engine oil on the vehicle components.
- Avoid overfilling, or the engine could be damaged.
- Check the oil level on the dipstick every time you refill the vehicle.
- Be sure the engine oil filler cap is properly tightened.

## Engine coolant

The coolant level is satisfactory if it is between the “FULL” and “LOW” lines on the reservoir when the engine is cold.

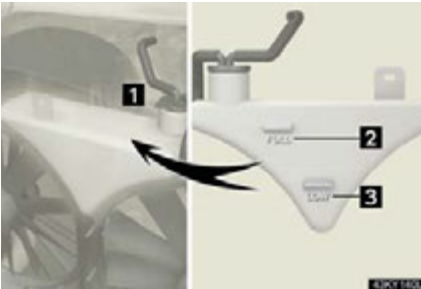

1 Reservoir cap

2 “FULL”

3 “LOW”

If the level is on or below the “LOW” line, add coolant up to the “FULL” line.

### ■ If the coolant level drops within a short time after replenishing

Visually check the radiator, hoses, engine coolant filler cap, radiator cap, drain cock and water pump.

If you cannot find a leak, have your Lexus dealer pressure test the cap and check for leaks in the cooling system.

### ■ Coolant selection

Only use “Toyota Super Long Life Coolant” or similar high-quality ethylene glycol-based non-silicate, non-amine, non-nitrite, and non-borate coolant with long-life hybrid organic acid technology.

U.S.A.: “Toyota Super Long Life Coolant” is a mixture of 50% coolant and 50% deionized water. (Enabled: -31°F [-35°C])

Canada: “Toyota Super Long Life Coolant” is a mixture of 55% coolant and 45% deionized water. (Enabled: -44°F [-42°C])

For more details about engine coolant, contact your Lexus dealer.

## CAUTION

### ■ When the engine is hot

Do not remove the radiator cap.

The cooling system may be under pressure and may spray hot coolant if the cap is removed, causing serious injuries, such as burns.

## NOTICE

### ■ When adding engine coolant

Coolant is neither plain water nor straight antifreeze. The correct mixture of water and antifreeze must be used to provide proper lubrication, corrosion protection and cooling. Be sure to read the antifreeze or coolant label.

### ■ If you spill coolant

Be sure to wash it off with water to prevent it damaging parts or paint.

### Radiator and condenser

Check the radiator and condenser and clear any foreign objects. If either of the above parts are extremely dirty or you are not sure of their condition, have your vehicle checked by your Lexus dealer.

#### CAUTION

##### When the engine is hot

Do not touch the radiator or condenser as they may be hot and cause serious injuries, such as burns.

### Brake fluid

#### Checking fluid level



The brake fluid level should be between the “MAX” and “MIN” lines on the tank.

Make sure to check the fluid type and prepare the necessary items.

#### Adding fluid

Fluid type	FMVSS No.116 DOT 3 or SAE J1703 brake fluid
Items	Clean funnel

#### Brake fluid can absorb moisture from the air

Excess moisture in the fluid can cause a dangerous loss of braking efficiency. Use only newly opened brake fluid.

 **CAUTION****■ When filling the reservoir**

Take care because brake fluid can harm your hands or eyes and damage painted surfaces.

If fluid gets in your eyes, flush your eyes with clean water immediately.

If you still experience discomfort, see a doctor.

 **NOTICE****■ If the fluid level is low or high**

It is normal for the brake fluid level to go down slightly as the brake pads wear or when the fluid level in the accumulator is high.

If the reservoir needs frequent refilling, it may indicate a serious problem.

## Battery

Check the battery as follows.

### Battery exterior

Make sure that the battery terminals are not corroded and that there are no loose connections, cracks, or loose clamps.

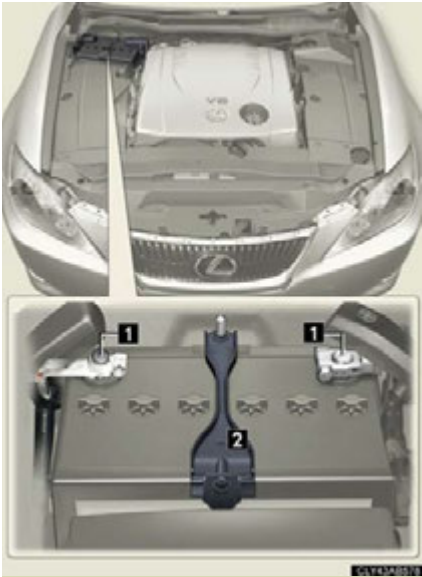

**1** Terminals

**2** Hold-down clamp

### Checking battery fluid

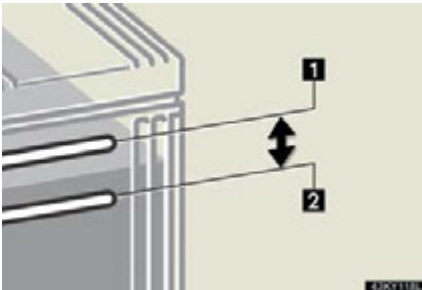

Check that the level is between “UPPER LEVEL” and “LOWER LEVEL”.

**1** “UPPER LEVEL”

**2** “LOWER LEVEL”

If the fluid level is at or below “LOWER LEVEL”, add distilled water.



## ■ Adding distilled water

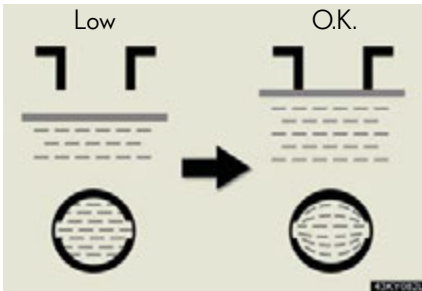

**STEP 1** Remove the vent plug.

**STEP 2** Add distilled water.

If the “UPPER LEVEL” line cannot be seen, check the fluid level by looking directly at the cell.

**STEP 3** Put the vent plug back on and close securely.

## ■ Before recharging

When recharging, the battery produces hydrogen gas which is flammable and explosive. Therefore, before recharging:

- If recharging with the battery installed on the vehicle, be sure to disconnect the ground cable.
- Make sure the power switch on the charger is off when connecting and disconnecting the charger cables to the battery.

## ■ After recharging/reconnecting the battery

In some cases, the engine may not start. Follow the procedure below to initialize the system.

**STEP 1** Shift the shift lever to “P” (automatic transmission) or depress the brake pedal with the shift lever in N (manual transmission), and turn the “ENGINE START STOP” switch OFF.

**STEP 2** Open and close any of the doors.

**STEP 3** Start the engine. (If the engine does not start first time, repeat the procedure.)

If the engine will not start even after multiple attempts at the above method, contact your Lexus dealer.

 **CAUTION**

■ **Chemicals in the battery**

A battery contains poisonous and corrosive sulfuric acid and may produce hydrogen gas which is flammable and explosive. To reduce the risk of death or serious injury, take the following precautions while working on or near the battery:

- Do not cause sparks by touching the battery terminals with tools.
- Do not smoke or light a match near the battery.
- Avoid contact with eyes, skin and clothes.
- Never inhale or swallow electrolyte.
- Wear protective safety glasses when working near the battery.
- Keep children away from the battery.

■ **Where to safely charge the battery**

Always charge the battery in an open area. Do not charge the battery in a garage or closed room where there is not sufficient ventilation.

■ **How to recharge the battery**

Only perform a slow charge (5 A or less). The battery may explode if charged at a quicker rate.

■ **Emergency measures regarding electrolyte**

- If electrolyte gets in your eyes  
Flush your eyes with clean water for at least 15 minutes and get immediate medical attention. If possible, continue to apply water with a sponge or cloth while traveling to the nearest medical facility.
- If electrolyte gets on your skin  
Wash the affected area thoroughly. If you feel pain or burning, get medical attention immediately.
- If electrolyte gets on your clothes  
It can soak through clothing on to your skin. Immediately take off the clothing and follow the procedure above if necessary.
- If you accidentally swallow electrolyte  
Drink a large quantity of water or milk. Get emergency medical attention immediately.

**⚠ NOTICE****■ When recharging the battery**

Never recharge the battery while the engine is running. Also, be sure all accessories are turned off.

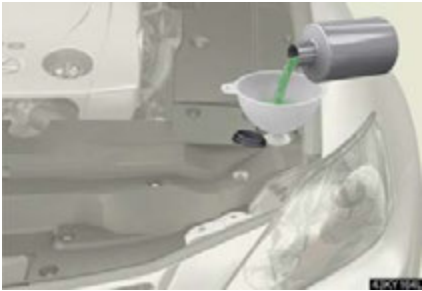
**Washer fluid**

If any washer does not work or the warning message appears on the multi-information display, the washer tank may be empty. Add washer fluid.

**⚠ CAUTION****■ When adding washer fluid**

Do not add washer fluid when the engine is hot or running, as washer fluid contains alcohol and may catch fire if spilled on the engine etc.

**⚠ NOTICE****■ Do not use any fluid other than washer fluid**

Do not use soapy water or engine antifreeze instead of washer fluid. Doing so may cause streaking on the vehicle's painted surfaces.

**■ Diluting washer fluid**

Dilute washer fluid with water as necessary. Refer to the freezing temperatures listed on the label of the washer fluid bottle.

## 4-3. Do-it-yourself maintenance

# Tires

Replace or rotate tires in accordance with maintenance schedules and treadwear.

### ■ Checking tires



- 1 New tread
- 2 Treadwear indicator
- 3 Worn tread

The location of treadwear indicators is shown by the “TWI” or “Δ” marks, etc., molded on the sidewall of each tire.

Check spare tire condition and pressure if not rotated.

### ■ Tire rotation

- ▶ 2WD models with 16-inch tires or AWD models

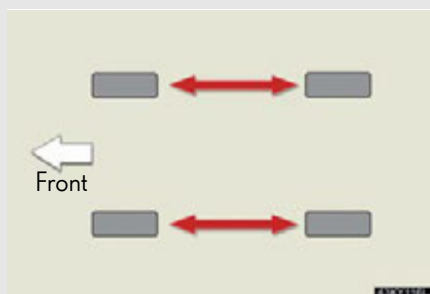

Rotate the tires in the order shown.

To equalize tire wear and extend tire life, Lexus recommends that tire rotation is carried out at the same interval as tire inspection.

Do not fail to initialize the tire pressure warning system after tire rotation.

- ▶ 2WD models with non-directional 17-inch tires or 18-inch tires

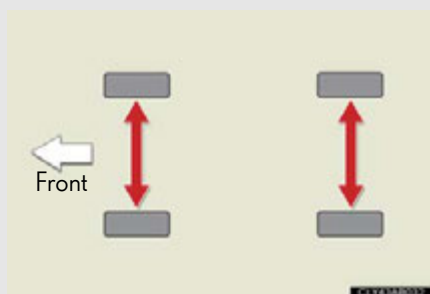

Rotate the tires in the order shown.

To equalize tire wear and extend tire life, Lexus recommends that tire rotation is carried out at the same interval as tire inspection.

- ▶ 2WD models with directional 17-inch tires or 18-inch tires  
Tires cannot be rotated.

### ■ The tire pressure warning system

Your Lexus is equipped with a tire pressure warning system that uses tire pressure warning valves and transmitters to detect low tire inflation pressure before serious problems arise. (→P. 473, 482)

## Directional tires



### Tire direction marks

The tire sidewalls are marked with arrows indicating the rolling direction of the tire. If mounted on the wrong side of the vehicle, directional tires will perform poorly.

### Installing tire pressure warning valves and transmitters

When replacing tires or wheels, tire pressure warning valves and transmitters must also be installed.

When new tire pressure warning valves and transmitters are installed, new tire pressure warning valve and transmitter ID codes must be registered in the tire pressure warning computer and tire pressure warning system must be initialized. Have tire pressure warning valve and transmitter ID codes registered by your Lexus dealer. (→P. 416)

### Initializing the tire pressure warning system

■ **The tire pressure warning system must be initialized in the following circumstances:**

- When rotating the tires on vehicles differing with front and rear tire inflation pressures.
- When changing the tire inflation pressure by changing traveling speed.
- When changing the tire size.

When the tire pressure warning system is initialized, the current tire inflation pressure is set as the pressure benchmark.

## ■ How to initialize the tire pressure warning system

To initialize the system, use the satellite switch. (→P. 339)

**STEP 1** Park the vehicle in safe place and turn the “ENGINE START STOP” switch OFF.

While the vehicle is moving, initialization is not performed.

**STEP 2** Adjust the tire inflation pressure to the specified cold tire inflation pressure level. (→P. 531)

Make sure to adjust the tire pressure to the specified cold tire inflation pressure level. The tire pressure warning system will operate based on this pressure level.

**STEP 3** Turn the “ENGINE START STOP” switch to IGNITION ON mode.

**STEP 4**



**1** The tire inflation pressure initialization setting display

Continue to press “<” or “>” until the initialization setting display appears.

**2** Recording tire inflation pressure settings

Push and hold the “ON/OFF” button until the tire pressure warning light blinks slowly three times.

**STEP 5** Wait for a few minutes with the IGNITION ON mode, and then turn the “ENGINE START STOP” switch OFF.

## Registering and selecting ID codes

To select tire pressure warning valve and transmitter ID codes, use the satellite switch. (→P. 339)

### ■ Registering ID codes

2 sets of tire pressure warning valve and transmitter ID codes can be registered. Once a second set of tires is registered at "2ND", you can switch between tire set settings simply by pressing the tire pressure warning select switch.

There are 2 settings:

"MAIN" position: The ID code of the tire pressure warning valve and transmitter on the tires originally installed on the vehicle is registered.

"2ND" position: The ID code is not registered. When you replace a new set of tires, purchase tire pressure warning valves and transmitters from your Lexus dealer and have the new ID code registered by your Lexus dealer.



## ■ Selecting ID codes

When replacing tires, make sure to select the ID code set that matches the new tire set. If the tire pressure select switch is set to the wrong tire setting, the tire pressure warning system will not operate properly. After driving for about 20 minutes, the tire pressure warning light comes on after blinking for 1 minute to indicate a system malfunction.



- 1 Tire pressure warning valve and transmitter ID code settings display

Press “<” or “>” repeatedly until the setting display appears.

- 2 Switching ID codes

Press the “ON/OFF” button to switch between “MAIN” and “2ND” ID codes.

### ■ When to replace your vehicle's tires

Tires should be replaced if:

- You have tire damage such as cuts, splits, cracks deep enough to expose the fabric or bulges indicating internal damage
- A tire goes flat repeatedly or cannot be properly repaired due to the size or location of a cut or other damage

If you are not sure, consult with your Lexus dealer.

### ■ Replacing tires and wheels

If the ID code of the tire pressure warning valve and transmitter is not registered, the tire pressure warning system will not work properly. After driving for about 20 minutes, the tire pressure warning light blinks for 1 minute and stays on to indicate a system malfunction.

### ■ Tire life

Any tire over 6 years old must be checked by a qualified technician even if it has seldom or never been used or damage is not obvious.

### ■ If the tread wears down below 0.16 in. (4 mm) on snow tires

The effectiveness of snow tires is lost.

### ■ Low profile tires (models not equipped with 16-inch tires)

Generally, low profile tires will wear more rapidly and tire grip performance will be reduced on snowy and/or icy roads when compared to standard tires. Be sure to use snow tires or tire chains\* on snowy and/or icy roads and drive carefully at a speed appropriate for road and weather conditions.

\*: Tire chains cannot be mounted on 18-inch tires.

### ■ Maximum load of tire

Check that the maximum load of the replacement tire is greater than 1/2 of the Gross Axle Weight Ratings (GAWR) of either the front axle or the rear axle, whichever is greater.



For the GAWR, see the Certification Label. For the maximum load of the tire, see the load limit at maximum cold tire inflation pressure mentioned on the sidewall of the tire. (→P. 541).

### ■ Tire types

#### 1 Summer tires

Summer tires are high-speed performance tires best suited to highway driving under dry conditions. Since summer tires do not have the same traction performance as snow tires, summer tires are inadequate for driving on snow-covered or icy roads. For driving on snow-covered roads or icy roads, the use of snow tires is recommended. When installing snow tires, be sure to replace all four tires.

#### 2 All season tires

All season tires are designed to provide better traction in snow and to be adequate for driving in most winter conditions, as well as for use year round. All season tires, however, do not have adequate traction performance compared with snow tires in heavy or loose snow. Also, all season tires fall short in acceleration and handling performance compared with summer tires in highway driving.

#### 3 Snow tires

For driving on snow-covered roads or icy roads, we recommend using snow tires. If you need snow tires, select tires of the same size, construction and load capacity as the originally installed tires. Since your vehicle has radial tires as original equipment, make sure your snow tires also have radial construction. Do not install studded tires without first checking local regulations for possible restriction. Snow tires should be installed on all wheels. (→P. 206)

### ■ Initializing the tire pressure warning system

Initialize the tires with the tire inflation pressure adjusted to the specified level.

### ■ When the initialization of the tire pressure warning system has failed

Initialization can be completed in a few minutes. However, in the following cases, the settings have not been recorded and the system will not operate properly. If repeated attempts to record tire inflation pressure settings are unsuccessful, have the vehicle inspected by your Lexus dealer.

- When operating the satellite switch, the tire pressure warning light does not blink 3 times.
- After carrying out the initialization procedure, the tire pressure warning light blinks for 1 minute then stays on after driving for about 20 minutes.

### ■ Routine tire inflation pressure checks

The tire pressure warning system does not replace routine tire inflation pressure checks. Make sure to check tire inflation pressure as part of your routine of daily vehicle checks.

**■ Tire pressure warning system certification****MODEL/FCC IDs:****Transmitter: PAXPMV107J****Receiver: HYQ13BCE****► For vehicles sold in the U.S.A.****NOTE:**

This device complies with Part 15 of the FCC Rules. Operation is subject to the following two conditions: (1) this device may not cause harmful interference, and (2) this device must accept any interference received, including interference that may cause undesired operation.

**FCC WARNING:**

Changes or modifications not expressly approved by the party responsible for compliance could void the user's authority to operate the equipment.

**► For vehicles sold in Canada****NOTE:**

Operation is subject to the following two conditions: (1) this device may not cause interference, and (2) this device must accept any interference, including interference that may cause undesired operation of the device.

### CAUTION

#### ■ Tire pressure warning system operation

The tire pressure warning system may not provide warning immediately if a tire bursts or if sudden air leakage occurs.

#### ■ When inspecting or replacing tires

Observe the following precautions to prevent accidents. Failure to do so may cause damage to parts of the drive train, as well as dangerous handling characteristics, which may lead to an accident resulting in death or serious injury.

- Do not mix tires of different makes, models or tread patterns.  
Also, do not mix tires of remarkably different treadwear.
- Do not use tire sizes other than those recommended by Lexus.
- Do not mix differently constructed tires (radial, bias-belted or bias-ply tires).
- Do not mix summer, all season and winter tires.
- Do not use tires that have been used on another vehicle.  
Do not use tires if you do not know how they were used previously.

#### ■ When initializing the tire pressure warning system

Do not press the satellite switch without first adjusting the tire inflation pressure to the specified level. Otherwise, the tire pressure warning light may not come on even if the tire inflation pressure is low, or it may come on when the tire inflation pressure is actually normal.

### NOTICE

#### ■ Repairing or replacing tires, wheels, tire pressure warning valves, transmitters and tire valve caps

- When removing or fitting the wheels, tires or the tire pressure warning valve and transmitter, contact your Lexus dealer as the tire pressure warning valve and transmitter may be damaged if not handled correctly.
- When replacing tire valve caps, do not use tire valve caps other than those specified. The cap may become stuck.

 NOTICE**■ To avoid damage to the tire pressure warning valves and transmitters**

When a tire is repaired with liquid sealants, the tire pressure warning valve and transmitter may not operate properly. If a liquid sealant is used, contact your Lexus dealer or other qualified service shop as soon as possible. Make sure to replace the tire pressure warning valve and transmitter when replacing the tire. (→P. 414)

**■ Driving on rough roads**

Take particular care when driving on roads with loose surfaces or pot holes. These conditions may cause losses in tire inflation pressure, reducing the cushioning ability of the tires. In addition driving on rough roads may cause damage to the tires themselves, as well as the vehicle's wheels and body.

**■ Low profile tires and wheels**

Wheels with profile tires like 17- and 18-inch tires may cause greater damage than usual to the tire wheel when receiving impact from the road surface. Therefore pay attention to the following:

- Be sure to use proper tire inflation pressure. If tires are under-inflated, they may be damaged more severely.
- Avoid pot holes, uneven pavement, curbs and other road hazards.  
Failure to do so may lead to severe tire and wheel damage.

**■ If tire inflation pressure become low while driving**

Do not continue driving, or your tires and/or wheels may be ruined.

## 4-3. Do-it-yourself maintenance

### Tire inflation pressure

#### ■ Tire inflation pressure

The recommended cold tire inflation pressure and tire size is displayed on the tire and loading information label. (→P. 531)



THE RECOMMENDED		RECOMMENDED COLD TIRE PRESSURE AND TIRE SIZE			
BEST DRIVING TIRE IS		NUMBER OF SEATS, TOTAL, IS			
NOT A REAR		FRONT X REAR X			
The combined weight of occupants		Le poids total des occupants et du chargement ne			
should never exceed 100 kg or 220 lb.		de dépasse jamais 100 kg ou 220 lb.			
TIRE	SIZE	TYRE PRESSURE	PNEU	DIMENSIONS	PRESSION DES PNEUS À FROID
FRONT	XXXXXXX	XXXPa,XXPSI	AVANT	XXX/XXXXX	XXXPa,XXPSI
REAR	XXXXXXX	XXXPa,XXPSI	ARRIÈRE	XXX/XXXXX	XXXPa,XXPSI
SPARE	XXXXXXX	XXXPa,XXPSI	DE SECOURS	XXX/XXXXX	XXXPa,XXPSI

SEE OWNER'S MANUAL FOR ADDITIONAL INFORMATION

VOIR LE MANUEL DE L'USAGER POUR PLUS DE RENSEIGNEMENTS

ULYSSE



### ■ Inspection and adjustment procedure



- 1 Tire valve
- 2 Tire pressure gauge

- STEP 1** Remove the tire valve cap.
- STEP 2** Press the tip of the tire pressure gauge onto the tire valve.
- STEP 3** Read the pressure using the graduations of the gauge.
- STEP 4** If the tire inflation pressure is not within the recommended levels, adjust the pressure.  
If you add too much air, press the center of the valve to lower.
- STEP 5** After completing the tire inflation pressure measurement and adjustment, apply soapy water to the valve and check for leakage.
- STEP 6** Reinstall the tire valve cap.

### ■ Tire inflation pressure check interval

You should check tire inflation pressure every two weeks, or at least once a month. Do not forget to check the spare.

### ■ Effects of incorrect tire inflation pressure

Driving with incorrect tire inflation pressure may result in the following:

- Reduced fuel efficiency
- Reduced driving comfort and tire life
- Reduced safety
- Damage to the drive train

If a tire needs frequent refilling, have it checked by your Lexus dealer.

### ■ Instructions for checking tire inflation pressure

When checking tire inflation pressure, observe the following:

- Check only when the tires are cold.

If your vehicle has been parked for at least 3 hours and has not been driven for more than 1 mile or 1.5 km, you will get an accurate cold tire inflation pressure reading.

- Always use a tire pressure gauge.

The appearance of the tire can be misleading. In addition, tire inflation pressures that are even just a few pounds off can degrade ride and handling.

- Do not bleed or reduce tire inflation pressure after driving. It is normal for the tire inflation pressure to be higher after driving.

- Never exceed the vehicle capacity weight.

Passengers and luggage weight should be placed so that the vehicle is balanced.

 **CAUTION****■ Proper inflation is critical to save tire performance**

Keep your tires properly inflated. Otherwise, the following conditions may occur and result in an accident causing death or serious injury.

- Excessive wear
- Uneven wear
- Poor handling
- Possibility of blowouts resulting from overheated tires
- Poor sealing of the tire bead
- Wheel deformation and/or tire separation
- A greater possibility of tire damage from road hazards

 **NOTICE****■ When inspecting and adjusting tire inflation pressure**

Be sure to reinstall the tire valve caps.

Without the valve caps, dirt or moisture could get into the valve and cause air leakage, which could result in an accident. If the caps have been lost, replace them as soon as possible.

# Wheels

If a wheel is bent, cracked or heavily corroded, it should be replaced. Otherwise, the tire may separate from the wheel or cause loss of handling control.

### ■ Wheel selection

When replacing wheels, care should be taken to ensure that they are equivalent to those removed in load capacity, diameter, rim width, and inset\*.

Replacement wheels are available at your Lexus dealer.

\*: Conventionally referred to as “offset”.

Lexus does not recommend using:

- Wheels of different sizes or types
- Used wheels
- Bent wheels that have been straightened

### ■ Aluminum wheel precautions

- Use only Lexus wheel nuts and wrenches designed for use with your aluminum wheels.
- When rotating, repairing or changing your tires, check that the wheel nuts are still tight after driving 1000 miles (1600 km).
- Be careful not to damage the aluminum wheels when using tire chains.
- Use only Lexus genuine balance weights or equivalent and a plastic or rubber hammer when balancing your wheels.

---

### ■ When replacing wheels

The wheels of your Lexus are equipped with tire pressure warning valves and transmitters that allow the tire pressure warning system to provide advanced warning in the event of a loss in tire inflation pressure. Whenever wheels are replaced, the tire pressure warning valves and transmitters must be installed. (→P. 414)

 **CAUTION****■ When replacing wheels**

- Do not use wheels that are a different size from those recommended in the Owner's Manual, as this may result in loss of handling control.
- Never use an inner tube in a leaking wheel which is designed for a tubeless tire. Doing so may result in an accident, causing death or serious injury.

 **NOTICE****■ Replacing tire inflation pressure warning valves and transmitters**

- Because tire repair or replacement may affect the tire pressure warning valves and transmitters, make sure to have tires serviced by your Lexus dealer or other qualified service shop. In addition, make sure to purchase your tire pressure warning valves and transmitters at your Lexus dealer.
- Ensure that only genuine Lexus wheels are used on your vehicle. Tire pressure warning valves and transmitters may not work properly with non-genuine wheels.

## 4-3. Do-it-yourself maintenance

### Air conditioning filter

The air conditioning filter must be cleaned or changed regularly to maintain air conditioning efficiency.

#### ■ Removal method

**STEP 1** Set the air conditioning system to recirculated mode.  
(→P. 216)

The air conditioning filter case cannot be removed with the system in the outside air mode.

**STEP 2** Turn the “ENGINE START STOP” switch OFF.

**STEP 3**

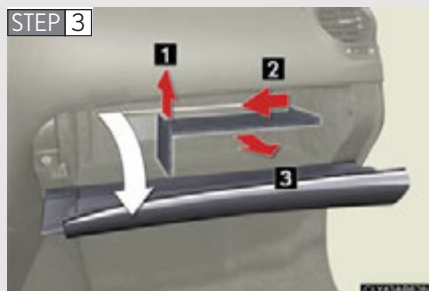

Open the glove box. Lift and remove the partition.

**STEP 4**



Remove the filter cover.

**STEP 5**

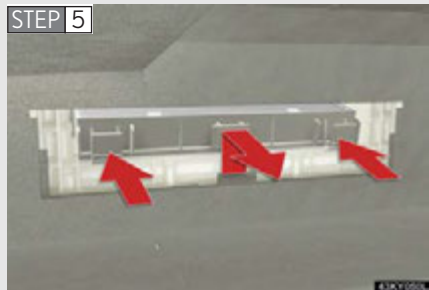

Remove the filter case.

### ■ Cleaning method



If the filter is dirty, clean by blowing compressed air through the filter from the downward side.

Hold the air gun 2 in. (5 cm) from the filter and blow for approximately 2 minutes at 72 psi (500 kPa, 5.0 kgf/cm<sup>2</sup> or bar).

If it is not available, have the filter cleaned by your Lexus dealer.

### ■ Replacement method



Remove the air conditioning filter from the filter case and replace it with a new one.

The “↑UP” marks shown on the filter and the filter case should be pointing up.

### ■ Checking interval

Inspect and replace the air conditioning filter according to the maintenance schedule. In dusty areas or areas with heavy traffic flow, early replacement may be required. (For scheduled maintenance information, please refer to the “Owner’s Manual Supplement/Scheduled Maintenance”.)

### ■ If air flow from the vents decreases dramatically

The filter may be clogged. Check the filter and replace if necessary.

### NOTICE

#### ■ To prevent damage to the system

- When using the air conditioning system, make sure that a filter is always installed.
- When cleaning the filter, do not clean the filter with water.



## 4-3. Do-it-yourself maintenance

### Electronic key battery

Replace the battery with a new one if it is discharged.

■ You will need the following items:

- Flathead screwdriver
- Small Phillips-head screwdriver
- Lithium battery (CR1632)

■ Replacing the battery

STEP 1



Take out the mechanical key.

STEP 2



Remove the cover.

STEP 3

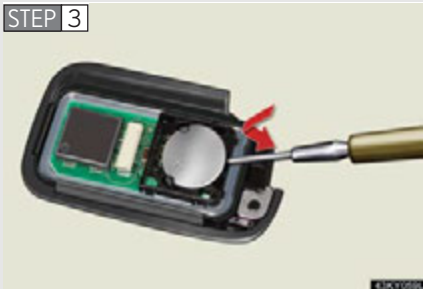

Remove the depleted battery.

Insert a new battery with the “+” terminal facing up.

### ■ If the electronic key battery is discharged

The following symptoms may occur.

- The smart access system with push-button start and wireless remote control will not function properly.
- The operational range is reduced.

### ■ Use a CR1632 lithium battery

- Batteries can be purchased at your Lexus dealer, jewelers, or camera stores.
- Replace only with the same or equivalent type recommended by a Lexus dealer.
- Dispose of used batteries according to the local laws.

### ■ When the card key battery needs to be replaced (if equipped)

The battery for the card key is available only at Lexus dealers. Your Lexus dealer can replace the battery for you.

### CAUTION

#### ■ Removed battery and other parts

Keep away from children. These parts are small and if swallowed by a child, they can cause choking. Failure to do so could result in death or serious injury

### NOTICE

#### ■ For normal operation after replacing the battery

Observe the following precautions to prevent accidents.

- Always work with dry hands.  
Moisture may cause the battery to rust.
- Do not touch or move any other components inside the remote control.
- Do not bend either of the battery terminals.

## 4-3. Do-it-yourself maintenance

### Checking and replacing fuses

If any of the electrical components do not operate, a fuse may have blown. If this happens, check and replace the fuses as necessary.

**STEP 1** Turn the “ENGINE START STOP” switch OFF.

**STEP 2** Engine compartment (type B fuse box): Remove the engine compartment cover. (→P. 399)

**STEP 3** Open the fuse box cover.

▶ Engine compartment (type A fuse box)

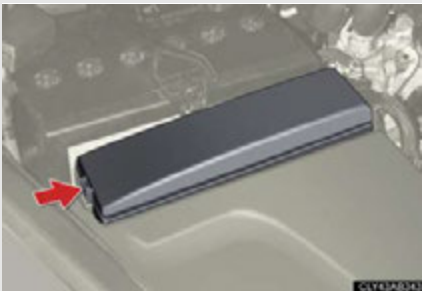

Push the tabs in and lift the lid off.

▶ Engine compartment (type B fuse box)



Push the tabs in and lift the lid off.

▶ Driver's side instrument panel



Remove the lid.

▶ Passenger's side instrument panel



Remove the lid.

**STEP 4** After a system failure, see "Fuse layout and amperage ratings" (→P. 439) for details about which fuse to check.

**STEP 5**



Remove the fuse with the pull-out tool.

**STEP 6** Check if the fuse has blown.

## ▶ Type A

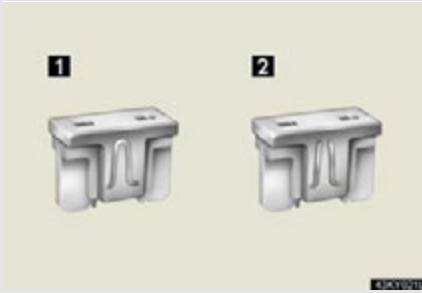
**1** Normal fuse**2** Blown fuse

Replace it with one of an appropriate amperage rating. The amperage rating can be found on the fuse box lid.

## ▶ Type B

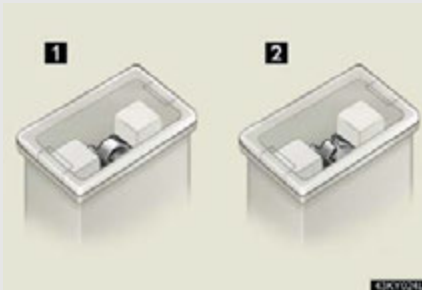
**1** Normal fuse**2** Blown fuse

Replace it with one of an appropriate amperage rating. The amperage rating can be found on the fuse box lid.

## ▶ Type C

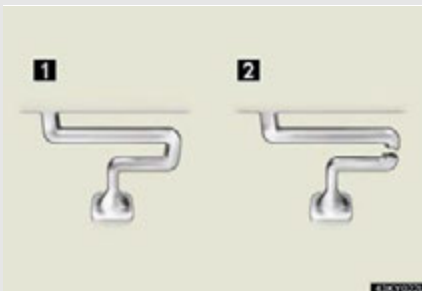
**1** Normal fuse**2** Blown fuse

Contact your Lexus dealer.

▶ Type D

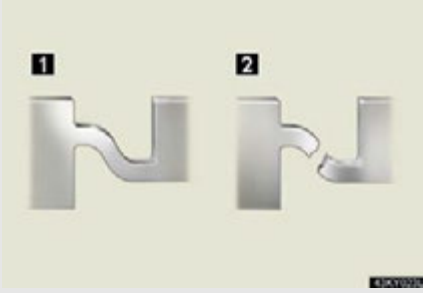

1 Normal fuse

2 Blown fuse

Contact your Lexus dealer.

Removing the front controller (engine compartment: type B fuse box)

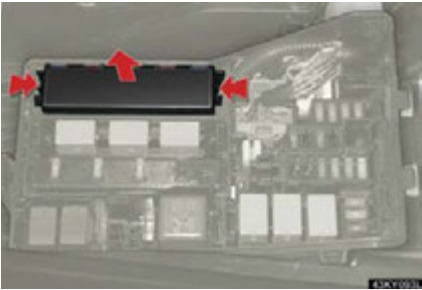

Lift the lid off while pushing the tabs on either side.

## Fuse layout and amperage ratings

### ■ Engine compartment (type A fuse box)

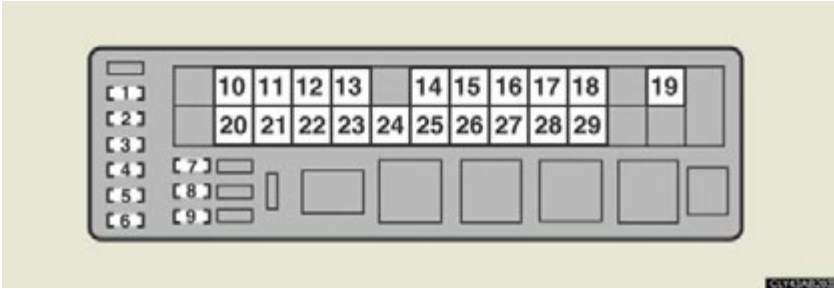

Fuse		Ampere	Circuit
1	PWR HTR	25 A	—
2	TURN-HAZ	15 A	Emergency flashers, turn signals
3	IG2 MAIN	20 A	IG2, IGN, GAUGE
4	RAD NO.2	30 A	Audio
5	D/C CUT	20 A	DOME, MPX-B
6	RAD NO.1	30 A	—
7	MPX-B	10 A	Headlights, front fog lights, parking lights, license plate lights, windshield washer, horn, power door lock system, power windows, power seats, electric tilt and telescopic steering column, meter, smart access system with push-button start, outside rear view mirrors, air conditioning system, multiplex communication system
8	DOME	10 A	Interior lights, meter, outer foot lights
9	CDS	10 A	Electric cooling fans

### 4-3. Do-it-yourself maintenance

Fuse		Ampere	Circuit
10	E/G-B	60 A	FR CTRL-B, ETCS, ALT-S, A/F, STR LOCK
11	DIESEL GLW	80 A	————
12	ABS1	50 A	VDIM
13	RH J/B-B	30 A	FR DOOR RH, RR DOOR RH, AM2
14	MAIN	30 A	H-LP R LWR, H-LP L LWR
15	STARTER	30 A	Smart access system with push-button start
16	LH J/B-B	30 A	FR DOOR LH, RR DOOR LH, SECURITY
17	P/I-B	60 A	EFI, F/PMP, INJ
18	EPS	80 A	Power steering
19	ALT	150 A	LH J/B-AM, E/G-AM, GLW PLG2, HEATER, FAN1, FAN2, DEFOG, ABS2, RH J/B-AM, GLW PLG1, LH J/B-B, RH J/B-B
20	GLW PLG1	50 A	PTC heater
21	RH J/B-AM	80 A	OBD, STOP SW, TI&TE, FR P/SEAT RH, RAD NO.3, ECU-IG RH, RH-IG, FR S/HTR RH, ACC, CIG, PWR OUTLET
22	ABS2	30 A	VDIM
23	DEFOG	50 A	Rear window defogger
24	FAN2	40 A	Electric cooling fans
25	FAN1	40 A	Air conditioning system
26	HEATER	50 A	Air conditioning system
27	GLW PLG2	50 A	PTC heater



Fuse		Ampere	Circuit
28	E/G-AM	60 A	H-LP CLN, FR CTRL AM, A/C COMP DEICER
29	LH J/B-AM	80 A	S/ROOF, FR P/SEAT LH, TV NO.1, A/C, FUEL OPEN, PSB, FR WIP, H-LP LVL, LH-IG, ECU-IG LH, PANEL, TAIL, TV NO.2, MIR HTR, FR S/HTR LH

■ Engine compartment (type B fuse box)

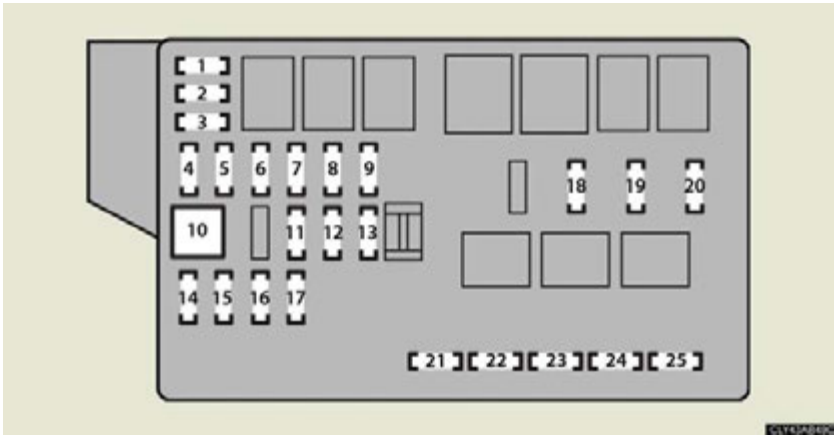

Fuse		Ampere	Circuit
1	SPARE	30 A	Spare fuse
2	SPARE	25 A	Spare fuse
3	SPARE	10 A	Spare fuse
4	FR CTRL-B	25 A	H-LP UPR, HORN
5	A/F	15 A	Multiport fuel injection system/ sequential multiport fuel injection system
6	ETCS	10 A	Multiport fuel injection system/ sequential multiport fuel injection system
7	ALT-S	7.5 A	Charging system
8	TEL	10 A	TEL
9	STR LOCK	25 A	Steering lock
10	H-LP CLN	30 A	Headlight cleaner
11	A/C COMP	7.5 A	Air conditioning system
12	DEICER	25 A	Windshield wiper de-icer

	Fuse	Ampere	Circuit
13	FR CTRL-AM	30 A	FR TAIL, FR FOG, WASHER
14	IG2	10 A	Ignition system
15	EFI NO.2	10 A	Multiport fuel injection system/ sequential multiport fuel injection system
16	H-LP R LWR	15 A	Headlight low beam (right)
17	H-LP L LWR	15 A	Headlight low beam (left)
18	F/PMP	25 A	Fuel system
19	EFI	25 A	Multiport fuel injection system/ sequential multiport fuel injection system, EFI NO.2
20	INJ	20 A	Multiport fuel injection system/ sequential multiport fuel injection system
21	H-LP UPR	15 A	Headlight high beams
22	HORN	10 A	Horns
23	WASHER	20 A	Windshield washer
24	FR TAIL	10 A	Parking lights
25	FR FOG	15 A	Front fog lights

## ■ Driver's side instrument panel

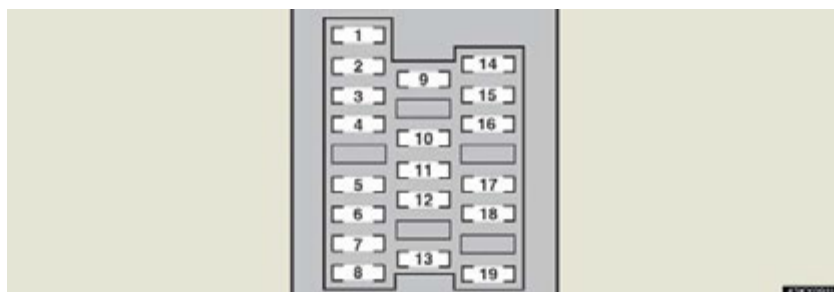

Fuse		Ampere	Circuit
1	FR P/SEAT LH	30 A	Power seat
2	A/C	7.5 A	Air conditioning system
3	MIR HTR	15 A	Outside rear view mirror defoggers
4	TV NO.1	10 A	Display
5	FUEL OPEN	10 A	Fuel filler door opener
6	TV NO.2	7.5 A	——
7	PSB	30 A	——
8	S/ROOF	25 A	Moon roof
9	TAIL	10 A	Tail lights, license plate lights, parking lights
10	PANEL	7.5 A	Switch illumination, air conditioning system, display, audio
11	RR FOG	7.5 A	——
12	ECU-IG LH	10 A	Cruise control, air conditioning system, power steering, rain sensor, anti-glare inside rear view mirror, shift lock system, moon roof, tire inflation pressure warning system, VSC
13	FR S/HTR LH	15 A	Seat heaters and ventilators

	Fuse	Ampere	Circuit
14	RR DOOR LH	20 A	Power windows
15	FR DOOR LH	20 A	Power windows, outside rear view mirror
16	SECURITY	7.5 A	Smart access system with push-button start
17	H-LP LVL	7.5 A	Automatic headlight leveling system
18	LH-IG	10 A	Charging system, headlight cleaner, rear window defogger, electric cooling fans, emergency flashers, turn signal lights, back-up lights, stop lights, mirror heaters, rear sun shade, seat belts, intuitive parking assist, cruise control, air conditioning system, PTC heater, manual transmission, windshield wiper de-icer
19	FR WIP	30 A	Windshield wipers

■ Passenger's side instrument panel

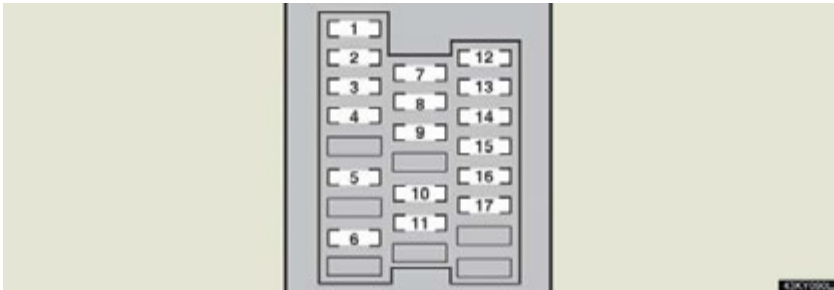

Fuse		Ampere	Circuit
1	FR P/SEAT RH	30 A	Power seat
2	DOOR DL	15 A	—
3	OBD	7.5 A	On-board diagnosis system
4	STOP SW	7.5 A	Stop lights, multiport fuel injection system/sequential multiport fuel injection system, VDIM, shift lock system, high mounted stop light
5	TI & TE	20 A	Electric tilt and telescopic steering column
6	RAD NO.3	10 A	Audio
7	GAUGE	7.5 A	Meter
8	IGN	10 A	SRS airbag system, steering lock system, multiport fuel injection system/sequential multiport fuel injection system, stop lights

Fuse		Ampere	Circuit
9	ACC	7.5 A	Clock, air conditioning system, audio, navigation system, outside rear view mirrors, Lexus parking assist monitor, glove box light, console box light, multiplex communication system, display, smart access system with push-button start
10	CIG	15 A	Cigarette lighter
11	PWR OUTLET	15 A	Power outlet
12	RR DOOR RH	20 A	Power windows
13	FR DOOR RH	20 A	Power windows, outside rear view mirrors, multiplex communication system
14	AM2	7.5 A	Starting system
15	RH-IG	7.5 A	Seat belts, intuitive parking assist, automatic transmission, seat heater and ventilator, windshield wiper de-icer
16	FR S/HTR RH	15 A	Seat heaters and ventilators
17	ECU-IG RH	10 A	Power seats, smart access system with push-button start, AWD system, outside rear view mirrors, VDIM, air conditioning system, electric tilt and telescopic steering, power windows, navigation system, multiplex communication system

### ■ After a fuse is replaced

- If the lights do not turn on even after the fuse has been replaced, a bulb may need replacement. (→P. 451)
- If the replaced fuse blows again, have the vehicle inspected by your Lexus dealer.

### ■ If there is an overload in the circuits

The fuses are designed to blow, protecting the wiring harness from damage.

### CAUTION

#### ■ To prevent system breakdowns and vehicle fire

Observe the following precautions.

Failing to do so may cause damage, and possibly a fire or injury.

- Never use a fuse of a higher amperage rating than indicated, or use any other object in place of a fuse.
- Always use a genuine Lexus fuse or equivalent.  
Never replace a fuse with a wire, even as a temporary fix.  
This can cause extensive damage or even fire.
- Do not modify the fuses or the fuse box.

### NOTICE

#### ■ Before replacing fuses

Have the cause of electrical overload determined and repaired by your Lexus dealer.



## 4-3. Do-it-yourself maintenance

# Headlight aim

- Removing the engine compartment cover  
→P. 399

- Vertical movement adjusting bolts

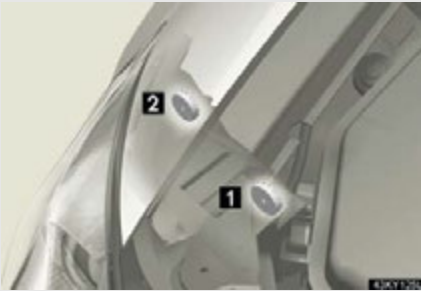

- 1 Adjustment bolt A
- 2 Adjustment bolt B

- Before checking the headlight aim

- STEP 1 Make sure the vehicle has a full tank of gas and the area around the headlight is not deformed.
- STEP 2 Park the vehicle on level ground.
- STEP 3 Sit in the driver's seat.
- STEP 4 Bounce the vehicle several times.

### ■ Adjusting the headlight aim

STEP 1



Turn bolt A in either direction using a Phillips-head screwdriver.

Remember the turning direction and the number of turns.

STEP 2



Turn bolt B the same number of turns and in the same direction as step 1 using a Phillips-head screwdriver.

If the headlight cannot be adjusted using this procedure, take the vehicle to your Lexus dealer to adjust the headlight aim.

## 4-3. Do-it-yourself maintenance

# Light bulbs

You may replace the following bulbs yourself. For more information about replacing other light bulbs, contact your Lexus dealer.

### ■ Preparing a replacement light bulb

Check the wattage of the light bulb being replaced. (→P. 536)

### ■ Removing the engine compartment cover

→P. 399

### ■ Front bulb locations

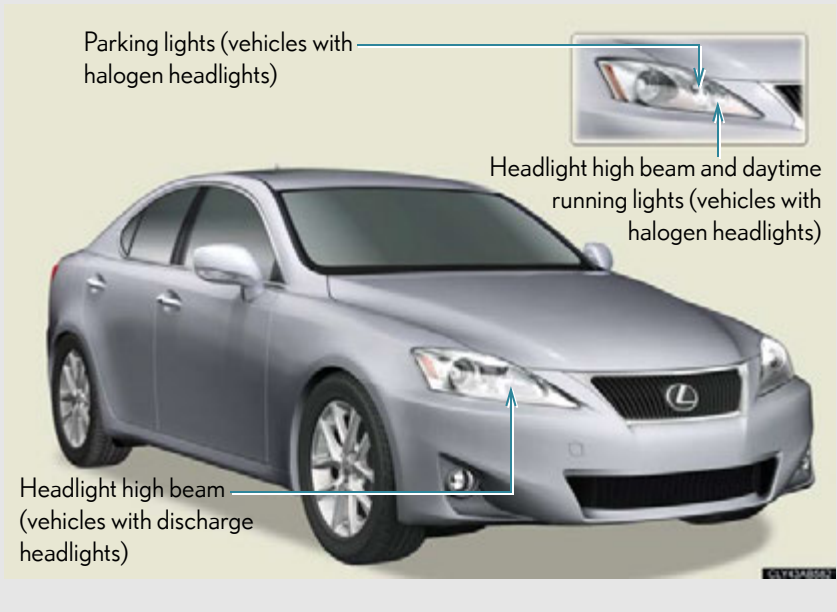

■ Rear bulb locations



## Replacing light bulbs

### ■ Headlight high beams and daytime running lights (vehicles with halogen headlights)

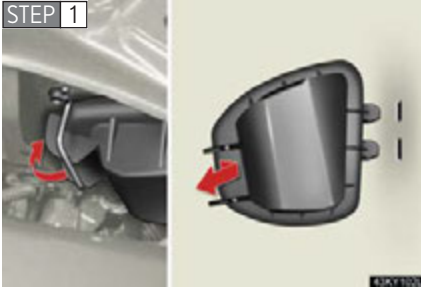

Release the lock and remove the cover.



Turn the bulb base counterclockwise.

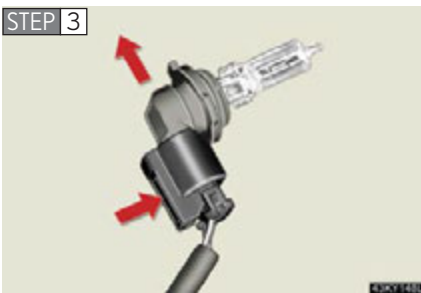

Unplug the connector while depressing the lock release.

■ Headlight high beams (vehicles with discharge headlights)

STEP 1



Turn the cover counterclockwise and remove it.

STEP 2



Turn the bulb base counterclockwise.

STEP 3



Unplug the connector while pulling the lock release.

### ■ Parking lights (vehicles with halogen headlights)

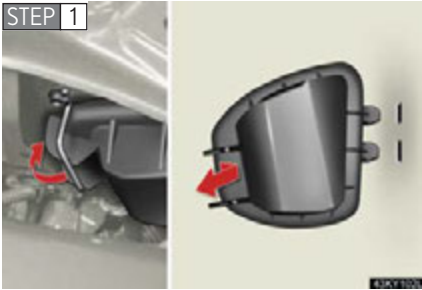

Release the lock and remove the cover.



Turn the bulb base counterclockwise.



Remove the light bulb.

### ■ Back-up lights



Open the trunk door and remove the trunk panel cover clips.

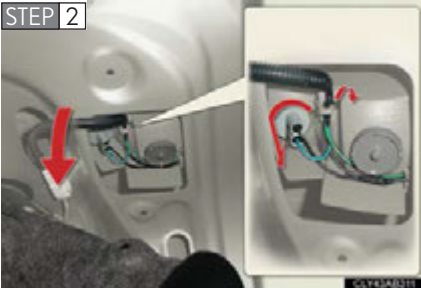

Partly remove the trunk panel cover and turn the bulb base counterclockwise.

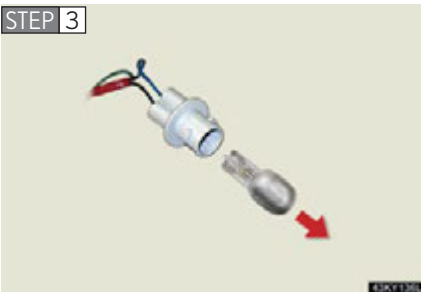

Remove the light bulb.

### ■ Rear turn signal lights

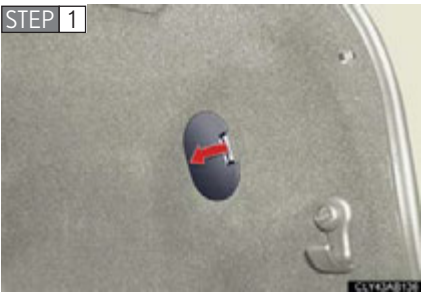

Open the trunk door and remove the cover.

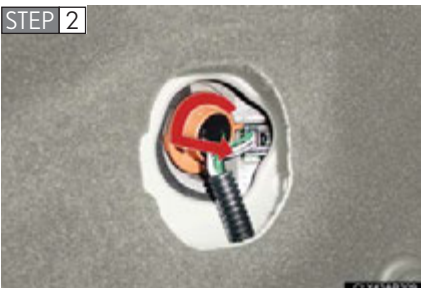

Turn the bulb base counterclockwise.

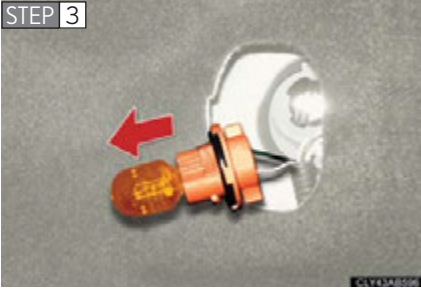

**STEP 3**

Remove the light bulb.

### **Bulbs other than the above**

If any of the bulbs listed below has burnt out, have your Lexus dealer replace it.

- Headlight low beams (halogen bulbs)
- Headlight high and low beams (discharge bulbs)
- Front fog lights
- Front turn signal lights
- Front side marker lights
- Side turn signal lights
- Stop/tail lights
- Tail lights
- Rear side marker lights
- High mounted stoplight
- License plate lights
- Parking lights and daytime running lights (vehicles with discharge headlights)

### ■ When replacing the front left headlight and parking light (vehicles with halogen headlights) bulbs



Remove the securing bolt and move the washer fluid filler opening to allow easy access to the light bulbs.

After replacing the bulbs, make sure to secure the washer fluid filler opening with the bolt.

### ■ Condensation build-up on the inside of the lens

Contact your Lexus dealer for more information in the following situations. Temporary condensation build-up on the inside of the headlight lens does not indicate a malfunction.

- Large drops of water are built up on the inside of the lens.
- Water has built up inside the headlight.

### ■ Discharge headlights (if equipped)

If voltage to the discharge bulbs is insufficient, the bulbs may not come on, or may go out temporarily. The discharge bulbs will come on when normal power is restored.

### ■ LED front side marker lights, side turn signal lights, tail lights, stop/tail lights, high mounted stoplight, rear side marker lights, license plate lights and parking lights (vehicles with discharge headlights)

The front side marker lights, side turn signal lights, tail lights, stop/tail lights, high mounted stoplight, rear side marker lights, license plate lights and parking lights (vehicles with discharge headlights) consist of a number of LEDs. If any of the LEDs burn out, take your vehicle to your Lexus dealer to have the light replaced.

 **CAUTION****■ Replacing light bulbs**

- Turn off the headlights. Do not attempt to replace the bulb immediately after turning off the headlights.  
The bulbs become very hot and may cause burns.
- Do not touch the glass portion of the light bulb with bare hands. Hold the bulb by the plastic or metal portion.  
If the bulb is scratched or dropped it may blow out or crack.
- Fully install light bulbs and any parts used to secure them. Failing to do so may result in heat damage, fire, or water entering the headlight unit. This may damage the headlights or cause condensation to build up on the lens.

**■ Discharge headlights (if equipped)**

- Contact your Lexus dealer before replacing discharge headlights (including light bulbs).
- Do not touch the high-intensity discharge headlight's high voltage socket when the headlights are turned on.  
An extremely high voltage of 20000 V will be discharged and could result in serious injury or death by electric shock.
- Do not attempt to take apart or repair the low beam headlight bulbs, connectors, power supply circuits, or related components.  
Doing so could result in electric shock and serious injury or death.

**■ To prevent damage or fire**

Make sure bulbs are fully seated and locked.



## When trouble arises

# 5

### 5-1. Essential information

Emergency flashers.....	462
If your vehicle needs to be towed .....	463
If you think something is wrong .....	469
Fuel pump shut off system .....	470

### 5-2. Steps to take in an emergency

If a warning light turns on or a warning buzzer sounds... ..	471
If a warning message is displayed.....	481
If you have a flat tire.....	492
If the engine will not start .....	501
If the shift lever cannot be shifted from P .....	503
If you lose your keys .....	504
If the electronic key does not operate properly.....	505
If the vehicle battery is discharged .....	510
If your vehicle overheats .....	513
If the vehicle becomes stuck.....	516
If your vehicle has to be stopped in an emergency.....	518

## 5-1. Essential information

# Emergency flashers

Use the emergency flashers if the vehicle malfunctions or is involved in an accident.



Press the switch to flash all the turn signal lights. To turn them off, press the switch once again.

### NOTICE

#### ■ To prevent battery discharge

Do not leave the emergency flashers on longer than necessary when the engine is not running.

## 5-1. Essential information

# If your vehicle needs to be towed

If towing is necessary, we recommend having your vehicle towed by your Lexus dealer or a commercial towing service, using a lift-type truck or a flat bed truck.

Use a safety chain system for all towing, and abide by all state/provincial and local laws.

If towing from the rear, the vehicle's front wheels and axles must be in good condition. (→P. 467)

If they are damaged, use a towing dolly or flat bed truck.

### Before towing

The following may indicate a problem with your transmission. Contact your Lexus dealer before towing.

- The engine is running, but the vehicle will not move.
- The vehicle makes an abnormal sound.

### Emergency towing

If a tow truck is not available, in an emergency your vehicle may be temporarily towed using a cable or chain secured to the emergency towing eyelet(s). This should only be attempted on hard, surfaced roads for short distances at low speeds.

A driver must be in the vehicle to steer and operate the brakes. The vehicle's wheels, drive train, axles, steering and brakes must be in good condition.



Towing eyelets

■ **Emergency towing procedure**

**STEP 1** Release the parking brake.

**STEP 2** Shift the shift lever to N.

**STEP 3** Put the "ENGINE START STOP" switch in ACCESSORY mode or IGNITION ON mode.

 **CAUTION**

■ **Caution while towing**

- Use extreme caution when towing the vehicle.  
Avoid sudden starts or erratic driving maneuvers which place excessive stress on the emergency towing eyelets and the cables or chains. Always be cautious of the surroundings and other vehicles while towing.
- If the engine is not running, the power assist for the brakes and steering will not function, making steering and braking more difficult.

 **NOTICE**

■ **To prevent causing serious damage to the transmission (vehicles with an automatic transmission)**

Never tow this vehicle from the front with the rear wheels on the ground. This may cause serious damage to the transmission.

■ **When towing a vehicle without using a towing dolly (vehicles with a manual transmission)**

The "ENGINE START STOP" switch must not be OFF.



## Installing towing eyelets

STEP 1

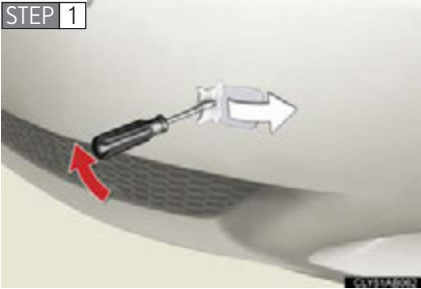

Remove the eyelet cover using a flathead screwdriver.

To protect the bodywork, place a rag between the screwdriver and the vehicle body, as shown in the illustration.

STEP 2

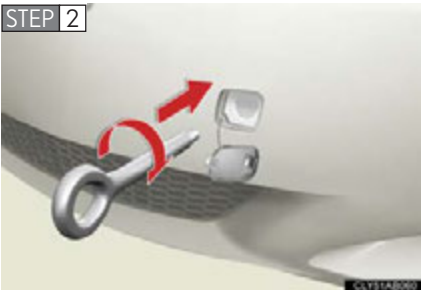

Insert the towing eyelet into the hole and tighten partially by hand.

STEP 3

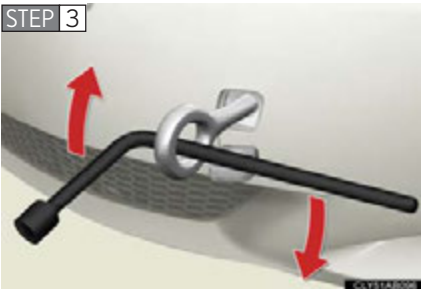

Tighten down the towing eyelet securely using a wheel nut wrench.

### ■ Location of the emergency towing eyelet

→P. 492

**⚠ CAUTION**

**■ Installing towing eyelets to the vehicle**

Make sure that towing eyelets are installed securely.

If not securely installed, towing eyelets may come loose during towing. This may lead to accidents that cause serious injury or even death.

**Towing with a sling-type truck**



**⚠ NOTICE**

**■ To prevent body damage**

Do not tow with a sling type truck, either from the front or rear.

## Towing with a wheel lift-type truck

### ▶ From the front

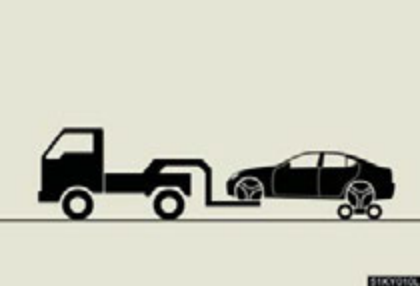

Vehicles with an automatic transmission: Use a towing dolly under the rear wheels.

Vehicles with a manual transmission: We recommend to use a towing dolly under the rear wheels.

When not using a towing dolly, release the parking brake and shift the shift lever to N.

### ▶ From the rear (2WD models)



Switch to ACCESSORY mode so that the steering wheel is unlocked.

### ▶ From the rear (AWD models)

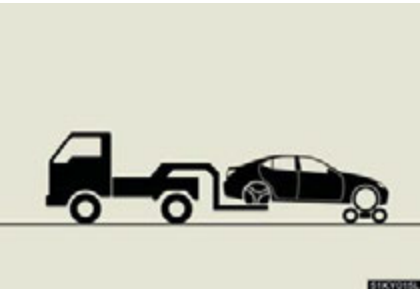

Use a towing dolly under the front wheels.

 NOTICE

■ **To prevent causing serious damage to the transmission (vehicles with an automatic transmission)**

Never tow this vehicle from the front with the rear wheels on the ground.

■ **To prevent damaging the vehicle**

- Do not tow the vehicle from the rear with the “ENGINE START STOP” switch OFF.  
The steering lock mechanism is not strong enough to hold the front wheels straight.
- When raising the vehicle from the rear, ensure adequate ground clearance for towing at the opposite end of the raised vehicle. Without adequate clearance, the vehicle could be damaged while being towed from the rear.

**Using a flat bed truck**

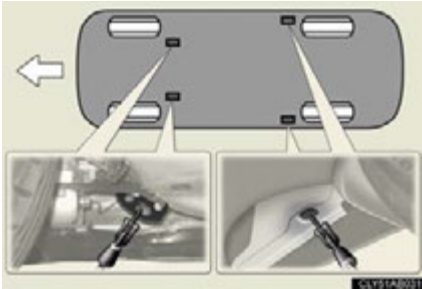

If your Lexus is transported by a flat bed truck, it should be tied down at the locations shown in the illustration.

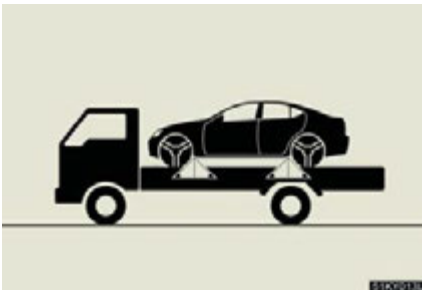

If you use chains or cables to tie down your vehicle, the angles shaded in black must be 45°.

Do not overly tighten the tie downs or the vehicle may be damaged.

# If you think something is wrong

If you notice any of the following symptoms, your vehicle probably needs adjustment or repair. Contact your Lexus dealer as soon as possible.

### ■ Visible symptoms

- Fluid leaks under the vehicle  
(Water dripping from the air conditioning after use is normal.)
- Flat-looking tires or uneven tire wear
- Engine coolant temperature gauge needle continually points higher than normal

### ■ Audible symptoms

- Changes in exhaust sound
- Excessive tire squeal when cornering
- Strange noises related to the suspension system
- Pinging or other noises related to the engine

### ■ Operational symptoms

- Engine missing, stumbling or running rough
- Appreciable loss of power
- Vehicle pulls heavily to one side when braking
- Vehicle pulls heavily to one side when driving on a level road
- Loss of brake effectiveness, spongy feeling, pedal almost touches the floor

## 5-1. Essential information

# Fuel pump shut off system

To minimize the risk of fuel leakage when the engine stalls or an airbag inflates upon collision, the fuel pump shut off system stops supplying fuel to the engine.

Follow the procedure below to restart the engine after the system is activated.

**STEP 1** Turn the “ENGINE START STOP” switch to the ACCESSORY mode or OFF.

**STEP 2** Restart the engine.

### NOTICE

#### ■ Before starting the engine

Inspect the ground under the vehicle.

If you find that fuel has leaked on to the ground, the fuel system has been damaged and is in need of repair. Do not restart the engine.



## 5-2. Steps to take in an emergency

### If a warning light turns on or a warning buzzer sounds...

Calmly perform the following actions if any of the warning lights turn on or flash. If a light turns on or flashes, but then turns off, this does not necessarily indicate a malfunction in the system.

**Stop the vehicle immediately. Continuing to drive the vehicle may be dangerous.**

The following warning indicates a possible problem in the brake system. Immediately stop the vehicle in a safe place and contact your Lexus dealer.

Warning light	Warning light/Details
 (U.S.A.)	<b>Brake system warning light (warning buzzer)*</b> <ul style="list-style-type: none"><li>• Low brake fluid</li><li>• Malfunction in the brake booster system</li></ul> This light also comes on when the parking brake is not released. If the light turns off after the parking brake is fully released the system is operating normally.
 (Canada)	

\*: Parking brake engaged warning buzzer:

→P. 484



**Stop the vehicle immediately.**

The following warning indicates the possibility of damage to the vehicle that may lead to an accident. Immediately stop the vehicle in a safe place and contact your Lexus dealer.





Warning light	Warning light/Details
	<p><b>Charging system warning light</b> Indicates a malfunction in the vehicle's charging system.</p>

**Have the vehicle inspected by your Lexus dealer immediately.**

Failing to investigate the cause of the following warnings may lead to the system operating abnormally and possibly cause an accident. Have the vehicle inspected by your Lexus dealer immediately.



Warning light	Warning light/Details
 (U.S.A.)  (Canada)	<p><b>Malfunction indicator lamp</b> Indicates a malfunction in:</p> <ul style="list-style-type: none"> <li>• The electronic engine control system;</li> <li>• The electronic throttle control system; or</li> <li>• The electronic automatic transmission control system.</li> </ul>
	<p><b>SRS warning light</b> Indicates a malfunction in:</p> <ul style="list-style-type: none"> <li>• The SRS airbag system; or</li> <li>• The seat belt pretensioner system.</li> </ul>





Warning light	Warning light/Details
 (U.S.A.)  (Canada)	<b>ABS warning light</b> Indicates a malfunction in: <ul style="list-style-type: none"> <li>• The ABS;</li> <li>• The brake assist system.</li> </ul>
	<b>Electric power steering system warning light</b> Indicates a malfunction in the EPS (Electric Power Steering) system.
	<b>Slip indicator</b> Indicates a malfunction in: <ul style="list-style-type: none"> <li>• The VSC system;</li> <li>• The TRAC system; or</li> <li>• The hill-start assist control system</li> </ul>

### Follow the correction procedures.

After taking the specified steps to correct the suspected problem, check that the warning light turns off.

Warning light	Warning light/Details	Correction procedure
	<b>Open door warning light (warning buzzer)*<sup>1</sup></b> Indicates that a door or the trunk is not fully closed.	Check that all doors and the trunk are closed.
	<b>Low fuel level warning light</b> Remaining fuel (Approximately 2.9 gal. [11 L, 2.4 Imp. gal.] or less)	Refuel the vehicle.
 (On the instrument cluster)	<b>Driver's seat belt reminder light (warning buzzer)*<sup>2</sup></b> Warns the driver to fasten his/her seat belt.	Fasten the seat belt.

Warning light	Warning light/Details	Correction procedure
 (On the center panel)	<p><b>Front passenger's seat belt reminder light (warning buzzer)*2</b>                      Warns the front passenger to fasten his/her seat belt.</p>	<p>Fasten the seat belt.</p>
	<p><b>Tire pressure warning light</b></p> <p>When the light comes on:                      Low tire inflation pressure such as</p> <ul style="list-style-type: none"> <li>• Natural causes (→P. 476)</li> <li>• Flat tire (→P. 492)</li> </ul> <p>When the light comes on after blinking for 1 minute:                      Malfunction in the tire pressure warning system (→P. 477)</p>	<p>Adjust the tire inflation pressure to the specified level.                      The light will turn off after a few minutes. In case the light does not turn off even if the tire inflation pressure is adjusted, have the system checked by your Lexus dealer.</p> <p>Have the system checked by your Lexus dealer.</p>

Warning light	Warning light/Details	Correction procedure
	<p><b>Master warning light</b> A buzzer sounds and the warning light comes on and flashes to indicate that the master warning system has detected a malfunction.</p>	<p>→P. 481</p>

**\*1: Open door warning buzzer:**

→P. 484

**\*2: Driver's and front passenger's seat belt reminders buzzer:**

The driver's and front passenger's seat belts reminder sounds to alert the driver and front passenger that his or her seat belt is not fastened. The buzzer sounds intermittently for 10 seconds after the vehicle has reached a speed of at least 12 mph (20 km/h). Then, if the seat belt is still unfastened, the buzzer will sound in a different tone for 20 more seconds.

### ■ If the malfunction indicator lamp comes on while driving

First check the following:

- Is the fuel tank empty?  
If it is, fill the fuel tank immediately.
- Is the fuel tank cap loose?  
If it is, tighten it securely.

The lamp will go off after taking several driving trips.

If the lamp does not go off even after several trips, contact your Lexus dealer as soon as possible.

### ■ Electric power steering warning light

When the battery is low or when the voltage drops temporarily, the electric power steering warning light may come on.

### ■ Front passenger detection sensor and passenger seat belt reminder and warning buzzer

- If luggage is placed on the front passenger seat, the front passenger detection sensor may cause the warning light to flash and the warning buzzer to sound, even if a passenger is not sitting in the seat.
- If a cushion is placed on the seat, the sensor may not detect a passenger, and the warning light may not operate properly.

### ■ When the tire pressure warning light comes on

Check the tire inflation pressure and adjust to the appropriate level. Pressing the satellite switch does not turn off the tire pressure warning light.

### ■ The tire pressure warning light may turn on due to natural causes

The tire pressure warning light may turn on due to natural causes such as natural air leaks or tire inflation pressure changes caused by temperature. In this case, adjusting the tire inflation pressure will turn off the warning light (after a few minutes).

### ■ When a tire is replaced with a spare tire

The compact spare tire is not equipped with the tire pressure warning valve and transmitter. If a tire goes flat, the tire pressure warning light will not turn off even though the flat tire is replaced with the spare tire. Replace the spare tire with the repaired tire and adjust the proper tire inflation pressure. The tire pressure warning light will turn off after a few minutes.

### ■ If the tire pressure warning system is inoperative

The tire pressure warning system will be disabled in the following conditions:  
(When the condition becomes normal, the system will work properly.)

- If tires not equipped with tire pressure warning valves and transmitters are used
- If the ID code on the tire pressure warning valves and transmitters is not registered in the tire pressure warning computer
- If a different set of tires has been selected using the satellite switch
- If the tire inflation pressure is 73 psi (500 kPa, 5.1 kgf/cm<sup>2</sup> or bar) or higher

The tire pressure warning system may be disabled in the following conditions:  
(When the condition becomes normal, the system will work properly.)

- If electronic devices or facilities using similar radio wave frequencies are nearby
- If a radio set at similar frequencies is in use in the vehicle
- If there is a lot of snow or ice on the vehicle, in particular around the wheels or wheel housings
- If non-genuine Lexus wheels are used (Even if you use Lexus wheels, the tire pressure warning system may not work properly with some types of tires.)
- If tire chains are used

### ■ If the tire pressure warning light frequently comes on after blinking for 1 minute

If the tire pressure warning light frequently comes on after blinking for 1 minute when the “ENGINE START STOP” switch is turned to IGNITION ON mode, have it checked by your Lexus dealer.

### ■ Customization that can be configured at Lexus dealer

The vehicle speed linked seat belt reminder buzzer can be disabled.  
(Customizable features →P. 553)

 **CAUTION**

■ **When the electric power steering warning light comes on**

The steering wheel may become extremely heavy.

If the steering wheel becomes heavier than usual when operating, firmly hold and operate it using more force than usual.

■ **If the tire pressure warning light comes on**

Be sure to observe the following precautions. Failure to do so could cause loss of vehicle control and result in death or serious injury.

- Stop your vehicle in a safe place as soon as possible. Adjust the tire inflation pressure immediately.
- If the tire pressure warning light comes on even after tire inflation pressure adjustment, it is probable that you have a flat tire. Check the tires. If the tire is flat, change to the spare tire and have the flat tire repaired by the nearest Lexus dealer.
- Avoid abrupt maneuvering and braking. If the vehicle tires deteriorate, you could lose control of the steering wheel or the brakes.

■ **If a blowout or sudden air leakage should occur**

The tire pressure warning system may not activate immediately.

 **CAUTION****■ Maintenance of the tires**

Each tire, including the spare (if provided), should be checked monthly when cold and inflated to the inflation pressure recommended by the vehicle manufacturer on the vehicle placard or tire inflation pressure label (tire and load information label). (If your vehicle has tires of a different size than the size indicated on the vehicle placard or tire inflation pressure label [tire and load information label], you should determine the proper tire inflation pressure for those tires.)

As an added safety feature, your vehicle has been equipped with a tire pressure monitoring system (TPMS-tire pressure warning system) that illuminates a low tire pressure telltale (tire pressure warning light) when one or more of your tires is significantly under-inflated. Accordingly, when the low tire pressure telltale (tire pressure warning light) illuminates, you should stop and check your tires as soon as possible, and inflate them to the proper pressure. Driving on a significantly under-inflated tire causes the tire to overheat and can lead to tire failure. Under-inflation also reduces fuel efficiency and tire tread life, and may affect the vehicle's handling and stopping ability.

Please note that the TPMS (tire pressure warning system) is not a substitute for proper tire maintenance, and it is the driver's responsibility to maintain correct tire pressure, even if under-inflation has not reached the level to trigger illumination of the TPMS low tire pressure telltale (tire pressure warning light).

Your vehicle has also been equipped with a TPMS (tire pressure warning system) malfunction indicator to indicate when the system is not operating properly. The TPMS (tire pressure warning system) malfunction indicator is combined with the low tire pressure telltale (tire pressure warning light). When the system detects a malfunction, the telltale will flash for approximately one minute and then remain continuously illuminated. This sequence will continue upon subsequent vehicle start-ups as long as the malfunction exists. When the malfunction indicator is illuminated, the system may not be able to detect or signal low tire pressure as intended.

TPMS (tire pressure warning system) malfunctions may occur for a variety of reasons, including the installation of replacement or alternate tires or wheels on the vehicle that prevent the TPMS (tire pressure warning system) from functioning properly. Always check the TPMS (tire pressure warning system) malfunction telltale after replacing one or more tires or wheels on your vehicle to ensure that the replacement or alternate tires and wheels allow the TPMS (tire pressure warning system) to continue to function properly.

 NOTICE

■ **Precaution when installing a different tire**

When a tire of a different specification or maker is installed, the tire pressure warning system may not operate properly.



## 5-2. Steps to take in an emergency If a warning message is displayed

If a warning is shown on the multi-information display, stay calm and perform the following actions:



### 1 Master warning light



The master warning light also comes on or flashes in order to indicate that a message is currently being displayed on the multi-information display.

### 2 Multi-information display

If any of the warning lights turns on again after performing the following actions, contact your Lexus dealer.







### Stop the vehicle immediately.



A buzzer sounds and a warning message is shown on the multi-information display. The following warning indicates the possibility of damage to the vehicle that may lead to an accident. Immediately stop the vehicle in a safe place and contact your Lexus dealer.

Warning message	Details
 <p>(for U.S.A.)</p>  <p>(for Canada)</p>  <p>(Flashing)</p>	<p><b>Indicates an abnormal engine oil pressure.</b></p> <p>The warning light may turn on if the engine oil pressure is too low.</p>

**Have the vehicle inspected by your Lexus dealer immediately.**







A buzzer sounds and a warning message is shown on the multi-information display. Failing to investigate the cause of the following warnings may lead to the system operating abnormally and possibly cause an accident. Have the vehicle inspected by your Lexus dealer immediately.





Warning message	Details
  (If equipped)	<p>Indicates a malfunction in the AWD system.</p>
  (Flashing)	<p>Indicates a malfunction in the steering lock system.</p>
  (If equipped)	<p>Indicates intuitive parking assist malfunction. The malfunctioning assist-sensor is shown flashing on the display.</p>

Warning message	Details
 <p>CHECK HEADLIGHT SYSTEM</p>  <p>(If equipped)</p>	<p>Indicates a malfunction in the headlight leveling system.</p>



**Follow the correction procedures.**



A buzzer sounds and a warning message is shown on the multi-information display. After taking the specified steps to correct the suspected problem, check that the warning message turns off.

Warning message	Details	Correction procedure
 RIGHT FRONT DOOR  LEFT FRONT DOOR  RIGHT REAR DOOR  LEFT REAR DOOR	<p><b>Indicates that one or more of the doors is not fully closed.</b></p> <p>The system also indicates which doors are not fully closed.</p>  flashes and a buzzer sounds to indicate that one or more of the doors is not fully closed (with the vehicle having reached a speed of 3 mph [5 km/h]).	<p>Make sure that all of the doors are closed.</p>
 HOOD OPEN	<p><b>Indicates that the hood is not fully closed.</b></p>  flashes and a buzzer sounds to indicate that hood is not fully closed (with the vehicle having reached a speed of 3 mph [5 km/h]).	<p>Close the hood.</p>

Warning message	Details	Correction procedure
	<p>Indicates that the trunk is not fully closed.</p> <p> flashes and a buzzer sounds to indicate that trunk is not fully closed (with the vehicle having reached a speed of 3 mph [5 km/h]).</p>	<p>Close the trunk.</p>
<p>MOONROOF OPEN</p> <p> (Flashing) (If equipped)</p>	<p>Indicates that the moon roof is not fully closed (with the “ENGINE START STOP” switch OFF and the driver’s door opened).</p>	<p>Close the moon roof.</p>
<p>PARK BRAKE</p>	<p>Indicates that the parking brake is still engaged.</p> <p> flashes and a buzzer sounds to indicate that the parking brake is still engaged (with the vehicle having reached a speed of 3 mph [5 km/h]).</p>	<p>Release the parking brake.</p>
<p>LOW WASHER FLUID</p> <p></p>	<p>Indicates that the washer fluid level is low.</p>	<p>Add washer fluid.</p>

## 5-2. Steps to take in an emergency





Warning message	Details	Correction procedure
<div data-bbox="78 266 338 396" style="background-color: #0056b3; color: white; padding: 10px; text-align: center;"> <p>LOW ENGINE OIL LEVEL</p> </div> <div data-bbox="82 409 174 470" style="text-align: center;">  </div>	<p>Indicates that engine oil level is low.</p>	<p>Check the level of engine oil, and add if necessary.</p>
<div data-bbox="78 565 338 695" style="background-color: #0056b3; color: white; padding: 10px; text-align: center;"> <p>OIL MAINT REQD SOON</p> </div> <div data-bbox="82 708 174 769" style="text-align: center;">  </div> <p data-bbox="136 769 274 802">(U.S.A. only)</p>	<p>Indicates that all maintenance according to the driven distance on the maintenance schedule* should be performed soon.</p> <p>Comes on approximately 4500 miles (7200 km) after the maintenance data has been reset.</p>	<p>If necessary, perform maintenance.</p>
<div data-bbox="78 1026 338 1156" style="background-color: #0056b3; color: white; padding: 10px; text-align: center;"> <p>OIL MAINT REQD</p> </div> <div data-bbox="82 1169 174 1230" style="text-align: center;">  </div> <p data-bbox="136 1230 274 1263">(U.S.A. only)</p>	<p>Indicates that all maintenance is required to correspond to the driven distance on the maintenance schedule*.</p> <p>Comes on approximately 5000 miles (8000 km) after the maintenance data has been reset. (The indicator will not work properly unless the maintenance data has been reset.)</p>	<p>Perform the necessary maintenance. Please reset the maintenance data after the maintenance is performed (→P. 386)</p>

Warning message	Details	Correction procedure
  (If equipped)	<p>Indicates that intuitive parking assist is dirty or covered with ice.</p>	<p>Clean the sensor.</p>







\*: Refer to the separate “Scheduled Maintenance” or “Owner’s Manual Supplement” for the maintenance interval applicable to your vehicle.

**Follow the correction procedures.**





After taking the specified steps to correct the suspected problem, check that the warning light turns off.

Interior buzzer	Exterior buzzer	Warning message	Details	Correction procedure
Once	—	 <p>(Comes on for 10 seconds.)</p>  (Flashing)	Indicates that an attempt was made to start the engine without the electronic key being present, or the electronic key was not functioning normally.	Start the engine with the electronic key <sup>*</sup> present.
Once	3 times	  (Flashing)	Indicates that a door other than the driver's door has been opened or closed with the "ENGINE START STOP" switch in any mode other than OFF and the electronic key outside of the detection area.	Confirm the location of the electronic key.



Interior buzzer	Exterior buzzer	Warning message	Details	Correction procedure
Once	3 times	 <p>(Vehicles with an automatic transmission)</p>  (Flashing)	Indicates that the driver's door has been opened or closed with the shift lever in P, the "ENGINE START STOP" switch in any mode other than OFF and the electronic key outside of the detection area.	Turn the "ENGINE START STOP" switch OFF or confirm the location of the electronic key.
Once	Continuous	  <p>(Displayed alternately) (Vehicles with an automatic transmission)</p>  (Flashing)	Indicates that the driver's door has been opened or closed (with the shift lever out of in P, the "ENGINE START STOP" switch in any mode other than OFF and the electronic key outside of the detection area).	<ul style="list-style-type: none"> <li>• Shift the shift lever to P.</li> <li>• Confirm the location of the electronic key.</li> </ul>
Once	—	  (Flashing)	Indicates that the key battery is low.	Replace the battery. (→P. 433)

## 5-2. Steps to take in an emergency

Interior buzzer	Exterior buzzer	Warning message	Details	Correction procedure
Once	—	 <p>(Vehicles with an automatic transmission)</p>	Indicates that a door has been opened or closed and the “ENGINE START STOP” switch has been switched twice to ACCESSORY mode from OFF.	Press the “ENGINE START STOP” switch while applying the brakes.
Once	—	 <p>(Vehicles with a manual transmission)</p>	Indicates that a door has been opened or closed and the “ENGINE START STOP” switch has been switched twice to ACCESSORY mode from OFF.	Press the “ENGINE START STOP” switch while depressing the clutch pedal.
—	—	  (Flashing)	Indicates that the steering lock has not released within 3 seconds of pressing the “ENGINE START STOP” switch.	Press the “ENGINE START STOP” switch again while turning the steering wheel with the brake pedal depressed.

Interior buzzer	Exterior buzzer	Warning message	Details	Correction procedure
Once	—	<p><b>DEPRESS THE BRAKE PEDAL, AND TOUCH THE ENGINE SWITCH WITH THE KEY</b></p> <p>(Vehicles with an automatic transmission)</p>	Indicates that the electronic key does not operate properly.	→P. 507
—	—	<p><b>TO START, DEPRESS THE BRAKE PEDAL, AND PUSH THE ENGINE SWITCH</b></p> <p>(Vehicles with an automatic transmission)</p>		
Once	—	<p><b>DEPRESS THE CLUTCH PEDAL, AND TOUCH THE ENGINE SWITCH WITH THE KEY</b></p> <p>(Vehicles with a manual transmission)</p>	Indicates that the electronic key does not operate properly.	→P. 507
—	—	<p><b>TO START, DEPRESS THE CLUTCH PEDAL, AND PUSH THE ENGINE SWITCH</b></p> <p>(Vehicles with a manual transmission)</p>		

\*: If the engine does not start when the electronic key is inside the vehicle, the electronic key battery may be depleted or there may be difficulties receiving the signal from the key. (→P. 37)

## 5-2. Steps to take in an emergency If you have a flat tire

Remove the flat tire and replace it with the spare provided.

### ■ Before jacking up the vehicle

- Stop the vehicle on a hard, flat surface.
- Set the parking brake.
- Shift the shift lever to P (vehicles with an automatic transmission) or R (vehicles with a manual transmission).
- Stop the engine.
- Turn on the emergency flashers.

### ■ Location of the spare tire, jack and tools

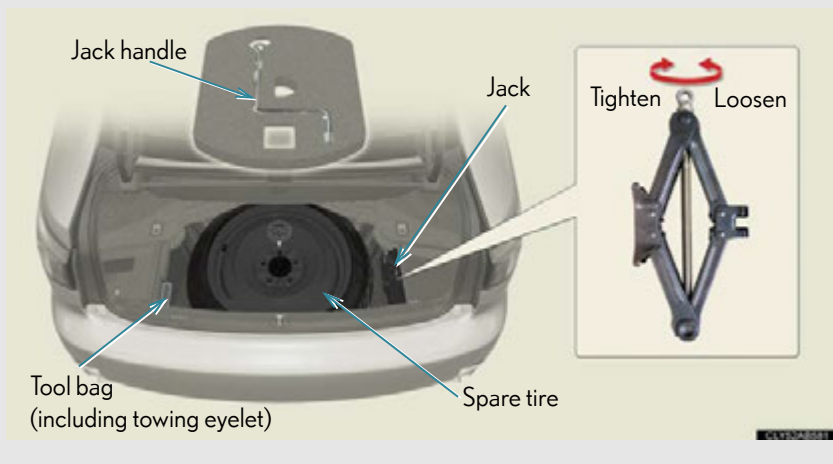

## Taking out the spare tire

STEP 1



Lift up the hook of the panel on the trunk floor.

STEP 2

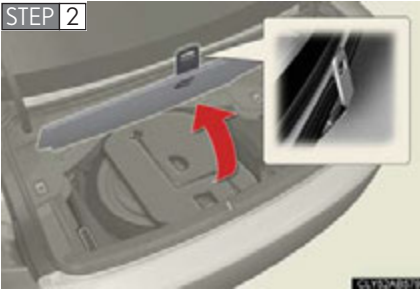

Secure the panel using the hook provided.

STEP 3

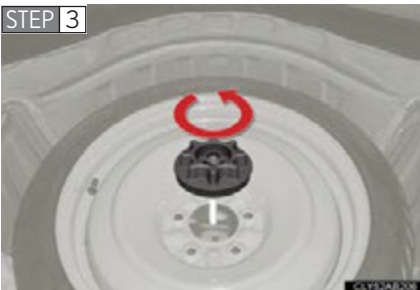

Loosen the center fastener that secures the spare tire.

## Replacing a flat tire

STEP 1



Chock the tires.

Flat tire		Wheel chock positions
Front	Left-hand side	Behind the rear right-hand side tire
	Right-hand side	Behind the rear left-hand side tire
Rear	Left-hand side	In front of the front right-hand side tire
	Right-hand side	In front of the front left-hand side tire

STEP 2

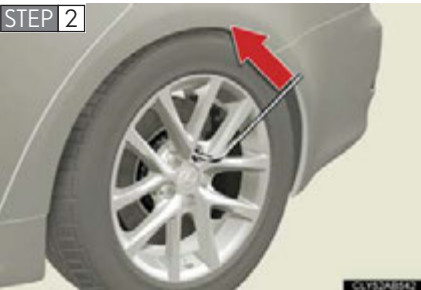

Slightly loosen the wheel nuts (one turn).

STEP 3



Turn the tire jack portion "A" by hand until the notch of the jack is in contact with the jack point.



Raise the vehicle until the tire is slightly raised off the ground.



Remove all the wheel nuts and the tire.

When resting the tire on the ground, place the tire so that the wheel design faces up to avoid scratching the wheel surface.

### Installing the spare tire

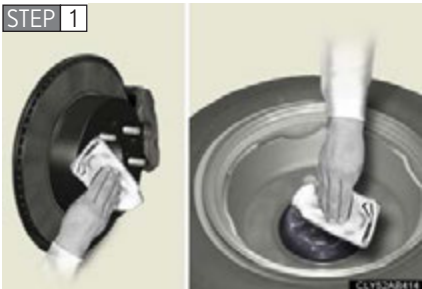

Remove any dirt or foreign matter from the wheel contact surface.

If foreign matter is on the wheel contact surface, the wheel nuts may loosen while the vehicle is in motion, and the tire may come off the vehicle.

## 5-2. Steps to take in an emergency

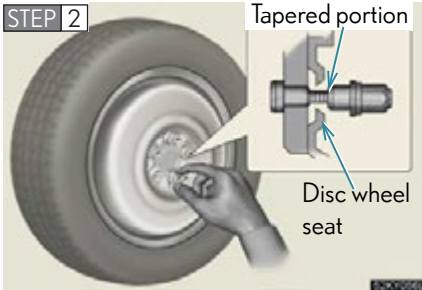

Install the spare tire and loosely tighten each nut by hand to approximately the same amount.

Tighten the wheel nuts until the tapered portion comes into loose contact with the disc wheel seat.



Lower the vehicle.

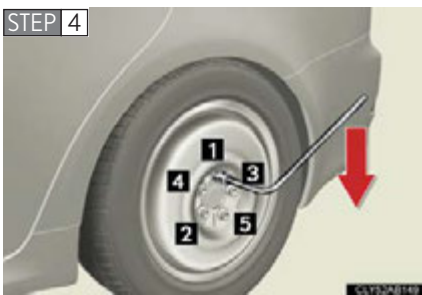

Firmly tighten each nut two or three times in the order shown in the illustration.

**Tightening torque:**  
76 ft•lbf (103 N•m, 10.5 kgf•m)

STEP 5] Stow the flat tire, tire jack and all tools.

### ■ The compact spare tire

- The compact spare tire is identified by the label "TEMPORARY USE ONLY" on the tire sidewall.  
Use the compact spare tire temporarily only in an emergency.
- Make sure to check the tire pressure of the compact spare tire. (→P. 531)



### ■ When using the compact spare tire

As the compact spare tire is not equipped with the tire pressure warning valve and transmitter, low inflation pressure of the spare tire will not be indicated. Also, if you replace the compact spare tire after the tire pressure warning light comes on, the light remains on.

### ■ If you have a flat rear tire on a road covered with snow or ice

Install the compact spare tire on the front of the vehicle. Perform the following steps and fit tire chains to the rear tires.

**STEP 1** Replace a front tire with the compact spare tire.

**STEP 2** Replace the flat rear tire with the tire removed from the front of the vehicle.

**STEP 3** Fit tire chains to the rear tires.

### ■ After completing the tire change

The tire pressure warning system must be reset. (→P. 414)

## CAUTION

### ■ Using the tire jack

Improper use of the tire jack may lead to death or serious injuries due to the vehicle suddenly falling off the jack.

- Do not use the tire jack for any purpose other than replacing tires or installing and removing tire chains.
- Only use the tire jack that comes with this vehicle for replacing a flat tire. Do not use it on other vehicles, and do not use other tire jacks for replacing tires on this vehicle.
- Always check that the tire jack is securely set to the jack point.
- Do not put any part of your body under the vehicle while it is supported by a jack.
- Do not start or run the engine while your vehicle is supported by the jack.
- Do not raise the vehicle while someone is in it.
- When raising the vehicle, do not put an object on or under the jack.
- Do not raise the vehicle to a height greater than that required to replace the tire.

### CAUTION

- Use a jack stand if it is necessary to get under the vehicle.

Take particular care when lowering the vehicle to ensure that no one working on or near the vehicle may be injured.

#### ■ Replacing a flat tire

- Do not attach a heavily damaged wheel ornament, as it may fly off the wheel while the vehicle is moving.
- Failure to follow these precautions could cause the wheel nuts to loosen and the tire to fall off, resulting in death or serious injury.
  - Never use oil or grease on the wheel bolts or wheel nuts.  
Oil and grease may cause the wheel nuts to be excessively tightened, leading to bolt or disc wheel damage. In addition, the oil or grease can cause the wheel nuts to loosen and the wheel may fall off, causing a serious accident. Remove any oil or grease from the wheel bolts or wheel nuts.
  - Have the wheel nuts tightened with a torque wrench to 76 ft•lbf (103 N•m, 10.5 kgf•m) as soon as possible after changing wheels.

#### ■ When using the spare tire

- Remember that your compact spare tire is specifically designed for use with your vehicle. Do not use your compact spare tire on another vehicle.
- Do not use two compact spare tires simultaneously.
- Replace the compact spare tire with a standard tire as soon as possible.
- Avoid sudden acceleration, deceleration and braking, as well as sharp cornering.

#### ■ Speed limit when using the spare tire

Do not drive at speeds in excess of 50 mph (80 km/h) when a compact spare tire is installed on the vehicle.

The compact spare tire is not designed for driving at high speeds. Failing to observe this precaution may lead to an accident causing death or serious injury.

 **CAUTION****■ When the spare tire is attached**

The vehicle speed may not be correctly detected, and the following systems may not operate correctly:

- ABS & brake assist
- VSC
- TRAC
- EPS
- VDIM
- Navigation system (if equipped)
- Intuitive parking assist (if equipped)
- Cruise control

Also, not only can the following system not be utilized fully, it may actually negatively effect the drive-train components:

- AWD system (if equipped)

 NOTICE

■ **Do not drive the vehicle with a flat tire.**

Do not continue driving with a flat tire.

Driving even a short distance with a flat tire can damage the tire and the wheel beyond repair.

■ **Be careful when driving over bumps with the compact spare tire installed on the vehicle.**

The vehicle becomes lower when driving with the compact spare tire compared to when driving with standard tires. Be careful when driving over uneven road surfaces.

■ **Driving with tire chains and the compact spare tire**

Do not fit tire chains to the compact spare tire.

Tire chains may damage the vehicle body and adversely affect driving performance.

■ **When replacing the tires**

When removing or fitting the wheels, tires or the tire pressure warning valve and transmitter, contact your Lexus dealer as the tire pressure warning valve and transmitter may be damaged if not handled correctly.

■ **To avoid damage to the tire pressure warning valves and transmitters**

When a tire is repaired with liquid sealants, the tire pressure warning valve and transmitter may not operate properly. If a liquid sealant is used, contact your Lexus dealer or other qualified service shop as soon as possible. Make sure to replace the tire pressure warning valve and transmitter when replacing the tire. (→P. 414)

## 5-2. Steps to take in an emergency

### If the engine will not start

If the engine will not start even though correct starting procedures are being followed (→P. 141), consider each of the following points.

■ **The engine will not start even when the starter motor operates normally.**

One of the following may be the cause of the problem.

- There may not be sufficient fuel in the vehicle's tank.

Refuel the vehicle.

- The engine may be flooded.

Try to restart the engine once more following correct starting procedures. (→P. 141)

- There may be a malfunction in the engine immobilizer system.

(→P. 90)

■ **The starter motor turns over slowly, the interior lights and headlights are dim, or the horn does not sound or sounds at a low volume.**

One of the following may be the cause of the problem.

- The battery may be discharged. (→P. 510)

- The battery terminal connections may be loose or corroded.

■ **The starter motor does not turn over, the interior lights and headlights do not turn on, or the horn does not sound.**

One of the following may be the cause of the problem.

- One or both of the battery terminals may be disconnected.

- The battery may be discharged. (→P. 510)

- There may be a malfunction in the steering lock system.

Contact your Lexus dealer if the problem cannot be repaired, or if repair procedures are unknown.

## Emergency start function

When the engine does not start, the following steps can be used as an interim measure to start the engine if the “ENGINE START STOP” switch is functioning normally.

▶ Vehicles with an automatic transmission

**STEP 1** Set the parking brake.

**STEP 2** Put the shift lever in P.

**STEP 3** Set the “ENGINE START STOP” switch to ACCESSORY mode.

**STEP 4** Press and hold the “ENGINE START STOP” switch for about 15 seconds while depressing the brake pedal firmly.

▶ Vehicles with a manual transmission

**STEP 1** Set the parking brake.

**STEP 2** Put the shift lever in N.

**STEP 3** Set the “ENGINE START STOP” switch to the ACCESSORY mode.

**STEP 4** Push and hold the “ENGINE START STOP” switch for about 15 seconds while depressing the brake pedal and clutch pedal firmly.

Even if the engine can be started using the above steps, the system may be malfunctioning. Have the vehicle checked by your Lexus dealer.

## 5-2. Steps to take in an emergency

### If the shift lever cannot be shifted from P\*

If the shift lever cannot be shifted with your foot on the brake, there may be a problem with the shift lock system (a system to prevent accidental operation of the shift lever). Have the vehicle inspected by your Lexus dealer immediately.

The following steps may be used as an emergency measure to ensure that the shift lever can be shifted.

**STEP 1** Set the parking brake.

**STEP 2** Turn the “ENGINE START STOP” switch to ACCESSORY mode.

**STEP 3** Depress the brake pedal.

**STEP 4**



Pry the cover up with a flathead screwdriver or equivalent.

**STEP 5**



Press the shift lock override button.

The shift lever can be shifted while the button is pressed.

## 5-2. Steps to take in an emergency

### If you lose your keys

New genuine Lexus keys can be made by your Lexus dealer using the other key and the key number stamped on your key number plate.



## 5-2. Steps to take in an emergency

### If the electronic key does not operate properly

If communication between the electronic key and vehicle is interrupted (→P. 37) or the electronic key cannot be used because the battery is depleted, the smart access system with push-button start and wireless remote control cannot be used. In such cases, the doors and trunk can be opened or the engine can be started by following the procedure below.

#### Locking and unlocking the doors, unlocking the trunk and key linked functions

Use the mechanical key built in to the electronic keys to operate the doors. (→P. 29)

##### ► Doors



Remove the cover on the driver's door handle.

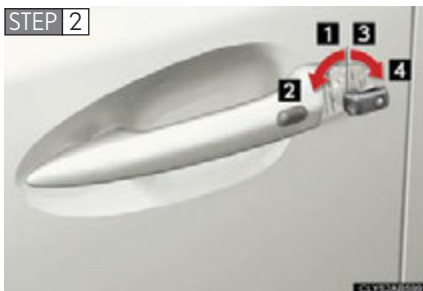

- 1 Locks all the doors
- 2 Closes the windows and moon roof (turn and hold)
- 3 Unlocks the door

Turning the key rearward unlocks the driver's door. Turning the key once again unlocks the other doors.

- 4 Opens the windows and moon roof (turn and hold)

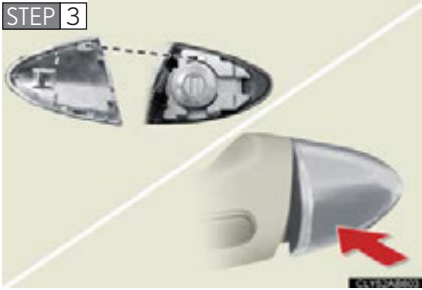

After the operation is completed, reinstall the cover.

Hook the upper claw of the cover onto the upper catch on the vehicle side, and then push on the lower side of the cover.

Make sure that the lower claw of the cover is securely fastened to the lower catch on the vehicle side. If the cover is not securely attached, it may fall off while driving.

► Trunk



Turn the mechanical key clockwise to open.

## Changing “ENGINE START STOP” switch modes and starting the engine

### ► Automatic transmission

**STEP 1** Shift the shift lever to P and apply the brakes.

**STEP 2**



Touch the Lexus emblem side of the electronic key to the “ENGINE START STOP” switch.

An alarm will sound to indicate that the start function cannot detect the electronic key that is touched to the “ENGINE START STOP” switch if any of the doors is opened and closed while the key is touched to the switch.



**STEP 3** To change “ENGINE START STOP” switch modes: Within 10 seconds of the buzzer sounding, release the brake pedal and press the “ENGINE START STOP” switch. Modes can be changed each time the switch is pressed.

(→P. 141)

To start the engine: Press the “ENGINE START STOP” switch within 10 seconds after the buzzer sounds, keeping the brake pedal depressed.

► Manual transmission

**STEP 1** Shift the shift lever to N and depress the clutch pedal.



Touch the Lexus emblem side of the electronic key to the “ENGINE START STOP” switch.

An alarm will sound to indicate that the start function cannot detect the electronic key that is touched to the “ENGINE START STOP” switch if any of the doors is opened and closed while the key is touched to the switch.



**STEP 3** To change “ENGINE START STOP” switch modes: Within 10 seconds of the buzzer sounding, release the clutch pedal and press the “ENGINE START STOP” switch. Modes can be changed each time the switch is pressed.

(→P. 141)

To start the engine: Press the “ENGINE START STOP” switch within 10 seconds after the buzzer sounds, keeping the clutch pedal depressed.

In the event that the engine still cannot be started, contact your Lexus dealer.

---

### ■ Stopping the engine

For vehicles with an automatic transmission: Shift the shift lever to P and press the “ENGINE START STOP” switch as you normally do when stopping the engine.

For vehicles with a manual transmission: Shift the shift lever to N position and press the “ENGINE START STOP” switch as you normally do when stopping the engine.

### ■ Replacing the key battery

As the above procedure is a temporary measure, it is recommended that the electronic key battery be replaced immediately when the battery depletes.  
(→P. 433)

## 5-2. Steps to take in an emergency

### If the vehicle battery is discharged

The following procedures may be used to start the engine if the vehicle's battery is discharged.

You can call your Lexus dealer or a qualified repair shop.

If you have a set of jumper (or booster) cables and a second vehicle with a 12-volt battery, you can jump start your Lexus following the steps below.

**STEP 1** Remove the engine compartment covers. (→P. 399)

**STEP 2** Connecting the jumper cables.

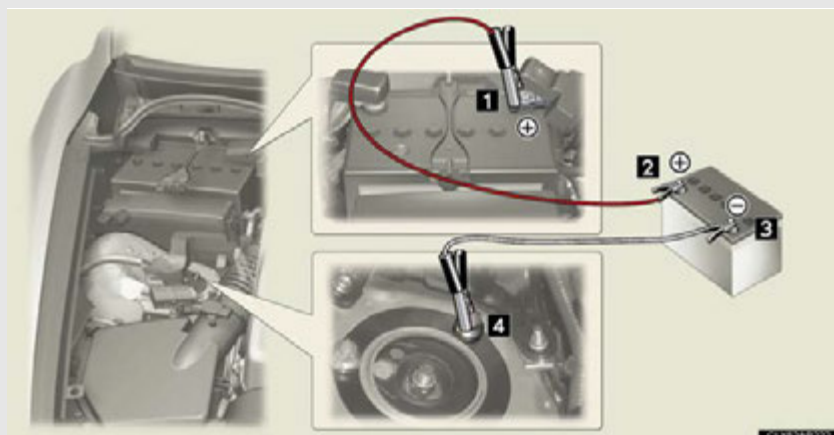

- 1** Positive (+) battery terminal on your vehicle
- 2** Positive (+) battery terminal on the second vehicle
- 3** Negative (-) battery terminal on the second vehicle
- 4** Connect the jumper cable to ground on your vehicle as shown in the illustration.

**STEP 3** Start the engine of the second vehicle. Increase the engine speed slightly and maintain at that level for approximately 5 minutes to recharge the battery of your vehicle.

**STEP 4** Open and close any of the doors with the “ENGINE START STOP” switch OFF.

**STEP 5** Maintain the engine speed of the second vehicle and turn the “ENGINE START STOP” switch to IGNITION ON mode, then start the vehicle’s engine.

**STEP 6** Once the vehicle’s engine has started, remove the jumper cables in the exact reverse order in which they were connected.

Once the engine starts, have the vehicle checked at your Lexus dealer as soon as possible.

### ■ Avoiding a discharged battery

- Turn off the headlights and the audio system while the engine is off.
- Turn off any unnecessary electrical components when the vehicle is running at a low speed for an extended period, such as in heavy traffic, etc.

### ■ Charging the battery

The electricity stored in the battery will discharge gradually even when the vehicle is not in use, due to natural discharge and the draining effects of certain electrical appliances. If the vehicle is left for a long time, the battery may discharge, and the engine may be unable to start. (The battery recharges automatically during driving.)

## CAUTION

### ■ Avoiding battery fires or explosions

Observe the following precautions to prevent accidentally igniting the flammable gas that may be emitted from the battery.

- Make sure the jumper cable is connected to the correct terminal and that it is not unintentionally in contact with any part other than the intended terminal.
- Do not allow the jumper cables to come into contact with the “+” and “-” terminals.
- Do not allow open flame or use matches, cigarette lighters or smoke near the battery.

 **CAUTION**

**■ Battery precautions**

The battery contains poisonous and corrosive acidic electrolyte, while related parts contain lead and lead compounds. Observe the following precautions when handling the battery.

- When working with the battery, always wear safety glasses and take care not to allow any battery fluids (acid) to come into contact with skin, clothing or the vehicle body.
- Do not lean over the battery.
- In the event that battery fluid comes into contact with the skin or eyes, immediately wash the affected area with water and seek medical attention.  
Place a wet sponge or cloth over the affected area until medical attention can be received.
- Always wash your hands after handling the battery support, terminals, and other battery-related parts.
- Do not allow children near the battery.

 **NOTICE**

**■ To prevent damaging the vehicle**

Do not pull- or push-start the vehicle, because the three-way catalytic converter may overheat and become a fire hazard.

**■ When handling jumper cables**

Be careful that the jumper cables do not become tangled in the cooling fan or any of the belts when connecting or disconnecting them.



## 5-2. Steps to take in an emergency If your vehicle overheats

### If your engine overheats:

**STEP 1** Stop the vehicle in a safe place and turn off the automatic air conditioning system.

**STEP 2** Check to see if steam is coming out from under the hood.

If you see steam:

Stop the engine. Carefully lift the hood after the steam subsides and then restart the engine.

If you do not see steam:

Leave the engine running and carefully lift the hood.

**STEP 3** Check to see if the cooling fans are operating.

If the fans are operating:

Wait until the temperature of the engine (shown on the instrument cluster) begins to fall and then stop the engine.

If the fans are not operating:

Stop the engine immediately and call your local Lexus dealer.

**STEP 4**

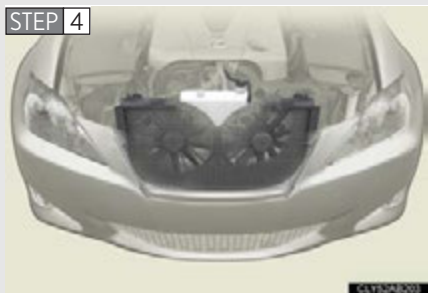

After the engine has cooled down sufficiently, check the engine coolant level and inspect the radiator core (radiator) for any leaks.

If the engine compartment cover needs to be removed:  
→P. 399

STEP 5



Add engine coolant if required.

Water can be used in an emergency if engine coolant is unavailable. (→P. 527)

Have the vehicle checked at your nearest Lexus dealer as soon as possible.

### ■ Overheating

If you observe the following, your vehicle may be overheating.

- The engine coolant temperature gauge enters the red zone or a loss of power is experienced.
- Steam is coming from under the hood.

### ⚠ CAUTION

#### ■ To prevent an accident or injury when inspecting under the hood of your vehicle

- If steam is seen coming from under the hood, do not open the hood until the steam has subsided. The engine compartment may be very hot, causing serious injury such as burns.
- Keep hands and clothing away from the fans and other belts while the engine is running.
- Do not loosen the radiator cap while the engine and radiator are hot. Serious injury, such as burns, may result from hot coolant and steam released under pressure.

 NOTICE**■ When adding engine coolant**

Wait until the engine has cooled down before adding engine coolant.

When adding coolant, do so slowly. Adding cool coolant to a hot engine too quickly can cause damage to the engine.

## 5-2. Steps to take in an emergency If the vehicle becomes stuck

Carry out the following procedures if the tires spin or the vehicle becomes stuck in mud, dirt, or snow.

**STEP 1** Stop the engine. Set the parking brake and shift the shift lever to P (vehicles with an automatic transmission) or N (vehicles with a manual transmission).

**STEP 2** Remove the mud, snow, or sand from around the stuck tire.

**STEP 3** Place wood, stones or some other material to help provide traction under the tires.

**STEP 4** Restart the engine.

**STEP 5** Shift the shift lever to the D or R position (vehicles with an automatic transmission) or 1 or R position (vehicles with a manual transmission), release the parking brake and carefully apply the accelerator to free the vehicle.

Turn off TRAC and VSC if these functions are hampering your attempts to free the vehicle. (→ P.198)

### CAUTION

#### ■ When attempting to free a stuck vehicle

If you choose to rock the vehicle back and forth to free it, make sure the surrounding area is clear, to avoid striking other vehicles, objects or persons. The vehicle may also lunge forward or lunge back suddenly as it becomes free. Use extreme caution.

#### ■ When shifting the shift lever

With automatic transmission vehicles, be careful not to shift the shift lever with the accelerator pedal depressed.

This may lead to unexpected rapid acceleration of the vehicle that may cause an accident and result in death or serious injury.

 NOTICE**■ To avoid damaging the transmission and other components**

- Avoid spinning the wheels and do not rev the engine.
- If the vehicle remains stuck after trying these procedures, the vehicle may require towing to be freed.

## 5-2. Steps to take in an emergency

### If your vehicle has to be stopped in an emergency

Only in an emergency, such as if it becomes impossible to stop the vehicle in the normal way, stop the vehicle using the following procedure:

**STEP 1** Steadily step on the brake pedal with both feet and firmly depress it.

Do not pump the brake pedal repeatedly as this will increase the effort required to slow the vehicle.

**STEP 2** Shift the shift lever to N.

► If the shift lever is shifted to N

**STEP 3** After slowing down, stop the vehicle in a safe place by the road.

**STEP 4** Stop the engine.

► If the shift lever cannot be shifted to N

**STEP 3** Keep depressing the brake pedal with both feet to reduce vehicle speed as much as possible.

**STEP 4**



Press and hold for 3 seconds or more

Stop the engine by pressing and holding the “ENGINE START STOP” switch for 3 consecutive seconds or more.

**STEP 5** Stop the vehicle in a safe place by the road.

#### CAUTION

##### If the engine has to be turned off while driving

Power assist for the brakes and steering wheel will be lost, making the brake pedal harder to depress and the steering wheel heavier to turn. Decelerate as much as possible before turning off the engine.

## Vehicle specifications

# 6

### **6-1. Specifications**

Maintenance data (fuel, oil level, etc.) .....	520
Fuel information.....	537
Tire information.....	541

### **6-2. Customization**

Customizable features .....	553
-----------------------------	-----

### **6-3. Initialization**

Items to initialize .....	559
---------------------------	-----

## 6-1. Specifications

### Maintenance data (fuel, oil level, etc.)

#### Dimensions and weight

Overall length		180.3 in. (4580 mm)
Overall width		70.9 in. (1800 mm)
Overall height *1	2WD models	56.1 in. (1425 mm)
	AWD models	56.7 in. (1440 mm)
Wheelbase		107.4 in. (2730 mm)
Tread	Front	60.4 in. (1535 mm)
	Rear	60.0 in. (1525 mm)*2 60.4 in. (1535 mm)*3
Vehicle capacity weight (Occupants + luggage)		825 lb. (375 kg)

\*1: Unladen vehicle

\*2: Vehicle with 18-inch tires

\*3: Vehicle with tires other than the above on rear wheels



## Vehicle identification

### ■ Vehicle identification number

The vehicle identification number (VIN) is the legal identifier for your vehicle. This is the primary identification number for your Lexus. It is used in registering the ownership of your vehicle.

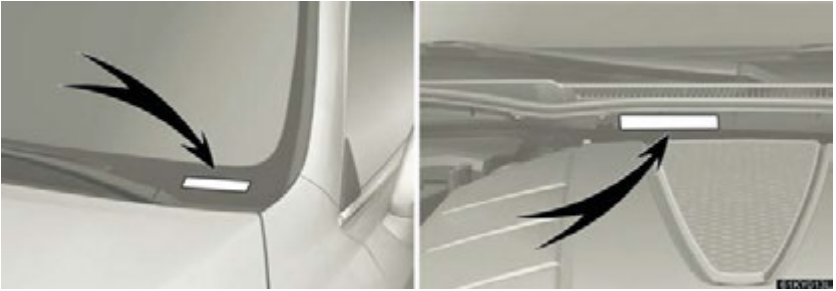

This number is stamped on the top left of the instrument panel and in the engine compartment.



This number is also on the Certification Label.

■ Engine number

The engine number is stamped on the engine block as shown.



**Engine**

	IS250	IS350
Model	4GR-FSE	2GR-FSE
Type	6-cylinder V type, 4-cycle, gasoline	6-cylinder V type, 4-cycle, gasoline
Bore and stroke	3.27 × 3.03 in. (83.0 × 77.0 mm)	3.70 × 3.27 in. (94.0 × 83.0 mm)
Displacement	152.5 cu.in. (2500 cm <sup>3</sup> )	210.9 cu.in. (3456 cm <sup>3</sup> )
Drive belt tension	Automatic adjustment	

**Fuel**

Fuel type	Unleaded gasoline only
Octane rating	91 (Research octane number 96) or higher
Fuel tank capacity (Reference)	17.2 gal. (65 L, 14.3 Imp. gal.)

**Lubrication system**

Oil capacity  
(Drain and refill —  
reference\*)

without filter

2WD models	6.2 qt. (5.9 L, 5.2 Imp. qt.)
AWD models	6.3 qt. (6.0 L, 5.3 Imp. qt.)

with filter

2WD models	6.6 qt. (6.3 L, 5.5 Imp. qt.)
AWD models	6.7 qt. (6.4 L, 5.6 Imp. qt.)

\*: The engine oil capacity is a reference quantity to be used when changing the engine oil. Warm up and turn off the engine, wait more than 5 minutes, and check the oil level on the dipstick.

► IS250

■ Engine oil selection

“Toyota Genuine Motor Oil” is used in your Lexus vehicle. Use Lexus approved “Toyota Genuine Motor Oil” or equivalent to satisfy the following grade and viscosity.

Oil grade: ILSAC multigrade engine oil

Recommended viscosity: SAE 0W-20

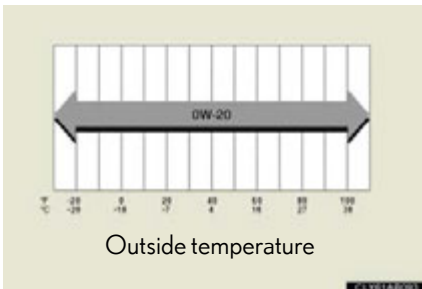

SAE 0W-20 is the best choice for good fuel economy and good starting in cold weather.

If SAE 0W-20 is not available, SAE 5W-20 oil may be used. However, it must be replaced with SAE 0W-20 at the next oil change.

Oil viscosity (0W-20 is explained here as an example):

- The 0W in 0W-20 indicates the characteristic of the oil which allows cold startability. Oils with a lower value before the W allow for easier starting of the engine in cold weather.
- The 20 in 0W-20 indicates the viscosity characteristic of the oil when the oil is at high temperature. An oil with a higher viscosity (one with a higher value) may be better suited if the vehicle is operated at high speeds, or under extreme load conditions.

How to read oil container label:

The ILSAC (International Lubricant Standardization and Approval Committee) Certification Mark is added to some oil containers to help you select the oil you should use.



## ► IS350

### ■ Engine oil selection

“Toyota Genuine Motor Oil” is used in your Lexus vehicle. Use Lexus approved “Toyota Genuine Motor Oil” or equivalent to satisfy the following grade and viscosity.

Oil grade: ILSAC multigrade engine oil

Recommended viscosity: SAE 5W-30

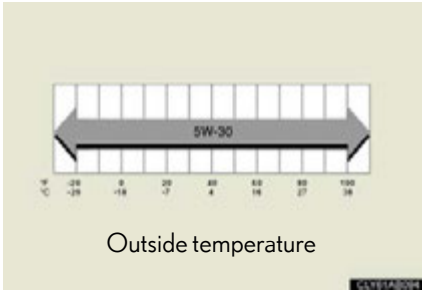

SAE 5W-30 is the best choice for good fuel economy and good starting in cold weather.

If SAE 5W-30 is not available, SAE 10W-30 oil may be used. However, it should be replaced with SAE 5W-30 at the next oil change.

Oil viscosity (5W-30 is explained here as an example):

- The 5W in 5W-30 indicates the characteristic of the oil which allows cold startability. Oils with a lower value before the W allow for easier starting of the engine in cold weather.
- The 30 in 5W-30 indicates the viscosity characteristic of the oil when the oil is at high temperature. An oil with a higher viscosity (one with a higher value) may be better suited if the vehicle is operated at high speeds, or under extreme load conditions.

How to read oil container label:

The ILSAC (International Lubricant Standardization and Approval Committee) Certification Mark is added to some oil containers to help you select the oil you should use.



## Cooling system

Capacity	<ul style="list-style-type: none"> <li>▶ IS350 9.6 qt. (9.1 L, 8.0 Imp. qt.)</li> <li>▶ IS250 10.9 qt. (10.3 L, 9.1 Imp. qt.)</li> </ul>
Coolant type	<p>Use either of the following.</p> <ul style="list-style-type: none"> <li>• “Toyota Super Long Life Coolant”</li> <li>• Similar high-quality ethylene glycol-based non-silicate, non-amine, non-nitrite, and non-borate coolant with long-life hybrid organic acid technology</li> </ul> <p>Do not use plain water alone.</p>

## Ignition system

Spark plug	DENSO FK20HBR11
Make	
Gap	

### NOTICE

#### ■ Iridium-tipped spark plugs

Use only iridium-tipped spark plugs. Do not adjust gap when tuning the engine.

## Electrical system

Battery	
Open voltage* at 68°F (20°C):	12.6 — 12.8 V Fully charged 12.2 — 12.4 V Half charged 11.8 — 12.0 V Discharged (*: Voltage checked 20 minutes after the engine and all the lights are turned off)
Charging rates	5 A max.

## Differential

### ► Front

Oil capacity	0.74 qt. (0.70 L, 0.61 Imp. qt.)
Oil type	Hypoid gear oil API GL-5
Oil viscosity	Above 0°F (-18°C): SAE90 Below 0°F (-18°C): SAE80W or SAE80W-90

### ► Rear

Oil capacity	IS350: 1.42 qt. (1.35 L, 1.19 Imp. qt.) IS250: 1.20 qt. (1.15 L, 1.01 Imp. qt.)
Oil type and viscosity*	Toyota Genuine Differential Gear Oil LT 75W-85 GL-5 or equivalent

\*: Your Lexus vehicle is filled with "Toyota Genuine Differential Gear Oil" at the factory. Use Lexus approved "Toyota Genuine Differential Gear Oil" or an equivalent of matching quality to satisfy the above specification. Please contact your Lexus dealer for further details.



## Automatic Transmission

Fluid capacity*	
IS350 (2WD)	8.3 qt. (7.9 L, 6.9 Imp. qt.)
IS350 (AWD)	10.5 qt. (10.0 L, 8.8 Imp. qt.)
IS250 (2WD)	7.9 qt. (7.5 L, 6.5 Imp. qt.)
IS250 (AWD)	9.9 qt. (9.4 L, 8.2 Imp. qt.)
Fluid type	Toyota Genuine ATF WS

\*: The fluid capacity is provided as a reference. If replacement is necessary, contact your Lexus dealer.

### NOTICE

Using automatic transmission fluid other than “Toyota Genuine ATF WS” may cause deterioration in shift quality, locking up of your transmission accompanied by vibration, and ultimately damage the automatic transmission of your vehicle.

## Manual Transmission

Gear oil capacity	1.9 qt. (1.8 L, 1.6 Imp. qt.)
Gear oil type	API GL-5
Recommended gear oil viscosity	SAE75W-90

## Clutch

Clutch free play	0.2 — 0.6 in. (5 — 15 mm)
Fluid type	SAE J1703 or FMVSS No.116 DOT 3

## Brakes

Pedal clearance <sup>*1</sup> IS 350 IS 250 Manual transmission Automatic transmission	4.13 in. (105 mm) Min. 4.09 in. (104 mm) Min. 4.3 in. (108 mm) Min.
Pedal free play	0.04 — 0.08 in. (1.0 — 2.0 mm)
Brake pad wear limit	0.04 in. (1.0 mm)
Parking brake lining wear limit	0.04 in. (1.0 mm)
Parking brake pedal travel <sup>*2</sup> / lever travel <sup>*3</sup> Pedal type Lever type	7 — 9 clicks 5 — 7 clicks
Fluid type	SAE J1703 or FMVSS No. 116 DOT 3

\*1: Minimum pedal clearance when depressed with a force of 110 lbf (490 N, 50 kgf) while the engine is running.

\*2: Parking brake pedal travel when depressed with a force of 67.4 lbf (300 N, 30.6 kgf).

\*3: Parking brake lever travel when pulled up with a force of 45.0 lbf (200 N, 20.4 kgf).

## Steering

Free play	Less than 1.2 in. (30 mm)
-----------	---------------------------

## Tires and wheels

### ■ Tires and wheels (except for compact spare)

#### ▶ Type A

Tire size	205/55R16 89W
Front and rear tire inflation pressure (Recommended cold tire inflation pressure)	<p>Driving under normal conditions</p> <p>Front: 35 psi (240 kPa, 2.4 kgf/cm<sup>2</sup> or bar)*</p> <p>Rear: 38 psi (260 kPa, 2.6 kgf/cm<sup>2</sup> or bar)*</p> <p>*: When driving at high speeds above 100 mph (160 km/h), in countries where such speeds are permitted by law, add 5.8 psi (40 kPa, 0.4 kgf/cm<sup>2</sup> or bar) to the front tires and rear tires. Never exceed the maximum cold tire inflation pressure indicated on the tire sidewall.</p>
Wheel size	16 × 7JJ
Wheel nut torque	76 ft•lbf (103 N•m, 10.5 kgf•m)

► Type B

Tire size	225/45R17 91V
Front and rear tire inflation pressure (Recommended cold tire inflation pressure)	<p>Driving under normal conditions</p> <p>Front: 35 psi (240 kPa, 2.4 kgf/cm<sup>2</sup> or bar)*</p> <p>Rear: 38 psi (260 kPa, 2.6 kgf/cm<sup>2</sup> or bar)*</p> <p>*: When driving at high speeds above 100 mph (160 km/h), in countries where such speeds are permitted by law, add 7.2 psi (50 kPa, 0.5 kgf/cm<sup>2</sup> or bar) to the front tires and rear tires. Never exceed the maximum cold tire inflation pressure indicated on the tire sidewall.</p>
Wheel size	17 × 8J
Wheel nut torque	76 ft•lbf (103 N•m, 10.5 kgf•m)

## ► Type C

Tire size	Front tires: 225/45R17 91V Rear tires: 245/45R17 95V
Front and rear tire inflation pressure (Recommended cold tire inflation pressure)	Driving under normal conditions Front: 35 psi (240 kPa, 2.4 kgf/cm <sup>2</sup> or bar)* Rear: 38 psi (260 kPa, 2.6 kgf/cm <sup>2</sup> or bar)* *: When driving at high speeds above 100 mph (160 km/h), in countries where such speeds are permitted by law, add 10 psi (70 kPa, 0.7 kgf/cm <sup>2</sup> or bar) to the front tires and rear tires. Never exceed the maximum cold tire inflation pressure indicated on the tire sidewall.
Wheel size	17 × 8J
Wheel nut torque	76 ft•lbf (103 N•m, 10.5 kgf•m)

► Type D

Tire size	Front tires: 225/40R18 88Y Rear tires: 255/40R18 95Y
Front and rear tire inflation pressure (Recommended cold tire inflation pressure)	Driving under normal conditions Front: 35 psi (240 kPa, 2.4 kgf/cm <sup>2</sup> or bar)* Rear: 38 psi (260 kPa, 2.6 kgf/cm <sup>2</sup> or bar)* *: When driving at high speeds above 100 mph (160 km/h), in countries where such speeds are permitted by law, add 7.2 psi (50 kPa, 0.5 kgf/cm <sup>2</sup> or bar) to the front tires and rear tires. Never exceed the maximum cold tire inflation pressure indicated on the tire sidewall.
Wheel size	Front wheels: 18 × 8J Rear wheels: 18 × 8 1/2J
Wheel nut torque	76 ft•lbf (103 N•m, 10.5 kgf•m)

## ► Type E

Tire size	Front tires: 225/40R18 88W Rear tires: 255/40R18 95W
Front and rear tire inflation pressure (Recommended cold tire inflation pressure)	Driving under normal conditions Front: 35 psi (240 kPa, 2.4 kgf/cm <sup>2</sup> or bar)* Rear: 38 psi (260 kPa, 2.6 kgf/cm <sup>2</sup> or bar)* *: When driving at high speeds above 100 mph (160 km/h), in countries where such speeds are permitted by law, add 7.2 psi (50 kPa, 0.5 kgf/cm <sup>2</sup> or bar) to the front tires and rear tires. Never exceed the maximum cold tire inflation pressure indicated on the tire sidewall.
Wheel size	Front wheels: 18 × 8J Rear wheels: 18 × 8 1/2J
Wheel nut torque	76 ft•lbf (103 N•m, 10.5 kgf•m)

## ■ Compact spare tire

Tire size	► Type A T125/70D17 98M ► Type B T145/70D17 106M
Tire inflation pressure (Recommended cold tire inflation pressure)	60 psi (420 kPa, 4.2 kgf/cm <sup>2</sup> or bar)
Wheel size	17 × 4T

**Light bulbs**

	Light Bulbs	Bulb No.	W	Type
Exterior	Headlights High beam	9005	60	D
	Low/high beam (discharge bulbs)	D4S	35	A
	Low beam (halogen bulbs)	H11	55	B
	Front turn signal lights	—	21	C
	Parking lights (vehicles with halogen headlights)	168	5	E
	Front fog lights	H11	55	B
	Rear turn signal lights	7440	21	E
	Back-up lights	921	16	E
Interior	Outer foot lights	—	5	E
	Vanity lights	—	8	E
	Trunk light	—	5	F
	Interior lights Front	—	5	E
	Rear	—	3	F
	Overhead courtesy lights	—	3	F
Front door courtesy lights	—	5	E	

- A: D4S discharge bulbs
- B: H11 halogen bulbs
- C: Wedge base bulbs (amber)
- D: HB3 halogen bulbs
- E: Wedge base bulbs (clear)
- F: Double end bulbs



## 6-1. Specifications

# Fuel information

Your vehicle must use only unleaded gasoline.

### ► IS250

Premium unleaded gasoline with an octane rating of 91 (Research Octane Number 96) or higher required for optimum engine performance. If 91 octane cannot be obtained, you may use unleaded gasoline with an octane rating as low as 87 (Research Octane Number 91). Use of unleaded gasoline with an octane rating lower than 91 may result in engine knocking. Persistent knocking can lead to engine damage and should be corrected by refueling with higher octane unleaded gasoline.

### ► IS350

Premium unleaded gasoline with an octane rating of 91 (Research Octane Number 96) or higher required for optimum engine performance. If 91 octane cannot be obtained, you may use unleaded gasoline with an octane rating as low as 87 (Research Octane Number 91). Use of unleaded gasoline with an octane rating lower than 91 may result in engine knocking and significantly reduced performance. Persistent knocking can lead to engine damage and should be corrected by refueling with higher octane unleaded gasoline.

At minimum, the gasoline you use should meet the specifications of ASTM D4814 in the U.S.A. and CGSB3.5-M93 in Canada.

### ■ Fuel tank opening for unleaded gasoline

To help prevent incorrect fueling, your Lexus has a fuel tank opening that only accommodates the special nozzle on unleaded fuel pumps.

### ■ If your engine knocks

- Consult your Lexus dealer.
- You may occasionally notice light knocking for a short time while accelerating or driving uphill. This is normal and there is no need for concern.

### ■ Gasoline quality

In very few cases, driveability problems may be caused by the brand of gasoline you are using. If driveability problems persist, try changing the brand of gasoline. If this does not correct the problem, consult your Lexus dealer.

### ■ Gasoline quality standards

- Automotive manufacturers in the US, Europe and Japan have developed a specification for fuel quality called World-Wide Fuel Charter (WWFC) that is expected to be applied worldwide.
- The WWFC consists of four categories that are based on required emission levels. In the US, category 4 has been adopted.
- The WWFC improves air quality by lowering emissions in vehicle fleets, and customer satisfaction through better performance.

### ■ Lexus recommends the use of gasoline containing detergent additives

- Lexus recommends the use of gasoline that contains detergent additives to avoid build-up of engine deposits.
- All gasoline sold in the US contains detergent additives to clean and/or keep clean intake systems.

### ■ Lexus recommends the use of cleaner burning gasoline

Cleaner burning gasoline, including reformulated gasoline that contains oxygenates such as ethanol or MTBE (Methyl Tertiary Butyl Ether) is available in many areas.

Lexus recommends the use of cleaner burning gasoline and appropriately blended reformulated gasoline. These types of gasoline provide excellent vehicle performance, reduce vehicle emissions and improve air quality.

### ■ Lexus does not recommend blended gasoline

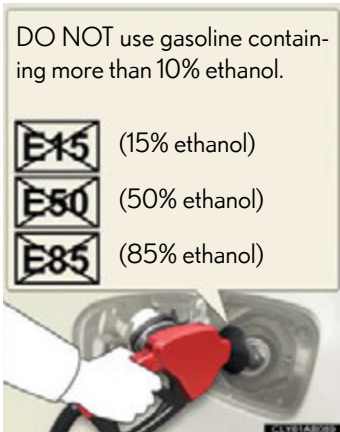

- Use only gasoline containing a maximum of 10% ethanol.

DO NOT use any flex-fuel or gasoline that could contain more than 10% ethanol, including from any pump labeled E15, E30, E50, E85 (which are only some examples of fuel containing more than 10% ethanol).

- If you use gasohol in your Lexus, be sure that it has an octane rating no lower than 87.
- Lexus DOES NOT recommend the use of gasoline containing methanol.

### ■ Lexus does not recommend gasoline containing MMT

Some gasoline contains octane enhancing additive called MMT (Methylcyclopentadienyl Manganese Tricarbonyl).

Lexus DOES NOT recommend the use of gasoline that contains MMT. If fuel containing MMT is used, your emission control system may be adversely affected.

The malfunction indicator lamp on the instrument cluster may come on. If this happens, contact your Lexus dealer for service.

### NOTICE

#### ■ Notice on fuel quality

- Do not use improper fuels. If improper fuels are used the engine will be damaged.
- Do not use leaded gasoline.  
Leaded gasoline can cause damage to your vehicle's three-way catalytic converters causing the emission control system to malfunction.
- Do not use gasohol other than that stated here.  
Other gasohol may cause fuel system damage or vehicle performance problems.
- IS250: Use of unleaded gasoline with an octane rating lower than 91 may result in engine knocking. Persistent knocking can lead to engine damage and should be corrected by refueling with higher octane unleaded gasoline.
- IS350: Use of unleaded gasoline with an octane rating lower than 91 may result in engine knocking and significantly reduced performance. Persistent knocking can lead to engine damage and should be corrected by refueling with higher octane unleaded gasoline.

#### ■ Fuel-related poor driveability

If after using a different type of fuel, poor driveability is encountered (poor hot starting, vaporization, engine knocking, etc.), discontinue the use of that type of fuel.

#### ■ When refueling with gasohol

Take care not to spill gasohol. It can damage your vehicle's paint.

## 6-1. Specifications

# Tire information

### Typical tire symbols

#### ► Standard tire



#### ► Compact spare tire



- 1** Tire size (→P. 543)
- 2** DOT and Tire Identification Number (TIN) (→P. 543)
- 3** Location of treadwear indicators (→P. 412)
- 4** Tire ply composition and materials

Plies are layers of rubber-coated parallel cords. Cords are the strands which form the plies in a tire.

### 5 Radial tires or bias-ply tires

A radial tire has “RADIAL” on the sidewall. A tire not marked “RADIAL” is a bias-ply tire.

### 6 TUBELESS or TUBE TYPE

A tubeless tire does not have a tube and air is directly filled in the tire. A tube type tire has a tube inside the tire and the tube maintains the air pressure.

### 7 Load limit at maximum cold tire inflation pressure (→P. 419)

### 8 Maximum cold tire inflation pressure (→P. 531)

This means the pressure to which a tire may be inflated.

### 9 Uniform tire quality grading

For details, see “Uniform Tire Quality Grading” that follows.

### 10 Summer tire or all season tire (→P. 419)

An all season tire has “M+S” on the sidewall. A tire not marked “M+S” is a summer tire.

### 11 “TEMPORARY USE ONLY” (→P. 496)

A compact spare tire is identified by the phrase “TEMPORARY USE ONLY” molded into its sidewall. This tire is designed for temporary emergency use only.

## Typical DOT and tire identification number (TIN)

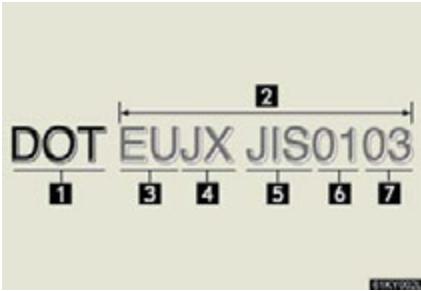

- 1 DOT symbol\*
- 2 Tire Identification Number (TIN)
- 3 Tire manufacturer's identification mark
- 4 Tire size code
- 5 Manufacturer's optional tire type code (3 or 4 letters)
- 6 Manufacturing week
- 7 Manufacturing year

\*:The DOT symbol certifies that the tire conforms to applicable Federal Motor Vehicle Safety Standards.

## Tire size

### Typical tire size information

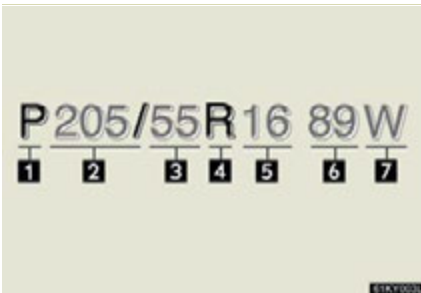

The illustration indicates typical tire size.

- 1 Tire use  
(P = Passenger car,  
T = Temporary use)
- 2 Section width (millimeters)
- 3 Aspect ratio  
(tire height to section width)
- 4 Tire construction code  
(R = Radial, D = Diagonal)
- 5 Wheel diameter (inches)
- 6 Load index (2 or 3 digits)
- 7 Speed symbol  
(alphabet with one letter)

### Tire dimensions



- 1 Section width
- 2 Tire height
- 3 Wheel diameter

### Tire section names

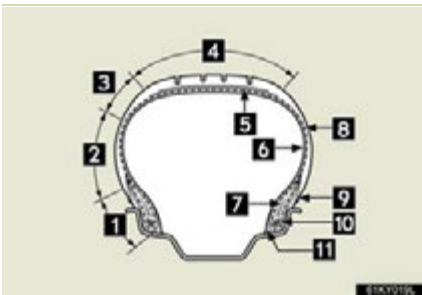

- 1 Bead
- 2 Sidewall
- 3 Shoulder
- 4 Tread
- 5 Belt
- 6 Inner liner
- 7 Reinforcing rubber
- 8 Carcass
- 9 Rim lines
- 10 Bead wires
- 11 Chafer

### Uniform Tire Quality Grading

This information has been prepared in accordance with regulations issued by the National Highway Traffic Safety Administration of the U.S. Department of Transportation.

It provides the purchasers and/or prospective purchasers of Lexus vehicles with information on uniform tire quality grading.

Your Lexus dealer will help answer any questions you may have as you read this information.



## ■ DOT quality grades

All passenger vehicle tires must conform to Federal Safety Requirements in addition to these grades. Quality grades can be found where applicable on the tire sidewall between tread shoulder and maximum section width.

For example: Treadwear 200 Traction AA Temperature A

## ■ Treadwear

The treadwear grade is a comparative rating based on the wear rate of the tire when tested under controlled conditions on a specified government test course.

For example, a tire graded 150 would wear one and a half (1 - 1/2) times as well on the government course as a tire graded 100.

The relative performance of tires depends upon the actual conditions of their use, however, and may depart significantly from the norm due to variations in driving habits, service practices and differences in road characteristics and climate.

## ■ Traction AA, A, B, C

The traction grades, from highest to lowest, are AA, A, B and C, and they represent the tire's ability to stop on wet pavement as measured under controlled conditions on specified government test surfaces of asphalt and concrete.

A tire marked C may have poor traction performance.

Warning: The traction grade assigned to this tire is based on braking (straight ahead) traction tests and does not include cornering (turning) traction.

### ■ Temperature A, B, C

The temperature grades are A (the highest), B, and C, representing the tire's resistance to the generation of heat and its ability to dissipate heat when tested under controlled conditions on a specified indoor laboratory test wheel.

Sustained high temperature can cause the material of the tire to degenerate and reduce tire life, and excessive temperature can lead to sudden tire failure.

The grade C corresponds to a level of performance which all passenger car tires must meet under the Federal Motor Vehicle Safety Standard No. 109.

Grades B and A represent higher levels of performance on the laboratory test wheel than the minimum required by law.

**Warning:** The temperature grades for this tire are established for a tire that is properly inflated and not overloaded.

Excessive speed, underinflation, or excessive loading, either separately or in combination, can cause heat buildup and possible tire failure.

### Glossary of tire terminology

Tire related term	Meaning
Accessory weight	The combined weight (in excess of those standard items which may be replaced) of automatic transmission, power steering, power brakes, power windows, power seats, radio and heater, to the extent that these items are available as factory-installed equipment (whether installed or not)
Cold tire inflation pressure	Tire pressure when the vehicle has been parked for three hours or more, or has not been driven more than 1 mile or 1.5 km under that condition
Curb weight	The weight of a motor vehicle with standard equipment, including the maximum capacity of fuel, oil and coolant, and if so equipped, air conditioning and additional weight optional engine

Tire related term	Meaning
Maximum inflation pressure	The maximum cold inflated pressure to which a tire may be inflated, shown on the sidewall of the tire
Maximum loaded vehicle weight	The sum of: (a) Curb weight (b) Accessory weight (c) Vehicle capacity weight (d) Production options weight
Normal occupant weight	150 lb. (68 kg) times the number of occupants specified in the second column of Table 1* that follows
Production options weight	The combined weight of installed regular production options weighing over 5 lb. (2.3 kg) in excess of the standard items which they replace, not previously considered in curb weight or accessory weight, including heavy duty brakes, ride levelers, roof rack, heavy duty battery, and special trim
Vehicle capacity weight (Total load capacity)	The rated cargo and luggage load plus 150 lb. (68 kg) times the vehicle's designated seating capacity
Occupant distribution	Distribution of occupants in a vehicle as specified in the third column of Table 1* below
Recommended inflation pressure	Cold tire inflation pressure recommended by a manufacturer.
Rim	A metal support for a tire or a tire and tube assembly upon which the tire beads are seated
Rim diameter (Wheel diameter)	Nominal diameter of the bead seat
Rim size designation	Rim diameter and width
Rim type designation	The industry manufacturer's designation for a rim by style or code

Tire related term	Meaning
Rim width	Nominal distance between rim flanges
Vehicle maximum load on the tire	The load on an individual tire that is determined by distributing to each axle its share of the maximum loaded vehicle weight, and dividing by two
Vehicle normal load on the tire	The load on an individual tire that is determined by distributing to each axle its share of curb weight, accessory weight, and normal occupant weight (distributed in accordance with Table 1* below), and dividing by two
Weather side	The surface area of the rim not covered by the inflated tire

Tire related term	Meaning
Bead	The part of the tire that is made of steel wires, wrapped or reinforced by ply cords and that is shaped to fit the rim
Bead separation	A breakdown of the bond between components in the bead
Bias ply tire	A pneumatic tire in which the ply cords that extend to the beads are laid at alternate angles substantially less than 90 degrees to the centerline of the tread
Carcass	The tire structure, except tread and sidewall rubber which, when inflated, bears the load
Chunking	The breaking away of pieces of the tread or sidewall
Cord	The strands forming the plies in the tire
Cord separation	The parting of cords from adjacent rubber compounds
Cracking	Any parting within the tread, sidewall, or innerliner of the tire extending to cord material
CT	A pneumatic tire with an inverted flange tire and rim system in which the rim is designed with rim flanges pointed radially inward and the tire is designed to fit on the underside of the rim in a manner that encloses the rim flanges inside the air cavity of the tire
Extra load tire	A tire designed to operate at higher loads and at higher inflation pressures than the corresponding standard tire
Groove	The space between two adjacent tread ribs
Innerliner	The layer(s) forming the inside surface of a tubeless tire that contains the inflating medium within the tire
Innerliner separation	The parting of the innerliner from cord material in the carcass

Tire related term	Meaning
Intended outboard sidewall	(a) The sidewall that contains a whitewall, bears white lettering, or bears manufacturer, brand, and/or model name molding that is higher or deeper than the same molding on the other sidewall of the tire, or (b) The outward facing sidewall of an asymmetrical tire that has a particular side that must always face outward when mounted on a vehicle
Light truck (LT) tire	A tire designated by its manufacturer as primarily intended for use on lightweight trucks or multipurpose passenger vehicles
Load rating	The maximum load that a tire is rated to carry for a given inflation pressure
Maximum load rating	The load rating for a tire at the maximum permissible inflation pressure for that tire
Maximum permissible inflation pressure	The maximum cold inflation pressure to which a tire may be inflated
Measuring rim	The rim on which a tire is fitted for physical dimension requirements
Open splice	Any parting at any junction of tread, sidewall, or innerliner that extends to cord material
Outer diameter	The overall diameter of an inflated new tire
Overall width	The linear distance between the exteriors of the sidewalls of an inflated tire, including elevations due to labeling, decorations, or protective bands or ribs
Passenger car tire	A tire intended for use on passenger cars, multipurpose passenger vehicles, and trucks, that have a gross vehicle weight rating (GVWR) of 10000 lb. or less.
Ply	A layer of rubber-coated parallel cords

Tire related term	Meaning
Ply separation	A parting of rubber compound between adjacent plies
Pneumatic tire	A mechanical device made of rubber, chemicals, fabric and steel or other materials, that, when mounted on an automotive wheel, provides the traction and contains the gas or fluid that sustains the load
Radial ply tire	A pneumatic tire in which the ply cords that extend to the beads are laid at substantially 90 degrees to the centerline of the tread
Reinforced tire	A tire designed to operate at higher loads and at higher inflation pressures than the corresponding standard tire
Section width	The linear distance between the exteriors of the sidewalls of an inflated tire, excluding elevations due to labeling, decoration, or protective bands
Sidewall	That portion of a tire between the tread and bead
Sidewall separation	The parting of the rubber compound from the cord material in the sidewall
Snow tire	A tire that attains a traction index equal to or greater than 110, compared to the ASTM E-1136 Standard Reference Test Tire, when using the snow traction test as described in ASTM F-1805-00, Standard Test Method for Single Wheel Driving Traction in a Straight Line on Snow- and Ice-Covered Surfaces, and which is marked with an Alpine Symbol (  ) on at least one sidewall
Test rim	The rim on which a tire is fitted for testing, and may be any rim listed as appropriate for use with that tire
Tread	That portion of a tire that comes into contact with the road

Tire related term	Meaning
Tread rib	A tread section running circumferentially around a tire
Tread separation	Pulling away of the tread from the tire carcass
Treadwear indicators (TWI)	The projections within the principal grooves designed to give a visual indication of the degrees of wear of the tread
Wheel-holding fixture	The fixture used to hold the wheel and tire assembly securely during testing

\*: Table 1 — Occupant loading and distribution for vehicle normal load for various designated seating capacities

Designated seating capacity, Number of occupants	Vehicle normal load, Number of occupants	Occupant distribution in a normally loaded vehicle
2 through 4	2	2 in front
5 through 10	3	2 in front, 1 in second seat
11 through 15	5	2 in front, 1 in second seat, 1 in third seat, 1 in fourth seat
16 through 20	7	2 in front, 2 in second seat, 2 in third seat, 1 in fourth seat



## 6-2. Customization

### Customizable features

Your vehicle includes a variety of electronic features that can be personalized to your preferences. Programming these preferences requires specialized equipment and may be performed by an authorized Lexus dealership.

Some function settings are changed simultaneously with other functions being customized. Contact your Lexus dealer for further details.

Item	Function	Default setting	Customized setting
Smart access system with push-button start (→P. 33)	Operation signal (Emergency flashers)	On	Off
	Operation signal (Buzzer)	On	Off
Wireless remote control (→P. 45)	Unlocking operation	Driver's door unlocked in one step, all doors unlocked in two steps	All doors unlocked in one step
	Automatic door lock function to be activated if door is not opened after being unlocked	On	Off

Item	Function	Default setting	Customized setting
Wireless remote control (→P. 45)	Time elapsed before automatic door lock function is activated if door is not opened after being unlocked	60 seconds	30 seconds
			120 seconds
	Operation signal (Emergency flashers)	On	Off
	Operation signal (Buzzer)	On	Off
	Door lock buzzer	On	Off
	Trunk unlocking function	On	Off
	Trunk unlocking operation	Push and hold	Push twice
			One short push
Panic function	On	Off	

Item	Function	Default setting	Customized setting
Door lock (→P. 48)	Unlocking using a key	Driver's door unlocked in one step, all doors unlocked in two steps	All doors unlocked in one step
	Speed-detecting automatic door lock function (Manual transmissions)	On	Off
	Speed-detecting automatic door lock function (Automatic transmissions)	Off	On
	Opening driver's door unlocks all doors (Manual transmissions)	On	Off
	Opening driver's door unlocks all doors (Automatic transmissions)	Off	On
	Shifting gears to P unlocks all doors	On	Off
	Shifting gears to a position other than P locks all doors	On	Off
Steering wheel (→P. 73)	Auto tilt-away function	On	Off

Item	Function	Default setting	Customized setting
Power windows (→P. 80)	Linked door key operation	Open and close	Off
			Open only
			Close only
	Wireless remote control linked operation	Off	Open only
Moon roof (→P. 83)	Linked door key operation	Open and close	Off
			Open only
			Close only
	Linked operation of components when door key is used	Slide only	Tilt only
	Wireless remote control linked operation	Off	Open only
Linked operation of components when wireless remote control is used	Slide only	Tilt only	
Automatic light control system (→P. 172)	Light sensor sensitivity	Level 3	Level 1 to 5
	Time elapsed before headlights automatically turn off after doors are closed	30 seconds	0 seconds
			60 seconds
			90 seconds
Lights (→P. 174)	Daytime running light system (U.S.A. only)	On	Off

Item	Function	Default setting	Customized setting
Windshield wipers and washer (→P. 178)	Switching operation when the vehicle is stationary	On	Off
	Drip prevention function	On	Off
	Time elapsed before the drip prevention function operates	Variable depending on the vehicle speed	3 seconds
Intuitive parking assist (→P. 190)	Back sensor operation display and buzzer	On	Off
	Buzzer volume	Level 3	Level 1 to 5
	Distance which a sensor detects	4.9 ft. (150 cm)	2.0 ft. (60 cm)
Illumination (→P. 325)	Time elapsed before lights turn off	15 seconds	7.5 seconds
			30 seconds
	Operation when the doors are unlocked	On	Off
	Operation after the "ENGINE START STOP" switch is turned OFF	On	Off
	Front footwell lights	On	Off
	Shift lever light	On	Off
	Outer foot light	On	Off
Seat belt reminder (→P. 473)	Vehicle speed linked seat belt reminder buzzer	On	Off

**Multi-information display (→P.167)**

Country	Available languages
Canada	English and French

## 6-3. Initialization

### Items to initialize

The following items must be initialized for normal system operation in cases such as after the battery is reconnected, or maintenance is performed on the vehicle.

Item	When to initialize	Reference
Maintenance data (U.S.A. only)	After the maintenance is performed	P. 386
Tire pressure warning system	<ul style="list-style-type: none"><li>• When rotating the tires with differing front and rear tire inflation pressures.</li><li>• When changing the tire inflation pressure by changing traveling speed.</li><li>• When changing the tire size.</li></ul>	P. 413







## Reporting safety defects for U.S. owners

If you believe that your vehicle has a defect which could cause a crash or could cause injury or death, you should immediately inform the National Highway Traffic Safety Administration (NHTSA) in addition to notifying the Lexus Division of Toyota Motor Sales, U.S.A., Inc. (Toll-free: 1-800-25-LEXUS).

If NHTSA receives similar complaints, it may open an investigation, and if it finds that a safety defect exists in a group of vehicles, it may order a recall and remedy campaign. However, NHTSA cannot become involved in individual problems between you, your dealer, or Lexus Division of Toyota Motor Sales, U.S.A., Inc.

To contact NHTSA, you may call the Vehicle Safety Hotline toll-free at 1-888-327-4236 (TTY: 1-800-424-9153); go to <http://www.safercar.gov>; or write to: Administrator, NHTSA, 1200 New Jersey Ave, S.E., Washington, DC 20590. You can also obtain other information about motor vehicle safety from <http://www.safercar.gov>.

## Seat belt instructions for Canadian owners (in French)

The following is a French explanation of seat belt instructions extracted from the seat belt section in this manual.

See the seat belt section for more detailed seat belt instructions in English.

### Utilisation correcte des ceintures de sécurité



- Déroulez la sangle diagonale de telle sorte qu'elle passe bien sur l'épaule, sans pour autant être en contact avec votre cou ou glisser de votre épaule.
- Placez la sangle abdominale le plus bas possible sur les hanches.
- Réglez la position du dossier de siège. Asseyez-vous le dos le plus droit possible et calez-vous bien dans le siège.
- Ne vrillez pas la ceinture de sécurité.

### Guide de confort de ceinture de sécurité (sièges arrière extérieurs)

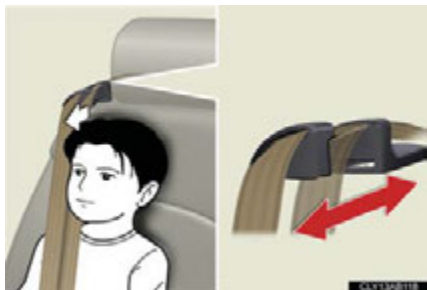

Si la sangle diagonale est proche du cou de la personne, faites coulisser le guide de confort de ceinture de sécurité vers l'avant.

## Entretien et soin

### ■ Ceintures de sécurité

Nettoyez avec un chiffon ou une éponge humectée d'eau savonneuse tiède. Profitez de l'occasion pour vérifier régulièrement que les ceintures ne sont pas effilochées, entaillées, ou ne paraissent pas exagérément usées.

### ATTENTION

#### ■ Détérioration et usure des ceintures de sécurité

Inspectez les ceintures de sécurité périodiquement. Contrôlez qu'elles ne sont pas entaillées, effilochées, et que leurs ancrages ne sont pas desserrés. N'utilisez pas une ceinture de sécurité défectueuse avant qu'elle ne soit remplacée. Une ceinture de sécurité défectueuse n'apporte aucune garantie de protection de l'occupant en cas d'accident.

## SRS airbag instructions for Canadian owners (in French)

The following is a French explanation of SRS airbag instructions extracted from the SRS airbag section in this manual.

See the SRS airbag section for more detailed SRS airbag instructions in English.



► Sacs de sécurité gonflables SRS frontaux

- 1 Sacs de sécurité gonflables SRS conducteur/passager avant  
Participent à la protection de la tête et du thorax du conducteur et du passager contre les chocs avec les éléments de l'habitacle.
- 2 Sacs de sécurité gonflables SRS de genoux  
Participent à la protection du conducteur et du passager avant.

- ▶ Sacs de sécurité gonflables SRS latéraux et rideau
- 3 Sacs de sécurité gonflables SRS latéraux  
Participent à la protection du haut du corps des occupants aux places avant.
- 4 Sacs de sécurité gonflables rideau SRS  
Participent principalement à la protection de la tête des occupants assis aux places extérieures.

## Composition du système de sacs de sécurité gonflables

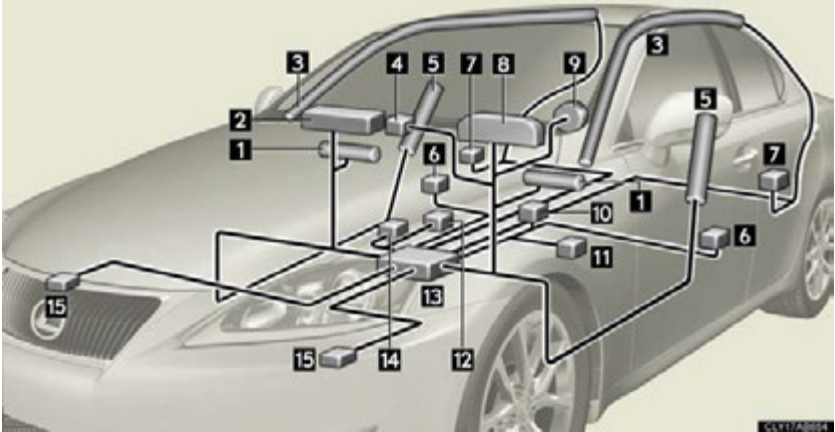

- |   |   |
|---|---|
| <b>1</b> Sacs de sécurité gonflables de genoux                      | <b>8</b> Témoin d'alerte SRS  |
| <b>2</b> Sac de sécurité gonflable passager avant                   | <b>9</b> Sac de sécurité gonflable conducteur                                     |
| <b>3</b> Sacs de sécurité gonflables rideau                         | <b>10</b> Contacteur de boucle de ceinture de sécurité conducteur                 |
| <b>4</b> Témoins indicateurs "AIR BAG ON" et "AIR BAG OFF"          | <b>11</b> Capteur de position du siège conducteur                                 |
| <b>5</b> Sacs de sécurité gonflables latéraux                       | <b>12</b> Contacteur de boucle de ceinture de sécurité passager avant             |
| <b>6</b> Capteurs de sacs de sécurité gonflables latéraux et rideau | <b>13</b> Boîtier électronique de sacs de sécurité gonflables                     |
| <b>7</b> Capteurs de sacs de sécurité gonflables rideau             | <b>14</b> Système de détection du passager (calculateur électronique et capteurs) |
|   | <b>15</b> Capteurs de sacs de sécurité gonflables frontaux                        |

Votre véhicule est équipé de SACS DE SÉCURITÉ GONFLABLES INTELLIGENTS (ADVANCED AIRBAGS) conçus selon les normes de sécurité américaines applicables aux véhicules à moteur (FMVSS208). Le système de sacs de sécurité gonflables régule la puissance de déploiement des sacs de sécurité gonflables conducteur et passager avant. Le système de sac de sécurité gonflable conducteur comprend le capteur de position du siège conducteur, etc. Le système de sac de sécurité gonflable passager avant comprend le capteur de classification des occupants du siège passager avant, etc.

Les principaux éléments du système de sacs de sécurité gonflables SRS sont illustrés ci-dessus. Le système des sacs de sécurité gonflables SRS est commandé par un boîtier électronique. Ce boîtier intègre un capteur de sécurité et un capteur de sac de sécurité gonflable.

Lorsque la violence du choc frontal ou latéral l'exige, le système de sacs de sécurité gonflables SRS déclenche les dispositifs pyrotechniques de gonflage (générateurs de gaz). Le déploiement rapide des sacs de sécurité gonflables est obtenu au moyen d'une réaction chimique dans les dispositifs pyrotechniques, qui produit un gaz inoffensif permettant d'amortir le mouvement des occupants.



## ATTENTION

### ■ Précautions avec les sacs de sécurité gonflables SRS

Respectez les précautions suivantes avec les sacs de sécurité gonflables.

À défaut, des blessures graves, voire mortelles, pourraient s'ensuivre.

- Le conducteur et tous les passagers à bord du véhicule doivent porter leur ceinture de sécurité correctement.

Les sacs de sécurité gonflables SRS sont des dispositifs de protection complémentaires aux ceintures de sécurité.

- Le sac de sécurité gonflable SRS conducteur se déploie avec une violence considérable, qui peut être très dangereuse voire mortelle si le conducteur se trouve très près du sac de sécurité gonflable. L'autorité fédérale chargée de la sécurité routière aux États-Unis, la NHTSA (National Highway Traffic Safety Administration) conseille:

La zone à risque du sac de sécurité gonflable conducteur se situant dans les premiers 2 à 3 in. (50 - 75 mm) de déploiement, vous disposez d'une marge de sécurité confortable en vous plaçant à 10 in. (250 mm) de votre sac de sécurité gonflable conducteur. Cette distance est à mesurer entre le moyeu du volant de direction et le sternum. Si vous êtes assis à moins de 10 in. (250 mm), vous pouvez changer votre position de conduite de plusieurs façons:

- Reculez votre siège le plus possible, tout en continuant à pouvoir atteindre confortablement les pédales.
- Inclinez légèrement le dossier du siège.

Bien que les véhicules puissent être différents les uns des autres, la plupart des conducteurs peuvent s'asseoir à une distance de 10 in. (250 mm), même avec le siège conducteur complètement avancé, simplement en inclinant un peu le dossier de siège. Si vous avez des difficultés à voir la route après avoir incliné votre siège, utilisez un coussin ferme et antidérapant pour vous rehausser ou, si votre véhicule est équipé du réglage en hauteur du siège, remontez-le.

- Si votre volant de direction est réglable, inclinez-le vers le bas. Cela a pour effet d'orienter le sac de sécurité gonflable en direction de votre poitrine plutôt que de votre tête et de votre cou.

Réglez votre siège selon ces recommandations de la NHTSA, tout en conservant le contrôle des pédales, du volant de direction et la vue des commandes du tableau de bord.

## ATTENTION

### ■ Précautions avec les sacs de sécurité gonflables SRS



- Si vous attachez une rallonge de ceinture de sécurité à la boucle du siège conducteur, mais pas à la ceinture de sécurité proprement dite, le système de sac de sécurité gonflable SRS conducteur pense que vous avez attaché votre ceinture de sécurité, alors qu'en fait c'est faux. Dans ce cas, il se peut que le sac de sécurité gonflable conducteur ne se déploie pas correctement en cas d'accident, et vous risquez d'être tué ou grièvement blessé. Veillez donc à porter la ceinture de sécurité avec la rallonge de ceinture de sécurité.
- Le sac de sécurité gonflable SRS passager avant se déploie également avec une violence considérable, qui peut être très dangereuse voire mortelle si le passager avant se trouve très près du sac de sécurité gonflable. Éloignez le siège passager avant au maximum du sac de sécurité gonflable, et réglez le dossier de siège de sorte à être assis bien droit dans le siège.
- Les nourrissons et les enfants qui ne sont pas correctement assis et/ou protégés peuvent être grièvement blessés ou tués par le déploiement d'un sac de sécurité gonflable. Installez dans un siège de sécurité enfant les enfants trop jeunes pour pouvoir utiliser la ceinture de sécurité. Lexus recommande vivement d'installer tous les nourrissons et jeunes enfants aux places arrière du véhicule et de prévoir pour eux des systèmes de retenue adaptés. C'est à l'arrière que les nourrissons et les jeunes enfants sont les mieux protégés.
- N'installez jamais un siège de sécurité enfant type dos à la route sur le siège passager avant, même si le témoin "AIR BAG OFF" est allumé. En cas d'accident, par la violence et la vitesse de son déploiement, le sac de sécurité gonflable passager avant peut blesser grièvement, voire tuer l'enfant si vous l'avez installé à la place du passager avant dans un siège de sécurité enfant type dos à la route.

## ATTENTION

### ■ Précautions avec les sacs de sécurité gonflables SRS



- Ne pas s'asseoir sur le bord du siège et ne pas s'appuyer contre la planche de bord.



- Ne laissez pas un enfant rester debout devant le sac de sécurité gonflable SRS passager avant ou bien s'asseoir sur les genoux du passager avant.



- Ne conduisez pas le véhicule avec quelque chose sur les genoux, et n'autorisez pas non plus le passager à voyager avec quelque chose sur les genoux.
- Ne vous appuyez pas contre la porte, contre le rail latéral de toit ou contre les montants avant, latéraux et arrière.



- Interdisez à quiconque de s'agenouiller sur le siège passager en appui contre la porte ou de sortir la tête ou les mains à l'extérieur du véhicule.

## ATTENTION

### ■ Précautions avec les sacs de sécurité gonflables SRS



- Ne fixez ni ne posez aucun objet sur la planche de bord, la garniture centrale du moyeu de volant de direction et la partie inférieure du tableau de bord.

Au déploiement des sacs de sécurité gonflables SRS conducteur, passager avant et genoux, tout objet risque de se transformer en projectile.



- Ne rien fixer aux portes, à la vitre de pare-brise, aux vitres latérales, aux montants avant et arrière, au rail latéral de toit ou à la poignée de maintien.

- Ne suspendez aux crochets à vêtements aucun cintre nu ni aucun objet dur. En cas de déploiement du sac de sécurité gonflable SRS rideau, ces objets peuvent se transformer en projectiles capables de vous blesser grièvement, voire de vous tuer.

- Si une housse en vinyle recouvre la partie où le sac de sécurité gonflable SRS de genoux se déploie, veillez à l'enlever.
- N'utilisez aucun accessoire de siège venant recouvrir les zones de déploiement des sacs de sécurité gonflables SRS latéraux, car il risquerait d'en gêner le déploiement.
- Évitez de faire subir des chocs ou des pressions excessives aux parties renfermant les composants des sacs de sécurité gonflables SRS, illustrées P. 553. En effet, cela pourrait entraîner un fonctionnement anormal des sacs de sécurité gonflables SRS.
- Ne touchez aucun composant du système immédiatement après le déclenchement (déploiement) des sacs de sécurité gonflables SRS, car ils sont alors encore très chauds.

## ATTENTION

### ■ Précautions avec les sacs de sécurité gonflables SRS

- Si vous avez des difficultés à respirer après le déploiement d'un sac de sécurité gonflable SRS, ouvrez une porte ou une vitre pour faire entrer de l'air frais, ou bien descendez du véhicule si cela ne présente pas de danger. Essayez tout résidu dès que possible afin d'éviter d'éventuelles irritations de la peau.
- Si les parties renfermant les sacs de sécurité gonflables SRS, telles que la garniture du moyeu de volant et la garniture de montant avant, apparaissent abîmées ou craquelées, faites-les remplacer par votre concessionnaire Lexus.

### ■ Modification et mise au rebut des éléments du système de sacs de sécurité gonflables SRS

Consultez impérativement votre concessionnaire Lexus si vous avez besoin d'intervenir sur votre véhicule ou de procéder à l'une des modifications suivantes.

Le sac de sécurité gonflable SRS risque de ne pas fonctionner correctement ou de se déclencher (déployer) accidentellement, ce qui pourrait risquer de vous tuer ou blesser grièvement.

- Installation, dépose, démontage et réparations des sacs de sécurité gonflables SRS
- Réparations, modifications, démontage ou remplacement du volant, du tableau de bord, de la planche de bord, des sièges ou de leur garnissage, des montants avant, latéraux et arrière ou des rails latéraux de toit
- Réparation ou modification des ailes avant, du bouclier avant, ou des flancs de l'habitacle
- Installation d'un chasse-neige, d'un treuil, etc. sur la calandre (pare-buffle, pare-kangourou, etc.)
- Modification des suspensions du véhicule
- Installation d'appareils électroniques tels que radio émetteur/récepteur ou lecteurs CD.
- Aménagements du véhicule visant à permettre sa conduite par une personne atteinte d'un handicap physique



## Index

<b>Abbreviation list .....</b>	<b>576</b>
<b>Alphabetical index .....</b>	<b>578</b>
<b>What to do if... .....</b>	<b>590</b>

For vehicles with a navigation system, refer to the “Navigation System Owner’s Manual” for information regarding the equipment listed below.

- Navigation system
- Audio/video system
- Air conditioning
- Rear window and outside rear view mirror defogging
- Climate control
- Rear view monitor system
- Intuitive parking assist

## Abbreviation list

# Abbreviation/Acronym list

ABBREVIATIONS	MEANING
2WD	Two Wheel Drive
ABS	Anti-lock Brake System
AI-SHIFT	Artificial Intelligence Shift
ALR	Automatic Locking Retractor
AWD	All Wheel Drive
CRS	Child Restraint System
DISP	Display
ECT	Electronic Controlled Transmission
ECU	Electronic Control Unit
EDR	Event data recorder
ELR	Emergency Locking Retractor
EPS	Electric Power Steering
ETCS	Electronic Throttle Control System
GAWR	Gross Axle Weight Rating
I/M	Emission inspection and maintenance
LATCH	Lower Anchors and Tethers for Children
LED	Light Emitting Diode
MMT	Methylcyclopentadienyl Manganese Tricarbonyl
M + S	Mud and Snow
MTBE	Methyl Tertiary Butyl Ether
OBD	On Board Diagnostics
SRS	Supplemental Restraint System
TIN	Tire Identification Number
TPMS	Tire Pressure Warning System
TRAC	Traction Control



ABBREVIATIONS	MEANING
VDIM	Vehicle Dynamics Integrated Management
VIN	Vehicle Identification Number
VSC	Vehicle Stability Control

<b>A</b>	A/C* ..... 216	Anti-lock brake system ..... 196
	ABS ..... 196	Armrest ..... 351
	Air conditioning filter ..... 430	Ashtrays ..... 342
	Air conditioning system	Audio input* ..... 271
	Air conditioning filter ..... 430	Audio system*
	Automatic air conditioning system* ..... 216	Antenna ..... 234
	Airbags	AUX port ..... 271
	Airbag operating conditions ..... 101	Bluetooth® audio ..... 276
	Airbag precautions for your child ..... 104	CD player/changer ..... 237
	Airbag warning light ..... 472	iPod ..... 252
	Curtain shield airbag operating conditions ..... 101	MP3/WMA disc ..... 244
	Curtain shield airbag precautions ..... 104	Optimal use ..... 269
	Front passenger occupant classification system ..... 109	Portable music player ..... 271
	General airbag precautions ..... 104	Radio ..... 229
	Locations of airbags ..... 98	Steering wheel audio switch ..... 273
	Modification and disposal of airbags ..... 108	USB memory ..... 260
	Proper driving posture ..... 96, 104	USB port ..... 260
	Side airbag operating conditions ..... 101	Automatic air conditioning system* ..... 216
	Side airbag precautions ..... 104	Automatic headlight leveling system ..... 175
	SRS airbags ..... 98	Automatic light control system ..... 172
	Alarm ..... 92	Automatic transmission
	Antenna* ..... 234	Automatic transmission ..... 146
		If the shift lever cannot be shifted from P ..... 503
		S mode ..... 149
		AUX port* ..... 271
		Auxiliary box ..... 335

<b>B</b>	<b>Back-up lights</b>	
	Wattage .....	536
	<b>Battery</b>	
	Checking .....	408
	If the vehicle has a discharged battery .....	510
	Preparing and checking before winter .....	206
	<b>Bluetooth® audio*</b> .....	276
	<b>Bluetooth® phone*</b> .....	294
	<b>Bottle holders</b> .....	334
	<b>Brake</b>	
	Fluid .....	406
	Parking brake .....	155
	<b>Brake assist</b> .....	196
<b>C</b>	<b>Care</b>	
	Exterior .....	378
	Interior .....	382
	Seat belts .....	383
	<b>Cargo capacity</b> .....	202
	<b>Cargo hooks</b> .....	357
	<b>CD changer*</b> .....	237
	<b>CD player*</b> .....	237
	<b>Chains</b> .....	206

<b>Child restraint system</b>	
Booster seats, definition .....	114
Booster seats, installation .....	121
Convertible seats, definition .....	114
Convertible seats, installation .....	121
Front passenger occupant classification system .....	109
Infant seats, definition .....	114
Infant seats, installation .....	121
Installing CRS with LATCH anchors .....	119
Installing CRS with seat belts .....	121
Installing CRS with top straps .....	124
<b>Child safety</b>	
Airbag precautions .....	104
Battery precautions .....	410, 512
Child restraint system .....	114
Child-protectors .....	49
How your child should wear the seat belt .....	68
Installing child restraints .....	118
Moon roof precautions .....	86
Power window lock switch .....	80
Power window precautions .....	82
Removed electronic key battery precautions .....	434
Seat belt comfort guide .....	66
Seat belt extender precautions .....	70
Seat belt precautions .....	69
Seat heater precautions .....	347, 350
Trunk precautions .....	54

\*: For vehicles with a navigation system, refer to the "Navigation System Owner's Manual".

Child-protectors ..... 49  
 Cigarette lighter ..... 343  
 Cleaning  
     Exterior ..... 378  
     Interior ..... 382  
     Seat belts ..... 383  
 Clock ..... 338  
 Coat hooks ..... 355  
 Compass ..... 366  
 Condenser ..... 406  
 Console box ..... 330  
 Cooling system  
     Engine overheating ..... 513  
 Cornering assist sensors ..... 190  
 Cruise control ..... 186  
 Cup holder ..... 332  
 Curtain shield airbags ..... 98  
 Customizable features ..... 553

**D** Daytime running light system ..... 174  
 Defogger\*  
     Rear window ..... 224  
     Side mirror ..... 224  
 Dimension ..... 520  
 Dinghy towing ..... 211, 212  
 Display  
     Satellite switch mode ..... 339  
     Trip information ..... 168  
     Warning message ..... 481

Do-it-yourself maintenance ..... 391  
 Door courtesy lights  
     Door courtesy lights ..... 325  
     Wattage ..... 536  
 Door pockets ..... 334  
 Doors  
     Door lock ..... 33, 45, 48  
     Door windows ..... 80  
     Side mirrors ..... 77  
 Driver's seat belt reminder light ..... 473  
 Driving  
     Correct posture ..... 96  
     Procedures ..... 130  
 Driving position memory ..... 58

**E** Electric power steering ..... 196  
 Electronic key  
     If the electronic key does not  
         operate properly ..... 505  
 Emergency, in case of  
     If a warning message is  
         displayed ..... 481  
     If the electronic key does not  
         operate properly ..... 505  
     If the engine will not start ..... 501  
     If the shift lever cannot be  
         shifted from P ..... 503  
     If the vehicle has a discharged  
         battery ..... 510  
     If the warning buzzer sounds ..... 471  
     If the warning light turns on ..... 471

If you have a flat tire .....	492
If you lose your keys .....	504
If you think something is wrong.....	469
If your vehicle becomes stuck .....	516
If your vehicle has to be stopped in an emergency.....	518
If your vehicle needs to be towed.....	463
If your vehicle overheats.....	513
<b>Emergency flashers</b>	
Switch.....	462
<b>Engine</b>	
Compartment .....	397
Engine switch .....	141
Hood .....	394
How to start the engine.....	141
Identification number .....	521
If the engine will not start .....	501
Ignition switch.....	141
Overheating.....	513
<b>Engine compartment cover.....</b>	<b>399</b>
<b>Engine coolant</b>	
Capacity.....	527
Checking.....	404
Preparing and checking before winter.....	206

<b>Engine coolant temperature</b>	
gauge.....	158
<b>Engine immobilizer system.....</b>	<b>90</b>
<b>Engine oil</b>	
Capacity .....	524
Checking .....	401
Preparing and checking before winter .....	206
<b>EPS .....</b>	<b>196</b>
<b>Event data recorder .....</b>	<b>21</b>
<b>F</b>	
<b>First-aid kit storage belt .....</b>	<b>357</b>
<b>Floor mat .....</b>	<b>356</b>
<b>Fluid</b>	
Brake.....	406
Washer .....	411
<b>Fog lights</b>	
Switch.....	176
Wattage.....	536
<b>Footwell lights .....</b>	<b>325</b>
<b>Front fog lights</b>	
Switch.....	176
Wattage.....	536
<b>Front passenger occupant classification system .....</b>	<b>109</b>
<b>Front passenger's seat belt reminder light.....</b>	<b>473</b>

\*: For vehicles with a navigation system, refer to the "Navigation System Owner's Manual".

Front seats  
 Adjustment.....56  
 Driving position memory.....58  
**Front turn signal lights**  
 Switch.....154  
 Wattage.....536  
**Fuel**  
 Capacity.....523  
 Fuel gauge.....158  
 Fuel pump shut off system.....470  
 Gas station information.....592  
 Information.....537  
 Refueling.....87  
**Fuel door**.....87  
**Fuel filler door**.....87  
**Fuel pump shut off system**.....470  
**Fuses**.....435

**G** **Garage door opener**.....360  
**Gas station information**.....592  
**Gauges**.....158  
**Glove box**.....330  
**Glove box light**.....330

**H** **Hands-free system**  
 for mobile phone\*.....294  
**Hazard lights**  
 Switch.....462  
**Head restraints**  
 Adjusting.....62  
**Headlight aim**.....450  
**Headlight cleaner**.....185  
**Headlights**  
 Discharge headlight  
 precautions.....459  
 Replacing light bulbs.....451  
 Switch.....172  
 Wattage.....536  
**Heaters**  
 Seat heaters.....345, 348  
 Side mirror.....224  
**Hill-start assist control**.....196  
**Hood**.....394  
**Hooks**  
 Cargo.....357  
 Coat.....355  
 Shopping bag.....357  
**Horn**.....157

<b>I</b>	I/M test.....	390
	Identification	
	Engine.....	521
	Vehicle.....	521
	Ignition switch.....	141
	Illuminated entry system.....	325
	Indicator lights.....	164
	Initialization	
	Items to initialize.....	559
	Inside rear view mirror.....	75
	Interior lights	
	Interior lights.....	325
	Switch.....	327
	Wattage.....	536
<b>J</b>	Jack	
	Positioning a floor jack.....	395
	Vehicle-equipped jack.....	492
	Jack handle.....	492
<b>K</b>	Keyless entry.....	45
	Keys	
	Electronic key.....	28
	Engine switch.....	141
	If the electronic key does not operate properly.....	505
	If you lose your keys.....	504

	Key number.....	28
	Keyless entry.....	45
	Keys.....	28
	Mechanical key.....	29
	Wireless remote control key.....	45
<b>L</b>	Light bulbs	
	Replacing.....	451
	Wattage.....	536
	Lights	
	Door courtesy lights.....	325
	Emergency flasher switch.....	462
	Fog light switch.....	176
	Hazard light switch.....	462
	Headlights switch.....	172
	Interior light switch.....	327
	Outer foot lights.....	325
	Overhead courtesy light.....	325
	Personal light switch.....	327
	Replacing light bulbs.....	451
	Scuff lights.....	325
	Shift lever light.....	325
	Turn signal lever.....	154
	Vanity lights.....	337
	Wattage.....	536
	Load capacity.....	205

\*: For vehicles with a navigation system, refer to the "Navigation System Owner's Manual".

<b>M</b>	<b>Maintenance</b>	
	Do-it-yourself maintenance.....	391
	General maintenance.....	387
	Maintenance data.....	520
	Maintenance requirements.....	385
	<b>Maintenance data.....</b>	<b>386</b>
	<b>Manual transmission.....</b>	<b>152</b>
	<b>Meter</b>	
	Instrument panel light control.....	159
	Meters.....	158
	<b>Micro dust and pollen filter*.....</b>	<b>220</b>
	<b>Mirrors</b>	
	Inside rear view mirror.....	75
	Side mirror heater.....	224
	Side mirrors.....	77
	Vanity mirrors.....	337
	<b>Moon roof.....</b>	<b>83</b>
	<b>MP3 disc*.....</b>	<b>244</b>
	<b>Multi-information display.....</b>	<b>167</b>
<b>N</b>	<b>Noise from under vehicle.....</b>	<b>19</b>
<b>O</b>	<b>Odometer.....</b>	<b>158</b>
	<b>Oil</b>	
	Engine oil.....	401
	<b>Opener</b>	
	Fuel filler door.....	87
	Hood.....	394
	Trunk.....	52

	<b>Outer foot lights</b>	
	Outer foot lights.....	325
	Wattage.....	536
	<b>Outside rear view mirrors</b>	
	Adjusting and folding.....	77
	Mirror position memory.....	58
	<b>Outside temperature display.....</b>	<b>168</b>
	<b>Overhead console.....</b>	<b>332</b>
	<b>Overhead courtesy lights</b>	
	Overhead courtesy lights.....	325
	Wattage.....	536
	<b>Overheating, Engine.....</b>	<b>513</b>
<b>P</b>	<b>Parking assist sensors*.....</b>	<b>190</b>
	<b>Parking brake.....</b>	<b>155</b>
	<b>Parking lights</b>	
	Replacing light bulbs.....	451
	Switch.....	172
	Wattage.....	536
	<b>Personal lights</b>	
	Switch.....	327
	<b>Power outlet.....</b>	<b>344</b>
	<b>Power windows.....</b>	<b>80</b>
<b>R</b>	<b>Radiator.....</b>	<b>406</b>
	<b>Radio*.....</b>	<b>229</b>
	<b>RDS*.....</b>	<b>231</b>
	<b>Rear sunshade.....</b>	<b>352</b>



Rear turn signal lights	
Replacing light bulbs .....	451
Wattage .....	536
Rear view mirror	
Compass .....	366
Rear window defogger* .....	224
Replacing	
Electronic key battery .....	433
Fuses .....	435
Light bulbs .....	451
Reporting safety defects for	
U.S. owners .....	562
<b>S</b> Safety Connect .....	370
Scuff lights .....	325
Seat belts	
Adjusting the seat belt .....	66
Automatic locking retractor.....	67
Child restraint system	
installation .....	118
Cleaning and maintaining	
the seat belts.....	383
Emergency locking retractor .....	67
How to wear your seat belt.....	65
How your child should wear	
the seat belt.....	68
Pregnant women,	
proper seat belt use.....	67
Reminder light.....	473
Seat belt extenders.....	68
Seat belt pretensioners.....	66

Seat heaters .....	345, 348
Seat ventilators .....	348
Seating capacity.....	205
Seats	
Adjustment.....	56
Adjustment precautions.....	57
Child seats/child restraint	
system installation.....	118
Cleaning.....	382
Driver's seat position memory.....	58
Head restraint.....	62
Properly sitting in the seat.....	96
Seat heaters .....	345, 348
Ventilated seats .....	348
Service reminder indicators .....	164
Shift lever	
Automatic transmission .....	146
If the shift lever cannot be	
shifted from P .....	503
Manual transmission .....	152
Shift lever lights.....	325
Shift lock system.....	503
Shopping bag hooks.....	357
Side airbags.....	98
Side marker lights	
Switch.....	172
Side mirror	
Adjusting and folding.....	77
Mirror position memory.....	58
"SOS" button .....	370

\*: For vehicles with a navigation system, refer to the "Navigation System Owner's Manual".

Smart access system with push-button start	
Entry function.....	33
Starting the engine.....	141
<b>Spare tire</b>	
Inflation pressure.....	424
Storage location.....	492
<b>Spark plug.....</b>	<b>527</b>
<b>Specifications .....</b>	<b>520</b>
<b>Speedometer</b>	
Speed indicator .....	158
Speedometer.....	158
<b>Steering wheel</b>	
Audio switches* .....	273
Manual adjustment .....	72
Power adjustment.....	73
Steering wheel position memory.....	58
<b>Storage feature.....</b>	<b>329</b>
<b>Stuck</b>	
If your vehicle becomes stuck.....	516
<b>Sun visors .....</b>	<b>336</b>
<b>Sunshade</b>	
Rear .....	352
Roof.....	84

<b>Switch</b>	
ECT switch.....	147
Emergency flasher switch.....	462
Engine switch.....	141
ETCS switch.....	153
Fog light switch .....	176
Hazard light switch .....	462
Ignition switch .....	141
Light switches.....	172
Power door lock switch.....	48
Power window switch .....	80
Satellite switches.....	339
Transmission shift switches .....	149
Window lock switch.....	80
Wiper and washer switch.....	178

**T**

<b>Tachometer</b>	
Tacho indicator .....	158
Tachometer.....	158
<b>Tail lights</b>	
Switch.....	172
<b>Talk switch* .....</b>	<b>299</b>
<b>Telephone switch* .....</b>	<b>298</b>
<b>Theft deterrent system</b>	
Alarm.....	92
Engine immobilizer system.....	90
<b>Theft prevention labels.....</b>	<b>95</b>
<b>Tire inflation pressure .....</b>	<b>424</b>

<b>Tire information</b>	
Glossary .....	546
Size .....	543
Tire identification number .....	543
Uniform tire quality grading.....	544
<b>Tires</b>	
Chains.....	206
Checking.....	412
If you have a flat tire.....	492
Inflation pressure .....	424
Inflation pressure sensor.....	414
Information.....	541
Replacing.....	492
Rotating tires.....	412
Size .....	531
Snow tires.....	206
<b>Tools .....</b>	<b>492</b>
<b>Total load capacity.....</b>	<b>205</b>
<b>Towing</b>	
Dinghy towing.....	211, 212
Emergency towing .....	463
Trailer towing.....	210
<b>TRAC .....</b>	<b>196</b>
<b>Traction control .....</b>	<b>196</b>
<b>Transmission shift switches .....</b>	<b>149</b>
<b>Trip meter .....</b>	<b>158</b>
<b>Trunk</b>	
Extending trunk space .....	354
Opener .....	52
<b>Trunk light</b>	
Trunk light.....	53
Wattage.....	536
<b>Turn signal lights</b>	
Replacing light bulbs.....	451
Switch.....	154
Wattage.....	536
<b>U</b>	
<b>USB port* .....</b>	<b>260</b>
<b>V</b>	
<b>Vanity lights</b>	
Vanity lights .....	337
Wattage.....	536
<b>Vanity mirrors .....</b>	<b>337</b>
<b>VDIM.....</b>	<b>196</b>
<b>Vehicle dynamics integrated management .....</b>	<b>196</b>
<b>Vehicle identification number .....</b>	<b>521</b>
<b>Vehicle stability control.....</b>	<b>196</b>
<b>Ventilators .....</b>	<b>348</b>
<b>Voice command switch* .....</b>	<b>298</b>
<b>VSC.....</b>	<b>196</b>

\*: For vehicles with a navigation system, refer to the “Navigation System Owner’s Manual”.

**W**

**Warning buzzers**

- Brake system ..... 471
- Open door ..... 473
- Seat belt reminder..... 473

**Warning lights**

- Anti-lock brake system.....472
- Brake assist system.....472
- Brake system ..... 471
- Charging system .....472
- Electric power steering
  - warning light.....472
- Low fuel level..... 473
- Malfunction indicator lamp.....472
- Master warning light..... 473
- Open door ..... 473
- Pretensioners.....472
- Seat belt reminder light ..... 473
- SRS airbags .....472
- Tire pressure warning
  - light..... 473

**Warning messages**

- AWD system..... 482
- Engine oil level..... 484
- Engine oil maintenance..... 484
- Engine oil pressure..... 481
- Hood..... 484
- Intuitive parking assist ..... 482, 484
- Moon roof..... 484
- Open door ..... 484
- Parking brake..... 484
- Smart access system with
  - push-button start ..... 488
- Steering lock..... 482
- Tire pressure
  - warning system..... 482, 484
- Trunk..... 484
- Washer fluid ..... 484

**Washer**

- Checking..... 411
- Preparing and checking
  - before winter..... 206
- Switch..... 178

**Washing and waxing..... 378**

Weight	
Cargo capacity .....	202
Load limits .....	205
Weight .....	520
Wheels .....	428
Window glasses .....	80
Window lock switch .....	80
Windows	
Power windows .....	80
Rear window defogger .....	224
Washer .....	178
Windshield wipers .....	178
Windshield wiper de-icer .....	225
Wireless remote control key	
Replacing the battery .....	433
WMA disc* .....	244

\*: For vehicles with a navigation system, refer to the "Navigation System Owner's Manual".

## What to do if...

## What to do if...



A tire punctures

P. 492 If you have a flat tire



The engine does not start

P. 501 If the engine will not start

P. 90 Engine immobilizer system

P. 510 If the vehicle battery is discharged



The shift lever cannot be moved out of P

P. 503 If the shift lever cannot be shifted from P



The engine coolant temperature gauge enters the red zone

P. 513 If your vehicle overheats



Steam can be seen coming from under the hood



The key is lost

P. 504 If you lose your keys



The battery runs out

P. 510 If the vehicle battery is discharged



The doors cannot be locked

P. 48 Doors



The horn begins to sound

P. 92 Alarm



The vehicle is stuck in mud or sand



P. 516 If the vehicle becomes stuck

 A warning light or indicator light comes on



P. 471 If a warning light turns on or a warning buzzer sounds...





■ Warning lights

 Brake system warning light  
or  
 P. 471

 Malfunction indicator lamp  
or  
 P. 472

 ABS warning light  
or  
 P. 472

 Driver's seat belt reminder light P. 473  
 Front passenger's seat belt reminder light P. 473

 Low fuel level warning light P. 473

 Master warning light P. 473

 SRS warning light P. 472

 Electric power steering warning light P. 472

 Open door warning light P. 473

 Tire pressure warning light P. 473

 Charging system warning light P. 472

 Slip indicator P. 472

 A warning message is displayed

P. 481 If a warning message is displayed

## GAS STATION INFORMATION

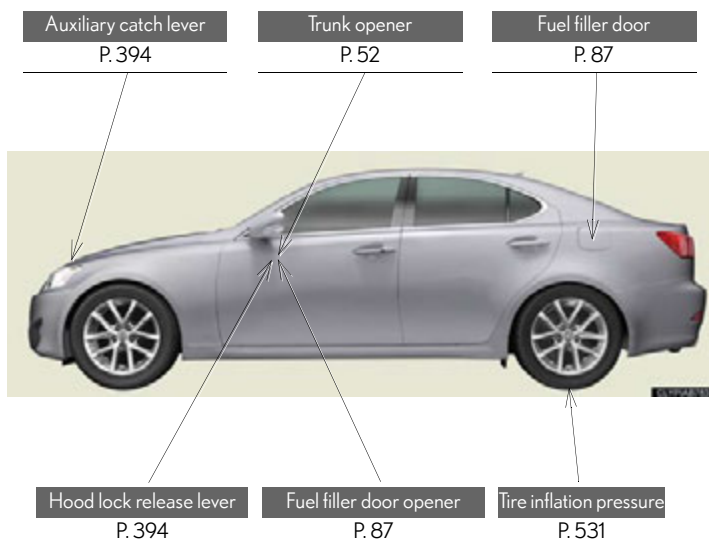

Fuel tank capacity (Reference)	17.2 gal. (65 L, 14.3 Imp. gal.)	
Fuel type	Unleaded gasoline only	P. 88, 523
Cold tire inflation pressure		P. 531
Engine oil capacity (Drain and refill — reference)	qt. (L, Imp. qt.)	
	(2WD models)	(AWD models)
	Without filter	6.2 (5.9, 5.2)    6.3 (6.0, 5.3)
	With filter	6.6 (6.3, 5.5)    6.7 (6.4, 5.6)
Engine oil type	Toyota Genuine Motor Oil or equivalent Oil grade: ILSAC multigrade engine oil	
		P. 524