

1	QUICK GUIDE	9
2	BASIC FUNCTION	33
3	NAVIGATION SYSTEM	81
4	AUDIO/VISUAL SYSTEM	165
5	VOICE COMMAND SYSTEM	257
6	INFORMATION	273
7	PERIPHERAL MONITORING SYSTEM	277
8	PHONE	295
9	LEXUS ENFORM	341
	INDEX	377

For more information about the following items, see the "Owner's Manual".

- Air conditioning
- Energy monitor (NX300h only)
- Fuel consumption
- Vehicle customization settings
- Intuitive parking assist

## Introduction

### NAVIGATION SYSTEM OWNER'S MANUAL

This manual explains the operation of the Navigation System. Please read this manual carefully to ensure proper use. Keep this manual in your vehicle at all times.

The screen shots in this document and the actual screens of the navigation system differ depending on whether the functions and/or a contract existed and the map data available at the time of producing this document.

Please be aware that the content of this manual may be different from the navigation system in some cases, such as when the system's software is updated.

### NAVIGATION SYSTEM

The Navigation System is one of the most technologically advanced vehicle accessories ever developed. The system receives satellite signals from the Global Positioning System (GPS) operated by the U.S. Department of Defense. Using these signals and other vehicle sensors, the system indicates your present position and assists in locating a desired destination.

The navigation system is designed to select efficient routes from your present starting location to your destination. The system is also designed to direct you to a destination that is unfamiliar to you in an efficient manner. The system uses DENSO maps. The calculated routes may not be the shortest nor the least traffic congested. Your own personal local knowledge or "short cut" may at times be faster than the calculated routes.

The navigation system's database includes Point of Interest categories to allow you to easily select destinations such as restaurants and hotels. If a destination is not in the database, you can enter the street address or a major intersection close to it and the system will guide you there.

The system will provide both a visual map and audio instructions. The audio instructions will announce the distance remaining and the direction to turn in when approaching an intersection. These voice instructions will help you keep your eyes on the road and are timed to provide enough time to allow you to maneuver, change lanes or slow down.

Please be aware that all current vehicle navigation systems have certain limitations that may affect their ability to perform properly. The accuracy of the vehicle's position depends on satellite conditions, road configuration, vehicle condition or other circumstances. For more information on the limitations of the system, refer to page 159.

**TOYOTA MOTOR CORPORATION**

## IMPORTANT INFORMATION ABOUT THIS MANUAL

For safety reasons, this manual indicates items requiring particular attention with the following marks.

### WARNING

- This is a warning against anything which may cause injury to people if the warning is ignored. You are informed about what you must or must not do in order to reduce the risk of injury to yourself and others.

### NOTICE

- This is a warning against anything which may cause damage to the vehicle or its equipment if the warning is ignored. You are informed about what you must or must not do in order to avoid or reduce the risk of damage to your vehicle and its equipment.

## SYMBOLS USED IN ILLUSTRATIONS



### Safety symbol

The symbol of a circle with a slash through it means "Do not", "Do not do this" or "Do not let this happen".

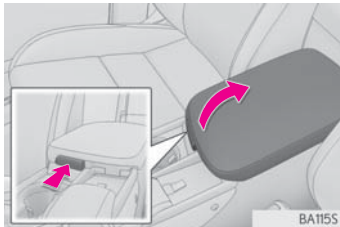

### Arrows indicating operations

- ➔ Indicates the action (pushing, turning, etc.) used to operate switches and other devices.

## HOW TO READ THIS MANUAL

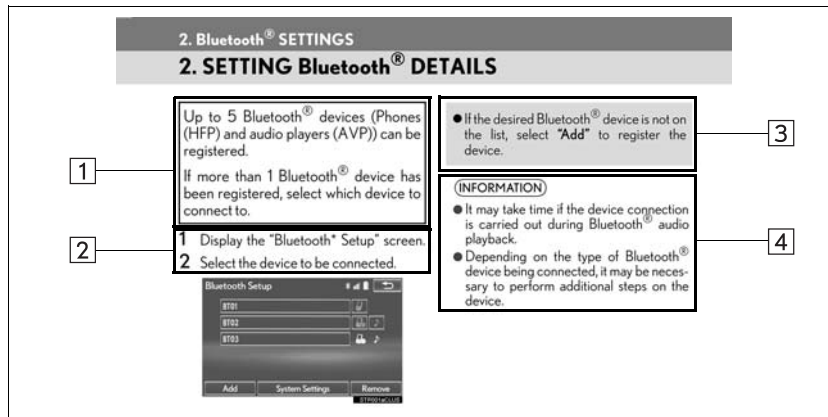

No.	Name	Description
1	Operational Outlines	An outline of the operation is explained.
2	Main Operations	The steps of an operation are explained.
3	Related Operations	A main operation's supplementary operations are described.
4	Information	Useful information for the user is described.

### ■ INFORMATION FOR HYBRID VEHICLES IS WRITTEN IN BRACKETS NEXT TO THE INFORMATION FOR GASOLINE VEHICLES

Different writing styles for gasoline and hybrid vehicles

#### ► Example

When the engine<sup>\*1</sup> <power><sup>\*2</sup> switch is in ACCESSORY or IGNITION ON<sup>\*1</sup> <ON><sup>\*2</sup> mode, the initial screen will be displayed and the system will begin operating.

\*1: Vehicles with gasoline engine

\*2: Vehicles with hybrid system

## SAFETY INSTRUCTION



To use this system in the safest possible manner, follow all the safety tips shown below.

This system is intended to assist in reaching the destination and, if used properly, can do so. The driver is solely responsible for the safe operation of your vehicle and the safety of your passengers.

Do not use any feature of this system to the extent it becomes a distraction and prevents safe driving. The first priority while driving should always be the safe operation of the vehicle. While driving, be sure to observe all traffic regulations.

Prior to the actual use of this system, learn how to use it and become thoroughly familiar with it. Read the entire Navigation System Owner's Manual to make sure you understand the system. Do not allow other people to use this system until they have read and understood the instructions in this manual.

For your safety, some functions may be inoperable when driving. Unavailable screen buttons are dimmed. Only when the vehicle is not moving, can the destination and route selection be done.

## WARNING

- For safety, the driver should not operate the navigation system while he/she is driving. Insufficient attention to the road and traffic may cause an accident.
- While driving, be sure to obey the traffic regulations and maintain awareness of the road conditions. If a traffic sign on the road has been changed, route guidance may not have the updated information such as the direction of a one way street.

While driving, listen to the voice instructions as much as possible and glance at the screen briefly and only when it is safe. However, do not totally rely on voice guidance. Use it just for reference. If the system cannot determine the current position correctly, there is a possibility of incorrect, late, or non-voice guidance.

The data in the system may occasionally be incomplete. Road conditions, including driving restrictions (no left turns, street closures, etc.) frequently change. Therefore, before following any instructions from the system, look to see whether the instruction can be done safely and legally.

This system cannot warn about such things as the safety of an area, condition of streets, and availability of emergency services. If unsure about the safety of an area, do not drive into it. Under no circumstances is this system a substitute for the driver's personal judgement.

Use this system only in locations where it is legal to do so. Some states/provinces may have laws prohibiting the use of video and navigation screens next to the driver.

## TABLE OF CONTENTS

### 1 QUICK GUIDE

<b>1. BASIC FUNCTION</b> .....	<b>10</b>
Remote Touch.....	10
“Menu” SCREEN.....	12
HOME SCREEN.....	14
<b>2. QUICK REFERENCE</b> .....	<b>18</b>
“Setup” SCREEN.....	18
“Information” SCREEN.....	20
<b>3. NAVIGATION OPERATION</b> .....	<b>22</b>
REGISTERING HOME.....	22
REGISTERING PRESET DESTINATIONS.....	24
OPERATION FLOW: GUIDING THE ROUTE.....	26
SETTING HOME AS THE DESTINATION.....	28
<b>4. FUNCTION INDEX</b> .....	<b>30</b>
FUNCTION INDEX.....	30

### 2 BASIC FUNCTION

<b>1. BASIC INFORMATION BEFORE OPERATION</b> .....	<b>34</b>
INITIAL SCREEN.....	34
HOW TO USE THE Remote Touch.....	36
HOME SCREEN OPERATION.....	39
ENTERING LETTERS AND NUMBERS/LIST SCREEN OPERATION.....	41
SCREEN ADJUSTMENT.....	45
LINKING MULTI-INFORMATION DISPLAY AND NAVIGATION SYSTEM.....	47
<b>2. Bluetooth® SETTINGS</b> .....	<b>48</b>
REGISTERING/CONNECTING Bluetooth® DEVICE.....	48
SETTING Bluetooth® DETAILS.....	56
<b>3. OTHER SETTINGS</b> .....	<b>66</b>
GENERAL SETTINGS.....	66
VOICE SETTINGS.....	73
VEHICLE SETTINGS.....	75

**3** NAVIGATION SYSTEM

<b>1. BASIC OPERATION</b> .....	<b>82</b>
QUICK REFERENCE .....	82
MAP SCREEN OPERATION .....	85
MAP SCREEN INFORMATION .....	93
TRAFFIC INFORMATION .....	100
<b>2. DESTINATION SEARCH</b> .....	<b>105</b>
DESTINATION SEARCH SCREEN .....	105
SEARCH OPERATION .....	107
STARTING ROUTE GUIDANCE .....	121
<b>3. ROUTE GUIDANCE</b> .....	<b>125</b>
ROUTE GUIDANCE SCREEN .....	125
TYPICAL VOICE GUIDANCE PROMPTS .....	132
EDITING ROUTE .....	133
<b>4. MEMORY POINTS</b> .....	<b>138</b>
MEMORY POINTS SETTINGS .....	138
<b>5. SETUP</b> .....	<b>150</b>
DETAILED NAVIGATION SETTINGS .....	150
TRAFFIC SETTINGS .....	156
<b>6. TIPS FOR THE NAVIGATION SYSTEM</b> .....	<b>159</b>
GPS (GLOBAL POSITIONING SYSTEM) .....	159
MAP DATABASE VERSION AND COVERED AREA .....	162

**4** AUDIO/VISUAL SYSTEM

<b>1. BASIC OPERATION</b> .....	<b>166</b>
QUICK REFERENCE .....	166
SOME BASICS .....	168
<b>2. RADIO OPERATION</b> .....	<b>176</b>
AM/FM RADIO .....	176
XM Satellite Radio .....	189
INTERNET RADIO .....	197
<b>3. MEDIA OPERATION</b> .....	<b>198</b>
CD .....	198
DVD .....	204
USB MEMORY .....	211
iPod .....	216
Bluetooth® AUDIO .....	223
AUX .....	229
VTR .....	232
<b>4. AUDIO/VISUAL REMOTE CONTROLS</b> .....	<b>235</b>
STEERING SWITCHES .....	235
<b>5. SETUP</b> .....	<b>237</b>
AUDIO SETTINGS .....	237
<b>6. TIPS FOR OPERATING THE AUDIO/VISUAL SYSTEM</b> .....	<b>244</b>
OPERATING INFORMATION .....	244

**5** VOICE COMMAND SYSTEM

<b>1. VOICE COMMAND SYSTEM OPERATION</b> .....	<b>258</b>
VOICE COMMAND SYSTEM .....	258
CASUAL SPEECH RECOGNIZATION .....	266
COMMAND LIST .....	267
<b>2. MOBILE ASSISTANT OPERATION</b> .....	<b>271</b>
MOBILE ASSISTANT .....	271

## TABLE OF CONTENTS

### 6 INFORMATION

<b>1. INFORMATION DISPLAY</b> .....	<b>274</b>
RECEIVING WEATHER INFORMATION.....	274
DATA SERVICES SETTINGS.....	276

### 7 PERIPHERAL MONITORING SYSTEM

<b>1. LEXUS PARKING ASSIST MONITOR</b> .....	<b>278</b>
LEXUS PARKING ASSIST MONITOR.....	278
ESTIMATED COURSE LINE DISPLAY MODE.....	283
PARKING ASSIST GUIDE LINE DISPLAY MODE.....	285
LEXUS PARKING ASSIST MONITOR PRECAUTIONS.....	287
THINGS YOU SHOULD KNOW.....	292

### 8 PHONE

<b>1. PHONE OPERATION (HANDS-FREE SYSTEM FOR CELLULAR PHONES)</b> .....	<b>296</b>
QUICK REFERENCE.....	296
SOME BASICS.....	297
CALLING ON THE Bluetooth® PHONE.....	301
RECEIVING ON THE Bluetooth® PHONE.....	307
TALKING ON THE Bluetooth® PHONE.....	308
Bluetooth® PHONE MESSAGE FUNCTION.....	311
<b>2. SETUP</b> .....	<b>318</b>
PHONE/MESSAGE SETTINGS.....	318
<b>3. WHAT TO DO IF...</b> .....	<b>334</b>
TROUBLESHOOTING.....	334

### 9 LEXUS ENFORM

<b>1. LEXUS ENFORM-OVERVIEW</b> .....	<b>342</b>
FUNCTIONAL OVERVIEW.....	342
TYPE A: FUNCTION ACHIEVED BY USING A CELLULAR PHONE.....	344
TYPE B: FUNCTION ACHIEVED BY USING DCM AND THE NAVIGATION SYSTEM.....	347
TYPE C: FUNCTION ACHIEVED BY USING DCM.....	350
<b>2. LEXUS ENFORM OPERATION</b> .....	<b>351</b>
LEXUS Enform Remote.....	351
LEXUS Enform Service Connect.....	352
LEXUS App Suite.....	353
LEXUS Enform Destinations.....	363
Lexus Insider.....	369
<b>3. SETUP</b> .....	<b>373</b>
LEXUS App Suite SETTINGS.....	373

### INDEX

<b>ALPHABETICAL INDEX</b> .....	<b>378</b>
---------------------------------	------------



# 1

## QUICK GUIDE

### 1 BASIC FUNCTION

- 1. Remote Touch..... 10
- 2. "Menu" SCREEN..... 12
- 3. HOME SCREEN..... 14
  - STATUS DISPLAY..... 16

### 2 QUICK REFERENCE

- 1. "Setup" SCREEN..... 18
- 2. "Information" SCREEN..... 20

### 3 NAVIGATION OPERATION

- 1. REGISTERING HOME..... 22
- 2. REGISTERING PRESET DESTINATIONS..... 24
- 3. OPERATION FLOW: GUIDING THE ROUTE..... 26
- 4. SETTING HOME AS THE DESTINATION..... 28

### 4 FUNCTION INDEX

- 1. FUNCTION INDEX..... 30

1

2

3

4

5

6

7

8

9

## 1. BASIC FUNCTION

### 1. Remote Touch

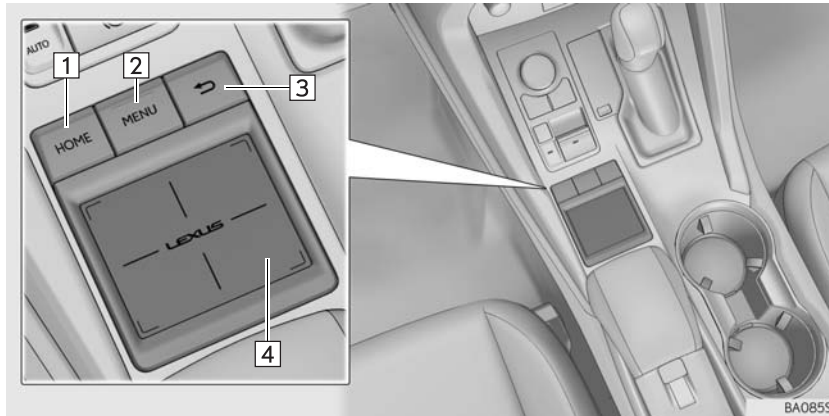

No.	Name	Function	Page
1	"HOME" button	Press to display the home screen.	14, 39
2	"MENU" button	Press to display the "Menu" screen.	12
3	Back button	Press to display the previous screen.	36
4	Touchpad	Slide your finger on the touchpad and move the pointer to select a function, letter and screen button. Press the touchpad to enter the selected function, letter or screen button. Certain finger movements on the touchpad can perform functions, such as changing map scalings and scrolling list screens.	36

## 1. BASIC FUNCTION

### 2. "Menu" SCREEN

Press the "MENU" button on the Remote Touch to display the "Menu" screen.

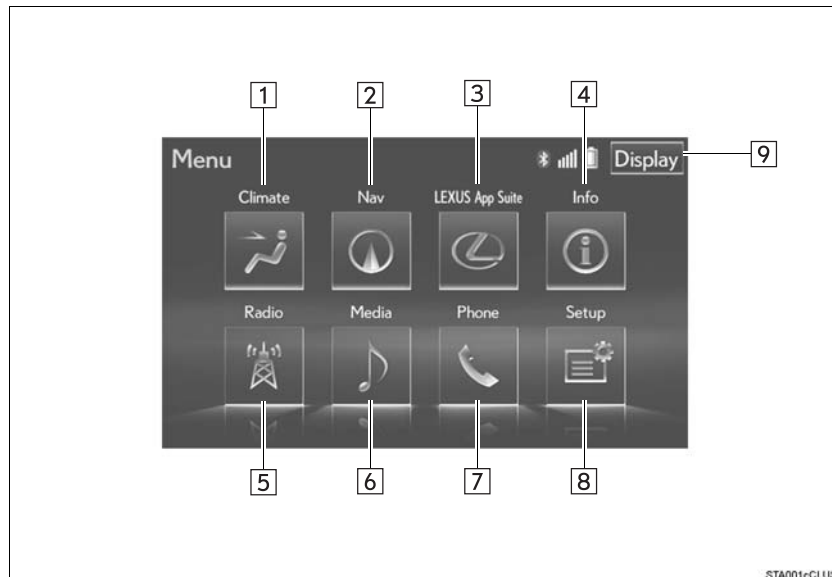

No.	Function	Page
1	Select to display the air conditioning control screen.	"Owner's Manual"
2	Select to display the map screen.	82
3	Select to display the "LEXUS App Suite" screen.	353
4	Select to display the "Information" screen.	20
5	Select to display the radio control screen.	166
6	Select to display the media control screen.	
7	Select to display the hands-free operation screen.	296
8	Select to display the "Setup" screen.	18
9	Select to adjust the contrast and brightness of the screens, turn the screen off, etc.	45

## 1. BASIC FUNCTION

### 3. HOME SCREEN

Press the "HOME" button on the Remote Touch to display the home screen.

The home screen can display multiple information screens, such as the navigation system screen, audio system screen and fuel consumption screen, simultaneously. When a screen is selected, the selected screen is switched to a full-screen display. The home screen can be set to either a three-way split screen or a two-way split screen.

For details about setting the home screen: → P.39

#### ► Three-way split screen

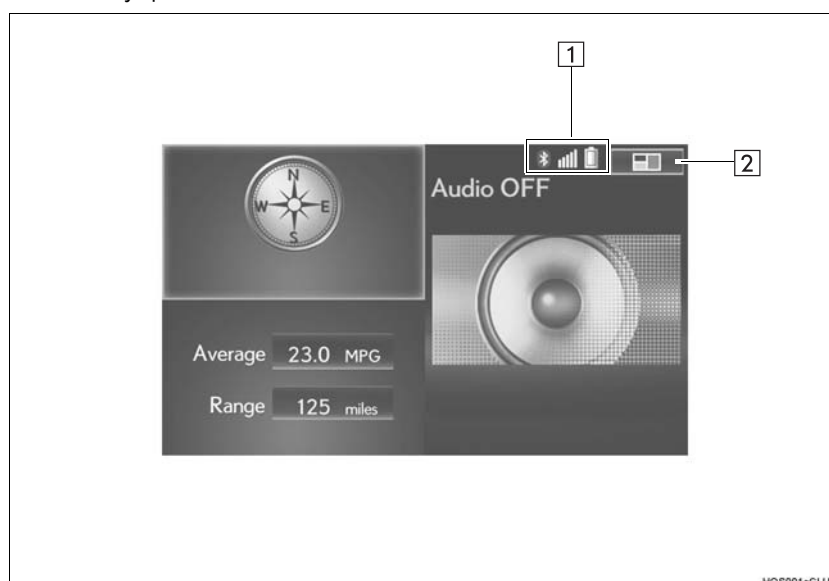

## ▶ Two-way split screen

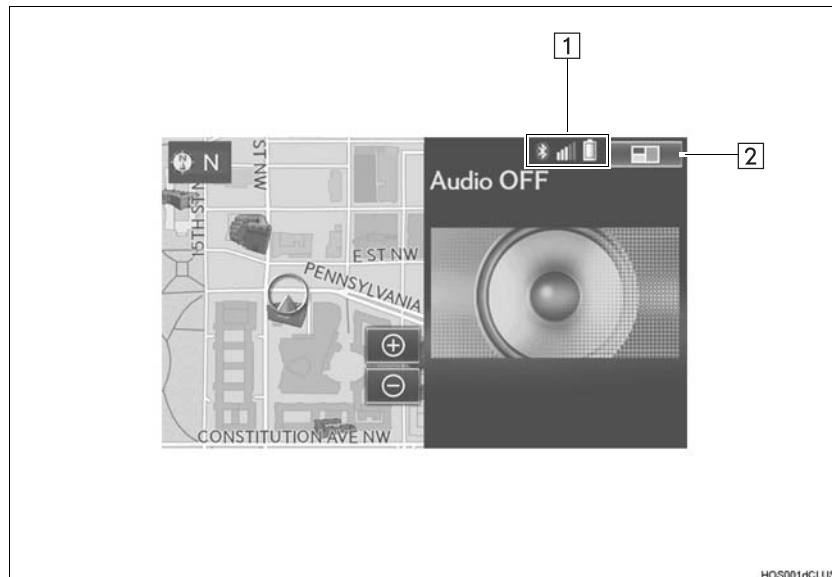



No.	Function	Page
1	Displays the condition of the Bluetooth® connection	16
2	Select to change the display items/area and the home screen layout.	39





## STATUS DISPLAY

The condition of the Bluetooth® connection, as well as the level of reception and the amount of cellular phone battery charge left, are displayed on the status bar. This status bar is always shown on all modes.



No.	Indicators	Conditions
1	The condition of the Bluetooth® connection	<p>   (Gray)                      (Blue)                 </p> <p>                     No connection ↔ Poor ↔ Good                 </p> <ul style="list-style-type: none"> <li>An antenna for the Bluetooth® connection is built into the instrument panel. The condition of the Bluetooth® connection may deteriorate and the system may not function when a Bluetooth® phone is used in the following conditions and/or places:                      The cellular phone is obstructed by certain objects (such as when it is behind the seat or in the glove box or console box).                      The cellular phone is touching or is covered with metal materials.</li> <li>Leave the Bluetooth® phone in a place where the condition of the Bluetooth® connection is good.</li> </ul>



No.	Indicators	Conditions
2	The level of reception	  <p>Poor ←————→ Excellent</p> <ul style="list-style-type: none"> <li>• The level of reception does not always correspond with the level displayed on the cellular phone. The level of reception may not be displayed depending on the phone you have. When the cellular phone is out of the service area or in a place inaccessible by radio waves, "No Service" is displayed.</li> <li>• "Rm" is displayed when receiving in a roaming area. While roaming, display "Rm" top-left on the icon.</li> <li>• The receiving area may not be displayed depending on the type of phone you have.</li> </ul>
3	The amount of battery charge left	  <p>Empty ←————→ Full</p> <ul style="list-style-type: none"> <li>• The amount displayed does not always correspond with the amount displayed on the Bluetooth<sup>®</sup> device. The amount of battery charge left may not be displayed depending on the type of the Bluetooth<sup>®</sup> device connected. This system does not have a charging function.</li> </ul>

## 2. QUICK REFERENCE

### 1. "Setup" SCREEN

The items shown on the "Setup" screen can be set. Press the "MENU" button on the Remote Touch, then select "Setup" to display the "Setup" screen.

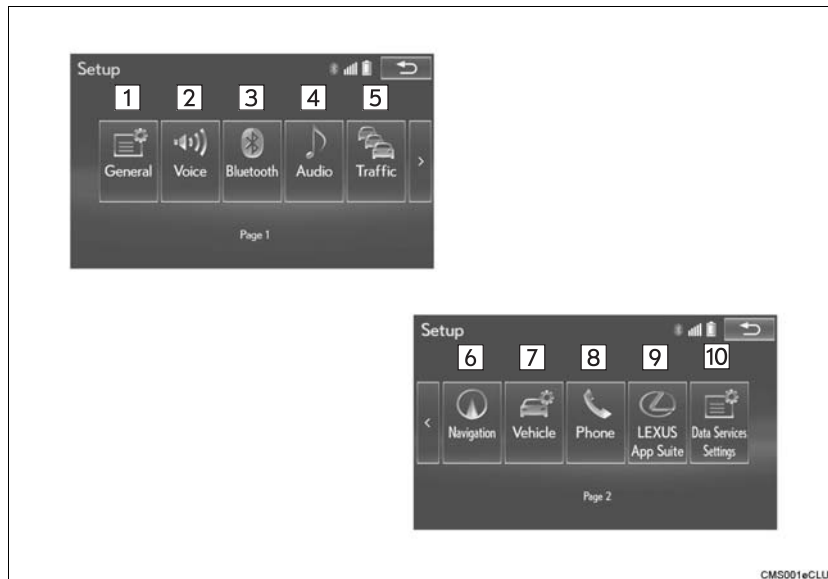

No.	Function	Page
1	Select to change the selected language, operation sound, automatic screen change settings, etc.	66
2	Select to set the voice guidance settings.	73
3	Select to set Bluetooth® phones and Bluetooth® audio devices.	56
4	Select to set radio and external media settings.	237
5	Select to set traffic information.	156
6	Select to set memory points (home, preset destinations, address book entries, areas to avoid), navigation details or to delete previous destinations.	138, 150
7	Select to set vehicle information such as maintenance information.	75
8	Select to set the phone sound, contacts, message settings, etc.	318
9	Select to set LEXUS App Suite settings.	373
10	Select to set data services settings.	276

## 2. QUICK REFERENCE

### 2. "Information" SCREEN

This screen can be used to display traffic information, fuel consumption, etc. Press the "MENU" button on the Remote Touch, then select "Info" to display the "Information" screen.

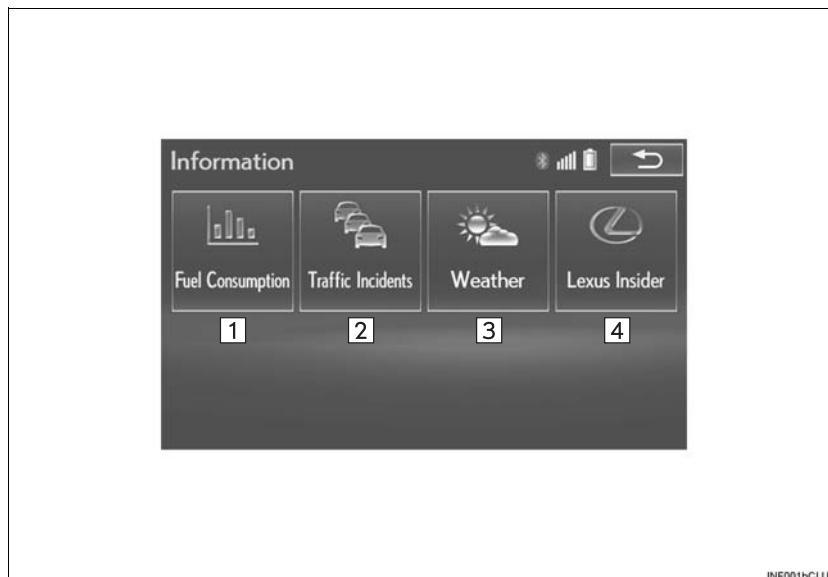

No.	Function	Page
1	Select to display the fuel consumption screen.	"Owner's Manual"
2	Select to display traffic information.	100
3	Select to display weather information.	274
4	Select to display the "LEXUS Insider" screen.	369

### 3. NAVIGATION OPERATION

## 1. REGISTERING HOME

- 1 Press the "MENU" button on the Remote Touch.

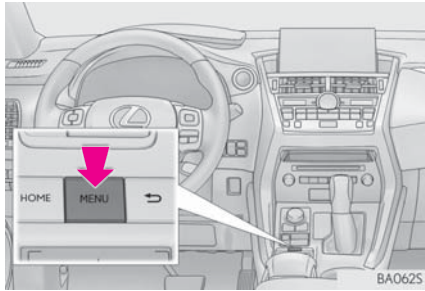

- 2 Select "Nav".



- 3 Select "Dest.".



- 4 Select "Go Home".



- 5 Select "Yes".



- 6 There are different kinds of methods to search for your home. (→P.105)

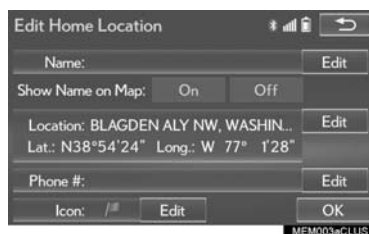

**7** Select "Enter".**8** Select "OK".

Registration of home is complete.

- ▶ Registering home in a different way  
→P.139
- ▶ Editing the name, location, phone number and icon  
→P.140
- ▶ Setting home as the destination  
→P.109

### 3. NAVIGATION OPERATION

## 2. REGISTERING PRESET DESTINATIONS

- 1 Press the "MENU" button on the Remote Touch.

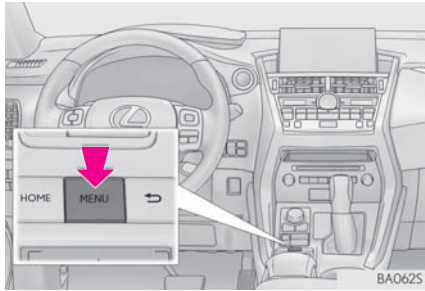

- 2 Select "Nav".



- 3 Select "Dest.".



- 4 Select one of the preset destination buttons.

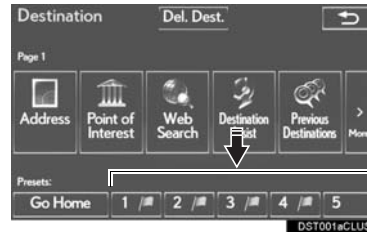

- 5 Select "Yes".

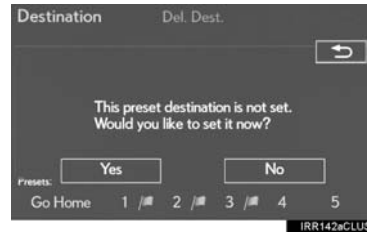

- 6 There are different kinds of methods to search for a destination. (→P.105)



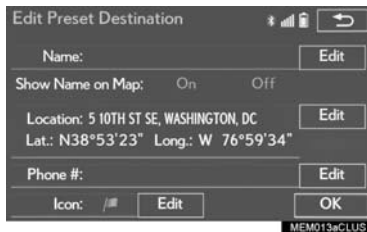

**7 Select "Enter".****8 Select "OK".**

Registration of preset destinations is complete.

- ▶ Registering preset destinations in a different way  
→P.141
- ▶ Editing the name, location, phone number and icon  
→P.142
- ▶ Setting preset destinations as the destination  
→P.109

### 3. NAVIGATION OPERATION

## 3. OPERATION FLOW: GUIDING THE ROUTE

- 1 Press the "MENU" button on the Remote Touch.

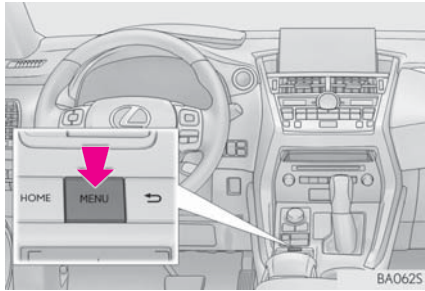

- 2 Select "Nav".



- 3 Select "Dest."



- 4 There are different kinds of methods to search for a destination. (→P.105)



- 5 Select "Go".

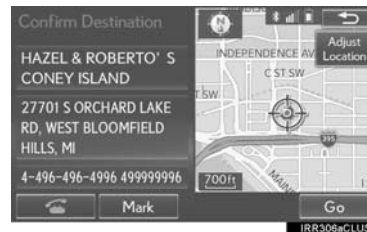

**6 Select "OK".**

Selecting routes other than the one recommended (→P.121)

Guidance to the destination is displayed on the screen and can be heard via voice guidance.

### 3. NAVIGATION OPERATION

## 4. SETTING HOME AS THE DESTINATION

- 1 Press the "MENU" button on the Remote Touch.

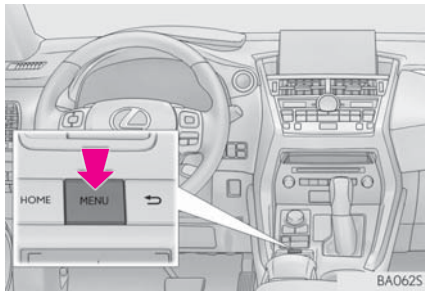

- 2 Select "Nav".



- 3 Select "Dest."



- 4 Select "Go Home".



## 5 Select "OK".



Selecting routes other than the one recommended (→P.121)

Guidance to the destination is displayed on the screen and can be heard via voice guidance.

## 4. FUNCTION INDEX

### 1. FUNCTION INDEX

#### ► Map

Displaying maps	Page
Viewing the map screen	82
Displaying the current position	85
Viewing the current position vicinity map	91
Changing the scale	86
Changing the map orientation	88
Displaying map Information	93
Displaying the estimated travel/arrival time to the destination	126
Selecting the map mode	89
Displaying traffic information	100

Searching for destinations	Page
Searching for the destination	107
Changing the search area	108

#### ► Route guidance

Before starting or during route guidance	Page
Starting route guidance	121
Editing the route	133
Viewing the entire route map	127
Pausing guidance	124
Adjusting route guidance volume	73
Deleting the destination	135

Address book	Page
Registering address book entries	143
Marking icons on the map	144

## ► Useful functions

Information	Page
Displaying vehicle maintenance	76
Hands-free system (for cellular phone)	Page
Registering/connecting a Bluetooth® phone	48
Making a call on a Bluetooth® phone	301
Receiving a call on the Bluetooth® phone	307
Voice command system	Page
Operating the system with your voice	258
Peripheral monitoring system	Page
Viewing behind the rear of the vehicle	278

## 4. FUNCTION INDEX



# 2

## BASIC FUNCTION

<b>1</b>	<b>BASIC INFORMATION BEFORE OPERATION</b>	
1.	INITIAL SCREEN .....	34
2.	HOW TO USE THE Remote Touch.....	36
	TOUCHPAD GESTURES.....	38
3.	HOME SCREEN OPERATION .....	39
4.	ENTERING LETTERS AND NUMBERS/LIST SCREEN OPERATION.....	41
	ENTERING LETTERS AND NUMBERS.....	41
	LIST SCREEN.....	42
5.	SCREEN ADJUSTMENT .....	45
6.	LINKING MULTI-INFORMATION DISPLAY AND NAVIGATION SYSTEM.....	47

<b>2</b>	<b>Bluetooth® SETTINGS</b>	
1.	<b>REGISTERING/CONNECTING Bluetooth® DEVICE.....</b>	<b>48</b>
	REGISTERING A Bluetooth® PHONE FOR THE FIRST TIME .....	48
	REGISTERING A Bluetooth® AUDIO PLAYER FOR THE FIRST TIME .....	50
	PROFILES.....	52
	CERTIFICATION.....	54
2.	<b>SETTING Bluetooth® DETAILS .....</b>	<b>56</b>
	“Bluetooth* Setup” SCREEN .....	57
	REGISTERING A Bluetooth® DEVICE.....	58
	DELETING A Bluetooth® DEVICE.....	59
	CONNECTING A Bluetooth® DEVICE .....	60
	EDITING THE Bluetooth® DEVICE INFORMATION.....	62
	“System Settings” SCREEN .....	64

<b>3</b>	<b>OTHER SETTINGS</b>	
1.	<b>GENERAL SETTINGS.....</b>	<b>66</b>
	GENERAL SETTINGS SCREEN.....	67
2.	<b>VOICE SETTINGS.....</b>	<b>73</b>
	VOICE SETTINGS SCREEN.....	74
3.	<b>VEHICLE SETTINGS .....</b>	<b>75</b>
	MAINTENANCE.....	76

\*: Bluetooth is a registered trademark of Bluetooth SIG, Inc.

## 1. BASIC INFORMATION BEFORE OPERATION

### 1. INITIAL SCREEN

- 1 When the engine <power> switch is in ACCESSORY or IGNITION ON <ON> mode, the initial screen will be displayed and the system will begin operating.



- Images shown on the initial screen can be changed to suit individual preferences. (→P.69)

- After a few seconds, the “CAUTION” screen will be displayed.



- After about 5 seconds, the “CAUTION” screen automatically switches to the home screen. (Select “Continue” or press the “HOME” button on the Remote Touch to display the home screen.)

#### WARNING

- When the vehicle is stopped with the engine running <hybrid system operating>, always apply the parking brake for safety.

## MAINTENANCE INFORMATION

This system reminds users when to replace certain parts or components and shows dealer information (if registered) on the screen.

When the vehicle reaches a previously set driving distance or date specified for a scheduled maintenance check, the "Maintenance Reminder" screen will be displayed when the navigation system is turned on.



- This screen goes off if the screen is not operated for several seconds.
- To prevent this screen from being displayed again, select "Do Not Display This Message Again".
- To register maintenance information: →P.76
- If  is selected, the registered phone number can be called.

## RESTARTING THE SYSTEM

When system response is extremely slow, the system can be restarted.

- 1 Press and hold the "PWR•VOL" knob for 3 seconds or more.

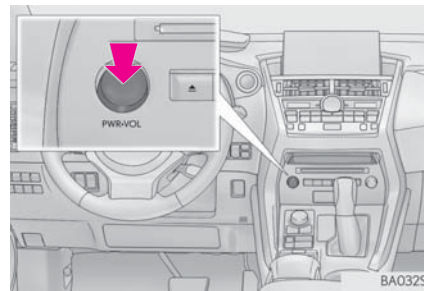

2 BASIC FUNCTION

## 1. BASIC INFORMATION BEFORE OPERATION

## 2. HOW TO USE THE Remote Touch

This navigation system can be operated by the Remote Touch when the engine <power> switch is in ACCESSORY or IGNITION ON <ON> mode.

- 1 Use the touchpad of the Remote Touch to select the desired button on the screen.

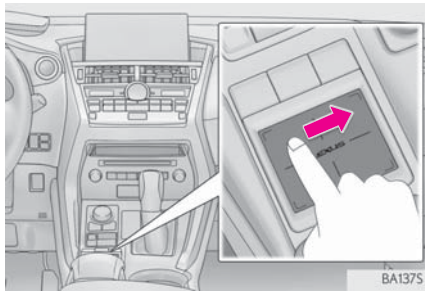

- 2 The buttons on the screen can be selected by either depressing or double tapping on the touchpad. Once a button has been selected, the screen will change.

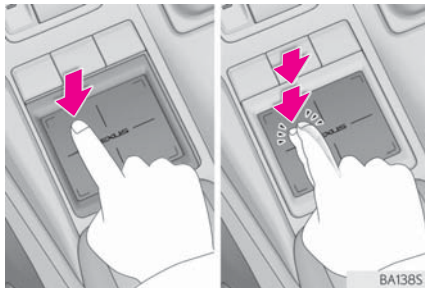

- When the pointer moves close to a button, it will automatically snap to that button and a feedback force is relayed from the touchpad. This feedback force can be adjusted. (→P.66)
- Press the “MENU” button on the Remote Touch to display the “Menu” screen. (→P.12)
- The home screen can be displayed by pressing the “HOME” button on the Remote Touch. (→P.14)
- Press the back button on the Remote Touch to return to the previous screen.

### NOTICE

- Do not allow the Remote Touch to come into contact with food, liquid, stickers or lit cigarettes as doing so may cause damage.
- Do not subject the Remote Touch to excessive pressure or strong impact as doing so may cause damage.
- Do not push the touchpad with a strong force or use a sharp pointed object to operate the pad, as it is possible to cause damage.

**INFORMATION**

- Perform touchpad operations using a finger. Do not use nails or other objects like pens, etc.
- Perform pointer movement operations using only one finger. The pointer can not be operated if other fingers are touching the touchpad.
- When water or other foreign materials are on the touchpad, a malfunction may occur. In those cases, wipe off the water or foreign materials and wait about 30 seconds before operating the touchpad.
- In the following cases, there is a possibility that the touchpad may not react normally:
  - When wearing gloves, etc.
  - When operated with a wet hand.
  - When a film, paint-like substance, etc., is on the touchpad.
  - When water, dirt, etc., have adhered to the touchpad.
  - Near a TV tower, electrical power plant, gas station, radio station, large display, airport or other facility that generates strong radio waves or electrical noise.
  - When wireless devices, such as portable radios and mobile phones are nearby.
  - When the following metal items are placed on the touchpad:
    - Coins
    - Keys
    - Metal parts of a wallet or purse
    - A card in which aluminum foil, etc., is attached
    - A box of cigarettes that uses aluminum foil
    - Disposable hand warmers
    - Media such as CD/DVDs, USB cables, etc.

**INFORMATION**

- If a hand or object was placed on the touchpad when the engine <power> switch is turned to ACCESSORY or IGNITION ON <ON> mode, the touchpad may not react normally. In those cases, remove what was set on the touchpad and operate it after waiting about 30 seconds. If there still no reaction, turn off the engine <power> switch and then set it to ACCESSORY or IGNITION ON <ON> mode again.
- Clean the touchpad frequently, as the reaction of the touch operation may worsen if the touchpad is dirty. In order to prevent malfunctions when cleaning the touchpad, turn the engine <power> switch off.

## 1. BASIC INFORMATION BEFORE OPERATION

### TOUCHPAD GESTURES

Operations are performed by touching the touchpad with your finger.

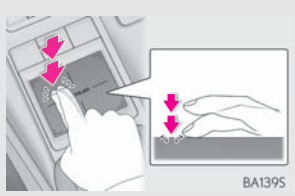
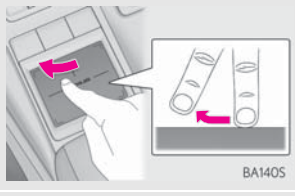
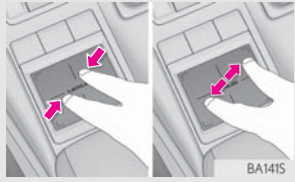
Operation method	Outline	Main use
	<p><b>Double tap</b> Tap the touchpad twice, quickly.</p>	<p>Selecting the button on the screen.</p>
	<p><b>Flick</b> Quick and long movement along the touchpad with your finger.</p>	<p>Moving the list screen or map (single map only) screen.</p>
	<p><b>Pinch in/Pinch out</b> Slide fingers toward each other or apart on the touchpad.</p>	<p>Changing the scale of the map.</p>

#### INFORMATION

- Setting for the touchpad, such as movement speed of the pointer, can be changed. For details, contact your Lexus dealer.

## 1. BASIC INFORMATION BEFORE OPERATION

### 3. HOME SCREEN OPERATION

The home screen can display multiple information screens, such as the navigation system screen, audio system screen and fuel consumption screen, simultaneously.

- 1 Press the "HOME" button on the Remote Touch.

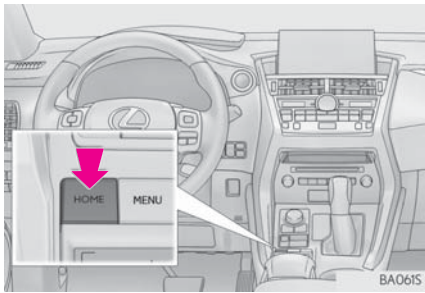

- 2 Check that the home screen is displayed.



- When a screen is selected, the selected screen will change to a full-screen display.

#### CUSTOMIZING THE HOME SCREEN

The display items/area on the home screen and the home screen layout can be changed.

2

BASIC FUNCTION

- 1 Select .



- 2 Check that "Customize Home Screen" is displayed.

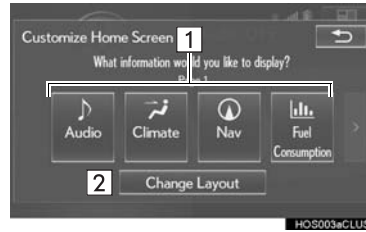

No.	Function	Page
1	Select to change the display items/area.	40
2	Select to change the home screen layout.	40

## 1. BASIC INFORMATION BEFORE OPERATION

### ■ CHANGING THE DISPLAY ITEMS/AREA

- 1 Select the desired item.
- 2 Select the desired area.



### ■ CHANGING THE HOME SCREEN LAYOUT

- 1 Select "Change Layout".
- 2 Select the desired screen layout.



### INFORMATION

- When the selected item is already being displayed and another area is selected for that item, the item that it is replacing will be displayed in the original item's location.



## 1. BASIC INFORMATION BEFORE OPERATION

### 4. ENTERING LETTERS AND NUMBERS/LIST SCREEN OPERATION

When searching by an address, name, etc., or entering data, letters and numbers can be entered via the screen.

#### ENTERING LETTERS AND NUMBERS

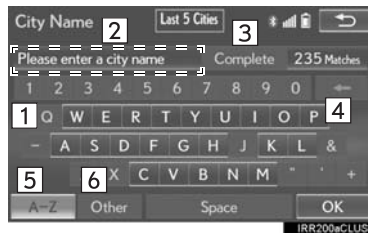

No.	Function
1	Select to enter desired characters.
2	Text field. Entered character(s) will be displayed.
3	During entering character(s), when there is only one available option for the next character(s), the next character(s) will be displayed in gray text in the text field automatically. Gray text is entered by selecting this button.
4	Select to erase one character. Select and hold to continue erasing characters.
5	Select to display the alphabet keys.
6	Select to display other symbols.

- On certain letter entry screens, letters can be entered in upper or lower case.

↓ : Select to enter in lower case.

↑ : Select to enter in upper case.

- Keyboard layout can be changed. (→P.66)

2

BASIC FUNCTION

# 1. BASIC INFORMATION BEFORE OPERATION

## LIST SCREEN

### DISPLAYING THE LIST

The list screen may be displayed after entering characters.

1 Enter characters and select "OK".



- Matching items from the database are listed even if the entered address or name is incomplete.
- The list will be displayed automatically if the maximum number of characters is entered or matching items can be displayed on a single list screen.

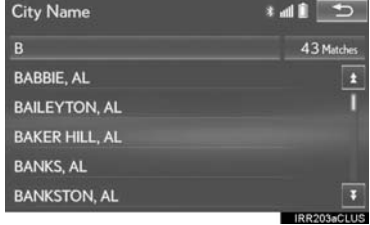

### INFORMATION

- The number of matching items is shown on the right side of the screen. If the number of matching items is more than 999, the system displays "\*\*\*" on the screen.

## SELECTING ALL ITEMS

Some lists contain "Select All". If "Select All" is selected, it is possible to select all items.

1 Select "Select All".

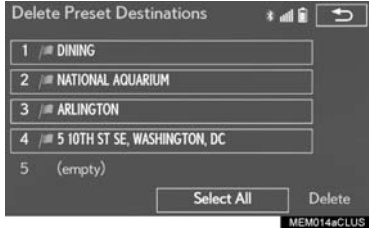

"Unselect All": Unselect all items in the list.

# 1. BASIC INFORMATION BEFORE OPERATION

## LIST SCREEN OPERATION

When a list is displayed, use the appropriate screen button to scroll through the list.

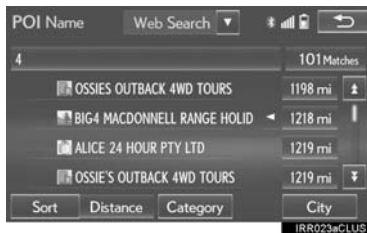

Icon	Function
	Select to skip to the next or previous page.
	Select and hold  or  to scroll through the displayed list.
	This indicates the displayed screen's position.
	If  appears to the right of an item name, the complete name is too long to display.
	Select  to scroll to the end of the name.
	Select  to move to the beginning of the name.

### INFORMATION

- The list screen can be scrolled by flick operation with your finger on the touchpad of the Remote Touch. (→P.38)

## SORTING

The order of a list displayed on the screen can be sorted in the order of distance from the current location, date, category, etc.

1 Select "Sort".

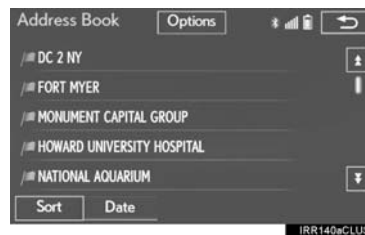

2 Select the desired sorting criteria.

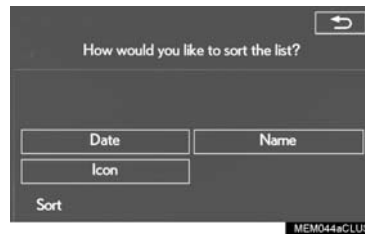

2 BASIC FUNCTION

## CHARACTER JUMP BUTTONS IN LISTS

Some lists contain character screen buttons, "ABC", "DEF" etc., which allow a direct jump to list entries that begin with the same letter as the character screen button.

- 1 Select the desired character jump buttons.

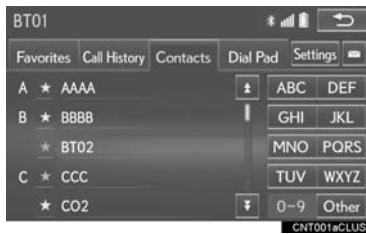

### (INFORMATION)

- Every time the same character screen button is selected, the list starting with the subsequent character is displayed.

## 1. BASIC INFORMATION BEFORE OPERATION

### 5. SCREEN ADJUSTMENT

The contrast and brightness of the screen display and the image of the camera display can be adjusted. The screen can also be turned off, and/or changed to either day or night mode. (For information regarding audio/visual screen adjustment: →P.174)

- 1 Press the “MENU” button on the Remote Touch.

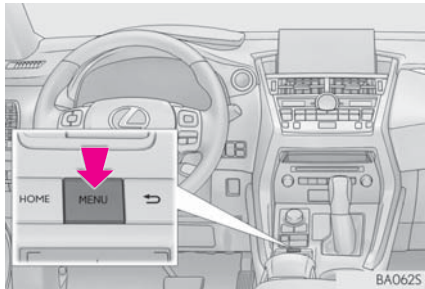

- 2 Select “Display”.



- 3 Select the items to be set.

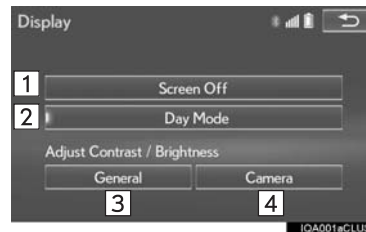

2  
BASIC FUNCTION

No.	Function	Page
1	Select to turn the screen off. To turn it on, press any button on the audio panel or on the Remote Touch.	—
2	Select to turn day mode on/off.	46
3	Select to adjust the screen display.	46
4	Select to adjust the camera display.	

#### INFORMATION

- When the screen is viewed through polarized sunglasses, a rainbow pattern may appear on the screen due to optical characteristics of the screen. If this is disturbing, please operate the screen without polarized sunglasses.

# 1. BASIC INFORMATION BEFORE OPERATION

## CHANGING BETWEEN DAY AND NIGHT MODE

Depending on the position of the headlight switch, the screen changes to day or night mode.

- 1 To display the screen in day mode even with the headlight switch on, select **"Day Mode"**.

**INFORMATION**

- If the screen is set to day mode with the headlight switch turned on, this condition is memorized even with the engine <hybrid system> turned off.

## ADJUSTING THE CONTRAST/ BRIGHTNESS

The contrast and brightness of the screen can be adjusted according to the brightness of your surroundings.

- 1 Select **"General"** or **"Camera"**.
- 2 Select the desired item.



- "Display (General)" screen only: Select "<" or ">" to select the desired display.

Screen button	Function
"Contrast" "+"	Select to strengthen the contrast of the screen.
"Contrast" "-"	Select to weaken the contrast of the screen.
"Brightness" "+"	Select to brighten the screen.
"Brightness" "-"	Select to darken the screen.

## 1. BASIC INFORMATION BEFORE OPERATION

### 6. LINKING MULTI-INFORMATION DISPLAY AND NAVIGATION SYSTEM

The following functions of the navigation system are linked with the multi-information display in the instrument cluster:

- Navigation
- Audio
- Phone

etc.

These functions can be operated using multi-information display control switches on the steering wheel. For details, refer to "Owner's Manual".

2

BASIC FUNCTION

## 2. Bluetooth® SETTINGS

### 1. REGISTERING/CONNECTING Bluetooth® DEVICE

#### REGISTERING A Bluetooth® PHONE FOR THE FIRST TIME

To use the hands-free system, it is necessary to register a Bluetooth® phone with the system.

Once the phone has been registered, it is possible to use the hands-free system.

This operation cannot be performed while driving.

For details about registering a Bluetooth® device: →P.58

1 Turn the Bluetooth® connection setting of your cellular phone on.

- This function is not available when Bluetooth® connection setting of your cellular phone is set to off.

2 Press the “MENU” button on the Remote Touch.

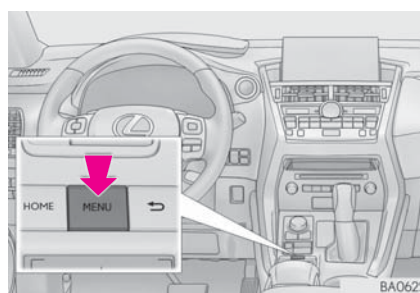

3 Select “Phone”.

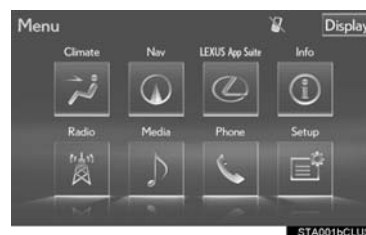

- Operations up to this point can also be performed by pressing the  switch on the steering wheel.



- 4 Select "Yes" to register a phone.



- 5 When this screen is displayed, search for the device name displayed on this screen on the screen of your Bluetooth® device.



- For details about operating the Bluetooth® device, see the manual that comes with it.
- To cancel the registration, select "Cancel".

- 6 Register the Bluetooth® device using your Bluetooth® device.

- A PIN-code is not required for SSP (Secure Simple Pairing) compatible Bluetooth® devices. Depending on the type of Bluetooth® device being connected, a message confirming registration may be displayed on the Bluetooth® device's screen. Respond and operate the Bluetooth® device according to the confirmation message.

- 7 Check that the following screen is displayed when registration is complete.



- The system waits for connection requests coming from the registered device.
- At this stage, the Bluetooth® functions are not yet available.

## 2. Bluetooth® SETTINGS

- 8 Select "OK" when the connection status changes from "Connecting..." to "Connected".

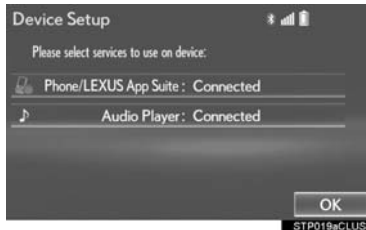

- If an error message is displayed, follow the guidance on the screen to try again.

### REGISTERING A Bluetooth® AUDIO PLAYER FOR THE FIRST TIME

To use the Bluetooth® Audio, it is necessary to register an audio player with the system.

Once the player has been registered, it is possible to use the Bluetooth® Audio.

This operation cannot be performed while driving.

For details about registering a Bluetooth® device: →P.58

- 1 Turn the Bluetooth® connection setting of your audio player on.
  - This function is not available when the Bluetooth® connection setting of your audio player is set to off.
- 2 Press the “MENU” button on the Remote Touch.

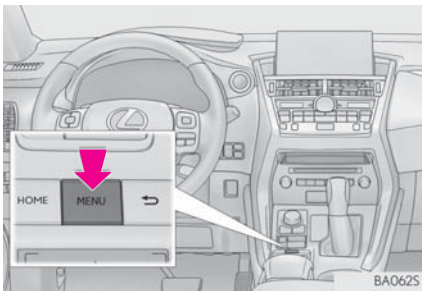

- 3 Select “Radio” or “Media”.



- 4 Select “Source”.



- 5 Select “Bluetooth\*”.



- 6 Select “Connect”.

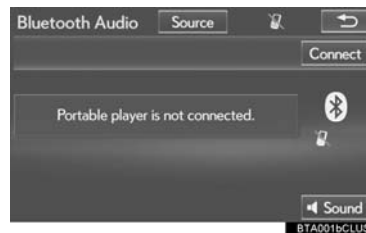

- 7 Select “Yes” to register a audio player.



- 8 Follow the steps in “REGISTERING A Bluetooth® PHONE FOR THE FIRST TIME” from “STEP 5”. (→P.48)

\*: Bluetooth is a registered trademark of Bluetooth SIG, Inc.

2  
BASIC FUNCTION

## 2. Bluetooth® SETTINGS

### PROFILES

This system supports the following services.

Bluetooth® Device	Spec.	Function	Requirements	Recommendations
Bluetooth® Phone/ Bluetooth® Audio Player	Bluetooth® Specification	Registering a Bluetooth® device	Ver.2.0	Ver.3.0 +EDR
Bluetooth® Device	Profile	Function	Requirements	Recommendations
Bluetooth® Phone	HFP (Hands-Free Profile)	Hands-free system	Ver. 1.0	Ver. 1.6
	OPP (Object Push Profile)	Transferring the contacts	Ver. 1.1	Ver. 1.2
	PBAP (Phone Book Access Profile)		Ver. 1.0	Ver. 1.1
	MAP (Message Access Profile)	Bluetooth® phone message	—	Ver. 1.0
	SPP (Serial Port Profile)	"LEXUS App Suite" function	—	Ver. 1.1
Bluetooth® Audio Player	A2DP (Advanced Audio Distribution Profile)	Bluetooth® audio system	Ver. 1.0	Ver. 1.2
	AVRCP (Audio/Video Remote Control Profile)		Ver. 1.0	Ver. 1.4

**INFORMATION**

- If your cellular phone does not support HFP, registering the Bluetooth® phone or using OPP, PBAP, MAP or SPP profiles individually will not be possible.
- If the connected Bluetooth® device version is older than recommended or incompatible, the Bluetooth® device function may not work properly.
- Refer to <http://www.lexus.com/MobileLink> to find approved Bluetooth® phones for this system.

2

BASIC FUNCTION



Bluetooth is a registered trademark of Bluetooth SIG, Inc.

## CERTIFICATION

### ► U.S.A.

- **FCC ID: AJDK061**

- This equipment complies with FCC/IC radiation exposure limits set forth for an uncontrolled environment and meets the FCC radio frequency (RF) Exposure Guidelines and RSS-102 of the IC radio frequency (RF) Exposure rules. This equipment should be installed and operated keeping the radiator at least 20 cm or more away from person's body.
- This transmitter must not be co-located or operated in conjunction with any other antenna or transmitter.

- This device complies with Part 15 of FCC Rules and Industry Canada licence-exempt RSS standard(s). Operation is subject to the following two conditions: (1) this device may not cause interference, and (2) this device must accept any interference, including interference that may cause undesired operation of this device.
- Information to User - Alteration or modifications carried out without appropriate authorization may invalidate the user's right to operate the equipment.

## ► Canada

## ● IC: 775E-K061

- This equipment complies with FCC/IC radiation exposure limits set forth for an uncontrolled environment and meets the FCC radio frequency (RF) Exposure Guidelines and RSS-102 of the IC radio frequency (RF) Exposure rules. This equipment should be installed and operated keeping the radiator at least 20 cm or more away from person's body.
- Cet équipement est conforme aux limites d'exposition aux rayonnements énoncées pour un environnement non contrôlé et respecte les règles les radioélectriques (RF) de la FCC lignes directrices d'exposition et d'exposition aux fréquences radioélectriques (RF) CNR-102 de l'IC. Cet équipement doit être installé et utilisé en gardant une distance de 20 cm ou plus entre le radiateur et le corps humain.

- This device complies with Part 15 of FCC Rules and Industry Canada's licence-exempt RSSs. Operation is subject to the following two conditions: (1) This device may not cause interference; and (2) This device must accept any interference, including interference that may cause undesired operation of the device.
- Le présent appareil est conforme aux la partie 15 des règles de la FCC et CNR d'Industrie Canada applicables aux appareils radio exempts de licence. L'exploitation est autorisée aux deux conditions suivantes: (1) l'appareil ne doit pas produire de brouillage; (2) l'utilisateur de l'appareil doit accepter tout brouillage radioélectrique subi, même si le brouillage est susceptible d'en compromettre le fonctionnement.

2

BASIC FUNCTION

## 2. Bluetooth® SETTINGS

### 2. SETTING Bluetooth® DETAILS

1 Press the “MENU” button on the Remote Touch.

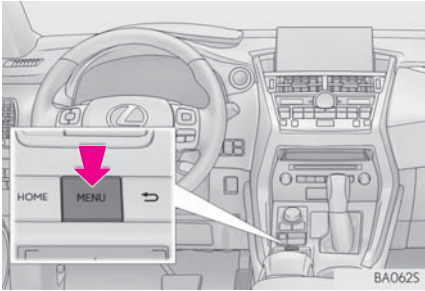

2 Select “Setup”.

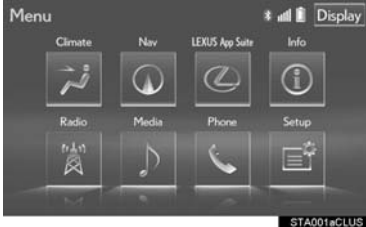

3 Select “Bluetooth\*”.

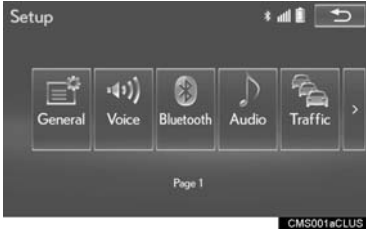

4 Select the desired item to be set.



\*: Bluetooth is a registered trademark of Bluetooth SIG, Inc.



**“Bluetooth\* Setup” SCREEN**



Function	Page
Registering a Bluetooth® device	58
Deleting a Bluetooth® device	59
Connecting a Bluetooth® device	60
Editing the Bluetooth® device information	62
Bluetooth® system settings	64

**DISPLAYING THE “Bluetooth\* Setup” SCREEN IN A DIFFERENT WAY**

- 1 Press the “MENU” button on the Remote Touch. (→P.10)
- 2 Select “Setup”.
- 3 Select “Phone”.
- 4 Select “Connect Phone”.

2  
BASIC FUNCTION



\*: Bluetooth is a registered trademark of Bluetooth SIG, Inc.

### REGISTERING A Bluetooth® DEVICE

Up to 5 Bluetooth® devices can be registered.

Bluetooth® compatible phones (HFP) and audio players (AVP) can be registered simultaneously.

This operation cannot be performed while driving.

1 Display the "Bluetooth\* Setup" screen. (→P.56)

2 Select "Add".

▶ When another Bluetooth® device is connected

● To disconnect the Bluetooth® device, select "Yes".

▶ When 5 Bluetooth® devices have already been registered

● A registered device needs to be replaced. Select "Yes", and select the device to be replaced.

\*: Bluetooth is a registered trademark of Bluetooth SIG, Inc.

3 When this screen is displayed, search for the device name displayed on this screen on the screen of your Bluetooth® device.



● For details about operating the Bluetooth® device, see the manual that comes with it.

● To cancel the registration, select "Cancel".

4 Register the Bluetooth® device using your Bluetooth® device.

● A PIN-code is not required for SSP (Secure Simple Pairing) compatible Bluetooth® devices. Depending on the type of Bluetooth® device being connected, a message confirming registration may be displayed on the Bluetooth® device's screen. Respond and operate the Bluetooth® device according to the confirmation message.

- 5 Check that the following screen is displayed when registration is complete.

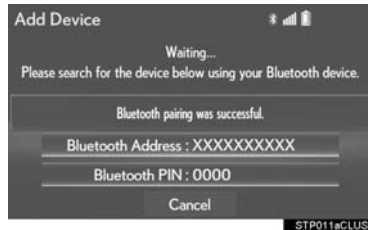

- The system waits for connection requests coming from the registered device.
  - At this stage, the Bluetooth® functions are not yet available.
- 6 Select "OK" when the connection status changes from "Connecting..." to "Connected".

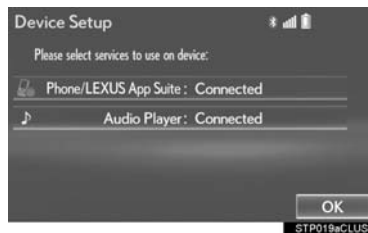

- If an error message is displayed, follow the guidance on the screen to try again.

## DELETING A Bluetooth® DEVICE

- 1 Display the "Bluetooth\* Setup" screen. (→P.56)
- 2 Select "Remove".
- 3 Select the desired device.



- 4 Select "Yes" when the confirmation screen appears.
- 5 Check that a confirmation screen is displayed when the operation is complete.

### INFORMATION

- When deleting a Bluetooth® phone, the contact data will be deleted at the same time.

\*: Bluetooth is a registered trademark of Bluetooth SIG, Inc.

2  
BASIC FUNCTION

### CONNECTING A Bluetooth® DEVICE

Up to 5 Bluetooth® devices (Phones (HFP) and audio players (AVP)) can be registered.

If more than 1 Bluetooth® device has been registered, select which device to connect to.

- 1 Display the "Bluetooth\* Setup" screen. (→P.56)
- 2 Select the device to be connected.



- Supported profile icons will be displayed.

 : Phone

 : Audio player

 : Phone/"LEXUS App Suite" service

- The profile icon for a currently connected device will be displayed in color.
- Selecting a profile icon which is not currently connected will switch the connection to the function.

- If the desired Bluetooth® device is not on the list, select "Add" to register the device. (→P.58)

\*: Bluetooth is a registered trademark of Bluetooth SIG, Inc.

- 3 Select the desired connection.



- ▶ When another Bluetooth® device is connected

- To disconnect the Bluetooth® device, select "Yes".

- 4 Check that a confirmation screen is displayed when the connection is complete.

- If an error message is displayed, follow the guidance on the screen to try again.

#### INFORMATION

- It may take time if the device connection is carried out during Bluetooth® audio playback.
- Depending on the type of Bluetooth® device being connected, it may be necessary to perform additional steps on the device.
- When disconnecting a Bluetooth® device, it is recommended to disconnect using the navigation system.

### ■ AUTO CONNECTION MODE

To turn auto connection mode on, set "Bluetooth\* Power" to on. (→P.64)  
Leave the Bluetooth® device in a location where the connection can be established.

- When the engine <power> switch is in ACCESSORY or IGNITION ON <ON> mode, the system searches for a nearby registered device.
- The system will connect with the registered device that was last connected, if it is nearby.

### ■ CONNECTING MANUALLY

When the auto connection has failed or "Bluetooth\* Power" is turned off, it is necessary to connect Bluetooth® manually.

- 1 Press the "MENU" button on the Remote Touch and select "Setup".
- 2 Select "Bluetooth\*".
- 3 Follow the steps in "CONNECTING A Bluetooth® DEVICE" from "STEP 2". (→P.60)

\*: Bluetooth is a registered trademark of Bluetooth SIG, Inc.

### ■ RECONNECTING THE Bluetooth® PHONE

If a Bluetooth® phone is disconnected due to poor reception from the Bluetooth® network when the engine <power> switch is in ACCESSORY or IGNITION ON <ON> mode, the system automatically reconnects the Bluetooth® phone.

2

BASICFUNCTION

### EDITING THE Bluetooth® DEVICE INFORMATION

The Bluetooth® device's information can be displayed on the screen. The displayed information can be edited.

- 1 Display the "Bluetooth\* Setup" screen. (→P.56)
- 2 Select the desired device to be edited.
- 3 Select "Device Info".

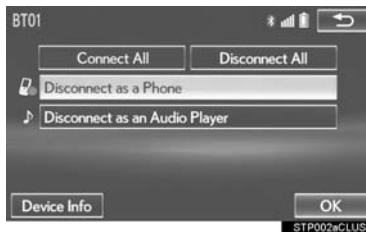

\*: Bluetooth is a registered trademark of Bluetooth SIG, Inc.

- 4 Confirm and change the Bluetooth® device information.

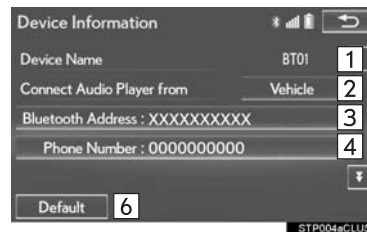

No.	Information
1	The name of the Bluetooth® device. Can be changed to a desired name. (→P.63)
2	Select to set the Bluetooth® audio player connection method. (→P.63)
3	Device address is unique to the device and cannot be changed.
4	Phone number of the Bluetooth® phone.
5	Compatibility profile of the Bluetooth® device.
6	Select to reset all setup items.

**INFORMATION**

- If 2 Bluetooth® devices have been registered with the same device name, the devices can be distinguished referring to the device's address.
- Depending on the type of phone, some information may not be displayed.

**CHANGING A DEVICE NAME**

- 1 Select "Device Name".
- 2 Enter the name and select "OK".

**INFORMATION**

- Even if the device name is changed, the name registered in your Bluetooth® device does not change.

**SETTING AUDIO PLAYER CONNECTION METHOD**

- 1 Select "Connect Audio Player from".
- 2 Select the desired connection method.

2  
BASIC FUNCTION

**"Vehicle"**: Select to connect the audio system to the audio player.

**"Device"**: Select to connect the audio player to the audio system.

- Depending on the audio player, the "Vehicle" or "Device" connection method may be best. As such, refer to the manual that comes with the audio player.
- To reset the connection method, select "Default".

## 2. Bluetooth® SETTINGS

### “System Settings” SCREEN

The Bluetooth® settings can be confirmed and changed.

- 1 Display the “Bluetooth\* Setup” screen. (→P.56)
- 2 Select “System Settings”.
- 3 Select the desired item to be set.



\*: Bluetooth is a registered trademark of Bluetooth SIG, Inc.

No.	Information	Page
1	Select to set Bluetooth® connection on/off.	65
2	Displays system name. Can be changed to a desired name.	65
3	PIN-code used when the Bluetooth® device was registered. Can be changed to a desired code.	65
4	Device address is unique to the device and cannot be changed.	—
5	Select to set the phone connection status display on/off.	—
6	Select to set the connection status display of the audio player on/off.	—
7	Compatibility profile of the system	—
8	Select to reset all setup items.	—



**CHANGING “Bluetooth\* Power”**

- 1 Select “Bluetooth\* Power”.

**When “Bluetooth\* Power” is on:**

The Bluetooth® device is automatically connected when the engine <power> switch is in ACCESSORY or IGNITION ON <ON> mode.

**When “Bluetooth\* Power” is off:**

The Bluetooth® device is disconnected, and the system will not connect to it next time.

**INFORMATION**

- While driving, the auto connection state can be changed from off to on, but cannot be changed from on to off.

**EDITING THE SYSTEM NAME**

- 1 Select “Bluetooth\* Name”.
- 2 Enter a name and select “OK”.

2

**EDITING THE PIN-CODE**

- 1 Select “Bluetooth\* PIN”.
- 2 Enter a PIN-code and select “OK”.

\*: Bluetooth is a registered trademark of Bluetooth SIG, Inc.

BASIC FUNCTION

### 3. OTHER SETTINGS

## 1. GENERAL SETTINGS

Settings are available for auto screen change, operation sounds, etc.

1 Press the “MENU” button on the Remote Touch.

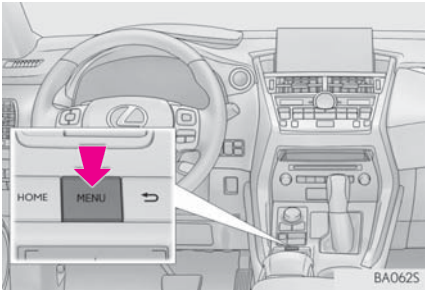

2 Select “Setup”.



3 Select “General”.

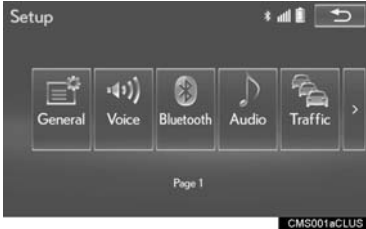

4 Select the items to be set.

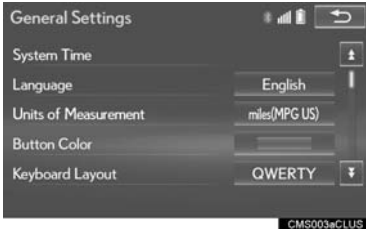

GENERAL SETTINGS SCREEN

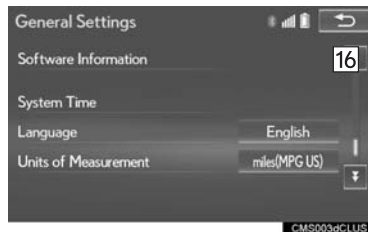
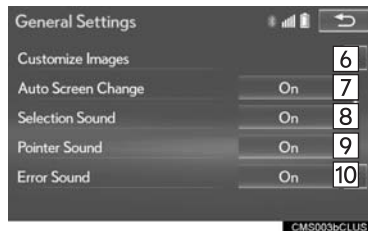
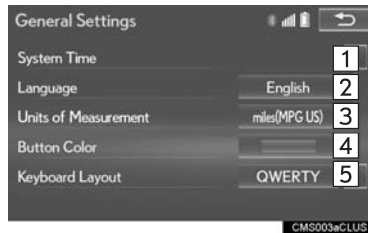

No.	Function
1	Select to change the time zone and set the daylight saving time on/off. (→P.66)
2	Select to change the language.
3	Select to change the unit of measure for distance/fuel consumption.
4	Select to change the screen button color.
5	Select to change the keyboard layout.
6	Select to customize the startup/screen off images. (→P.69)
7	Select to set automatic screen changes from the audio/air conditioning control screen to the previous screen to on/off. When set to on, the screen will automatically return to the previous screen from the audio/air conditioning control screen after 20 seconds.
8	Select to set the selection sounds on/off.
9	Select to set the pointer sounds on/off.
10	Select to set the error sounds on/off.

2  
BASIC FUNCTION

### 3. OTHER SETTINGS

No.	Function
11	Select to adjust the pointer sound volume.
12	Select to adjust the level of the feedback force to the touchpad, when selecting a screen button.
13	Select to delete personal data. (→P.72)
14	Select to update software versions. For details, contact your Lexus dealer.
15	Select to update "Gracenote" database versions. For details, contact your Lexus dealer.
16	Select to display the software information. Notices related to third party software used in this product are enlisted. (This includes instructions for obtaining such software, where applicable.)

#### SYSTEM TIME SETTINGS

Used for changing time zones and the on/off settings of daylight saving time.

- 1 Display the "General Settings" screen. (→P.66)
- 2 Select "System Time".
- 3 Select the items to be set.

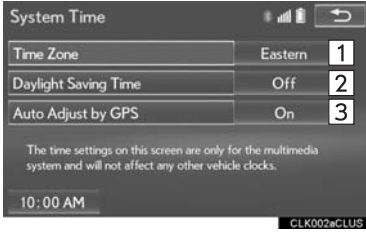

No.	Function
1	Select to change the time zone. (→P.69)
2	Select to set daylight saving time on/off.
3	Select to set automatic adjustment of the clock by GPS on/off. When set to on, the system will automatically adjust the clock to the current position's time zone when the vehicle moves to a different time zone.

■ SETTING THE TIME ZONE

- 1 Select "Time Zone".
- 2 Select the desired time zone.

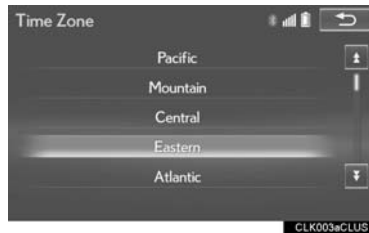

- If "Other" is selected, the zone can be adjusted manually. Select "+" or "-" to adjust the time zone.



CUSTOMIZING THE STARTUP AND SCREEN OFF IMAGES

2 BASIC FUNCTION

An image can be copied from a USB memory and used as the startup and screen off Images.

When the engine <power> switch is in ACCESSORY or IGNITION ON <ON> mode, the initial screen will be displayed. (→P.34)

When "Screen Off" on the "Display" screen is selected, the screen is turned off and the desired screen off image that is set is displayed. (To turn the screen off: →P.45)

- 1 Display the "General Settings" screen. (→P.66)
- 2 Select "Customize Images".
- 3 Select the items to be set.



No.	Function	Page
1	Select to copy images from a USB memory.	70
2	Select to delete images.	72
3	Select to set an image as the startup or screen off image.	71

### 3. OTHER SETTINGS

#### ■ TRANSFERRING IMAGES

- 1 Press the button to release the lock and lift the armrest.

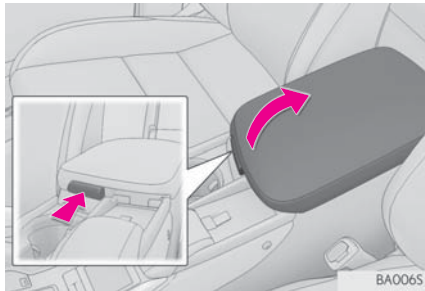

- 2 Open the cover and connect a USB memory.

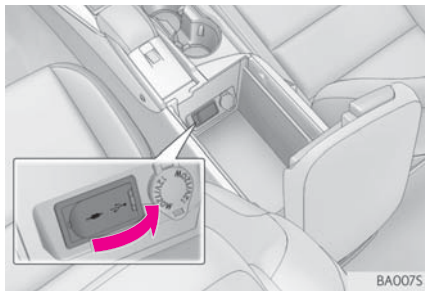

- Turn on the power of the USB memory if it is not turned on.

- 3 Select "Copy from USB".

- 4 Select the desired images from the list and then select "Copy".



- The selected image is displayed on the right side of the screen. If the selected image file is broken or incompatible,  will be displayed.
  - The remaining number of image files that can be transferred is displayed at the bottom of the screen.
- 5 Select "Yes" when the confirmation screen appears.

**INFORMATION**

- When saving image files to a USB memory to be transferred to the navigation system, save the images in a folder named "Image" (I-m-a-g-e, case sensitive). If a different folder name is used, the navigation system will not recognize the image files.
- The compatible file extensions are JPG and JPEG.
- An image's file name, including file extension, can be up to 32 characters.
- Image files of 10 MB or less can be transferred.
- Up to 10 images can be transferred to the navigation system.
- Files with non-ASCII filenames cannot be transferred.

**SETTING THE STARTUP AND SCREEN OFF IMAGES**

- 1 Select "Set Images".
- 2 Select the desired image.

2

BASIC FUNCTION



- 3 Select the desired items to be set.



No.	Function
1	Select to set an image as the startup image.
2	Select to set an image as the screen off image.
3	Select to set an image as both the startup and screen off image.

### 3. OTHER SETTINGS

#### ■ DELETING TRANSFERRED IMAGES

- 1 Select “Delete Images”.
- 2 Select the images to be deleted and select “Delete”.



- 3 Select “Yes” when the confirmation screen appears.

#### ■ DELETING PERSONAL DATA

- 1 Display the “General Settings” screen. (→P.66)
- 2 Select “Delete Personal Data”.
- 3 Select “Delete”.



- 4 Select “Yes” when the confirmation screen appears.
- Registered or changed personal settings will be deleted or returned to their default conditions.  
For example:
    - General settings
    - Navigation settings
    - Audio settings
    - Phone settings
    - Lexus Enform settings

#### ⚠ NOTICE

- Make sure the map SD card is inserted when deleting personal data. The personal data cannot be deleted when the map SD card is removed. To delete the data, after inserting the map SD card, turn the engine <power> switch to ACCESSORY or IGNITION ON <ON> mode.



### 3. OTHER SETTINGS

## 2. VOICE SETTINGS

Voice guidance etc. can be set.

- 1 Press the "MENU" button on the Remote Touch.

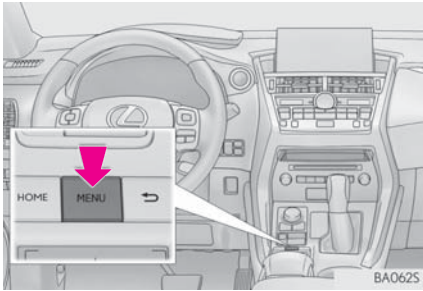

- 2 Select "Setup".



- 3 Select "Voice".

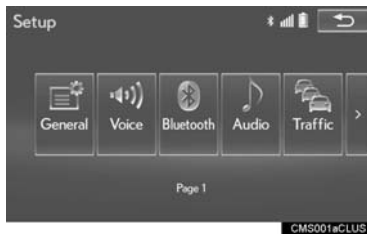

- 4 Select the items to be set.



#### INFORMATION

- "Voice Settings" screen can also be displayed from the voice recognition top screen. (→P.260)

2 BASICFUNCTION

### 3. OTHER SETTINGS

#### VOICE SETTINGS SCREEN

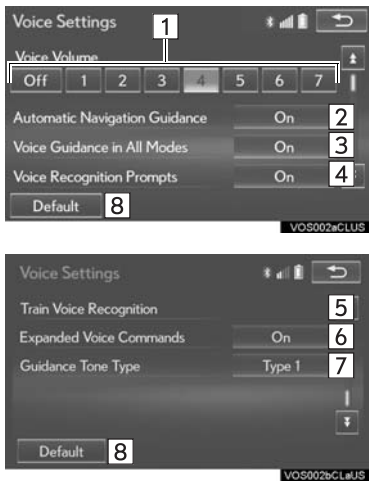

No.	Function
1	Select to adjust the volume of voice guidance.
2	Select to set the voice guidance during route guidance on/off.
3	Select to set the voice guidance during audio/visual and/or air conditioning system use on/off.
4	Select to set the voice recognition prompts on/off.
5	Select to train voice recognition. The voice command system adapt the user accent.
6	When "On" is selected, expanded voice commands can be operated using voice commands. (→P.265)
7	Select to set the beep sound of navigation guidance.
8	Select to reset all setup items.

### 3. OTHER SETTINGS

## 3. VEHICLE SETTINGS

Settings are available for maintenance, vehicle customization, etc.

- 1 Press the "MENU" button on the Remote Touch.

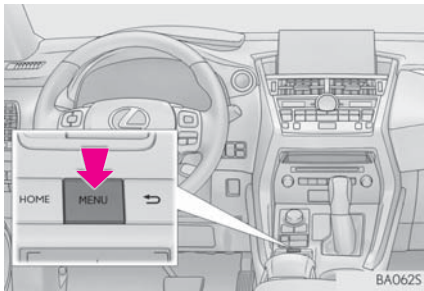

- 2 Select "Setup".



- 3 Select "Vehicle".



- 4 Select the desired item to be set.

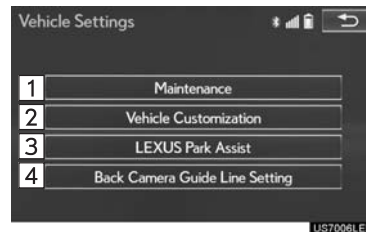

2 BASIC FUNCTION

No.	Function	Page
1	Select to set maintenance.	76
2	Select to set vehicle customization.	"Owner's Manual"
3	Select to set intuitive parking assist.	"Owner's Manual"
4	Select to set back camera guide line.	282

### 3. OTHER SETTINGS

#### MAINTENANCE

When the navigation system is turned on, the "Maintenance Reminder" screen displays when it is time to replace a part or certain components. (→P.35)

- 1 Display the "Vehicle Settings" screen. (→P.75)
- 2 Select "Maintenance".
- 3 Select the desired item.

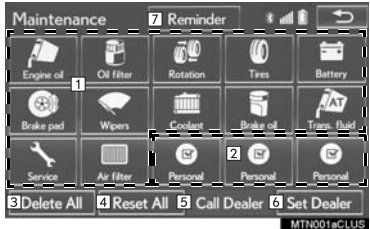

No.	Function
1	Select to set the condition of parts or components.
2	Select to add new information items separately from provided ones.
3	Select to cancel all conditions which have been entered.
4	Select to reset the items which have expired conditions.
5	Select to call the registered dealer.
6	Select to register/edit dealer information. (→P.78)
7	When set to on, the indicator will illuminate. The system is set to give maintenance information with the "Maintenance Reminder" screen. (→P.35)

**INFORMATION**

- When the vehicle needs to be serviced, the screen button color will change to orange.

**MAINTENANCE INFORMATION SETTING**

- 1 Select the desired part or component screen button.
- 2 Set the conditions.

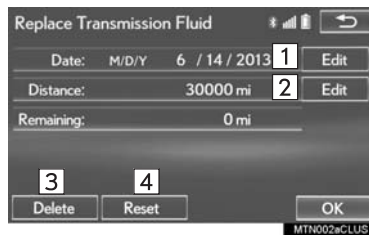

No.	Function
1	Select to enter the next maintenance date.
2	Select to enter the driving distance until the next maintenance check.
3	Select to cancel the conditions which have been entered.
4	Select to reset the conditions which have expired.

- 3 Select "OK" after entering the conditions.

**INFORMATION**

- For scheduled maintenance information, refer to "Warranty and Services Guide/Owner's Manual Supplement/Scheduled Maintenance".
- Depending on driving or road conditions, the actual date and distance that maintenance should be performed may differ from the stored date and distance in the system.

2 BASIC FUNCTION

**DEALER SETTING**

Dealer information can be registered in the system. With dealer information registered, route guidance to the dealer is available.

- 1 Select "Set Dealer".
- 2 Select the desired item to search for the location. (→P.105)

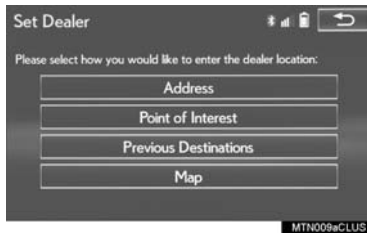

- The editing dealer screen appears after setting the location.

- 3 Select the items to be edited.

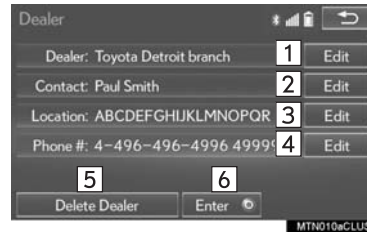

No.	Function	Page
1	Select to enter the name of a dealer.	79
2	Select to enter the name of a dealer member.	79
3	Select to set the location.	79
4	Select to enter the phone number.	79
5	Select to delete the dealer information displayed on the screen.	—
6	Select to set the displayed dealer as a destination.	121

■ EDITING DEALER OR CONTACT NAME

- 1 Select "Edit" next to "Dealer" or "Contact".
- 2 Enter the name and select "OK".

■ EDITING THE LOCATION

- 1 Select "Edit" next to "Location".
- 2 Scroll the map to the desired point (→P.92) and select "OK".

■ EDITING PHONE NUMBER

- 1 Select "Edit" next to "Phone #".
- 2 Enter the phone number and select "OK".

2

BASIC FUNCTION

# 3

## NAVIGATION SYSTEM

### 1 BASIC OPERATION

1. QUICK REFERENCE .....	82
MAP SCREEN.....	82
NAVIGATION OPTIONS SCREEN .....	84
2. MAP SCREEN OPERATION .....	85
CURRENT POSITION DISPLAY.....	85
MAP SCALE .....	86
ORIENTATION OF THE MAP.....	88
SWITCHING THE MAP MODE.....	89
SCREEN SCROLL OPERATION.....	91
ADJUSTING LOCATION IN SMALL INCREMENTS.....	92
3. MAP SCREEN INFORMATION.....	93
DISPLAYING MAP INFORMATION .....	93
DISPLAYING INFORMATION ABOUT THE ICON WHERE THE CURSOR IS SET .....	97
STANDARD MAP ICONS.....	99
4. TRAFFIC INFORMATION .....	100
DISPLAYING TRAFFIC INFORMATION ON THE MAP.....	103

### 2 DESTINATION SEARCH

1. DESTINATION SEARCH SCREEN.....	105
2. SEARCH OPERATION.....	107
SELECTING SEARCH AREA.....	108
SETTING HOME AS DESTINATION.....	109
SETTING PRESET DESTINATIONS AS DESTINATION .....	109
SEARCHING BY ADDRESS.....	110
SEARCHING BY POINT OF INTEREST .....	111
DESTINATION SEARCH BY DESTINATION ASSIST .....	116
SEARCHING FROM PREVIOUS DESTINATIONS.....	116
SEARCHING BY ADDRESS BOOK .....	117
SEARCHING BY EMERGENCY .....	117
SEARCHING BY INTERSECTION AND FREEWAY.....	118
SEARCHING BY MAP.....	119
SEARCHING BY COORDINATES.....	120
3. STARTING ROUTE GUIDANCE .....	121
STARTING ROUTE GUIDANCE.....	121
PAUSING GUIDANCE.....	124



# 3

## NAVIGATION SYSTEM

<b>3</b>	<b>ROUTE GUIDANCE</b>	<b>5</b>	<b>SETUP</b>	<b>3</b>	
1.	<b>ROUTE GUIDANCE SCREEN</b> .....	125	1.	<b>DETAILED NAVIGATION SETTINGS</b> .....	150
	SCREEN FOR ROUTE GUIDANCE.....	125		SCREENS FOR NAVIGATION SETTINGS.....	151
	ROUTE OVERVIEW .....	127	2.	<b>TRAFFIC SETTINGS</b> .....	156
	DURING FREEWAY DRIVING.....	128		SCREEN FOR TRAFFIC SETTINGS.....	157
	WHEN APPROACHING INTERSECTION.....	130		AUTO AVOID TRAFFIC .....	158
	TURN LIST SCREEN.....	130	<b>6</b>	<b>TIPS FOR THE NAVIGATION SYSTEM</b>	
	TURN-BY-TURN ARROW SCREEN.....	131	1.	<b>GPS (GLOBAL POSITIONING SYSTEM)</b> .....	159
2.	<b>TYPICAL VOICE GUIDANCE PROMPTS</b> .....	132		LIMITATIONS OF THE NAVIGATION SYSTEM.....	159
3.	<b>EDITING ROUTE</b> .....	133	2.	<b>MAP DATABASE VERSION AND COVERED AREA</b> .....	162
	ADDING DESTINATIONS .....	134		MAP INFORMATION .....	162
	REORDERING DESTINATIONS.....	134		ABOUT THE MAP DATA .....	163
	DELETING DESTINATIONS .....	135			
	SETTING ROUTE PREFERENCES.....	135			
	SELECTING ROUTE TYPE .....	136			
	DETOUR SETTING.....	136			
	STARTING FROM ADJACENT ROAD.....	137			
<b>4</b>	<b>MEMORY POINTS</b>				
1.	<b>MEMORY POINTS SETTINGS</b> .....	138			
	SETTING UP HOME .....	139			
	SETTING UP PRESET DESTINATIONS.....	141			
	SETTING UP ADDRESS BOOK .....	143			
	SETTING UP AREAS TO AVOID .....	146			
	DELETING PREVIOUS DESTINATIONS.....	149			

## 1. BASIC OPERATION

### 1. QUICK REFERENCE

#### MAP SCREEN

To display this screen, press the “MENU” button on the Remote Touch, then select “Nav” on the “Menu” screen.

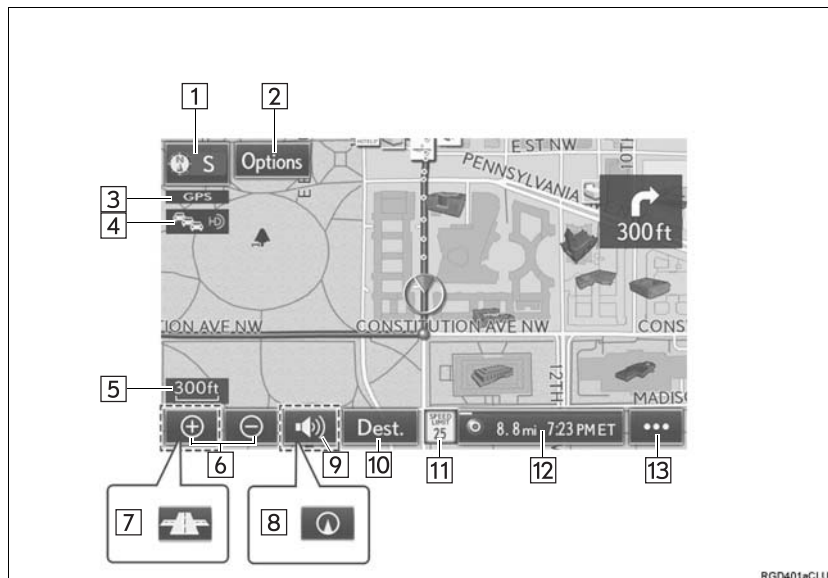

No.	Name	Function	Page
1	2D north up, 2D heading up or 3D heading up symbol	Indicates whether the map orientation is set to north-up or heading-up. The letter(s) beside this symbol indicate the vehicle's heading direction (e.g. N for north). In 3D map, only a heading-up view is available.	88
2	Options button	Select to display the “Navigation Options” screen.	84
3	“GPS” mark (Global Positioning System)	Shows that the vehicle is receiving signals from the GPS.	159
4	Traffic indicator	Shows that traffic information is received. Select to start voice guidance for traffic information. When traffic information is received via HD Radio broadcast, HD mark is displayed on the right.	100
5	Scale indicator	This figure indicates the map scale.	86

No.	Name	Function	Page
6	Zoom in/out button	Select to magnify or reduce the map scale. When either button is selected, the map scale indicator bar appears at the bottom of the screen.	86
7	Footprint map button	Select to display the footprint map screen.	86
8	Current position button	Select to display the current position address.	—
9	Voice guidance button	Select to repeat voice guidance.	132
10	Destination button	Select to display the "Destination" screen.	105
11	Speed limit icon	Indicates the speed limit on the current road. The display of the speed limit icon can be set to on/off.	93
12	Route information bar	Displays the current street name, or the distance with the estimated travel time/arrival time to the destination. The route information bar fills from left to right as the vehicle progresses on the route.	126
13	Route information button	Select to change the display between the current street name and the distance with the estimated travel/arrival time.	

## NAVIGATION OPTIONS SCREEN

The navigation options allow you to change map configurations, display/hide POI icons, and edit the navigation routes. To display the “Navigation Options” screen, press the “MENU” button on the Remote Touch, select “Nav” on the “Menu” screen, and select “Options” on the map screen.

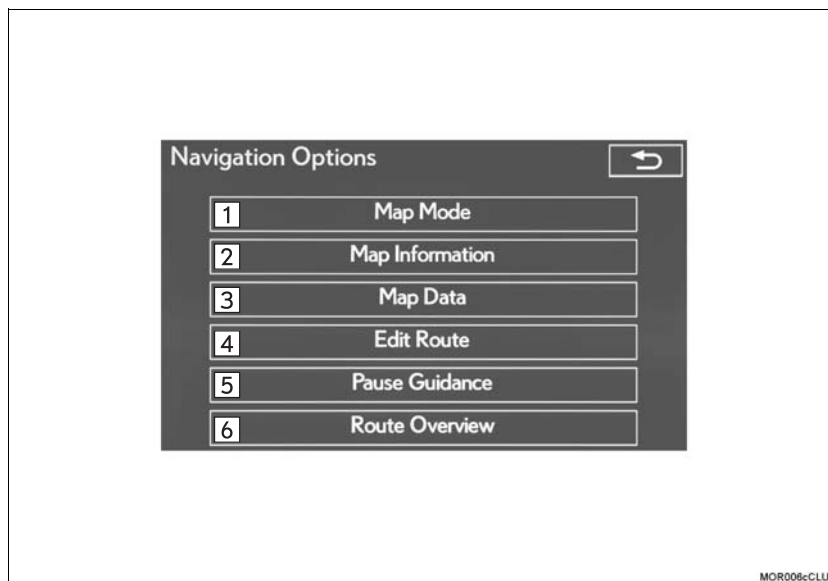

No.	Function	Page
1	Select to display the desired map configuration.	89
2	Select to set display of the map information such as POI icons, route trace, speed limit, etc.	93
3	Select to display the map version and coverage area.	162
4	Select to edit the set route.	133
5	Select to pause or resume route guidance.	124
6	Select to display the overview of the entire route.	127

## 1. BASIC OPERATION

# 2. MAP SCREEN OPERATION

### CURRENT POSITION DISPLAY

- 1 Press the "MENU" button on the Remote Touch.

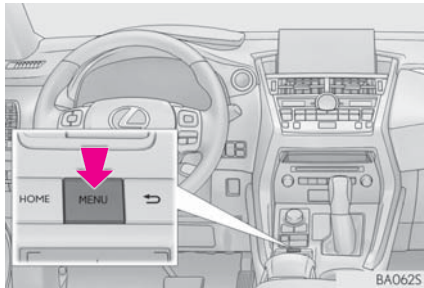

- 2 Select "Nav".

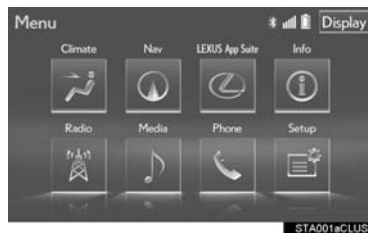

- 3 Check that the current position map is displayed.



- To correct the current position manually:  
→P.154

### INFORMATION

- While driving, the current position mark is fixed on the screen and the map moves.
- The current position is automatically set as the vehicle receives signals from the GPS (Global Positioning System). If the current position is not correct, it is automatically corrected after the vehicle receives signals from the GPS.
- After the 12-volt battery disconnection, or on a new vehicle, the current position may not be correct. As soon as the system receives signals from the GPS, the correct current position is displayed.

# 1. BASIC OPERATION

## MAP SCALE

1 Select or to change the scale of the map screen.



- The scale indicator bar appears at the bottom of the screen.
- Select and hold or to continue changing the scale of the map screen.
- The scale of the map screen can also be changed by selecting the scale bar directly. This function is not available while driving.

### INFORMATION

- The scale of the map screen can be changed by pinch operations with your fingers on the touchpad of the Remote Touch. (→P.38)
- The map scale is displayed above the zoom in button at the bottom left of the screen.
- In areas where the footprint map is available the map scale changes from to when at the minimum range.

## FOOTPRINT MAP

For areas covered by the footprint map (some major cities), a footprint map on a scale of 75 ft. (25 m) can be selected. When the map is scaled down to 150 ft. (50 m), changes to and can be selected to display the footprint map.

- 1 Select on the map screen.
- 2 Check that the footprint map is displayed.



- To return to the normal map display, select .

### INFORMATION

- If the map or the current position is moved to the area which is not covered by the footprint map, the screen scale automatically changes to 150 ft. (50 m).
- On the footprint map, a one way street is displayed by .
- Scrolling on the footprint map is not available while driving.

Building footprints in the database were created and provided by NAVTEQ.

### 3D CITY MODEL MAP

A 3D city model map can be displayed for some areas in major cities when the map scale is 700 ft. (200 m) or less on the 3D map screen.



- To display the normal map, select .

#### INFORMATION

- The 3D city model map can be set the display on/off. (→P.150)

### ROTATING 3D MAP

3D map and 3D city model map can be rotated when arrows appear around the cursor while scrolling.

- 1 Select an arrow to rotate.



#### INFORMATION

- The viewing angle of the 3D map can be changed. (→P.153)

3

NAVIGATION SYSTEM

# 1. BASIC OPERATION

## ORIENTATION OF THE MAP

The orientation of the map can be changed between 2D north-up, 2D heading-up and 3D heading-up by selecting the orientation symbol displayed at the top left of the screen.

1 Select ,  or .

▶ North-up screen



▶ Heading-up screen



▶ 3D screen



 E : North-up symbol

Regardless of the direction of vehicle travel, north is always up.

 E : Heading-up symbol

The direction of vehicle travel is always up.

 E : 3D Heading-up symbol

The direction of vehicle travel is always up.

- The letter(s) beside this symbol indicate the vehicle's heading direction (e.g. N for north).



## SWITCHING THE MAP MODE

- 1 Select "Options" on the map screen.
- 2 Select "Map Mode".

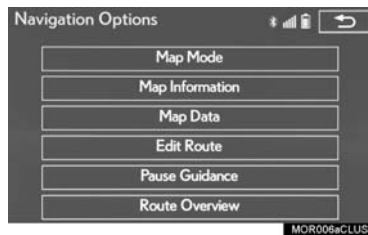

- 3 Select the desired configuration button.

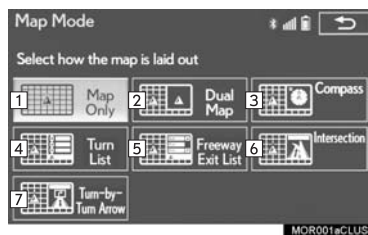

No.	Function	Page
1	Select to display the single map screen.	90
2	Select to display the dual map screen.	90
3	Select to display the compass mode screen.	91
4	Select to display the turn list screen.	130
5	Select to display the freeway exit list screen.	128
6	Select to display the intersection guidance screen or the guidance screen on the freeway.	130
7	Select to display the turn-by-turn arrow screen.	131

3

NAVIGATION SYSTEM

- Depending on the conditions, certain screen configuration buttons cannot be selected.

# 1. BASIC OPERATION

## MAP ONLY



## DUAL MAP



- The map on the left is the main map.

## Editing right map

The right side map can be edited.

- 1 Select any point on the right side map.
- 2 Select the desired item.



No.	Function	Page
1	Select to change the orientation of the map.	88
2	Select to display POI icons.	94
3	Select to show traffic information.	100
4	Select to display eDestination icons.	364
5	Select to change the map scale.	86

- When set to on, the indicator will illuminate.

■ COMPASS

Information about the destination, current position and a compass is displayed on the screen.



INFORMATION

- The destination mark is displayed in the direction of the destination. When driving, refer to the longitude and latitude coordinates, and the compass, to make sure that the vehicle is headed in the direction of the destination.
- When the vehicle travels out of the coverage area, the guidance screen changes to the whole compass mode screen.

SCREEN SCROLL OPERATION

Use the scroll feature to move the desired point to the center of the screen for looking at a point on the map that is different from the current position.



3

NAVIGATION SYSTEM

No.	Information/Function
1	Cursor mark
2	Distance from the current position to the cursor mark.
3	Select to set as a destination. When selecting "Go to" on the following map screen, the navigation system performs a search for the route. (→P.121) If a destination has already been set, "Go to" and "Add to Route" will be displayed. "Go to": Select to delete the existing destination(s) and set a new one. "Add to Route": Select to add a destination.
4	Select to register as a memory point. To change the icon, name, etc.: →P.143
5	Select to return to the current position.

## 1. BASIC OPERATION

- To scroll over the map screen, place the cursor mark in the desired position and then press and hold the touchpad of the Remote Touch. The map will continue scrolling in that direction until the touchpad is released.

### ADJUSTING LOCATION IN SMALL INCREMENTS

The cursor location can be adjusted in small increments when **“Adjust Location”** is selected on the setting map screen.

Also, when changing the location of memory points on the editing screen (→P.145) and adjusting the current position mark manually on the “Calibration” screen (→P.154), 8 directional arrows may appear for this purpose.

- 1 Select one of the 8 directional arrows to move the cursor to the desired point and then select **“OK”**.



## 1. BASIC OPERATION

### 3. MAP SCREEN INFORMATION

#### DISPLAYING MAP INFORMATION

Information such as POI icons, route trace, speed limit, etc. can be displayed on the map screen.

- 1 Select "Options" on the map screen.
- 2 Select "Map Information".

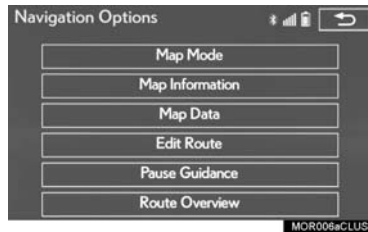

- 3 Select the desired items to be displayed.

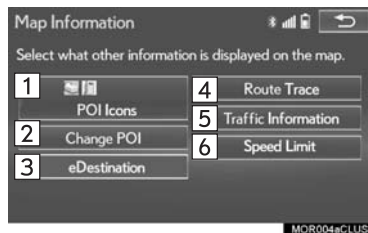

No.	Function	Page
1	Select to display the selected POI icons.	—
2	Select to select or change POI icons.	94
3	Select to display eDestination icons.	364
4	Select to display route trace.	96
5	Select to display traffic information.	100
6	Select to display speed limit icon.	—

3

NAVIGATION SYSTEM

- When set to on, the indicator will illuminate.

# 1. BASIC OPERATION

## SELECTING THE POI ICONS

- 1 Display the "Map Information" screen. (→P.93)
- 2 Select "Select POI".

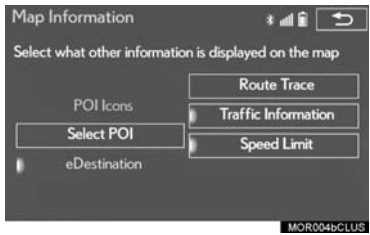

- When the POI icons to be displayed on the map screen have already been set, "Change POI" is displayed.

- 3 Select the desired POI category and select "OK".

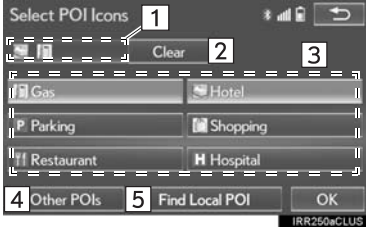

No.	Information/Function	Page
1	Displays up to 5 selected POI icons on the map screen.	–
2	Select to cancel the selected POI icons.	–
3	Displays up to 6 POI icons as favorite POI categories	152
4	Select to display other POI categories if the desired POIs cannot be found on the screen.	95
5	Select to search for the nearest POIs.	95

### ■ SELECTING OTHER POI ICONS TO BE DISPLAYED

- 1 Select "Other POIs".
- 2 Select the desired POI categories and select "OK".



"List All Categories": Select to display all POI categories. To add more POI categories, select "More".

### ■ DISPLAYING THE LOCAL POI LIST

POIs that are within 20 miles (32 km) of the current position will be listed from among the selected categories.

- 1 Select "Find Local POI".
- 2 Select the desired POI.



"Near...": Select to search for POIs near the current position or along the route.

- 3 Check that the selected POI is displayed on the map screen. (→P.91)



3

NAVIGATION SYSTEM

## 1. BASIC OPERATION

► When “Near...” is selected

- 1 Select the desired item.



“Near Here”: Select to search for POIs near the current position.

“Along My Route”: Select to search for POIs along the route.

## ROUTE TRACE

The traveled route can be stored and re-traced on the map screen. This feature is available when the map scale is 30 miles (50 km) or less.

- 1 Display the “Map Information” screen. (→P.93)
- 2 Select “Route Trace”.
  - The “Route Trace” indicator illuminates and the route trace starts.
- 3 Check that the traveled line is displayed.





■ STOP RECORDING THE ROUTE TRACE

- 1 Select "Route Trace" again.
- 2 A confirmation screen will be displayed.  
 "Yes": Select to keep the recorded route trace.  
 "No": Select to erase the recorded route trace.

(INFORMATION)

- The traveled route can be stored up to 124 miles (200 km).

DISPLAYING INFORMATION ABOUT THE ICON WHERE THE CURSOR IS SET

When the cursor is placed over an icon on the map screen, the name bar is displayed on the upper part of the screen. If "Info" appears on the right side of the name bar, detailed information can be displayed.

- 1 Place the cursor over an icon.
- 2 Select "Info".

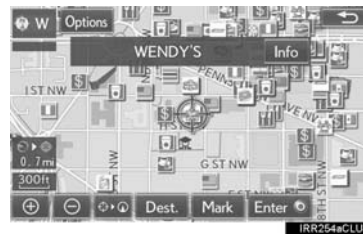

▶ POI information

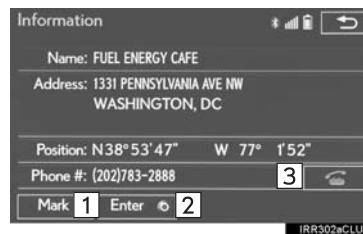

▶ Memory point information

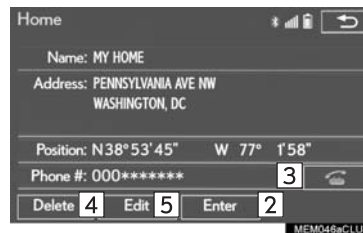

3 NAVIGATION SYSTEM

# 1. BASIC OPERATION

▶ Destination information

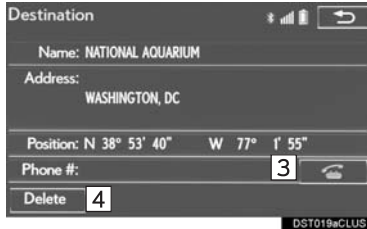

▶ Traffic information



No.	Function
1	Select to register as a memory point. To change the icon, name, etc.: →P.143
2	Select to set as a destination.
3	Select to call the registered number.
4	Select to delete destination or memory point.
5	Select to display the edit memory point screen.
6	Select to display detailed information.

**INFORMATION**

- Even when traffic information is not currently being received, traffic information and "Info" will be displayed for a while after traffic information has been received.

## STANDARD MAP ICONS

Icon	Name
	Island
	Park
	Industry
	Business facility
	Airport
	Military
	University
	Hospital
	Stadium
	Shopping mall
	Golf

## 1. BASIC OPERATION

# 4. TRAFFIC INFORMATION

Traffic data can be received via HD Radio broadcast or LEXUS App Suite to display traffic information on the map screen.

- 1 Press the "MENU" button on the Remote Touch.

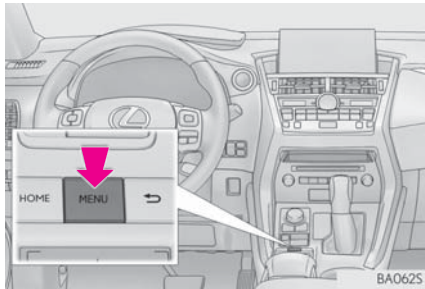

- 2 Select "Info".



- 3 Select "Traffic Incidents".



- 4 Select the desired item.

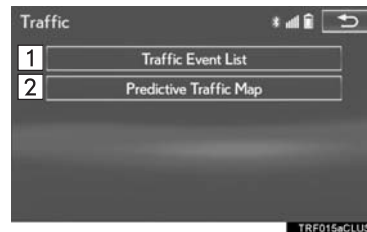

No.	Function	Page
1	Select to display a list of current traffic information.	101
2	Select to display a map with predictive traffic data.	102

## DISPLAYING TRAFFIC INFORMATION

A list of current traffic information can be displayed along with information on the incident's distance and position relative to the vehicle.

- 1 Display the "Traffic" screen. (→P.100)
- 2 Select "Traffic Event List".
- 3 Select the desired traffic information.



**"On Current Road"**: Select to display traffic information for the current road.

**"On Current Route"**: Select to display traffic information for the set route.

- When set to on, the indicator will illuminate.

- 4 Check that the traffic information is displayed.



**"Detail"**: Select to display detailed traffic information.

3

NAVIGATION SYSTEM

## DISPLAYING PREDICTIVE TRAFFIC INFORMATION

A map with predictive traffic data can be displayed.

- 1 Display the "Traffic" screen. (→P.100)
- 2 Select "Predictive Traffic Map".
- 3 Scroll the map to the desired point and set the time of predictive traffic information. Then select "Info".



- The time of the predictive traffic information can be displayed in 15-minute steps up to +45 minutes.
- "+": Moves the time forward 15 minutes.
- “-”: Moves the time back 15 minutes.

- 4 Check that the traffic information is displayed.



- "Detail": Select to display detailed traffic information.

**DISPLAYING TRAFFIC INFORMATION ON THE MAP**

- 1 Select "Options" on the map screen.
- 2 Select "Map Information".

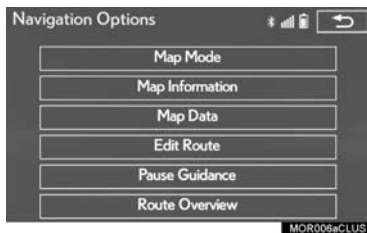

- 3 Select "Traffic Information".

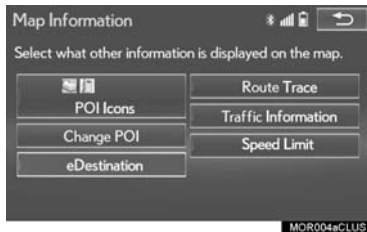

- When set to on, the indicator will illuminate.

- 4 Check that the traffic information is displayed.

▶ On the map screen





▶ On the freeway information screen



3 NAVIGATION SYSTEM

## 1. BASIC OPERATION

No.	Information/Function
1	The icons show traffic incident, road repair, traffic obstacles, etc. Select to display traffic information and start voice guidance for the traffic information.
2	The color of the arrow changes depending on the traffic information received.
3	The indicator is displayed as follows.  : Traffic information has been received.  : Traffic information has been received via HD Radio broadcast. No icon: Any traffic information has not been received.



## 2. DESTINATION SEARCH

### 1. DESTINATION SEARCH SCREEN

The “Destination” screen enables to search for a destination. To display the “Destination” screen, press the “MENU” button on the Remote Touch, and select “Nav” on the “Menu” screen. Then select “Dest.” on the map screen.

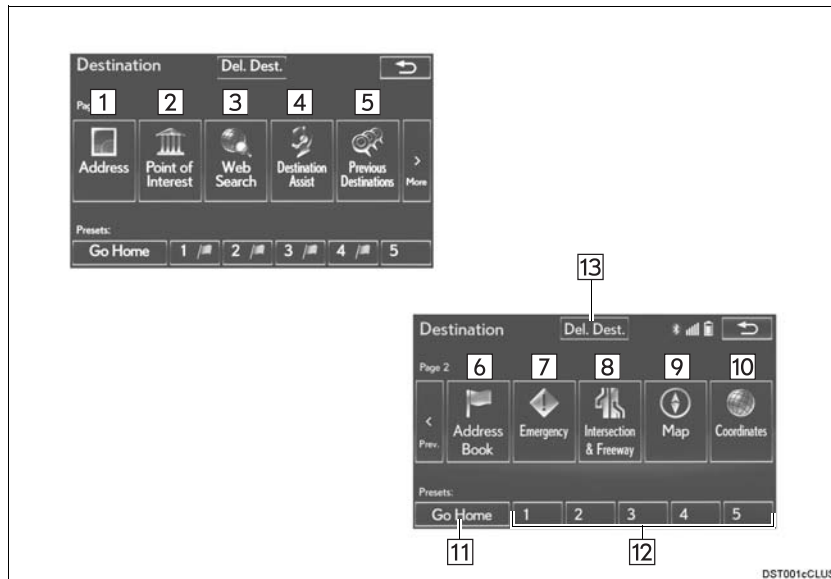

3

NAVIGATION SYSTEM

No.	Function	Page
1	Select to search for a destination by address.	110
2	Select to search for a destination by point of interest.	111
3	Select to search for a destination by online database.	358
4	Select to search for a destination via the Lexus response center.	363
5	Select to search for a destination from previously set destinations.	116
6	Select to search for a destination from a registered entry in “Address Book”.	117
7	Select to search for a destination from emergency service points.	117
8	Select to search for a destination by intersection or freeway entrance/exit.	118
9	Select to search for a destination by the last displayed map.	119

## 2. DESTINATION SEARCH

No.	Function	Page
10	Select to search for a destination by coordinates.	120
11	Select to set a destination by home.	109
12	Select to set a destination from preset destinations.	109
13	Select to delete set destinations.	135

## 2. DESTINATION SEARCH

### 2. SEARCH OPERATION

- 1 Press the "MENU" button on the Remote Touch.

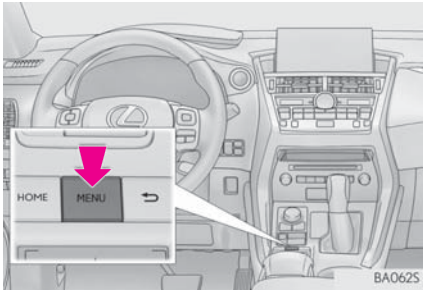

- 2 Select "Nav".

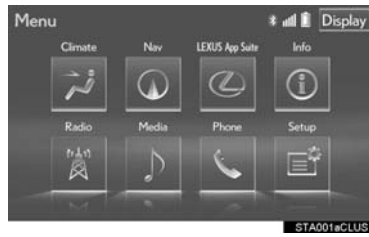

- 3 Select "Dest.".



- 4 Search for a destination.



- There are different kinds of methods to search for a destination. (→P.105)

3  
NAVIGATION SYSTEM

## 2. DESTINATION SEARCH

- 5 Select “Go” when the confirm destination screen is displayed.



No.	Function
1	Select to adjust the position in smaller increments. (→P.92)
2	Select to register as a memory point.
3	Select to search for the route. (→P.121) If a destination has already been set, “Go Directly” and “Add to Route” will be displayed. “Go Directly”: Select to delete the existing destination(s) and set a new one. “Add to Route”: Select to add a destination.
4	Select to call the registered number.

## SELECTING SEARCH AREA

The selected state (province) can be changed to set a destination from a different state (province) by using “Address”, “Point of Interest” or “Intersection & Freeway”.

- 1 Display the “Destination” screen. (→P.107)
- 2 Select “Address”, “Point of Interest” or “Intersection & Freeway”.
- 3 Select “Select State/Province” or “Change State/Province”.

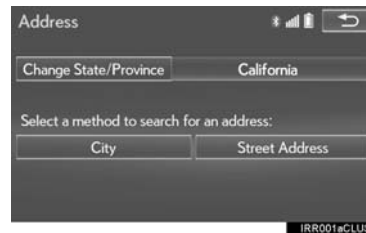

- If a state (province) has not been selected yet, “Select State/Province” is displayed.
- 4 Select the desired state (province).



- To change countries, select the “United States”, “Canada” or “Mexico” tab.
- For map database information and updates: →P.162

### SETTING HOME AS DESTINATION

To use this function, it is necessary to register a home address. (→P.139)

- 1 Display the “Destination” screen. (→P.107)
- 2 Select “Go Home”.
  - The navigation system performs a search for the route and the entire route map is displayed. (→P.121)

### SETTING PRESET DESTINATIONS AS DESTINATION

To use this function, it is necessary to register preset destinations to the preset screen buttons (1-5). (→P.141)

- 1 Display the “Destination” screen. (→P.107)
- 2 Select any of the preset destination buttons (1-5).

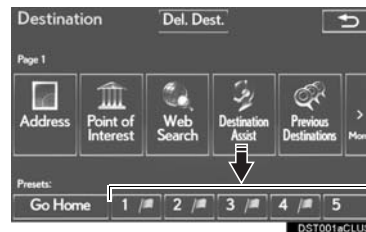

- The navigation system performs a search for the route and the entire route map is displayed. (→P.121)

## 2. DESTINATION SEARCH

### SEARCHING BY ADDRESS

There are 2 methods to search for a destination by address.

- 1 Display the "Destination" screen. (→P.107)
- 2 Select "Address".
- 3 Select the desired search method.



No.	Function	Page
1	Select to search by city.	110
2	Select to search by street address.	111

### SEARCHING BY CITY

- 1 Select "City".
- 2 Enter a city name and select "OK".



"Last 5 Cities": Select the city name from the list of the last 5 cities.

- 3 Select the desired city name.
  - 4 Enter a street name and select "OK".
  - 5 Select the desired street name.
  - 6 Enter a house number and select "OK".
- If the same address exists, the address list screen will be displayed. Select the desired address.

**SEARCHING BY STREET ADDRESS**

- 1 Select "Street Address".
- 2 Enter a house number and select "OK".



- 3 Enter a street name and select "OK".
  - 4 Select the desired street name.
  - 5 Enter a city name and select "OK".
  - 6 Select the desired city name.
- If the same address exists, the address list screen will be displayed. Select the desired address.

**(INFORMATION)**

- A street name can be searched using only the body part of its name.  
For example: S WESTERN AVE
  - A search can be performed by entering "S WESTERN AVE", "WESTERN AVE" or "WESTERN".

**SEARCHING BY POINT OF INTEREST**

There are 4 methods to search for a destination by Points of Interest.

- 1 Display the "Destination" screen. (→P.107)
- 2 Select "Point of Interest".
- 3 Select the desired search method.



No.	Function	Page
1	Select to search by name.	112
2	Select to search by category.	114
3	Select to search by phone number.	115
4	Select to search by eDestination.	366

3 NAVIGATION SYSTEM

## 2. DESTINATION SEARCH

### SEARCHING BY NAME

- 1 Select "Name".
- 2 Enter a POI name and select "OK".
- 3 Select the desired POI.



No.	Function	Page
1	Select to search for POI in the desired city.	112
2	Select to search for POI from the category list.	112
3	Select to search for POI using online database.	113

- When entering the name of a specific POI, and there are 2 or more sites with the same name, the list screen will be displayed. Select the desired POI.

#### INFORMATION

- To search for a facility name using multiple search words, put a space between each word.

### SELECTING A CITY TO SEARCH

- 1 Select "City".
- 2 Enter a city name and select "OK".



"Any City": Select to cancel the city setting.

- 3 Select the desired city name.
- 4 Select the desired POI.

### SELECTING FROM THE CATEGORIES

- 1 Select "Category".
- 2 Select the desired category.



- If there is more than 1 detailed item of the selected category, the detailed list will be displayed.

"List All Categories": Select to display all POI categories.

- 3 Select the desired POI.



**SEARCHING FOR POI USING WEB SEARCH**

1 Select “▼” next to “Web Search” to select a search engine.

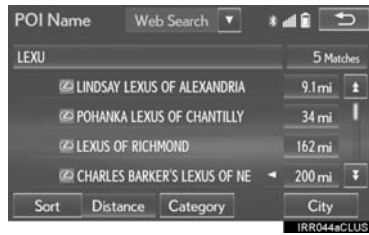

2 Select the desired search engine icon.



● The selected search engine icon will be displayed on the top center of the POI list screen.

3 Select the search engine icon.

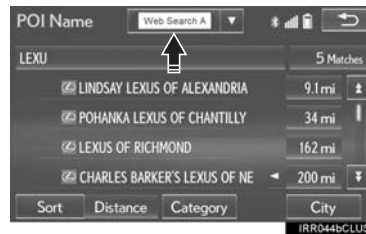

● Accessing to a search engine  
For the procedure on how to conduct a search via a search engine, go to “SETTING A DESTINATION USING LEXUS App Suite” (→P.359), and follow the steps from 3 onward.

3  
NAVIGATION SYSTEM

## 2. DESTINATION SEARCH

### SEARCHING BY CATEGORY

- 1 Select "Category".
- 2 Select the desired search point.

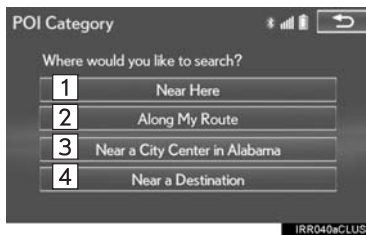

No.	Function
1	Select to set the search point from near the current position.
2	Select to search for POIs along the set route.
3	Select to set the search point from near a city center. (→P.115)
4	Select to set the search point from near a destination.

- 3 Select the desired POI category.



- If there is more than 1 detailed item of the selected category, the detailed list will be displayed.

"List All Categories": Select to display all POI categories.

"Favorite POI Categories": Select to use the 6 POIs that have been previously set.(→P.152)

- 4 Select the desired POI.

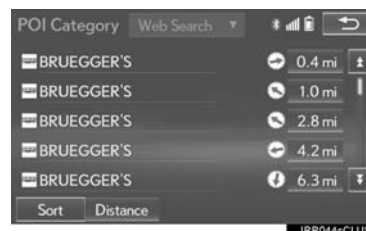

"Web Search": Select to search for POI using online database. (→P.113)

#### INFORMATION

- The names of POIs located within approximately 200 miles (320 km) from the selected search point can be displayed.

▶ When “Near a City Center in XX\*” is selected

- 1 Select “Near a City Center in XX”.
  - 2 Enter a city name and select “OK”.  
“Last 5 Cities”: Select the city name from the list of the last 5 cities.
  - 3 Select the desired city name.
  - 4 Select “OK” when the city center map screen is displayed.
  - 5 Follow the steps from 3 onward in “SEARCHING BY CATEGORY”. (→P.114)
- \*: XX represents the selected search area name.

**INFORMATION**

- If the navigation system has never been used, selecting the city name from “Last 5 Cities” will not be available.

**SEARCHING BY PHONE NUMBER**

- 1 Select “Phone #”.
- 2 Enter a phone number and select “OK”.
  - If there is more than 1 site with the same number, the list screen will be displayed.

**INFORMATION**

- If there is no match for the entered phone number, a list of identical numbers with different area codes will be displayed.

## 2. DESTINATION SEARCH

### DESTINATION SEARCH BY DESTINATION ASSIST

The destination can be searched by calling an operator of Destination Assist. You can request either a specific business, address, or ask for help locating your desired destination. (→P.363)

### SEARCHING FROM PREVIOUS DESTINATIONS

- 1 Display the “Destination” screen. (→P.107)
- 2 Select “Previous Destinations”.
- 3 Select the desired destination.

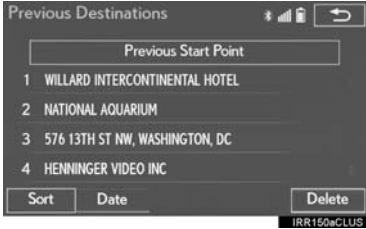

“Previous Start Point”: Select to display the start point map of the previous guided route.

“Delete”: Select to delete the previous destination. (→P.149)

#### INFORMATION

- The previous start point and up to 100 previously set destinations are displayed on the screen.

SEARCHING BY ADDRESS BOOK

To use this function, it is necessary to register an address book entry. (→P.143)

- 1 Display the “Destination” screen. (→P.107)
- 2 Select “Address Book”.
- 3 Select the desired address book entry.

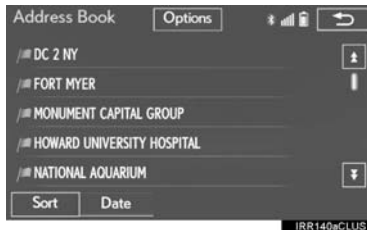

“Options”: Select to register or edit address book entries. (→P.144)

SEARCHING BY EMERGENCY

- 1 Display the “Destination” screen. (→P.107)
- 2 Select “Emergency”.
- 3 Select the desired emergency category.



- 4 Select the desired destination.

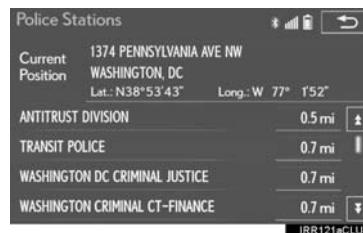

3  
NAVIGATION SYSTEM

INFORMATION

- The navigation system does not guide in areas where route guidance is unavailable. (→P.160)

## 2. DESTINATION SEARCH

### SEARCHING BY INTERSECTION AND FREEWAY

There are 2 methods to search for a destination by Intersection & Freeway.

- 1 Display the "Destination" screen. (→P.107)
- 2 Select "Intersection & Freeway".
- 3 Select the desired method.



No.	Function	Page
1	Select to search by intersection.	118
2	Select to search by freeway entrance/exit.	119

### SEARCHING BY INTERSECTION

- 1 Select "Intersection".
- 2 Enter the name of the first intersecting street which is located near the destination and select "OK".
- 3 Select the desired street name.



- 4 Enter the name of the second intersecting street and select "OK".
- 5 Select the desired street name.



- If the 2 streets cross at more than 1 intersection in a city, the list of intersections will be displayed.

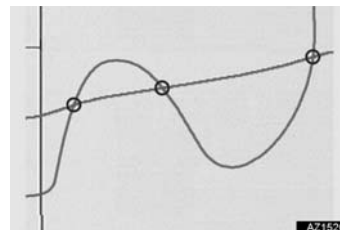

### SEARCHING BY FREEWAY ENTRANCE/EXIT

- 1 Select **"Freeway Entrance / Exit"**.
- 2 Enter a freeway name and select **"OK"**.
- 3 Select the desired freeway.
- 4 Select **"Entrance"** or **"Exit"**.



- 5 Enter a freeway entrance or exit name and select **"OK"**.
- 6 Select the desired entrance or exit name.

#### INFORMATION

- Be sure to use the complete name of the freeway or highway, including the hyphen, when entering the destination. Freeways and interstates use an "I" (I-405). US highways use the state designation before the number (CA-118).

### SEARCHING BY MAP

By selecting **"Map"** the last displayed location is displayed again on the map screen. You can search for a destination from this map.

- 1 Display the **"Destination"** screen. (→P.107)
- 2 Select **"Map"**.
- 3 Scroll the map to the desired point and select **"Go to Ⓞ"**.



**"Adjust Location"**: Select to adjust the position in smaller increments. (→P.92)

- If a destination has already been set, **"Go to Ⓞ"** and **"Add to Route"** will be displayed.

**"Go to Ⓞ"**: Select to delete the existing destination(s) and set a new one.

**"Add to Route"**: Select to add a destination.

- The navigation system performs a search for the route and the entire route map is displayed. (→P.121)

## 2. DESTINATION SEARCH

### SEARCHING BY COORDINATES

- 1 Display the “Destination” screen. (→P.107)
- 2 Select “Coordinates”.
- 3 Enter the latitude and longitude and select “OK”.

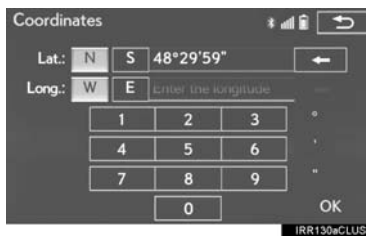



## 2. DESTINATION SEARCH

### 3. STARTING ROUTE GUIDANCE

When the destination is set, the entire route map from the current position to the destination is displayed.

#### STARTING ROUTE GUIDANCE

1 Select "OK" to start guidance.

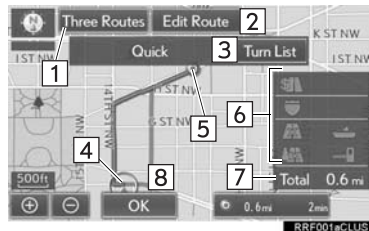

No.	Information/Function
1	Select the desired route from 3 possible routes. (→P.122)
2	Select to change the route. (→P.123)
3	Select to display a list of the turns required to reach the destination. (→P.123)
4	Current position
5	Destination point
6	Type of route and its distance
7	Distance of the entire route
8	Select to start guidance. If "OK" is selected and held until a beep sounds, demo mode will start. Press the "HOME" button on the Remote Touch to end demo mode.

#### ! WARNING

- Be sure to obey traffic regulations and keep road conditions in mind while driving. If a traffic sign on the road has been changed, the route guidance may not indicate such changed information.

#### INFORMATION

- The route for returning may not be the same as that for going.
- The route guidance to the destination may not be the shortest route or a route without traffic congestion.
- Route guidance may not be available if there is no road data for the specified location.
- When setting the destination on a map with a scale more than 0.5 mile (800 m), the map scale changes to 0.5 mile (800 m) automatically. If this occurs, set the destination again.
- If a destination that is not located on a road is set, the vehicle will be guided to the point on a road nearest to the destination. The road nearest to the selected point is set as the destination.

3

NAVIGATION SYSTEM

## 2. DESTINATION SEARCH

### 3 ROUTES SELECTION

- 1 Select "Three Routes".
- 2 Select the desired route.

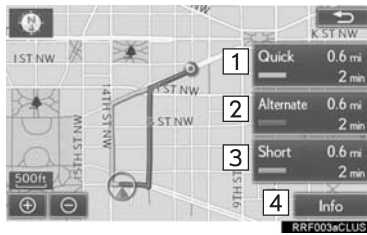

No.	Function
1	Select to display the quickest route.
2	Select to display the alternative route.
3	Select to display the route that is the shortest distance to the set destination.
4	Select to display the information about the 3 routes. (→P.122)

### DISPLAYING 3 ROUTES INFORMATION

- 1 Select "Info".
- 2 Check that the "Information for Three Routes" screen is displayed.

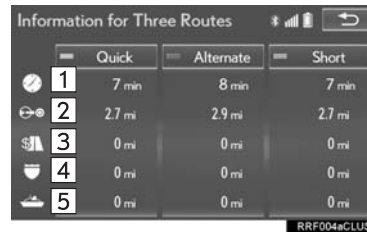

No.	Information
1	Time necessary for the entire trip
2	Distance of the entire trip
3	Distance of the toll road
4	Distance of the freeway
5	Distance of the ferry trip

**DISPLAYING TURN LIST**

A list of turn information from the current position to the destination can be displayed.

- 1 Select "Turn List".
- 2 Check that the turn list is displayed.



No.	Information
1	Current position
2	Distance to the next turn
3	Turn direction at the intersection
4	Select to display the map of the selected point.

**INFORMATION**

- However, not all road names on the route may appear on the list. If a road changes its name without requiring a turn (such as on a street that runs through 2 or more cities), the name change will not appear on the list. The street names will be displayed in order from the starting point, along with the distance to the next turn.

**EDITING ROUTE**

Destinations can be added, reordered or deleted, and conditions for the route to the destination can be changed.

- 1 Select "Edit Route".
- 2 Select the desired item.

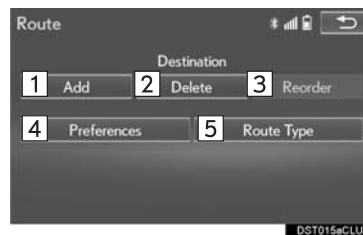

No.	Function	Page
1	Select to add destinations.	134
2	Select to delete destinations.	135
3	Select to reorder destinations.	134
4	Select to set route preferences.	135
5	Select to change route type.	136

3

NAVIGATION SYSTEM

## 2. DESTINATION SEARCH

### INFORMATION

- Even if the "Freeways" indicator is dimmed, the route cannot avoid including a freeway in some cases. (→P.135)
- If the calculated route includes a trip by ferry, the route guidance shows a sea route. After traveling by ferry, the current position may be incorrect. Upon reception of GPS signals, it is automatically corrected.

### PAUSING GUIDANCE

- 1 Select "Options" on the map screen.
- 2 Select "Pause Guidance".

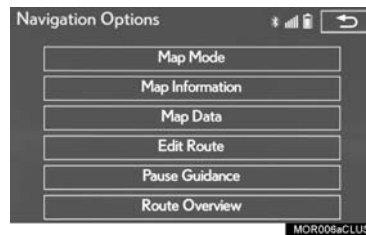

### RESUMING GUIDANCE

- 1 Select "Resume Guidance".



### 3. ROUTE GUIDANCE

## 1. ROUTE GUIDANCE SCREEN

During the route guidance, various types of guidance screens can be displayed depending on conditions.

### SCREEN FOR ROUTE GUIDANCE



No.	Information
1	Distance to the next turn and an arrow indicating the turning direction
2	Guidance route
3	Current position
4	Current street name or route information

#### INFORMATION

- If the vehicle goes off the guidance route, the route is searched again.
- For some areas, the roads have not been completely digitized in our database. For this reason, the route guidance may select a road that should not be traveled on.
- When arriving at the set destination the destination name will be displayed on the upper part of the screen.

3

NAVIGATION SYSTEM

### 3. ROUTE GUIDANCE

#### CHANGING ROUTE INFORMATION BAR

When the vehicle is on the guidance route, the route information bar displays the current street name or the distance with the estimated travel/arrival time to the destination.

- 1 Select the route information bar (1) or the route information button (2) to change the display of the route information bar.



No.	Information
1	Select to change the display between the estimated travel time and the estimated arrival time.
2	Select to change the display between the current street name and the distance with the estimated travel/arrival time.

#### INFORMATION

- When the vehicle is on the guidance route, the distance measured along the route is displayed. Travel time and arrival time are calculated based on the average speed for the specified speed limit.
- When the vehicle gets off the guidance route, the arrow facing the destination is displayed instead of the estimated travel/arrival time.
- The route information bar fills from left to right as the vehicle progresses on the route.

**DISTANCE AND TIME TO DESTINATION**

When driving on the guidance route with more than 1 destination set, a list of the distance with estimated travel/arrival time from the current position to each destination is displayed.

- 1 Select the route information bar.



- 2 Check that the list of the distance and time is displayed.

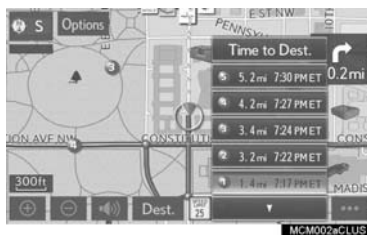

- By selecting one of the number buttons, the desired route information is displayed.

**ROUTE OVERVIEW**

The entire route from the current position to the destination can be displayed during the route guidance.

- 1 Select "Options" on the map screen.



- 2 Select "Route Overview".

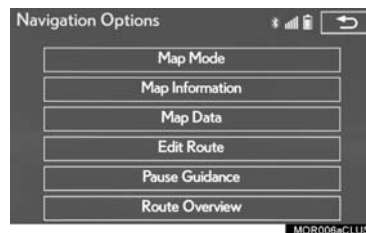

- 3 Check that the entire route map is displayed.



- For details about this screen: →P.121

3 NAVIGATION SYSTEM

### 3. ROUTE GUIDANCE

#### DURING FREEWAY DRIVING

During freeway driving, the freeway exit information screen will be displayed.



No./Icon	Information/Function
1	Distance and time from the current position to the road traffic facilities.
2	Name of the road traffic facilities.
3	POIs that are close to a freeway exit
4	Select to display the selected map of the exit vicinity.
	Select to scroll to farther road traffic facilities.
	Select to scroll to closer road traffic facilities.

#### WHEN APPROACHING FREEWAY EXIT OR JUNCTION

When the vehicle approaches an exit or junction, the freeway guidance screen will be displayed.

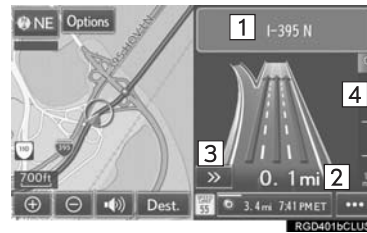



No.	Information/Function
1	Next exit or junction name
2	Distance from the current position to the exit or junction
3	Select to hide the freeway guidance screen. To return to the freeway guidance screen, select  .
4	Remaining distance bar to the guidance point

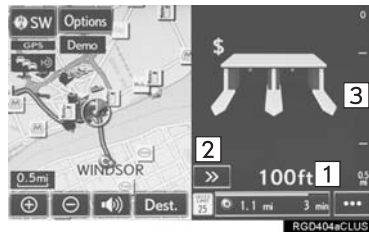

**TOLLGATE GUIDANCE**

When the vehicle approaches a tollgate, the tollgate view will be displayed.



No.	Information/Function
1	Distance from the current position to the tollgate
2	Select to hide the tollgate guidance screen. To return to the tollgate guidance screen, select  .
3	Remaining distance bar to the guidance point

**REAL FREEWAY JUNCTION VIEW**

When the vehicle approaches a junction, the junction view with signage will be displayed.



No.	Information/Function
1	Next junction or street name
2	Select to hide the real freeway junction view. To return to the real freeway junction view, select  .
3	Distance from the current position to the next junction
4	Remaining distance bar to the guidance point

3

NAVIGATION SYSTEM

### 3. ROUTE GUIDANCE

#### WHEN APPROACHING INTERSECTION

When the vehicle approaches an intersection, the intersection guidance screen will be displayed.

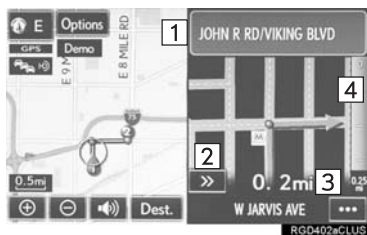

No.	Information/Function
1	Next street name
2	Select to hide the intersection guidance screen. To return to the intersection guidance screen, select  .
3	Distance to the intersection
4	Remaining distance bar to the guidance point

#### TURN LIST SCREEN

- 1 Select "Turn List" on the "Map Mode" screen. (→P.89)
- 2 Check that the turn list screen is displayed.

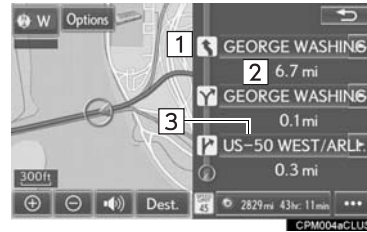

No.	Information
1	Turn direction
2	Distance between turns
3	Next street or destination name

## TURN-BY-TURN ARROW SCREEN

On this screen, information about the next turn on the guidance route can be displayed.

- 1 Select "Turn-by-Turn Arrow" on the "Map Mode" screen. (→P.89)
- 2 Check that the turn-by-turn arrow screen is displayed.

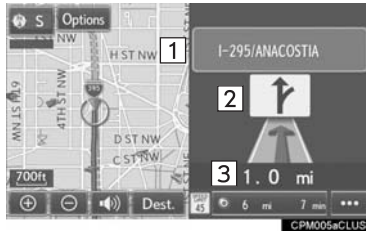

No.	Information
1	Exit number or street name
2	Turn direction
3	Distance to the next turn

3

NAVIGATION SYSTEM

### 3. ROUTE GUIDANCE

## 2. TYPICAL VOICE GUIDANCE PROMPTS

As the vehicle approaches an intersection, or point, where maneuvering the vehicle is necessary, the system's voice guidance will provide various messages.

#### WARNING

- Be sure to obey the traffic regulations and keep the road condition in mind especially when you are driving on IPD roads (roads that are not completely digitized in our database). The route guidance may not have the updated information such as the direction of a one way street.

#### INFORMATION

- If a voice guidance command cannot be heard, select  on the map screen to hear it again.
- To adjust the voice guidance volume:  
→P.74
- Voice guidance may be made early or late.
- If the system cannot determine the current position correctly, you may not hear voice guidance or may not see the magnified intersection on the screen.

### 3. ROUTE GUIDANCE

## 3. EDITING ROUTE

- 1 Press the "MENU" button on the Remote Touch.

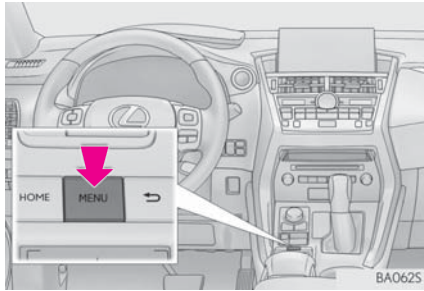

- 2 Select "Nav".

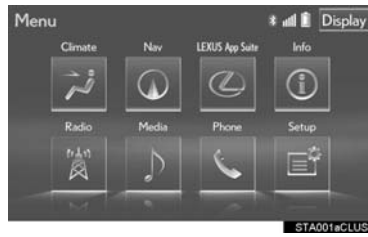

- 3 Select "Options".



- 4 Select "Edit Route".

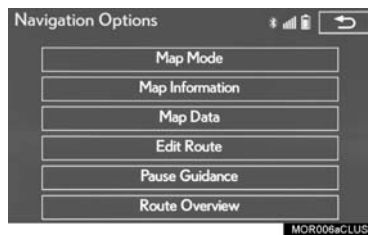

- 5 Select the item to be set.



No.	Function	Page
1	Select to add destinations.	134
2	Select to delete destinations.	135
3	Select to reorder destinations.	134
4	Select to set route preferences.	135
5	Select to change route type.	136
6	Select to set detours.	136
7	Select to start from adjacent road.	137

3 NAVIGATION SYSTEM

- 6 Check that the entire route map is displayed. (→P.121)

### 3. ROUTE GUIDANCE

#### ADDING DESTINATIONS

- 1 Display the "Route" screen. (→P.133)
- 2 Select "Add".
- 3 Search for an additional destination in the same way as a destination search. (→P.105)
- 4 Select "Add Destination Here" to insert the new destination into the route.



#### REORDERING DESTINATIONS

When more than 1 destination has been set, the arrival order of the destinations can be changed.

- 1 Display the "Route" screen. (→P.133)
- 2 Select "Reorder".
- 3 Select the desired destination and select "Move Up" or "Move Down" to change the arrival order. Then select "OK".



### DELETING DESTINATIONS

- 1 Display the "Route" screen. (→P.133)
  - 2 Select "Delete".
  - 3 Select "Yes" when the confirmation screen appears.
- When more than 1 destination has been set, a list will be displayed on the screen. Select the item(s) to be deleted.



**"Delete All":** Select to delete all destinations on the list.

- If more than 1 destination has been set, the system will recalculate the route(s) to the set destination(s) as necessary.

### SETTING ROUTE PREFERENCES

The conditions to determine the route can be selected from various choices such as freeways, toll roads, ferries, etc.

- 1 Display the "Route" screen. (→P.133)
- 2 Select "Preferences".
- 3 Select the desired route preferences and select "OK".

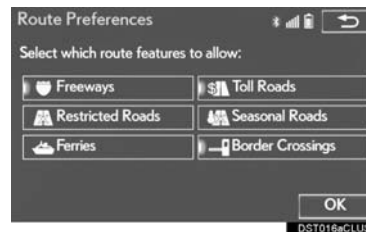

- When set to on, the indicator will illuminate.

### 3. ROUTE GUIDANCE

#### SELECTING ROUTE TYPE

- 1 Display the "Route" screen. (→P.133)
- 2 Select "Route Type".
- 3 Select the desired route type and select "OK".

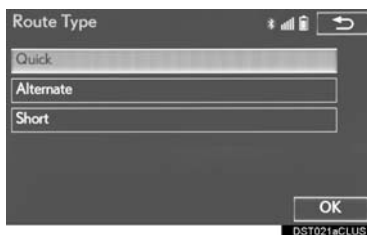

- During driving, the route guidance starts after selecting the desired route type.
- 4 The entire route from the starting point to the destination is displayed.



- For details about this screen: →P.121

#### DETOUR SETTING

During the route guidance, the route can be changed to detour around a section of the route where a delay is caused by road repairs, an accident, etc.

- 1 Display the "Route" screen. (→P.133)
- 2 Select "Detour".
- 3 Select the desired detour distance.



No.	Function
1	Select to detour within 1 mile of the current position.
2	Select to detour within 3 miles of the current position.
3	Select to detour within 5 miles of the current position.
4	Select to detour on the entire route.
5	Select to make the system search for the route based on traffic congestion information received from traffic information. (→P.100)



## INFORMATION

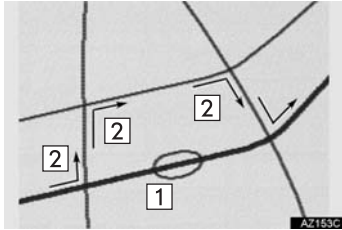

- This picture shows an example of how the system would guide around a delay caused by a traffic jam.
- 1 This position indicates the location of a traffic jam caused by road repairs, an accident, etc.
- 2 This route indicates the detour suggested by the system.
- When the vehicle is on a freeway, the detour distance selections are 5, 15 and 25 miles (or 5, 15 and 25 km if units are in km).
- The system may not be able to calculate a detour route depending on the selected distance and surrounding road conditions.

## STARTING FROM ADJACENT ROAD

When a freeway and a surface road run in parallel, the system may show the guidance route going on the freeway while driving on the surface road, or vice versa.

If this happens, you can instantly choose the adjacent road for the route guidance.

- 1 Display the "Route" screen. (→P.133)
- 2 Select "Start from Adjacent Road".

## INFORMATION

- When there is no adjacent road, this screen button will not be displayed.

3

NAVIGATION SYSTEM

## 4. MEMORY POINTS

### 1. MEMORY POINTS SETTINGS

Home, preset destinations, address book entries, areas to avoid can be set as memory points. The registered points can be used as the destinations. (→P.105)

Registered areas to avoid, will be avoided when the system searches for a route.

- 1 Press the “MENU” button on the Remote Touch.

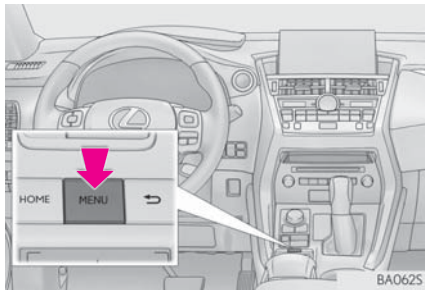

- 2 Select “Setup”.

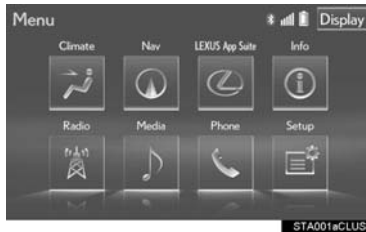

- 3 Select “Navigation”.



- 4 Select the desired item to be set.



No.	Function	Page
1	Select to set home.	139
2	Select to set preset destinations.	141
3	Select to set the address book.	143
4	Select to set areas to avoid.	146
5	Select to delete previous destinations.	149
6	Select to set detailed navigation settings.	150

## SETTING UP HOME

If home has been registered, that information can be recalled by selecting **“Go Home”** on the **“Destination”** screen. (→P.109)

- 1 Display the **“Navigation Settings”** screen. (→P.138)
- 2 Select **“Home”**.
- 3 Select the desired item to be set.



No.	Function	Page
1	Select to register home.	139
2	Select to edit home.	140
3	Select to delete home.	140

## REGISTERING HOME

- 1 Select **“Set Home Location”**.
- 2 Select the desired item to search for the location. (→P.105)
- 3 Select **“OK”** when the editing home screen appears.

3

NAVIGATION SYSTEM

## 4. MEMORY POINTS

### EDITING HOME

- 1 Select "Edit".
- 2 Select the desired item to be edited.

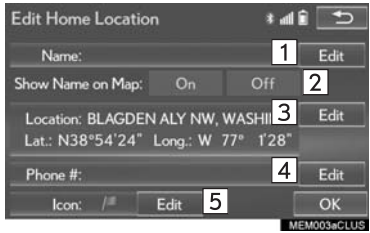

No.	Function	Page
1	Select to edit the home name.	145
2	Select to set display of the home name on/off.	—
3	Select to edit location information.	145
4	Select to edit the phone number.	145
5	Select to change the icon to be displayed on the map screen.	144

- 3 Select "OK".

### DELETING HOME

- 1 Select "Delete".
- 2 Select "Yes" when the confirmation screen appears.

### SETTING UP PRESET DESTINATIONS

If a preset destination has been registered, that information can be recalled by using preset destinations on the "Destination" screen. (→P.109)

- 1 Display the "Navigation Settings" screen. (→P.138)
- 2 Select "Preset Destinations".
- 3 Select the desired item.



No.	Function	Page
1	Select to register a preset destination.	141
2	Select to edit a preset destination.	142
3	Select to delete a preset destination.	142

### REGISTERING PRESET DESTINATIONS

- 1 Select "Set".
- 2 Select the desired item to search for the location. (→P.105)
- 3 Select a position for this preset destination.

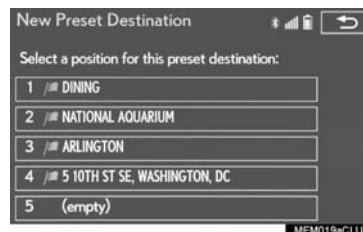

- 4 Select "OK" when the editing preset destination screen appears. (→P.142)

**INFORMATION**

- Up to 5 preset destinations can be registered.

3 NAVIGATION SYSTEM

## 4. MEMORY POINTS

### EDITING PRESET DESTINATIONS

- 1 Select "Edit".
- 2 Select the desired preset destination.
- 3 Select the item to be edited.

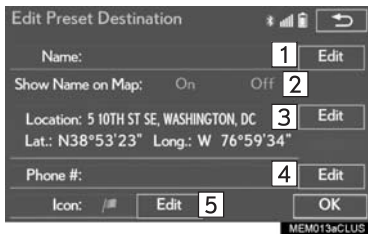

No.	Function	Page
1	Select to edit the preset destination name.	145
2	Select to set display of the preset destination name on/off.	—
3	Select to edit location information.	145
4	Select to edit the phone number.	145
5	Select to change the icon to be displayed on the map screen.	144

- 4 Select "OK".

### DELETING PRESET DESTINATIONS

- 1 Select "Delete".
- 2 Select the preset destination to be deleted and select "Delete".



- 3 Select "Yes" when the confirmation screen appears.

## SETTING UP ADDRESS BOOK

Points on the map can be registered.

- 1 Display the "Navigation Settings" screen. (→P.138)
- 2 Select "Address Book".
- 3 Select the desired item.



No.	Function	Page
1	Select to register address book entries.	143
2	Select to edit address book entries.	144
3	Select to delete address book entries.	146

## REGISTERING ADDRESS BOOK ENTRIES

- 1 Select "New".
- 2 Select the desired item to search for the location. (→P.105)
- 3 Select "OK" when the editing address book entry screen appears. (→P.144)

## INFORMATION

- Up to 100 address book entries can be registered.

## 4. MEMORY POINTS

### EDITING ADDRESS BOOK ENTRIES

The icon, name, location and/or phone number of a registered address book entry can be edited.

- 1 Select "Edit".
- 2 Select the desired address book entry.
- 3 Select the item to be edited.

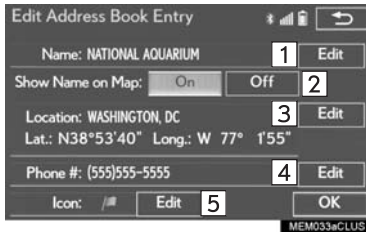

No.	Function	Page
1	Select to edit the address book entry name.	145
2	Select to set display of the address book entry name on/off.	—
3	Select to edit location information.	145
4	Select to edit the phone number.	145
5	Select to change the icon to be displayed on the map screen.	144

- 4 Select "OK".

### CHANGING THE ICON

- 1 Select "Edit" next to the "Icon".
- 2 Select the desired icon.



- Change pages by selecting the "Page 1", "Page 2" or "With Sound" tab.
- "With Sound": Select the memory points with a sound



► When the “With Sound” tab is selected

A sound for some address book entries can be set. When the vehicle approaches the location of the address book entry, the selected sound will be heard.

- 1 Select the “With Sound” tab.
- 2 Select the desired sound icon.

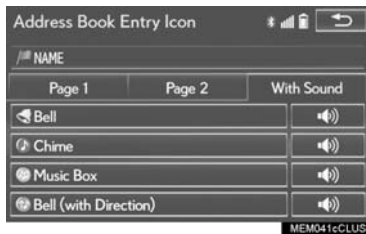

 : Select to play the sound.

- When “Bell (with Direction)” is selected, select an arrow to adjust the direction and select “OK”.

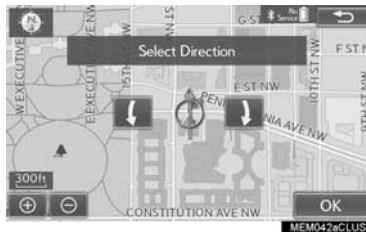

**INFORMATION**

- The bell sounds only when the vehicle approaches this point in the direction that has been set.

■ CHANGING THE NAME

- 1 Select “Edit” next to “Name”.
- 2 Enter a name and select “OK”.

■ CHANGING THE LOCATION

- 1 Select “Edit” next to “Location”.
- 2 Scroll the map to the desired point (→P.92) and select “OK”.

■ CHANGING PHONE NUMBER

- 1 Select “Edit” next to “Phone #”.
- 2 Enter the phone number and select “OK”.

3

NAVIGATION SYSTEM

## 4. MEMORY POINTS

### DELETING ADDRESS BOOK ENTRIES

- 1 Select **"Delete"**.
- 2 Select the item to be deleted and select **"Delete"**.

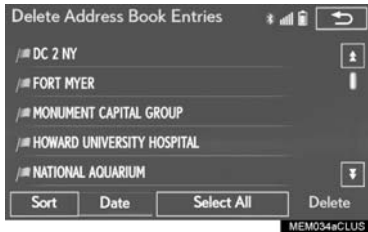

- 3 Select **"Yes"** when the confirmation screen appears.

### SETTING UP AREAS TO AVOID



Areas to be avoided because of traffic jams, construction work or other reasons can be registered as "Areas to Avoid".

- 1 Display the "Navigation Settings" screen. (→P.138)
- 2 Select **"Areas to Avoid"**.
- 3 Select the desired item.



No.	Function	Page
1	Select to register areas to avoid.	147
2	Select to edit areas to avoid.	147
3	Select to delete areas to avoid.	149

### REGISTERING AREAS TO AVOID

- 1 Select "New".
- 2 Select the desired item to search for the location. (→P.105)
- 3 Select either  or  to change the size of the area to be avoided and select "OK".



- 4 Select "OK" when the editing area to avoid screen appears.

#### INFORMATION

- If a destination is entered in the area to avoid or the route calculation cannot be made without running through the area to avoid, a route passing through the area to be avoided may be shown.
- Up to 10 locations can be registered as points/areas to avoid.

### EDITING AREAS TO AVOID

The name, location and/or area size of a registered area can be edited.

- 1 Select "Edit".
- 2 Select the area and select "OK".

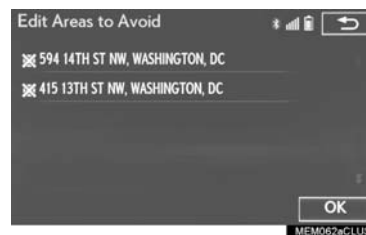

3

NAVIGATION SYSTEM

## 4. MEMORY POINTS

**3** Select the item to be edited.

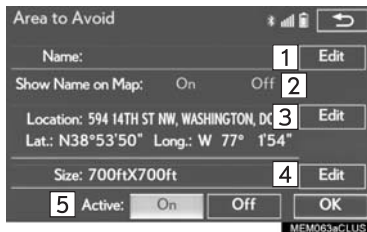

No.	Function	Page
1	Select to edit the name of the area to avoid.	148
2	Select to set display of the area to avoid name on/off.	—
3	Select to edit area location.	148
4	Select to edit area size.	148
5	Select to set the area to avoid function on/off.	—

**4** Select “OK”.



### ■ CHANGING THE NAME

- 1 Select “Edit” next to “Name”.
- 2 Enter a name and select “OK”.

### ■ CHANGING THE LOCATION

- 1 Select “Edit” next to “Location”.
- 2 Scroll the map to the desired point (→P.92) and select “OK”.

### ■ CHANGING THE AREA SIZE

- 1 Select “Edit” next to “Size”.
- 2 Select either  or  to change the size of the area to be avoided and select “OK”.



## DELETING AREAS TO AVOID

- 1 Select **"Delete"**.
- 2 Select the area to be deleted and select **"Delete"**.

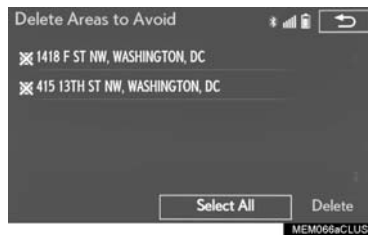

- 3 Select **"Yes"** when the confirmation screen appears.

## DELETING PREVIOUS DESTINATIONS

Previous destinations can be deleted.

- 1 Display the **"Navigation Settings"** screen. (→P.138)
- 2 Select **"Delete Previous Dest."**.
- 3 Select the previous destination to be deleted and select **"Delete"**.

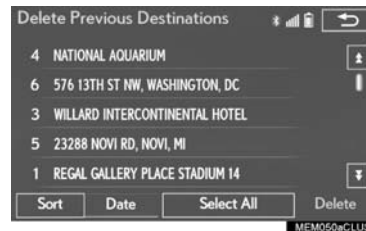

- 4 Select **"Yes"** when the confirmation screen appears.

3  
NAVIGATION SYSTEM

# 5. SETUP

## 1. DETAILED NAVIGATION SETTINGS

Settings are available for pop-up information, favorite POI categories, low fuel warning, etc.

1 Press the "MENU" button on the Remote Touch.

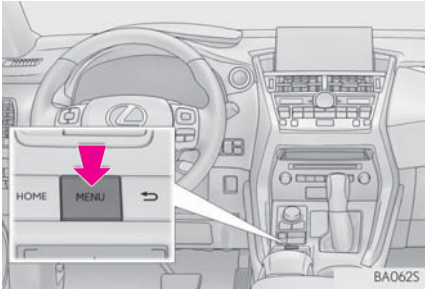

2 Select "Setup".



3 Select "Navigation".



4 Select "Detailed Navi. Settings".

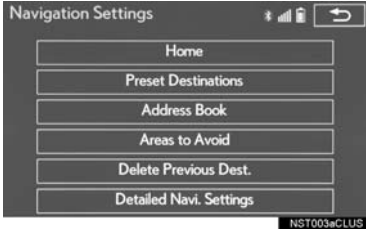

5 Select the items to be set.



## SCREENS FOR NAVIGATION SETTINGS

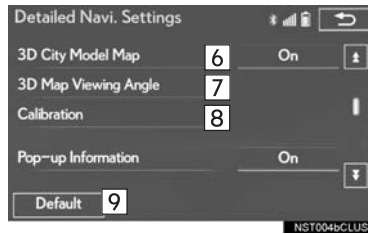
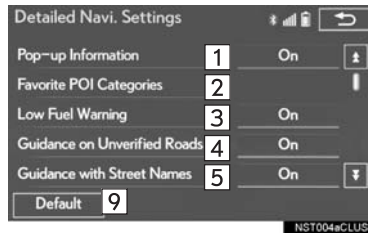

No.	Function	Page
1	Select to set display of pop-up information on/off.	—
2	Select to set favorite POI categories that are used for POI selection to display on the map screen.	152
3	Select to set display of low fuel warning on/off.	152
4	Select to set IPD road guidance on/off.	—
5	Select to set the voice guidance for the next street name on/off.	—
6	Select to set display of the 3D city model map on/off.	—
7	Select to change the viewing angle of the 3D map.	153
8	Select to adjust the current position mark manually or to adjust miscalculation of the distance caused by tire replacement.	154
9	Select to reset all setup items.	—

3

NAVIGATION SYSTEM

### FAVORITE POI CATEGORIES (SELECT POI ICONS)

Up to 6 POI icons, which are used for selecting POIs on the map screen, can be selected as favorites.

- 1 Display the "Detailed Navi. Settings" screen. (→P.150)
- 2 Select "**Favorite POI Categories**".
- 3 Select the category to be changed.



"**Default**": Select to set the default categories.

- 4 Select the desired POI category.

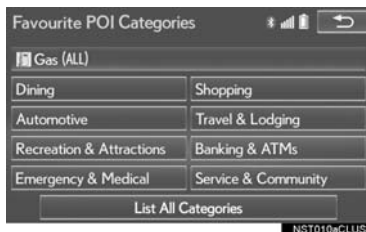

"**List All Categories**": Select to display all POI categories.

- 5 Select the desired POI icon.

### LOW FUEL WARNING

When the fuel level is low, a warning message will pop up on the screen.

- 1 Display the "Detailed Navi. Settings" screen. (→P.150)
- 2 Select "**Low Fuel Warning**".
- 3 Select "On" or "Off".



## SEARCHING GAS STATION IN LOW FUEL WARNING

A nearby gas station can be selected as a destination.

- 1 Select "Yes" when the low fuel warning appears.
- 2 Select the desired nearby gas station.



- 3 Select "Enter" to set as a destination.



"Info": Select to display gas station information. (→P.97)

## CHANGING VIEWING ANGLE OF 3D MAP

- 1 Display the "Detailed Navi. Settings" screen. (→P.150)
- 2 Select "3D Map Viewing Angle".
- 3 Select "Up" or "Down" to change the viewing angle.



"Default": Select to set the initial angle.

**CURRENT POSITION/TIRE CHANGE CALIBRATION**

The current position mark can be adjusted manually. Miscalculation of the distance caused by tire replacement can also be adjusted.

- 1 Display the "Detailed Navi. Settings" screen. (→P.150)
- 2 Select "Calibration".
- 3 Select the desired item.

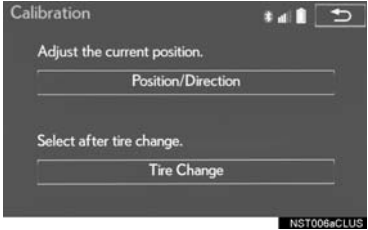

● For additional information on the accuracy of a current position: →P.159

**POSITION/DIRECTION CALIBRATION**

When driving, the current position mark will be automatically corrected by GPS signals. If GPS reception is poor due to location, the current position mark can be adjusted manually.

- 1 Select "Position / Direction".
- 2 Scroll the map to the desired point (→P.92) and select "OK".
- 3 Select an arrow to adjust the direction of the current position mark and select "OK".



## ■ TIRE CHANGE CALIBRATION

The tire change calibration function will be used when replacing the tires. This function will adjust miscalculation caused by the circumference difference between the old and new tires.

### 1 Select "Tire Change".

- The message appears and the quick distance calibration starts automatically.

#### INFORMATION

- If this procedure is not performed when the tires are replaced, the current position mark may be incorrectly displayed.

3

NAVIGATION SYSTEM

# 5. SETUP

## 2. TRAFFIC SETTINGS

Traffic information such as traffic congestion or traffic incident warnings can be made available.

1 Press the "MENU" button on the Remote Touch.

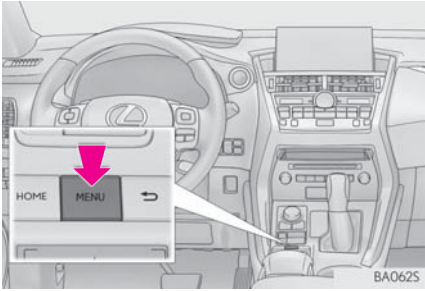

2 Select "Setup".



3 Select "Traffic".



4 Select the items to be set.



## SCREEN FOR TRAFFIC SETTINGS

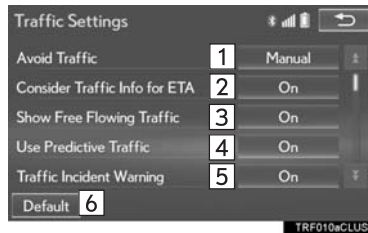

No.	Function
1	Select to set the avoid traffic function auto/manual. (→P.158)
2	Select to set the usage of traffic information for the estimated arrival time on/off.
3	Select to set the display of an arrow of free flowing traffic on/off.
4	Select to set to on/off whether to consider the predictive traffic information (→P.102) with estimated arrival time and detoured route search.
5	Select to set traffic incident voice warning on/off.
6	Select to reset all setup items.

3  
NAVIGATION SYSTEM

### AUTO AVOID TRAFFIC

- 1 Display the "Traffic Settings" screen. (→P.156)
- 2 Select "Avoid Traffic".
- 3 Select the desired item.

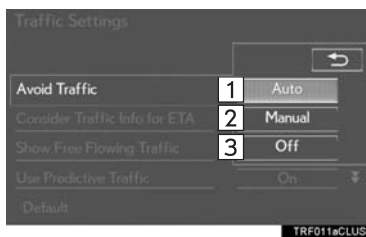

No.	Function
1	Select to automatically change routes when congestion information of the guidance route has been received.
2	Select to select manually whether or not to change routes when congestion information of the guidance route has been received. In this mode, a screen will appear to ask if you wish to reroute.
3	Select to not reroute when congestion information for the guidance route has been received.

### CHANGING THE ROUTE MANUALLY

When the navigation system calculates a new route, the following screen will be displayed.

- 1 Select the desired item.

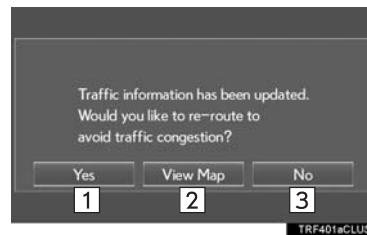

No.	Function
1	Select to start route guidance using the new route.
2	Select to confirm the new route and current route on the map.
3	Select to continue the current route guidance.

## 6. TIPS FOR THE NAVIGATION SYSTEM

### 1. GPS (GLOBAL POSITIONING SYSTEM)

#### LIMITATIONS OF THE NAVIGATION SYSTEM

This navigation system calculates the current position using satellite signals, various vehicle signals, map data, etc. However, an accurate position may not be shown depending on satellite conditions, road configuration, vehicle condition or other circumstances.

The Global Positioning System (GPS) developed and operated by the U.S. Department of Defense provides an accurate current position, normally using 4 or more satellites, and in some case 3 satellites. The GPS system has a certain level of inaccuracy. While the navigation system compensates for this most of the time, occasional positioning errors of up to 300 ft. (100 m) can and should be expected. Generally, position errors will be corrected within a few seconds.



When the vehicle is receiving signals from satellites, the “GPS” mark appears at the top left of the screen.

The GPS signal may be physically obstructed, leading to inaccurate vehicle position on the map screen. Tunnels, tall buildings, trucks, or even the placement of objects on the instrument panel may obstruct the GPS signals.

The GPS satellites may not send signals due to repairs or improvements being made to them.

Even when the navigation system is receiving clear GPS signals, the vehicle position may not be shown accurately or inappropriate route guidance may occur in some cases.

#### NOTICE

- The installation of window tinting may obstruct the GPS signals. Most window tinting contains some metallic content that will interfere with GPS signal reception of the antenna in the instrument panel. We advise against the use of window tinting on vehicles equipped with navigation systems.

3

NAVIGATION SYSTEM

## 6. TIPS FOR THE NAVIGATION SYSTEM

- Accurate current position may not be shown in the following cases:
  - When driving on a small angled Y-shaped road.
  - When driving on a winding road.
  - When driving on a slippery road such as in sand, gravel, snow, etc.
  - When driving on a long straight road.
  - When freeway and surface streets run in parallel.
  - After moving by ferry or vehicle carrier.
  - When a long route is searched during high speed driving.
  - When driving without setting the current position calibration correctly.
  - After repeating a change of direction by going forward and backward, or turning on a turntable in a parking lot.
  - When leaving a covered parking lot or parking garage.
  - When a roof carrier is installed.
  - When driving with tire chains installed.
  - When the tires are worn.
  - After replacing a tire or tires.
  - When using tires that are smaller or larger than the factory specifications.
  - When the tire pressure in any of the 4 tires is not correct.
- If the vehicle cannot receive GPS signals, the current position can be adjusted manually. For information on setting the current position calibration: →P.154
- Inappropriate route guidance may occur in the following cases:
  - When turning at an intersection off the designated route guidance.
  - If you set more than 1 destination but skip any of them, auto reroute will display a route returning to the destination on the previous route.
  - When turning at an intersection for which there is no route guidance.
  - When passing through an intersection for which there is no route guidance.
  - During auto reroute, the route guidance may not be available for the next turn to the right or left.
  - During high speed driving, it may take a long time for auto reroute to operate. In auto reroute, a detour route may be shown.
  - After auto reroute, the route may not be changed.
  - If an unnecessary U-turn is shown or announced.
  - If a location has multiple names and the system announces 1 or more of them.
  - When a route cannot be searched.
  - If the route to your destination includes gravel, unpaved roads or alleys, the route guidance may not be shown.
  - Your destination point might be shown on the opposite side of the street.
  - When a portion of the route has regulations prohibiting the entry of the vehicle that vary by time, season or other reasons.
  - The road and map data stored in the navigation system may not be complete or may not be the latest version.
- After replacing a tire: →P.155



### INFORMATION

- This navigation system uses tire turning data and is designed to work with factory-specified tires for the vehicle. Installing tires that are larger or smaller than the originally equipped diameter may cause inaccurate display of the current position. The tire pressure also affects the diameter of the tires, so make sure that the tire pressure of all 4 tires is correct.

## 6. TIPS FOR THE NAVIGATION SYSTEM

### 2. MAP DATABASE VERSION AND COVERED AREA

#### MAP INFORMATION

Coverage areas and legal information can be displayed and map data can be updated.

1 Press the "MENU" button on the Remote Touch.

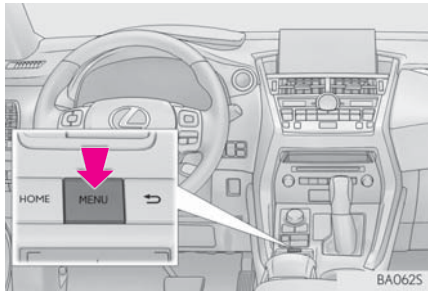

2 Select "Nav".



3 Select "Options".



4 Select "Map Data".



5 Check that the map data screen is displayed.



No.	Function
1	Map version
2	Select to update map.
3	Select to display map coverage areas.
4	Select to display legal information.

**INFORMATION**

- Map data updates are available for a fee. Contact your Lexus dealer for further information.

## ABOUT THE MAP DATA

Map data for the navigation system is contained in a SD card that is inserted in the SD card slot located at the bottom of the audio control panel.

Do not eject the SD card, as doing so may deactivate the navigation system.

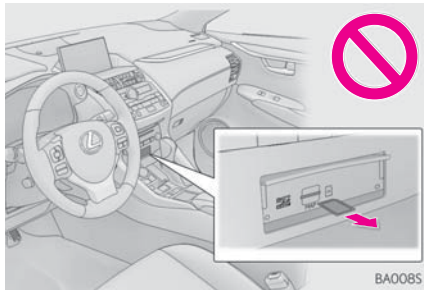

## NOTICE

- Do not edit or delete the map data on the SD card, as doing so may deactivate the navigation system.

## INFORMATION



- microSDHC Logo is a trademark of SD-3C, LLC.

# 4

## AUDIO/VISUAL SYSTEM

### 1 BASIC OPERATION

1. QUICK REFERENCE .....	166
2. SOME BASICS .....	168
TURNING THE SYSTEM ON AND OFF .....	168
SELECTING AN AUDIO SOURCE .....	169
DISC SLOT .....	170
USB/AUX PORT .....	171
SOUND SETTINGS .....	172
AUDIO SCREEN ADJUSTMENT .....	174
VOICE COMMAND SYSTEM.....	175

### 2 RADIO OPERATION

1. AM/FM RADIO .....	176
OVERVIEW .....	176
PRESETTING A STATION .....	180
SELECTING A STATION FROM THE LIST .....	180
CACHING A RADIO PROGRAM .....	182
RADIO BROADCAST DATA SYSTEM .....	183
TRAFFIC ANNOUNCEMENT (FM RADIO) .....	185
USING HD Radio™ TECHNOLOGY .....	185
AVAILABLE HD Radio™ TECHNOLOGY .....	186
TROUBLESHOOTING GUIDE .....	188
2. XM Satellite Radio .....	189
OVERVIEW .....	189
HOW TO SUBSCRIBE TO AN XM Satellite Radio .....	192
DISPLAYING THE RADIO ID .....	194
PRESETTING A CHANNEL.....	194
SELECTING A CHANNEL FROM THE LIST .....	195
IF THE SATELLITE RADIO TUNER MALFUNCTIONS .....	196
3. INTERNET RADIO .....	197
LISTENING TO INTERNET RADIO .....	197

# 4

## AUDIO/VISUAL SYSTEM

<b>3 MEDIA OPERATION</b>	<b>4 AUDIO/VISUAL REMOTE CONTROLS</b>
1. CD.....198	1. STEERING SWITCHES .....235
OVERVIEW ..... 198	
PLAYING AN AUDIO CD ..... 202	
PLAYING AN MP3/WMA/AAC DISC ... 203	
2. DVD.....204	<b>5 SETUP</b>
OVERVIEW ..... 204	1. AUDIO SETTINGS.....237
DVD OPTIONS..... 208	AUDIO SETTINGS SCREEN..... 238
3. USB MEMORY ..... 211	<b>6 TIPS FOR OPERATING THE AUDIO/VISUAL SYSTEM</b>
OVERVIEW ..... 211	1. OPERATING INFORMATION.....244
USB AUDIO ..... 215	RADIO..... 244
4. iPod.....216	DVD PLAYER AND DISC ..... 246
OVERVIEW ..... 216	iPod..... 251
iPod AUDIO ..... 221	FILE INFORMATION..... 252
iPod VIDEO ..... 222	TERMS..... 254
5. Bluetooth® AUDIO .....223	ERROR MESSAGES..... 256
OVERVIEW ..... 223	
CONNECTING A Bluetooth® DEVICE ... 227	
LISTENING TO Bluetooth® AUDIO ..... 227	
6. AUX ..... 229	
OVERVIEW ..... 229	
7. VTR ..... 232	
OVERVIEW ..... 232	
VTR OPTIONS..... 234	

## 1. BASIC OPERATION

### 1. QUICK REFERENCE

Operations such as selecting a preset station and adjusting the sound balance are carried out on the screen.

▶ Using the instrument panel

Press the “**RADIO**” or “**MEDIA**” button to display the audio/visual screen.

▶ Using the Remote Touch

Press the “**MENU**” button on the Remote Touch, then select “**Radio**” or “**Media**” to display the audio/visual screen.

#### ■ CONTROL SCREEN

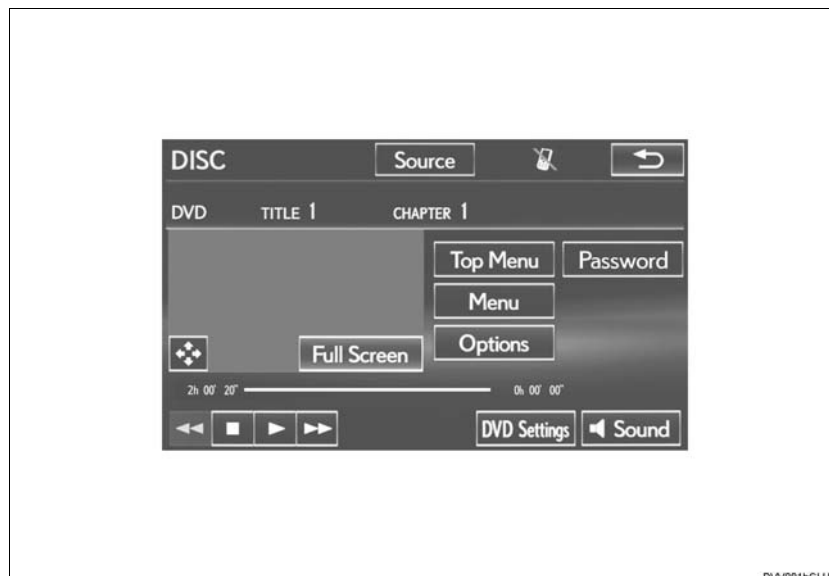

## ■ CONTROL PANEL

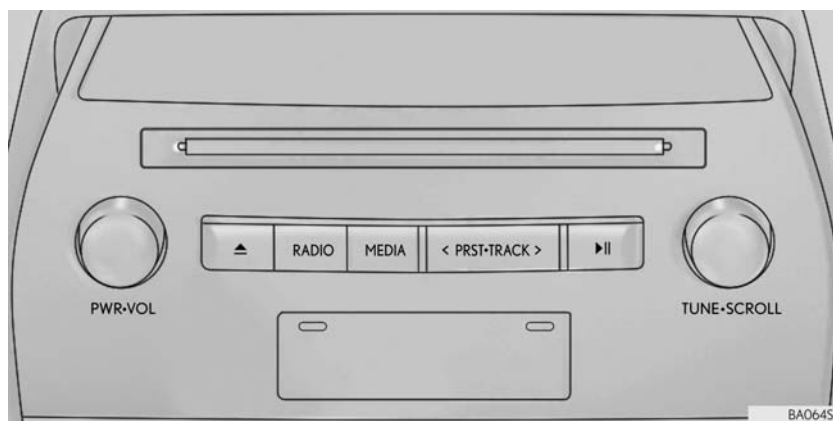

Function	Page
Using the radio	176
Playing an audio CD or MP3/WMA/AAC disc	198
Playing a DVD	204
Playing a USB memory	211
Playing an iPod®	216
Playing a Bluetooth® device	223
Using the AUX port	229
Playing the VTR	232
Using the steering wheel audio switches	235
Audio system settings	237

## 1. BASIC OPERATION

## 2. SOME BASICS

This section describes some of the basic features of the audio/visual system. Some information may not pertain to your system.

Your audio/visual system works when the engine <power> switch is turned to **ACCESSORY** or **IGNITION ON <ON>** mode.

### **WARNING**

- For vehicles sold in U.S.A.:  
Part 15 of the FCC Rules  
FCC WARNING: Changes or modifications not expressly approved by the party responsible for compliance could void the user's authority to operate the equipment.
- Laser products
  - CAUTION: USE OF CONTROL OR ADJUSTMENT OR PERFORMANCE OF PROCEDURES OTHER THAN THOSE SPECIFIED HEREIN MAY RESULT IN HAZARDOUS RADIATION EXPOSURE.
  - CAUTION: THE USE OF OPTICAL INSTRUMENTS WITH THIS PRODUCT WILL INCREASE EYE HAZARD.

### **NOTICE**

- To prevent the 12-volt battery from being discharged, do not leave the audio/visual system on longer than necessary when the engine is not running <the hybrid system is not operating>.

## TURNING THE SYSTEM ON AND OFF

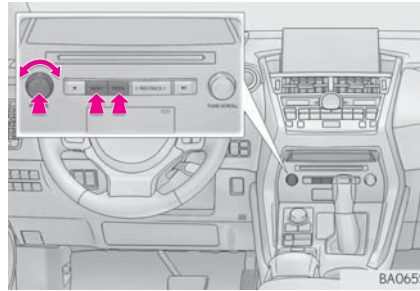

**"PWR·VOL"** knob: Press to turn the audio/visual system on and off. The system turns on in the last mode used. Turn this knob to adjust the volume.

**"RADIO", "MEDIA"** button: Press to display screen buttons for the audio/visual system.

- A function that enables automatic return to the previous screen from the audio/visual screen can be selected. (→P.66)



**SELECTING AN AUDIO SOURCE**

► Using the instrument panel

- 1 Each time the “RADIO” or “MEDIA” button is pressed, the audio control mode changes.

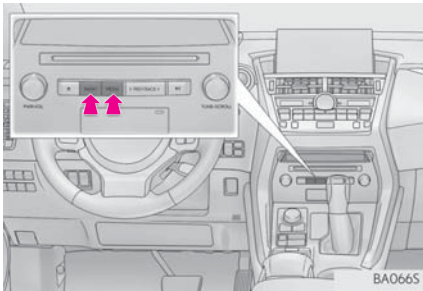

“RADIO” button: To display the radio operation screen.

“MEDIA” button: To display the external media operation screen.

► Using the Remote Touch

- 1 Press the “MENU” button on the Remote Touch.

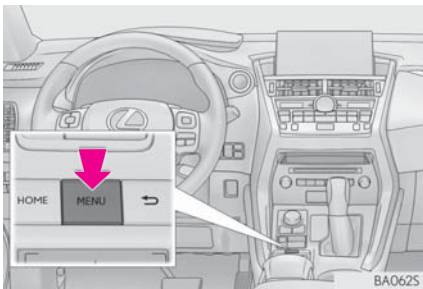

- 2 Select “Radio” or “Media”.

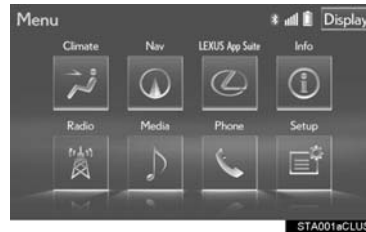

- 3 Select “Source”.



- 4 Select the desired source.



4

AUDIO/VISUAL SYSTEM

**INFORMATION**

- Dimmed screen buttons cannot be operated.
- When there are two pages, select “>” or “<” to change the page.

## 1. BASIC OPERATION

### REORDERING THE AUDIO SOURCE

- 1 Select "Source".



- 2 Select "Reorder".



- 3 Select the desired audio source then "<<" or ">>" to reorder.



### DISC SLOT

#### INSERTING A DISC

- 1 Insert a disc into the disc slot.



- After insertion, the disc is automatically loaded.

**EJECTING A DISC**

- 1 Press the “▲” button and remove the disc.

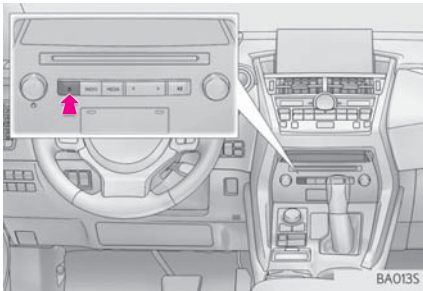

 **NOTICE**

- Never try to disassemble or oil any part of the DVD player. Do not insert anything other than a disc into the slot.

**INFORMATION**

- The player is intended for use with 4.7 in. (12 cm) discs only.
- When inserting a disc, gently insert the disc with the label facing up.

**USB/AUX PORT**

There are 2 USB ports and an AUX port in the console box.

- 1 Press the button to release the lock and lift the armrest.

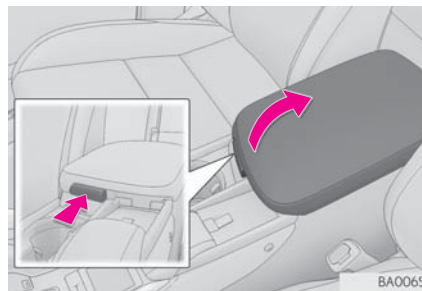

- 2 Open the cover and connect a device.

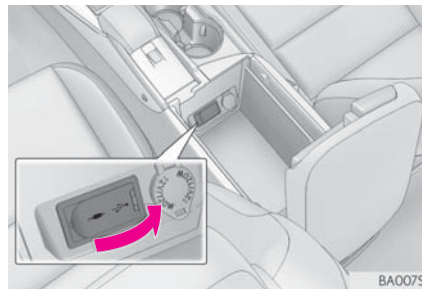

- Turn on the power of the device if it is not turned on.

**INFORMATION**

- Up to two portable players can be connected to the USB port at the same time.

4

AUDIO/VISUAL SYSTEM

# 1. BASIC OPERATION

## USING A 4-POLE AUX CABLE

To view a video on an iPod video or VTR, it is necessary to use a 4-pole AUX cable to connect the portable audio device.

When connecting a portable audio device to the AUX port, use a 4-pole AUX cable with a plug that matches the exact layout shown in the illustration.

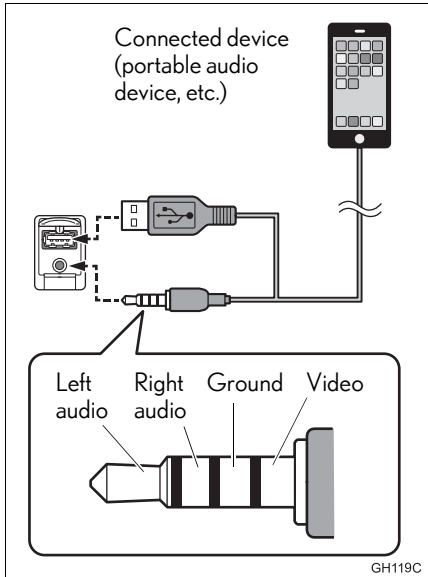

- When using an iPod video, a cable that has a 4-pole AUX plug and a USB connector is necessary. Connect the plug and connector to the AUX and USB ports.

### INFORMATION

- If a 4-pole AUX cable with a different layout is used, audio and/or video may not be output properly.

## SOUND SETTINGS

### DSP CONTROL

- 1 Select **Sound**.



- 2 Select the "DSP" tab.



No.	Function
1	The system adjusts to the optimum volume and tone quality according to vehicle speed to compensate for increased vehicle noise.
2	This function can create a feeling of presence.

- 3 Select the desired items to be set.

**TONE AND BALANCE**

**TONE:**

How good an audio program sounds is largely determined by the mix of the treble, mid and bass levels. In fact, different kinds of music and vocal programs usually sound better with different mixes of treble, mid and bass.

**BALANCE:**

A good balance of the left and right stereo channels and of the front and rear sound levels is also important.

Keep in mind that when listening to a stereo recording or broadcast, changing the right/left balance will increase the volume of 1 group of sounds while decreasing the volume of another.

- 1 Select **Sound**.



- 2 Select the **"Sound"** tab.

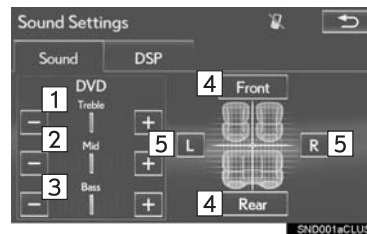

- 3 Select the desired screen button.

No.	Function
1	Select "+" or "-" to adjust high-pitched tones.
2	Select "+" or "-" to adjust mid-pitched tones.
3	Select "+" or "-" to adjust low-pitched tones.
4	Select to adjust the sound balance between the front and rear speakers.
5	Select to adjust the sound balance between the left and right speakers.

4

AUDIO/VISUAL SYSTEM

**AUDIO SCREEN  
ADJUSTMENT**

**SCREEN SIZE SETTINGS**

The screen size can be selected for each type of media.

- ▶ DVD video/iPod video/VTR
- 1 Select “Options” on the control screen.
- 2 Select “Wide” on the options screen.
- 3 Select the desired item to be adjusted.

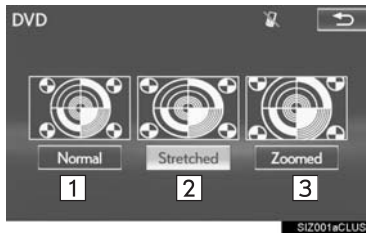

No.	Function
1	Select to display a 4 : 3 screen, with either side in black.
2	Select to enlarge the image horizontally and vertically to full screen.
3	Select to enlarge the image by the same ratio horizontally and vertically.

**CONTRAST, BRIGHTNESS,  
COLOR AND TONE  
ADJUSTMENT**

The brightness, contrast, color and tone of the screen can be adjusted.

- ▶ DVD video/iPod video/VTR
- 1 Select “Options” on the control screen.
- 2 Select “Display” on the option screen.

- 3 Select the desired item to be adjusted.



Screen button	Function
"Color" "R"	Select to strengthen the red color of the screen.
"Color" "G"	Select to strengthen the green color of the screen.
"Tone" "+"	Select to strengthen the tone of the screen.
"Tone" "-"	Select to weaken the tone of the screen.
"Contrast" "+"	Select to strengthen the contrast of the screen.
"Contrast" "-"	Select to weaken the contrast of the screen.
"Brightness" "+"	Select to brighten the screen.
"Brightness" "-"	Select to darken the screen.

**INFORMATION**

- Depending on the audio source, some functions may not be available.

**VOICE COMMAND SYSTEM**

- 1 Press this switch to operate the voice command system.

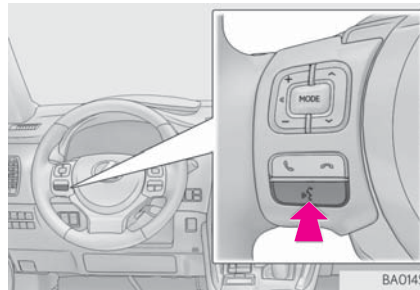

- The voice command system and its list of commands can be operated. (→P.258)

4

AUDIO/VISUAL SYSTEM

## 2. RADIO OPERATION

### 1. AM/FM RADIO

#### OVERVIEW

The radio operation screen can be reached by the following methods:

- ▶ Using the instrument panel  
Press the **"RADIO"** button to display the audio control screen.
- ▶ Using the Remote Touch  
Press the **"MENU"** button on the Remote Touch, then select **"Radio"** to display the audio control screen.

#### ■ CONTROL SCREEN

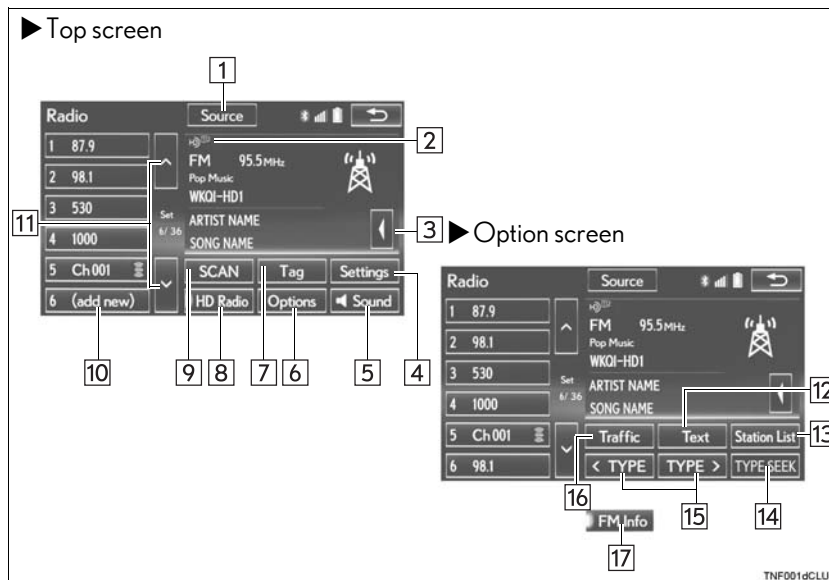



■ CONTROL PANEL

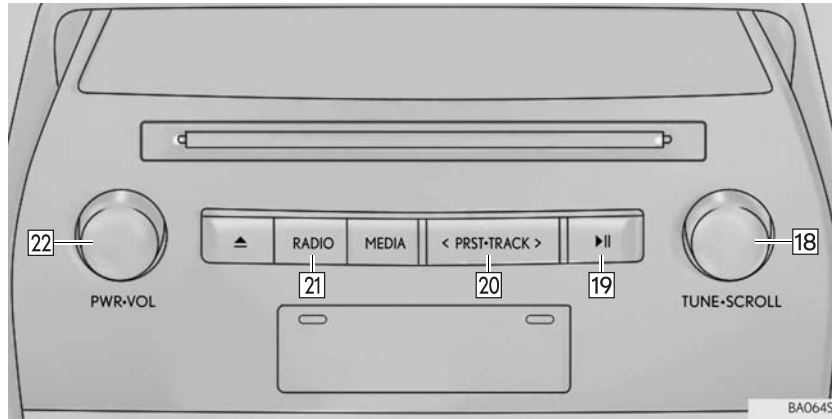

4  
AUDIO/VISUAL SYSTEM

## 2. RADIO OPERATION

No.	Function
1	Select to display the audio source selection screen.
2	Select to display HD) multicast channels available.
3	Select to display the cache radio operation buttons.
4	Select to display the audio setting screen.
5	Select to display the sound setting screen.
6	Select to display the option screen.
7	Select to store artist and song title information.
8	<ul style="list-style-type: none"> <li>Select to turn HD Radio mode on/off.</li> <li>When the "HD Radio" indicator is off, the station list shows only analog broadcasts.</li> </ul>
9	Select to scan for receivable stations.
10	Select to tune to preset stations/channels.
11	Select to change the page of preset buttons.
12	Select to display text messages.
13	Select to display a list of receivable stations.
14	Select to seek a receivable station of the selected category.
15	Select to select a program type/channel category.
16	FM only: Select to seek a traffic program station.
17	Analog FM only: Select to display RBDS text messages.
18	<ul style="list-style-type: none"> <li>Turn to step up/down frequencies.</li> <li>Turn to move up/down the list.</li> </ul>
19	Cache radio only: Press to turn mute on/off.
20	<ul style="list-style-type: none"> <li>Press to select a preset station.</li> <li>Press and hold to seek for a station.</li> </ul>
21	<ul style="list-style-type: none"> <li>Press to select a radio mode.</li> <li>While in a radio mode, pressing the "RADIO" button changes radio modes.</li> </ul>

No.	Function
22	<ul style="list-style-type: none"><li>• Turn to adjust volume.</li><li>• Press to turn the audio system on/off.</li><li>• Press and hold to restart the audio system.</li></ul>

**INFORMATION**

- The radio automatically changes to stereo reception when a stereo broadcast is received.

## 2. RADIO OPERATION

### PRESETTING A STATION

Radio mode has a mix preset function, which can store up to 36 stations (6 stations per page x 6 pages) from any of the AM, FM or SAT bands.

- 1 Tune in the desired station.
- 2 Select "add new".



- To change the preset station to a different one, select and hold the preset station.
- 3 Select "Yes" on the confirmation screen.
  - 4 Select "OK" after setting the new preset station.

#### INFORMATION

- The number of preset radio stations displayed on the screen can be changed. (→P.239)

### SELECTING A STATION FROM THE LIST

A station list can be displayed.

- 1 Select "Options".



- 2 Select "Station List".



- 3 FM radio only: Select the desired program type.

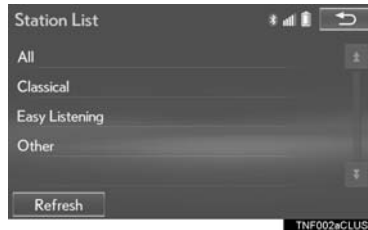

- 4 Select the desired station and select "OK".



■ REFRESHING THE STATION LIST

- 1 Select "Refresh" on the "Station List" screen and the following screen will be displayed.

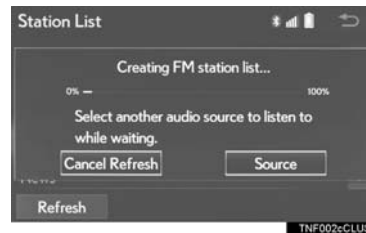

4

AUDIO/VISUAL SYSTEM

"Cancel Refresh": Select to cancel the refresh.

"Source": Select to change to another audio source while refreshing.

(INFORMATION)

- The audio system sound is muted during refresh operation.
- In some situations, it may take some time to update the station list.

## 2. RADIO OPERATION

### CACHING A RADIO PROGRAM

A radio program can be cached and played back in a time-shifted manner.

### PLAYING BACK THE CACHE MANUALLY

The broadcast cached in the program cache can be played back manually.

- 1 Select  on the right side of the screen.



- 2 Select the desired cache radio operation button.

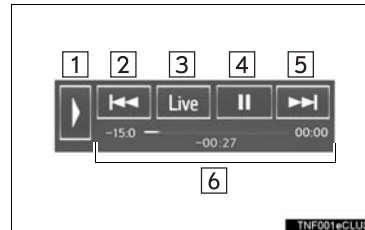

No.	Function
1	Hides the cache operation buttons
2	Select: Skips backward 2 minutes Select and hold: Fast rewinds continuously
3	Returns to the live radio broadcast
4	Pauses the playback (To restart, select  )
5	Select: Skips forward 2 minutes Select and hold: Fast forwards continuously
6	Red vertical bar: Shows what portion of the cached broadcast is currently playing Light blue bar: Shows time in which cache writing is in progress

### AUTOMATIC PLAYBACK OF THE CACHE

If the radio broadcast is interrupted by another audio output, such as an incoming phone call, the system will automatically cache the interrupted portion and perform time-shift playback when the interruption ends. To manually operate the cache operation: (→P.182)

#### INFORMATION

- The system can store up to 15 minutes. Cached data will be erased when the radio mode or station is changed or when the audio system is turned off.
- If noise or silence occurs during the caching process, cache writing will continue, with the noise or silence recorded as is. In this case, the cached broadcast will contain the noise or silence when played back.

### RADIO BROADCAST DATA SYSTEM

This audio system is equipped with Radio Broadcast Data Systems (RBDS). RBDS mode allows text messages to be received from radio stations that utilize RBDS transmitters.

When RBDS is on, the radio can

- only select stations of a particular program type,
- display messages from radio stations,
- search for a stronger signal station.

RBDS features are available only when listening to an FM station that broadcasts RBDS information and the "FM Info" indicator is on.

4

AUDIO/VISUAL SYSTEM

## 2. RADIO OPERATION

### SELECTING A DESIRED PROGRAM TYPE

#### 1 Select "Options".



#### 2 Select "TYPE >" or "< TYPE" to move forward and backward through the program list.



- Once a program type has been set, "TYPE SEEK" will appear on the screen.

- The program list is in the following order:

- "Classical"
- "Country"
- "EasyLis" (Easy Listening)
- "Inform" (Information)
- "Jazz"
- "News"
- "Oldies"
- "Other"
- "Pop Music"
- "Religion"
- "Rock"
- "R&B" (Rhythm and Blues)
- "Sports"
- "Talk"
- "Traffic" (Not available when "HD Radio" indicator is off.)
- "Alert" (Emergency Alert)

- 3 Select "TYPE SEEK" and the system will start to seek for stations in the relevant program type.

#### INFORMATION

- If no relevant program can be found, "no type" will appear on the screen.



## TRAFFIC ANNOUNCEMENT (FM RADIO)

A station that regularly broadcasts traffic information is automatically located.

- 1 Select "Options".



- 2 Select "Traffic" to seek a traffic program station. "TRAF SEEK" will appear on the screen.



### (INFORMATION)

- If no traffic program station is found, "No Traffic" will appear on the screen.
- If a traffic program station is found, the name of the traffic program station will be displayed for a while.

## USING HD Radio™ TECHNOLOGY

HD Radio™ Technology is the digital evolution of analog AM/FM radio. Your radio product has a special receiver which allows it to receive digital broadcasts (where available) in addition to the analog broadcasts it already receives. Digital broadcasts have better sound quality than analog broadcasts as digital broadcasts provide free, crystal clear audio with no static or distortion. For more information, and a guide to available radio stations and programming, refer to [www.hdradio.com](http://www.hdradio.com).

### HD Radio features included in Lexus radios:

- Digital Sound — HD Radio broadcasts deliver crystal-clear, digital audio quality to listeners.
- HD2/HD3 Channels — FM stations can provide additional digital only audio programming with expanded content and format choices on HD2/HD3 channels.
- PSD — Program Service Data (PSD) gives you on-screen information such as artist name and song title.
- iTunes Tagging — Listeners can tag (store) songs they like for later review and purchase through iTunes.
- Artist Experience — Images related to the broadcast are displayed on the radio screen, such as album cover art and station logos.

4

AUDIO/VISUAL SYSTEM

# HD Radio®

HD Radio Technology manufactured under license from iBiquity Digital Corporation. U.S. and Foreign Patents. HD Radio™ and the HD, HD Radio, and “Arc” logos are proprietary trademarks of iBiquity Digital Corp.

## AVAILABLE HD Radio™ TECHNOLOGY

### MULTICAST

On the FM radio frequency most digital stations have “multiple” or supplemental programs on one FM station.

- 1 Select the “HD” logo.



- 2 Select the desired channel.



- Turning the “TUNE-SCROLL” knob can also select the desired multicast channel.

### PRESERVING A MUSIC INFORMATION

Tag information in the music broadcasting is preserved in the system and transmits to an iPod.

- 1 Select “Tag” to bookmark the music information.



- 2 Connect an iPod. (→P.171)

- Turn on the power of the iPod if it is not turned on.
- Once an iPod is connected, the music tag moves from the radio into the iPod.
- When the iPod is connected to iTunes, the “tagged” information of the songs which were tagged while listening to the radio can be viewed. Then a user may decide to purchase the song or CD/Album which had been listened to on their radio.

**INFORMATION**

- The tag information can not be preserved while scanning or caching the radio station.
- If tagging the music information fails, "Saving the HD Radio tag failed." will be displayed on the screen. If this occurs, tag the information again.
- HD Radio™ stations can be preset.
- An orange "HD)" logo indicator will be displayed on the screen when in digital. The "HD)" logo will first appear in a gray color indicating the station is indeed (an analog and) a digital station. Once the digital signal is acquired, the logo will change to a bright orange color.
- The song title, artist name and music genre will appear on the screen when available by the radio station. In addition, radios stations may send album cover pictures when available.
- As a user works through the analog radio stations, (where applicable) the radio receiver will automatically tune from an analog signal to a digital signal within 5 seconds.

## 2. RADIO OPERATION

### TROUBLESHOOTING GUIDE

Experience	Cause	Action
Mismatch of time alignment- a user may hear a short period of programming replayed or an echo, stutter or skip.	The radio stations analog and digital volume is not properly aligned or the station is in ballgame mode.	None, radio broadcast issue. A user can contact the radio station.
Sound fades, blending in and out.	Radio is shifting between analog and digital audio.	Reception issue, may clear-up as the vehicle continues to be driven. Turning the indicator of the "HD Radio" button off can force radio in an analog audio.
Audio mute condition when an HD2/HD3 multicast channel had been playing.	The radio does not have access to digital signals at the moment.	This is normal behavior, wait until the digital signal returns. If out of the coverage area, seek a new station.
Audio mute delay when selecting an HD2/HD3 multicast channel preset.	The digital multicast content is not available until HD Radio™ broadcast can be decoded and make the audio available. This takes up to 7 seconds.	This is normal behavior, wait for the audio to become available.
Text information does not match the present song audio.	Data service issue by the radio broadcaster.	Broadcaster should be notified. Complete the form; <a href="http://www.ibequality.com/automotive/report_radio_station_experiences">www.ibequality.com/automotive/report_radio_station_experiences</a> .
No text information shown for the present selected frequency.	Data service issue by the radio broadcaster.	Broadcaster should be notified. Complete the form; <a href="http://www.ibequality.com/automotive/report_radio_station_experiences">www.ibequality.com/automotive/report_radio_station_experiences</a> .

## 2. RADIO OPERATION

### 2. XM Satellite Radio

#### OVERVIEW

The radio operation screen can be reached by the following methods:

▶ Using the instrument panel

Press the **"RADIO"** button to display the audio control screen.

▶ Using the Remote Touch

Press the **"MENU"** button on the Remote Touch, then select **"Radio"** to display the audio control screen.

4

#### CONTROL SCREEN

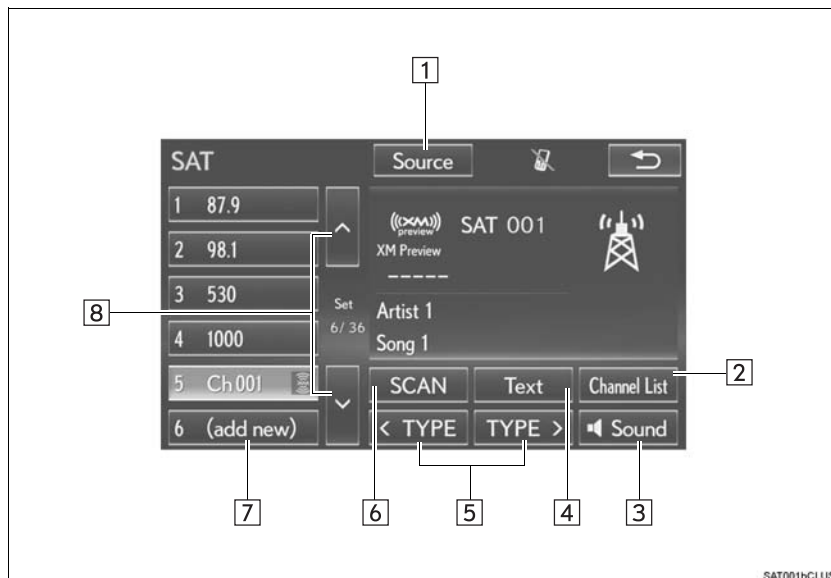

AUDIO/VISUAL SYSTEM

## 2. RADIO OPERATION

### ■ CONTROL PANEL

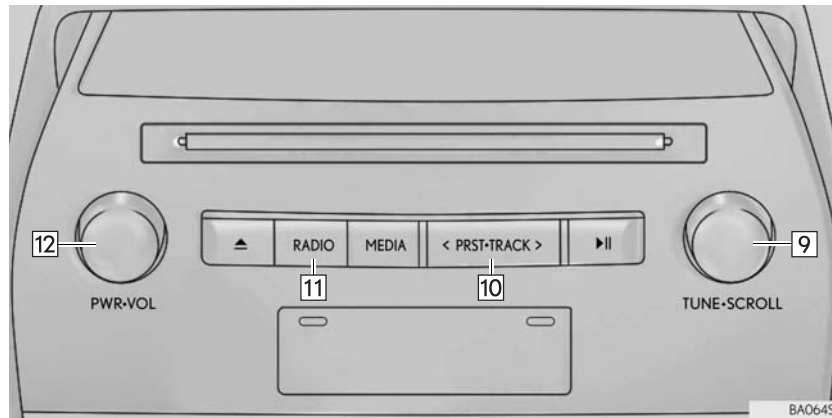

No.	Function
1	Select to display the audio source selection screen.
2	Select to display a receivable channel list.
3	Select to display the sound setting screen.
4	Select to display text messages.
5	Select to select a program type/channel category.
6	Select to scan for receivable channels.
7	Select to tune to preset stations/channels.
8	Select to change the page of preset buttons.
9	<ul style="list-style-type: none"> <li>• Turn to step up/down channels.</li> <li>• Turn to move up/down the list.</li> </ul>
10	<ul style="list-style-type: none"> <li>• Press to select a preset channel.</li> <li>• Press and hold to seek for a channel.</li> </ul>
11	<ul style="list-style-type: none"> <li>• Press to select a radio mode.</li> <li>• While in a radio mode, pressing the "RADIO" button changes radio modes.</li> </ul>
12	<ul style="list-style-type: none"> <li>• Turn to adjust volume.</li> <li>• Press to turn the audio system on/off.</li> <li>• Press and hold to restart the audio system.</li> </ul>

4

AUDIO/VISUAL SYSTEM

## 2. RADIO OPERATION

### HOW TO SUBSCRIBE TO AN XM Satellite Radio

To listen to a satellite radio broadcast in the vehicle, a subscription to the XM Satellite Radio service is necessary.

An XM Satellite Radio is a tuner designed exclusively to receive broadcasts provided under a separate subscription. Availability is limited to the 48 contiguous U.S. states and some Canadian provinces.

### HOW TO SUBSCRIBE

It is necessary to enter into a separate service agreement with XM Satellite Radio in order to receive satellite broadcast programming in the vehicle. Additional activation and service subscription fees apply that are not included in the purchase price of the vehicle and digital satellite tuner.

- For complete information on subscription rates and terms, or to subscribe to XM Satellite Radio:

- ▶ U.S.A.  
Refer to [www.siriusxm.com](http://www.siriusxm.com) or call 1-877-447-0011.
- ▶ Canada  
Refer to [www.siriusxm.ca](http://www.siriusxm.ca) or call 1-877-438-9677.

### NOTICE

- XM Radio Services— Legal Disclaimers and Warnings
  - Fees and Taxes— Subscription fee, taxes, one time activation fee, and other fees may apply. Subscription fee is consumer only. All fees and programming subject to change. Subscriptions subject to Customer Agreement available at [www.siriusxm.com](http://www.siriusxm.com). (U.S.A.) or [www.siriusxm.ca](http://www.siriusxm.ca) (Canada) XM service only available in the 48 contiguous United States and Canada.
  - Explicit Language Notice— Channels with frequent explicit language are indicated with an “XL” preceding the channel name. Channel blocking is available for XM Satellite Radio receivers by notifying XM at;  
U.S.A. Customers:  
Visit [www.siriusxm.com](http://www.siriusxm.com) or calling 1-877-447-0011  
Canadian Customers:  
Visit [www.siriusxm.ca](http://www.siriusxm.ca) or calling 1-877-438-9677
- It is prohibited to copy, decompile, disassemble, reverse engineer, hack, manipulate, or otherwise make available any technology or software incorporated in receivers compatible with the XM Satellite Radio System or that support the XM website, the Online Service or any of its content. Furthermore, the AMBE<sup>®</sup> voice compression software included in this product is protected by intellectual property rights including patent rights, copyrights, and trade secrets of Digital Voice Systems, Inc.
- Note: this applies to XM receivers only and not XM Ready devices.



**INFORMATION**

- XM Radio Services—Descriptions
  - Radio and Entertainment  
XM offers more than 170 satellite radio channels of commercial-free music and premier sports, news, talk, and entertainment. XM is broadcast via satellites to millions of listeners across the continental United States. XM subscribers listen to XM on satellite radio receivers for the car, home, and portable use. More information about XM is available online at [www.siriusxm.com](http://www.siriusxm.com) (U.S.A.) or [www.siriusxm.ca](http://www.siriusxm.ca) (Canada).
- XM Radio Services—Subscription Instructions
  - For XM Services requiring a subscription (such as XM Radio, and some Infotainment & data services), the following paragraph shall be included. Required XM Radio and some Infotainment & data services monthly subscriptions sold separately after trial period. Subscription fee is consumer only. All fees and programming subject to change. Subscriptions are subject to the Customer Agreement available at [www.siriusxm.com](http://www.siriusxm.com). XM service only available in the 48 contiguous United States. © 2011 Sirius XM Radio Inc. Sirius, XM and all related marks and logos are trademarks of Sirius XM Radio Inc. All other marks, channel names and logos are the property of their respective owners.  
For more information, program schedules, and to subscribe or extend subscription after complimentary trial period; more information is available at: USA Customers:  
Visit [www.siriusxm.com](http://www.siriusxm.com) or call 1-877-447-0011

**INFORMATION**

- XM Satellite Radio is solely responsible for the quality, availability and content of the satellite radio services provided, which are subject to the terms and conditions of the XM Satellite Radio customer service agreement.
- Customers should have their radio ID ready; the radio ID can be found by tuning to “Ch 000” on the radio. For details, see “DISPLAYING THE RADIO ID” below.
- All fees and programming are the responsibility of XM Satellite Radio and are subject to change.

**SATELLITE TUNER TECHNOLOGY NOTICE**

Lexus’s satellite radio tuners are awarded Type Approval Certificates from XM Satellite Radio Inc. as proof of compatibility with the services offered by XM Satellite Radio.

**INFORMATION**

- Satellite tuner  
The tuner supports only Audio Services (Music and Talk) and the accompanying Text Information of XM<sup>®</sup> Satellite Radio.

## 2. RADIO OPERATION

### DISPLAYING THE RADIO ID

Each XM tuner is identified with a unique radio ID. The radio ID is required when activating an XM service or when reporting a problem.

- If “Ch000” is selected using the “TUNE-SCROLL” knob, the ID code, which is 8 alphanumeric characters, will be displayed. If another channel is selected, the ID code will no longer be displayed. The channel (000) alternates between displaying the radio ID and the specific radio code.

### PRESETTING A CHANNEL

- 1 Tune in the desired channel.
- 2 Select “add new”.



- To change the preset channel to a different one, select and hold the preset station/channel.
- 3 Select “Yes” on the confirmation screen.
  - 4 Select “OK” after setting the new preset channel.

## SELECTING A CHANNEL FROM THE LIST

- 1 Select "Channel List".



- 2 Select the desired program type.

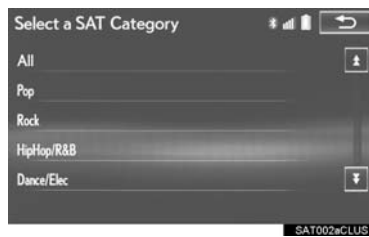

- 3 Select the desired channel and select "OK".

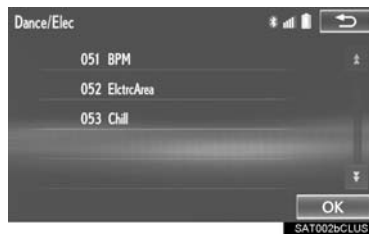

4

AUDIO/VISUAL SYSTEM

## 2. RADIO OPERATION

### IF THE SATELLITE RADIO TUNER MALFUNCTIONS

When problems occur with the XM tuner, a message will appear on the screen. Referring to the table below to identify the problem, take the suggested corrective action.

Message	Explanation
"Ck Antenna"	The XM antenna is not connected. Check whether the XM antenna cable is attached securely.
	A short circuit occurs in the antenna or the surrounding antenna cable. See a Lexus certified dealer for assistance.
"Ch Unauth"	You have not subscribed to XM Satellite Radio. The radio is being updated with the latest encryption code. Contact XM Satellite Radio for subscription information. When a contract is canceled, you can choose "Ch 000" and all free-to-air channels.
	The premium channel you selected is not authorized. Wait for about 2 seconds until the radio returns to the previous channel or "Ch 001". If it does not change automatically, select another channel. To listen to the premium channel, contact XM Satellite Radio.
"No Signal"	The XM signal is too weak at the current location. Wait until your vehicle reaches a location with a stronger signal.
"Loading..."	The unit is acquiring audio or program information. Wait until the unit has received the information.
"Ch Off Air"	The channel you selected is not broadcasting any programming. Select another channel.
-----	There is no song/program title or artist name/feature associated with the channel at that time. No action is required.
"Ch Unavail"	The channel you selected is no longer available. Wait for about 2 seconds until the radio returns to the previous channel or "Ch 001". If it does not change automatically, select another channel.

#### INFORMATION

- Contact the XM Listener Care Center at 1-877-447-0011 (U.S.A.) or 1-877-438-9677 (Canada).

## 2. RADIO OPERATION

### 3. INTERNET RADIO

#### LISTENING TO INTERNET RADIO

One of LEXUS App Suite's features is the ability to listen to internet radio. In order to use this service, a compatible phone and the navigation system needs to be set up. For details: →P.353

- 1 Select the desired application screen button.



- The internet radio application screen is displayed.
- Perform operations according to the displayed application screen.
- For the instrument panel operation method and the Remote Touch operation method: →P.169
- By pressing the "RADIO" button, the "Audio" screen can be returned to.

#### INFORMATION

- Other applications can be activated while listening to internet radio.
- An iPhone cannot be connected via Bluetooth® and USB connection at the same time. However, it is possible to recharge an iPhone while using applications by connecting via USB. The system uses the connection method that was used last. Therefore, if connected via USB after Bluetooth® connection, it is necessary to reconnect the iPhone via Bluetooth®.
- Services requiring a separate contract can also be used.\*
- Some parts of applications can be adjusted using the switches on the steering wheel.

\*: For details, refer to <http://www.lexus.com/enform/> or call 1-800-255-3987.

4

AUDIO/VISUAL SYSTEM

### 3. MEDIA OPERATION

## 1. CD

#### OVERVIEW

The CD operation screen can be reached by the following methods:

- ▶ Inserting a disc (→P.170)
- ▶ Using the instrument panel

Press the “**MEDIA**” button to display the audio control screen.

- ▶ Using the Remote Touch

Press the “**MENU**” button on the Remote Touch, then select “**Media**” to display the audio control screen.

#### ■ CONTROL SCREEN

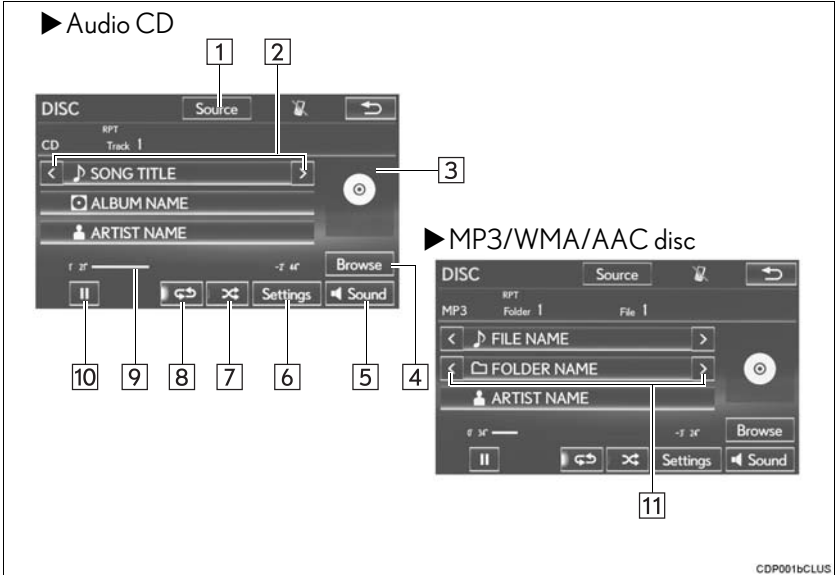

■ CONTROL PANEL

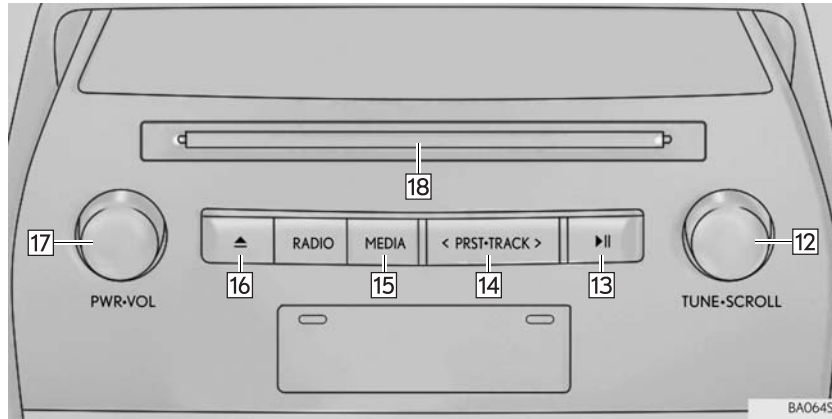

4  
AUDIO/VISUAL SYSTEM

### 3. MEDIA OPERATION

No.	Function
1	Select to display the audio source selection screen.
2	Select to select a track/file.
3	<ul style="list-style-type: none"> <li>• Displays cover art</li> <li>• Select to display a track/file list.</li> </ul>
4	<ul style="list-style-type: none"> <li>• Audio CD: Select to display a track list.</li> <li>• MP3/WMA/AAC disc: Select to display a folder list. To return to the top screen, select <b>"Now Playing"</b> on the list screen.</li> </ul>
5	Select to display the sound setting screen.
6	Select to display the audio setting screen.
7	Select to set random playback.
8	Select to set repeat playback.
9	Shows progress
10	Select to play/pause.
11	Select to select a folder.
12	<ul style="list-style-type: none"> <li>• Turn to select a track/file.</li> <li>• Turn to move up/down the list.</li> </ul>
13	Press to play/pause.
14	<ul style="list-style-type: none"> <li>• Press to select a track/file.</li> <li>• Press and hold to fast forward/rewind.</li> </ul>
15	<ul style="list-style-type: none"> <li>• Press to select a media mode.</li> <li>• While in a media mode, pressing the <b>"MEDIA"</b> button changes media modes.</li> </ul>
16	Press to eject a disc.
17	<ul style="list-style-type: none"> <li>• Turn to adjust volume.</li> <li>• Press to turn the audio system on/off.</li> <li>• Press and hold to restart the audio system.</li> </ul>
18	Disc slot



**INFORMATION**

- If a disc contains CD-DA files and MP3/WMA/AAC files, only the CD-DA files can be played back.
- If a CD-TEXT disc is inserted, the title of the disc and track will be displayed. Up to 32 characters can be displayed.

### 3. MEDIA OPERATION

#### PLAYING AN AUDIO CD

##### REPEATING

The track currently being listened to can be repeated.

1 Select .



- Each time  is selected, the mode changes as follows:
  - track repeat → off

##### INFORMATION

- When  is selected, "RPT" appears on the screen.

#### RANDOM ORDER

Tracks can be automatically and randomly selected.

1 Select .



- Each time  is selected, the mode changes as follows:
  - random (1 disc random) → off

##### INFORMATION

- When  is selected, "RAND" appears on the screen.

PLAYING AN MP3/WMA/  
AAC DISC

## REPEATING

The file or folder currently being listened to can be repeated.

- 1 Select .



- Each time  is selected, the mode changes as follows:
  - ▶ When random playback is off
    - file repeat → folder repeat → off
  - ▶ When random playback is on
    - file repeat → off

**INFORMATION**

- Each time  is selected, "RPT"/"FLD.RPT" appears on the screen.

## RANDOM ORDER

Files or folders can be automatically and randomly selected.

- 1 Select .



- Each time  is selected, the mode changes as follows:
  - random (1 folder random) → folder random (1 disc random) → off

**INFORMATION**

- Each time  is selected, "RAND"/"FLD.RAND" appears on the screen.

4

AUDIO/VISUAL SYSTEM

### 3. MEDIA OPERATION

## 2. DVD

For safety reasons, the DVD video discs can only be viewed when the following conditions are met:

- (a) The vehicle is completely stopped.
- (b) The engine <power> switch is in ACCESSORY or IGNITION ON <ON> mode.
- (c) The parking brake is applied.

While driving in DVD video mode, only the DVD's audio can be heard.

The playback condition of some DVD discs may be determined by the DVD software producer. This DVD player plays a disc as the software producer intended. As such, some functions may not work properly. Be sure to read the instruction manual that comes with the individual DVD disc. (→P.246)

### OVERVIEW

The DVD operation screen can be reached by the following methods:

▶ Inserting a disc (→P.170)

▶ Using the instrument panel

Press the **"MEDIA"** button to display the audio control screen.

▶ Using the Remote Touch

Press the **"MENU"** button on the Remote Touch, then select **"Media"** to display the audio control screen.

■ CONTROL SCREEN

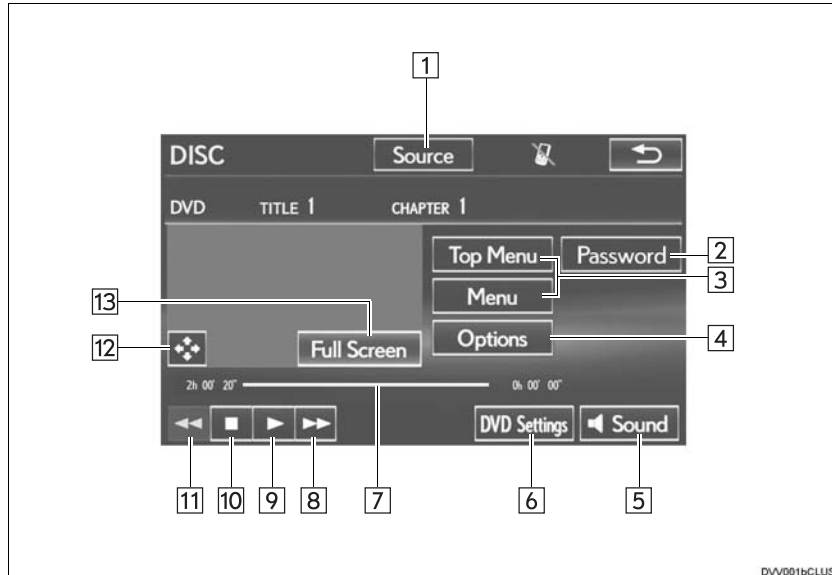

4  
AUDIO/VISUAL SYSTEM

■ CONTROL PANEL

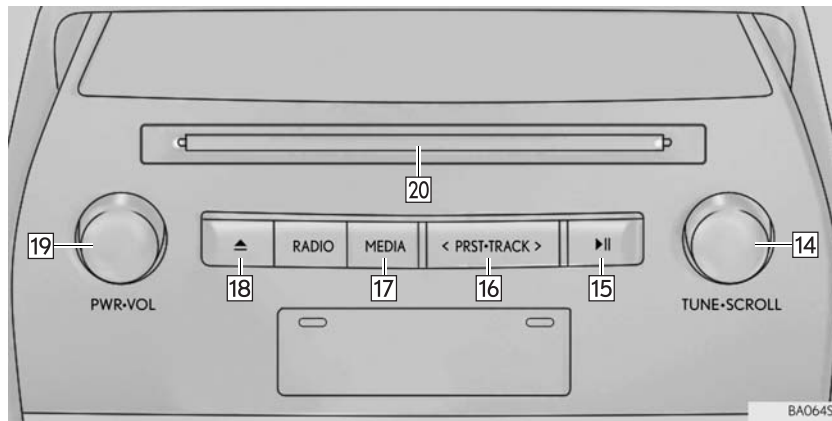

### 3. MEDIA OPERATION

No.	Function
1	Select to display the audio source selection screen.
2	Select to display the password input screen.
3	Select to display the menu screen.
4	Select to display the option screen. (→P.208)
5	Select to display the sound setting screen.
6	Select to display the DVD setting screen.
7	Shows progress
8	<ul style="list-style-type: none"> <li>• During playback: Select to fast forward.</li> <li>• During a pause: Select to slow forward.</li> </ul>
9	Select to play/pause.
10	Select to stop the video screen.
11	Select to rewind.
12	Select to display the menu control key.
13	Select to display full screen video.
14	Turn to select a chapter.
15	Press to play/pause.
16	<ul style="list-style-type: none"> <li>• Press to select a chapter.</li> <li>• Press and hold to fast forward/rewind.</li> </ul>
17	<ul style="list-style-type: none"> <li>• Press to select a media mode.</li> <li>• While in a media mode, pressing the "MEDIA" button changes media modes.</li> </ul>
18	Press to eject a disc.
19	<ul style="list-style-type: none"> <li>• Turn to adjust volume.</li> <li>• Press to turn the audio system on/off.</li> <li>• Press and hold to restart the audio system.</li> </ul>
20	Disc slot

**⚠ WARNING**

- Conversational speech on some DVDs is recorded at a low volume to emphasize the impact of sound effects. If you adjust the volume assuming that the conversations represent the maximum volume level that the DVD will play, you may be startled by louder sound effects or when you change to a different audio source. The louder sounds may have a significant impact on the human body or pose a driving hazard. Keep this in mind when you adjust the volume.

**ℹ INFORMATION**

- According to the DVD disc, some menu items can be selected directly. (For details, see the manual that comes with the DVD disc provided separately.)
- If  appears on the screen when a control is selected, the operation relevant to the control is not permitted.

### 3. MEDIA OPERATION

#### DVD OPTIONS

1 Select "Options".



2 The following screen is displayed.

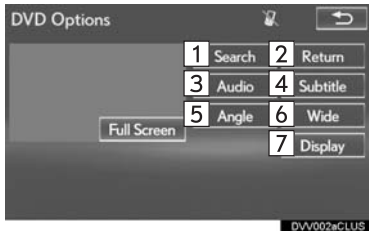

No.	Function	Page
1	Select to display the title search screen.	209
2	Select to display the predetermined scene on the screen and start playing.	—
3	Select to display the audio selection screen.	209
4	Select to display the subtitle selection screen.	209
5	Select to display the angle selection screen.	210
6	Select to change the screen size.	174
7	Select to display the image quality adjustment screen.	174



## SEARCHING BY TITLE

- 1 Select "Search".
- 2 Enter the title number and select "OK".



- The player starts playing video for that title number.

## CHANGING THE AUDIO LANGUAGE

- 1 Select "Audio".
- 2 Each time "Change" is selected, the audio language is changed.



- The languages available are restricted to those available on the DVD disc.

## CHANGING THE SUBTITLE LANGUAGE

- 1 Select "Subtitle".
- 2 Each time "Change" is selected, the language the subtitles are displayed in is changed.

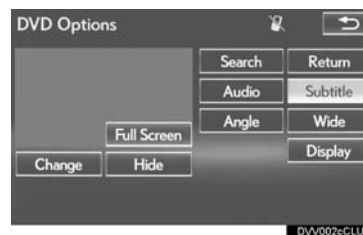

- The languages available are restricted to those available on the DVD disc.
- When "Hide" is selected, the subtitles can be hidden.

4

AUDIO/VISUAL SYSTEM

#### CHANGING THE ANGLE

The angle can be selected for discs that are multi-angle compatible when the angle mark appears on the screen.

- 1 Select **"Angle"**.
- 2 Each time **"Change"** is selected, the angle is changed.



- The angles available are restricted to those available on the DVD disc.

### 3. MEDIA OPERATION

## 3. USB MEMORY

### OVERVIEW

The USB memory operation screen can be reached by the following methods:

▶ Connecting a USB memory (→P.171)

▶ Using the instrument panel

Press the **"MEDIA"** button to display the audio control screen.

▶ Using the Remote Touch

Press the **"MENU"** button on the Remote Touch, then select **"Media"** to display the audio control screen.

4

### ■ CONTROL SCREEN

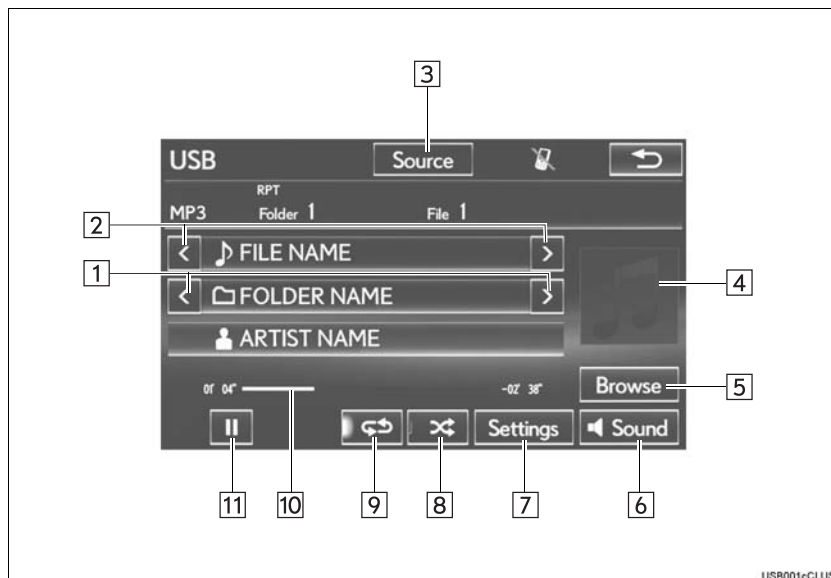

AUDIO/VISUAL SYSTEM

### 3. MEDIA OPERATION

#### ■ CONTROL PANEL

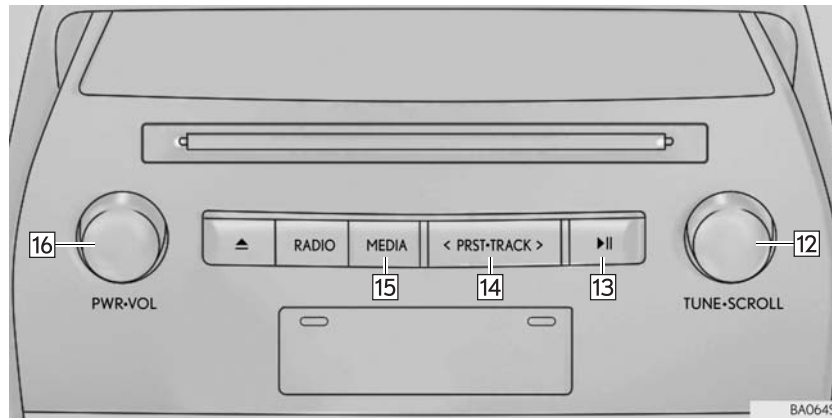

No.	Function
1	Select to select a folder/album.
2	Select to select a file/track.
3	Select to display the audio source selection screen.
4	<ul style="list-style-type: none"> <li>• Displays cover art</li> <li>• Select to display a file/track list. To return to the top screen, select <b>"Now Playing"</b> on the list screen.</li> </ul>
5	Select to display the play mode selection screen. To return to the top screen, select <b>"Now Playing"</b> on the list screen.
6	Select to display the sound setting screen.
7	Select to display the audio settings screen.
8	Select to set random playback.
9	Select to set repeat playback.
10	Shows progress
11	Select to play/pause.
12	<ul style="list-style-type: none"> <li>• Turn to select a track/file.</li> <li>• Turn to move up/down the list.</li> </ul>
13	Press to play/pause.
14	<ul style="list-style-type: none"> <li>• Press to select a track/file.</li> <li>• Press and hold to fast forward/rewind.</li> </ul>
15	<ul style="list-style-type: none"> <li>• Press to select a media mode.</li> <li>• While in a media mode, pressing the <b>"MEDIA"</b> button changes media modes.</li> </ul>
16	<ul style="list-style-type: none"> <li>• Turn to adjust volume.</li> <li>• Press to turn the audio system on/off.</li> <li>• Press and hold to restart the audio system.</li> </ul>

### 3. MEDIA OPERATION

#### WARNING

- Do not operate the player's controls or connect the USB memory while driving.

#### NOTICE

- Depending on the size and shape of the USB memory that is connected to the system, the armrest may not close fully. In this case, do not forcibly close the armrest as this may damage the USB memory or the terminal, etc.
- Do not leave your portable player in the car. In particular, high temperatures inside the vehicle may damage the portable player.
- Do not push down on or apply unnecessary pressure to the portable player while it is connected as this may damage the portable player or its terminal.
- Do not insert foreign objects into the port as this may damage the portable player or its terminal.

#### INFORMATION

- If tag information exists, the file/folder names will be changed to track/album names.

USB AUDIO

REPEATING

The file/track or folder/album currently being listened to can be repeated.

1 Select .



- Each time  is selected, the mode changes as follows:
  - ▶ When random playback is off
    - file/track repeat → folder/album repeat → off
  - ▶ When random playback is on
    - file/track repeat → off

(INFORMATION)

- Each time  is selected, "RPT"/"FLD.RPT" appears on the screen.

RANDOM ORDER

Files/tracks or folders/albums can be automatically and randomly selected.

1 Select .



- Each time  is selected, the mode changes as follows:
  - random (1 folder/album random) → folder/album random (all folder/album random) → off

(INFORMATION)

- Each time  is selected, "RAND"/"FLD.RAND" appears on the screen.

4 AUDIO/VISUAL SYSTEM

### 3. MEDIA OPERATION

## 4. iPod

### OVERVIEW

The iPod operation screen can be reached by the following methods:

▶ Connecting an iPod (→P.171)

▶ Using the instrument panel

Press the “**MEDIA**” button to display the audio control screen.

▶ Using the Remote Touch

Press the “**MENU**” button on the Remote Touch, then select “**Media**” to display the audio control screen.

### ■ CONTROL SCREEN

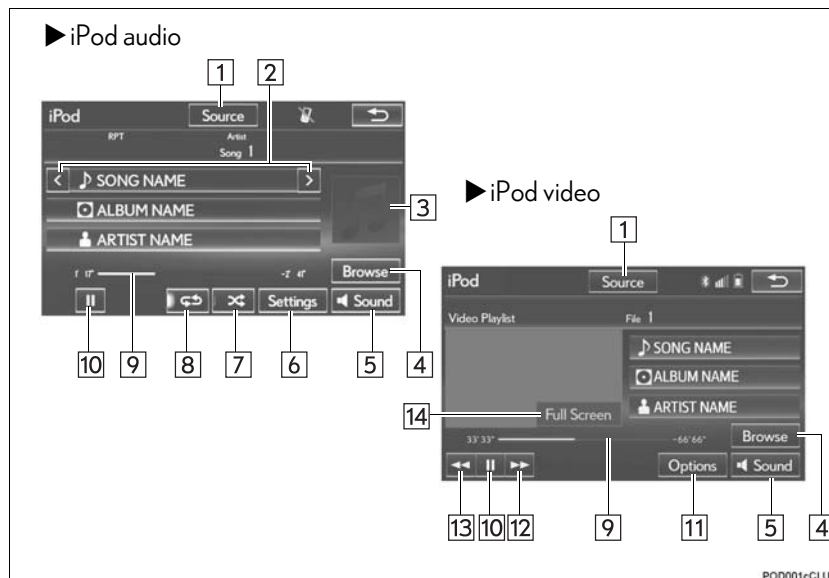



■ CONTROL PANEL

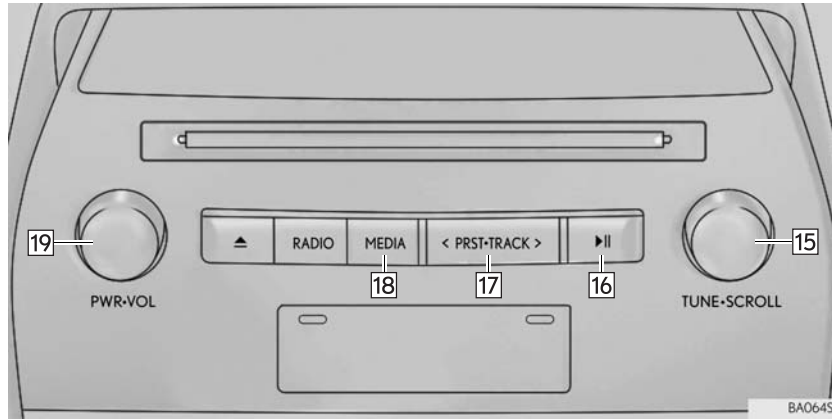

4  
AUDIO/VISUAL SYSTEM

### 3. MEDIA OPERATION

No.	Function	
	Audio	Video
1	Select to display the audio source selection screen.	Select to display the audio source selection screen.
2	Select to select a track.	—
3	<ul style="list-style-type: none"> <li>• Displays cover art</li> <li>• Select to display a track list. To return to the top screen, select “<b>Now Playing</b>” on the list screen.</li> </ul>	—
4	Select to display the play mode selection screen. To return to the top screen, select “ <b>Now Playing</b> ” on the list screen.	Select to display the play mode selection screen. To return to the top screen, select “ <b>Now Playing</b> ” on the list screen.
5	Select to display the sound setting screen.	Select to display the sound setting screen.
6	Select to display the audio settings screen.	—
7	Select to set random playback.	—
8	Select to set repeat playback.	—
9	Shows progress	Shows progress
10	Select to play/pause.	Select to play/pause.
11	—	Select to display the option screen. (→P.222)
12	—	Select to fast forward.
13	—	Select to rewind.
14	—	Select to display full screen video.
15	<ul style="list-style-type: none"> <li>• Turn to select a track.</li> <li>• Turn to move up/down the list.</li> </ul>	<ul style="list-style-type: none"> <li>• Turn to select a file.</li> <li>• Turn to move up/down the list.</li> </ul>
16	Press to play/pause.	Press to play/pause.
17	<ul style="list-style-type: none"> <li>• Press to select a track.</li> <li>• Press and hold to fast forward/rewind.</li> </ul>	<ul style="list-style-type: none"> <li>• Press to select a file.</li> <li>• Press and hold to fast forward/rewind.</li> </ul>

No.	Function	
	Audio	Video
18	<ul style="list-style-type: none"> <li>• Press to select a media mode.</li> <li>• While in a media mode, pressing the "MEDIA" button changes media modes.</li> </ul>	<ul style="list-style-type: none"> <li>• Press to select a media mode.</li> <li>• While in a media mode, pressing the "MEDIA" button changes media modes.</li> </ul>
19	<ul style="list-style-type: none"> <li>• Turn to adjust volume.</li> <li>• Press to turn the audio system on/off.</li> <li>• Press and hold to restart the audio system.</li> </ul>	<ul style="list-style-type: none"> <li>• Turn to adjust volume.</li> <li>• Press to turn the audio system on/off.</li> <li>• Press and hold to restart the audio system.</li> </ul>

4

AUDIO/VISUAL SYSTEM

### 3. MEDIA OPERATION

#### WARNING

- Do not operate the player's controls or connect the iPod while driving.

#### NOTICE

- Depending on the size and shape of the iPod that is connected to the system, the armrest may not close fully. In this case, do not forcibly close the armrest as this may damage the iPod or the terminal, etc.
- Do not leave your portable player in the car. In particular, high temperatures inside the vehicle may damage the portable player.
- Do not push down on or apply unnecessary pressure to the portable player while it is connected as this may damage the portable player or its terminal.
- Do not insert foreign objects into the port as this may damage the portable player or its terminal.

#### INFORMATION

- The system can only output the sound while driving.
- When an iPod is connected using a genuine iPod cable, the iPod starts charging its battery.
- Depending on the iPod, the video sound may not be able to be heard.
- Depending on the iPod and the songs in the iPod, iPod cover art may be displayed. This function can be changed to "On" or "Off". (→P.240) It may take time to display iPod cover art, and the iPod may not be operated while the cover art display is in process.
- When an iPod is connected and the audio source is changed to iPod mode, the iPod will resume playing from the same point it was last used.
- Depending on the iPod that is connected to the system, certain functions may not be available.
- For viewing videos from an iPod, it is necessary to set "Video Sound Input" to "A/V". (→P.238)
- If a LEXUS App Suite application (→P.344) is used while iPod audio/video is being played back, operation may become unstable. In this case, restart the cellular phone. (Refer to the manual that came with the cellular phone for turning it on/off.)

iPod AUDIO

REPEATING

The track currently being listened to can be repeated.

1 Select .



- Each time  is selected, the mode changes as follows:
  - track repeat → off

(INFORMATION)

- When  is selected, "RPT" appears on the screen.

RANDOM ORDER

Tracks or albums can be automatically and randomly selected.

1 Select .



- Each time  is selected, the mode changes as follows:
  - track shuffle → album shuffle → off

(INFORMATION)

- Each time  is selected, "Shuffle"/"Alb.Shuffle" appears on the screen.

4

AUDIO/VISUAL SYSTEM

### 3. MEDIA OPERATION

#### iPod VIDEO

To change to iPod video mode, select **"Browse"** on the iPod audio screen, then select the **"Videos"** tab and select the desired video file.

#### iPod VIDEO OPTIONS

1 Select **"Options"**.



2 Select the desired settings to change.



No.	Function	Page
1	Select to change the screen size.	174
2	Select to display the image quality adjustment screen.	174
3	Select to change audio settings.	237

### 3. MEDIA OPERATION

## 5. Bluetooth® AUDIO

The Bluetooth® audio system enables users to enjoy listening to music that is played on a portable player on the vehicle speakers via wireless communication.

This audio system supports Bluetooth®, a wireless data system capable of playing portable audio music without cables. If your device does not support Bluetooth®, the Bluetooth® audio system will not function.

### OVERVIEW

The Bluetooth® audio operation screen can be reached by the following methods:  
Depending on the type of portable player connected, some functions may not be available and/or the screen may look differently than shown in this manual.

▶ Connecting a Bluetooth® audio device (→P.227)

▶ Using the instrument panel

Press the **"MEDIA"** button to display the audio control screen.

▶ Using the Remote Touch

Press the **"MENU"** button on the Remote Touch, then select **"Media"** to display the audio control screen.

4

AUDIO/VISUAL SYSTEM

### 3. MEDIA OPERATION

#### ■ CONTROL SCREEN

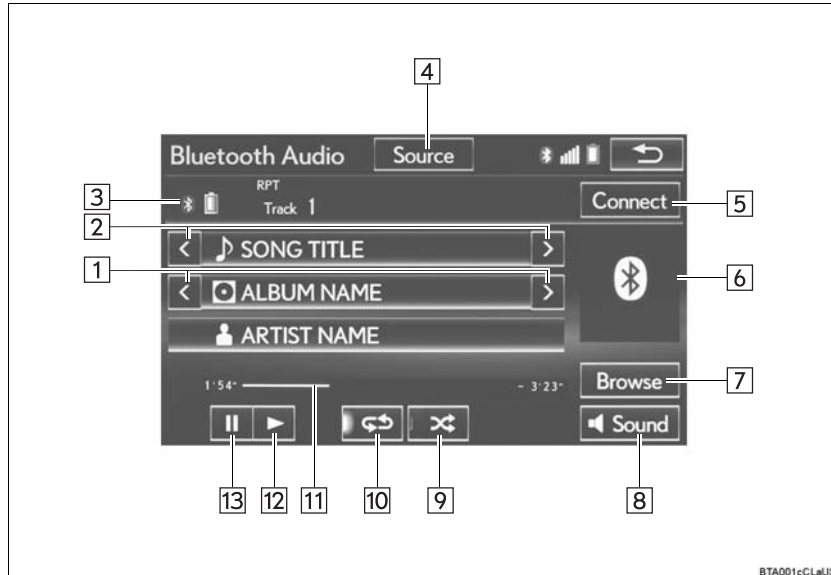

#### ■ CONTROL PANEL

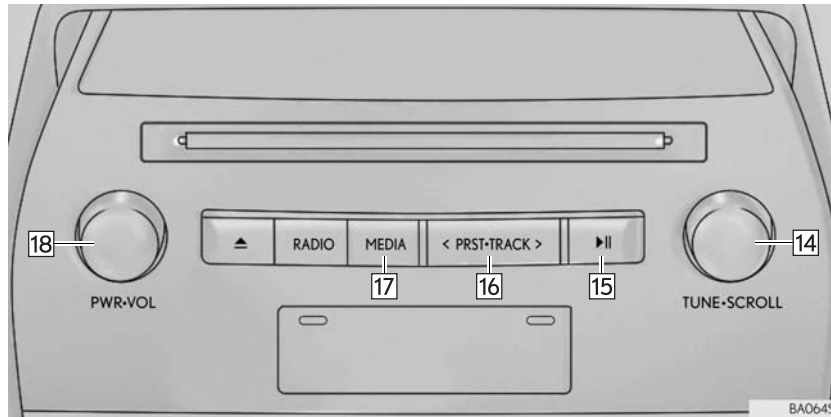



No.	Function
1	Select to select an album.
2	Select to select a track.
3	Displays Bluetooth <sup>®</sup> device condition
4	Select to display the audio source selection screen.
5	Select to display the portable device connection screen.
6	<ul style="list-style-type: none"> <li>• Displays cover art</li> <li>• Select to display a track list. To return to the top screen, select <b>"Now Playing"</b> on the list screen.</li> </ul>
7	Select to display the playlist screen. To return to the top screen, select <b>"Now Playing"</b> on the list screen.
8	Select to display the sound settings screen.
9	Select to set random playback.
10	Select to set repeat playback.
11	Shows progress
12	Select to play.
13	Select to pause.
14	<ul style="list-style-type: none"> <li>• Turn to select a track.</li> <li>• Turn to move up/down the list.</li> </ul>
15	Press to play/pause.
16	<ul style="list-style-type: none"> <li>• Press to select a track.</li> <li>• Press and hold to fast forward/rewind.</li> </ul>
17	<ul style="list-style-type: none"> <li>• Press to select a media mode.</li> <li>• While in a media mode, pressing the <b>"MEDIA"</b> button changes media modes.</li> </ul>
18	<ul style="list-style-type: none"> <li>• Turn to adjust volume.</li> <li>• Press to turn the audio system on/off.</li> <li>• Press and hold to restart the audio system.</li> </ul>

4

AUDIO/VISUAL SYSTEM



#### WARNING

- Do not operate the player's controls or connect to the Bluetooth® audio system while driving.
- Your audio unit is fitted with Bluetooth® antennas. People with implantable cardiac pacemakers, cardiac resynchronization therapy-pacemakers or implantable cardioverter defibrillators should maintain a reasonable distance between themselves and the Bluetooth® antennas. The radio waves may affect the operation of such devices.
- Before using Bluetooth® devices, users of any electrical medical device other than implantable cardiac pacemakers, cardiac resynchronization therapy-pacemakers or implantable cardioverter defibrillators should consult the manufacturer of the device for information about its operation under the influence of radio waves. Radio waves could have unexpected effects on the operation of such medical devices.

#### NOTICE

- Do not leave your portable player in the vehicle. In particular, high temperatures inside the vehicle may damage the portable player.

#### INFORMATION

- Depending on the Bluetooth® device that is connected to the system, the music may start playing when selecting  while it is paused. Conversely, the music may pause when selecting  while it is playing.
- In the following conditions, the system may not function:
  - The Bluetooth® device is turned off.
  - The Bluetooth® device is not connected.
  - The Bluetooth® device has a low battery.
- It may take time to connect the phone when Bluetooth® audio is being played.
- For operating the portable player, see the instruction manual that comes with it.
- If the Bluetooth® device is disconnected due to poor reception from the Bluetooth® network when the engine <power> switch is in ACCESSORY or IGNITION ON <ON> mode, the system automatically reconnects the portable player.
- If the Bluetooth® device is disconnected on purpose, such as it was turned off, this does not happen. Reconnect the portable player manually.
- Bluetooth® device information is registered when the Bluetooth® device is connected to the Bluetooth® audio system. When selling or disposing of the vehicle, remove the Bluetooth® audio information from the system. (→P.72)

## CONNECTING A Bluetooth® DEVICE

To use the Bluetooth® audio system, it is necessary to register a Bluetooth® device with the system.

► Registering an additional device

- 1 Select **"Connect"** on the Bluetooth® audio control screen.
  - 2 For more information: →P.58
- Selecting a registered device
- 1 Select **"Connect"** on the Bluetooth® audio control screen.
  - 2 For more information: →P.60

## LISTENING TO Bluetooth® AUDIO

### REPEATING

The track or album currently being listened to can be repeated.

- 1 Select .



- Each time  is selected, the mode changes as follows:
  - track repeat → album repeat → off

### INFORMATION

- Each time  is selected, "RPT"/"ALB.RPT" appears on the screen.

4

AUDIO/VISUAL SYSTEM

### 3. MEDIA OPERATION

#### RANDOM ORDER

Tracks or albums can be automatically and randomly selected.

1 Select .



- Each time  is selected, the mode changes as follows:
  - album random → all track random → off

#### INFORMATION

- Each time  is selected, "RAND"/"ALB.RAND" appears on the screen.

### 3. MEDIA OPERATION

## 6. AUX

#### OVERVIEW

The AUX operation screen can be reached by the following methods:

▶ Connecting a device to the AUX port (→P.171)

▶ Using the instrument panel

Press the **"MEDIA"** button to display the audio control screen.

▶ Using the Remote Touch

Press the **"MENU"** button on the Remote Touch, then select **"Media"** to display the audio control screen.

4

#### ■ CONTROL SCREEN

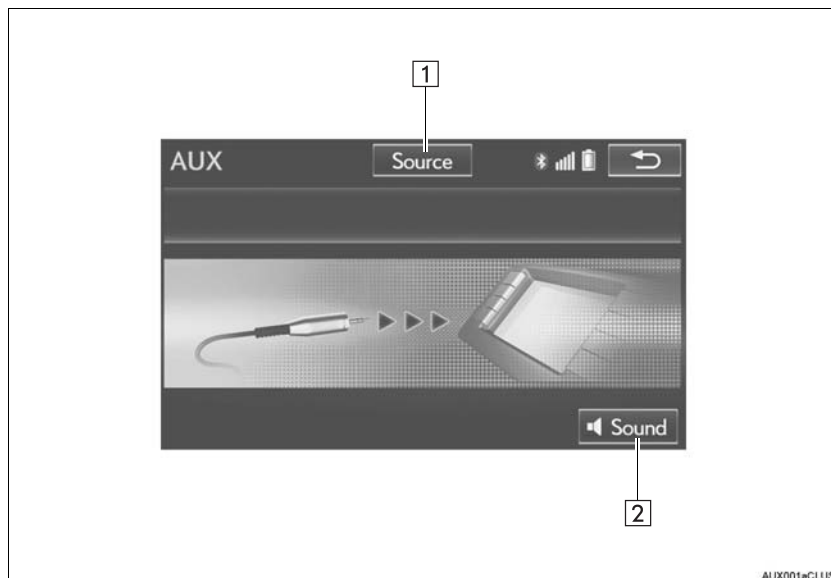

AUDIO/VISUAL SYSTEM

### 3. MEDIA OPERATION

#### ■ CONTROL PANEL

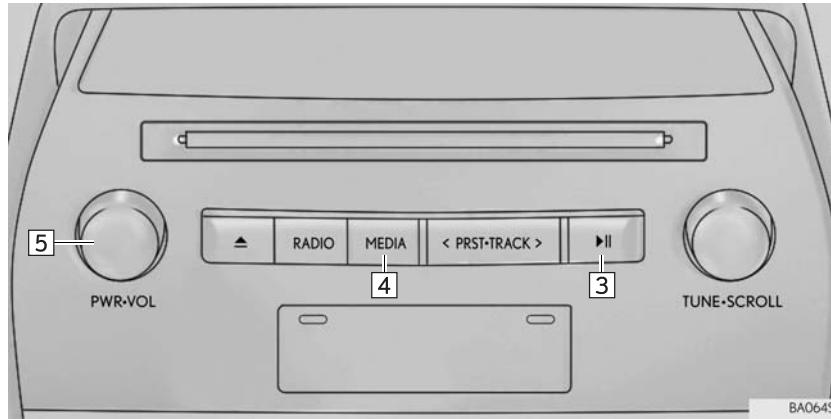

No.	Function
1	Select to display the audio source selection screen.
2	Select to display the sound setting screen.
3	Press to turn mute on/off.
4	<ul style="list-style-type: none"><li>• Press to select a media mode.</li><li>• While in a media mode, pressing the "MEDIA" button changes media modes.</li></ul>
5	<ul style="list-style-type: none"><li>• Turn to adjust volume.</li><li>• Press to turn the audio system on/off.</li><li>• Press and hold to restart the audio system.</li></ul>

 **WARNING**

- Do not connect portable audio device or operate the controls while driving.

 **NOTICE**

- Depending on the size and shape of the portable audio device that is connected to the system, the armrest may not close fully. In this case, do not forcibly close the armrest as this may damage the portable audio device or the terminal, etc.
- Do not leave portable audio device in the vehicle. The temperature inside the vehicle may become high, resulting in damage to the player.
- Do not push down on or apply unnecessary pressure to the portable audio device while it is connected as this may damage the portable audio device or its terminal.
- Do not insert foreign objects into the port as this may damage the portable audio device or its terminal.

4

AUDIO/VISUAL SYSTEM

### 3. MEDIA OPERATION

## 7. VTR

### OVERVIEW

The VTR operation screen can be reached by the following methods:

▶ Connecting a device to the AUX port (→P.171)

▶ Using the instrument panel

Press the “**MEDIA**” button to display the audio control screen.

▶ Using the Remote Touch

Press the “**MENU**” button on the Remote Touch, then select “**Media**” to display the audio control screen.

### ■ CONTROL SCREEN

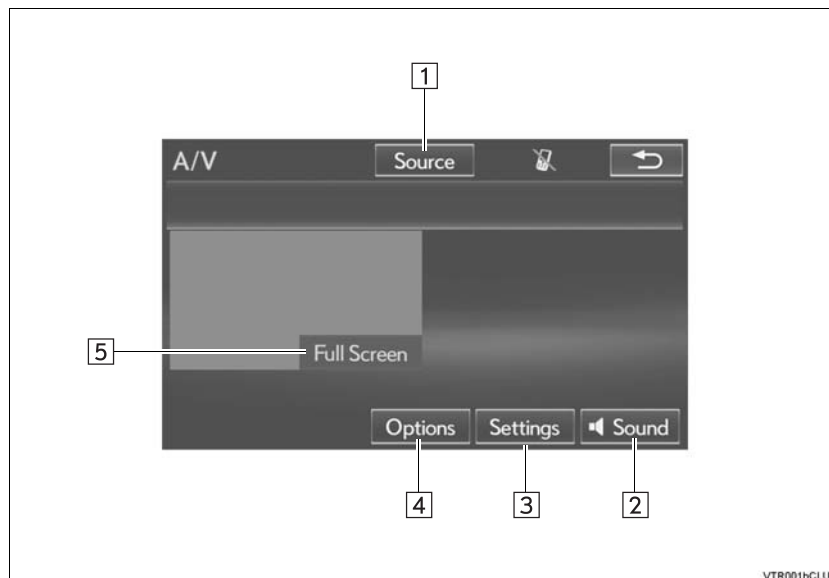



■ CONTROL PANEL

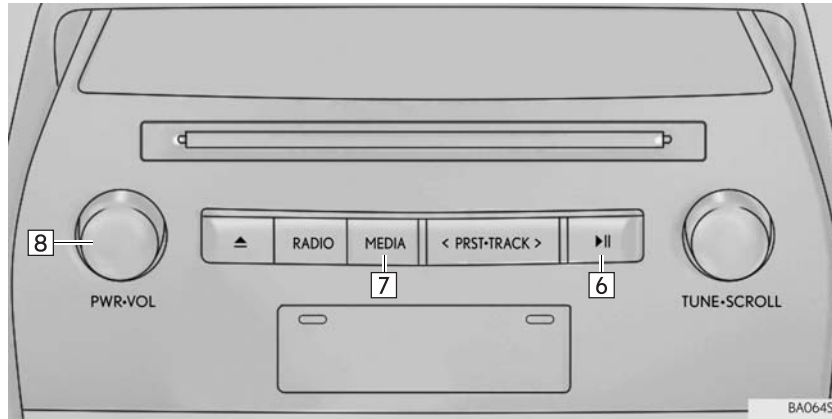

4  
AUDIO/VISUAL SYSTEM

No.	Function
1	Select to display the audio source selection screen.
2	Select to display the sound setting screen.
3	Select to display the audio setting screen.
4	Select to display the option screen. (→P.234)
5	Select to display full screen video.
6	Press to turn mute on/off.
7	<ul style="list-style-type: none"> <li>• Press to select a media mode.</li> <li>• While in a media mode, pressing the “MEDIA” button changes media modes.</li> </ul>
8	<ul style="list-style-type: none"> <li>• Turn to adjust volume.</li> <li>• Press to turn the audio system on/off.</li> <li>• Press and hold to restart the audio system.</li> </ul>

### 3. MEDIA OPERATION

#### VTR OPTIONS

1 Select "Options".

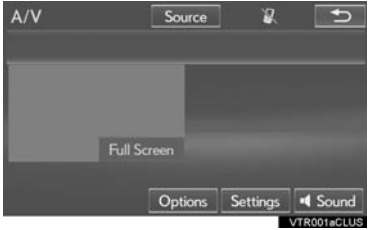

2 Select the desired settings to change.

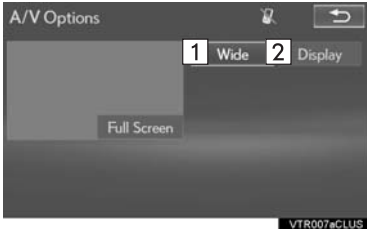

No.	Function	Page
1	Select to change the screen size.	174
2	Select to display the image quality adjustment screen.	174

## 4. AUDIO/VISUAL REMOTE CONTROLS

### 1. STEERING SWITCHES

Some parts of the audio/visual system can be adjusted using the switches on the steering wheel.

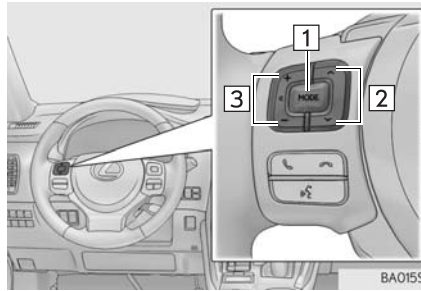

4

AUDIO/VISUAL SYSTEM

No.	Switch
1	"MODE" switch
2	"^ v" switch
3	Volume control switch

#### ► "MODE" switch

Mode	Operation	Function
AM, FM, SAT, AUX, VTR	Press	Change audio modes
	Press and hold	Mute
CD, MP3/WMA/AAC disc, DVD, USB, iPod, BT audio, APPS	Press	Change audio modes
	Press and hold	Pause

#### ► "^ v" switch

Mode	Operation	Function
AM/FM Radio	Press	Preset station up/down
	Press and hold	Seek up/down continuously while the switch is being pressed

## 4. AUDIO/VISUAL REMOTE CONTROLS

Mode	Operation	Function
SAT	Press	Preset channel up/down
	Press and hold (0.8 sec. or more)	Type seek up/down
	Press and hold (1.5 sec. or more)	Fast up/down
CD	Press	Track up/down
	Press and hold	Fast forward/rewind
MP3/WMA/AAC disc	Press	File up/down
	Press and hold	Fast forward/rewind
DVD	Press	Chapter up/down
USB	Press	File/Track up/down
	Press and hold	Fast forward/rewind
iPod	Press	Track/File up/down
BT audio	Press	Track up/down
	Press and hold	Fast forward/rewind

### ▶ Volume control switch

Mode	Operation	Function
All	Press	Volume up/down
	Press and hold	Volume up/down continuously

### **INFORMATION**

- In the APPS mode, some operation may be done on the screen depend on the selected APPS.

## 5. SETUP

### 1. AUDIO SETTINGS

Detailed audio settings can be programmed.

- 1 Press the "MENU" button on the Remote Touch.

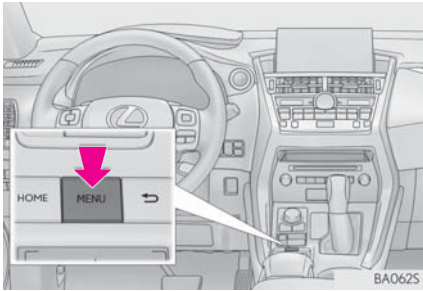

- 2 Select "Setup".



- 3 Select "Audio".

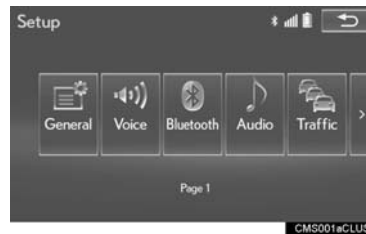

- 4 Select the items to be set.

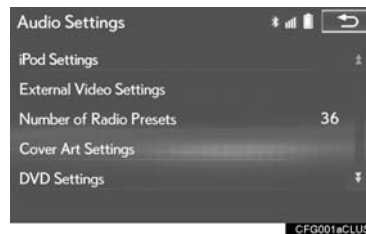

4

AUDIO/VISUAL SYSTEM

# 5. SETUP

## AUDIO SETTINGS SCREEN

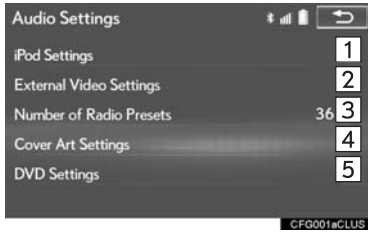

No.	Function	Page
1	Select to set the iPod audio signal input settings.	238
2	Select to set the video signal format settings.	239
3	Select to change the number of preset radio stations displayed on the screen.	239
4	Select to set detailed cover art settings.	240
5*	Select to set detailed DVD settings.	240

\*: Only in DVD video mode

## iPod SETTINGS

- 1 Display the audio setting screen. (→P.237)
- 2 Select “iPod Settings”.
- 3 Select “Video Sound Input”.



- 4 Select a screen button for the desired setting.



## EXTERNAL VIDEO SETTINGS

- 1 Display the audio setting screen. (→P.237)
- 2 Select “External Video Settings”.
- 3 Select “Video Signal Switch”.



- 4 Select a screen button for the desired setting.



## SETTING THE NUMBER OF RADIO PRESETS

- 1 Display the audio setting screen. (→P.237)
- 2 Select “Number of Radio Presets”.
- 3 Select the button with the desired number to be displayed.

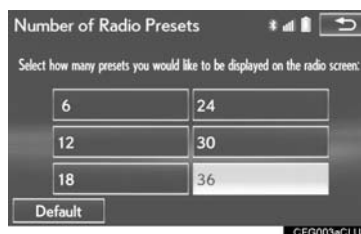

- “Default”: Select to default the settings.

4

AUDIO/VISUAL SYSTEM

## COVER ART SETTINGS

- 1 Display the audio setting screen. (→P.237)
- 2 Select “Cover Art Settings”.
- 3 Select the desired button to be set.

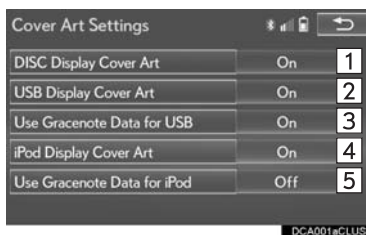

No.	Function
1	Select on/off to set the cover art display in DISC mode.
2	Select on/off to set the cover art display in USB mode.
3	Select on/off to set the priority of the Gracenote database in USB mode.
4	Select on/off to set the cover art display in iPod mode.
5	Select on/off to set the priority of the Gracenote database in iPod mode.

## INFORMATION

- Images from the Gracenote database displayed on the screen may be different from the actual cover art.

## DVD SETTINGS

- 1 Display the audio setting screen. (→P.237)
- 2 Select “DVD Settings”.
- 3 Select the items to be set.

- Selecting “DVD Settings” on the DVD top screen can also display “DVD Settings” screen. (→P.204)

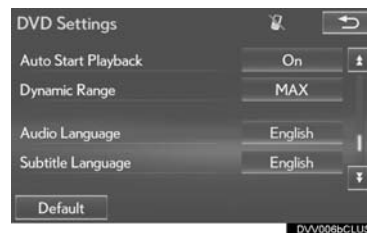

- When “Default” is selected, all menus are initialized.



### ■ AUDIO LANGUAGE

The audio language can be changed.

- 1 Select **"Audio Language"**.
- 2 Select the desired language to be heard on the "Audio Language" screen.
  - If the desired language to be heard cannot be found on this screen, select **"Other"** and enter a language code. (→P.242)

### ■ SUBTITLE LANGUAGE

The subtitle language can be changed.

- 1 Select **"Subtitle Language"**.
- 2 Select the desired language to be read on the "Subtitle Language" screen.
  - If the desired language to be read cannot be found on this screen, select **"Other"** and enter a language code. (→P.242)

### ■ MENU LANGUAGE

The language on the DVD video menu can be changed.

- 1 Select **"Menu Language"**.
- 2 Select the desired language to be read on the "Menu Language" screen.
  - If the desired language to be read cannot be found on this screen, select **"Other"** and enter a language code. (→P.242)

### ■ ANGLE MARK

The multi-angle mark can be turned on or off on the screen while discs that are multi-angle compatible are being played.

- 1 Select **"Angle Mark"**.
- 2 Select **"On"** or **"Off"**.

### ■ PARENTAL LOCK

The level of viewer restrictions can be changed.

- 1 Select **"Parental Lock"**.
- 2 Enter the 4-digit personal code on the "Key Code" screen.
- 3 Select a parental level (1-8) on the "Select Restriction Level" screen.

### ■ AUTO START

Discs that are inserted while the vehicle is in motion will automatically start playing. Certain discs may not play.

- 1 Select **"Auto Start Playback"**.
- 2 Select **"On"** or **"Off"**.

### ■ SOUND DYNAMIC RANGE

The difference between the lowest volume and the highest volume can be adjusted.

- 1 Select **"Dynamic Range"**.
- 2 Select **"MAX"**, **"STD"** or **"MIN"**.

■ ENTER AUDIO/SUBTITLE/MENU LANGUAGE CODE

If “Other” on the “Audio Language” screen, “Subtitle Language” screen or “Menu Language” screen is selected, the desired language to be heard or read can be selected by entering a language code.

- 1 Enter the 4-digit language code.



- 2 Select “OK”.

## LANGUAGE CODES LIST

Code	Language	Code	Language	Code	Language	Code	Language
0514	English	0426	Bhutani	1125	Kirghiz	1909	Sinhalese
1001	Japanese	0515	Esperanto	1201	Latin	1911	Slovak
0618	French	0520	Estonian	1214	Lingala	1912	Slovenian
0405	German	0521	Basque	1215	Laotian	1913	Samoan
0920	Italian	0601	Persian	1220	Lithuanian	1914	Shona
0519	Spanish	0609	Finnish	1222	Latvian, Lettish	1915	Somali
2608	Chinese	0610	Fiji	1307	Malagasy	1917	Albanian
1412	Dutch	0615	Faroese	1309	Maori	1918	Serbian
1620	Portuguese	0625	Frisian	1311	Macedonian	1919	Siswati
1922	Swedish	0701	Irish	1312	Malayalam	1920	Sesotho
1821	Russian	0704	Scottish-Gaelic	1314	Mongolian	1921	Sundanese
1115	Korean	0712	Galician	1315	Moldavian	1923	Swahili
0512	Greek	0714	Guarani	1318	Marathi	2001	Tamil
0101	Afar	0721	Gujarati	1319	Malay	2005	Telugu
0102	Abkhazian	0801	Hausa	1320	Maltese	2007	Tajik
0106	Afrikaans	0809	Hindi	1325	Burmese	2008	Thai
0113	Amharic	0818	Croatian	1401	Nauru	2009	Tigrinya
0118	Arabic	0821	Hungarian	1405	Nepali	2011	Turkmen
0119	Assamese	0825	Armenian	1415	Norwegian	2012	Tagalog
0125	Aymara	0901	Interlingua	1503	Occitan	2014	Setswana
0126	Azerbaijani	0905	Interlingue	1513	(Afan) Oromo	2015	Tongan
0201	Bashkir	0911	Inupiak	1518	Oriya	2018	Turkish
0205	Byelorussian	0914	Indonesian	1601	Punjabi	2019	Tsonga
0207	Bulgarian	0919	Icelandic	1612	Polish	2020	Tatar
0208	Bihari	0923	Hebrew	1619	Pashto, Pushto	2023	Twi
0209	Bislama	1009	Yiddish	1721	Quechua	2111	Ukrainian
0214	Bengali, Bangla	1023	Javanese	1813	Rhaeto-Romance	2118	Urdu
0215	Tibetan	1101	Georgian	1814	Kirundi	2126	Uzbek
0218	Breton	1111	Kazakh	1815	Romanian	2209	Vietnamese
0301	Catalan	1112	Greenlandic	1823	Kinyarwanda	2215	Volapük
0315	Corsican	1113	Cambodian	1901	Sanskrit	2315	Wolof
0319	Czech	1114	Kannada	1904	Sindhi	2408	Xhosa
0325	Welsh	1119	Kashmiri	1907	Sango	2515	Yoruba
0401	Danish	1121	Kurdish	1908	Serbo-Croatian	2621	Zulu

4

AUDIO/VISUAL SYSTEM

## 6. TIPS FOR OPERATING THE AUDIO/VISUAL SYSTEM

### 1. OPERATING INFORMATION

#### NOTICE

- To avoid damage to the audio/visual system:
  - Be careful not to spill beverages over the audio/visual system.
  - Do not put anything other than an appropriate disc into the disc slot.

#### INFORMATION

- The use of a cellular phone inside or near the vehicle may cause a noise from the speakers of the audio/visual system which you are listening to. However, this does not indicate a malfunction.

#### RADIO

Usually, a problem with radio reception does not mean there is a problem with the radio – it is just the normal result of conditions outside the vehicle.

For example, nearby buildings and terrain can interfere with FM reception. Power lines or phone wires can interfere with AM signals. And of course, radio signals have a limited range. The farther the vehicle is from a station, the weaker its signal will be. In addition, reception conditions change constantly as the vehicle moves.

Here, some common reception problems that probably do not indicate a problem with the radio are described.

**FM**

**Fading and drifting stations:** Generally, the effective range of FM is about 25 miles (40 km). Once outside this range, you may notice fading and drifting, which increase with the distance from the radio transmitter. They are often accompanied by distortion.

**Multi-path:** FM signals are reflective, making it possible for 2 signals to reach the vehicle's antenna at the same time. If this happens, the signals will cancel each other out, causing a momentary flutter or loss of reception.

**Static and fluttering:** These occur when signals are blocked by buildings, trees or other large objects. Increasing the bass level may reduce static and fluttering.

**Station swapping:** If the FM signal being listened to is interrupted or weakened, and there is another strong station nearby on the FM band, the radio may tune in the second station until the original signal can be picked up again.

**AM**

**Fading:** AM broadcasts are reflected by the upper atmosphere – especially at night. These reflected signals can interfere with those received directly from the radio station, causing the radio station to sound alternately strong and weak.

**Station interference:** When a reflected signal and a signal received directly from a radio station are very nearly the same frequency, they can interfere with each other, making it difficult to hear the broadcast.

**Static:** AM is easily affected by external sources of electrical noise, such as high tension power lines, lightening or electrical motors. This results in static.

## 6. TIPS FOR OPERATING THE AUDIO/VISUAL SYSTEM

### XM

- Cargo loaded on the roof luggage carrier, especially metal objects, may adversely affect the reception of XM Satellite Radio.
- Alternation or modifications carried out without appropriate authorization may invalidate the user's right to operate the equipment.

### DVD PLAYER AND DISC

- This DVD player is intended for use with 4.7 in. (12 cm). discs only.
- Extremely high temperatures can keep the DVD player from working. On hot days, use the air conditioning system to cool the inside of the vehicle before using the player.
- Bumpy roads or other vibrations may make the DVD player skip.
- If moisture gets into the DVD player, the discs may not be able to be played. Remove the discs from the player and wait until it dries.

**⚠ WARNING**

- DVD players use an invisible laser beam which could cause hazardous radiation exposure if directed outside the unit. Be sure to operate the player correctly.

### DVD PLAYER

Audio CDs	 
	 
DVD video discs	 
DVD-R/RW discs	 

- Use only discs marked as shown above. The following products may not be playable on your player:
  - SACD
  - dts CD
  - Copy-protected CD
  - DVD audio
  - Video CD
  - DVD-RAM

► Special shaped discs

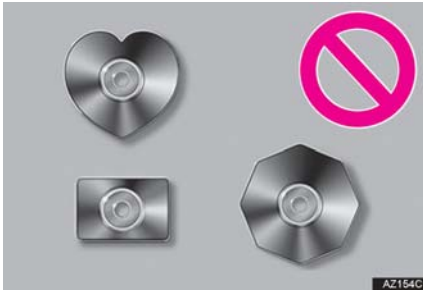

► Labeled discs



► Transparent/translucent discs

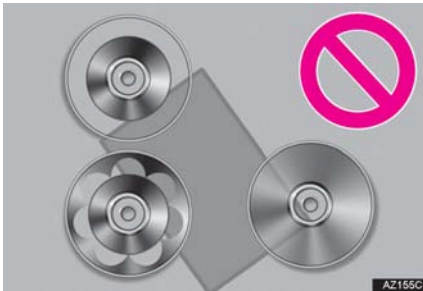

► Low quality discs

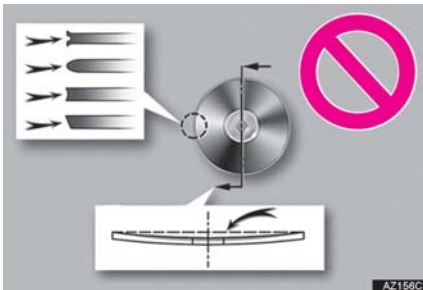

 NOTICE

- Do not use special shaped, transparent/translucent, low quality or labeled discs such as those shown in the illustrations. The use of such discs may damage the player, or it may be impossible to eject the disc.
- This system is not designed for use of Dual Discs. Do not use Dual Discs because they may cause damage to the player.
- Do not use discs with a protection ring. The use of such discs may damage the player, or it may be impossible to eject the disc.
- Do not use printable discs. The use of such discs may damage the player, or it may be impossible to eject the disc.

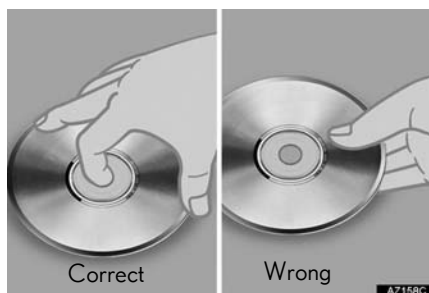

- Handle discs carefully, especially when inserting them. Hold them on the edge and do not bend them. Avoid getting fingerprints on them, particularly on the shiny side.
- Dirt, scratches, warping, pin holes or other disc damage could cause the player to skip or to repeat a section of a track. (To see a pin hole, hold the disc up to the light.)
- Remove discs from the players when not in use. Store them in their plastic cases away from moisture, heat and direct sunlight.

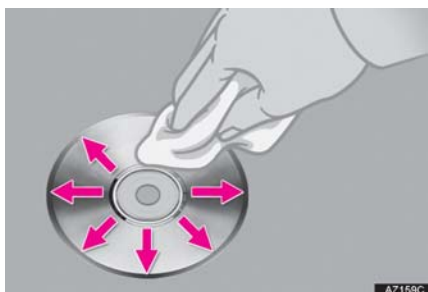

**To clean a disc:** Wipe it with a soft, lint-free cloth that has been dampened with water. Wipe in a straight line from the center to the edge (not in circles). Dry it with another soft, lint-free cloth. Do not use a conventional record cleaner or anti-static device.

### CD-R/RW AND DVD-R/RW DISCS

- CD-R/CD-RW discs that have not been subject to the “finalizing process” (a process that allows discs to be played on a conventional CD player) cannot be played.
- It may not be possible to play CD-R/CD-RW discs recorded on a music CD recorder or a personal computer because of disc characteristics, scratches or dirt on the disc, or dirt, condensation, etc. on the lens of the unit.
- It may not be possible to play discs recorded on a personal computer depending on the application settings and the environment. Record with the correct format. (For details, contact the appropriate application manufacturers of the applications.)
- CD-R/CD-RW discs may be damaged by direct exposure to sunlight, high temperatures or other storage conditions. The unit may be unable to play some damaged discs.
- If you insert a CD-RW disc into the player, playback will begin more slowly than with a conventional CD or CD-R disc.
- Recordings on CD-R/CD-RW cannot be played using the DDCCD (Double Density CD) system.







**DVD VIDEO DISCS**

This DVD player conforms to NTSC/PAL color TV formats. DVD video discs conforming to another format such as SECAM cannot be used.

**Region codes:** Some DVD video discs have the following region code indicating which countries the DVD video disc can be played in on this DVD player. If you attempt to play an inappropriate DVD video disc on this player, error message appears on the screen. Even if the DVD video disc does not have a region code, there are cases when it cannot be used.

Code	Country
All	All countries
1	North America

**MARKS SHOWN ON DVD VIDEO DISCS**

NTSC/PAL	Indicates NTSC/PAL format of color TV.
	Indicates the number of audio tracks.
	Indicates the number of language subtitles.
	Indicates the number of angles.
	Indicates the screen to be selected. Wide screen: 16:9 Standard: 4:3
	Indicates a region code by which this video disc can be played. ALL: in all countries Number: region code

4

AUDIO/VISUAL SYSTEM

## DVD VIDEO DISC GLOSSARY

**DVD video discs:** Digital Versatile Disc that holds video. DVD video discs have adopted "MPEG2", one of the world standards of digital compression technologies. The picture data is compressed by 1/40 on average and stored. Variable rate encoded technology in which the volume of data assigned to the picture is changed depending on the picture format has also been adopted. Audio data is stored using PCM and Dolby Digital, which enables higher quality of sound. Furthermore, multi-angle and multi-language features will also help users enjoy the more advanced technology of DVD video.

**Viewer restrictions:** This feature limits what can be viewed in conformity with a level of restrictions of the country. The level of restrictions varies depending on the DVD video disc. Some DVD video discs cannot be played at all, or violent scenes are skipped or replaced with other scenes.

- Level 1: DVD video discs for children can be played.
- Level 2 - 7: DVD video discs for children and G-rated movie can be played.
- Level 8: All types of the DVD video discs can be played.

**Multi-angle feature:** The same scene can be enjoyed from different angles.

**Multi-language feature:** The subtitle and audio language can be selected.

**Region codes:** The region codes are provided on DVD players and DVD discs. If the DVD video disc does not have the same region code as the DVD player, you cannot play the disc on the DVD player. For region codes: (→P.249)

**Audio:** This DVD player can play linear PCM, Dolby Digital and MPEG audio format DVDs. Other decoded types cannot be played.

**Title and chapter:** Video and audio programs stored in DVD video discs are divided into parts by title and chapter.

**Title:** The largest unit of the video and audio programs stored on DVD video discs. Usually, one movie, one album, or one audio program is assigned as a title.

**Chapter:** A unit smaller than that of title. A title comprises of several chapters.

- Manufactured under license from Dolby Laboratories. Dolby and the double-D symbol are trademarks of Dolby Laboratories.

## iPod



- “Made for iPod”, “Made for iPhone” and “Made for iPad” mean that an electronic accessory has been designed to connect specifically to iPod, iPhone, or iPad, respectively, and has been certified by the developer to meet Apple performance standards.
- Apple is not responsible for the operation of this device or its compliance with safety and regulatory standards. Please note that the use of this accessory with iPod, iPhone, or iPad may affect wireless performance.
- iPad, iPhone, iPod, iPod classic, iPod nano, and iPod touch are trademarks of Apple Inc., registered in the U.S. and other countries. Lightning is a trademark of Apple Inc.
- The Lightning connector works with iPhone 5, iPod touch (5th generation), and iPod nano (7th generation).
- The 30-pin connector works with iPhone 4S, iPhone 4, iPhone 3GS, iPhone 3G, iPhone, iPod touch (1st through 4th generation), iPod classic, and iPod nano (1st through 6th generation).
- USB works with iPhone 5, iPhone 4S, iPhone 4, iPhone 3GS, iPhone 3G, iPhone, iPod touch (1st through 5th generation), iPod classic, and iPod nano (1st through 7th generation).
- Bluetooth® technology works with iPhone 5, iPhone 4S, iPhone 4, iPhone 3GS, iPhone 3G, iPhone, and iPod touch (2nd through 5th generation).

## COMPATIBLE MODELS

The following iPod®, iPod nano®, iPod classic®, iPod touch® and iPhone® devices can be used with this system.

Made for

- iPod touch (5th generation)\*
- iPod touch (4th generation)
- iPod touch (3rd generation)
- iPod touch (2nd generation)
- iPod touch (1st generation)
- iPod classic
- iPod with video
- iPod nano (7th generation)\*
- iPod nano (6th generation)
- iPod nano (5th generation)
- iPod nano (4th generation)
- iPod nano (3rd generation)
- iPod nano (2nd generation)
- iPod nano (1st generation)
- iPhone 5\*
- iPhone 4S
- iPhone 4
- iPhone 3GS
- iPhone 3G
- iPhone

\*: iPod video not supported

## INFORMATION

- Depending on differences between models or software versions etc., some models might be incompatible with this system.

## 6. TIPS FOR OPERATING THE AUDIO/VISUAL SYSTEM

### FILE INFORMATION

#### COMPATIBLE USB DEVICES

USB communication formats	USB 2.0 HS (480 Mbps) and FS (12 Mbps)
File formats	FAT16/32
Correspondence class	Mass storage class

#### COMPATIBLE COMPRESSED FILES

Item	USB	DISC
Compatible file format (audio)	MP3/WMA/AAC	
Folders in the device	Maximum 3000	Maximum 192
Files in the device	Maximum 9999	Maximum 255
Files per folder	Maximum 255	—

#### CORRESPONDING SAMPLING FREQUENCY

File type	Frequency (kHz)
MP3 files: MPEG1 LAYER 3	32/44.1/48
MP3 files: MPEG2 LSF LAYER 3	16/22.05/24
WMA files: Ver. 7, 8, 9*1 (9.1/9.2)	32/44.1/48
AAC files: MPEG4/AAC-LC	11.025/12/16/22.05/24/32/44.1/48

\*1: Only compatible with Windows Media Audio Standard

#### CORRESPONDING BIT RATES\*2

File type	Bit rate (kbps)
MP3 files: MPEG1 LAYER 3	32 - 320
MP3 files: MPEG2 LSF LAYER 3	8 - 160
WMA files: Ver. 7, 8	CBR 48 - 192
WMA files: Ver. 9*1 (9.1/9.2)	CBR 48 - 320
AAC files: MPEG4/AAC-LC	16 - 320

\*1: Only compatible with Windows Media Audio Standard

\*2: Variable Bit Rate (VBR) compatible

### COMPATIBLE CHANNEL MODES

File type	Channel mode
MP3 files	Stereo, joint stereo, dual channel and monaural
WMA files	2ch
AAC files	1ch, 2ch (Dual channel is not supported)

- MP3 (MPEG Audio Layer 3), WMA (Windows Media Audio) and AAC (Advanced Audio Coding) are audio compression standards.
- This system can play MP3/WMA/AAC files on CD-R, CD-RW, DVD-R, DVD-RW discs and USB memory.
- This system can play disc recordings compatible with ISO 9660 level 1 and level 2 and with the Romeo and Joliet file system and UDF (2.01 or lower).
- When naming an MP3/WMA/AAC file, add an appropriate file extension (.mp3/.wma/.m4a).
- This system plays back files with .mp3/.wma/.m4a file extensions as MP3/WMA/AAC files respectively. To prevent noise and playback errors, use the appropriate file extension.
- This system can play only the first session/border when using multi session/border compatible discs.
- MP3 files are compatible with the ID3 Tag Ver. 1.0, Ver. 1.1, Ver. 2.2 and Ver. 2.3 formats. This system cannot display disc title, track title and artist name in other formats.
- WMA/AAC files can contain a WMA/AAC tag that is used in the same way as an ID3 tag. WMA/AAC tags carry information such as track title and artist name.
- The emphasis function is available only when playing MP3 files.
- This system can play back AAC files encoded by iTunes.
- The sound quality of MP3/WMA files generally improves with higher bit rates. In order to achieve a reasonable level of sound quality, discs recorded with a bit rate of at least 128 kbps are recommended.
- MP3i (MP3 interactive) and MP3PRO formats are not compatible with the audio player.
- The player is compatible with VBR (Variable Bit Rate).
- When playing back files recorded as VBR (Variable Bit Rate) files, the play time will not be correctly displayed if the fast forward or reverse operations are used.
- It is not possible to check folders that do not include MP3/WMA/AAC files.
- MP3/WMA/AAC files in folders up to 8 levels deep can be played. However, the start of playback may be delayed when using discs containing numerous levels of folders. For this reason, we recommend creating discs with no more than 2 levels of folders.

4

AUDIO/VISUAL SYSTEM

## 6. TIPS FOR OPERATING THE AUDIO/VISUAL SYSTEM

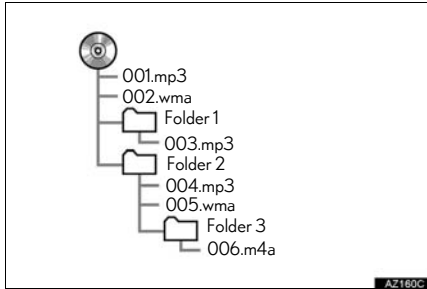

- The play order of the compact disc with the structure shown above is as follows:

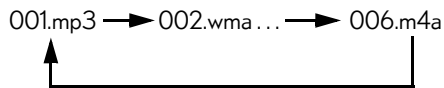

- The order changes depending on the personal computer and MP3/WMA/AAC encoding software you use.

### TERMS

#### PACKET WRITE

- This is a general term that describes the process of writing data on-demand to CD-R, etc., in the same way that data is written to floppy or hard discs.

#### ID3TAG

- This is a method of embedding track-related information in an MP3 file. This embedded information can include the track number, track title, the artist's name, the album title, the music genre, the year of production, comments, cover art and other data. The contents can be freely edited using software with ID3 tag editing functions. Although the tags are restricted to a number of characters, the information can be viewed when the track is played back.

#### WMA TAG

- WMA files can contain a WMA tag that is used in the same way as an ID3 tag. WMA tags carry information such as track title and artist name.

### ISO 9660 FORMAT

- This is the international standard for the formatting of CD-ROM folders and files. For the ISO 9660 format, there are 2 levels of regulations.
- Level 1: The file name is in 8.3 format (8 character file names, with a 3 character file extension. File names must be composed of one-byte capital letters and numbers. The “\_” symbol may also be included.)
- Level 2: The file name can have up to 31 characters (including the separation mark “.” and file extension). Each folder must contain fewer than 8 hierarchies.

### MP3

- MP3 is an audio compression standard determined by a working group (MPEG) of the ISO (International Standard Organization). MP3 compresses audio data to about 1/10 the size of that on conventional discs.

### WMA

- WMA (Windows Media Audio) is an audio compression format developed by Microsoft®. It compresses files into a size smaller than that of MP3 files. The decoding formats for WMA files are Ver. 7, 8 and 9.

### AAC

- AAC is short for Advanced Audio Coding and refers to an audio compression technology standard used with MPEG2 and MPEG4.

## 6. TIPS FOR OPERATING THE AUDIO/VISUAL SYSTEM

### ERROR MESSAGES

Mode	Message	Explanation
CD/DVD	"No disc found."	It indicates that there is no disc in the DVD player.
	"Check disc"	It indicates that the disc is dirty, damaged, or it was inserted upside down. Clean the disc or insert it correctly. It indicates a disc which is not playable is inserted.
	"DISC Error"	There is a trouble inside the system. Eject the disc.
	"Region Code Error"	It indicates that the DVD region code is not set properly.
USB	"USB Error"	This indicates a problem in the USB memory or its connection.
	"No music files found."	This indicates that no MP3/WMA/AAC files are included in the USB memory.
iPod	"iPod Error."	This indicates a problem in the iPod or its connection.
	"No music files found."	This indicates that there is no music data in the iPod.
	"No video files found."	This indicates that no video files are included in the iPod.
	"Please check the iPod firmware version."	This indicates that the software version is not compatible. Perform the iPod firmware updates and try again.
	"iPod authorization failed."	This indicates that it failed to authorize the iPod. Please check your iPod.
Bluetooth® Audio	"Music tracks not supported. Please check your portable player."	This indicates a problem in the Bluetooth® device.

#### INFORMATION

- If the malfunction is not rectified: Take your vehicle to your Lexus dealer.



# 5

## VOICE COMMAND SYSTEM

### 1 VOICE COMMAND SYSTEM OPERATION

- 1. VOICE COMMAND SYSTEM ..... 258
  - USING THE VOICE COMMAND SYSTEM..... 258
  - VOICE COMMAND SYSTEM OPERATION ..... 259
  - EXPANDED VOICE COMMANDS ..... 265
- 2. CASUAL SPEECH RECOGNITION..... 266
- 3. COMMAND LIST ..... 267

### 2 MOBILE ASSISTANT OPERATION

- 1. MOBILE ASSISTANT ..... 271

1

2

3

4

5

6

7

8

9

## 1. VOICE COMMAND SYSTEM OPERATION

### 1. VOICE COMMAND SYSTEM

The voice command system enables the navigation, audio/visual, hands-free and air conditioning systems to be operated using voice commands.

Refer to the command list for samples of voice commands. (→P.267)

#### USING THE VOICE COMMAND SYSTEM

##### STEERING SWITCH

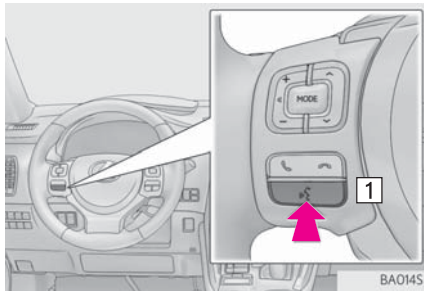

##### 1 Talk switch

- Press the talk switch to start the voice command system.
- To cancel voice recognition, press and hold the talk switch.

##### MICROPHONE

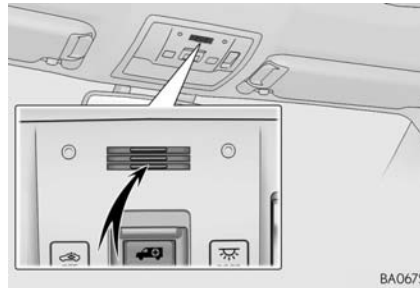

- It is unnecessary to speak directly into the microphone when giving a command.

##### INFORMATION

- Wait for the confirmation beep before speaking a command.
- Voice commands may not be recognized if:
  - Spoken too quickly.
  - Spoken at a low or high volume.
  - The roof or windows are open.
  - Passengers are talking while voice commands are spoken.
  - The air conditioning speed is set high.
  - The air conditioning vents are turned towards the microphone.
- In the following conditions, the system may not recognize the command properly and using voice commands may not be possible:
  - The command is incorrect or unclear. Note that certain words, accents or speech patterns may be difficult for the system to recognize.
  - There is excessive background noise, such as wind noise.

## VOICE COMMAND SYSTEM OPERATION

The voice command system is operated by speaking commands corresponding to each function. Also you can confirm the each command by selecting a tab. The tabs are found on the upper part of the screen.

All commands that are not displayed on the screen can be recognized on any screens.

### 1 Press the talk switch.

- Voice guidance for the voice command system can be skipped by pressing the talk switch.

### 2 Say the tab selection command or select the desired tab.



- Commands related with each function are displayed on the screen of the each function tab. Some commonly used commands are displayed on the screen of the shortcut tab. Say **"More Hints"** to display more commonly used commands.

- Saying **"Help"** prompts voice guidance to offer examples of commands and operation methods.

### 3 Say the desired command.



- Registered POIs, registered names in the contacts list etc., can be said in the place of the "<>" next to the commands. (→P.267)  
For example: Say **"Find nearby dining"**, **"Call John Smith"** etc.
- If a desired outcome is not shown, or if no selections are available, perform one of the following to return to the previous screen:
  - Say **"Go back"**.
  - Select **"Go Back"**.
- To cancel voice recognition, select , or press and hold the talk switch.

5

VOICE COMMAND SYSTEM

**INFORMATION**

- If the navigation system does not respond or the confirmation screen does not disappear, press the talk switch and try again.
- If a voice command cannot be recognized, voice guidance will say "Pardon?" ("Command not recognized." will be displayed on the screen) and voice command reception will restart.
- If a voice command cannot be recognized 2 consecutive times, the voice command guidance system will say "Paused. To restart voice recognition, please push the talk switch. To cancel voice recognition, please push and hold the talk switch." Then voice recognition will be suspended.
- "Voice Recognition Prompts" can be set to on or off on the "Voice Settings" screen. (→P.74)
- Voice guidance can be canceled by setting voice prompts to off. Use this setting when it is desirable to say a command immediately after pressing the talk switch and hearing a beep.

**■ DISPLAYING THE "Voice Settings" SCREENS**



- Selecting  can be displayed the "Voice Settings" screen. (→P.73)

**VOICE COMMAND  
EXAMPLE: LAUNCH LEXUS  
App Suite APPLICATION**

- 1 Press the talk switch.
- 2 Say "Launch <application name>".



- LEXUS App Suite application screen is displayed.

**VOICE COMMAND  
EXAMPLE: PERFORMING A  
DESTINATION SEARCH BY  
ADDRESS (ENGLISH ONLY)**

- 1 Press the talk switch.
- 2 Say "Enter an address".
- 3 Say "<house number, street name, city name, State>" continuously.

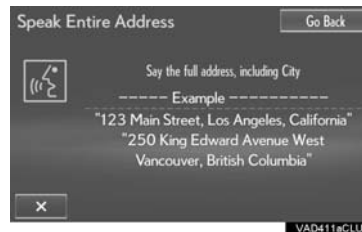

- A confirmation screen will be displayed showing the recognition results. If multiple matching items are found, a selection screen will be displayed. Say "<number>" or select the number.
- Some areas cannot be recognized by the voice recognition system.

- For information regarding the state/province setting to perform a destination search by address: →P.108

5

VOICE COMMAND SYSTEM

#### 4 Say "Go directly".



- After this, follow the voice guidance and search for a destination route by voice command operation.

#### INFORMATION

- The voice command recognition is designed to recognize the main body of the official street name.

For example: if the official street name is "East Main Street", the voice command recognition will recognize "Main".

- Say the desired number, cardinal direction etc. in the place of the "<>".

For example: Say "**West 555**".

- Inputting the house number can be skipped.
- Even if the state set using voice recognition is different from the set state in the "Address" screen (which was set when a destination was set manually), the set state in the "Address" screen will not change. (→P.110)

- The house number voice recognition conditions are outlined below:
  - Numerals: 10 digits or less
  - Numerals and cardinal direction or a hyphen and numerals: A total of 9 digits or less (Do not say "**and**".)
  - Cardinal direction or a hyphen and numerals: A total of 9 digits or less (Do not say "**and**".)
  - Numerals are recognized as single digits only.
  - The cardinal direction and hyphens are only recognized once.
  - The following cardinal directions can be recognized: North, East, West and South.

### VOICE COMMAND EXAMPLE: SEARCH FOR A SONG

- 1 Press the talk switch.
  - 2 Say "Play song <name>".
- A confirmation screen will be displayed showing the recognition results. If multiple matching items are found, a selection screen will be displayed. Say "<number>" or select the number.
  - The system starts playing music and the song lists are displayed.

#### INFORMATION

- The Gracenote database is only compatible with the USB or iPod mode.
- The list screens can be operated by selecting using the Remote Touch as well as by recognizing the voice commands.
- A USB memory or iPod must be connected to enable track searching and playback. (→P.211, 216)
- When a USB memory or iPod is connected, recognition data is created so tracks can be searched using voice commands.
- Recognition data is updated under the following conditions:
  - When the USB memory or iPod data has changed.
  - When the voice recognition language is changed. (→P.66)
- While the recognition data is being created or being updated, a track search cannot be performed using a voice command.
- When the "Music" tab is disappeared on the shortcut menu screen, it is not possible to search for a track using a voice command.

5

VOICE COMMAND SYSTEM

**VOICE COMMAND  
EXAMPLE: CALL NAME**



- 1 Press the talk switch.
  - 2 Say "Call <contacts> <phone types>".
- A confirmation screen will be displayed showing the recognition results. If multiple matching items are found, a selection screen will be displayed. Say "<number>" or select the number.

**INFORMATION**

- In the same manner as it is displayed on the screen, "Call <contacts> <phone types>", after saying "Call a contact" say the name, or the name and type of phone, of a contact.  
For example: "Call a contact", "John Smith" or "Call a contact", "Mary Davis", "Mobile"
- There are 4 types of phones: Home, Mobile, Office and Other.
- Short or abbreviated names in the contacts list may not be recognized. Change names in the contacts list to full names.
- Sometimes a voice recognition result confirmation screen will be displayed. After confirming the result, say "Yes" or "No".
- When the system recognizes multiple names from the contacts list, a name candidate list will be displayed on the screen. If the desired name is not displayed on the top of the screen, say or select the number of the name from the candidate list to select a name from the candidate list.
- When a contact has multiple phone numbers registered in the contacts list, a candidate list will be displayed. If the desired phone number is not displayed on the top of the screen, say or select the number of the desired phone number from the candidate list to select a phone number from the candidate list.



### VOICE COMMAND EXAMPLE: DIAL NUMBER

- 1 Press the talk switch.
  - 2 Say the phone number.
    - In the same manner as it is displayed on the screen, "Dial <number>", after saying "*Dial a number*" say the phone number.
    - Say the phone number one digit at a time. For example, if the phone number is 2345678:  
Say "*two three four five six seven eight*"
  - 3 Say "*Call*" or press the  switch on the steering wheel.
    - When the confirmation screen appears, say "*Yes*" or select "*Yes*" or press the  switch on the steering wheel.
- When the system recognizes multiple phone numbers, a phone number candidate list will be displayed on the screen. Pressing the  switch on the steering wheel makes a call to the top entry on the list. If the desired phone number is not displayed on the top of the screen, say the number of the desired phone number from the candidate list to select a phone number from the candidate list.

### EXPANDED VOICE COMMANDS

Selecting "On" next to "Expanded Voice Commands" on the "Voice Settings" screen enables expanded voice commands operation. (→P.73)  
Expanded voice commands are displayed on the screen of the "Other" tab. Expanded voice commands are listed in the table (→P.267)

#### INFORMATION

- The "Other" tab is not displayed when "Expanded Voice Commands" is "Off".

5

VOICE COMMAND SYSTEM

## 1. VOICE COMMAND SYSTEM OPERATION

## 2. CASUAL SPEECH RECOGNITION

Due to natural language speech recognition technology, this system enables recognition of a command when spoken naturally. However, the system cannot recognize every variation of each command. In some situations, it is possible to omit the command for the procedure and directly state the desired operation. Not all voice commands are displayed in the short cut menu.

### INFORMATION

- If the command cannot be recognized completely, the command input screen will be displayed. (Search results will be shown based on the part of the command that was recognized.)

### EXPRESSION EXAMPLES FOR EACH FUNCTION

Command	Expression examples
"Go Home"	<i>Navigate to my house. Take me home.</i>
"Enter an Address"	<i>I need a route to a street address. Give me a street.</i>
"Find <POI category>"	<i>Search for a &lt;Restaurants&gt; around here. I need a route to a nearby &lt;Restaurants&gt;.</i>
"Call <name> <type>"	<i>Get me &lt;Robert Brown&gt;. Contact the &lt;Robert Brown&gt; phone of &lt;Work&gt;.</i>
"Dial <number>"	<i>Can you get me &lt;3334445555&gt;. Ring &lt;3334445555&gt;.</i>
"Play Artist <name>"	<i>Play the artist &lt;name&gt;. I want to hear the band &lt;name&gt;.</i>
"Play Album <name>"	<i>Switch to the album &lt;name&gt;.</i>

## 1. VOICE COMMAND SYSTEM OPERATION

### 3. COMMAND LIST

Recognizable voice commands and their actions are shown below.

- Frequently used commands are listed in the following tables.
  - For devices that are not installed in the vehicle, the related commands will not be displayed in the screen. Also, according to conditions, other commands may not be displayed in the screen.
  - The functions available may vary according to the navigation system installed.
- Voice recognition language can be changed. (→P.66)

#### ▶ Basic

Command	Action
"Help"	Prompts voice guidance to offer examples of commands or operation methods
"Go Back"	Returns to the previous screen
"Go to <tab>"	Displays the command list of the selected tab
"More Hints"	Displays more commonly used commands
"Cancel"	Cancels the voice command system

#### ▶ Apps

When the voice recognition language is set to English.

Command	Action
"Launch <apps>"	Activates the LEXUS App Suite application

5

VOICE COMMAND SYSTEM

## 1. VOICE COMMAND SYSTEM OPERATION

### ► Navi

Command	Action
"Find <POI category>"	Displays a list of <POI category* <sup>1</sup> > near the current position* <sup>2</sup>
"Enter an Address"	Enables setting a destination by saying the address
"Go Home"	Displays the route to home
"Pause Guidance"	Stops the route guidance
"Resume Guidance"	Resumes the route guidance
"Show <POI> icons"	Displays the specified POI icons
"Delete Destination"	Deletes the destination
"Previous Destination"	Displays previous destinations

\*<sup>1</sup>: For example; "Gas stations", "Restaurants", etc.

\*<sup>2</sup>: Depending on the search results, a POI list may be provided by a relevant POI application of the LEXUS App suite. (→P.353)

### ► Phone

Command	Action
"Redial"	Places a call to the phone number of the latest outgoing call
"Call Back"	Places a call to the phone number of latest incoming call
"Show Recent Calls"	Displays the call history screen
"Dial <phone number>"	Places a call to the said phone number
"Call <contacts> <phonetypes>"	Place a call to the said phone type of the contact from the phone book

## 1. VOICE COMMAND SYSTEM OPERATION

### ▶ Radio

Command	Action
"Tune to <frequency> AM"	Changes the radio to the specified AM frequency
"Tune to <frequency> FM"	Changes the radio to the specified FM frequency
"Play <genre> station"	Changes the radio to an FM station of the specified genre
"Tune to FM <frequency> HD <number>"	Changes the radio to the specified HD radio station
"Tune to preset <number>"	Changes the radio to the specified preset radio station
"Tune to <name>"	Changes the radio to the satellite radio channel with the specified name
"Tune to channel <number>"	Changes the radio to the specified satellite radio channel number
"Play <genre> satellite station"	Changes the radio to a satellite radio channel of the specified genre

5

VOICE COMMAND SYSTEM

### ▶ Audio

Command	Action
"Play Playlist <name>"	Plays tracks from the selected playlist
"Play Artist <name>"	Plays tracks from the selected artist
"Play Song <name>"	Plays the selected track
"Play Album <name>"	Plays tracks from the selected album

### ▶ Info

Command	Action
"Destination Assist"	Connects the system to the Lexus response center
"Show Forecast"	Displays weather information
"Show Traffic"	Displays traffic information
"Lexus Insider"	Displays the Lexus insider list

## 1. VOICE COMMAND SYSTEM OPERATION

### ► Other

When "Expanded Voice Commands" is turned "On". (→P.73)

Command	Action
"Turn Climate Control On"	Turns air conditioning system on
"Turn Climate Control Off"	Turns air conditioning system off
"Warmer"	Increases the temperature of the air conditioning system
"Cooler"	Decreases the temperature of the air conditioning system
"<##> degrees"	Changes the set temperature of the air conditioning system to <##> degrees* <sup>1</sup>
"Turn Music On"	Turns the audio system on
"Turn Music Off"	Turns the audio system off
"AM Radio"	Selects AM radio mode
"FM Radio"	Selects FM radio mode
"Sirius XM"	Selects satellite radio mode
"Disc"	Selects the selected disc mode
"USB"	Selects USB audio mode
"iPod"	Selects iPod audio mode
"Bluetooth* <sup>2</sup> Audio"	Selects Bluetooth® audio mode
"A.V."	Selects VTR mode
"Auxiliary"	Selects AUX audio mode

\*<sup>1</sup>: Only within the possible temperature range of the air conditioning system

\*<sup>2</sup>: Bluetooth is a registered trademark of Bluetooth SIG, Inc.

#### **INFORMATION**

- Commands relating to operation of the audio/visual and air conditioning systems can only be performed when the audio and air conditioning systems are turned on.

## 2. MOBILE ASSISTANT OPERATION

### 1. MOBILE ASSISTANT

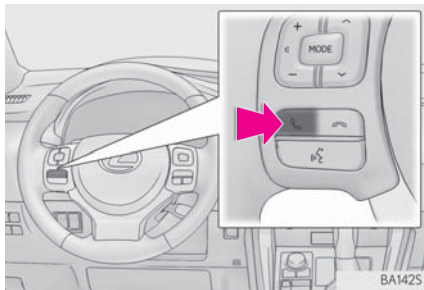

The Mobile Assistant feature will activate Apple's Siri® Eyes Free mode via the steering wheel switches. To operate the Mobile Assistant, a compatible cellular phone must be registered and connected to this system via Bluetooth®. (→P.48)

- 1 Press and hold this switch until you hear the beeps.

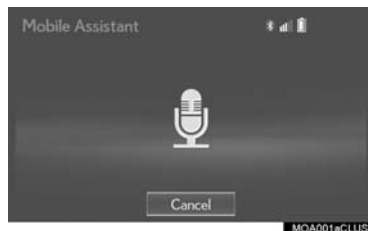

- 2 The Mobile Assistant can be used only when the following screen is displayed.



- To cancel the Mobile Assistant, select "Cancel", or press and hold the  on the steering wheel.
- To restart the Mobile Assistant for additional commands, press the  on the steering wheel.
  - Mobile Assistant can only be restarted after the system responds to a voice command.

- After some phone and music commands, the Mobile Assistant feature will automatically end to complete the requested action.

- The volume of the Mobile Assistant can be adjusted using the "PWR-VOL" knob or steering wheel volume control switches. The Mobile Assistant and phone call volumes are synchronized.

#### INFORMATION

- The available features and functions may vary based on the iOS version installed on the connected device.
- Some Siri features are limited in Eyes Free mode. If you attempt to use an unavailable function, Siri will inform you that the function is not available.
- If Siri is not enabled on the cellular phone connected via Bluetooth®, an error message will be displayed on the screen.
- While a phone call is active, the Mobile Assistant cannot be used.
- If using the navigation feature of the cellular phone, ensure the active audio source is Bluetooth® audio or iPod in order to hear turn by turn direction prompts.

5

VOICE COMMAND SYSTEM

## 2. MOBILE ASSISTANT OPERATION

### MICROPHONE

It is not necessary to speak directly into the microphone when using the Mobile Assistant.  
(Microphone location: →P.258)

#### (INFORMATION)

- Wait for the listening beeps before using the Mobile Assistant.
- The Mobile Assistant may not recognize commands in the following situations:
  - Spoken too quickly.
  - Spoken at a low or high volume.
  - The roof or windows are open.
  - Passengers are talking while the Mobile Assistant is being used.
  - The air conditioning speed is set high.
  - The air conditioning vents are turned toward the microphone.



# 6

## INFORMATION

### 1 INFORMATION DISPLAY

- 1. RECEIVING WEATHER INFORMATION ..... 274
- DISPLAYING WEATHER INFORMATION ..... 274
- 2. DATA SERVICES SETTINGS ..... 276
- SETTING DOWNLOAD METHODS ..... 276

1

2

3

4

5

6

7

8

9

## 1. INFORMATION DISPLAY

### 1. RECEIVING WEATHER INFORMATION

Weather radar information can be received via the HD Radio or by the LEXUS App Suite application on a Bluetooth® phone. For details about the LEXUS App Suite application: →P.346

#### DISPLAYING WEATHER INFORMATION

- 1 Press the “MENU” button on the Remote Touch.

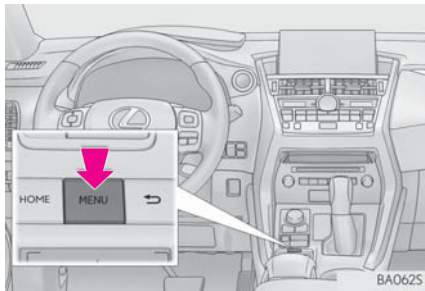

- 2 Select “Info”.



- 3 Select “Weather”.

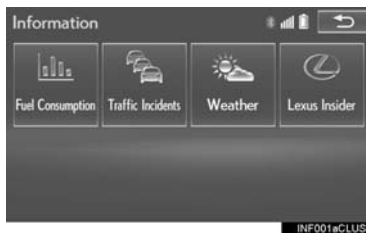

- 4 Check that the “Weather” screen is displayed.

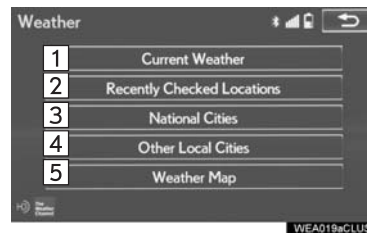

No.	Function
1	Select to display the weather of the current location. (→P.275)
2	Select to display the weather of a desired location in the recently checked locations list.
3	Select to display the weather of a desired location in the national cities list.
4	Select to display the weather of a desired location in the other local cities list.
5	Select to display Doppler weather radar information over the map.

**DISPLAYING THE WEATHER OF THE CURRENT LOCATION**

- 1 Display the "Weather" screen. (→P.274)
- 2 Select "Current Weather".
- 3 Select the desired tab to be displayed.



- ▶ When the "Current" tab is selected



- ▶ When the "3 Day" tab is selected



- When a specific day is selected, weather information for that day will be displayed.

- ▶ When the "6/12 Hour" tab is selected



**INFORMATION**

- If weather is set to the home screen, the weather screen of the current location will be displayed.

# 1. INFORMATION DISPLAY

## 2. DATA SERVICES SETTINGS

### SETTING DOWNLOAD METHODS

Data service information, which is comprised of traffic information and weather information, can be received via the HD Radio and by the LEXUS App Suite application on a Bluetooth® phone. The receiving method can be set to both or only via the HD Radio. For details about the LEXUS App Suite application: →P.346

1 Press the "MENU" button on the Remote Touch.

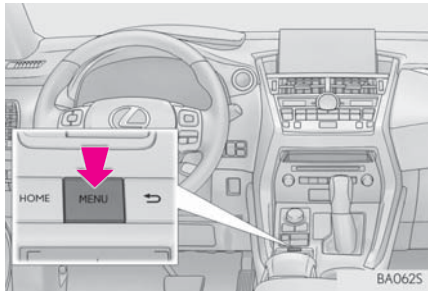

2 Select "Setup".



3 Select "Data Services Settings".



4 Select the desired item to be set.



● Select a checkbox on the right to set.

No.	Function
1	Select to receive data service information via both the HD Radio and the LEXUS App Suite application on a Bluetooth® phone. When both methods are available, the HD Radio will be selected.
2	Select to receive data only via the HD Radio.

# 7

## PERIPHERAL MONITORING SYSTEM

### 1 LEXUS PARKING ASSIST MONITOR

- |  |     |   |
|--|-----|---|
| 1. LEXUS PARKING ASSIST MONITOR .....                    | 278 | 4 |
| DRIVING PRECAUTIONS .....                                | 278 |   |
| SCREEN DISPLAY .....                                     | 280 | 5 |
| USING THE SYSTEM .....                                   | 281 |   |
| 2. ESTIMATED COURSE LINE DISPLAY MODE .....              | 283 | 6 |
| SCREEN DESCRIPTION .....                                 | 283 |   |
| PARKING .....  | 284 | 7 |
| 3. PARKING ASSIST GUIDE LINE DISPLAY MODE .....          | 285 | 8 |
| SCREEN DESCRIPTION .....                                 | 285 |   |
| PARKING .....  | 286 | 9 |
| 4. LEXUS PARKING ASSIST MONITOR PRECAUTIONS .....        | 287 |   |
| AREA DISPLAYED ON SCREEN .....                           | 287 |   |
| THE CAMERA .....   | 288 |   |
| DIFFERENCES BETWEEN THE SCREEN AND THE ACTUAL ROAD ..... | 289 |   |
| WHEN APPROACHING THREE-DIMENSIONAL OBJECTS .....         | 290 |   |
| 5. THINGS YOU SHOULD KNOW ....                           | 292 |   |
| IF YOU NOTICE ANY SYMPTOMS .....                         | 292 |   |

## 1. LEXUS PARKING ASSIST MONITOR

### 1. LEXUS PARKING ASSIST MONITOR

The parking assist monitor assists the driver by displaying an image of the view behind the vehicle while backing up, for example while parking.

#### INFORMATION

- The screen illustrations used in this text are intended as examples, and may differ from the image that is actually displayed on the screen.

#### DRIVING PRECAUTIONS

The parking assist monitor is a supplemental device intended to assist the driver when backing up. When backing up, be sure to visually check all around the vehicle both directly and using the mirrors before proceeding. If you do not, you may hit another vehicle, and could possibly cause an accident.

Pay attention to the following precautions when using the parking assist monitor.

#### ⚠ WARNING

- Never depend on the parking assist monitor entirely when backing up. The image and the position of the guide lines displayed on the screen may differ from the actual state.  
Use caution, just as you would when backing up any vehicle.
- Be sure to back up slowly, depressing the brake pedal to control vehicle speed.
- If you seem likely to hit nearby vehicles, obstacles, people or mount the shoulder, depress the brake pedal to stop the vehicle.
- The instructions given are only guidelines. When and how much to turn the steering wheel will vary according to traffic conditions, road surface conditions, vehicle condition, etc. when parking. It is necessary to be fully aware of this before using the parking assist system.
- When parking, be sure to check that the parking space will accommodate your vehicle before maneuvering into it.

**⚠ WARNING**

- Do not use the parking assist monitor system in the following cases:
  - On icy or slick road surfaces, or in snow
  - When using tire chains
  - When the back door is not closed completely
  - On roads that are not flat or straight, such as curves or slopes
- In low temperatures, the screen may darken or the image may become faint. The image could distort when the vehicle is moving, or you may become unable to see the image on the screen. Be sure to visually check all around the vehicle both directly and using the mirrors before proceeding.
- If the tire sizes are changed, the position of the guide lines displayed on the screen may change.
- The camera uses a special lens. The distances between objects and pedestrians that appear in the image displayed on the screen will differ from the actual distances. (→P.289)

## 1. LEXUS PARKING ASSIST MONITOR

### SCREEN DISPLAY

The parking assist monitor screen will be displayed if the shift lever is shifted to the "R" position while the engine <power> switch is in IGNITION ON <ON> mode.

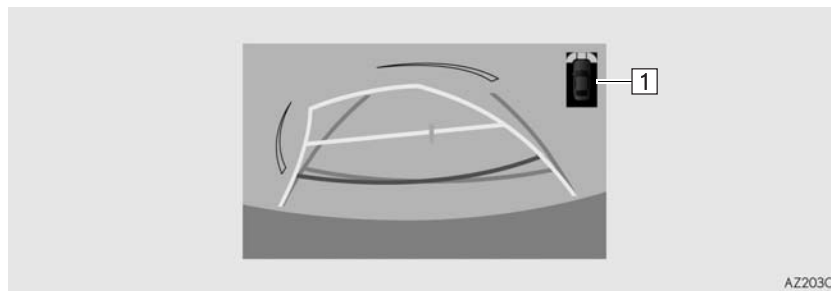

▶ **1** Intuitive parking assist

If an obstacle is detected while the intuitive parking assist is on, a display is shown in the top right corner of the screen.

### CANCELING LEXUS PARKING ASSIST MONITOR

The parking assist monitor is canceled when the shift lever is shifted into any position other than the "R" position.



**USING THE SYSTEM**

Use any of the following modes.

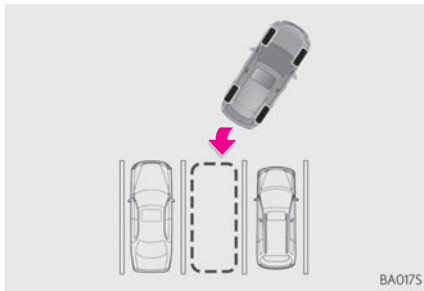

- ▶ Estimated course line display mode (→P.283)

Estimated course lines are displayed which move in accordance with the operation of the steering wheel.

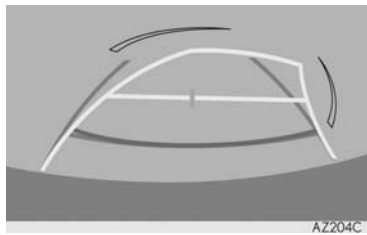

- ▶ Parking assist guide line display mode (→P.285)

The steering wheel return points (parking assist guide lines) are displayed.

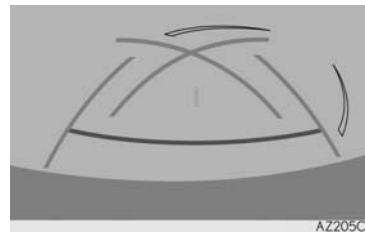

- ▶ Distance guide line display mode

Distance guide lines only are displayed.

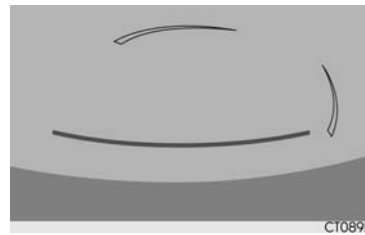

# 1. LEXUS PARKING ASSIST MONITOR

## SWITCHING THE DISPLAY MODE

When the shift lever is in any position other than the "R" position, the display mode can be changed in the following procedure.

- 1 Press the "MENU" button.
- 2 Select "Setup".
- 3 Select "Vehicle".
- 4 Select "Back Camera Guide Line Setting".

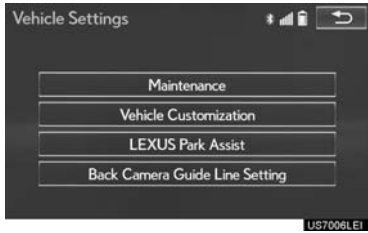

- 5 Select the display mode.

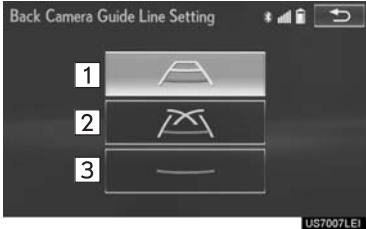

No.	Name	Detail
1	Estimated course line display mode	283
2	Parking assist guide line display mode	285
3	Distance guide line display mode	Distance guide lines only are displayed.

## 1. LEXUS PARKING ASSIST MONITOR

### 2. ESTIMATED COURSE LINE DISPLAY MODE

#### SCREEN DESCRIPTION

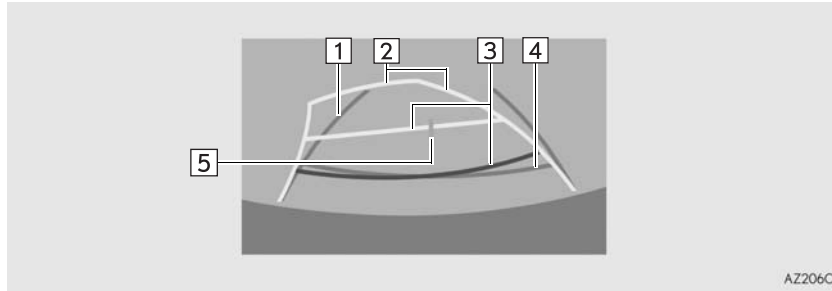

No.	Display	Function
1	Vehicle width guide line	Displays a guide path when the vehicle is being backed straight up. <ul style="list-style-type: none"> <li>The displayed width is wider than the actual vehicle width.</li> <li>These guide lines align with the estimated course lines when the vehicle is going straight ahead.</li> </ul>
2	Estimated course lines	Shows an estimated course when the steering wheel is turned.
3	Distance guide lines	Shows distance behind the vehicle when the steering wheel is turned. <ul style="list-style-type: none"> <li>The guide lines move in conjunction with the estimated course lines.</li> <li>The guide lines display points approximately 1.5 ft. (0.5 m) (red) and approximately 3 ft. (1 m) (yellow) from the center of the edge of the bumper.</li> </ul>
4	Distance guide line	Shows distance behind the vehicle. <ul style="list-style-type: none"> <li>Displays a point approximately 1.5 ft. (0.5 m) (blue) from the edge of the bumper.</li> </ul>
5	Vehicle center guide line	The line indicates the estimated vehicle center on the ground.

7

PERIPHERAL MONITORING SYSTEM

#### WARNING

- If the steering wheel is straight and the vehicle width guide lines and the estimated course lines are not in alignment, have the vehicle inspected by your Lexus dealer.

# 1. LEXUS PARKING ASSIST MONITOR

## PARKING

When parking in a space which is in the reverse direction to the space described in the procedure below, the steering directions will be reversed.

- 1 Shift the shift lever to the "R" position.
- 2 Turn the steering wheel so that the estimated course lines are within the parking space, and back up slowly.

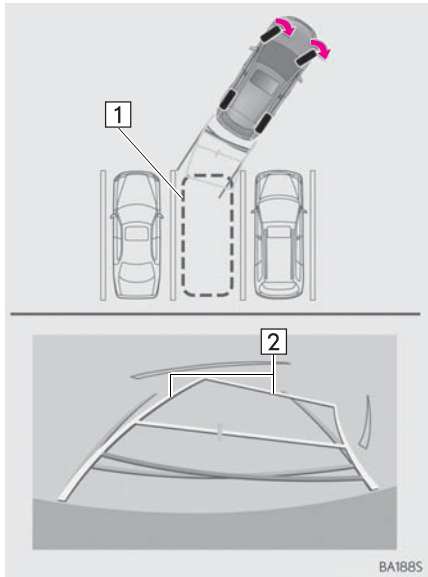

- ▶ 1 Parking space
- ▶ 2 Estimated course lines

- 3 When the rear position of the vehicle has entered the parking space, turn the steering wheel so that the vehicle width guide lines are within the left and right dividing lines of the parking space.

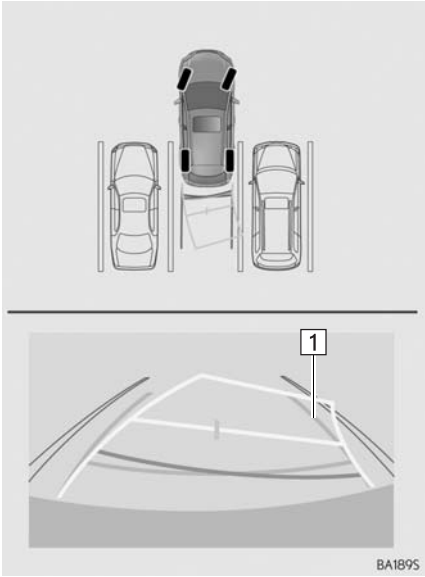

- ▶ 1 Vehicle width guide line
- 4 Once the vehicle width guide lines and the parking space lines are parallel, straighten the steering wheel and back up slowly until the vehicle has completely entered the parking space.
  - 5 Stop the vehicle in an appropriate place, and finish parking.

## 1. LEXUS PARKING ASSIST MONITOR

### 3. PARKING ASSIST GUIDE LINE DISPLAY MODE

#### SCREEN DESCRIPTION

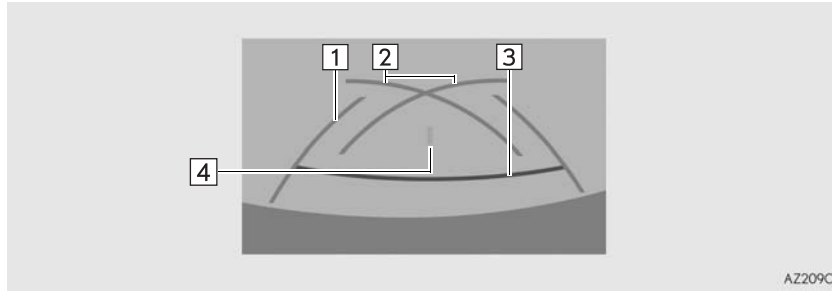

No.	Display	Function
1	Vehicle width guide line	Displays a guide path when the vehicle is being backed straight up. <ul style="list-style-type: none"> <li>The displayed width is wider than the actual vehicle width.</li> </ul>
2	Parking assist guide lines	Shows the path of the smallest turn possible behind the vehicle. <ul style="list-style-type: none"> <li>Shows the approximate position of the steering wheel when parking.</li> </ul>
3	Distance guide line	Shows distance behind the vehicle. <ul style="list-style-type: none"> <li>Display points approximately 1.5 ft. (0.5 m) (red) from the edge of the bumper.</li> </ul>
4	Vehicle center guide line	The line indicates the estimated vehicle center on the ground.

7

PERIPHERAL MONITORING SYSTEM

## 1. LEXUS PARKING ASSIST MONITOR

### PARKING

When parking in a space which is in the reverse direction to the space described in the procedure below, the steering directions will be reversed.

- 1 Shift the shift lever to the "R" position.
- 2 Back up until the parking assist guide line meets the edge of the left-hand dividing line of the parking space.

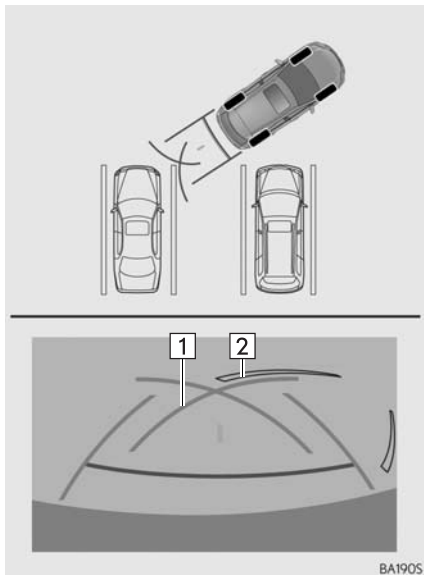

BA190S

- ▶ 1 Parking assist guide line
- ▶ 2 Parking space dividing line

- 3 Turn the steering wheel all the way to the right, and back up slowly.
- 4 Once the vehicle is parallel with the parking space, straighten the steering wheel and back up slowly until the vehicle has completely entered the parking space.
- 5 Stop the vehicle in an appropriate place, and finish parking.

## 1. LEXUS PARKING ASSIST MONITOR

# 4. LEXUS PARKING ASSIST MONITOR PRECAUTIONS

### AREA DISPLAYED ON SCREEN

The parking assist monitor displays an image of the view from the bumper of the rear area of the vehicle.

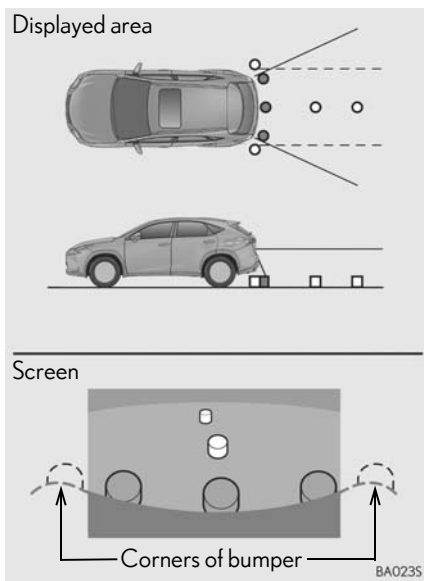

- The image adjustment procedure for the parking assist monitor screen is the same as the procedure for adjusting the navigation screen. (→P.45)

### INFORMATION

- The area displayed on the screen may vary according to vehicle orientation conditions.
- Objects which are close to either corner of the bumper or under the bumper cannot be displayed.
- The camera uses a special lens. The distance of the image that appears on the screen differs from the actual distance.
- Items which are located higher than the camera may not be displayed on the monitor.

### THE CAMERA

The camera for the parking assist monitor is located as shown in the illustration.

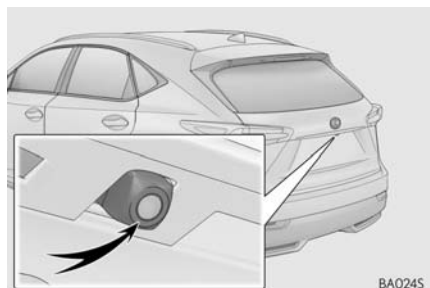

### USING THE CAMERA

If dirt or foreign matter (such as water droplets, snow, mud etc.) is adhering to the camera, it cannot transmit a clear image. In this case, flush it with a large quantity of water and wipe the camera lens clean with a soft and wet cloth.

### NOTICE

- The parking assist monitor may not operate properly in the following cases.
  - If the back of the vehicle is hit, the position and mounting angle of the camera may change.
  - As the camera has a water proof construction, do not detach, disassemble or modify it. This may cause incorrect operation.
  - When cleaning the camera lens, flush the camera with a large quantity of water and wipe it with a soft and wet cloth. Strongly rubbing the camera lens may cause the camera lens to be scratched and unable to transmit a clear image.
  - Do not allow organic solvent, car wax, window cleaner or a glass coating to adhere to the camera. If this happens, wipe it off as soon as possible.
  - If the temperature changes rapidly, such as when hot water is poured on the vehicle in cold weather, the system may not operate normally.
  - When washing the vehicle, do not apply intensive bursts of water to the camera or camera area. Doing so may result in the camera malfunctioning.
- Do not expose the camera to strong impact as this could cause a malfunction. If this happens, have the vehicle inspected by your Lexus dealer as soon as possible.



**DIFFERENCES BETWEEN THE SCREEN AND THE ACTUAL ROAD**

- The distance guide lines and the vehicle width guide lines may not actually be parallel with the dividing lines of the parking space, even when they appear to be so. Be sure to check visually.
- The distances between the vehicle width guide lines and the left and right dividing lines of the parking space may not be equal, even when they appear to be so. Be sure to check visually.
- The distance guide lines give a distance guide for flat road surfaces. In any of the following situations, there is a margin of error between the guide lines on the screen and the actual distance/course on the road.

**WHEN THE GROUND BEHIND THE VEHICLE SLOPES UP SHARPLY**

The distance guide lines will appear to be closer to the vehicle than the actual distance. Because of this, objects will appear to be farther away than they actually are. In the same way, there will be a margin of error between the guidelines and the actual distance/course on the road.



7

PERIPHERAL MONITORING SYSTEM

# 1. LEXUS PARKING ASSIST MONITOR

## WHEN THE GROUND BEHIND THE VEHICLE SLOPES DOWN SHARPLY

The distance guide lines will appear to be farther from the vehicle than the actual distance. Because of this, objects will appear to be closer than they actually are. In the same way, there will be a margin of error between the guidelines and the actual distance/course on the road.

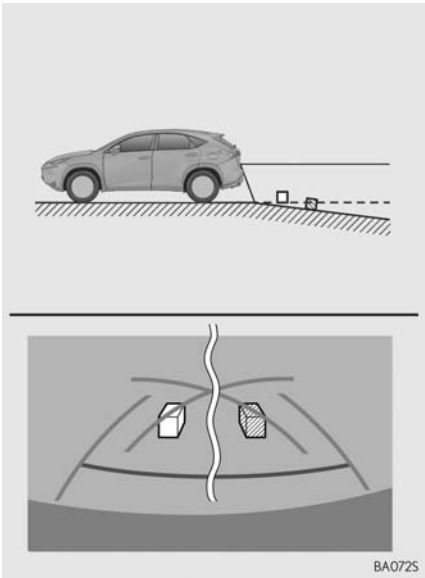

## WHEN ANY PART OF THE VEHICLE SAGS

When any part of the vehicle sags due to the number of passengers or the distribution of the load, there is a margin of error between the guide lines on the screen and the actual distance/course on the road.

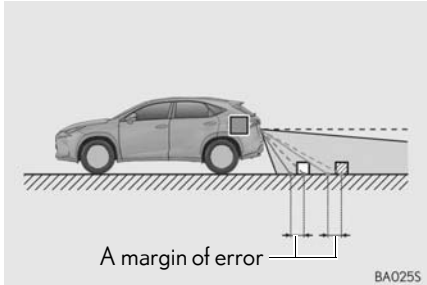

## WHEN APPROACHING THREE-DIMENSIONAL OBJECTS

The estimated course lines target flat surfaced objects (such as the road). It is not possible to determine the position of three-dimensional objects (such as vehicles) using the estimated course lines and distance guide lines. When approaching a three-dimensional object that extends outward (such as the flatbed of a truck), be careful of the following.

**ESTIMATED COURSE LINES**

Visually check the surroundings and the area behind the vehicle. In the case shown below, the truck appears to be outside of the estimated course lines and the vehicle does not look as if it hits the truck. However, the rear body of the truck may actually cross over the estimated course lines. In reality if you back up as guided by the estimated course lines, the vehicle may hit the truck.

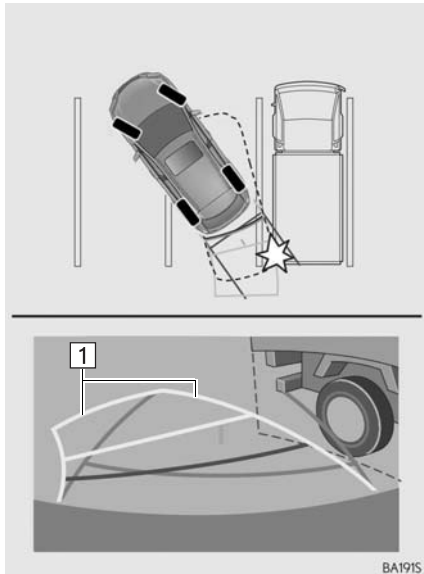

▶ **1** Estimated course lines

**DISTANCE GUIDE LINES**

Visually check the surroundings and the area behind the vehicle. On the screen, it appears that a truck is parking at point B. However, in reality if you back up to point A, you will hit the truck. On the screen, it appears that A is closest and C is farthest away. However, in reality, the distance to A and C is the same, and B is farther than A and C.

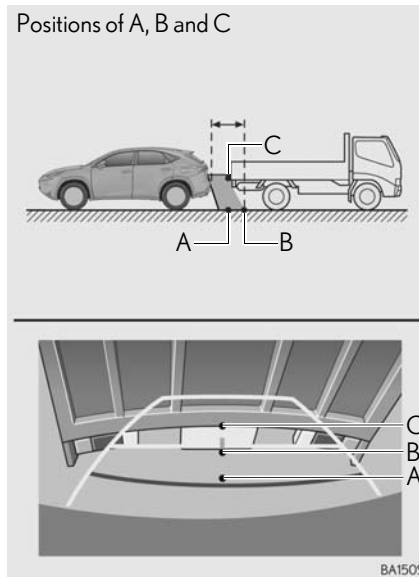

7  
PERIPHERAL MONITORING SYSTEM

## 1. LEXUS PARKING ASSIST MONITOR

### 5. THINGS YOU SHOULD KNOW

#### IF YOU NOTICE ANY SYMPTOMS

If you notice any of the following symptoms, refer to the likely cause and the solution, and re-check.

If the symptom is not resolved by the solution, have the vehicle inspected by your Lexus dealer.

Symptom	Likely cause	Solution
The image is difficult to see	<ul style="list-style-type: none"><li>• The vehicle is in a dark area</li><li>• The temperature around the lens is either high or low</li><li>• The outside temperature is low</li><li>• There are water droplets on the camera</li><li>• It is raining or humid</li><li>• Foreign matter (mud etc.) is adhering to the camera</li><li>• Sunlight or headlights are shining directly into the camera</li><li>• The vehicle is under fluorescent lights, sodium lights, mercury lights etc.</li></ul>	Back up while visually checking the vehicle's surroundings. (Use the monitor again once conditions have been improved.) The procedure for adjusting the picture quality of the parking assist monitor is the same as the procedure for adjusting the navigation screen. (→P.45)
The image is blurry	Dirt or foreign matter (such as water droplets, snow, mud etc.) is adhering to the camera.	Flush the camera with a large quantity of water and wipe the camera lens clean with a soft and wet cloth.
The image is out of alignment	The camera or surrounding area has received a strong impact.	Have the vehicle inspected by your Lexus dealer.

## 1. LEXUS PARKING ASSIST MONITOR

Symptom	Likely cause	Solution
The guide lines are very far out of alignment	The camera position is out of alignment.	Have the vehicle inspected by your Lexus dealer.
	<ul style="list-style-type: none"> <li>• The vehicle is tilted. (There is a heavy load on the vehicle, tire pressure is low due to a tire puncture, etc.)</li> <li>• The vehicle is used on an incline.</li> </ul>	If this happens due to these causes, it does not indicate a malfunction. Back up while visually checking the vehicle's surroundings.
The estimated course lines move even though the steering wheel is straight	There is a malfunction in the signals being output by the steering sensor.	Have the vehicle inspected by your Lexus dealer.
Guide lines are not displayed	The back door is open.	Close the back door. If this does not resolve the symptom, have the vehicle inspected by your Lexus dealer.
The estimated course lines are not displayed	<ul style="list-style-type: none"> <li>• The steering wheel has been moved while the 12-volt battery was being reinstalled.</li> <li>• 12-volt battery power is low.</li> <li>• The steering sensor has been reinstalled.</li> <li>• There is a malfunction in the signals being output by the steering sensor.</li> </ul>	Stop the vehicle, and turn the steering wheel as far as it will go to the left and right. If this does not resolve the symptom, have the vehicle inspected by your Lexus dealer.

7

PERIPHERAL MONITORING SYSTEM

## 1. LEXUS PARKING ASSIST MONITOR

# 8

## PHONE

### 1 PHONE OPERATION (HANDS-FREE SYSTEM FOR CELLULAR PHONES)

- 1. QUICK REFERENCE ..... 296
- 2. SOME BASICS ..... 297
  - REGISTERING/CONNECTING A Bluetooth® PHONE..... 298
  - USING THE PHONE SWITCH/MICROPHONE..... 298
  - VOICE COMMAND SYSTEM..... 299
  - ABOUT THE CONTACTS IN THE CONTACT LIST ..... 300
  - WHEN SELLING OR DISPOSING OF THE VEHICLE ..... 300
- 3. CALLING ON THE Bluetooth® PHONE..... 301
  - BY FAVORITES LIST ..... 302
  - BY CALL HISTORY ..... 302
  - BY CONTACTS LIST ..... 303
  - BY DIAL PAD ..... 306
  - BY OFF HOOK SWITCH ..... 306
- 4. RECEIVING ON THE Bluetooth® PHONE..... 307
  - INCOMING CALLS..... 307

- 5. TALKING ON THE Bluetooth® PHONE..... 308
  - INCOMING CALL WAITING..... 310
- 6. Bluetooth® PHONE MESSAGE FUNCTION..... 311
  - RECEIVING A MESSAGE..... 312
  - CHECKING MESSAGES..... 313
  - REPLYING TO A MESSAGE (QUICK REPLY)..... 314
  - CALLING THE MESSAGE SENDER ..... 316

### 2 SETUP

- 1. PHONE/MESSAGE SETTINGS..... 318
  - PHONE/MESSAGE SETTINGS SCREEN ..... 318
  - "Sound Settings" SCREEN ..... 319
  - "Contact/Call History Settings" SCREEN ..... 320
  - "Messaging Settings" SCREEN..... 332
  - "Phone Display Settings" SCREEN..... 333

### 3 WHAT TO DO IF...

- 1. TROUBLESHOOTING..... 334

1

2

3

4

5

6

7

8

9

## 1. PHONE OPERATION (HANDS-FREE SYSTEM FOR CELLULAR PHONES)

### 1. QUICK REFERENCE

The phone top screen can be used to make a phone call. To display this screen, press the “MENU” button on the Remote Touch and select “Phone”, or the  switch on the steering wheel.

Several functions are available to operate on each screen that is displayed by selecting the 4 tabs.

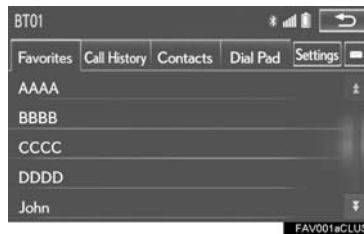

	Function	Page
Phone operation	Registering/connecting Bluetooth® device	48
	Calling on the Bluetooth® phone	301
	Receiving on the Bluetooth® phone	307
	Talking on the Bluetooth® phone	308
Message function	Using the Bluetooth® phone message function	311
Setting up a phone	Phone settings	318
	Bluetooth® settings	56



## 1. PHONE OPERATION (HANDS-FREE SYSTEM FOR CELLULAR PHONES)

### 2. SOME BASICS

The hands-free system enables calls to be made and received without having to take your hands off the steering wheel.

This system supports Bluetooth<sup>®</sup>. Bluetooth<sup>®</sup> is a wireless data system that enables cellular phones to be used without being connected by a cable or placed in a cradle.

The operating procedure of the phone is explained here.



#### WARNING

- While driving, do not use a cellular phone or connect the Bluetooth<sup>®</sup> phone.
- Your audio unit is fitted with Bluetooth<sup>®</sup> antennas. People with implantable cardiac pacemakers, cardiac resynchronization therapy-pacemakers or implantable cardioverter defibrillators should maintain a reasonable distance between themselves and the Bluetooth<sup>®</sup> antennas. The radio waves may affect the operation of such devices.
- Before using Bluetooth<sup>®</sup> devices, users of any electrical medical device other than implantable cardiac pacemakers, cardiac resynchronization therapy-pacemakers or implantable cardioverter defibrillators should consult the manufacturer of the device for information about its operation under the influence of radio waves. Radio waves could have unexpected effects on the operation of such medical devices.



#### NOTICE

- Do not leave your cellular phone in the vehicle. The temperature inside may rise to a level that could damage the phone.

#### INFORMATION

- If your cellular phone does not support Bluetooth<sup>®</sup>, this system cannot function.
- In the following conditions, the system may not function:
  - The cellular phone is turned off.
  - The current position is outside the communication area.
  - The cellular phone is not connected.
  - The cellular phone has a low battery.
- When using Bluetooth<sup>®</sup> audio and hands-free system at the same time, the following problems may occur:
  - The Bluetooth<sup>®</sup> connection may be cut.
  - Noise may be heard on the Bluetooth<sup>®</sup> audio playback.

## 1. PHONE OPERATION (HANDS-FREE SYSTEM FOR CELLULAR PHONES)

### REGISTERING/ CONNECTING A Bluetooth® PHONE

To use the hands-free system for cellular phones, it is necessary to register a cellular phone with the system. (→P.48)

### Bluetooth® PHONE CONDITION DISPLAY

The condition of the Bluetooth® phone appears on the upper right side of the screen. (→P.16)

### USING THE PHONE SWITCH/ MICROPHONE

#### ► Steering switch

By pressing the phone switch, a call can be received or ended without taking your hands off the steering wheel.

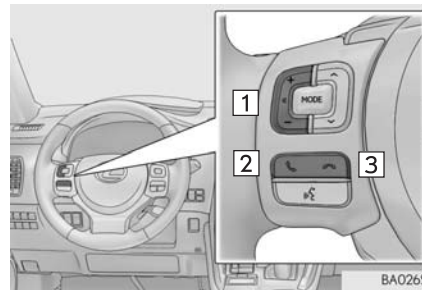

#### 1 Volume control switch

- Press the "+" side to increase the volume.
- Press the "-" side to decrease the volume.

#### 2 Off hook switch

#### 3 On hook switch

#### ► Microphone

The microphone is used when talking on the phone.

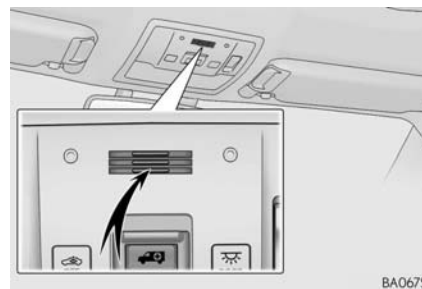

## VOICE COMMAND SYSTEM

Press this switch to operate the voice command system.

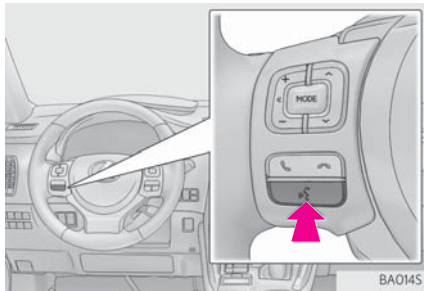

- The voice command system and its list of commands can be operated. (→P.258)

## INFORMATION

- The other party's voice will be heard from the front speakers. The audio/visual system will be muted during phone calls or when hands-free voice commands are used.
- Talk alternately with the other party on the phone. If both parties speak at the same time, the other party may not hear what has been said. (This is not a malfunction.)
- Keep call volume down. Otherwise, the other party's voice may be audible outside the vehicle and voice echo may increase. When talking on the phone, speak clearly towards the microphone.
- The other party may not hear you clearly when:
  - Driving on an unpaved road. (Making excessive traffic noise.)
  - Driving at high speeds.
  - The roof or windows are open.
  - The air conditioning vents are pointed towards the microphone.
  - The sound of the air conditioning fan is loud.
  - There is a negative effect on sound quality due to the phone and/or network being used.

### ABOUT THE CONTACTS IN THE CONTACT LIST

- The following data is stored for every registered phone. When another phone is connected, the following registered data cannot be read:
  - Contact data
  - Call history data
  - Favorites data
  - Image data
  - All phone settings
  - Message settings

#### INFORMATION

- When a phone's registration is deleted, the above-mentioned data is also deleted.

### WHEN SELLING OR DISPOSING OF THE VEHICLE

A lot of personal data is registered when the hands-free system is used. When selling or disposing of the vehicle, initialize the data. (→P.72)

- The following data in the system can be initialized:
  - Contact data
  - Call history data
  - Favorites data
  - Image data
  - All phone settings
  - Message settings

#### INFORMATION

- Once initialized, the data and settings will be erased. Pay much attention when initializing the data.

## 1. PHONE OPERATION (HANDS-FREE SYSTEM FOR CELLULAR PHONES)

### 3. CALLING ON THE Bluetooth® PHONE

After a Bluetooth® phone has been registered, a call can be made using the hands-free system. There are several methods by which a call can be made, as described below.

- 1 Press the “MENU” button on the Remote Touch.

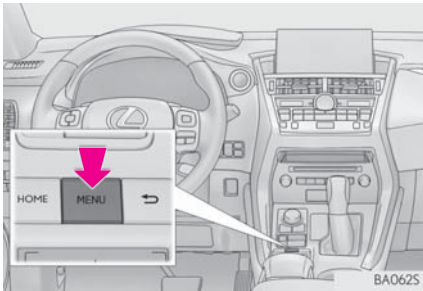

- 2 Select “Phone”.



- 3 Select the desired tab to call from.



- The phone top screen can be displayed by pressing the  switch on the steering wheel.

How to make a call list	Page
By favorites list	302
By call history	302
By contacts list*	303
By dial pad*	306
By e-mail/SMS/MMS	316
By POI call	97
By off hook switch	306
By LEXUS App Suite*	360
By voice command system	264

8  
PHONE

\*: The operation cannot be performed while driving.

# 1. PHONE OPERATION (HANDS-FREE SYSTEM FOR CELLULAR PHONES)

## BY FAVORITES LIST

Calls can be made using registered contacts which can be selected from a contact list. (→P.328)

- 1 Display the phone top screen. (→P.301)
- 2 Select the **“Favorites”** tab and select the desired contact.

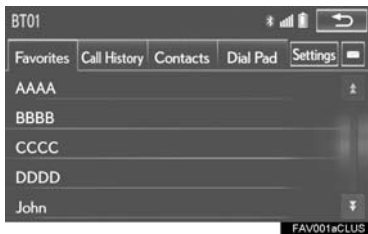

- 3 Select the desired number.

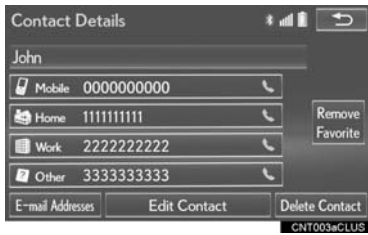

- 4 Check that the **“Call”** screen is displayed.



## BY CALL HISTORY

Up to 30 of the latest call history items (missed, incoming and outgoing) can be selected from the **“Call History”** tab.

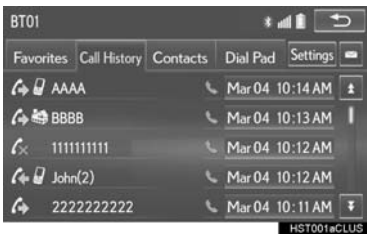
- 1 Display the phone top screen. (→P.301)
- 2 Select the **“Call History”** tab and select  or the desired contact.



● The icons of call type are displayed.

-  : Missed call
-  : Incoming call
-  : Outgoing call

- ▶ When  is selected
- 3 Check that the “Call” screen is displayed.
- ▶ When the desired contact is selected
- 3 Select the desired number.

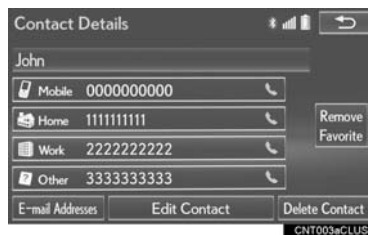

- 4 Check that the “Call” screen is displayed.

**INFORMATION**

- When making a call to the same number continuously, only the most recent call is listed in call history.
- When a phone number registered in the contact list is received, the name is displayed.
- Number-withheld calls are also memorized in the system.
- International phone calls may not be made depending on the type of cellular phone you have.
- The list should group together consecutive entries with the same phone number and same call type. For example, two calls from John’s mobile would be displayed as follows: John (2)
- By pressing the  switch on the steering wheel, a call to the latest history item can be made.

**BY CONTACTS LIST**

Calls can be made by using contact data which is transferred from a registered cellular phone. (→P.304)  
Up to 2500 contacts (maximum of 4 phone numbers and e-mail addresses per contact) can be registered in the contact list.

- 1 Display the phone top screen. (→P.301)
- 2 Select the “Contacts” tab and select the desired contact.

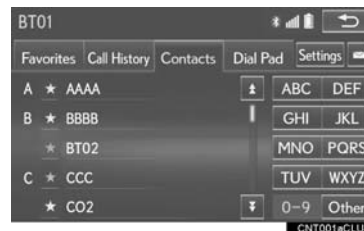

- 3 Select the desired number.

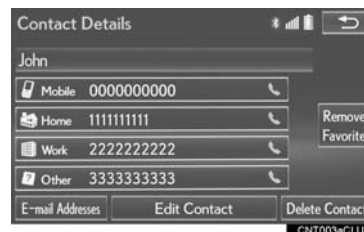

- 4 Check that the “Call” screen is displayed.

8 PHONE

1. PHONE OPERATION (HANDS-FREE SYSTEM FOR CELLULAR PHONES)

**WHEN THE CONTACT IS EMPTY**

**FOR PBAP COMPATIBLE Bluetooth® PHONES**

- ▶ When “Automatic Contact/History Transfer” is set to on (→P.320)
- Contacts are transferred automatically.

▶ When “Automatic Contact/History Transfer” is set to off (→P.320)

1 Select the desired item.

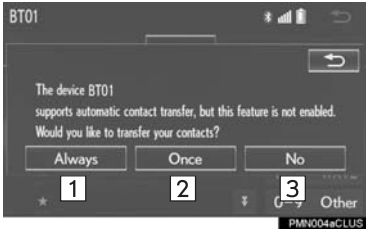

No.	Function
1	Select to always transfer all the contacts from a connected cellular phone automatically.
2	Select to transfer all the contacts from a connected cellular phone only once.
3	Select to cancel transferring.

2 Check that a confirmation screen is displayed when the operation is complete.



■ FOR PBAP INCOMPATIBLE BUT OPP COMPATIBLE Bluetooth® PHONES

1 Select the desired item.

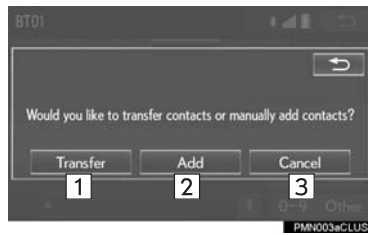

No.	Function
1	Select to transfer the contacts from the connected cellular phone.
2	Select to add a new contact manually.
3	Select to cancel transferring.

▶ When "Transfer" is selected

2 Follow the steps in "FOR PBAP INCOMPATIBLE BUT OPP COMPATIBLE Bluetooth® PHONES" from "STEP 3". (→P.323)

▶ When "Add" is selected

2 Follow the steps in "REGISTERING A NEW CONTACT TO THE CONTACTS LIST" from "STEP 2". (→P.325)

**INFORMATION**



- Manual transfer operation cannot be performed while driving.
- If your cellular phone is neither PBAP nor OPP compatible, the contacts cannot be transferred.
- Depending on the type of Bluetooth® phone:
  - It may be necessary to perform additional steps on the phone when transferring contact data.
  - The registered image in the contact list may not transfer depending on the type of Bluetooth® phone connected.

## 1. PHONE OPERATION (HANDS-FREE SYSTEM FOR CELLULAR PHONES)

### BY DIAL PAD

- 1 Display the phone top screen. (→P.301)
- 2 Select the “Dial Pad” tab and enter the phone number.





- 3 Select  or press the  switch on the steering wheel.
- 4 Check that the “Call” screen is displayed.

### INFORMATION

- Depending on the type of Bluetooth® phone being connected, it may be necessary to perform additional steps on the phone.

### BY OFF HOOK SWITCH

Calls can be made using the latest call history item.



- 1 Press the  switch on the steering wheel to display the phone top screen.
- 2 Press the  switch on the steering wheel to display the “Call History” screen.
- 3 Press the  switch on the steering wheel to call the latest history item.
- 4 Check that the “Call” screen is displayed.

## 1. PHONE OPERATION (HANDS-FREE SYSTEM FOR CELLULAR PHONES)



### 4. RECEIVING ON THE Bluetooth® PHONE

#### INCOMING CALLS

When a call is received, this screen is displayed with a sound.

- 1 Select  or press the  switch on the steering wheel to talk on the phone.



**To refuse to receive the call:** Select  or press the  switch on the steering wheel.

**To adjust the volume of a received call:** Turn the "PWR·VOL" knob, or use the volume control switch on the steering wheel.

#### INFORMATION

- During international phone calls, the other party's name or number may not be displayed correctly depending on the type of cellular phone you have.
- The incoming call display mode can be set. (→P.333)
- The ringtone that has been set in the "Sound Settings" screen sounds when there is an incoming call. Depending on the type of Bluetooth® phone, both the navigation system and Bluetooth® phone may sound simultaneously when there is an incoming call. (→P.319)

## 1. PHONE OPERATION (HANDS-FREE SYSTEM FOR CELLULAR PHONES)

### 5. TALKING ON THE Bluetooth® PHONE

While talking on the phone, this screen is displayed. The operations outlined below can be performed on this screen.

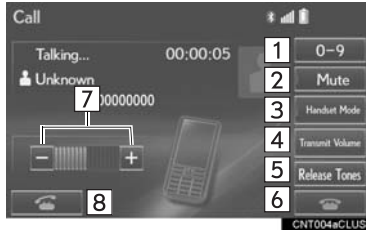

No.	Function	Page
1	Select to display the dial pad to send tones.	309
2	Select to mute your voice to the other party.	—
3	Select to change handset modes between hands-free and cellular phone.	—
4	Select to adjust your voice volume that the other party hears from their speaker.	310
5	Select to send tones. This button only appears when a number that contains a (w) is dialed in hands-free mode.	309
6	Select to hang up the phone.	—
7	Select "+" or "-" to adjust the volume of the other party's voice.	—
8	Select to start talking with the other party.	310

#### INFORMATION

- Changing from hands-free call to cellular phone call is not possible while driving.
- When cellular phone call is changed to hands-free call, the hands-free screen will be displayed and its functions can be operated on the screen.
- Changing between cellular phone call and hands-free call can be performed by operating the cellular phone directly.
- Transferring methods and operations will be different depending on the type of cellular phone you have.
- For the operation of the cellular phone, see the manual that comes with it.

**SENDING TONES**

**BY DIAL PAD**

This operation cannot be performed while driving.

- 1 Select "0-9".



- 2 Enter the desired number.

**BY SELECTING "Release Tones"**

"Release Tones" appear when a continuous tone signal(s) containing a (w) is registered in the contact list.

This operation can be performed while driving.

- 1 Select "Release Tones".

**INFORMATION**

- A continuous tone signal is a character string that consists of numbers and the characters p or w. (e.g. 056133w0123p#1\*)
- When the "p" pause tone is used, the tone data up until the next pause tone will be automatically sent after 2 seconds have elapsed. When the "w" pause tone is used, the tone data up until the next pause tone will be automatically sent after a user operation is performed.
- Release tones can be used when automated operation of a phone based service such as an answering machine or bank phone service is desired. A phone number with continuous tone signals can be registered in the contact list.
- Tone data after a "w" pause tone can be operated on voice command during a call.

## 1. PHONE OPERATION (HANDS-FREE SYSTEM FOR CELLULAR PHONES)

### TRANSMIT VOLUME SETTING

- 1 Select "Transmit Volume".
- 2 Select the desired level for the transmit volume.

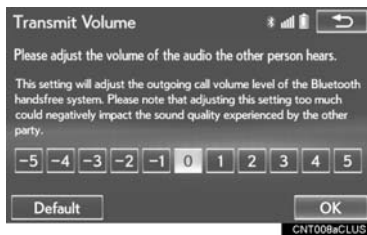



- 3 Select "OK".

#### INFORMATION



- The sound quality of the voice heard from the other party's speaker may be negatively impacted.
- To reset the transmit volume, select "Default".
- "Transmit Volume" is dimmed when mute is on.

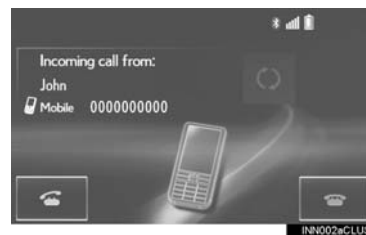

### INCOMING CALL WAITING

When a call is interrupted by a third party while talking, this screen is displayed.

- 1 Select  or press the  switch on the steering wheel to start talking with the other party.



To refuse to receive the call: Select  or press the  switch on the steering wheel.

- Each time  is selected or the  switch on the steering wheel is pressed during an interrupted call, the party who is on hold will be switched.

#### INFORMATION

- This function may not be available depending on the type of cellular phone.

# 1. PHONE OPERATION (HANDS-FREE SYSTEM FOR CELLULAR PHONES)

## 6. Bluetooth® PHONE MESSAGE FUNCTION

Received messages can be forwarded from the connected Bluetooth® phone, enabling checking and replying using the navigation system.

Depending on the type of Bluetooth® phone connected, received messages may not be transferred to the message inbox.

If the phone does not support the message function, this function cannot be used.

- 1 Press the "MENU" button on the Remote Touch.

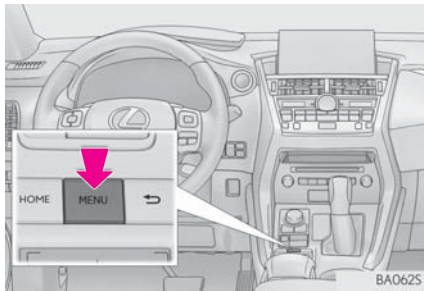

- 2 Select "Phone".

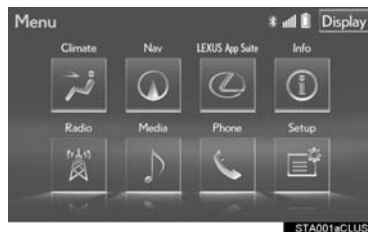

- 3 Select [Phone Icon].

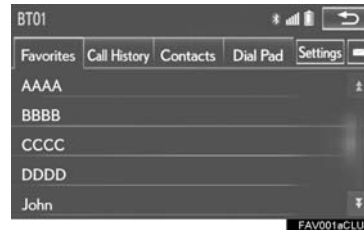

- The phone top screen can be displayed by pressing the [Phone Icon] switch on the steering wheel.

- 4 Check that the message inbox screen is displayed.

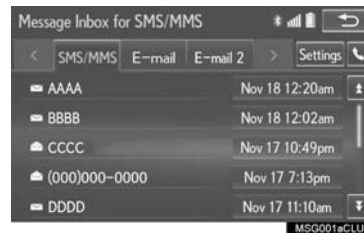

[Phone Icon] : Select to change to phone mode.

8 PHONE

Function	Page
Receiving a message	312
Checking messages	313
Replying to a message (quick reply)	314
Calling the message sender	316
Message settings	332

## RECEIVING A MESSAGE

When an e-mail/SMS/MMS is received, the incoming message screen pops up with sound and is ready to be operated on the screen.



No.	Function
1	Select to check the message.
2	Select to not open the message.
3	Select to call the message sender.

## INFORMATION

- Depending on the cellular phone used for receiving messages, or its registration status with the navigation system, some information may not be displayed.
- The pop up screen is separately available for incoming e-mail and SMS/MMS messages under the following conditions:

E-mail:

- "Incoming E-mail Display" is set to "Full Screen". (→P.332)
- "E-mail Notification Popup" is set to on. (→P.332)

SMS/MMS:

- "Incoming SMS/MMS Display" is set to "Full screen". (→P.332)
- "SMS/MMS Notification Popup" is set to on. (→P.332)



CHECKING MESSAGES

- 1 Display the message inbox screen. (→P.311)
- 2 Select the desired message from the list.
- 3 Check that the message is displayed.



No.	Function
1	Select <b>“Mark Unread”</b> or <b>“Mark Read”</b> to mark mail unread or read on the message inbox screen. This function is available when <b>“Update Message Read Status on Phone”</b> is set to on. (→P.332)
2	Select to reply the message. (→P.314)
3	Select to display the previous or next message.
4	Select to have messages read out. To cancel this function, select <b>“Stop”</b> . When <b>“Automatic Message Read-out”</b> is set to on, messages will be automatically read out. (→P.332)
5	Select to make a call to the sender.

INFORMATION

- Reading a text message is not available while driving.
- Depending on the type of Bluetooth® phone being connected, it may be necessary to perform additional steps on the phone.
- Messages are displayed in the appropriate connected Bluetooth® phone's registered mail address folder. Select the tab of the desired folder to be displayed.
- Only received messages on the connected Bluetooth® phone can be displayed.
- The text of the message is not displayed while driving.
- Turn the **“PWR·VOL”** knob, or use the volume control switch on the steering wheel to adjust the message read out volume.

## REPLYING TO A MESSAGE (QUICK REPLY)

15 messages have already been stored.

- 1 Display the message inbox screen. (→P.311)
- 2 Select the desired message from the list.
- 3 Select “Quick Msg”.



- 4 Select the desired message.



- 5 Select “Send”.



- While the message is being sent, a sending message screen is displayed.
  - To cancel sending the message, select “Cancel”.
- 6 Check that a confirmation screen is displayed when the operation is complete.
  - If an error message is displayed, follow the guidance on the screen to try again.

■ EDITING QUICK REPLY MESSAGES

This operation cannot be performed while driving.

1 Select "Quick Msg".



2 Select  corresponding to the desired message to edit.



3 Select "OK" when editing is completed.

INFORMATION

● To reset the edited quick reply messages, select "Default".

● "Quick Message 1" ("I am driving and will arrive in approximately [ETA] minutes.):

This message cannot be edited and will automatically fill in [ETA] with the navigation calculated estimated time of arrival on the confirm message screen.

If there are waypoints set, [ETA] to the next waypoint will be shown.

If there is no route currently set in the navigation system, "Quick Message 1" cannot be selected.

1. PHONE OPERATION (HANDS-FREE SYSTEM FOR CELLULAR PHONES)

**CALLING THE MESSAGE SENDER**

Calls can be made to an e-mail/SMS/MMS message sender's phone number. This operation can be performed while driving.

**CALLING FROM E-MAIL/SMS/MMS MESSAGE DISPLAY**

- 1 Display the message inbox screen. (→P.311)
- 2 Select the desired message.
- 3 Select .



- If there are 2 or more phone numbers, select the desired number.
- 4 Check that the "Call" screen is displayed.

**CALLING FROM A NUMBER WITHIN A MESSAGE**

Calls can be made to a number identified in a message's text area. This operation cannot be performed while driving.

- 1 Display the message inbox screen. (→P.311)
- 2 Select the desired message.
- 3 Select the text area.



- 4 Select the desired number.

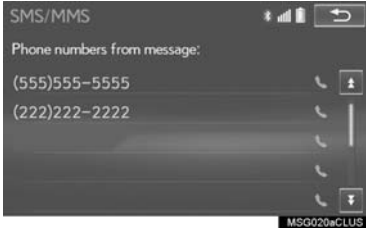

- Identified phone numbers contained in the message are displayed.

- 5 Check that the "Call" screen is displayed.

**INFORMATION**

- A series of numbers may be recognized as a phone number. Additionally, some phone numbers may not be recognized, such as those for other countries.

**■ CALLING FROM THE INCOMING MESSAGE SCREEN**

→P.312

## 2. SETUP

# 1. PHONE/MESSAGE SETTINGS

1 Press the “MENU” button on the Remote Touch.

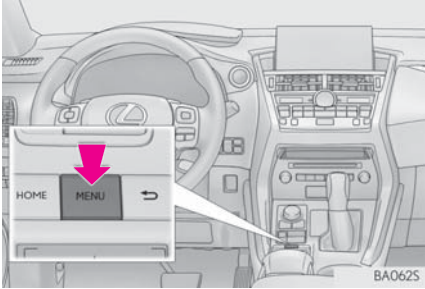

2 Select “Setup”.



3 Select “Phone”.



4 Select the item to be set.



## PHONE/MESSAGE SETTINGS SCREEN



No.	Information	Page
1	Registering/connecting a phone	57
2	Sound settings	319
3	Contact/call history settings	320
4	Messaging settings	332
5	Phone display settings	333

### DISPLAYING THE PHONE/ MESSAGE SETTINGS SCREEN IN A DIFFERENT WAY

- 1 Display the phone top screen. (→P.301)
- 2 Select **“Settings”**.

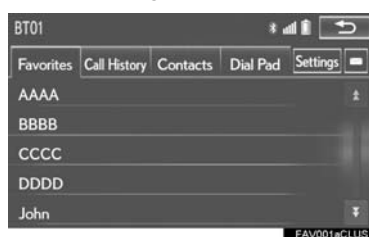

### “Sound Settings” SCREEN

The call and ringtone volume can be adjusted. A ringtone can be selected.

- 1 Display the “Phone/Message Settings” screen. (→P.318)
- 2 Select **“Sound Settings”**.
- 3 Select the desired item to be set.

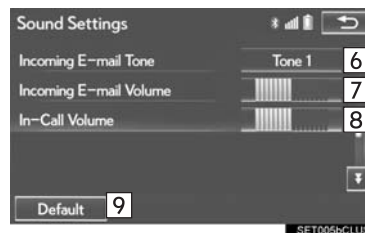
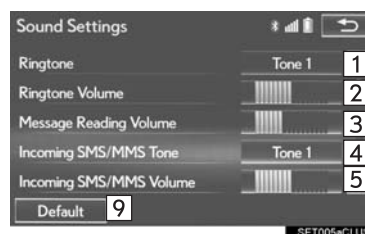

8

PHONE

## 2. SETUP

No.	Function
1	Select to set the desired ringtone.
2	Select “-” or “+” to adjust the ringtone volume.
3	Select “-” or “+” to adjust the message readout volume.
4	Select to set the desired incoming SMS/MMS tone.
5	Select “-” or “+” to adjust the incoming SMS/MMS tone volume.
6	Select to set the desired incoming e-mail tone.
7	Select “-” or “+” to adjust the incoming e-mail tone volume.
8	Select “-” or “+” to adjust the default volume of the other party’s voice.
9	Select to reset all setup items.

### INFORMATION

- Depending on the type of phone, certain functions may not be available.

### “Contact/Call History Settings” SCREEN

The contact can be transferred from a Bluetooth® phone to the system. The contact also can be added, edited and deleted.

The call history can be deleted and contact and favorites can be changed.

- 1 Display the “Phone/Message Settings” screen. (→P.318)
- 2 Select “Contact/Call History Settings”.
- 3 Select the desired item to be set.

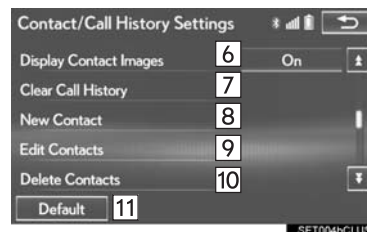
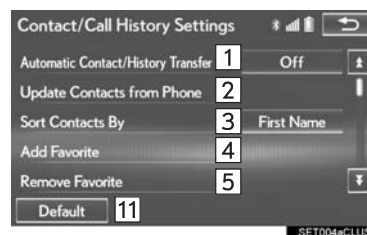



No.	Function	Page
1	For PBAP compatible Bluetooth® phones, select to set automatic contact/history transfer on/off. When set to on, the phone's contact data and history are automatically transferred.	—
2	Select to update contacts from the connected phone.	322
3	Select to sort contacts by the first name or last name field.	—
4	Select to add contacts to the favorites list.	328
5	Select to delete contacts from the favorites list.	330
6	Select to set the transferred contact image display on/off.	—
7*	Select to clear contacts from the call history.	—
8*	Select to add new contacts to the contact list.	325
9*	Select to edit contacts in the contact list.	326
10*	Select to delete contacts from the contact list.	327
11	Select to reset all setup items.	—

\*: For PBAP compatible Bluetooth® phones, this function is available when "Automatic Contact/History Transfer" is set to off. (→P.320)

#### INFORMATION

- Depending on the type of phone, certain functions may not be available.
- Contact data is managed independently for every registered phone. When one phone is connected, another phone's registered data cannot be read.

8

PHONE

### UPDATE CONTACTS FROM PHONE

Operation methods differ between PBAP compatible and PBAP incompatible but OPP compatible Bluetooth® phones.

If your cellular phone is neither PBAP nor OPP compatible, the contacts cannot be transferred.

### ■ FOR PBAP COMPATIBLE Bluetooth® PHONES

- 1 Select "Update Contacts from Phone".
  - Contacts are transferred automatically.
- 2 Check that a confirmation screen is displayed when the operation is complete.
  - This operation may be unnecessary depending on the type of cellular phone.
  - Depending on the type of cellular phone, OBEX authentication may be required when transferring contact data. Enter "1234" into the Bluetooth® phone.
  - If another Bluetooth® device is connected when transferring contact data, depending on the phone, the connected Bluetooth® device may need to be disconnected.
  - Depending on the type of Bluetooth® phone being connected, it may be necessary to perform additional steps on the phone.

■ **FOR PBAP INCOMPATIBLE BUT OPP COMPATIBLE Bluetooth® PHONES**

This operation cannot be performed while driving.

- 1 Select **"Update Contacts from Phone"**.
- 2 Select **"Replace Contacts"** or **"Add Contacts"**.



**"Replace Contacts"**: Select to transfer the contact from the connected cellular phone and replace the current one.

**"Add Contacts"**: Select to transfer the desired contact data from the connected cellular phone to add to the current one.

- 3 Transfer the contact data to the system using a Bluetooth® phone.

- This operation may be unnecessary depending on the type of cellular phone.
- Depending on the type of cellular phone, OBEX authentication may be required when transferring contact data. Enter "1234" into the Bluetooth® phone.
- To cancel this function, select **"Cancel"**.

- 4 Select **"Done"** when it appears on the screen.

- 5 Check that a confirmation screen is displayed when the operation is complete.

8

PHONE

■ **UPDATING THE CONTACTS IN A DIFFERENT WAY (FROM THE “Call History” SCREEN)**

For PBAP compatible Bluetooth® phones, this function is available when “Automatic Contact/History Transfer” is set to off. (→P.320)

- 1 Display the phone top screen. (→P.301)
- 2 Select the “Call History” tab and select a contact not yet registered in the contact list.
- 3 Select “Update Contact”.

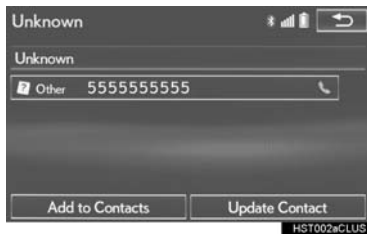

- 4 Select the desired contact.

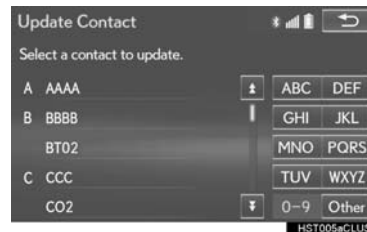

- 5 Select a phone type for the phone number.



### REGISTERING A NEW CONTACT TO THE CONTACT LIST

New contact data can be registered.

Up to 4 numbers per person can be registered. For PBAP compatible Bluetooth® phones, this function is available when "Automatic Contact/History Transfer" is set to off. (→P.320)

- 1 Select **"New Contact"**.
- 2 Enter the name and select **"OK"**.
- 3 Enter the phone number and select **"OK"**.
- 4 Select the phone type for the phone number.



- 5 To add another number to this contact, select **"Yes"**.

### REGISTERING A NEW CONTACT IN A DIFFERENT WAY (FROM THE "Call History" SCREEN)

- 1 Display the phone top screen. (→P.301)
- 2 Select the **"Call History"** tab and select a contact not yet registered in the contact list.
- 3 Select **"Add to Contacts"**.



- 4 Follow the steps in "REGISTERING A NEW CONTACT TO THE CONTACT LIST" from "STEP 2". (→P.325)

8  
PHONE

**EDITING THE CONTACT DATA**

For PBAP compatible Bluetooth® phones, this function is available when “Automatic Contact/History Transfer” is set to off. (→P.320)

- 1 Select “Edit Contacts”.
- 2 Select the desired contact.

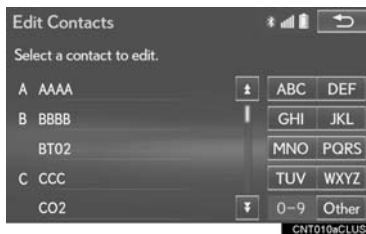

- 3 Select  corresponding to the desired name or number.



► For editing the name

- 4 Follow the steps in “REGISTERING A NEW CONTACT TO THE CONTACT LIST” from “STEP 2”. (→P.325)

► For editing the number

- 4 Follow the steps in “REGISTERING A NEW CONTACT TO THE CONTACT LIST” from “STEP 3”. (→P.325)

### ■ EDITING THE CONTACT IN A DIFFERENT WAY (FROM THE “Contact Details” SCREEN)

- 1 Display the phone top screen. (→P.301)
- 2 Select the “Contacts”, “Call History” tab or the “Favorites” tab and select the desired contact.
- 3 Select “Edit Contact”.

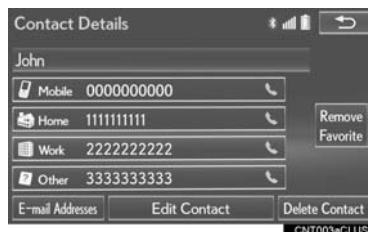

“E-mail Addresses”: Select to display all registered e-mail addresses for the contact.

- 4 Follow the steps in “EDITING THE CONTACT DATA” from “STEP 4”. (→P.326)

### DELETING THE CONTACT DATA

For PBAP compatible Bluetooth® phones, this function is available when “Automatic Contact/History Transfer” is set to off. (→P.320)

- 1 Select “Delete Contacts”.
- 2 Select the desired contact and select “Delete”.



- 3 Select “Yes” when the confirmation screen appears.

#### INFORMATION

- Multiple data can be selected and deleted at the same time.

### ■ DELETING THE CONTACT IN A DIFFERENT WAY (FROM THE “Contact Details” SCREEN)

- 1 Display the phone top screen. (→P.301)
- 2 Select the “Contacts”, “Call History” tab or the “Favorites” tab and select the desired contact.
- 3 Select “Delete Contact”.

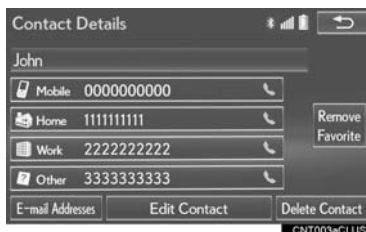

- 4 Select “Yes” when the confirmation screen appears.

#### INFORMATION

- When a Bluetooth® phone is deleted, the contact data will be deleted at the same time.

### ■ FAVORITES LIST SETTING

Up to 15 contacts (maximum of 4 numbers per contact) can be registered in the favorites list.

### ■ REGISTERING THE CONTACTS IN THE FAVORITES LIST

- 1 Select “Add Favorite”.
- 2 Select the desired contact to add to the favorites list.

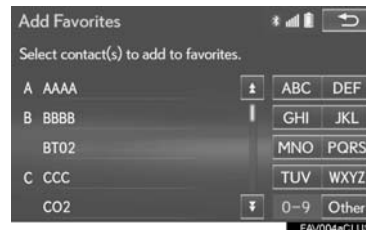

- Dimmed contacts are already stored as a favorite.
- 3 Check that a confirmation screen is displayed when the operation is complete.



► When 15 contacts have already been registered to the favorites list

1 When 15 contacts have already been registered to the favorites list, a registered contact needs to be replaced. Select **“Yes”** when the confirmation screen appears to replace a contact.

2 Select the contact to be replaced.

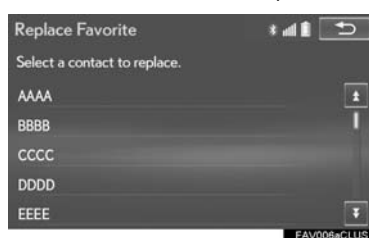

3 Check that a confirmation screen is displayed when the operation is complete.

► Registering contacts in the favorites list in a different way (from the “Contacts” screen)

1 Display the phone top screen. (→P.301)

2 Select the **“Contacts”** tab.

3 Select ☆(grey) at the beginning of the desired contact list name to be registered in the favorites list.

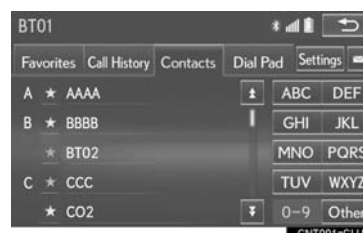

● When selected, ☆(grey) is changed to ★(yellow), and the contact is registered in the favorites list.

## 2. SETUP

▶ Registering contacts in the favorites list in a different way (from the “Contact Details” screen)

- 1 Display the phone top screen. (→P.301)
- 2 Select the “Contacts” tab or the “Call History” tab and select the desired contact.
- 3 Select “Add Favorite”.

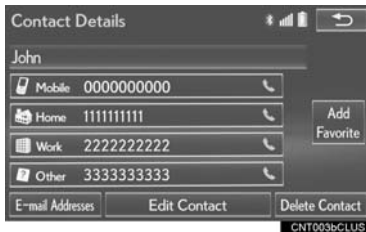

- 4 Check that a confirmation screen is displayed when the operation is complete.

### ■ DELETING THE CONTACTS IN THE FAVORITES LIST

- 1 Select “Remove Favorite”.
- 2 Select the desired contacts and select “Remove”.



- 3 Select “Yes” when the confirmation screen appears.
- 4 Check that a confirmation screen is displayed when the operation is complete.

- ▶ Deleting contacts in the favorites list in a different way (from the “Contacts” screen)

- 1 Display the phone top screen. (→P.301)
- 2 Select the “**Contacts**” tab.
- 3 Select ★(yellow) at the beginning of the contact list name to be deleted from the favorites list.

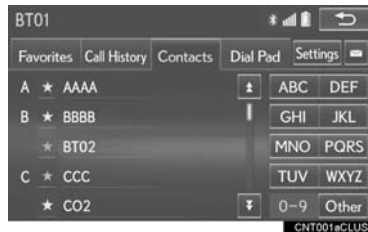

- When selected, ★(yellow) is changed to ☆(grey), and the data is deleted from the list.

- ▶ Deleting contacts in the favorites list in a different way (from the “Contact Details” screen)

- 1 Display the phone top screen. (→P.301)
- 2 Select the “**Contacts**”, “**Call History**” tab or the “**Favorites**” tab and select the desired contact to delete.
- 3 Select “**Remove Favorite**”.

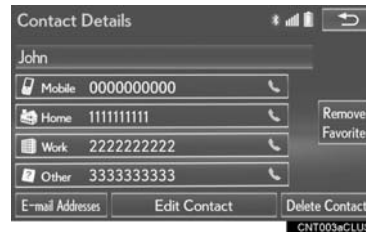

- 4 Select “**Yes**” when the confirmation screen appears.
- 5 Check that a confirmation screen is displayed when the operation is complete.

## 2. SETUP

### “Messaging Settings” SCREEN

- 1 Display the “Phone/Message Settings” screen. (→P.318)
- 2 Select “Messaging Settings”.
- 3 Select the desired item to be set.

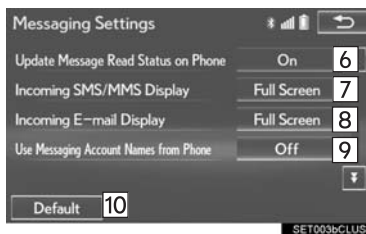

No.	Function
1	Select to set automatic message transfer on/off.
2	Select to set automatic message readout on/off.
3	Select to set the SMS/MMS notification popup on/off.
4	Select to set the e-mail notification popup on/off.
5	Select to set adding the vehicle signature to outgoing messages on/off.
6	Select to set updating message read status on phone on/off.
7	Select to change the incoming SMS/MMS display. <b>“Full Screen”</b> : When an SMS/MMS message is received, the incoming SMS/MMS display screen is displayed and can be operated on the screen. <b>“Drop-Down”</b> : When an SMS/MMS message is received, a message is displayed on the upper side of the screen.
8	Select to change the incoming e-mail display. <b>“Full Screen”</b> : When an e-mail is received, the incoming e-mail display screen is the displayed and can be operated on the screen. <b>“Drop-Down”</b> : When an e-mail is received, a message is displayed on the upper side of the screen.
9	Select to set display of messaging account names on the inbox tab on/off. When set to on, messaging account names used on the cellular phone will be displayed.
10	Select to reset all setup items.

**INFORMATION**

- Depending on the phone, these functions may not be available.

**DISPLAYING THE “Messaging Settings” SCREEN IN A DIFFERENT WAY**

- 1 Display the phone top screen. (→P.301)
- 2 Select “Settings”.

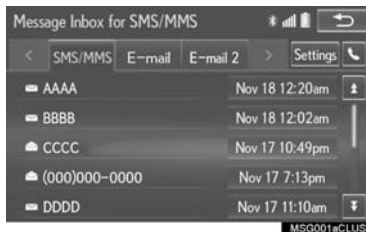

- 3 Select “Messaging Settings”.

**“Phone Display Settings” SCREEN**

- 1 Display the “Phone/Message Settings” screen. (→P.318)
- 2 Select “Phone Display Settings”.
- 3 Select the desired item to be set.

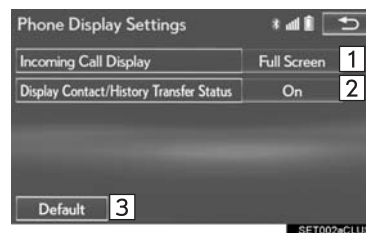

No.	Function
1	Select to change the incoming call display. “Full Screen”: When a call is received, the hands-free screen is displayed and can be operated on the screen. “Drop-Down”: A message is displayed on the upper side of the screen and can only be operated via the steering wheel switches.
2	Select to set display of the contact/history transfer completion message on/off.
3	Select to reset all setup items.

8  
PHONE**INFORMATION**

- Depending on the phone, these functions may not be available.

### 3. WHAT TO DO IF...

## 1. TROUBLESHOOTING

If there is a problem with the hands-free system or a Bluetooth® device, first check the table below.

► When using the hands-free system with a Bluetooth® device

Symptom	Likely cause	Solution	Page	
			Cellular phone	This system
The hands-free system or Bluetooth® device does not work.	The connected device may not be a compatible Bluetooth® cellular phone.	For a list of specific devices which operation has been confirmed on this system, check with your Lexus dealer or the following website: <a href="http://www.lexus.com/MobileLink">http://www.lexus.com/MobileLink</a>	*	—
	The Bluetooth® version of the connected cellular phone may be older than the specified version.	Use a cellular phone with Bluetooth® version 2.0 or higher (recommended: Ver. 3.0 +EDR or higher).	*	52

## ► When registering/connecting a cellular phone

Symptom	Likely cause	Solution	Page	
			Cellular phone	This system
A cellular phone cannot be registered.	An incorrect passcode was entered on the cellular phone.	Enter the correct passcode on the cellular phone.	*	—
	The registration operation has not been completed on the cellular phone side.	Complete the registration operation on the cellular phone (approve registration on the phone).	*	—
	Old registration information remains on either this system or the cellular phone.	Delete the existing registration information from both this system and the cellular phone, then register the cellular phone you wish to connect to this system.	*	59
A Bluetooth® connection cannot be made.	Another Bluetooth® device is already connected.	Manually connect the cellular phone you wish to use to this system.	—	60
	Bluetooth® function is not enabled on the cellular phone.	Enable the Bluetooth® function on the cellular phone.	*	—
	Automatic Bluetooth® connection on this system is set to off.	Set automatic Bluetooth® connection on this system to on when the engine <power> switch is in ACCESSORY or IGNITION ON <ON> mode.	—	65

### 3. WHAT TO DO IF...

Symptom	Likely cause	Solution	Page	
			Cellular phone	This system
"Unable to dial. Please check your phone." message is displayed.	Bluetooth® function is not enabled on the cellular phone.	Enable the Bluetooth® function on the cellular phone.	*	—
	Old registration information remains on either this system or the cellular phone.	Delete the existing registration information from both this system and the cellular phone, then register the cellular phone you wish to connect to this system.	*	59

▶ When making/receiving a call

Symptom	Likely cause	Solution	Page	
			Cellular phone	This system
A call cannot be made/received.	Your vehicle is in a "No Service" area.	Move to where "No Service" no longer appears on the display.	—	—



## ► When using the phonebook

Symptom	Likely cause	Solution	Page	
			Cellular phone	This system
Phonebook data cannot be transferred manually/automatically.	The profile version of the connected cellular phone may not be compatible with transferring phonebook data.	For a list of specific devices which operation has been confirmed on this system, check with your Lexus dealer or the following website: <a href="http://www.lexus.com/MobileLink">http://www.lexus.com/MobileLink</a>	*	—
	Automatic contact transfer function on this system is set to off.	Set automatic contact transfer function on this system to on.	—	320
	Passcode has not been entered on the cellular phone.	Enter the passcode on the cellular phone if requested (default passcode: 1234).	*	—
	Transfer operation on the cellular phone has not completed.	Complete transfer operation on the cellular phone (approve transfer operation on the phone).	*	—
Phonebook data cannot be edited.	Automatic contact transfer function on this system is set to on.	Set automatic contact transfer function on this system to off.	—	320

### 3. WHAT TO DO IF...

#### ► When using the Bluetooth® message function

Symptom	Likely cause	Solution	Page	
			Cellular phone	This system
Messages cannot be viewed.	Message transfer is not enabled on the cellular phone.	Enable message transfer on the cellular phone (approve message transfer on the phone).	*	—
	Automatic transfer function on this system is set to off.	Set automatic transfer function on this system to on.	—	332
New message notifications are not displayed.	Notification of SMS/MMS/E-mail reception on this system is set to off.	Set notification of SMS/MMS/E-mail reception on this system to on.	*	332
	Automatic message transfer function is not enabled on the cellular phone.	Enable automatic transfer function on the cellular phone.	*	—

#### ► In other situations

Symptom	Likely cause	Solution	Page	
			Cellular phone	This system
The Bluetooth® connection status is displayed at the top of the screen each time the engine <power> switch is in ACCESSORY or IGNITION ON <ON> mode.	Connection confirmation display on this system is set to on.	To turn off the display, set connection confirmation display on this system to off.	—	64

Symptom	Likely cause	Solution	Page	
			Cellular phone	This system
Even though all conceivable measures have been taken, the symptom status does not change.	The cellular phone is not close enough to this system.	Bring the cellular phone closer to this system.	—	—
	Radio interference has occurred.	Turn off Wi-Fi® devices or other devices that may emit radio waves.	—	—
	The cellular phone is the most likely cause of the symptom.	Turn the cellular phone off, remove and reinstall the battery pack, and then restart the cellular phone.	*	—
		Enable the cellular phone's Bluetooth® connection.	*	—
		Disable the Wi-Fi® connection of the cellular phone.	*	—
		Stop the cellular phone's security software and close all applications.	*	—
		Before using an application installed on the cellular phone, carefully check its source and how its operation might affect this system.	*	—

8  
PHONE

\*: For details, refer to the owner's manual that came with the cellular phone.

### 3. WHAT TO DO IF...

# 9

## LEXUS ENFORM

### 1 LEXUS ENFORM-OVERVIEW

1. FUNCTIONAL OVERVIEW ..... 342  
LEXUS Enform Remote ..... 343  
LEXUS Enform Service Connect ..... 343
2. TYPE A: FUNCTION ACHIEVED BY USING A CELLULAR PHONE ..... 344  
BEFORE USING THE FUNCTION ..... 345  
PREPARATION BEFORE USING LEXUS App Suite ..... 346
3. TYPE B: FUNCTION ACHIEVED BY USING DCM AND THE NAVIGATION SYSTEM ..... 347  
BEFORE USING THE FUNCTION ..... 348
4. TYPE C: FUNCTION ACHIEVED BY USING DCM ..... 350

### 2 LEXUS ENFORM OPERATION

1. LEXUS Enform Remote ..... 351
2. LEXUS Enform Service Connect ..... 352
3. LEXUS App Suite ..... 353  
USING LEXUS App Suite ..... 353  
LINKING LEXUS App Suite AND NAVIGATION SYSTEM LOCAL FUNCTION ..... 358  
ENTERING KEYWORD OPERATION ..... 361
4. LEXUS Enform Destinations ..... 363  
Destination Assist ..... 363  
eDestination ..... 364
5. Lexus Insider ..... 369  
NEW MESSAGE NOTIFICATION ..... 369  
VIEWING AND PLAYING RECEIVED Lexus Insider MESSAGES ..... 369

### 3 SETUP

1. LEXUS App Suite SETTINGS ..... 373  
SCREEN FOR LEXUS App Suite SETTINGS ..... 373

LEXUS Enform connected services consists of five products:

- LEXUS Enform Safety Connect
- LEXUS Enform Service Connect
- LEXUS Enform Remote
- LEXUS Enform Destinations
- LEXUS Enform App Suite

For availability and to learn more, visit <http://www.lexus.com/enform/>.

## 1. LEXUS ENFORM-OVERVIEW

### 1. FUNCTIONAL OVERVIEW

Lexus Enform is a service that includes Safety Connect, Service Connect, Remote, Destinations, Insider and App Suite.

- The functions included in Lexus Enform are classified into the following three types.
  - Type A: Function achieved by using a cellular phone
  - Type B: Function achieved by using an embedded cellular device in the vehicle (DCM: Data Communication Module) and the navigation system
  - Type C: Function achieved by using DCM

Function	Type
LEXUS App Suite	Type A
LEXUS Enform Destinations (Destination Assist, eDestination)	Type B
Lexus Insider	Type B
LEXUS Enform Safety Connect	Type C

- Each function is available in the following areas:
  - LEXUS App Suite is available in the contiguous United States, Washington D.C. and Alaska.
  - LEXUS Enform Destinations is available in the contiguous United States, Washington D.C. and limited areas of Alaska for vehicles that contain the appropriate map data.
  - Lexus Insider is available in the contiguous United States, Washington D.C. and Alaska.
  - LEXUS Enform Safety Connect features include:
    - Automatic Collision Notification, Emergency Assistance, Stolen Vehicle Location (available in the contiguous United States, Washington D.C., Hawaii, Alaska, and Canada) and Enhanced Roadside Assistance (available in the contiguous United States, Washington D.C., Alaska, and Canada).

#### (INFORMATION)

- Availability of functions of the Lexus Enform service is dependent on network reception level.

### LEXUS Enform Remote

LEXUS Enform Remote is a cellular phone application that lets you view and remotely control certain aspects of your vehicle.

For details about the functions and services of this application, refer to <http://www.lexus.com/enform/>.

- Function of the LEXUS Enform Remote is achieved by using an embedded cellular device in the vehicle (DCM: Data Communication Module).
- Lexus Enform Remote is available in the contiguous United States, Washington D.C. and Alaska.

### LEXUS Enform Service Connect

Lexus Enform Service Connect uses embedded telematics hardware to collect and transmit vehicle data that allows Lexus to provide:

- Vehicle Health Report (VHR)  
(Safety Recalls, Service Campaigns, Current Vehicle Alerts, Required Maintenance, and Vehicle Condition Status)
- Maintenance Notifications
- Vehicle Alert Notifications

For details about this service and how to register, refer to <http://www.lexus.com/enform/>.

- The Lexus Enform Service Connect is achieved by using a Data Communication Module (DCM) built into the vehicle.
- Lexus Enform Service Connect is available in the contiguous United States, Washington D.C., Hawaii, Alaska, and Canada.

## 1. LEXUS ENFORM-OVERVIEW

### 2. TYPE A: FUNCTION ACHIEVED BY USING A CELLULAR PHONE

Of the functions included with Lexus Enform, the App Suite relies on the use of a cellular phone. App Suite enables applicable apps installed on a cellular phone to be displayed on and operated from the navigation screen via a Bluetooth®. A few settings must be performed before App Suite can be used. (→P. 346)

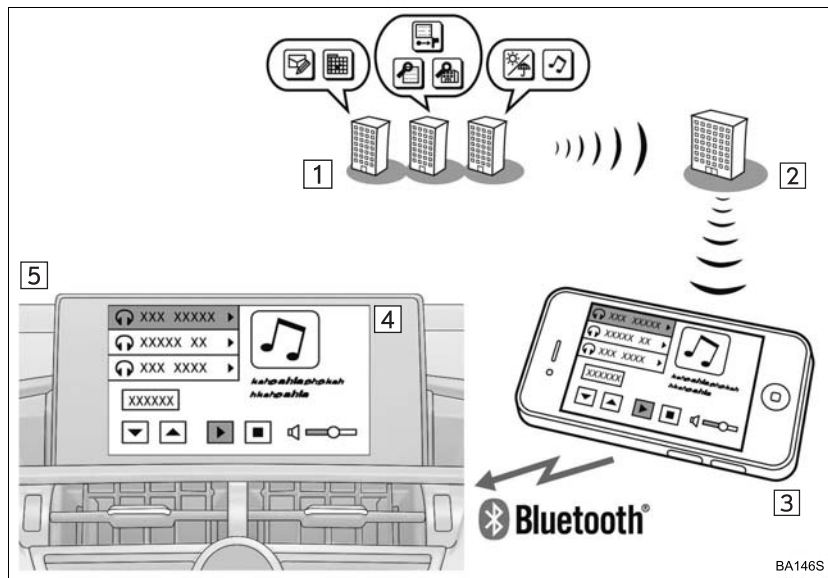

No.	Name	Function
1	Content provider	Provides contents to the navigation system via a cellular phone.
2	Application server	Provides applications to the navigation system via a cellular phone.
3	Cellular phone*	Using the App Suite, communication is relayed between the navigation system, application server and contents provider. The cellular phone cannot be operated while communicating.
4	Applications	Display usable content from the content providers on the screen using the data connection of the connected cellular phone.
5	Navigation system	Content received, via a cellular phone, from content provider servers is displayed on the navigation screen. The navigation system is equipped with an application player to run applications.

\*: For known compatible phones, refer to <http://www.lexus.com/MobileLink>.



## BEFORE USING THE FUNCTION

### SUBSCRIPTION

- User registration is required to start using the App Suite function. (→P. 346)
- App Suite does not require an activation fee or monthly recurring fees.
- Services requiring a separate contract can also be used.\*

\*: For details, refer to <http://www.lexus.com/enform/> or call 1-800-255-3987.

### AVAILABILITY OF FUNCTION

- LEXUS App Suite is available in the contiguous United States, Washington D.C. and Alaska.

#### INFORMATION

- Data usage fees may apply while using App Suite function. Confirm data usage fees before using this function.
- The required operations to activate applications and connect a cellular phone to the navigation system, and the registration steps for the App Suite are explained in this section. For details regarding operation of the App Suite and the applications, refer to <http://www.lexus.com/enform/>.
- Availability of functions of the Lexus Enform service is dependent on network reception level.

## INITIALIZING PERSONAL DATA

The personal data used in applications can be reset. (→P. 72)

- The following personal data can be deleted and returned to their default settings:
  - Downloaded contents
  - Radio stations that were listened to
  - Input history

#### INFORMATION

- Once initialized, data will be erased. Pay close attention when initializing data.

### PREPARATION BEFORE USING LEXUS App Suite

#### SETTINGS REQUIRED TO USE LEXUS App Suite

Perform the settings in the following order.

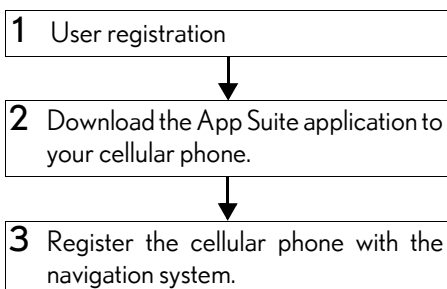

In order to use App Suite, the following must first be performed:

- User registration with the service (→P. 346)
- Download the App Suite application onto your cellular phone, and login to the application. (→P. 346)
- Register the cellular phone, on which the App Suite application was installed, with the navigation system. (→P. 346)
- Register a Bluetooth® phone with the hands-free system. (→P. 48)

### USER REGISTRATION

- 1 Perform user registration at <http://www.lexus.com/enform> or register within the App Suite application after you download it onto your cellular phone.

### REGISTERING THE LEXUS App Suite APPLICATION

- 1 Download the App Suite application to your cellular phone.
- 2 Run the App Suite application on your cellular phone.
- 3 Enter the information required into the App Suite application. Login to the application.

#### INFORMATION

- Applications can only be used when the App Suite application has been downloaded to your cellular phone and the application is running.
- App Suite operational procedures can also be confirmed by visiting <http://www.lexus.com/enform/>.
- In order to use applications, it is necessary to run the App Suite application on your cellular phone.
- If an iPhone is connected via Bluetooth® and USB at the same time, system operation may become unstable. For known phone compatibility information, refer to <http://www.lexus.com/enform/>.
- If a App Suite application is used while iPod audio/video is being played back, system operation may become unstable.

## 1. LEXUS ENFORM-OVERVIEW

### 3. TYPE B: FUNCTION ACHIEVED BY USING DCM AND THE NAVIGATION SYSTEM

The functionality of Lexus Enform Safety Connect, Lexus Enform Destinations, and Lexus Insider is made possible through the shared work of the DCM and the navigation system.

These are subscription-based telematics services that use Global Positioning System (GPS) data and embedded cellular technology to provide safety and security as well as convenience features.

These services are available by subscription on select, telematics hardware-equipped vehicles and supported by Lexus' designated response center, which operates 24 hours a day, 7 days a week.

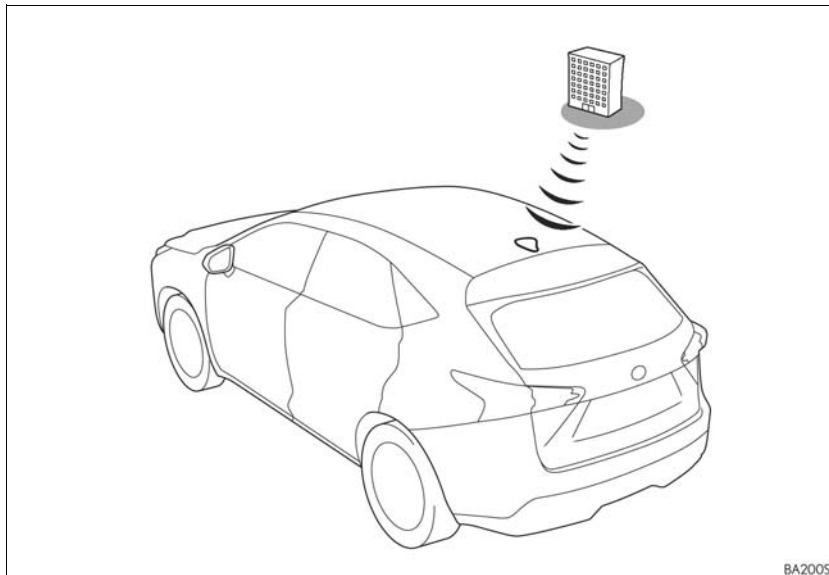

9

LEXUSENFORM

# 1. LEXUS ENFORM-OVERVIEW

## BEFORE USING THE FUNCTION

### SUBSCRIPTION

- After you have signed the Telematics Subscription Service Agreement and are enrolled, you can begin receiving services. A variety of subscription terms are available. Contact your Lexus dealer or call 1-800-25-LEXUS (1-800-255-3987) for further subscription details. (→P. 363)

### AVAILABILITY OF FUNCTION(S)

- Destinations is available in the contiguous United States, Washington D.C. and limited areas of Alaska for vehicles that contain the appropriate map data.
- Lexus Insider is available in the contiguous United States, Washington D.C. and Alaska.

## ACTIVATION OF FUNCTION(S)

- Enrollment in Lexus Enform Safety Connect (via your dealership) is required to activate all functions.

- Certification for Lexus Enform Safety Connect

FCC ID: O6Y-CDMRF101 FCC ID: XOECDMRF101B FCC ID: N7NGTM2
---

**FCC WARNING**  
This equipment complies with FCC radiation exposure limits set forth for an uncontrolled environment and meets the FCC radio frequency (RF) Exposure Guidelines in Supplement C to OET65.  
This equipment should be installed and operated keeping the radiator at least 20cm or more away from person's body (excluding extremities: hands, wrists, feet and ankles).

**INFORMATION**

- Exposure to radio frequency signals:  
The Lexus Enform system installed in your vehicle includes a low power radio transmitter and receiver. The system receives and also sends out radio frequency (RF) signals.
- In August 1996, the Federal Communications Commission (FCC) adopted RF exposure guidelines with safety levels for mobile wireless phones. Those guidelines are consistent with the safety standards previously set by both U.S. and international standards bodies.
  - ANSI (American National Standards Institute) C95.1 [1992]
  - NCRP (National Council on Radiation Protection and Measurement) Report 86 [1986]
  - ICNIRP (International Commission on Non-Ionizing Radiation Protection) [1996]
- These standards are based on comprehensive and periodic evaluations of the relevant scientific literature. Over 120 scientists, engineers, and physicians from universities, government health agencies, and industry reviewed the available body of research to develop the ANSI Standard (C95.1).
- The design of Lexus Enform system complies with the FCC guidelines in addition to those standards.

**INFORMATION**

- Contact with the Lexus response center is dependent upon the telematics device being in operative condition, cellular connection availability, navigation map data, and GPS satellite signal reception, which can limit the ability to reach the response center or receive support. Enrollment and Telematics Subscription Service Agreement required. A variety of subscription terms are available; charges vary by subscription term selected.
- The Lexus response center offers support in multiple languages.
- Select Lexus Enform Safety Connect-subscribed vehicles are capable of communicating vehicle information. Please see the terms and conditions for additional details.  
Owners who do not wish to have their vehicle transmit this information can opt out at the time of enrollment or by calling 1-800-255-3987 and following the prompts for Lexus Enform Safety Connect.
- For further details about the service, contact your Lexus dealer.
- Lexus Enform functions are not subject to section 255 of the Telecommunications Act and the system is not TTY compatible.

## 1. LEXUS ENFORM-OVERVIEW

### 4. TYPE C: FUNCTION ACHIEVED BY USING DCM

The functionality of Lexus Enform Safety Connect is made possible by the use of a DCM.

For details, refer to "Owner's Manual".

## 2. LEXUS ENFORM OPERATION

### 1. LEXUS Enform Remote

For details about the functions and services provided by this app, refer to <http://www.lexus.com/enform/>.

#### SUBSCRIPTION

- After you sign the Telematics Subscription Service Agreement (see the LEXUS Enform Safety Connect section in "Owner's Manual"), download the LEXUS Enform Remote app from your cellular phone's app store, and register within the app (or enroll and complete registration at the dealer), you can begin using these services.
- A variety of subscription terms are available. Contact your Lexus dealer, or call 1-800-25-LEXUS (1-800-255-3987) for further subscription details.

#### AVAILABILITY OF FUNCTION

- Lexus Enform Remote is available in the contiguous United States, Washington D.C., and Alaska.

#### INFORMATION

- Lexus Enform Remote should only be used by authorized users.
- Laws in some communities may require that the vehicle be within view of the user when operating Lexus Enform Remote.  
In some states, use of Lexus Enform Remote may violate state or local laws. Before using Lexus Enform Remote, check your state and local laws.
- Any malfunction of the Lexus should be repaired by your Lexus dealer.
- Lexus Enform Remote is designed to work at temperatures above -22 °F (-30 °C). This specification is related to the Lexus Enform Remote operation, but is dependent on the vehicle's operating temperature range which may be different.
- Content is subject to change without notice.
- Some features of the Lexus Enform Remote may not be available on some models.
- Additional information can be found at [www.lexus.com/enform/](http://www.lexus.com/enform/).

## 2. LEXUS ENFORM OPERATION

### 2. LEXUS Enform Service Connect

For details about this service and how to register, refer to <http://www.lexus.com/enform/>.

#### AVAILABILITY OF FUNCTION

- Lexus Enform Service Connect is available in the contiguous United States, Washington D.C., Hawaii, Alaska, and Canada.

#### INFORMATION

- Availability of functions of the Lexus Enform Service Connect is dependent on network reception level.



## 2. LEXUS ENFORM OPERATION

### 3. LEXUS App Suite

#### USING LEXUS App Suite

App Suite is a function that enables applicable apps installed on a cellular phone to be displayed on and operated from the navigation screen. Before App Suite can be used, a few settings need to be performed. (→P. 346)

For details about the functions and services provided by each application, refer to <http://www.lexus.com/enform/>.

- 1 Press the “MENU” button on the Remote Touch.

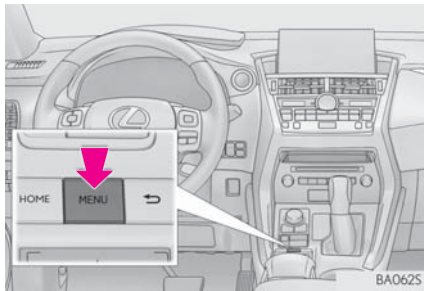

- 2 Select “LEXUS App Suite”.



- 3 Select the desired application screen button.

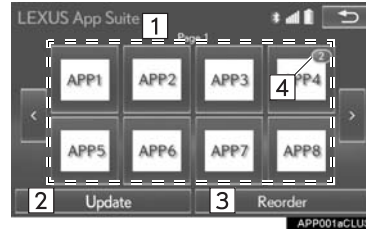

No.	Function	Page
1	Select to activate an application.	—
2	Select to update the applications.	354
3	Select to change the order of the applications.	356
4	Displays the number of new notifications for the application	—

9

LEXUSENFORM

**UPDATING AN APPLICATION**

When App Suite is activated, an application may need to be updated. By updating the application, it can be kept to the latest version. To update an application, it is necessary to download update data and install it.

**DOWNLOADING UPDATE**

If an update is available, "Update" can be selected.

1 Select "Update".



2 Check that downloading starts.

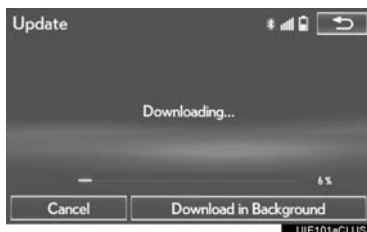

"Download in Background": Select to operate other functions while downloading.

"Cancel": Select to cancel updating.

3 Check that downloading is complete.

► From the "Update" screen

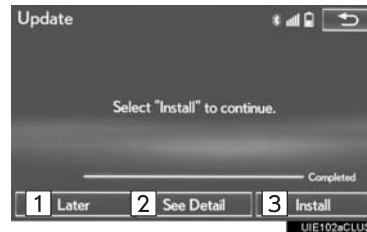

► From other screens

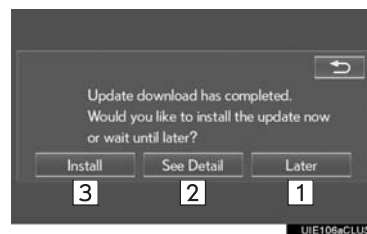

No.	Function
1	Select to install later. When this screen button is selected, the screen will return to the last displayed screen. To install the update data: →P. 355
2	Select to display detailed information on the update data.
3	Select to install the update data. Follow the steps "INSTALLING THE UPDATE DATA" from "STEP 2". (→P. 355)

■ INSTALLING THE UPDATE DATA

After the downloading is complete, "Update" will be changed to "Install".

1 Select "Install".



2 Select "Continue".



"Later": Select to postpone the installation of the update data and go back to the previous screen.

3 Check that installing is started.

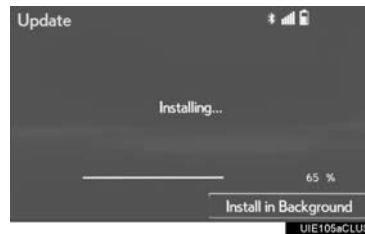

"Install in Background": Select to operate other function while installing.

4 Select "OK" after the installing is complete.

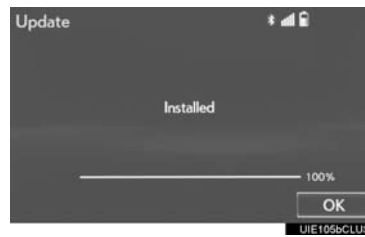

INFORMATION

- The App Suite function cannot be operated while installing.

## REORDERING THE APPLICATIONS

Order of the applications can be changed.

- 1 Display the "LEXUS App Suite" screen. (→P. 353)
- 2 Select "Reorder".



- 3 Select the desired application to be moved.



- 4 Select "<<" or ">>" to move the application, and select "OK".

## IF A MESSAGE APPEARS ON THE SCREEN

When problems occur with starting the application player, a message will appear on the screen. Referring to the table below, identify the problem and take the suggested corrective action.

Message	Display conditions	Corrective action
"This feature is unavailable during an emergency call."	Safety Connect is being implemented.	After the Safety Connect call is finished, perform the operation again.
"This feature is unavailable while transferring contacts."	Contacts are being transferred manually from the phonebook.	When the transfer of contacts is complete, perform the operation again.
"Unable to connect to a Bluetooth* phone. For troubleshooting assistance, please visit the Lexus website or contact your dealer."	The cellular phone cannot be connected.	Refer to <a href="http://www.lexus.com/enform/">http://www.lexus.com/enform/</a> to confirm if the phone is compatible or not.
"This feature is unavailable during a handsfree call."	A hands-free call is in progress.	After the hands-free call is finished, perform the operation.
"To use the services, an active application needs to be running on your phone. For more information, please visit <a href="http://lexus.com">lexus.com</a> ."	The LEXUS App Suite application cannot be connected to Bluetooth® SPP.	Refer to <a href="http://www.lexus.com/enform/">http://www.lexus.com/enform/</a> to confirm if the phone is Bluetooth® SPP compatible or not, and then activate the App Suite application.
"Communication error. Please try again."	Communication was disconnected.	After a few moments, retry the operation.

\*: Bluetooth is a registered trademark of Bluetooth SIG, Inc.

## 2. LEXUS ENFORM OPERATION

### LINKING LEXUS App Suite AND NAVIGATION SYSTEM LOCAL FUNCTION

The setting a destination and making a hands-free call functions of the navigation system can be performed via App Suite. For details about the functions and services provided by each application, refer to <http://www.lexus.com/enform/>.

- 1 Press the "MENU" button on the Remote Touch.

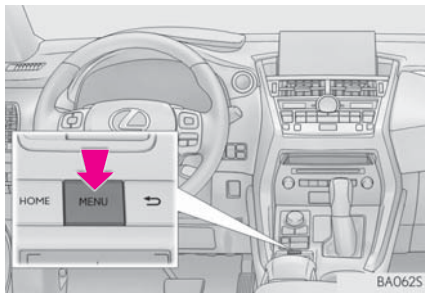

- 2 Select "Nav".



- 3 Select "Dest.".



- 4 Select "Web Search".



- 5 Check that the "Web Search" screen is displayed.

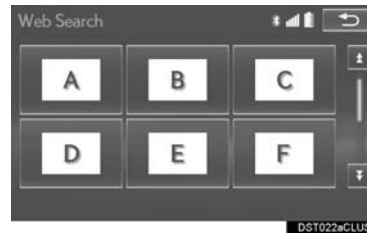

**SETTING A DESTINATION USING LEXUS App Suite**

Locations that were searched for using the App Suite can be set as a destination.

- 1 Display the "Web Search" screen. (→P. 358)
- 2 Select the desired application screen button to perform search.

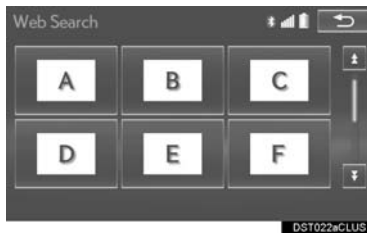

- 3 Enter a search term, and select "Go".



- 4 Select "Map".



- 5 Select "Go to" icon.



- 6 Select "OK" to start guidance.



- For the operation of the route guidance screen and the function of each screen button: →P. 121

## 2. LEXUS ENFORM OPERATION

### MAKING A PHONE CALL USING LEXUS App Suite

Phone calls can be made to locations which were searched for using App Suite.

- 1 Display the "Web Search" screen. (→P. 358)
- 2 Select the desired application screen button to perform search.



- 3 Enter a search term, and select "Go".



- 4 Select "Call".



- 5 Select "Yes".

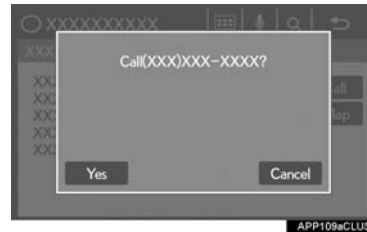

**"Cancel"**: Select to cancel making a phone call.

- 6 Check that the "Call" screen is displayed.



- For phone operation and the function of each screen button: →P. 308



**ENTERING KEYWORD OPERATION**

A keyword can be entered to an application by the software keyboard or voice recognition function. For details about the functions and services provided by each application, refer to <http://www.lexus.com/enform/>.

- The keyboard layout can be changed. (→P. 66)

**ENTERING A KEYWORD USING THE SOFTWARE KEYBOARD**

- 1 Display the "LEXUS App Suite" screen. (→P. 353)
- 2 Select the desired application screen button.



- 3 Select the character entering space.

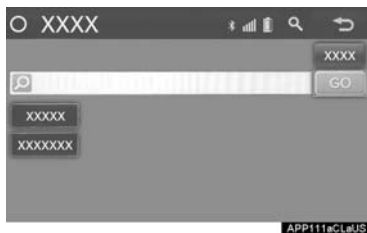

- 4 Enter a search term, and then select "OK".

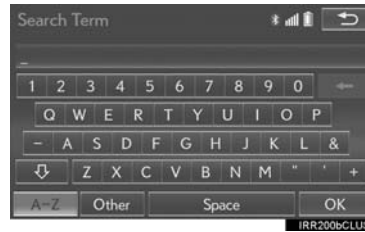

- 5 Entering characters will be reflected on the character entering space.

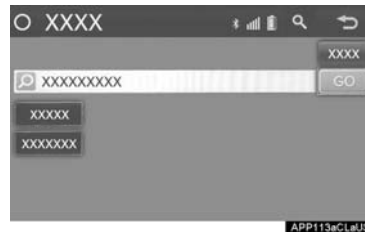

- For details on operating the keyboard: →P. 41



## 2. LEXUS ENFORM OPERATION

### 4. LEXUS Enform Destinations

#### Destination Assist

Destinations provide you with live assistance for finding destinations via the Lexus response center. You can request either a specific business, address, or ask for help locating your desired destination by category, such as restaurants, gas stations, shopping centers or other Points of Interest (POI).

After you tell the agent your choice of destination, its coordinates are sent wirelessly to your vehicle's navigation system.

#### MAKE A CALL WITH Destination Assist

- 1 Press the "MENU" button on the Remote Touch.

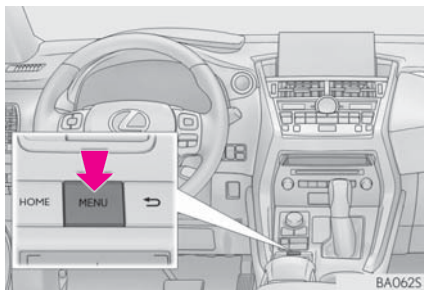

- 2 Select "Nav".

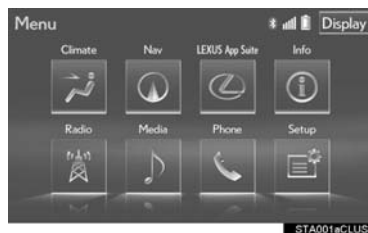

- 3 Select "Dest.".



- 4 Select "Destination Assist".



- 5 When an agent comes on the line, tell the agent the address, business name, or the type of POI or service.

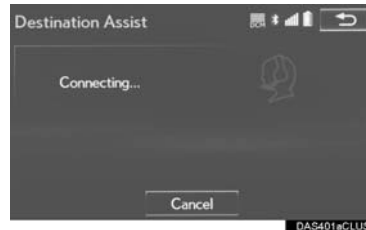

9

LEXUSENFORM

To adjust the volume of a received call: Use the volume control switch on the steering wheel.

- To hang up the phone, select "Disconnect" or press the  switch on the steering wheel.

## 2. LEXUS ENFORM OPERATION

- 6 After the agent helps you determine your location of choice, this screen is displayed. Select the screen button of the desired action.

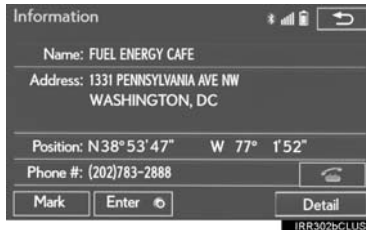

**“Mark”**: Select to mark the POI on the map screen.

**“Enter”** (with location pin icon): Select to set as a destination.

**“Detail”**: Select to display detailed information.

- If the phone icon is selected, the registered phone number can be called.

### eDestination

With the eDestination feature, you can go online, and via the Lexus.com owner's Web site, select and organize destinations of your choice and then wirelessly send them to your vehicle's navigation system. Up to 200 locations can be stored online and accessed or updated at any time.

- Locations can be organized into up to 20 personalized folders.

#### (INFORMATION)

- You must first go online at [www.lexus.com/drivers/](http://www.lexus.com/drivers/) to view the Owners site where you will need to register and log in. After this, personalized folders that contain the locations to be sent to your vehicle can be created. (See Lexus Enform Guide for more information.)

**DOWNLOADING eDestinations**

After updating eDestination folders online, it is necessary to download the updated data to the vehicle.

- 1 Press the "MENU" button on the Remote Touch.

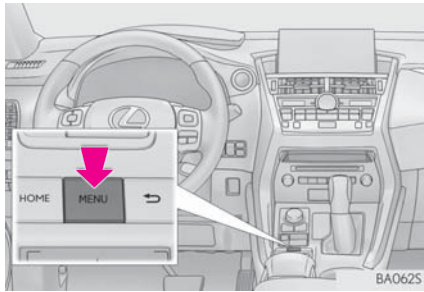

- 2 Select "Nav".



- 3 Select "Dest.".



- 4 Select "Point of Interest".



- 5 Select "eDestination".



- 6 Select "Download".



9 LEXUSENFORM

## 2. LEXUS ENFORM OPERATION

- 7 Select **"Yes"** when the confirmation screen appears.
- 8 Check that downloading starts.

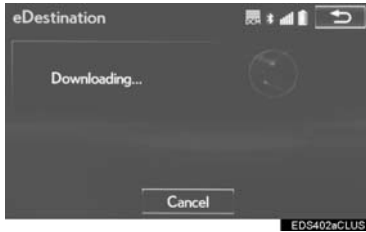

- The most recent Destinations data will be loaded to the navigation system.

### SEARCHING eDestinations

- 1 Press the **"MENU"** button on the Remote Touch.

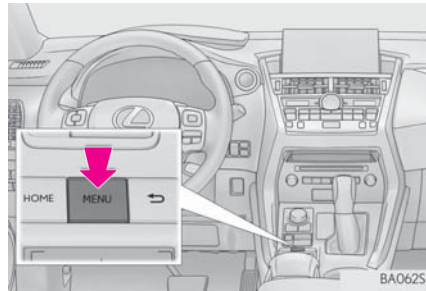

- 2 Select **"Nav"**.



- 3 Select **"Dest."**.



4 Select "Point of Interest".



5 Select "eDestination".



6 Select the desired eDestination category.



7 Select the desired location.



8 Select the button of the desired action.

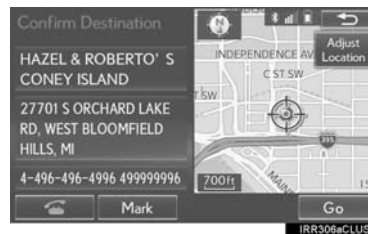

"Mark": Select to mark the POI on the map screen.  
 "Go": Select to set the POI as a destination with route directions.

- If  is selected, the registered phone number can be called.

9

LEXUSENFORM

## 2. LEXUS ENFORM OPERATION

### DISPLAYING eDestination ICONS

1 Select "Options".



2 Select "Map Information".



3 Select "eDestination".

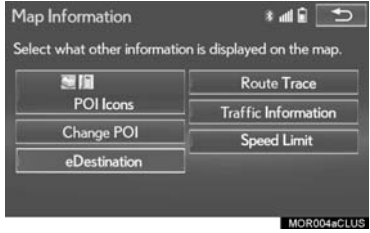

● The "eDestination" indicator will illuminate.



## 2. LEXUS ENFORM OPERATION

### 5. Lexus Insider

Lexus Insider is an optional function that can send audio messages, or articles, to participating owners' vehicles via the navigation system. Potential Lexus Insider subjects might include, for example, Lexus vehicle technology tips, updates on regional Lexus events, or audio excerpts from Lexus Magazine articles.

#### NEW MESSAGE NOTIFICATION

When the vehicle is first powered on and a new Lexus Insider article is available, a notification will appear on the navigation screen. The notice will appear for only approximately 6 seconds unless one of the options listed is selected.

- 1 When the new message notification appears, any of the following options can be selected.

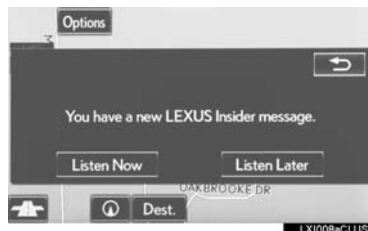

**"Listen Now"**: Select to play newly received Lexus Insider article(s).

**"Listen Later"**: Select to close the notification screen without playing articles. The notification screen will be displayed again when the engine <power> switch is turned to ACCESSORY or IGNITION ON <ON> mode.

#### VIEWING AND PLAYING RECEIVED Lexus Insider MESSAGES

- 1 Press the "MENU" button on the Remote Touch.

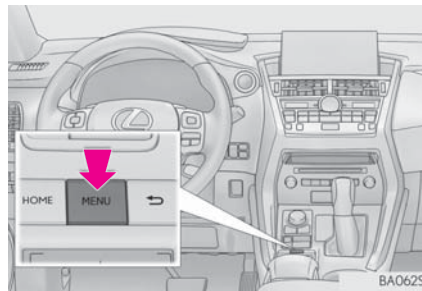

- 2 Select "Info".



9

LEXUSENFORM

## 2. LEXUS ENFORM OPERATION

### 3 Select "Lexus Insider".

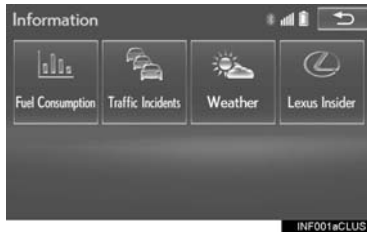

### 4 Select the desired article title.



**"Read All":** Select to listen to all stored Lexus Insider broadcasts.

- To disrupt the audio read of Lexus Insider, press the **"MODE"** switch on the steering wheel, or press the **"RADIO"** or **"MEDIA"** button on the audio system.

### MESSAGE ICONS

Icons appear at the left of the Lexus Insider story titles and indicate the following.

Icon	Article
	Unread article
	Previously read article
	Unread article with downloadable Point of Interest (POI)
	Previously read article with downloadable Point of Interest (POI)

### LISTENING TO ANOTHER ARTICLE

- 1 Display the "LEXUS Insider" screen. (→P. 369)
- 2 Select the desired article.



- 3 Select "Next" or "Previous" to listen to another article.

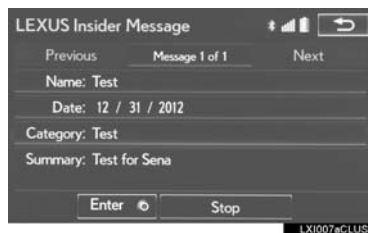

- The "∧" or "∨" switch on the steering wheel can be used to move to the previous or next article.
- To stop listening to the broadcast, select "Stop" or press the "PWR·VOL" knob of the audio system.

### DOWNLOADING A POI

Some Lexus Insider articles will contain a downloadable POI relevant to the content.

- 1 Display the "LEXUS Insider" screen. (→P. 369)
- 2 Select the desired article.

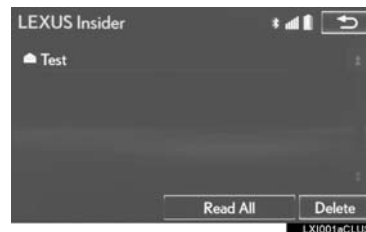

- 3 Select "Enter".

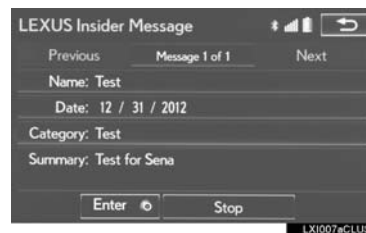

- If a POI is contained, "Enter" can be selected to download a POI to the navigation system.
- 4 Select "Go" to set the POI as a destination with route directions.

9

LEXUSENFORM

## 2. LEXUS ENFORM OPERATION

### DELETING Lexus Insider ARTICLE

1 Display the "LEXUS Insider" screen.  
(→P. 369)

2 Select "Delete".

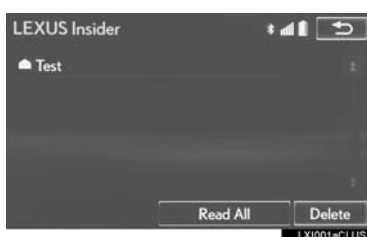

3 Select the item to be deleted and select "Delete".

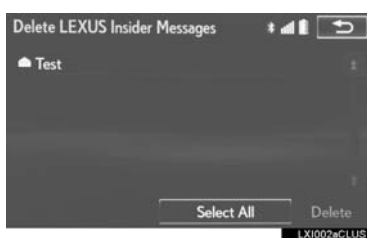

4 Select "Yes" when the confirmation screen appears.

### 3. SETUP

## 1. LEXUS App Suite SETTINGS

The settings of App Suite can be changed.

- 1 Press the "MENU" button on the Remote Touch.

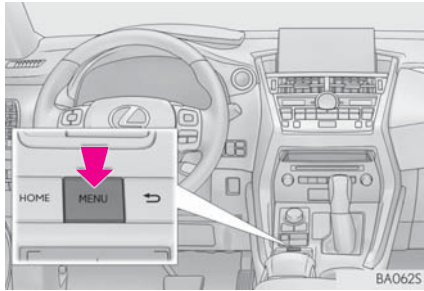

- 2 Select "Setup".



- 3 Select "LEXUS App Suite".



- 4 Select the items to be set.

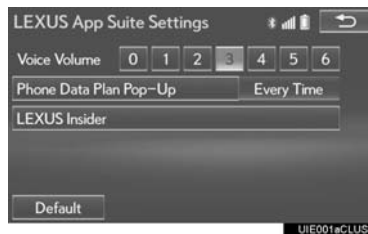

### SCREEN FOR LEXUS App Suite SETTINGS

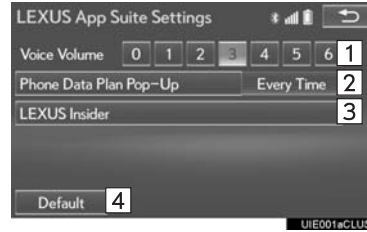

No.	Information	Page
1	Select to set the voice guidance volume.	374
2	Select to set the pop up reminder for cellular phone data usage.	374
3	Select to set Lexus Insider settings.	375
4	Select to reset all setup items.	—

9

LEXUSENFORM

### VOICE VOLUME SETTINGS

The voice guidance volume can be adjusted.

- 1 Display the “LEXUS App Suite Settings” screen. (→P. 373)
- 2 Select the desired level by selecting the appropriate number.

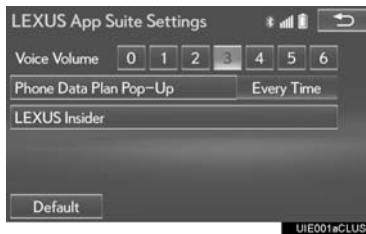

### PHONE DATA PLAN POP-UP SETTINGS

The phone data plan pop-up can be set when a paid application is downloaded.

- 1 Display the “LEXUS App Suite Settings” screen. (→P. 373)
- 2 Select “Phone Data Plan Pop-Up”.

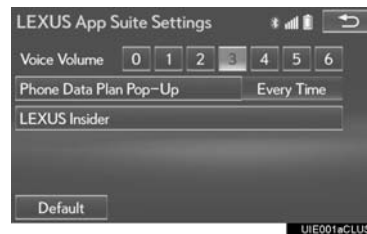

- 3 Check the desired function to be operated.

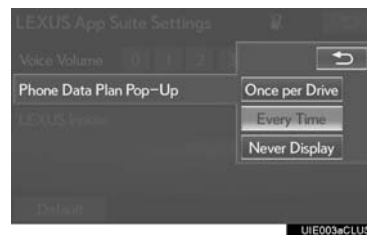

### Lexus Insider SETTINGS

Lexus Insider settings, notification, and opt in or out of article receipt can be changed.

- 1 Display the "LEXUS App Suite Settings" screen. (→P. 373)
- 2 Select "LEXUS Insider".

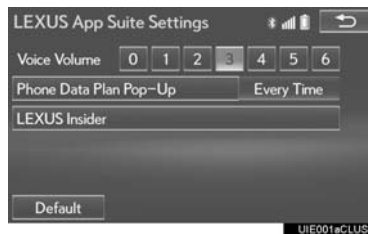

- 3 Select the items to be set.

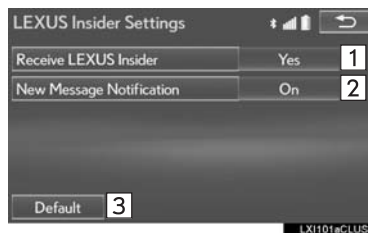

No.	Function
1	Select to set the receiving of Lexus Insider articles yes/no.
2	Select to set the new message notification on/off.
3	Select to reset all setup items.

### 3. SETUP





# INDEX

- 1
- 2
- 3
- 4
- 5
- 6
- 7
- 8
- 9
-

## ALPHABETICAL INDEX

### A

AM/FM radio .....	176
Available HD Radio™ technology.....	186
Caching a radio program .....	182
Overview .....	176
Presetting a station .....	180
Radio broadcast data system .....	183
Selecting a station from the list .....	180
Traffic announcement (FM radio) .....	185
Troubleshooting guide .....	188
Using HD Radio™ technology .....	185
Audio settings .....	237
Audio settings screen.....	238
Audio/visual remote controls .....	235
Audio/visual system .....	165
AUX.....	229
Overview .....	229

### B

Basic function.....	10, 33
Basic information before operation.....	34
Basic operation .....	82, 166
Bluetooth® audio .....	223
Connecting a Bluetooth® device .....	227
Listening to Bluetooth® audio .....	227
Overview .....	223
Bluetooth® phone message function .....	311
Calling the message sender .....	316
Checking messages.....	313
Receiving a message .....	312
Replying to a message (Quick reply) .....	314
Bluetooth® settings.....	48

### C

Calling on the Bluetooth® phone.....	301
By call history .....	302
By contacts list.....	303
By dial pad.....	306
By favorites list.....	302
By off hook switch.....	306
Casual speech recognition .....	266
CD.....	198
Overview .....	198
Playing an audio CD.....	202
Playing an MP3/WMA/AAC disc.....	203
Command list .....	267

### D

Data services settings.....	276
Setting download methods .....	276
Destination Assist .....	362
Destination search.....	105
Destination search screen.....	105
Detailed navigation settings .....	150
Screens for navigation settings .....	151
DVD.....	204
DVD options .....	208
Overview.....	204



**E**

eDestination.....363  
Editing route .....133  
    Adding destinations.....134  
    Deleting destinations.....135  
    Detour setting .....136  
    Reordering destinations .....134  
    Selecting route type.....136  
    Setting route preferences .....135  
    Starting from adjacent road .....137  
Entering letters and numbers/  
    list screen operation .....41  
    Entering letters and numbers .....41  
    List screen.....42  
Estimated course line display mode .....283  
    Parking .....284  
    Screen description.....283

**F**

Function index.....30  
Functional overview.....342

**G**

General settings .....66  
    General settings screen .....67  
GPS (Global Positioning System) .....159  
    Limitations of the navigation system.....159

**H**

Home screen.....14  
    Status display.....16  
Home screen operation .....39  
How to use the Remote Touch .....36  
    Touchpad gestures .....38

**I**

Information.....273  
Information display .....274  
"Information" screen .....20  
Initial screen.....34  
Internet radio.....197  
    Listening to internet radio.....197  
iPod .....216  
    iPod audio.....221  
    iPod video.....222  
Overview .....216



## ALPHABETICAL INDEX

L	M
LEXUS App Suite ..... 352	Map database version and covered area ..... 162
Entering keyword operation..... 360	About the map data ..... 163
Linking LEXUS App Suite and navigation local function..... 357	Map information ..... 162
Using LEXUS App Suite..... 352	Map screen information ..... 93
LEXUS App Suite settings ..... 372	Displaying information about the icon where the cursor is set ..... 97
Screen for LEXUS App Suite settings ..... 372	Displaying map information..... 93
Lexus Enform ..... 341	Standard map icons ..... 99
Lexus Enform Destinations ..... 362	Map screen operation ..... 85
Destination Assist..... 362	Adjusting location in small increments ..... 92
eDestination..... 363	Current position display..... 85
Lexus Enform Remote..... 351	Map scale ..... 86
LEXUS Enform Service Connect ..... 343, 352	Orientation of the map ..... 88
Lexus Insider..... 368	Screen scroll operation ..... 91
New message notification ..... 368	Switching the map mode ..... 89
Viewing and playing received Lexus insider messages ..... 368	Media operation..... 198
Lexus parking assist monitor ..... 278	Memory points..... 138
Driving precautions..... 278	Memory points settings..... 138
Screen display..... 280	Deleting previous destinations..... 149
Using the system..... 281	Setting up address book ..... 143
Lexus parking assist monitor precautions..... 287	Setting up areas to avoid..... 146
Area displayed on screen ..... 287	Setting up home..... 139
Differences between the screen and the actual road..... 289	Setting up preset destinations ..... 141
The camera ..... 288	"Menu" screen..... 12
When approaching three-dimensional objects..... 290	Mobile Assistant..... 271
Linking multi-information display and navigation system ..... 47	



N	
Navigation operation .....	22
Navigation system .....	81

O	
Operating information .....	244
DVD player and disc .....	246
Error messages .....	256
File information .....	252
iPod .....	251
Radio .....	244
Terms .....	254
Operation flow: Guiding the route .....	26
Other settings .....	66

P	
Parking assist guide line display mode .....	285
Parking .....	286
Screen description .....	285
Peripheral monitoring system .....	277
Phone .....	295
Phone operation (Hands-free system for cellular phones) .....	296
Phone/message settings .....	318
“Contact/Call History Settings” screen .....	320
“Messaging Settings” screen .....	332
“Phone Display Settings” screen .....	333
Phone/message settings screen .....	318
“Sound Settings” screen .....	319

Q	
Quick guide .....	9
Quick reference .....	18, 82, 166, 296
Map screen .....	82
Navigation options screen .....	84

R	
Radio operation .....	176
Receiving on the Bluetooth® phone .....	307
Incoming calls .....	307
Receiving weather information .....	274
Displaying weather information .....	274
Registering home .....	22
Registering preset destinations .....	24
Registering/connecting Bluetooth® device .....	48
Certification .....	54
Profiles .....	52
Registering a Bluetooth® audio player for the first time .....	50
Registering a Bluetooth® phone for the first time .....	48
Remote Touch .....	10
Route guidance .....	125
Route guidance screen .....	125
During freeway driving .....	128
Route overview .....	127
Screen for route guidance .....	125
Turn list screen .....	130
Turn-by-turn arrow screen .....	131
When approaching intersection .....	130

## ALPHABETICAL INDEX

### S

Screen adjustment .....	45	Setting home as the destination .....	28
Search operation .....	107	Setup .....	150, 237, 318
Destination search by Destination Assist...	116	“Setup” screen .....	18
Searching by address .....	110	Some basics .....	168, 297
Searching by address book .....	117	About the contacts in the contact list .....	300
Searching by coordinates .....	120	Audio screen adjustment .....	174
Searching by emergency .....	117	Disc slot .....	170
Searching by intersection and freeway .....	118	Registering/connecting a Bluetooth® phone .....	298
Searching by map .....	119	Selecting an audio source .....	169
Searching by point of interest .....	111	Sound settings .....	172
Searching from previous destinations .....	116	Turning the system on and off .....	168
Selecting search area .....	108	USB/AUX port .....	171
Setting home as destination .....	109	Using the phone switch/microphone .....	298
Setting preset destinations as destination .....	109	Voice command system .....	175, 299
Setting Bluetooth® details .....	56	When selling or disposing of the vehicle .....	300
“Bluetooth Setup” screen .....	57	Starting route guidance .....	121
Connecting a Bluetooth® device .....	60	Pausing guidance .....	124
Deleting a Bluetooth® device .....	59	Starting route guidance .....	121
Editing the Bluetooth® device information .....	62	Steering switches .....	235
Registering a Bluetooth® device .....	58		
“System Settings” screen .....	64		



**T**

Talking on the Bluetooth® phone.....308  
 Incoming call waiting..... 310  
 Things you should know .....292  
 If you notice any symptoms .....292  
 Tips for operating the audio/  
 visual system ..... 244  
 Tips for the navigation system ..... 159  
 Traffic information .....100  
 Displaying traffic information  
 on the map ..... 103  
 Traffic settings .....156  
 Auto avoid traffic.....158  
 Screen for traffic settings.....157  
 Troubleshooting .....334  
 Type A: Function achieved by  
 using a cellular phone ..... 344  
 Before using the function ..... 345  
 Preparation before using  
 LEXUS App Suite ..... 346  
 Type B: Function achieved by using  
 DCM and the navigation system..... 347  
 Before using the function ..... 348  
 Type C: Function achieved by  
 using DCM.....350  
 Typical voice guidance prompts .....132

**U**

USB memory.....211  
 Overview .....211  
 USB audio .....215

**V**

Vehicle settings .....75  
 Maintenance .....76  
 Voice command system.....257, 258  
 Expanded voice commands .....265  
 Using the voice command system ..... 258  
 Voice command system operation..... 259  
 Voice command system operation..... 258  
 Voice settings.....73  
 Voice settings screen .....74  
 VTR .....232  
 Overview .....232  
 VTR options .....234

**W**

What to do if... ..... 334

**X**

XM Satellite Radio.....189  
 Displaying the radio ID .....194  
 How to subscribe to an  
 XM Satellite Radio.....192  
 If the satellite radio tuner malfunctions.....196  
 Overview .....189  
 Presetting a channel.....194  
 Selecting a channel from the list .....195



# Map database information and updates

## END USER LICENSE AGREEMENT

PLEASE READ THIS AGREEMENT CAREFULLY BEFORE USING THE NAVIGATION SYSTEM

THIS IS A LICENSE AGREEMENT FOR YOUR COPY OF THE SPATIAL MAP DATABASE, INCLUDING LOCATION CODES AND RELATED PRODUCTS (COLLECTIVELY, THE "DATABASE"), USED IN THE NAVIGATION SYSTEM. BY USING THE NAVIGATION SYSTEM AND THE DATABASE, YOU ACCEPT AND AGREE TO BE BOUND BY ALL TERMS AND CONDITIONS SET FORTH BELOW.

### LICENSE GRANT

DENSO CORPORATION ("DENSO"), as a licensed distributor of the DATABASE, grants to you a non-exclusive, non-perpetual license to use your copy of the DATABASE for your personal use or for your use in your business' internal operations and not for any other purpose. This license does not include the right to grant sub-licenses.

### OWNERSHIP

The DATABASE and the copyrights and intellectual property and neighboring rights therein are owned by TomTom North America, Inc. ("TomTom") and its licensors. This Agreement does not transfer any title or interest in the DATABASE, except for the license to use the DATABASE according and subject to the terms and conditions of this Agreement. You shall not alter, obscure or remove any copyright notices, trademark notices or other restrictive legends relating to the DATABASE.

The DATABASE comprises confidential and proprietary information and materials of TomTom. Accordingly, you shall hold the DATABASE in confidence and trust. You shall take reasonable steps to protect the DATABASE from misappropriation or misuse. You shall not extract stand-alone data from or publish any part of the DATABASE without the prior written consent of TomTom and its licensors.

### LIMITATIONS ON USE

The DATABASE is restricted for use in the specific system for which it was created. Except to the extent explicitly permitted by mandatory laws, you may not extract or reutilize any portion of the contents of the DATABASE, nor reproduce, copy, duplicate, modify, adapt, translate, disassemble, decompile, or reverse engineer any portion of the DATABASE.

### TRANSFER

You may not transfer the DATABASE to third parties, except together with the system for which it was created, provided that you do not retain any copy of the DATABASE, and provided that the transferee agrees to all terms and conditions of this AGREEMENT.

### DISCLAIMER OF WARRANTY

THE LICENSED PRODUCTS ARE PROVIDED ON AN "AS IS" AND "WITH ALL FAULTS BASIS" AND TOMTOM AND ITS SUPPLIERS EXPRESSLY DISCLAIM ALL WARRANTIES, EXPRESS OR IMPLIED, INCLUDING BUT NOT LIMITED TO, THE IMPLIED WARRANTIES OF NON-INFRINGEMENT, MERCHANTABILITY, SATISFACTORY QUALITY, ACCURACY, TITLE AND FITNESS FOR A PARTICULAR PURPOSE. NO ORAL OR WRITTEN ADVICE OR INFORMATION PROVIDED BY TOMTOM OR ANY OF ITS AGENTS, EMPLOYEES OR THIRD PARTY



PROVIDERS SHALL CREATE A WARRANTY, AND LICENSEE IS NOT ENTITLED TO RELY ON ANY SUCH ADVICE OR INFORMATION. THIS DISCLAIMER OF WARRANTIES IS AN ESSENTIAL CONDITION OF THE AGREEMENT.

**LIMITATION OF LIABILITY**

NEITHER TOMTOM NOR ITS SUPPLIERS SHALL BE LIABLE TO THE UNDERSIGNED FOR ANY INCIDENTAL, CONSEQUENTIAL, SPECIAL, INDIRECT OR EXEMPLARY DAMAGES ARISING OUT OF THIS AGREEMENT, INCLUDING LOST PROFITS OR COSTS OF COVER, LOSS OF USE OR BUSINESS INTERRUPTION OR THE LIKE, REGARDLESS OF WHETHER THE PARTY WAS ADVISED OF THE POSSIBILITY OF SUCH DAMAGES.

NOTWITHSTANDING ANYTHING TO THE CONTRARY CONTAINED HEREIN, TOMTOM SHALL HAVE NO MONETARY LIABILITY TO THE UNDERSIGNED FOR ANY CAUSE (REGARDLESS OF THE FORM OF ACTION) UNDER OR RELATING TO THIS AGREEMENT.

**WARNINGS**

The DATABASE comprises facts and information from government and other sources reflecting circumstances in existence before you received the DATABASE, which may contain errors and omissions. Accordingly, the DATABASE may contain inaccurate or incomplete information due to the passage of time, changing circumstances, and due to the nature of the sources used. The DATABASE does not include or reflect information relating to, among other things, neighborhood safety; law enforcement; emergency assistance; construction work; road or lane closures; vehicle or speed restrictions; road slope or grade; bridge height, weight or other limits; road or traffic conditions; special events; traffic congestion; or travel time.

End Users shall acknowledge that the use of the Licensed Products with a non-TomTom map may result in increased variance between the location displayed on the map and ground truth location.

The covenants and obligations undertaken by the End User herein are intended for the direct benefit of TomTom and may be enforced by TomTom directly against the End User.

**U.S. GOVERNMENT RIGHTS**

U.S. GOVERNMENT RIGHTS. If End User is an agency, department, or other entity of the United States Government, or funded in whole or in part by the United States Government, then use, duplication, reproduction, release, modification, disclosure or transfer of this commercial product and accompanying documentation, is restricted in accordance with the LIMITED or RESTRICTED rights as described in any applicable DFARS or FAR. In case of conflict between any of the FAR and/or DFARS that may apply to the Licensed Product, the construction that provides greater limitations on the Government's rights shall control. Contractor/manufacturer is TomTom North America, Inc., 11 Lafayette Street, Lebanon, NH 03766-1445. Phone: 603.643. 0330. The Licensed Products are © 2006-Present by TomTom. ALL RIGHTS RESERVED. For purpose of any public disclosure provision under any federal, state or local law, it is agreed that the Licensed Products are a trade secret and a proprietary commercial product and not subject to disclosure.

If End User is an agency, department, or other entity of any State government, the United States Government or any other public entity or funded in whole or in part by the United States Government, then End User hereby agrees to protect the Licensed Products from public disclosure and to consider the Licensed Products exempt from any statute, law,

regulation, or code, including any Sunshine Act, Public Records Act, Freedom of Information Act, or equivalent, which permits public access and/or reproduction or use of the Licensed Products. In the event that such exemption is challenged under any such laws, this EULA shall be considered breached and any and all right to retain any copies or to use of the Licensed Products shall be terminated and considered immediately null and void. Any copies of the Licensed Products held by Licensee shall immediately be destroyed. If any court of competent jurisdiction considers this clause void and unenforceable, in whole or in part, for any reason, this EULA shall be considered terminated and null and void, in its entirety, and any and all copies of the Licensed Products shall immediately be destroyed.

#### END-USER TERMS

The data ("Data") is provided for your personal, internal use only and not for resale. It is protected by copyright, and is subject to the following terms and conditions which are agreed to by you, on the one hand, and DENSO CORPORATION ("DENSO") and its licensors (including their licensors and suppliers) on the other hand.

© 2014 NAVTEQ. All rights reserved.

The Data for areas of Canada includes information taken with permission from Canadian authorities, including: © Her Majesty the Queen in Right of Canada, © Queen's Printer for Ontario, © Canada Post Corporation, GeoBase®, ©Department of Natural Resources Canada. All rights reserved.

NAVTEQ holds a non-exclusive license from the United States Postal Service® to publish and sell ZIP+4® information. ©United States Postal Service® 2014. Prices are not established, controlled or approved by the United States Postal Service®. The following trademarks and registrations are owned by the USPS: United States Postal Service, USPS, and ZIP+4.

The Data for Mexico includes certain data from Instituto Nacional de Estadística y Geografía.

#### Terms and Conditions

**Personal Use Only.** You agree to use this Data together with the vehicle navigation system for the solely personal, non-commercial purposes for which you were licensed, and not for service bureau, time-sharing or other similar purposes. Notwithstanding the foregoing, You may use the Data for purposes of Your business operations. Accordingly, but subject to the restrictions set forth in the following paragraphs, you agree not to otherwise reproduce, copy, modify, decompile, disassemble or reverse engineer any portion of this Data, and may not transfer or distribute it in any form, for any purpose, except to the extent permitted by mandatory laws. Multi-disc sets may only be transferred or sold as a complete set as provided by DENSO and not as a subset thereof.

**Restrictions.** Except where you have been specifically licensed to do so by DENSO, and without limiting the preceding paragraph, you may not (a) use this Data with any products, systems, or applications installed or otherwise connected to or in communication with vehicles, capable of vehicle navigation, positioning, dispatch, real time route guidance, fleet management or similar applications; or (b) with or in communication with any positioning devices or any mobile or wireless-connected electronic or computer devices, including without limitation cellular phones, palmtop and handheld computers, pagers, and personal digital assistants or PDAs.

**Warning.** The Data may contain inaccurate or incomplete information due to the passage of time, changing circumstances, sources used and the nature of collecting comprehensive geographic data, any of which may lead to incorrect results.

**No Warranty.** This Data is provided to you "as is," and you agree to use it at your own risk. DENSO and its licensors (and their licensors and suppliers) make no guarantees, representations or warranties of any kind, express or implied, arising by law or otherwise, including but not limited to, content, quality, accuracy, completeness, effectiveness, reliability, fitness for a particular purpose, usefulness, use or results to be obtained from this Data, or that the Data or server will be uninterrupted or error-free.

Disclaimer of Warranty: DENSO AND ITS LICENSORS (INCLUDING THEIR LICENSORS AND SUPPLIERS) DISCLAIM ANY WARRANTIES, EXPRESS OR IMPLIED, OF QUALITY, PERFORMANCE, MERCHANTABILITY, FITNESS FOR A PARTICULAR PURPOSE OR NON-INFRINGEMENT. Some States, Territories and Countries do not allow certain warranty exclusions, so to that extent the above exclusion may not apply to you.

Disclaimer of Liability: DENSO AND ITS LICENSORS (INCLUDING THEIR LICENSORS AND SUPPLIERS) SHALL NOT BE LIABLE TO YOU: IN RESPECT OF ANY CLAIM, DEMAND OR ACTION, IRRESPECTIVE OF THE NATURE OF THE CAUSE OF THE CLAIM, DEMAND OR ACTION ALLEGING ANY LOSS, INJURY OR DAMAGES, DIRECT OR INDIRECT, WHICH MAY RESULT FROM THE USE OR POSSESSION OF THE INFORMATION; OR FOR ANY LOSS OF PROFIT, REVENUE, CONTRACTS OR SAVINGS, OR ANY OTHER DIRECT, INDIRECT, INCIDENTAL, SPECIAL OR CONSEQUENTIAL DAMAGES ARISING OUT OF YOUR USE OF OR INABILITY TO USE THIS INFORMATION, ANY DEFECT IN THE INFORMATION, OR THE BREACH OF THESE TERMS OR CONDITIONS, WHETHER IN AN ACTION IN CONTRACT OR TORT OR BASED ON A WARRANTY, EVEN IF DENSO OR ITS LICENSORS HAVE BEEN ADVISED OF THE POSSIBILITY OF SUCH DAMAGES. Some States, Territories and Countries do not allow certain liability exclusions or damages limitations, so to that extent the above may not apply to you.

Export Control. You agree not to export from anywhere any part of the Data provided to you or any direct product thereof except in compliance with, and with all licenses and approvals required under, applicable export laws, rules and regulations.

Entire Agreement. These terms and conditions constitute the entire agreement between DENSO (and its licensors, including their licensors and suppliers) and you pertaining to the subject matter hereof, and supersedes in their entirety any and all written or oral agreements previously existing between us with respect to such subject matter.

Governing Law. The above terms and conditions shall be governed by the laws of the State of Illinois, without giving effect to (i) its conflict of laws provisions, or (ii) the United Nations Convention for Contracts for the International Sale of Goods, which is explicitly excluded. You agree to submit to the jurisdiction of the State of Illinois for any and all disputes, claims and actions arising from or in connection with the Data provided to you hereunder.

Government End Users. If the Data is being acquired by or on behalf of the United States government or any other entity seeking or applying rights similar to those customarily claimed by the United States government, the Data is a "commercial item" as that term is defined at 48 C.F.R. ("FAR") 2.101, is licensed in accordance with the End-User Terms under which this Data was provided, and each copy of the Data delivered or otherwise furnished shall be marked and embedded as appropriate with the following "Notice of Use," and shall be treated in accordance with such Notice:

NOTICE OF USE

CONTRACTOR (MANUFACTURER/ SUPPLIER) NAME: NAVTEQ

CONTRACTOR (MANUFACTURER/SUPPLIER) ADDRESS:

c/o Nokia 425 West Randolph Street, Chicago, Illinois 60606

This Data is a commercial item as defined in FAR 2.101 and is subject to the End-User Terms under which this Data was provided.

© 2014 NAVTEQ – All rights reserved.

If the Contracting Officer, federal government agency, or any federal official refuses to use the legend provided herein, the Contracting Officer, federal government agency, or any federal official must notify NAVTEQ prior to seeking additional or alternative rights in the Data

## END USER NOTICE

PLEASE READ THIS NOTICE CAREFULLY BEFORE USING THIS NAVIGATION SYSTEM

The Point Of Interest Data ("POI" Data) in the navigation system is in part provided by Infogroup Inc. ("Infogroup"). By using the POI Data, you accept and agree to all terms and conditions set forth below.

### 1. Ownership

All rights, title and interest to the Infogroup POI Data shall be retained by Infogroup.

### 2. Limitations on use

Except to the extent explicitly permitted by mandatory laws, you may not extract or re-utilize any portion of the contents of the POI Data, nor reproduce, copy, modify, adapt, translate, disassemble, decompile, or reverse engineer any portion of the POI Data.

### 3. Transfer

You may not transfer the POI Data to third parties, except together with the system for which it was created, provided that you do not retain any copy of the POI Data.

### 4. Disclaimer of warranty

EXCEPT AS STATED HEREIN, INFOGROUP MAKES NO EXPRESS OR IMPLIED WARRANTIES, INCLUDING, WITHOUT LIMITATION, ANY EXPRESS OR IMPLIED WARRANTY OF FITNESS FOR A PARTICULAR PURPOSE OR WARRANTY OF MERCHANTABILITY.

### 5. Limitation of Liability

EITHER INFOGROUP OR SUPPLIER OF POI DATA SHALL NOT BE LIABLE FOR ANY INDIRECT, CONSEQUENTIAL OR INCIDENTAL DAMAGES MADE OR ALLEGED IN CONNECTION WITH YOUR USE OF THE POI DATA.

## END USER LICENSE AGREEMENT

**Personal Use Only.** You agree to use this information for solely personal, non-commercial purposes, and not for service bureau, time-sharing or other similar purposes. You may not modify the information or remove any copyright notices that appear on the information in any way. You may not decompile, disassemble or reverse engineer any portion of this information, and may not transfer or distribute it in any form, for any purpose. Without limiting the foregoing, you may not use this information with any products, systems, or applications installed or otherwise connected to or in communication with vehicles, capable of vehicle navigation, positioning, dispatch, real time route guidance, fleet management or similar applications.

**No Warranty.** This information is provided to you "as is," and you agree to use it at your own risk. DENSO and its licensors (and their licensors and suppliers, collectively "DENSO") make no guarantees, representations or warranties of any kind, express or implied, arising by law or otherwise, including but not limited to, and DENSO expressly disclaims any warranties regarding content, quality, accuracy, completeness, effectiveness, reliability, fitness for a particular purpose, non-infringement, usefulness, use or results to be obtained from this information, or that the information or server will be uninterrupted or error-free. Some states, territories and countries do not allow certain warranty exclusions, so to that extent, the above exclusion may not apply to you.

**Disclaimer of Liability:** DENSO SHALL NOT BE LIABLE TO YOU FOR ANY CLAIM, DEMAND OR ACTION, IRRESPECTIVE OF ITS NATURE, ALLEGING ANY LOSS, INJURY OR DAMAGES, WHETHER DIRECT, INDIRECT, INCIDENTAL, SPECIAL OR CONSEQUENTIAL DAMAGES, INCLUDING ANY LOSS OF PROFIT, REVENUE OR CONTRACTS ARISING OUT OF YOUR POSSESSION, USE OF OR INABILITY TO USE THIS INFORMATION, ANY DEFECT IN THE INFORMATION, OR THE BREACH OF THESE TERMS OR CONDITIONS, WHETHER IN AN ACTION IN CONTRACT OR TORT OR BASED ON A WARRANTY, EVEN IF DENSO OR ITS LICENSORS HAVE BEEN ADVISED OF THE POSSIBILITY OF SUCH DAMAGES. Some states, territories and countries do not allow certain liability exclusions or damages limitations, so to that extent the above may not apply to you.

**Indemnity.** You agree to indemnify, defend and hold DENSO and its licensors (including their respective licensors, suppliers, assignees, subsidiaries, affiliated companies, and the respective officers, directors, employees, shareholders, agents and representatives of each of them) free and harmless from and against any liability, loss, injury (including injuries resulting in death), demand, action, cost, expense, or claim of any kind or character, including but not limited to attorney's fees, arising out of or in connection with any use or possession by you of this information.

## **END USER NOTICE**

The marks of companies displayed by this product to indicate business locations are the marks of their respective owners. The use of such marks in this product does not imply any sponsorship, approval, or endorsement by such companies of this product.

End User's use of the Brand Icon Licensed Product and any portion thereof, is limited to use solely for the purpose of enhancing the value and/or use of the spatial vector data furnished or made by TomTom. Notwithstanding anything to the contrary herein, or in any attachment or exhibit hereto, in no event shall End User use the Brand Icon Licensed Product or any portion thereof in connection with or in conjunction with spatial street vector data furnished or made by a party other than TomTom. End User may only use the icons, brand names, logos, trademarks or other features within (and not separate from) the map data in any collateral, marketing and product packaging. In addition, End shall not modify or alter the color, shape, size, and orientation of the Brand Icon Licensed Product as provided to End User without TomTom's prior written approval.

Licensee agrees that the use of Brand Icon Licensed Product subject to the terms and conditions set forth in this Agreement and that there may be additional third party terms, conditions and restrictions to which the use of the Brand Icon Licensed Product will be subject provided to the End User from time to time by TomTom in the Release Notes applicable to the Licensed Products.



## Certification

- Gracenote, the Gracenote logo and logotype, "Powered by Gracenote", MusicID, Playlist Plus and MediaVOCS are either registered trademarks or trademarks of Gracenote, Inc. in the United States and/or other countries



### Gracenote<sup>®</sup> End User License Agreement - Music

This application or device contains software from Gracenote, Inc. of Emeryville, California ("Gracenote"). The software from Gracenote (the "Gracenote Software") enables this application to perform disc and/or file identification and obtain music-related information, including name, artist, track, and title information ("Gracenote Data") from online servers or embedded databases (collectively, "Gracenote Servers") and to perform other functions. You may use Gracenote Data only by means of the intended End-User functions of this application or device.

This application or device may contain content belonging to Gracenote's providers. If so, all of the restrictions set forth herein with respect to Gracenote Data shall also apply to such content and such content providers shall be entitled to all of the benefits and protections set forth herein that are available to Gracenote.

You agree that you will use Gracenote Data, the Gracenote Software, and Gracenote Servers for your own personal non-commercial use only. You agree not to assign, copy, transfer or transmit the Gracenote Software or any Gracenote Data to any third party. **YOU AGREE NOT TO USE OR EXPLOIT GRACENOTE DATA, THE GRACENOTE SOFTWARE, OR GRACENOTE SERVERS, EXCEPT AS EXPRESSLY PERMITTED HEREIN.**

You agree that your non-exclusive license to use the Gracenote Data, the Gracenote Software, and Gracenote Servers will terminate if you violate these restrictions. If your license terminates, you agree to cease any and all use of the Gracenote Data, the Gracenote Software, and Gracenote Servers. Gracenote reserves all rights in Gracenote Data, the Gracenote Software, and the Gracenote Servers, including all ownership rights. Under no circumstances will Gracenote become liable for any payment to you for any information that you provide. You agree that Gracenote, Inc. may enforce its rights under this Agreement against you directly in its own name.

The Gracenote service uses a unique identifier to track queries for statistical purposes. The purpose of a randomly assigned numeric identifier is to allow the Gracenote service to count queries without knowing anything about who you are. For more information, see the web page for the Gracenote Privacy Policy for the Gracenote service.

The Gracenote Software and each item of Gracenote Data are licensed to you "AS IS." Gracenote makes no representations or warranties, express or implied, regarding the accuracy of any Gracenote Data from the Gracenote Servers. Gracenote reserves the right to delete data from the Gracenote Servers or to change data categories for any cause that Gracenote deems sufficient. No warranty is made that the Gracenote Software or Gracenote Servers are error-free or that functioning of Gracenote Software or Gracenote Servers will be uninterrupted. Gracenote is not obligated to provide you with new enhanced or additional data types or categories that Gracenote may provide in the future and is free to discontinue its services at any time.

GRACENOTE DISCLAIMS ALL WARRANTIES EXPRESS OR IMPLIED, INCLUDING, BUT NOT LIMITED TO, IMPLIED WARRANTIES OF MERCHANTABILITY, FITNESS FOR A PARTICULAR PURPOSE, TITLE, AND NON-INFRINGEMENT. GRACENOTE DOES NOT WARRANT THE RESULTS THAT WILL BE OBTAINED BY YOUR USE OF THE GRACENOTE SOFTWARE OR ANY GRACENOTE SERVER. IN NO CASE WILL GRACENOTE BE LIABLE FOR ANY CONSEQUENTIAL OR INCIDENTAL DAMAGES OR FOR ANY LOST PROFITS OR LOST REVENUES.

© 2013 Gracenote, Inc. All rights reserved.

► For U.S. owners

**I. Clear Channel Disclaimers**

"Total Traffic Network, a division of Clear Channel Broadcasting, Inc., owns or holds the rights to the traffic, news, sports, weather, stocks and other data (the "TOTAL TRAFFIC-HD+ Data") and TOTAL TRAFFIC-HD+ network through which it is delivered, together the "TTN Service". Use of the TTN Service is subject to the terms of these Device End User Terms.

"The TTN Service is informational only. User assumes all risk of use. Total Traffic Network and its suppliers and licensors make no representations about the accuracy or timeliness of any of the TOTAL TRAFFIC-HD+ Data, including traffic and road conditions, route usability, or speed."

"TOTAL TRAFFIC-HD+ NETWORK DATA IS PROVIDED "AS IS," AND "WHERE IS". TOTAL TRAFFIC NETWORK AND ITS SUPPLIERS AND LICENSORS EXPRESSLY DISCLAIM ALL WARRANTIES WITH RESPECT TO THE DATA (INCLUDING, WITHOUT LIMITATION, THAT THE DATA WILL BE ERROR-FREE, WILL OPERATE WITHOUT INTERRUPTION OR THAT THE DATA WILL BE ACCURATE), EXPRESS, IMPLIED OR STATUTORY, INCLUDING, WITHOUT LIMITATION, THE IMPLIED WARRANTIES OF MERCHANTABILITY, NON-INFRINGEMENT, FITNESS FOR A PARTICULAR PURPOSE, OR THOSE ARISING FROM A COURSE OF DEALING OR USAGE OF TRADE."

"TOTAL TRAFFIC NETWORK AND ITS SUPPLIERS AND LICENSORS WILL NOT BE LIABLE TO YOU FOR ANY INDIRECT, SPECIAL, CONSEQUENTIAL, EXEMPLARY, OR INCIDENTAL DAMAGES (INCLUDING, WITHOUT LIMITATION, LOST REVENUES, ANTICIPATED REVENUES, OR PROFITS RELATING TO THE SAME) ARISING FROM ANY CLAIM RELATING DIRECTLY OR INDIRECTLY TO USE OF THE DATA, WHETHER A CLAIM FOR SUCH DAMAGES IS BASED ON WARRANTY, CONTRACT, TORT (INCLUDING, WITHOUT LIMITATION, NEGLIGENCE OR STRICT LIABILITY) OR ANY OTHER LEGAL THEORY."

**II. The Weather Channel's (TWC's) Disclaimers**

THE FOLLOWING TERMS APPLY TO THE USE OF ANY MATERIAL, DATA OR INFORMATION PROVIDED BY THE WEATHER CHANNEL, LLC ("THE WEATHER CHANNEL"), INCLUDING WEATHER-RELATED INFORMATION AND REPORTS, OBTAINED BY YOU OR OTHERS THROUGH THE TTN SERVICE ("THE WC DATA").

**DISCLAIMER OF WARRANTIES.**

YOUR USE OF THE WC DATA IS AT YOUR SOLE RISK. THE WC DATA IS PROVIDED ON AN "AS IS" AND "AS AVAILABLE" BASIS. THE WEATHER CHANNEL EXPRESSLY DISCLAIMS ALL WARRANTIES OF ANY KIND, WHETHER EXPRESS OR IMPLIED, INCLUDING, BUT NOT LIMITED TO THE IMPLIED WARRANTIES OF MERCHANTABILITY, FITNESS FOR A PARTICULAR PURPOSE AND NON-INFRINGEMENT.

THE WEATHER CHANNEL MAKES NO REPRESENTATION OR WARRANTY THAT (i) THE WC DATA WILL MEET YOUR REQUIREMENTS, (ii) THE WC DATA WILL BE UNINTERRUPTED, TIMELY, SECURE, OR ERROR-FREE, (iii) THE RESULTS THAT MAY BE OBTAINED FROM THE USE OF THE WC DATA WILL BE ACCURATE OR RELIABLE, OR (iv) ANY ERRORS OR BUGS IN THE WC DATA WILL BE CORRECTED. ACCORDINGLY, THE WEATHER CHANNEL SHALL NOT BE RESPONSIBLE OR LIABLE FOR THE ACCURACY, USEFULNESS OR AVAILABILITY OF THE WC DATA.

**LIMITATION OF LIABILITY.**

YOU EXPRESSLY UNDERSTAND AND AGREE THAT THE WEATHER CHANNEL, ITS SUPPLIERS, ITS LICENSORS AND ITS AFFILIATE COMPANIES SHALL NOT BE LIABLE, UNDER ANY LEGAL THEORY, INCLUDING CONTRACT, TORT, NEGLIGENCE OR STRICT LIABILITY, FOR ANY DIRECT, INDIRECT, INCIDENTAL, SPECIAL, PUNITIVE, CONSEQUENTIAL OR EXEMPLARY DAMAGES, INCLUDING BUT NOT LIMITED TO, DAMAGES FOR LOSS OF PROFITS, GOODWILL, USE, DATA OR OTHER INTANGIBLE LOSSES (EVEN IF THE WEATHER CHANNEL HAS BEEN ADVISED OF THE POSSIBILITY OF SUCH DAMAGES), RESULTING FROM OR ARISING OUT OF YOUR USE OF, OR YOUR INABILITY TO USE, THE WC DATA, THIS AGREEMENT, OR ANY OTHER MATTER RELATING TO THE WC DATA. YOUR SOLE AND EXCLUSIVE REMEDY FOR ANY DISPUTE WITH THE WEATHER CHANNEL RELATED TO THE WC DATA OR CONTENT SHALL BE CANCELLATION OF RECEIPT OF THE WC DATA.

SOME JURISDICTIONS DO NOT ALLOW THE EXCLUSION OF CERTAIN WARRANTIES OR THE LIMITATION OR EXCLUSION OF LIABILITY FOR INCIDENTAL OR CONSEQUENTIAL DAMAGES. ACCORDINGLY, SOME OF THE ABOVE LIMITATIONS MAY NOT APPLY TO YOU.

