

A large, stylized graphic of the letter 'V' is formed by two thick, grey, parallel lines. The lines are slightly offset from each other, creating a sense of depth and movement. The 'V' is oriented vertically, with its top pointing towards the right side of the page.

## OWNER'S MANUAL

M2394A  
M2794A

Make sure to read the Safety Precautions before using the product.  
Keep the User's Guide(CD) in an accessible place for future reference.  
See the label attached on the product and give the information to your dealer when you ask for service.

# PREPARATION

## FRONT PANEL CONTROLS

- This is a simplified representation of the front panel. The image shown may be somewhat different from your set.

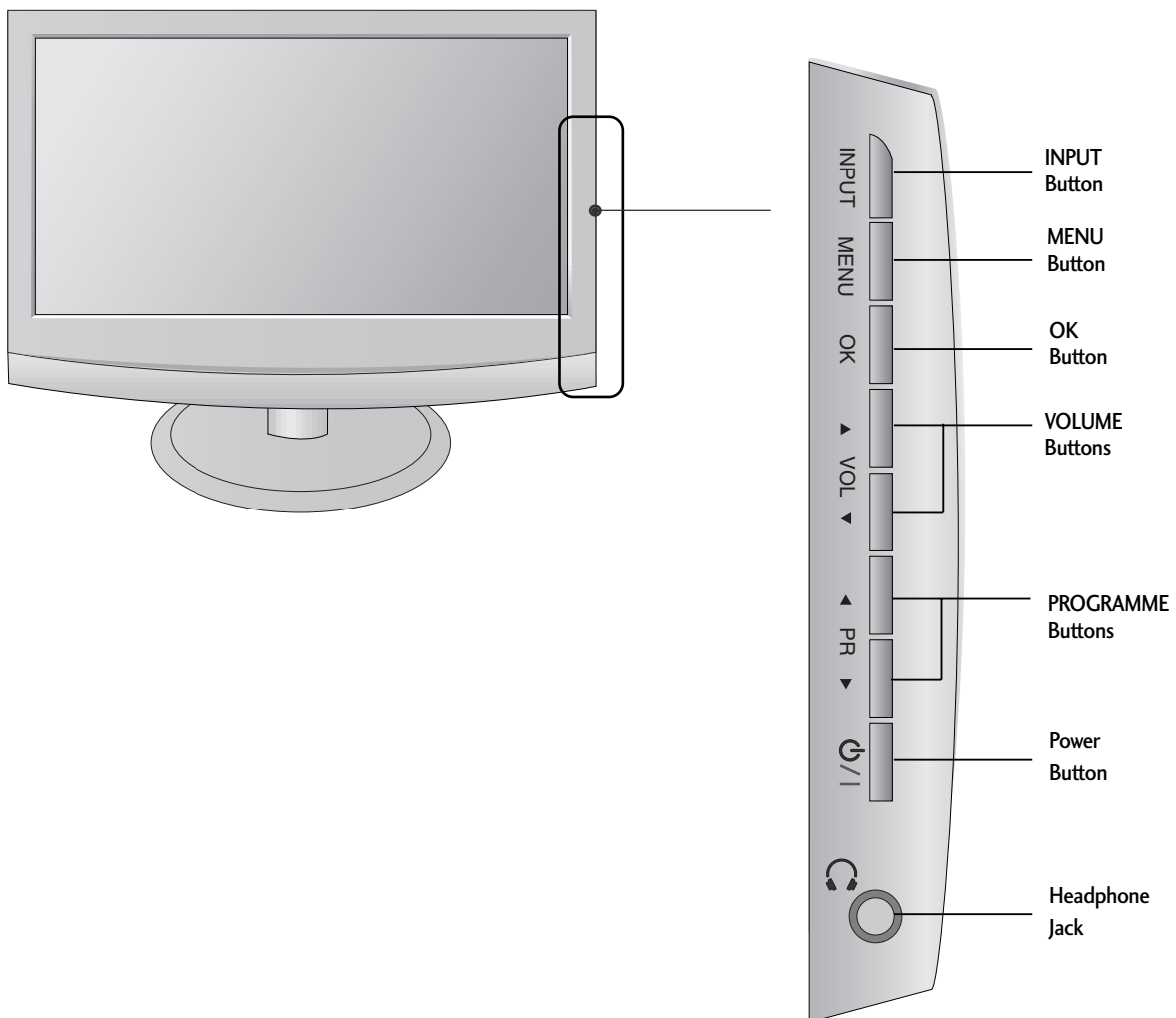

# PREPARATION

## BACK PANEL INFORMATION

- This is a simplified representation of the back panel. The image shown may be somewhat different from your set.

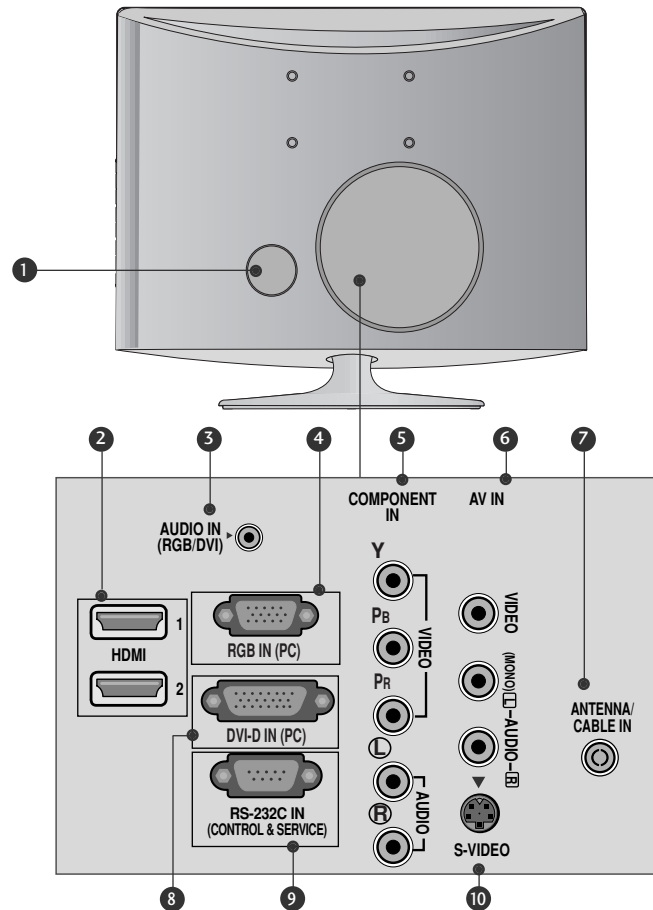

### 1 Power Cord Socket

This set operates on AC power. The voltage is indicated on the Specifications page. Never attempt to operate the set on DC power.

### 2 HDMI Input

Connect a HDMI signal to HDMI .  
Or DVI (VIDEO) signal to HDMI with DVI to HDMI cable.

### 3 RGB/DVI Audio Input

Connect the audio from a PC.

### 4 RGB Input (PC)

Connect the output from a PC.

### 5 Component Input

Connect a component video/audio device to these jacks.

### 6 AV(Audio/Video) Input

Connect audio/video output from an external device to these jacks.

### 7 Antenna Input

Connect over-the-air signals to this jack.

### 8 DVI-D Input(PC)

Connect the output from a PC.

### 9 RS-232C IN (CONTROL & SERVICE) PORT

Connect to the RS-232C port on a PC.

### 10 S-Video Input

Connect S-Video out from an S-VIDEO device.

# PREPARATION

## STAND INSTALLATION

■ The image shown may be somewhat different from your set.

- 1 Carefully place the product screen side down on a cushioned surface that will protect product and screen from damage.

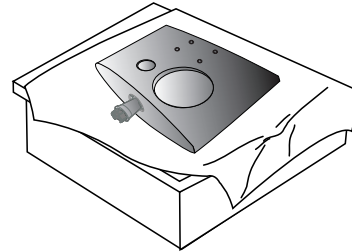

- 2 Insert the **stand base** into the product

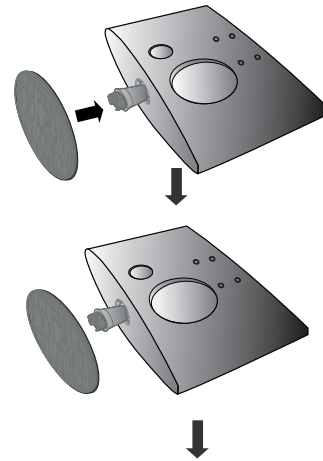

- 3 Attach the monitor to the Stand Base by turning the screw to the right.

\* Turn the screw by using the screw handle

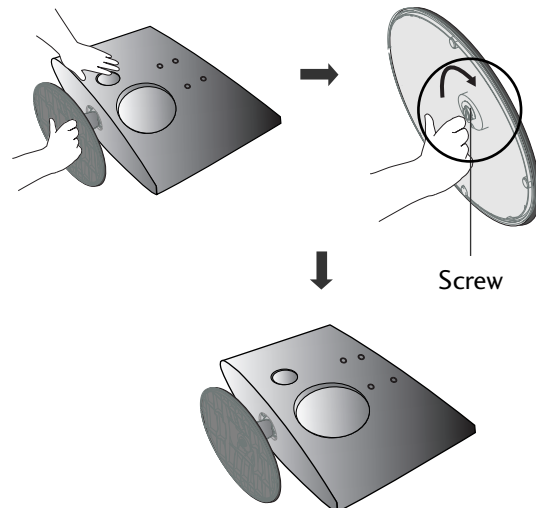

# PREPARATION

## DETACHING STAND

▪ The image shown may be somewhat different from your set.

- 1** Place the set screen side down on a cushion or soft cloth.

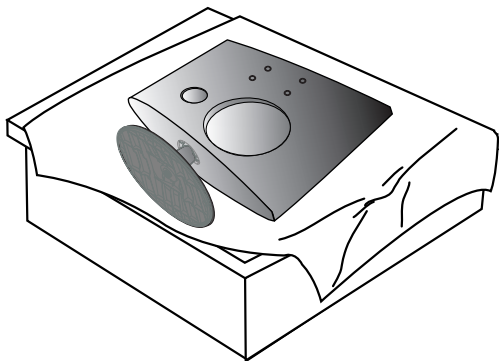

- 2** Detach the monitor to the Stand Base by turning the screw to the left.

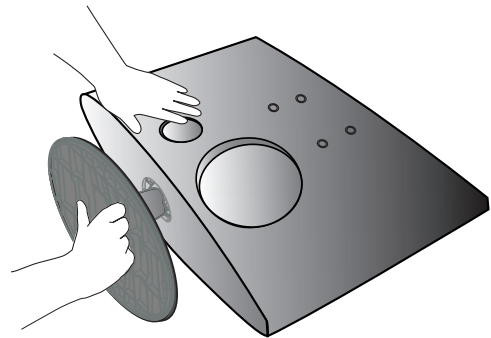

- 3** Turn the screw by using the screw handle

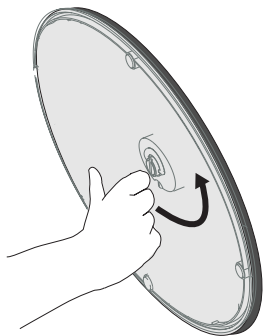

- 4** Pull the stand base.

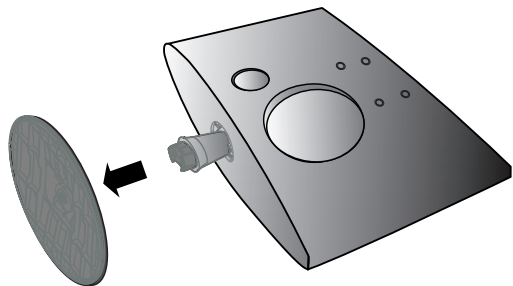

- 5**

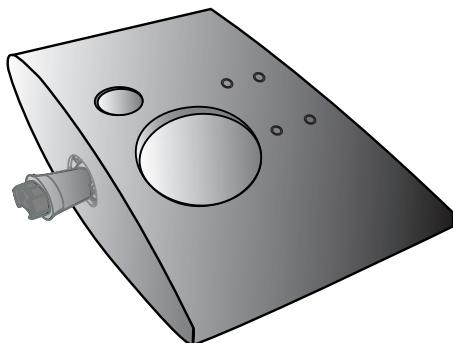

# PREPARATION

## WALL MOUNT: HORIZONTAL INSTALLATION

For proper ventilation, allow a clearance of 4 inches on each side and from the wall. Detailed installation instructions are available from your dealer, see the optional Tilt Wall Mounting Bracket Installation and Setup Guide.

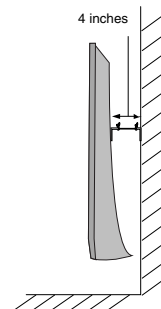
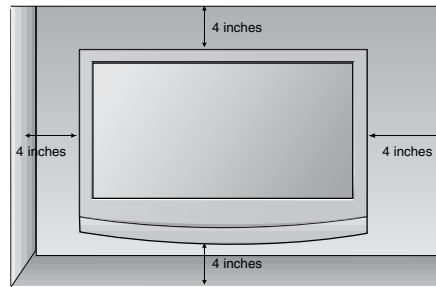
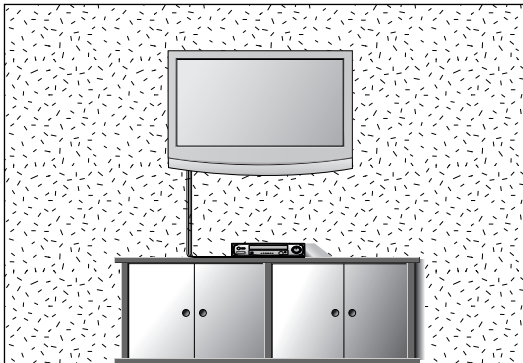

## DESKTOP PEDESTAL INSTALLATION

For proper ventilation, allow a clearance of 4 inches on each side and from the wall.

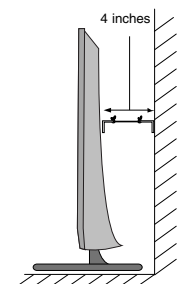
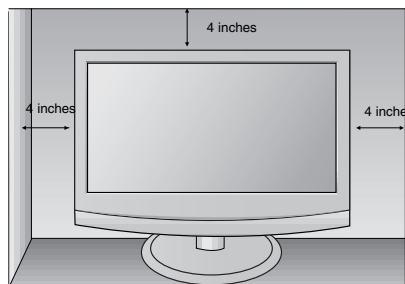
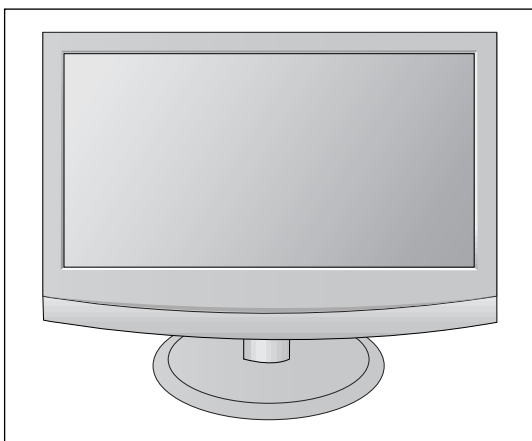

# PREPARATION

## POSITIONING YOUR DISPLAY

■ The image shown may be somewhat different from your set.

Adjust the position of the panel in various ways for maximum comfort.

### • Tilt range

<M2394A>

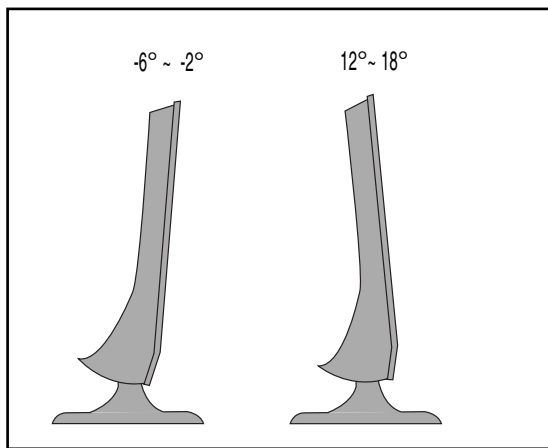

<M2794A>

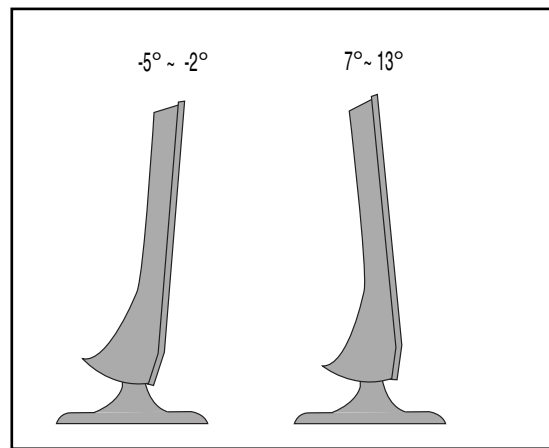

## LOCATION

Position your set so that no bright light or sunlight falls directly onto the screen. Care should be taken not to expose the set to any unnecessary vibration, moisture, dust or heat. Also, ensure that the set is placed in a position to allow a free flow of air. Do not cover the ventilation openings on the back cover.

If you intend to mount the set to a wall, attach Wall mounting interface (optional parts) to the back of the set.

When you install the set using the wall mounting interface (optional parts), attach it carefully so it will not drop.

- Be sure to use screws and a wall mount that meet VESA standards.
- Using screws longer than those recommended might damage the product.
- Using screws that do not meet VESA standards might either damage the product or result in it coming away from the wall. We will not be held responsible for any damage resulting from failure to follow these instructions.

< Screw Mounting Interface Dimension >

M2394A : 75mm x 75mm hole spacing

M2794A : 100mm x 100mm hole spacing

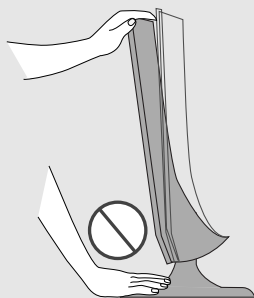

### **Warning:**

When adjusting the angle of the screen, do not put your finger(s) in between the head of the monitor and the stand body. You can hurt your finger(s).

# PREPARATION

## KENSINGTON SECURITY SYSTEM

- The product is equipped with a Kensington Security System connector on the back panel. Connect the Kensington Security System cable as shown below.
- For detailed installation and use of the Kensington Security System, refer to the user's guide provided with the Kensington Security System.  
For further information, contact <http://www.kensington.com>, the internet homepage of the Kensington company. Kensington sells security systems for expensive electronic equipment such as notebook PCs and LCD projectors.

### NOTE

- The Kensington Security System is an optional accessory.

### NOTES

- If the product feels cold to the touch, there may be a small "flicker" when it is turned on.  
This is normal, there is nothing wrong with product.
- Some minute dot defects may be visible on the screen, appearing as tiny red, green, or blue spots.  
However, they have no adverse effect on the monitor's performance.
- Avoid touching the LCD screen or holding your finger(s) against it for long periods of time.  
Doing so may produce some temporary distortion effects on the screen.

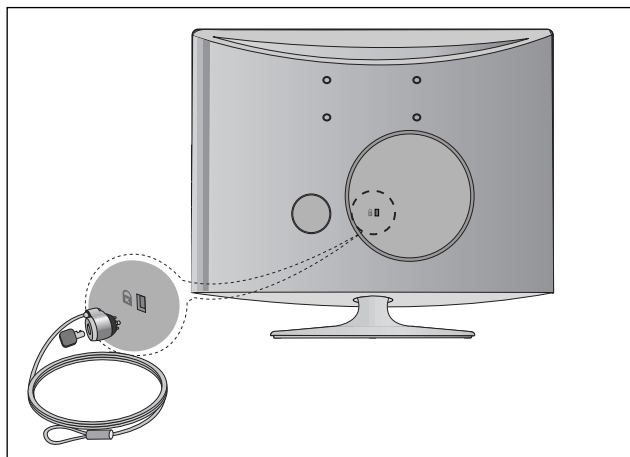



# EXTERNAL EQUIPMENT SETUP

- To prevent equipment damage, never plug in any power cords until you have finished connecting all equipment.

## ANTENNA CONNECTION

- For optimum picture quality, adjust antenna direction.
- An antenna cable and converter are not supplied.

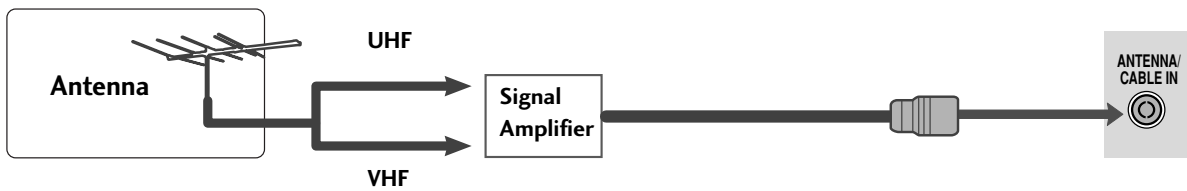
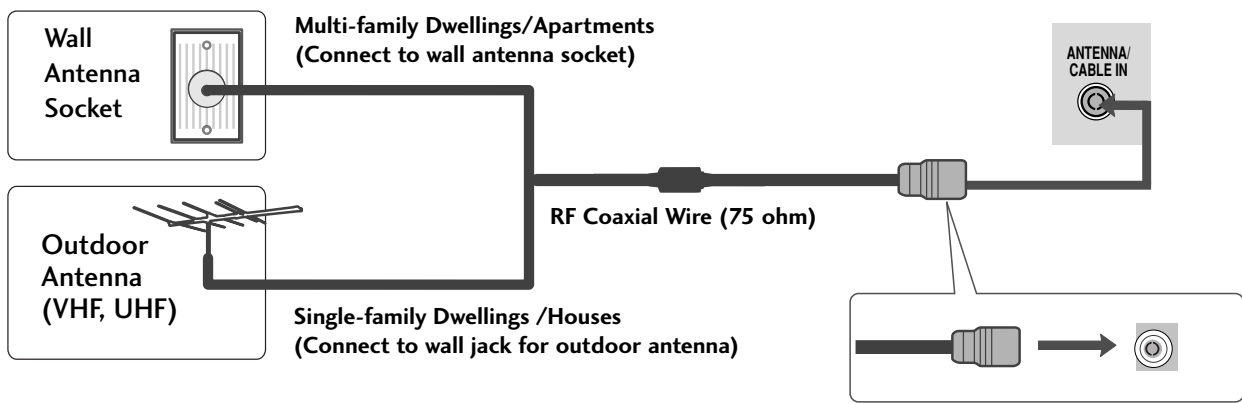

- In poor signal areas, to get better picture quality, install a signal amplifier to the antenna as shown above.
- If signal needs to be split for two sets, use an antenna signal splitter for connection.

# EXTERNAL EQUIPMENT SETUP

- To prevent the equipment damage, never plug in any power cords until you have finished connecting all equipment.
- The image shown may be somewhat different from your set.

## HD RECEIVER SETUP

### When connecting with a component cable

- 1 Connect the SET-TOP outputs to the **COMPONENT IN VIDEO** sockets (Y Pb Pr) on the set.
- 2 Connect the audio cable from the SET-TOP to **COMPONENT IN AUDIO** sockets of the set.
- 3 Press the **INPUT** button to select **Component**.

Signal	Component
480i/576i	Yes
480p/576p	Yes
720p/1080i	Yes
1080p	Yes

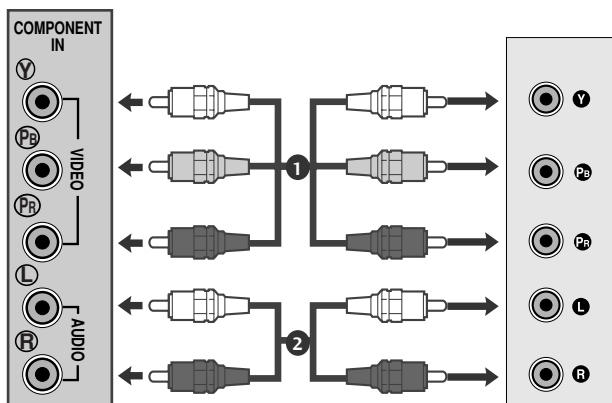

# EXTERNAL EQUIPMENT SETUP

## When connecting with a HDMI

- 1 Connect the HDMI output of the digital set-top box to the **HDMI** jack on the set.
- 2 Press the INPUT button to select HDMI1 or HDMI2.

Signal	HDMI
480i/576i	No
480p/576p	Yes
720p/1080i	Yes
1080p	Yes

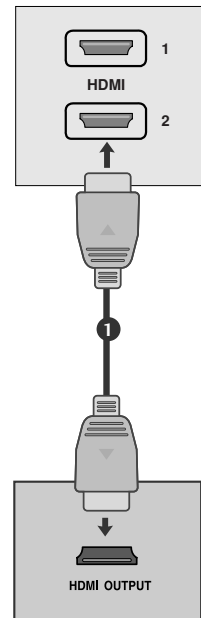

## When connecting with a HDMI to DVI cable

- 1 Connect the digital set-top box to **HDMI** jack on the set.
- 2 Connect the audio output of the digital set-top box to the **AUDIO IN (RGB/DVI)** jack on the set.
- 3 Turn on the digital set-top box. (Refer to the owner's manual for the digital set-top box.)
- 4 Press the INPUT button to select HDMI1 or HDMI2.

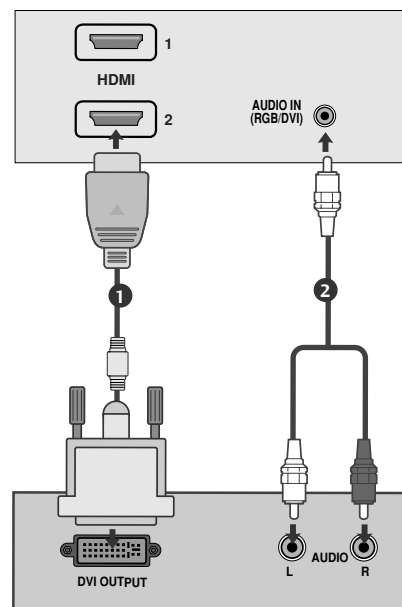

### ! NOTE

- ▶ HDMI Input does not support PC mode. If it is connected PC, the screen may not be displayed properly.
- ▶ HDMI support PCM audio format only.

# EXTERNAL EQUIPMENT SETUP

## DVD SETUP

### When connecting with a component cable

- 1 Connect the video output sockets (Y P<sub>B</sub> P<sub>R</sub>) of the DVD to the **COMPONENT IN VIDEO** sockets (Y P<sub>B</sub> P<sub>R</sub>) of the set.
- 2 Connect the audio cable from the DVD to **COMPONENT IN AUDIO** sockets of the set.
- 3 Press the **INPUT** button to select **Component**.
- 4 Press the **PLAY** button on the DVD.  
The DVD playback picture appears on the screen.

### Component Input ports

To get better picture quality, connect a DVD player to the component input ports as shown below.

Component ports on the set	Y	P <sub>B</sub>	P <sub>R</sub>
Video output ports on DVD player	Y	P <sub>B</sub>	P <sub>R</sub>
	Y	B-Y	R-Y
	Y	C <sub>b</sub>	C <sub>r</sub>
	Y	P <sub>b</sub>	P <sub>r</sub>

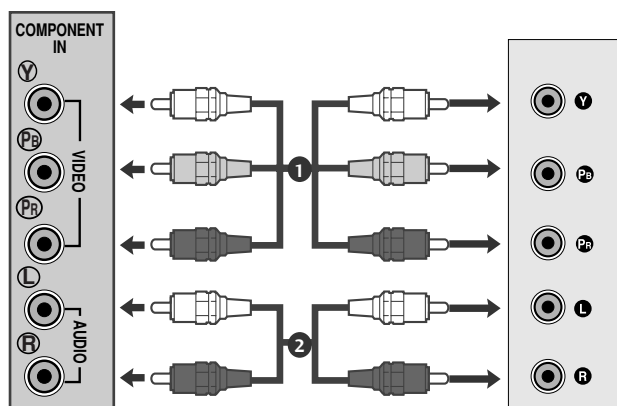

# EXTERNAL EQUIPMENT SETUP

## When connecting HDMI cable

- 1 Connect the HDMI output of the DVD to the **HDMI** jack on the set.
- 2 Press the INPUT button to select HDMI1 or HDMI2.

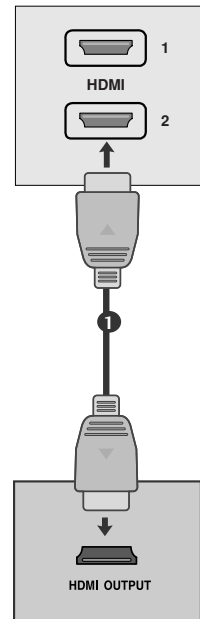

### ! NOTE

- ▶ Set can receive the video and audio signal simultaneously by using a HDMI cable.
- ▶ If the DVD player does not support Auto HDMI, you need to set the DVD output resolution appropriately.
- ▶ HDMI support PCM audio format only.

# EXTERNAL EQUIPMENT SETUP

## VCR SETUP

- To avoid picture noise (interference), leave an adequate distance between the VCR and set.
- Typically a still picture is shown on the VCR. If a user uses 4:3 picture format for a long time, an afterimage may remain on the sides of the screen.

### When connecting with an antenna

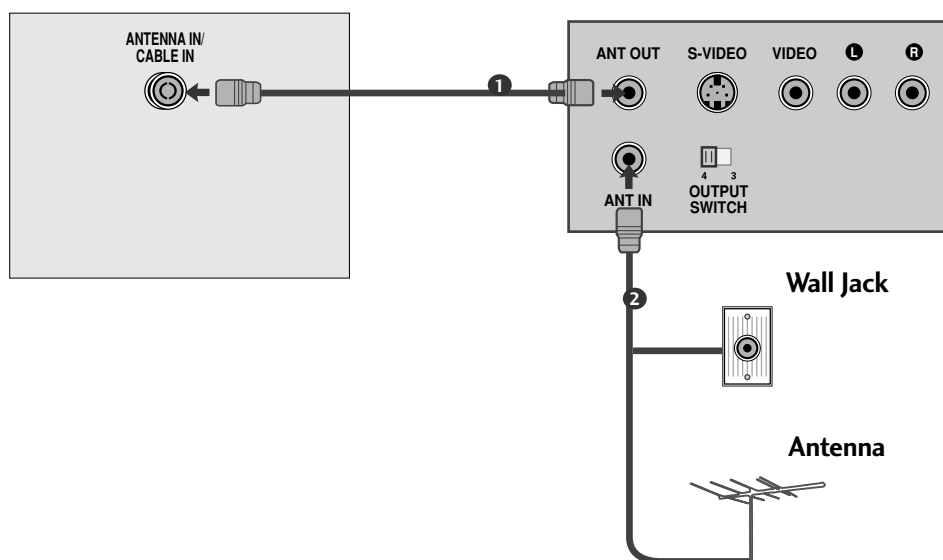

- 1 Connect the RF out socket of the VCR to the aerial socket of the set.
- 2 Connect the aerial cable to the RF ANT IN socket of the VCR.
- 3 Store the VCR channel on a desired programme number using the 'Manual programme tuning' section.
- 4 Select the programme number where the VCR channel is stored.
- 5 Press the **PLAY** button on the VCR.

# EXTERNAL EQUIPMENT SETUP

## When connecting with a RCA cable

- 1 Connect the audio/video out sockets of the VCR to AUDIO/VIDEO in sockets of the set.
- 2 Press the INPUT button to select AV.
- 3 Press the PLAY button on the VCR. The VCR playback picture appears on the screen.

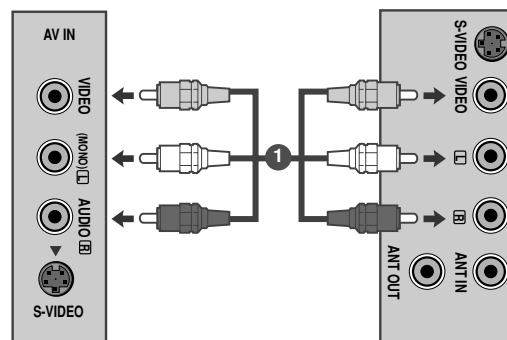

### ! NOTE

- ▶ If you have a mono VCR, connect the audio cable from the VCR to the AUDIO L/MONO jack of the set.

## When connecting with an S-Video cable

- 1 Connect the S-Video socket of the VCR to the S-VIDEO socket of the set.
- 2 Connect the audio cable from the S-VIDEO VCR to the AUDIO sockets of the set.
- 3 Press the INPUT button to select AV.
- 4 Press the PLAY button on the VCR. The VCR playback picture appears on the screen.

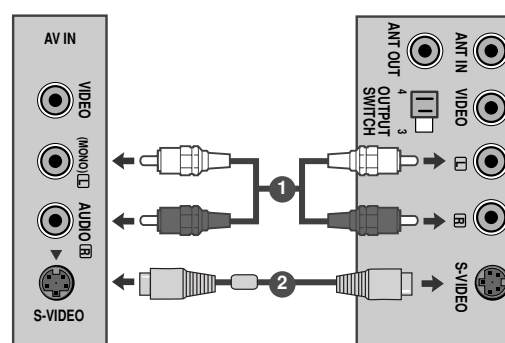

# EXTERNAL EQUIPMENT SETUP

## PC SETUP

This product provides Plug and Play capability, meaning that the PC adjusts automatically to the set's settings.

### When connecting with a D-sub 15 pin cable

- 1 Connect the signal cable from the RGB output socket of the PERSONAL COMPUTER to the RGB IN(PC) of the set.
- 2 Connect the audio cable from the PC to the **AUDIO IN (RGB/DVI)** jack of the set.
- 3 Press the INPUT button to select **RGB PC**.
- 4 Switch on the PC, and the PC screen appears on the set. The set can be operated as a PC monitor.

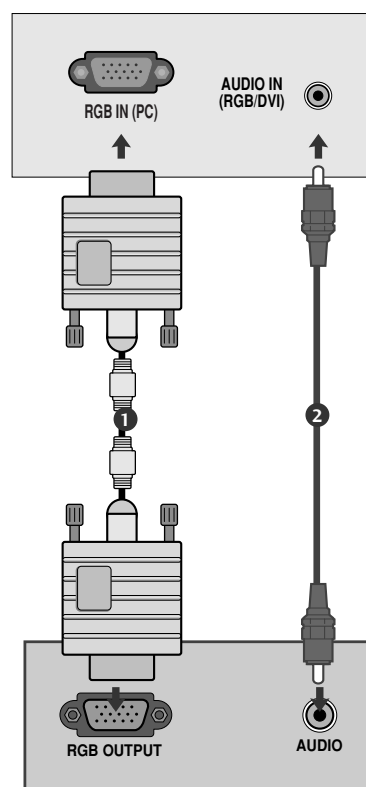

### ! NOTE

- ▶ You must use shielded signal interface cables (D sub 15 pin cable, DVI cable) with ferrite cores to maintain standard compliance for the product.



# EXTERNAL EQUIPMENT SETUP

## When connecting with a DVI cable

- 1 Connect the DVI output of the PC to the **DVI-D IN** jack on the set.
- 2 Connect the audio cable from the PC to the **AUDIO IN (RGB/DVI)** jack of the set.

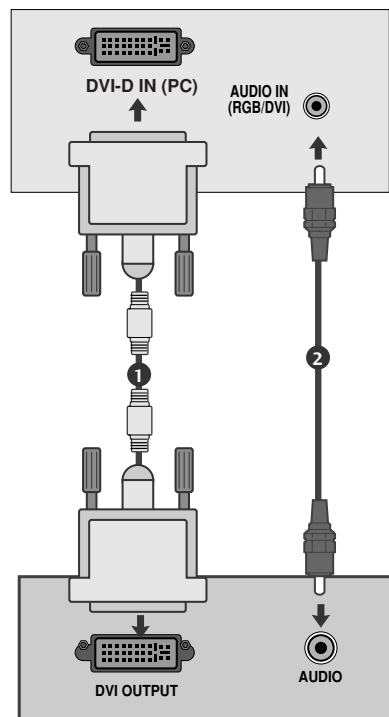

### ! NOTE

- ▶ If the set is cold, there may be a small “flicker” when the set is switched on. This is normal, there is nothing wrong with the set.
- ▶ If possible, use the 1920x1080@60Hz video mode to obtain the best image quality for your LCD monitor. If used with other resolutions, some scaled or processed pictures may appear on the screen. The set has been preadjusted to the mode 1920x1080@60Hz.
- ▶ Some dot defects may appear on the screen, like Red, Green or Blue spots. However, this will have no impact or effect on the monitor performance.
- ▶ Do not press the LCD screen with your finger for a long time as this may produce some temporary distortion effects on the screen.
- ▶ Avoid keeping a fixed image on the set's screen for prolonged periods of time. The fixed image may become permanently imprinted on the screen; use a screen saver when possible.

# EXTERNAL EQUIPMENT SETUP

## BACK COVER FOR WIRE ARRANGEMENT

Tie cables together with a cable tie as shown in the illustration.

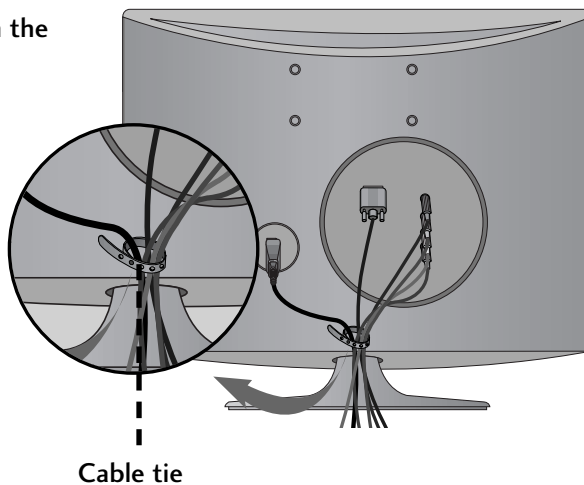

# EXTERNAL EQUIPMENT SETUP

## RGB/DVI[PC]

Resolution	Horizontal Frequency(kHz)	Vertical Frequency(Hz)
720x400	31.468	70
640x480	31.469	60
	37.500	75
800x600	37.879	60
	46.875	75
1024x768	48.363	60
	60.123	75
1152x864	67.500	75
1280x1024	63.981	60
	79.976	75
1680x1050	64.674	60
	65.290	60
1600x1200	75.000	60
1920x1080	66.587	60

## HDMI[DTV] supported mode

Resolution	Horizontal Frequency(kHz)	Vertical Frequency(Hz)
720x480/60p	31.47	60
	31.5	60
720x576/50p	31.25	50
1280x720/50p	37.5	50
1280x720/60p	44.96	60
	45	60
1920x1080/60i	33.72	60
	33.75	60
1920x1080/50i	28.125	50
1920x1080/24p	27	24
1920x1080/30p	33.75	30
1920x1080/50p	56.25	50
1920x1080/60p	67.43	60
	67.5	60

# WATCHING TV /PROGRAMME CONTROL

## REMOTE CONTROL KEY FUNCTIONS

When using the remote control, aim it at the remote control sensor on the set.  
 (Depends the country the remote control can be provided different.)

### A TYPE

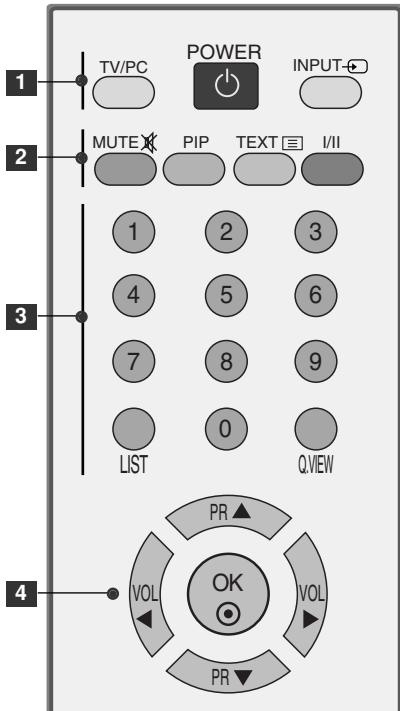

**1** TV/PC Selects TV or PC mode.  
Switches the set on.

**POWER** Switches the set on or off.

**INPUT** External input mode rotates in regular sequence.  
Switches the set on.

**2** **MUTE** Switches the sound on or off.

**PIP** Switches the sub picture PIP, DW mode.  
(Refer to the p.29)

**TELETEXT** These buttons are used for teletext.  
**BUTTONS** For further details, see the 'Teletext' section. (Refer to the p.51 -53)

**FAV** Scroll through the programmed Favorite programme.  
(Refer to the p.27)

**I/II** Selects the sound output.(Refer to the p.44)

### B TYPE

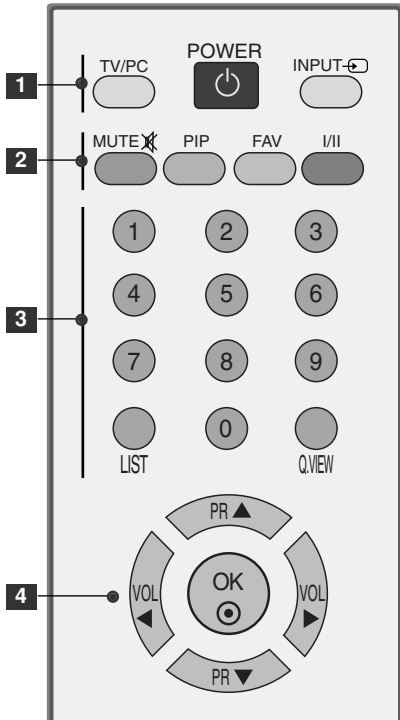

**3** **0~9 number** Selects a programme.  
**button** Selects numbered items in a menu.

**LIST** Displays the programme table.(Refer to the p.28)

**Q.VIEW** Returns to the previously viewed programme.

**4** **VOLUME UP** Adjusts the volume.  
**/DOWN**

**Programme** Selects a programme.  
**UP/DOWN**

**OK Button** Accepts your selection or displays the current mode.  
Double press the OK button, then Auto Config. (**Only RGB-PC input**)

# WATCHING TV /PROGRAMME CONTROL

(Depends the country the remote control can be provided different.)

## A TYPE

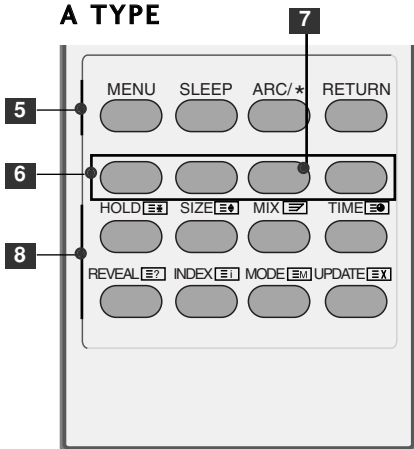

- 5** MENU Selects a menu. (Refer to the p.22)
- SLEEP Sets the sleep timer. (Refer to the p.46)
- ARC/\* Selects your desired picture format.(Refer to the p.30,31)
- RETURN Allows the user to move return one step in an interactive application or other user interaction function.

- 6** Colour Buttons These buttons are used for teletext or programme edit. (Refer to the p.26, 51-53)

- 7** Yellow key Scroll through the programmed Favorite programme. (Only A Type)

## B TYPE

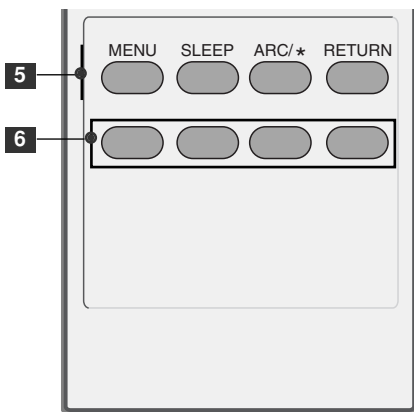

- 8** HOLD Press the button to stop the automatically rotating of the sub pages. Press the button again to continue the automatic rotating again.
- SIZE Press the button repeatedly to display the upper part, the lower part and then to return to the normal page size.
- MIX Display the teletext pages superimposed on the TV picture. To switch the TV picture off press this button again.
- TIME Press this button to select a sub page number. The sub page number is displayed at the bottom of the screen. To hold or change the sub page, press the RED/GREEN, ▲ / ▼ or NUMBER buttons. Press again to exit this function.
- REVEAL Press the button to reveal/conceal the hidden information, such as solutions to riddles and puzzles. Press this button again to remove the information from the display.
- INDEX To display the main index.
- MODE The mode will be switched in the Teletext mode.
- UPDATE Press the button to appear the TV programme. At the top of screen indicates that you are still in the teletext mode. Before interrupting teletext, you may select a page number. When the page has been found, the information line appears briefly on your screen. Press the button again to reappear teletext.

## Inserting batteries into remote control.

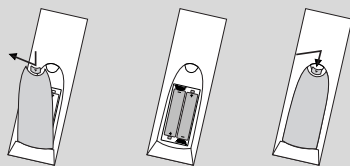

1. Take out the battery cap.
2. Insert the batteries with correct polarity (+/-).
3. Close the battery cap.
  - Dispose of used batteries in the recycle bin to prevent environmental pollution.

# WATCHING TV /PROGRAMME CONTROL

## TURNING ON THE SET

When your set is turned on, you will be able to use its features.

- 
- 1 Firstly, connect the power cord correctly.
    - To turn set on, press the  $\odot/|$  , **INPUT**, **PR ▲ / ▼** button on the set or press the **POWER**, **INPUT**, **PR ▲ / ▼**, **NUMBER(0~9)** buttons on the remote control and the set will switch on.
- 

### Initializing Guide

If the OSD (On Screen Display) is displayed on the screen after turning on the set, you can adjust the **Language**, **Location**, **Auto Tuning**.

**Note:**

- a. It will automatically disappear after approx. 40 seconds unless a button is pressed.
- b. "In-Store" mode is only for shop display and not for general customer use.
- c. "Home" mode is the optimal setting for home environments, and is the set's default mode.
- d. "In-Store" mode is the optimal setting for store environments. If a user modifies image quality data, "In-Store" mode initializes the product to the image quality set by us after a certain period of time.
- e. The mode (Home, In-Store) can be changed by executing Factory Reset in the Option menu.

## PROGRAMME SELECTION

- 
- 1 Press the **PR ▲ / ▼** or **NUMBER** buttons to select a programme number.
- 

## VOLUME ADJUSTMENT

- 
- 1 Press the **VOL ◀ / ▶** button to adjust the volume.
  - 2 If you wish to switch the sound off, press the **MUTE** button.
  - 3 You can cancel the Mute function by pressing the **MUTE** or **VOL ◀ / ▶** button.
-

# WATCHING TV /PROGRAMME CONTROL

## ON SCREEN MENUS SELECTION AND ADJUSTMENT

Your set's OSD (On Screen Display) may differ slightly from what is shown in this manual.

- 1 Press the **MENU** button and then **▲ / ▼** button to display each menu.
- 2 Press the **▶** button and then **▲ / ▼** button to select a menu item.
- 3 Change the setting of an item in the sub or pull-down menu with **◀ / ▶** button. You can move to a higher level menu by pressing the **OK**.

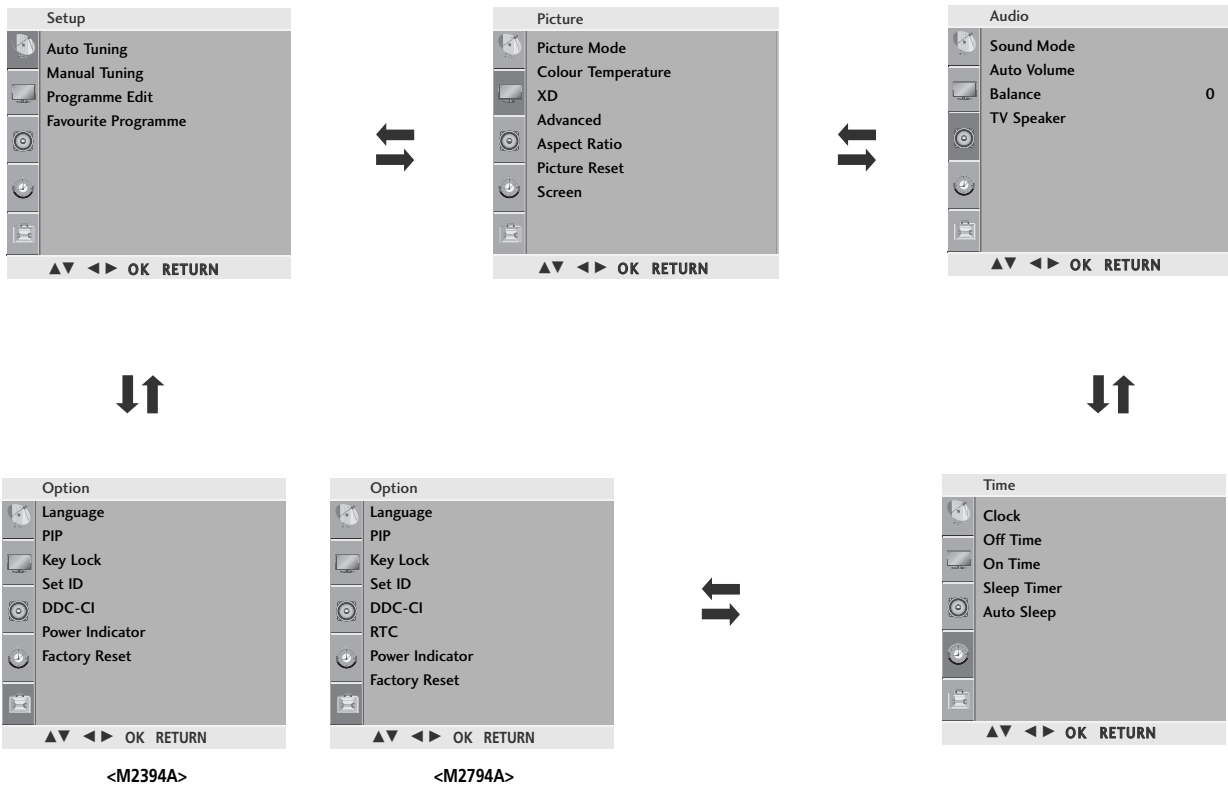

- Press the **MENU** button to close the menu window.
- Press the **RETURN** button to move to the previous menu screen.

### ! NOTE

- ▶ The OSD (On Screen Display) function enables you to adjust the screen status conveniently since it provides graphical presentation.
- ▶ In the teletext mode, menus are not displayed.

# WATCHING TV /PROGRAMME CONTROL

## AUTO PROGRAMME TUNING

Up to 100 TV stations can be stored by programme numbers (0 to 99). Once you have preset the stations, you will be able to use the PR ▲ / ▼ or NUMBER buttons to scan the stations you have programmed.

Stations can be tuned using automatic or manual modes.

All stations which can be received are stored by this method. It is recommended that you use Auto tuning during installation of this set.

- 1 Press the **MENU** button and then ▲ / ▼ button to select the **Setup** menu.
- 2 Press the ► button and then ▲ / ▼ button to select **Auto Tuning**.
- 3 Press the ► button and then ▲ / ▼ button to select **System**.
- 4 Press the ▲ / ▼ button to select a TV system menu:  
BG: PAL B/G, SECAM B/G (Europe / East Europe / Asia / NewZealand / M.East / Africa / Australia)  
I : PAL I/II (U.K. / Ireland / Hong Kong / South Africa)  
DK: PAL D/K, SECAM D/K (East Europe / China / Africa / CIS)  
M : NTSC M (Taiwan, Philippines, Myanmar)
- 5 Press the ▲ / ▼ button to select **Storage From**.
- 6 Press the ◀ / ▶ button or NUMBER buttons to select the initial programme number. If you use NUMBER buttons, any number under 10 is entered with a numeric '0' in front of it, i.e. '05' for 5.
- 7 Press the ▲ / ▼ button to select **Search**.
- 8 Press the ► button to begin auto tuning.  
All receivable stations are stored.

To stop auto tuning, press the **RETURN** button.  
When auto tuning is complete, the Programme edit menu appears on the screen. See the Programme edit section to edit the stored programme.

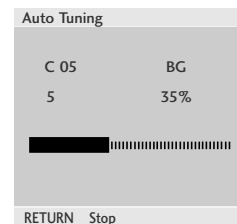
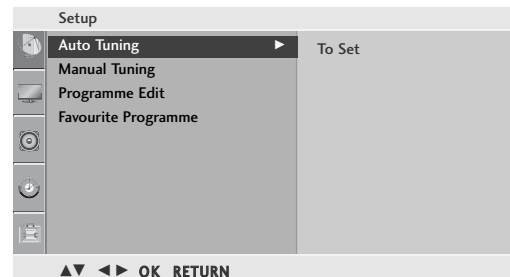

- Press the **MENU** button to close the menu window.
- Press the **RETURN** button to move to the previous menu screen.



# WATCHING TV /PROGRAMME CONTROL

## MANUAL PROGRAMME TUNING

Manual programme lets you manually tune and arrange the stations in whatever order you desire.

- 1 Press the **MENU** button and then **▲ / ▼** button to select the **Setup** menu.
- 2 Press the **▶** button and then **▲ / ▼** button to select **Manual Tuning**.
- 3 Press the **▶** button and then **▲ / ▼** button to select **Storage**.
- 4 Press the **◀ / ▶** button or **NUMBER** buttons to select the desired programme number (0 to 99). If you use **NUMBER** buttons, any number under 10 is entered with a numeric '0' in front of it, i.e. '05' for 5.
- 5 Press the **▲ / ▼** button to select **System**.
- 6 Press the **▲ / ▼** button to select a TV system menu;  
BG: PAL B/G, SECAM B/G (Europe / East Europe / Asia / NewZealand / M.East / Africa / Australia)  
I : PAL I/II (U.K. / Ireland / Hong Kong / South Africa)  
DK: PAL D/K, SECAM D/K (East Europe / China / Africa / CIS)  
M : NTSC M(Taiwan, Philippines, Myanmar)
- 7 Press the **▲ / ▼** button to select **Band**.
- 8 Press the **▶** button and then **▲ / ▼** button to select **V/UHF** or **Cable**.
- 9 Press the **▲ / ▼** button to select **Channel**.
- 10 You can select the desired programme number with the **◀ / ▶** button or **NUMBER** buttons. If possible, select the programme number directly with the number buttons. Any number under 10 is entered with a numeric '0' in front of it, i.e. '05' for 5.
- 11 Press the **▲ / ▼** button to select **Search**.
- 12 Press the **◀ / ▶** button to commence searching. If a station is found the search will stop.
- 13 Press the **OK** button to store it.
- 14 To store another station, repeat steps 3 to 13.

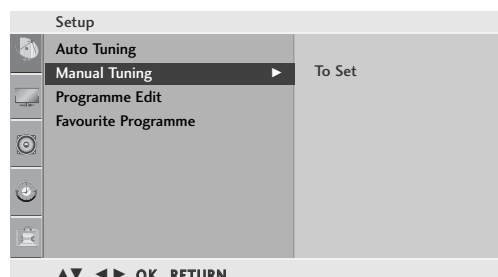

- Press the **MENU** button to close the menu window.
- Press the **RETURN** button to move to the previous menu screen.

# WATCHING TV /PROGRAMME CONTROL

## FINE TUNING

Normally fine tuning is only necessary if reception is poor.

- 1 Press the **MENU** button and then **▲ / ▼** button to select the **Setup** menu.
- 2 Press the **▶** button and then **▲ / ▼** button to select **Manual Tuning**.
- 3 Press the **▶** button and then **▲ / ▼** button to select **Fine**.
- 4 Press the **▶** button and then **▲ / ▼** button to fine tune for the best picture and sound.
- 5 Press the **OK** button to store it.

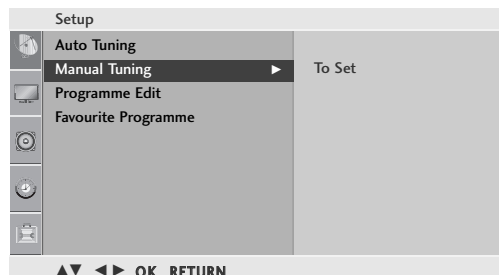

## ASSIGNING A STATION NAME

You can assign a station name up to five characters to each programme number.

- 1 Press the **▶** button and then **▲ / ▼** button to select **Name**.
- 2 Press the **▶** button and then **▲ / ▼** button. You can use a blank, **+**, **-**, the number **0** to **9** and the alphabet **A** to **Z**.
- 3 Press the **◀ / ▶** button to select the position and make your choice of the second character, and so on.
- 4 Press the **OK** button to store it.



## BOOSTER

In some models, **Booster** is an optional function. Only a set with **Booster** can perform this function.

If reception is poor select **Booster** to **On**.

When the signal is strong, select "OFF".

- 1 Press the **▶** button and then use **▲ / ▼** button to select **Booster**.
- 2 Press the **▶** button and then use **▲ / ▼** button to select **On** or **Off**.

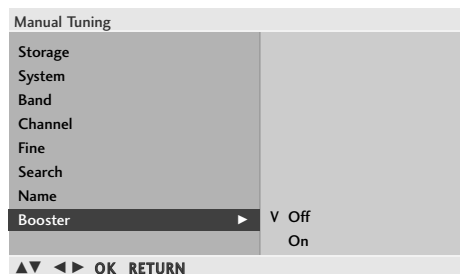

- Press the **MENU** button to close the menu window.
- Press the **RETURN** button to move to the previous menu screen.

# WATCHING TV /PROGRAMME CONTROL

## PROGRAMME EDIT

This function enables you to delete or skip stored programmes. Also you can move some stations to other programme numbers or copy a blank station data into the selected programme number.

- 1 Press the **MENU** button and then **▲ / ▼** button to select the **Setup** menu.
- 2 Press the **▶** button and then **▲ / ▼** button to select **Programme Edit**.
- 3 Press the **▶** button to display the Programme edit menu.

### ■ Deleting a programme

1. Select a programme to be deleted with the **▲ / ▼ / ◀ / ▶** button.
2. Press the **RED** button twice.  
The selected programme is deleted, all the following programmes are shifted up one position.

### ■ Copying a programme

1. Select a programme to be copied with the **▲ / ▼ / ◀ / ▶** button.
2. Press the **GREEN** button.  
All the following programmes are shifted down one position.

### ■ Moving a programme

1. Select a programme to be moved with the **▲ / ▼ / ◀ / ▶** button.
2. Press the **YELLOW** button.
3. Move the programme to the desired programme number with the **▲ / ▼ / ◀ / ▶** button.
4. Press the **YELLOW** button again to release this function.

### ■ Skipping a programme number

1. Select a programme number to be skipped with the **▲ / ▼ / ◀ / ▶** button.
2. Press the **BLUE** button. The skipped programme turns to blue.
3. Press the **BLUE** button again to release the skipped programme.  
When a programme number is skipped it means that you will be unable to select it using the **▲ / ▼** button during normal TV viewing. If you wish to select the skipped programme, directly enter the programme number with the **NUMBER** buttons or select it in the programme edit or table menu.

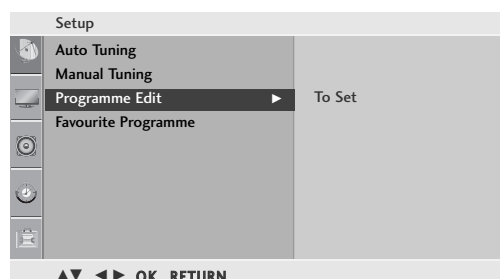

0	C	03	5	S	69
1	BLN	03	6	S	17
2	C	12	7	S	22
3	S	66	8	C	09
4	S	67	9	C	11

Legend:  
● Delete      ● Copy  
● Move        ● Skip

Navigation buttons: ▲▼, ◀▶, OK, RETURN

- Press the **MENU** button to close the menu window.
- Press the **RETURN** button to move to the previous menu screen.

# WATCHING TV /PROGRAMME CONTROL

## FAVOURITE PROGRAMME

This function lets you select your favourite programmes directly.

- 1 Press the **MENU** button and then ▲ / ▼ button to select the **Setup** menu.
- 2 Press the ► button and then ▲ / ▼ button to select **Favourite Programme**.
- 3 Press the ► button.
- 4 Press the ▲ / ▼ button to select - - - - -.
- 5 Select a desired programme with the ◀ / ▶ button or NUMBER buttons. Any number under 10 is entered with a numeric '0' in front of it, i.e. '05' for 5.
- 6 To store another programme, repeat steps 4 to 5. You can store up to 8 programmes.

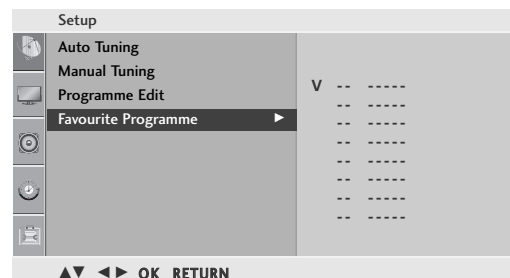

- Press the **MENU** button to close the menu window.
- Press the **RETURN** button to move to the previous menu screen.

# WATCHING TV /PROGRAMME CONTROL

## SELECTING THE PROGRAMME LIST

You can check which programmes are stored in the memory by displaying the programme list.

### ■ Displaying programme list

Press the **LIST** button to display the Programme list menu.

The programme list appears on the screen.

One programme list contains ten programmes as shown.

### ! NOTE

- You may find some blue programmes. They have been set up to be skipped by auto programming or in the programme edit mode.
- Some programmes with the channel number shown in the programme list indicate there is no station name assigned.

### ■ Selecting a programme in the programme list

Select a programme with the ▲ / ▼ / ◀ / ▶ button.

Then press the **OK** button. The TV switches to the chosen programme number.

### ■ Paging through a programme list

There are 10 programme table pages in which contain 100 programmes some countries contain 200 programmes. Pressing the ▲ / ▼ / ◀ / ▶ button repeatedly turns the pages.

Press the **LIST** button to close the programme list window.

0	C	03	5	S	69
1	BLN	03	6	S	17
2	C	12	7	S	22
3	S	66	8	C	09
4	S	67	9	C	11

◀ ▶ ▲ ▼ OK RETURN

# PICTURE CONTROL

## WATCHING PIP (PICTURE-IN-PICTURE)

PIP lets you view 2 different inputs (sources) on your TV screen at the same time.  
One source will be large, and the other source will show a smaller inset image.  
PIP function is available in the RGB-PC, DVI input only.  
(It can support TV, AV mode)

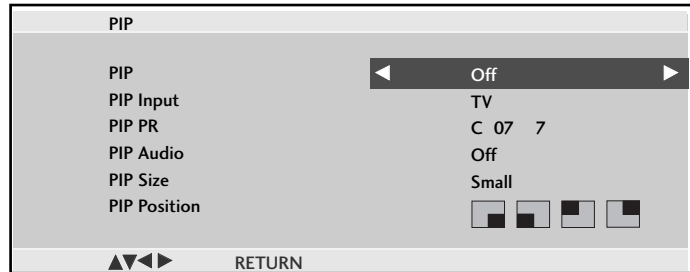

### Watching PIP/Double Window

Each time you press the PIP button it will change to PIP -> DW1 -> DW2 -> PIP Off.

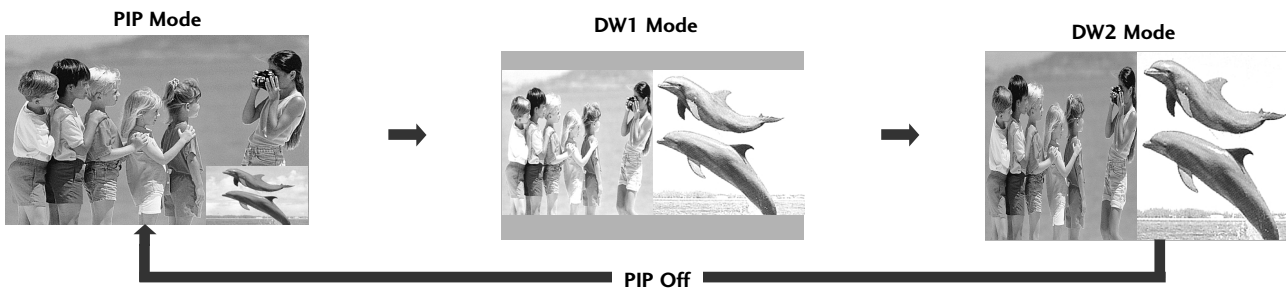

### Programme Selection for Sub Picture

Enter the PIP menu and then press the ▲ / ▼ / ◀ / ▶ button to select a programme for the sub picture.  
The selected programme number is displayed just below RGB-PC or DVI input.

### Input Source Selection for Sub Picture

Enter the PIP menu and then press the ▲ / ▼ / ◀ / ▶ button to select the PIP Input source for the sub picture.  
(Sub picture can be selected only TV, AV)

### Audio Source Selection for Sub Picture

Enter the PIP menu and then press the ▲ / ▼ / ◀ / ▶ button to select the PIP Audio source for the sub picture.

### Sub Picture Size Adjustment (PIP mode only)

Enter the PIP menu and then press the ▲ / ▼ / ◀ / ▶ button to adjust the sub picture size.

### Moving the Sub Picture (PIP mode only)

Enter the PIP menu and then press the ▲ / ▼ / ◀ / ▶ button to adjust the sub picture position.

#### NOTE

- ▶ A teletext function does not operate in PIP mode.
- ▶ In PIP mode, below remote controller keys are not available.  
\* NUMBER, FAV, Q.VIEW
- ▶ ARC function doesn't operate DW1, DW2 mode.

# PICTURE CONTROL

## PICTURE SIZE (ASPECT RATIO)CONTROL

You can watch the screen in various picture formats; **16:9**, **Original**, **4:3**, **14:9**, **Zoom1/2** and **Just Scan**.

Just Scan works in the following mode:

Component (720p/1080i/1080p), HDMI (720p/1080i/1080p)

If a fixed image is displayed on the screen for a long time, that fixed image may become imprinted on the screen and remain visible.

You can adjust the enlarge proportion using ▲ / ▼ button.

This function works in the following signal.

---

**1** You can adjust **Aspect Ratio** in the **Picture** menu.

---

- **16:9**

The following selection will allow you to adjust the picture horizontally, in linear proportion, to fill the entire screen (useful for viewing 4:3 formatted DVDs).



- **Original**

When your set receives a wide screen signal it will automatically change to the picture format to be broadcast.



- **4:3**

The following selection will allow you to view a picture with an original 4:3 aspect ration, grey bars will appear on both the left and right hand of the screen.

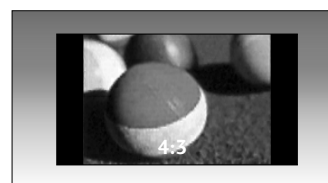

- **14:9**

You can view a picture format of 14:9 or a general TV programme in the 14:9 mode. The 14:9 screen is viewed in the same way as in 4:3, but is magnified to the left and right.



# PICTURE CONTROL

- **Zoom1**

The following selection will allow you to view the picture without any alteration, while filling the entire screen. However, the top and bottom of the picture will be cropped.

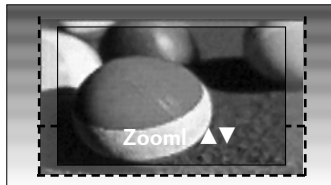

- **Zoom2**

Choose Zoom 2 when you wish the picture to be altered, both horizontally extended and vertically cropped. The picture adopting a compromise between alteration and screen coverage.

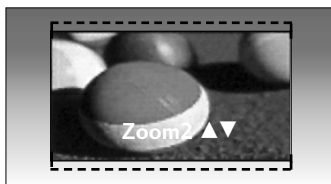

- **Just Scan**

Following Selection will lead to you view the picture of best quality without loss of original picture in high resolution image.

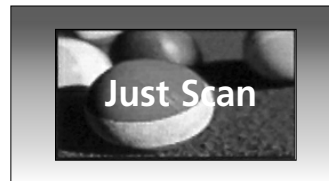

## ! NOTE

- ▶ You can only select 4:3,16:9 (Wide) in Component, HDMI, RGB(PC) mode.
- ▶ In HDMI/Component (over 720p) mode, Just Scan is available.



# PICTURE CONTROL

## PRESET PICTURE SETTINGS

### Picture Mode-Preset

Picture Mode adjusts the set for the best picture appearance. Select the preset value in the **Picture Mode** menu based on the programme category.

Vivid, Standard, Cinema, Sport and Game are programmed for optimum picture reproduction at the factory and cannot be changed.

- 1 Press the **MENU** button and then ▲ / ▼ button to select the **Picture** menu.
- 2 Press the ► button and then ▲ / ▼ button to select **Picture Mode**.
- 3 Press the ► button and then ▲ / ▼ button to select **Vivid, Standard, Cinema, Sport, Game, User1 or User2**.

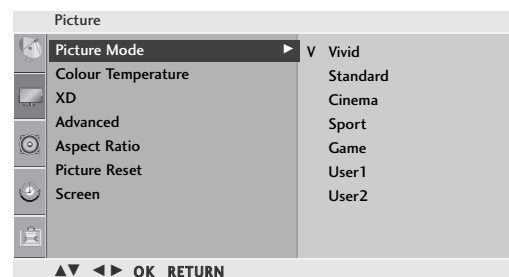

- Press the **MENU** button to close the menu window.
- Press the **RETURN** button to move to the previous menu screen.

# PICTURE CONTROL

## MANUAL PICTURE ADJUSTMENT

### Picture Mode-User Mode

<b>Backlight</b>	Adjust the brightness of LCD panel to control the brightness of the screen.
<b>Contrast</b>	Adjusts the difference between light and dark levels in the picture.
<b>Brightness</b>	Increases or decreases the amount of white in the picture.
<b>Colour</b>	Adjusts intensity of all colours.
<b>Sharpness</b>	Adjusts the level of crispness in the edges between the light and dark areas of the picture. The lower the level, the softer the image.
<b>Tint</b>	Adjusts the balance between red and green levels.

- 1 Press the **MENU** button and then **▲ / ▼** button to select the **Picture** menu.
- 2 Press the **▶** button and then **▲ / ▼** button to select **Picture Mode**.
- 3 Press the **▶** button and then **▲ / ▼** button to select **User1** or **User2**.
- 4 Press the **▶** button and then **▲ / ▼** button to select the desired picture option.
  - **TV/AV/Component/HDMI:** Backlight, Contrast, Brightness, Colour, Sharpness and Tint
  - **RGB-PC/DVI-PC:** Backlight, Contrast, Brightness
- 5 Press the **◀ / ▶** button to make appropriate adjustments.

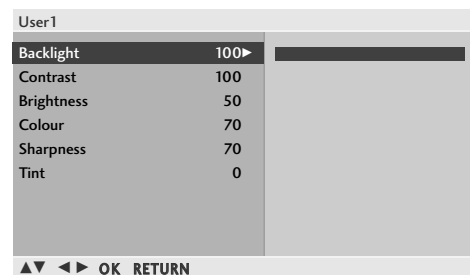
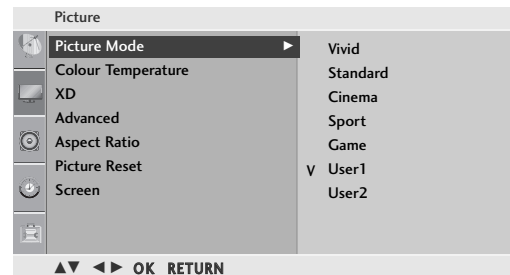

<TV/AV/Component/HDMI>

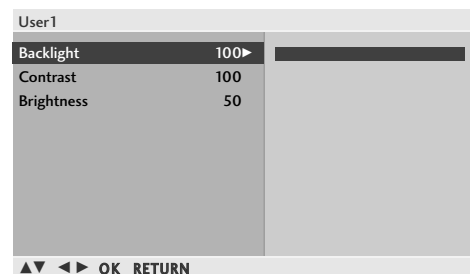

<RGB-PC/DVI-PC>

- Press the **MENU** button to close the menu window.
- Press the **RETURN** button to move to the previous menu screen.

# PICTURE CONTROL

## Auto Colour Tone Control(Cool/Medium/Warm)

To initialize values (reset to default settings), select the Cool option.

Choose one of three automatic colour adjustments. Set to warm to enhance hotter colours such as red, or set to cool to see less intense colours with more blue.

This menu is activated after selecting “User1” or “User2” in the Picture Mode.

- 1 Press the **MENU** button and then **▲ / ▼** button to select the **Picture** menu.
- 2 Press the **▶** button and then **▲ / ▼** button to select **Colour Temperature**.
- 3 Press the **▶** button and then **▲ / ▼** button to select either **Cool, Medium, Warm** or **User**.

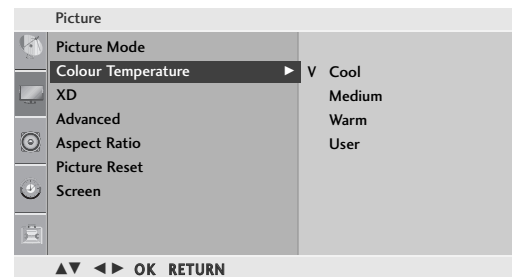

## Auto Colour Tone Control (9300K/6500K/sRGB) (RGB-PC, DVI-PC mode only)

To initialize values (reset to default settings), select the 6500K option.

This menu is activated after selecting “User1” or “User2” in the Picture Mode.

- 1 Press the **▶** button and then **▲ / ▼** button to select either **9300K, 6500K, sRGB** or **User**.

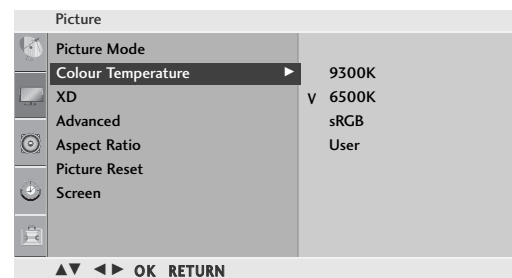

- Press the **MENU** button to close the menu window.
- Press the **RETURN** button to move to the previous menu screen.

### ! NOTE

- ▶ Auto colour tone is displayed with cool/medium/warm in the following mode.  
RGB-PC(1080i), DVI(480i, 1080i)

# PICTURE CONTROL

## Colour Tone - User Mode

To adjust red, green, blue to any colour temperature you prefer.

This menu is activated after selecting "User1" or "User2" in the Picture Mode.

- 1 Press the **MENU** button and then ▲ / ▼ button to select the **Picture** menu.
- 2 Press the ► button and then ▲ / ▼ button to select **Colour Temperature**.
- 3 Press the ► button and then ▲ / ▼ button to select **User**.
- 4 Press the ► button and then ▲ / ▼ button to select **Red, Green** or **Blue**.
- 5 Press the ◀ / ▶ button to make appropriate adjustments.

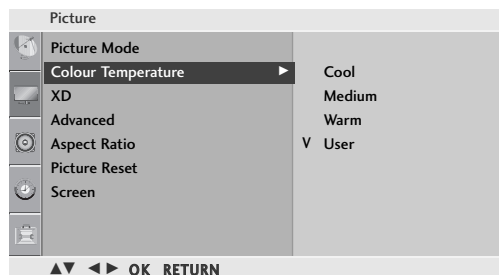

<TV/AV/Component/HDMI>

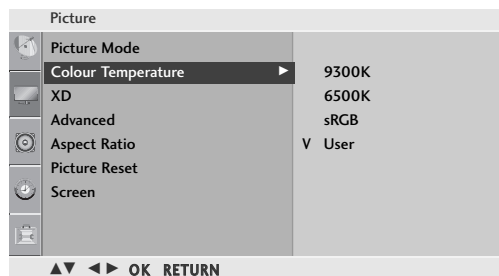

<RGB-PC/DVI-PC>

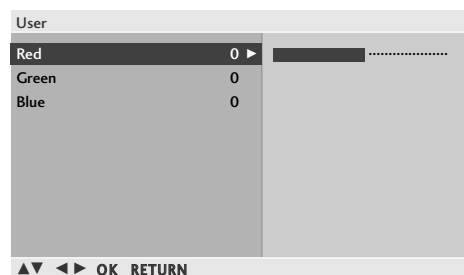

- Press the **MENU** button to close the menu window.
- Press the **RETURN** button to move to the previous menu screen.

# PICTURE CONTROL

## **XD** - PICTURE IMPROVEMENT TECHNOLOGY

XD is LG electronic's unique picture improving technology to display a real HD source through an advanced digital signal processing algorithm.

It is not possible to use this function in RGB-PC/DVI input.

This menu is activated after selecting the **User1** or **User2** of **Picture Mode**.

- 1 Press the MENU button and then ▲ / ▼ button to select the **Picture** menu.
- 2 Press the ► button and then ▲ / ▼ button to select **XD**.
- 3 Press the ► button and then ▲ / ▼ button to select **Auto** or **Manual**.

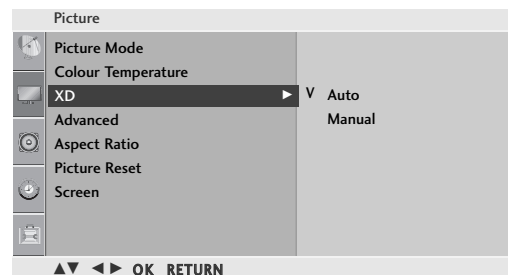

### \* Manual Selection

- 1 Press the ► button and then ▲ / ▼ button to select **XD Contrast**, **XD Colour** or **XD NR**.
- 2 Press the ► button and then ▲ / ▼ button to select **Off**, **Low** or **High**.  
Select **Off**, **Low**, **High** or **Adaptive** (Only XD NR).

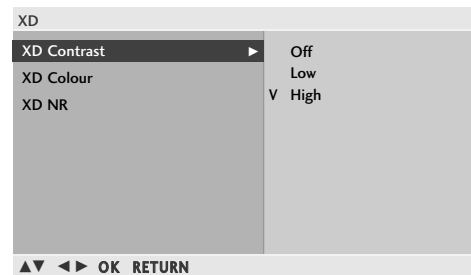

- **XD Contrast** : Optimises the contract automatically according to the brightness of the reflection.
- **XD Colour** : Adjusts the colour of the reflection automatically to reproduce as close as possible to natural colours.
- **XD NR** : Removes interference up to the point where it does not damage the original picture.

- Press the MENU button to close the menu window.
- Press the RETURN button to move to the previous menu screen.

# PICTURE CONTROL

## ADVANCED - GAMMA

High gamma values display whitish images and low gamma values display high contrast images. It is not possible to use this function in RGB-PC/DVI input.

- 1 Press the **MENU** button and then **▲ / ▼** button to select the **Picture** menu.
- 2 Press the **▶** button and then **▲ / ▼** button to select **Advanced**.
- 3 Press the **▶** button and then **▲ / ▼** button to select **Gamma**.
- 4 Press the **▶** button and then **▲ / ▼** button to select **Low**, **Medium** or **High**.

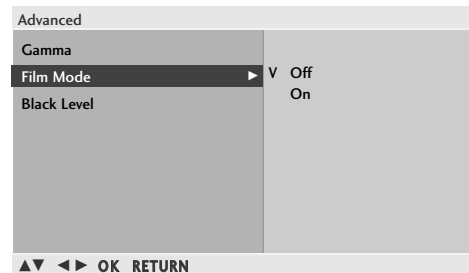
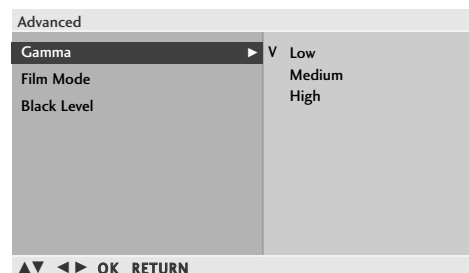
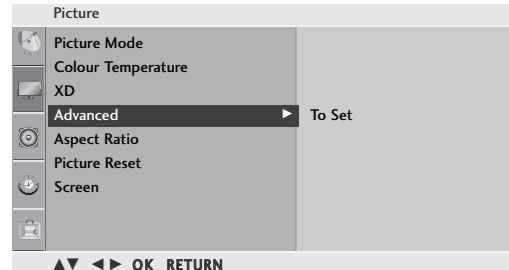

## ADVANCED - Film Mode

To set up for the best picture quality for viewing films. This feature operates only in TV, AV and Component 480i/576i mode.

- 1 Press the **▶** button and then **▲ / ▼** button to select **Film Mode**.
- 2 Press the **▶** button and then **▲ / ▼** button to select **On** or **Off**.

## ADVANCED - BLACK(DARKNESS) LEVEL

When you view a film this function adjust the set to best picture quality. Adjusting the contrast and the brightness of the screen using the black level of the screen.

This function works in the following mode:  
RF(NTSC-M), AV(NTSC-M, NTSC 4.43), Component or HDMI.

- 1 Press the **▶** button and then **▲ / ▼** button to select **Black Level**.
- 2 Press the **▶** button and then **▲ / ▼** button to select **Low** or **High**.
  - **Low** : The reflection of the screen gets darker.
  - **High** : The reflection of the screen gets brighter.

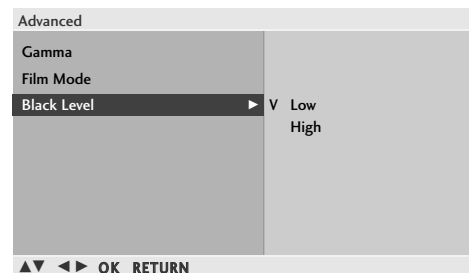

- Press the **MENU** button to close the menu window.
- Press the **RETURN** button to move to the previous menu screen.

# PICTURE CONTROL

## PICTURE RESET

Returns to the default factory setting for Picture Mode, Colour Temperature, XD, Advanced, Aspect Ratio.

- 1 Press the **MENU** button and then **▲ / ▼** button to select the **Picture** menu.
- 2 Press the **▶** button and then **▲ / ▼** button to select **Picture Reset**.
- 3 Press the **▶** button to initialize the adjusted value.

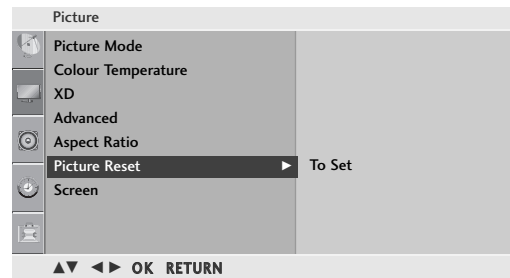

- Press the **MENU** button to close the menu window.
- Press the **RETURN** button to move to the previous menu screen.

# PICTURE CONTROL

## SCREEN SETUP FOR PC MODE

### Auto Configure (RGB [PC] mode only)

Automatically adjusts picture position and minimizes image instability. After adjustment, if the image is still not correct, your set is functioning properly but needs further adjustment.

#### Auto configure

This function is for automatic adjustment of the screen position, clock, and phase. The displayed image will be unstable for a few seconds while the auto configuration is in progress.

#### 1. Using OSD

- 1 Press the **MENU** button and then use **▲ / ▼** button to select the **Picture** menu.
- 2 Press the **▶** button and then use **▲ / ▼** button to select **Screen**.
- 3 Press the **▶** button and then use **▲ / ▼** button to select **Auto Config.**
- 4 Press the **▶** button to start **Auto Config.**
  - When Auto config. has finished, OK will be shown on screen.
  - If the position of the image is still not correct, try Auto adjustment again.
  - If picture needs to be adjusted again after Auto adjustment in RGB (PC), you can adjust the **Manual Config.**

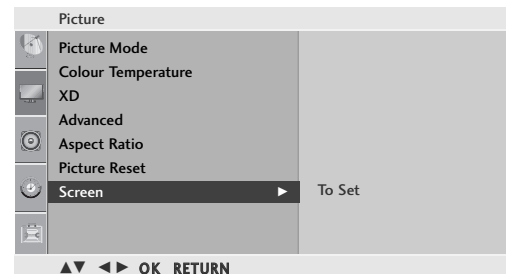

#### 2. Using OK (Remocon or control key)

This function is available for RGB signals only.

- 1 Press the OK button. **Auto Config. (OK)**
- 2 Press the OK button. **Auto in progress**  
**<1920 x 1080 Resolution>**

• If you don't want Auto Configure, do not press **⊙ OK**

**Auto in progress**  
For optimal display change resolution to 1920 x 1080  
**<Others Resolution>**

- Press the **MENU** button to close the menu window.
- Press the **RETURN** button to move to the previous menu screen.



# PICTURE CONTROL

## Manual Configure (Adjustment for screen Phase, Clock, Position) (RGB [PC] mode only)

If the picture is not clear after auto adjustment and especially if characters are still trembling, adjust the picture phase manually.

To correct the screen size, adjust **Clock**.

It's not available to use Phase, Clock function in COMPONENT (480i/480p/576i/576p/720p/1080i/1080p), HDMI (480p/576p/720p/1080i/1080p).

**Clock** This function is to minimize any vertical bars or stripes visible on the screen background the horizontal screen size will also change.

**Phase** This function allows you to remove any horizontal noise and clear or sharpen the image of characters.

- 1 Press the **MENU** button and then use ▲ / ▼ button to select the **Picture** menu.
- 2 Press the ► button and then use ▲ / ▼ button to select **Screen**.
- 3 Press the ► button and then use ▲ / ▼ button to select **Manual Config.**
- 4 Press the ► button and then use ▲ / ▼ button to select **Phase, Clock, H-Position** or **V-Position**.
- 5 Press the ◀ / ▶ button to make appropriate adjustments.

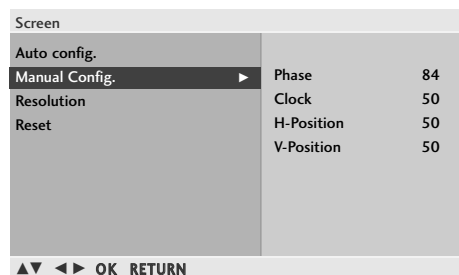
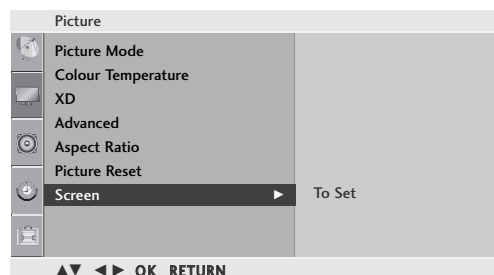

- Press the **MENU** button to close the menu window.
- Press the **RETURN** button to move to the previous menu screen.

# PICTURE CONTROL

## Selecting Resolution

To view a normal picture, match the resolution of RGB mode and selection of Resolution.

This function works in the following mode: RGB-PC input mode.

- 1 Press the **MENU** button and then use ▲ / ▼ button to select the **Picture** menu.
- 2 Press the ► button and then use ▲ / ▼ button to select **Screen**.
- 3 Press the ► button and then use ▲ / ▼ button to select **Resolution**
- 4 Press the ► button and then use ▲ / ▼ button to select the desired Resolution.

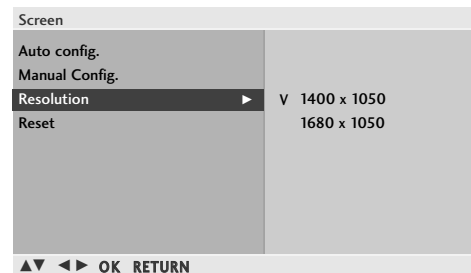
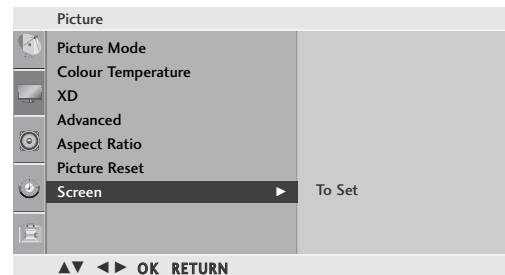

## Initializing (Reset to original factory settings)

This function operates in current mode.

To initialize the adjusted value

- 1 Press the ► button and then use ▲ / ▼ button to select **Reset**.
- 2 Press the ► button.

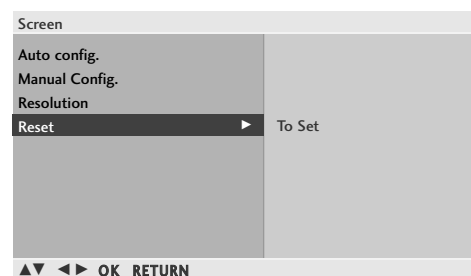

- Press the **MENU** button to close the menu window.
- Press the **RETURN** button to move to the previous menu screen.

# SOUND CONTROL

## PRESET SOUND SETTINGS-SOUND MODE

You can select your preferred sound setting; **SRS TS XT, Clear Voice, Standard, Music, Cinema, Sport or Game** and you can also adjust the frequency of the equalizer.

Sound Mode lets you enjoy the best sound without any Special adjustment as the sets the appropriate sound options based on the programme content.

**TruSurround XT(SRS TS XT), Clear Voice, Standard, Music, Cinema, Sport and Game** are preset for optimum sound quality at the factory and are not adjustable.

- 1 Press the **MENU** button and then **▲ / ▼** button to select the **Audio** menu.
- 2 Press the **▶** button and then **▲ / ▼** button to select **Sound Mode**.
- 3 Press the **▶** button and then **▲ / ▼** button to select **SRS TS XT, Clear Voice, Standard, Music, Cinema, Sport, Game or User**.

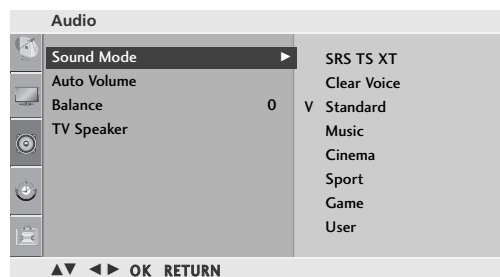

## SOUND SETTING ADJUSTMENT -USER MODE

Adjusting the audio equalizer.

- 1 Press the **▶** button and then **▲ / ▼** button to select **User**.
- 2 Press the **▶** button.
- 3 Select a frequency band by pressing the **◀ / ▶** button. Set the desired sound level with the **▲ / ▼** button.

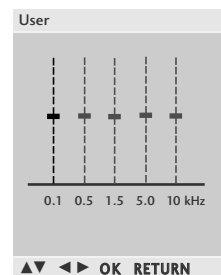
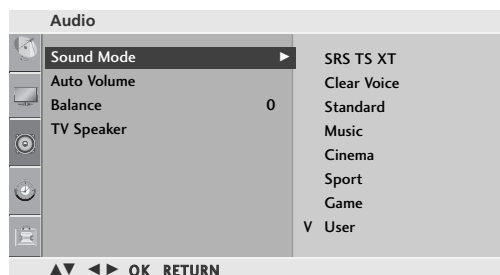

- Press the **MENU** button to close the menu window.
- Press the **RETURN** button to move to the previous menu screen.

- ▶ **SRS** is a trademark of SRS Labs, Inc.
- ▶ TruSurround XT technology is incorporated under license from SRS Labs, Inc.

# SOUND CONTROL

## AUTO VOLUME LEVELER

Auto Volume automatically remains on the same level of volume if you change programmes.

- 1 Press the **MENU** button and then **▲ / ▼** button to select the **Audio** menu.
- 2 Press the **▶** button and then **▲ / ▼** button to select **Auto Volume**.
- 3 Press the **▶** button and then **▲ / ▼** button to select **On** or **Off**.

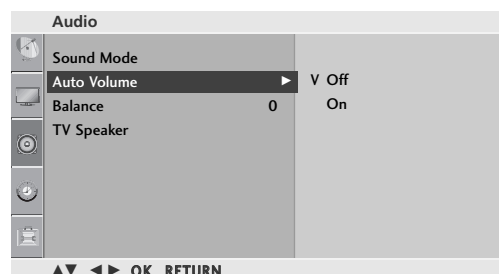

## BALANCE

You can adjust the sound balance of the speakers to the preferred levels.

- 1 Press the **▶** button and then **▲ / ▼** button to select **Balance**.
- 2 Press the **▶** button and then **◀ / ▶** button to make desired adjustment.

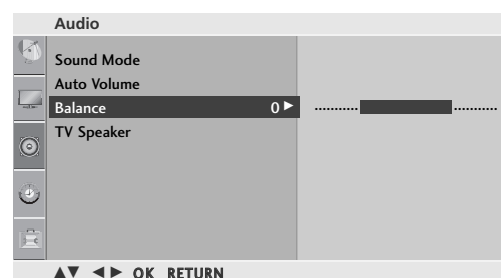

## TV SPEAKERS ON/OFF SETUP

You can adjust the internal speaker status.

In TV, AV, COMPONENT and HDMI mode, internal speaker audio can be operational even though there is no video signal. If you wish to use an external hi-fi system, turn off the TV internal speakers.

- 1 Press the **▶** button and then **▲ / ▼** button to select **TV Speaker**.
- 2 Press the **▶** button and then **▲ / ▼** button to select **On** or **Off**.

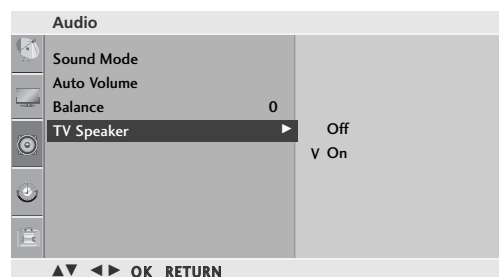

- Press the **MENU** button to close the menu window.
- Press the **RETURN** button to move to the previous menu screen.

# SOUND CONTROL

## I/II

### Stereo/Dual Reception

When a programme is selected, the sound information for the station appears with the programme number and station name.

- 1 Press the I/II button and then ▲ / ▼ button.

Broadcast	On Screen Display
Mono	MONO
Stereo	STEREO
Dual	DUAL I, DUAL II, DUAL I+II

#### ■ Mono sound selection

If the stereo signal is weak in stereo reception, you can switch to mono. In mono reception, the clarity of sound is improved. To switch back to stereo.

#### ■ Language selection for dual language broadcast

If a programme can be received in two languages (dual language), you can switch to DUAL I, DUAL II or DUAL I+II.

- DUAL I Sends the primary broadcast language to the loudspeakers.
- DUAL II Sends the secondary broadcast language to the loudspeakers.
- DUAL I+II Sends a separate language to each loudspeaker.

## NICAM Reception

If the set is equipped with a receiver for NICAM reception, high quality NICAM (Near Instantaneous Companding Audio Multiplex) digital sound can be received.

Sound output can be selected according to the type of broadcast received.

- 1 When NICAM MONO is received, you can select NICAM MONO or FM MONO.
- 2 When NICAM stere is received, you can select NICAM STEREO or FM MONO. If the stereo signal is weak, switch to FM MONO.
- 3 When NICAM dual is received, you can select NICAM DUAL I, NICAM DUAL II or NICAM DUAL I+II or FM MONO.

## Speaker Sound Output Selection

In AV, Component, RGB-PC, HDMI and DVI mode, you can select output sound for the left and right loudspeakers.

Select the sound output.

L+R: Audio signal from audio L input is sent to the left loudspeaker and audio signal from audio R input is sent to the right loudspeaker.

L+L: Audio signal from audio L input is sent to left and right loudspeakers.

R+R: Audio signal from audio R input is sent to left and right loudspeakers.

# TIME SETTING

## CLOCK SETUP

You must set the time correctly before using on/off timer function.

If current time setting is erased by a power failure or the set is unplugged, reset the clock.

- 1 Press the **MENU** button and then **▲ / ▼** button to select the **Time** menu.
- 2 Press the **▶** button and then **▲ / ▼** button to select **Clock**.
- 3 Press the **▶** button and then **▲ / ▼** button to set the hour.
- 4 Press the **▶** button and then **▲ / ▼** button to set the minute.

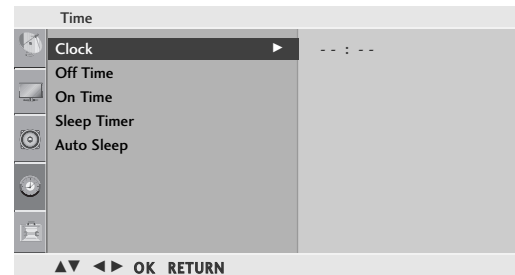

## AUTO ON/OFF TIME SETTING

The Off time function automatically switches the set to standby at a preset time.

Two hours after the set is switched on by the on time function it will automatically switch off unless a button has been pressed.

Once the on time/off time is set, these functions operate daily at the preset time.

The Off time function overrides the On timer function if both are set to the same time.

- 1 Press the **▶** button and then **▲ / ▼** button to select **On/Off Time**.
  - To cancel **On/Off Time** function, select **Off**.
- 2 Press the **▶** button and then **▲ / ▼** button to set the hour.
- 3 Press the **▶** button and then **▲ / ▼** button to set the minutes.
- 4 **For On Time function only**
  - **Programme:** Press the **▶** button and then **▲ / ▼** button to select the programme.
  - **Volume:** Press the **▶** button and then **▲ / ▼** button to adjust volume level at switch-on.



- Press the **MENU** button to close the menu window.
- Press the **RETURN** button to move to the previous menu screen.

# TIME SETTING

## SLEEP TIMER SETTING

You do not have to remember to switch the set off before you go to sleep. The sleep timer automatically switches the set off after the preset time has elapsed.

- 1 Press the **MENU** button and then ▲ / ▼ button to select the **Time** menu.
- 2 Press the ► button and then ▲ / ▼ button to select **Sleep Timer**.
- 3 Press the ► button and then ▲ / ▼ button to set the minute.

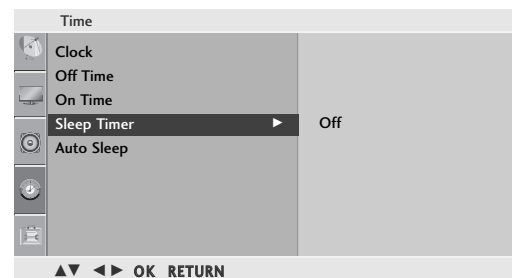

### ! NOTE

- ▶ When you switch the set off, the set releases the preset sleep timer.

## AUTO SHUT-OFF SETTING

If the set is switched on and there is no input signal, it will switch off automatically after 10 minutes.

- 1 Press the ► button and then ▲ / ▼ button to select **Auto Sleep**.
- 2 Press the ► button and then ▲ / ▼ button to select **On** or **Off**.

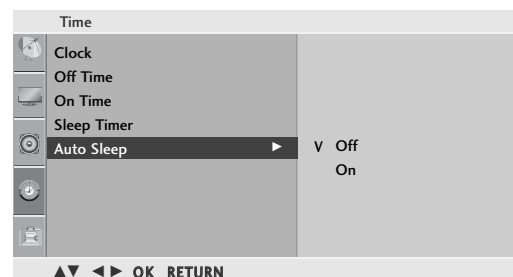

- Press the **MENU** button to close the menu window.
- Press the **RETURN** button to move to the previous menu screen.

# OPTION SETTING

## ON-SCREEN MENU LANGUAGE SELECTION

Installation guide menu appears on set screen when it is turned on for the first time.

- 1 Press the ▲ / ▼ / ◀ / ▶ button and then, **OK** button to select your desired language.

### \* If you want to change Language selection

- 1 Press the **MENU** button and then use ▲ / ▼ button to select the **OPTION** menu.
- 2 Press the ▶ button and then use ▲ / ▼ button to select **Language**.
- 3 Press the ▶ button and then use ▲ / ▼ / ◀ / ▶ button to select your desired language. The menus can be shown on the screen in the selected language.
- 4 Press the **OK** button.



<M2394A>

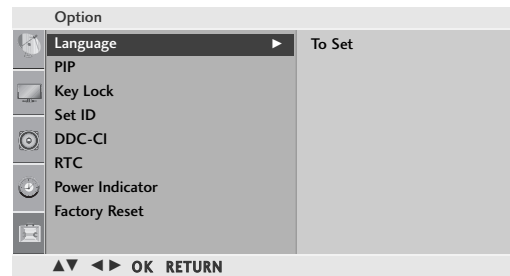

<M2794A>

- Press the **MENU** button to close the menu window.
- Press the **RETURN** button to move to the previous menu screen.

### ! NOTE

- ▶ If you don't finish set up **Installation Guide** by pressing **RETURN** button or time out of OSD (On Screen Display) display, it will continuously appear until completing set up whenever the set is turned on.



# OPTION SETTING

## KEY LOCK

The set can be set so that the remote control is needed to control it.

This feature can be used to prevent unauthorized viewing.

This set is programmed to remember which option it was last set to even if you turn the set off.

- 1 Press the **MENU** button and then **▲ / ▼** button to select the **Option** menu.
- 2 Press the **▶** button and then **▲ / ▼** button to select **Key Lock**.
- 3 Press the **▶** button and then **▲ / ▼** button to select **On** or **Off**.

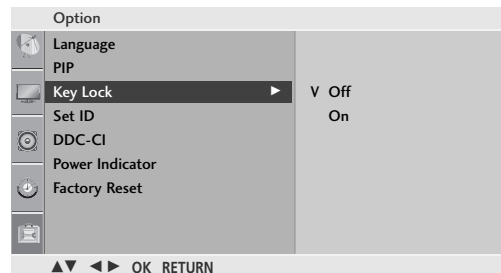

<M2394A>

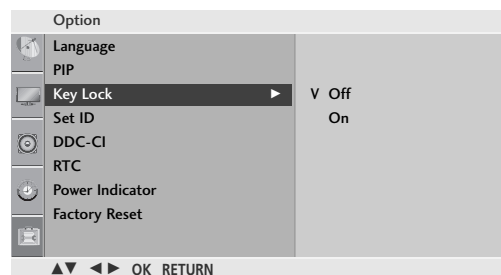

<M2794A>

- Press the **MENU** button to close the menu window.
- Press the **RETURN** button to move to the previous menu screen.

### ! NOTE

- ▶ In **Key Lock 'On'**, if the set is turned off, press the **⏻ / I, INPUT, PR ▲ / ▼** button on the set or **POWER, INPUT, PR ▲ / ▼** or **NUMBER** buttons on the remote control.
- ▶ With the **Key Lock On**, the display 'Key Lock On' appears on the screen if any button on the right side of set is pressed while using the set.

# OPTION SETTING

## DDC CI(Only RGB, DVI mode)

DDC/CI (Display Data Channel Command Interface) is a communication protocol for communications between PC and set.

DDC/CI makes it possible to adjust and setup detailed functions on PC instead of the set OSD.

Set can be adjusted with PC by connecting communication between PC and set when DDC/CI is ON, and set cannot be adjusted with PC because communication between PC and set is disconnected when DDC/CI is OFF.

- 1 Press the **MENU** button and then **▲ / ▼** button to select the **Option** menu.
- 2 Press the **▶** button and then **▲ / ▼** button to select **DDC-CI**.
- 3 Press the **▶** button and then **▲ / ▼** button to select **On** or **Off**.

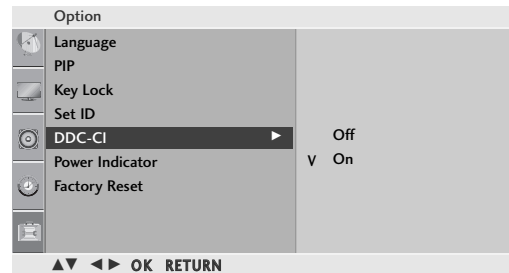

<M2394A>

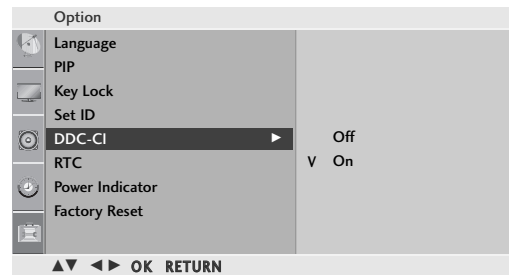

<M2794A>

## RTC (Only M2794A)

If you set ON, you enable the response time control function.

If you set OFF, you disable the response time control function.

- 1 Press the **▶** button and then **▲ / ▼** button to select **RTC**.
- 2 Press the **▶** button and then **▲ / ▼** button to select **On** or **Off**.

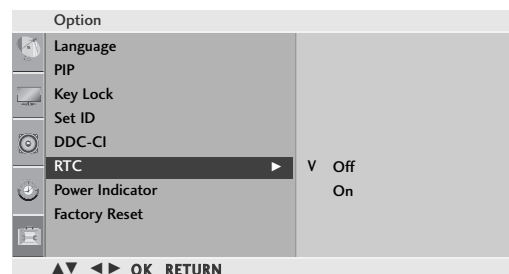

- Press the **MENU** button to close the menu window.
- Press the **RETURN** button to move to the previous menu screen.

# OPTION SETTING

## POWER INDICATOR

It helps you control LED when power is turned on.

- 1 Press the **MENU** button and then **▲ / ▼** button to select the **Option** menu.
- 2 Press the **▶** button and then **▲ / ▼** button to select **Power indicator**.
- 3 Press the **▶** button and then **▲ / ▼** button to select **On** or **Off**.

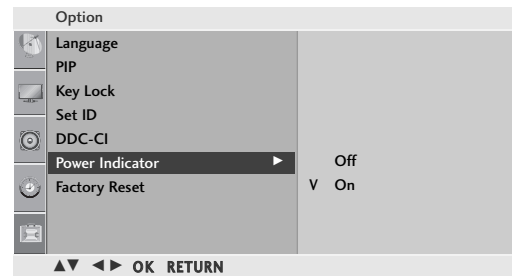

<M2394A>

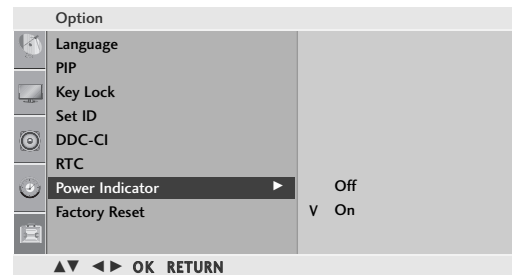

<M2794A>

## FACTORY RESET

Use to quickly reset all the menu options to their original factory preset values. The function deletes all TV programmes.

- 1 Press the **▶** button and then **▲ / ▼** button to select **Factory Reset**.
- 2 Press the **▶** button and then **◀ / ▶** button to select **Yes** or **No**.

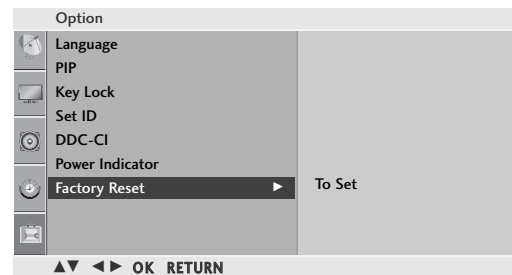

<M2394A>

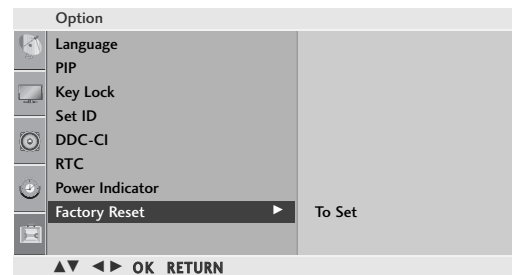

<M2794A>

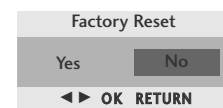

- Press the **MENU** button to close the menu window.
- Press the **RETURN** button to move to the previous menu screen.

# TELETEXT

**This feature is not available in all countries.**

Teletext is a free service broadcast by most TV stations which gives up-to-the-minute information on news, weather, television programmes, share prices and many other topics.

The teletext decoder of this TV can support the SIMPLE, TOP and FASTEXT systems. SIMPLE (standard teletext) consists of a number of pages which are selected by directly entering the corresponding page number. TOP and FASTEXT are more modern methods allowing quick and easy selection of teletext information.

## SWITCH ON/OFF

Press the **TEXT** button to switch to teletext. The initial page or last page viewed appears on the screen.

Two page numbers, TV station name, date and time are displayed on the screen headline. The first page number indicates your selection, while the second shows the current page displayed.

Press the **TEXT** or **RETURN** button to switch off teletext. The previous mode reappears.

## SIMPLE TEXT

### ■ Page selection

- 1 Enter the desired page number as a three digit number with the NUMBER buttons. If during selection you press a wrong number, you must complete the three digit number and then re-enter the correct page number.
- 2 The **PR ▲ / ▼** button can be used to select the preceding or following page.

### ■ Programming a colour button in LIST mode

If the TV is in SIMPLE text, TOP text or FASTEXT mode, press the  button to switch to LIST mode.

Four teletext page numbers of your choice can be colour coded and easily selected by pressing the corresponding coloured button on the remote control handset.

- 1 Press a coloured button.
- 2 Using the NUMBER buttons, select the page you wish to programme.
- 3 Press the OK button. The selected page is stored as the selected page number, blinking once to confirm this. From now on, you can select this page with the same coloured button.
- 4 The three other coloured buttons are programmed in this way.

# TELETEXT

## TOP TEXT

The user guide displays four fields-red, green, yellow and blue at the bottom of the screen. The yellow field denotes the next group and the blue field indicates the next block.

### ■ Block / group / page selection

- ① With the blue button you can progress from block to block.
- ② Use the yellow button to proceed to the next group with automatic overflow to the next block.
- ③ With the green button you can proceed to the next existing page with automatic overflow to the next group.  
Alternatively the **PR ▲** button can be used.
- ④ The red button return to the previous selection. Alternatively the **PR ▼** button can be used.

### ■ Direct page selection

As with SIMPLE teletext mode, you can select a page by entering it as a three digit number using the NUMBER buttons in TOP mode.

## FASTEXT

The teletext pages are colour coded along the bottom of the screen and are selected by pressing the corresponding coloured button.

### ■ Page selection

- ① Press the **⏏** button to select the index page.
- ② You can select the pages which are colour coded along the bottom line with corresponding coloured buttons.
- ③ As with SIMPLE teletext mode, you can select a page by entering its three digit page number with the NUMBER buttons in FASTEXT mode.
- ④ The **PR ▲ / ▼** button can be used to select the preceding or following page.

# TELETEXT

## SPECIAL TELETEXT FUNCTIONS



### ■ TIME

When viewing a TV programme, press this button to display the time at the top right hand corner of the screen. Press this button again to remove the display. In the teletext mode, press this button to select a sub page number. The sub page number is displayed at the bottom of the screen. To hold or change the sub page, press the RED/GREEN, **PR ▲ / ▼** or NUMBER buttons.

Press again to exit this function.



### ■ SIZE

Selects double height text.

Press this button to enlarge the top half of the page.

Press this button again to enlarge the bottom half of the page.

Press this button again to return to the normal display.



### ■ UPDATE

Displays the TV picture on the screen while waiting for a new teletext page. The display will appear at the top left hand corner of the screen. When the updated page is available then display will change to the page number. Press this button again to view the updated teletext page.



### ■ REVEAL

Press this button to display concealed information, such as solutions to riddles or puzzles.

Press this button again to remove the information from the display.



### ■ INDEX

Select the each index page.



### ■ HOLD

Stops the automatic page change which will occur if a teletext page consists of 2 or more sub pages. The number of sub pages and the sub page displayed is, usually, shown on the screen below the time. When this button is pressed the stop symbol is displayed at the top left-hand corner of the screen and the automatic page change is inactive. To continue press this button again.



### ■ MIX

Displays the teletext pages superimposed on the TV picture.

To switch the TV picture off press this button again.

# APPENDIX

## TROUBLESHOOTING

### The operation does not work normally.

The remote control doesn't work	<ul style="list-style-type: none"><li>■ Check to see if there is any object between the product and the remote control causing obstruction. Ensure you are pointing the remote control directly at the set.</li><li>■ Ensure that the batteries are installed with correct polarity (+ to +, - to -).</li><li>■ Ensure that the correct remote operating mode is set: TV, VCR, etc.</li><li>■ Install new batteries.</li></ul>
Power is suddenly turned off	<ul style="list-style-type: none"><li>■ Is the sleep timer set?</li><li>■ Check the power control settings. Power interrupted.</li><li>■ No broadcast on station tuned with <b>Auto sleep</b> activated.</li></ul>

### The video function does not work.

No picture & No sound	<ul style="list-style-type: none"><li>■ Check whether the product is turned on.</li><li>■ Try another channel. The problem may be with the broadcast.</li><li>■ Is the power cord inserted into wall power outlet?</li><li>■ Check your antenna direction and/or location.</li><li>■ Test the wall power outlet, plug another product's power cord into the outlet where the product's power cord was plugged in.</li></ul>
Picture appears slowly after switching on	<ul style="list-style-type: none"><li>■ This is normal, the image is muted during the product startup process. Please contact your service centre, if the picture has not appeared after five minutes.</li></ul>
No color, poor colour, or poor picture	<ul style="list-style-type: none"><li>■ Adjust Colour in menu option.</li><li>■ Keep a sufficient distance between the product and the VCR.</li><li>■ Try another channel. The problem may be with the broadcast.</li><li>■ Are the video cables installed properly?</li><li>■ Activate any function to restore the brightness of the picture.</li></ul>
Horizontal/vertical bars or picture shaking	<ul style="list-style-type: none"><li>■ Check for local interference such as an electrical appliance or power tool.</li></ul>
Poor reception on some channels	<ul style="list-style-type: none"><li>■ Station or cable product experiencing problems, tune to another station.</li><li>■ Station signal is weak, reorient antenna to receive weaker station.</li><li>■ Check for sources of possible interference.</li></ul>
Lines or streaks in pictures	<ul style="list-style-type: none"><li>■ Check antenna (Change the direction of the antenna).</li></ul>

# APPENDIX

The audio function does not work.	
Picture OK & No sound	<ul style="list-style-type: none"> <li>■ Press the <b>VOL</b> ◀ / ▶ button.</li> <li>■ Sound muted? Press <b>MUTE</b> button.</li> <li>■ Try another channel. The problem may be with the broadcast.</li> <li>■ Are the audio cables installed properly?</li> </ul>
No output from one of the speakers	<ul style="list-style-type: none"> <li>■ Adjust <b>Balance</b> in menu option.</li> </ul>
Unusual sound from inside the product	<ul style="list-style-type: none"> <li>■ A change in ambient humidity or temperature may result in an unusual noise when the product is turned on or off and does not indicate a problem with the product.</li> </ul>

## Only RGB/DVI mode applied

No image is displayed.	
Power is on, power indicator is blue but the screen appears extremely dark.	<ul style="list-style-type: none"> <li>■ Adjust brightness and contrast again.</li> </ul>
Does the power indicator look amber?	<ul style="list-style-type: none"> <li>■ If the product is in power saving mode, move the mouse or press any key.</li> </ul>
Does the 'Out of range' message appear?	<ul style="list-style-type: none"> <li>■ The signal from the PC (Video card) is out of the vertical or horizontal frequency range of the product. Adjust the frequency range by referring to the Specifications in this user's guide.</li> </ul>
Does the 'Check signal cable' message appear?	<ul style="list-style-type: none"> <li>■ The signal cable between PC and product is not connected. Check the signal cable.</li> <li>■ Press the 'INPUT' button in the remote control to check the input signal.</li> </ul>



# APPENDIX

## 'Unknown Product' message appears when the product is connected.

Did you install the driver?	<ul style="list-style-type: none"> <li>■ Install the product driver, which is provided with the product, or download it from the web site. (<a href="http://www.lge.com">http://www.lge.com</a>)</li> <li>■ See if the plug_&amp;_play function is supported by referring to the video card user's guide.</li> </ul>
-----------------------------	--

## After-image appears on the product.

After-image appears when the product is turned off.	<ul style="list-style-type: none"> <li>■ If you use a fixed image for a long time, the pixels may be damaged quickly. Use the screen saver function.</li> </ul>
---	---

## Screen color is abnormal.

Screen has poor color resolution (16_colors).	<ul style="list-style-type: none"> <li>■ Set screen color resolution to more than 24 bits (true color) Select control Panel-Display-Settings-Color Table menu in Windows.</li> </ul>
Screen color is unstable or mono color.	<ul style="list-style-type: none"> <li>■ Check the connection status of the signal cable.</li> </ul>
Do back spots appear on the screen?	<ul style="list-style-type: none"> <li>■ Several pixels (red, green, white or black color) may appear on the screen, which can be attributable to the unique characteristics of the LCD panel. It is not a malfunction of the LCD.</li> </ul>

## Only RGB mode applied

### The screen image looks abnormal.

Is the screen position wrong?	<ul style="list-style-type: none"> <li>■ Adjust the Position menu in OSD.</li> <li>■ See if the video card resolution and frequency are supported by the product. If the frequency is out of range, set to the recommended resolution in the Control Panel-Display-Setting menu.</li> </ul>
Do thin lines appear on the background screen?	<ul style="list-style-type: none"> <li>■ Adjust the Clock menu in OSD.</li> </ul>
Horizontal noise appears or the characters look blurred.	<ul style="list-style-type: none"> <li>■ Adjust the Phase menu in OSD.</li> </ul>

# APPENDIX

## MAINTENANCE

Early malfunctions can be prevented. Careful and regular cleaning can extend the amount of time you can enjoy your new set.

**Caution:** Be sure to turn the power off and unplug the power cord before you begin any cleaning.

### Cleaning the Screen

- 1 To keep the dust off your screen for a while, wet a soft cloth in a mixture of lukewarm water and a little fabric softener or dishwashing detergent. Wring the cloth until it's almost dry, and then use it to wipe the screen.
- 2 Make sure the excess water is off the screen, and then let it air-dry before you turn on your set.

### Cleaning the Cabinet

- To remove dirt or dust, wipe the cabinet with a soft, dry, lint-free cloth.
- Please be sure not to use a wet cloth.

### Extended Absence

#### CAUTION

- ▶ If you expect to leave your set dormant for a long time (such as a vacation), it's a good idea to unplug the power cord to protect against possible damage from lightning or power surges.

# APPENDIX

## PRODUCT SPECIFICATIONS

### <M2394A>

LCD Panel	Screen Type	23 inches Wide (584.2 mm) TFT (Thin Film Transistor) LCD (Liquid Crystal Display) Panel Visible diagonal size : 584.2 mm
	Pixel Pitch	0.265(H) x 0.265(V) mm
Video Signal	Max. Resolution	1920 X 1080 @60 Hz
	Recommended Resolution	1920 X 1080 @60 Hz
	Horizontal Frequency	30 - 83 kHz
	Vertical Frequency	56 - 75 Hz
	Synchronization Type	Separate Sync, Digital
Input Connector		S-VIDEO, CVBS, TV, D-Sub Analog, DVI-D, HDMI, PC Audio In, Component
Power	Rated Voltage	AC 100-240V ~ 50/60 Hz 1.0A
	Power Consumption	On Mode : 50W (typ.) Sleep Mode ≤ 1W (RGB) Off Mode ≤ 1W
Tilt	Tilt Range	-5 ~ 15°
Dimensions (Width x Height x Depth) Weight		560.8 x 427 x 193.2 mm (22.08 x 16.81 x 7.61 inches) 5.6 kg / 12.35 lbs
Environmental conditions	Operating Temperature	10 ~ 35°C
	Operating Humidity	20 ~ 80%
	Storage Temperature	-10 ~ 60°C
	Storage Humidity	5 ~ 90%

- The specifications shown above may be changed without prior notice for quality improvement.

# APPENDIX

## PRODUCT SPECIFICATIONS

<M2794A>

LCD Panel	Screen Type	27 inches Wide (686 mm) TFT (Thin Film Transistor) LCD (Liquid Crystal Display) Panel Visible diagonal size: 686 mm
	Pixel Pitch	0.3114(H) x 0.3114(V) mm
Video Signal	Max. Resolution	1920 X 1080 @60 Hz
	Recommended Resolution	1920 X 1080 @60 Hz
	Horizontal Frequency	30 - 83 kHz
	Vertical Frequency	56 - 75 Hz
	Synchronization Type	Separate Sync, Digital
Input Connector		S-VIDEO, CVBS, TV, D-Sub Analog, DVI-D, HDMI, PC Audio In, Component
Power	Rated Voltage	AC 100-240V ~ 50/60 Hz 1.2A
	Power Consumption	On Mode : 100W (typ.) Sleep Mode ≤ 1W (RGB) Off Mode ≤ 1W
Tilt	Tilt Range	-5 ~ 10°
Swivel	Swivel Range	358°
Dimensions (Width x Height x Depth) Weight		654.1 x 494.6 x 210 mm (25.75 x 19.47 x 8.27 inches) 8.92 kg / 19.66 lbs
Environmental conditions	Operating Temperature	10 ~ 35°C
	Operating Humidity	20 ~ 80%
	Storage Temperature	-10 ~ 60°C
	Storage Humidity	5 ~ 90%

■ The specifications shown above may be changed without prior notice for quality improvement.

# APPENDIX

## IR CODES

### 1. How to Connect

- Connect your wired remote control to the Remote Control port on the set.

### 2. Remote Control IR Codes

#### ■ Output waveform

Single pulse, modulated with 37.917KHz signal at 455KHz

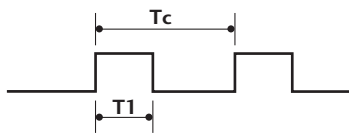

Carrier frequency  
 $FCAR = 1/T_c = f_{OSC}/12$   
 Duty ratio =  $T_1/T_c = 1/3$

#### ■ Configuration of frame

1st frame

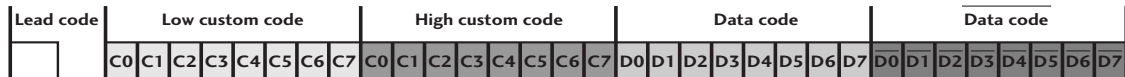

Repeat frame

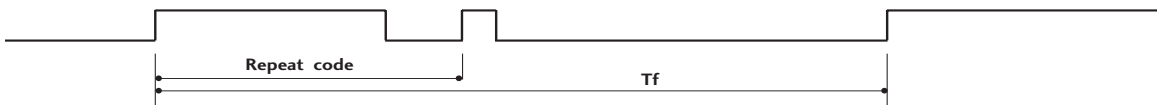

#### ■ Lead code

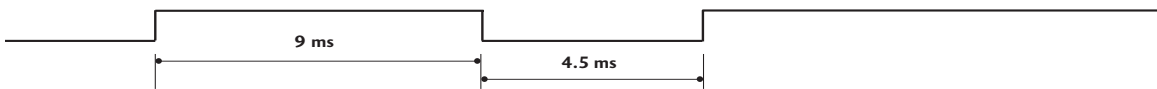

#### ■ Repeat code

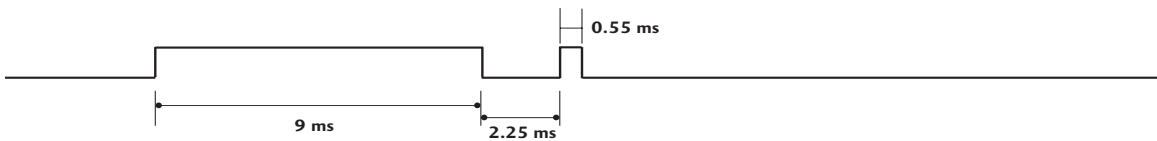

#### ■ Bit description

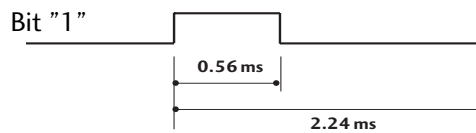
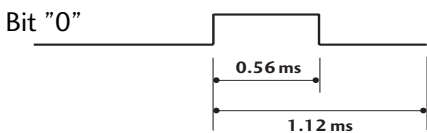

#### ■ Frame interval: $T_f$

The waveform is transmitted as long as a key is depressed.

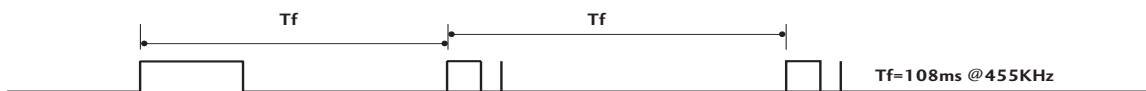

# APPENDIX

Code (Hexa)	Function	Note	Code (Hexa)	Function	Note
79	ARC	R/C Button	09	MUTE	R/C Button
0B	INPUT	R/C Button	53	LIST	R/C Button
08	POWER	R/C Button (Power On/Off)	10 ~ 19	Number Key 0 ~ 9	R/C Button
43	MENU	R/C Button	1A	Q.VIEW	R/C Button
28	RETURN	R/C Button	20	TEXT	R/C Button
03	VOL ◀	R/C Button	26	TIME	R/C Button
02	VOL ▶	R/C Button	64	SIZE	R/C Button
00	PR ▲	R/C Button	62	UPDATE	R/C Button
01	PR ▼	R/C Button	70	INDEX	R/C Button
44	OK( )	R/C Button	65	HOLD	R/C Button
72	RED	R/C Button	2A	REVEAL	R/C Button
71	GREEN	R/C Button	24	MIX	R/C Button
63	YELLOW	R/C Button	22	MODE	R/C Button
61	BLUE	R/C Button	0A	I/II	R/C Button
0F	TV/PC	R/C Button	0E	SLEEP	R/C Button
60	PIP	R/C Button	1E	FAV	R/C Button

# APPENDIX

## EXTERNAL CONTROL THROUGH RS-232C

Connect the RS-232C input jack to an external control device (such as a computer or an A/V control system) and control the set's functions externally.

Connect the serial port of the control device to the RS-232C jack on the set back panel. RS-232C connection cables are not supplied with the set.

### RS-232C Setup

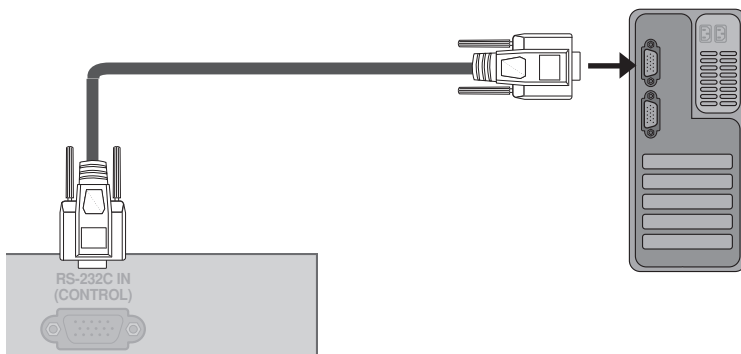

### Type of Connector; D-Sub 9-Pin Male

No.	Pin Name
1	No connection
2	RXD (Receive data)
3	TXD (Transmit data)
4	DTR (DTE side ready)
5	GND
6	DSR (DCE side ready)
7	RTS (Ready to send)
8	CTS (Clear to send)
9	No Connection

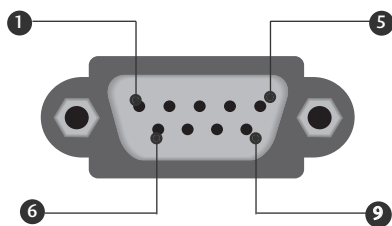

# APPENDIX

## RS-232C Configurations

7-Wire Configurations (Standard RS-232C cable)				3-Wire Configurations (Not standard)				
	PC		SET		PC		SET	
RXD	2	●	3	TXD	2	●	3	
TXD	3	●	2	RXD	3	●	2	
GND	5	●	5	GND	5	●	5	
DTR	4	●	6	DTR	4		6	
DSR	6	●	4	DSR	6		4	
RTS	7	●	8	RTS	7		7	
CTS	8	●	7	CTS	8		8	
	D-Sub 9		D-Sub 9		D-Sub 9		D-Sub 9	

## Set ID

- Use this function to specify a set ID number.
- Refer to 'Real Data Mapping 1'. See page 67.

- 1 Press the **MENU** button and then use ▲ / ▼ button to select the **Option** menu.
- 2 Press the ► button and then use ▲ / ▼ button to select **Set ID**.
- 3 Press the ► button and then use ◀ / ▶ button to adjust **Set ID** to choose the desired Set ID number.
  - The adjustment range of SET ID is 1~ 99.



<M2394A>

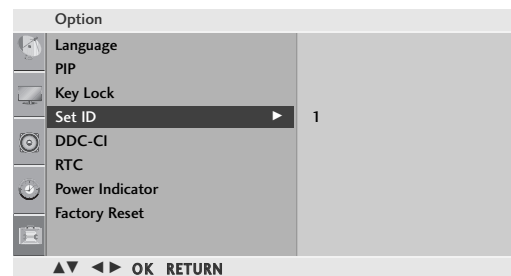

<M2794A>

- Press the **MENU** button to close the menu window.
- Press the **RETURN** button to move to the previous menu screen.

## Communication Parameters

- Baud rate : 9600 bps (UART)
- Data length : 8 bits
- Parity : None
- Stop bit : 1 bit
- Communication code : ASCII code
- Use a crossed (reverse) cable.



# APPENDIX

## Command Reference List

	COMMAND1	COMMAND2	DATA (Hexadecimal)		COMMAND1	COMMAND2	DATA (Hexadecimal)
01. Power	k	a	00 ~ 01	14. Colour Temperature	k	u	Refer to p.66
02. Aspect Ratio	k	c	Refer to p.65	15. Red Adjustment	k	v	00 ~ 3C
03. Screen Mute	k	d	00 ~ 01	16. Green Adjustment	k	w	00 ~ 3C
04. Volume Mute	k	e	00 ~ 01	17. Blue Adjustment	k	\$	00 ~ 3C
05. Volume Control	k	f	00 ~ 64	18. Abnormal Status	k	z	FF
06. Contrast	k	g	00 ~ 64	19. Auto Configure	j	u	01
07. Brightness	k	h	00 ~ 64	20. Equalize	j	v	Refer to p.67
08. Colour	k	i	00 ~ 64	21. Tune Command	m	a	Refer to p.67
09. Tint	k	j	00 ~ 64	22. Channel Skip	m	b	00 ~ 01
10. Sharpness	k	k	00 ~ 64	23. Key	m	c	Key Code
11. OSD Select	k	l	00 ~ 01	24. Input select (Main)	x	b	Refer to p.67
12. Remote Control Lock /Key Lock Mode	k	m	00 ~ 01				
13. Balance	k	t	00 ~ 64				

## Transmission / Receiving Protocol

### Transmission

**[Command1][Command2][ ][Set ID][ ][Data][Cr]**

[Command 1] : First command to control the set.(j,k,m or x)

[Command 2] : Second command to control the set.

[Set ID] : You can adjust the set ID to choose desired Set ID number in Setup menu. Adjustment range is 1 ~ 99. When selecting Set ID '0', every connected set is controlled. Set ID is indicated as decimal (1 ~ 99) on menu and as Hexa decimal (0x0 ~ 0x63) on transmission/receiving protocol.

[DATA] : To transmit command data.

Transmit 'FF' data to read status of comand.

[Cr] : Carriage Return

ASCII code '0x0D'

[ ] : ASCII code 'space (0x20)'

### OK Acknowledgement

**[Command2][ ][Set ID][ ][OK][Data][x]**

The set transmits ACK (acknowledgement) based on this format when receiving normal data. At this time, if the data is data read mode, it indicates present status data. If the data is data write mode, it returns the data of the PC computer.

### Error Acknowledgement

**[Command2][ ][Set ID][ ][NG][Data][x]**

Set transmits ACK(acknowledgement) based on this format when receiving abnormal data form non-viable functions or communication errors.

[Command 2] : use as command.

[Set ID]: use the small character, if set ID is 10, set will send the '0', 'a'

[Data]: use the small character, if data is 0xab, set will send the 'a', 'b'.

[NG]: use the large character.

# APPENDIX

## 01. Power (Command: k a)

To control Power On/Off of the TV.

*Transmission* [k][a][ ][Set ID][ ][Data][Cr]

Data 00 : Power Off      Data 01 : Power On

*Acknowledgement* [a][ ][Set ID][ ][OK/NG][Data][x]

To show Power On/Off.

*Transmission* [k][a][ ][Set ID][ ][FF][Cr]

*Acknowledgement* [a][ ][Set ID][ ][OK/NG][Data][x]

\* If there is the time delay between command and ack message during power on sequence, It should be described like "Note: In this model, set will send the Acknowledge after power on processing completion. There might be a time delay between command and acknowledge."

## 02. Aspect Ratio (Command: k c) (Main picture size)

To adjust the screen format. (Main picture format)

You can adjust the screen format using the Aspect Ratio in the Picture menu.

*Transmission* [k][c][ ][Set ID][ ][Data][Cr]

Data 01: Normal screen (4:3)      Data 06: Original  
Data 02: Wide screen (16:9)      Data 07: 14:9  
Data 04: Zoom1                      Data 09: Just Scan  
Data 05: Zoom2

*Acknowledgement* [c][ ][Set ID][ ][OK/NG][Data][x]

\* Using the RGB-PC, Component or HDMI input, you select either 16:9 or 4:3 screen aspect ratio.

\* Just Scan works in the following mode:  
Component (720p/1080i/1080p),  
HDMI (720p/1080i/1080p)

## 03. Screen Mute (Command: k d)

To select screen mute on/off.

*Transmission* [k][d][ ][Set ID][ ][Data][Cr]

Data 00 : Screen mute off (Picture on)

Data 01 : Screen mute on (Picture off)

*Acknowledgement* [d][ ][Set ID][ ][OK/NG][Data][x]

## 04. Volume Mute (Command: k e)

To control volume mute on/off.

You can also adjust mute using the MUTE button on remote control.

*Transmission* [k][e][ ][Set ID][ ][Data][Cr]

Data 00 : Volume mute on (Volume off)

Data 01 : Volume mute off (Volume on)

*Acknowledgement* [e][ ][Set ID][ ][OK/NG][Data][x]

## 05. Volume Control (Command: k f)

To adjust volume.

You can also adjust volume with the volume buttons on remote control.

*Transmission* [k][f][ ][Set ID][ ][Data][Cr]

Data Min : 00 ~ Max : 64

Refer to 'Real data mapping 1' : See page 67.

*Acknowledgement* [f][ ][Set ID][ ][OK/NG][Data][x]

## 06. Contrast (Command: k g)

To adjust screen contrast.

You can also adjust contrast in the Picture menu.

*Transmission* [k][g][ ][Set ID][ ][Data][Cr]

Data Min : 00 ~ Max : 64

Refer to 'Real data mapping 1' : See page 67.

*Acknowledgement* [g][ ][Set ID][ ][OK][Data][x]

## 07. Brightness (Command: k h)

To adjust screen brightness.

You can also adjust brightness in the Picture menu.

*Transmission* [k][h][ ][Set ID][ ][Data][Cr]

Data Min : 00 ~ Max : 64

Refer to 'Real data mapping 1' : See page 67.

*Acknowledgement* [h][ ][Set ID][ ][OK/NG][Data][x]

## 08. Colour (Command: k i)

To adjust the screen colour.

You can also adjust colour in the Picture menu.

*Transmission* [k][i][ ][Set ID][ ][Data][Cr]

Data Min : 00 ~ Max : 64

Refer to 'Real data mapping 1' : See page 67.

*Acknowledgement* [i][ ][Set ID][ ][OK/NG][Data][x]

## 09. Tint (Command: k j)

To adjust the screen tint.

You can also adjust tint in the Picture menu.

*Transmission* [k][j][ ][Set ID][ ][Data][Cr]

Data Min : 00 ~ Max : 64

Refer to 'Real data mapping 1' : See page 67.

*Acknowledgement* [j][ ][Set ID][ ][OK/NG][Data][x]

# APPENDIX

## 10. Sharpness (Command: k k)

To adjust the screen sharpness.

You can also adjust sharpness in the Picture menu.

```
Transmission [k][k][ ][Set ID][ ][Data][Cr]
```

Data Min : 00 ~ Max : 64

Refer to 'Real data mapping 1'. See page 67.

```
Acknowledgement [k][ ][Set ID][ ][OK/NG][Data][x]
```

## 11. OSD Select (Command: k l)

To select OSD (On Screen Display) on/off when controlling remotely.

```
Transmission [k][l][ ][Set ID][ ][Data][Cr]
```

Data 00: OSD off

Data 01: OSD on

```
Acknowledgement [l][ ][Set ID][ ][OK][Data][x]
```

## 12. Remote Control Lock/Key Lock Mode (Command: k m)

To lock the remote control and the side key controls on the set.

```
Transmission [k][m][ ][Set ID][ ][Data][Cr]
```

Data 00: Lock off

Data 01: Lock on

```
Acknowledgement [m][ ][Set ID][ ][OK/NG][Data][x]
```

## 13. Balance (Command: k t)

To adjust balance.

You can also adjust balance in the Audio menu.

```
Transmission [k][t][ ][Set ID][ ][Data][Cr]
```

Data Min : 00 ~ Max : 64

Refer to 'Real data mapping 1'. See page 67.

```
Acknowledgement [t][ ][Set ID][ ][OK/NG][Data][x]
```

## 14. Colour Temperature (Command: k u)

To adjust colour temperature.

You can also adjust Colour Temperature in the Picture menu.

```
Transmission [k][u][ ][Set ID][ ][Data][Cr]
```

Data 00: Medium 01: Cool 02: Warm(Don't operate in RGB, DVI mode)

Data 05: 9300K 06: 6500K 07: sRGB(Operate in RGB, DVI mode)

```
Acknowledgement [u][ ][Set ID][ ][OK/NG][Data][x]
```

## 15. Red Adjustment (Command: k v)

To adjust red in colour temperature.

```
Transmission [k][v][ ][Set ID][ ][Data][Cr]
```

Data Min: 00 ~ Max: 3C

Refer to 'Real data mapping 2'. See page 67.

```
Acknowledgement [v][ ][Set ID][ ][OK/NG][Data][x]
```

## 16. Green Adjustment (Command: k w)

To adjust green in colour temperature.

```
Transmission [k][w][ ][Set ID][ ][Data][Cr]
```

Data Min: 00 ~ Max: 3C

Refer to 'Real data mapping 2'. See page 67.

```
Acknowledgement [w][ ][Set ID][ ][OK/NG][Data][x]
```

## 17. Blue Adjustment (Command: k \$)

To adjust blue in colour temperature.

```
Transmission [k][$][ ][Set ID][ ][Data][Cr]
```

Data Min: 00 ~ Max: 3C

Refer to 'Real data mapping 2'. See page 67.

```
Acknowledgement [$][ ][Set ID][ ][OK/NG][Data][x]
```

## 18. Abnormal State (Command: k z)

To recognize an abnormal state.

```
Transmission [k][z][ ][Set ID][ ][FF][ ][Cr]
```

Data FF: Read

```
Acknowledgement [z][ ][Set ID][ ][OK/NG][Data][x]
```

Data 00: Normal (Power on and signal exist)

Data 01: No signal (Power on)

Data 02: Turn the set off by remote control

Data 03: Turn the set off by sleep time function

Data 04: Turn the set off by RS-232C function

\* This function is "read only"

# APPENDIX

## 19 . Auto Configure (Command: j u)

To adjust picture position and minimize image shaking automatically. It works only in RGB (PC) mode.

*Transmission* [j][u][ ][Set ID][ ][Data][Cr]

Data 01: To set

*Acknowledgement* [u][ ][Set ID][ ][OK/NG][Data][x]

## 20. Equalize(Command: j v)

► To adjust equalize.

*Transmission* [j][v][ ][Set ID][ ][Data][Cr]

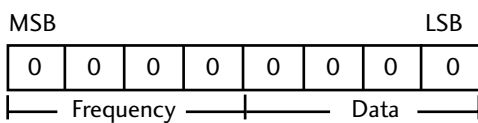

Frequency						Data				
7	6	5	4	Hex	Remark	3	2	1	0	Step
0	0	0	0	0	1'st Band	0	0	0	0	0
0	0	1	0	2	2'nd Band	0	0	0	1	1
0	1	0	0	4	3'rd Band	0	0	1	0	2
0	1	1	0	6	4'th Band	...	...	...	...	...
1	0	0	0	8	5'th Band	1	1	1	1	F

*Acknowledgement* [v][ ][Set ID][ ][OK/NG][Data][x]

## 21 . Tune Command / Channel Tuning (Command: m a)

Tune Channel to following Physical number.

*Transmission* [m][a][ ][Set ID][ ][Data0][ ][Data1][ ][Data2][Cr]

Data00 Min: 00 ~ Max: 63 (Max : C8 in China area)

(\*transmit by Hexadecimal code)

Data01 don't care

Data02 0 ; Main

1 : Sub

*Acknowledgement* [a][ ][Set ID][OK][ ][Data0][Data1][x][a][ ][Set ID][NG][ ][Data0][x]

## 22. Channel Skip(Command: m b)

► To set skip status for the current Programme.

*Transmission* [m][b][ ][Set ID][ ][Data][Cr]

Data 00 : Skip 01 : Add

*Acknowledgement* [b][ ][Set ID][ ][OK/NG][Data][x]

## 23. Key Code (Command: m c)

To send IR remote key code.

*Transmission* [m][c][ ][Set ID][ ][Data][Cr]

Data: Key code - Refer to page 61.

*Acknowledgement* [c][ ][Set ID][ ][OK/NG][Data][x]

## 24. Input select (Command: x b)

(Main Picture Input)

To select input source for set

*Transmission* [x][b][ ][Set ID][ ][Data][Cr]

Data: Structure

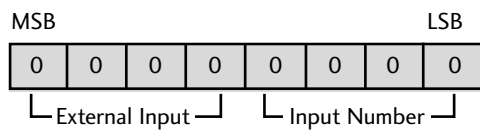

Input	command
TV	[x][b][ ][Set ID][ ][10][Cr]
AV	[x][b][ ][Set ID][ ][20][Cr]
Component	[x][b][ ][Set ID][ ][40][Cr]
RGB-PC	[x][b][ ][Set ID][ ][60][Cr]
DVI	[x][b][ ][Set ID][ ][80][Cr]
HDMI1	[x][b][ ][Set ID][ ][90][Cr]
HDMI2	[x][b][ ][Set ID][ ][91][Cr]

*Acknowledgement* [b][ ][Set ID][ ][OK/NG][Data][x]

### \* Real data mapping 1

00 : Step 0  
⋮  
32 : Step 50  
⋮  
64 : Step 100

### \* Real data mapping 2

00 : -30  
⋮  
1E : 0  
⋮  
3C : +30

**LG Electronics Inc.**