

Service Manual

(LM40/50)

LG Electronics

Ch 1. Service information

Ch 2. Locations

Ch 3. System information

- Specification**
- Model configuration**
- System Block Diagram**
- Fn key combinations**
- Status indicators**
- BIOS Flash**
- BIOS Setup**

Ch 4. Symptom-to-part index

- Power system checkout**
- Numeric error codes**
- Error messages**
- LCD-related symptoms**
- Indeterminate problems**

Ch 5. Removing and replacing a part (FRU)

Ch 6. Part list

- Part list**
- Exploded view**

Chapter 1. Service information

1-1. Important service information

■ Strategy for replacing parts (FRU-Field Replaceable Units)

Before replacing parts

Make sure that latest BIOS and drivers are installed before replacing any parts (FRUs) listed in this

Use the following strategy to prevent unnecessary expense for replacing and servicing parts

1. If you are instructed to replacing a part but the replacement does not correct the problem, reinstall the original part before you continue.
2. Some computers have both a processor board and system board. If you are instructed to replace either the processor board or the system board, and replacing one of them does not correct the problem, reinstall that board, and then replace the other one.
3. If an adapter or device consists of more than one part, any of the parts (FRUs) may be the cause of the error. Before replacing the adapter or device, remove the parts (FRUs), one by one, to see if the symptoms change. Replace only the part that changed the symptoms.

Caution



The BIOS configuration on the computer you are servicing may have been customized.

Running Automatic Configuration may alter the settings. Note the current configuration settings; then, when service has been completed, verify that those settings remain in effect.

■ Strategy for replacing a hard-disk drive

You have to get a User's approval before formatting or replacing a hard-disk drive. You must let the User know that the user is responsible for the loss data

Caution



The drive startup sequence in the computer you are servicing may have been changed. Be extremely careful during write operations such as copying, saving, or formatting. If you select an incorrect drive, data or programs can be overwritten.

1-2. Safety notices

**Warning**

Before the computer is powered-on after part (FRU) replacement, make sure all screws, springs, and other small parts are in place and are not left loose inside the computer. Verify this by shaking the computer and listening for rattling sounds. Metallic parts or metal flakes can cause electrical shorts.

**Warning**

some standby batteries contain a small amount of nickel and cadmium. Do not disassemble a standby battery, recharge it, throw it into fire or water, or short-circuit it. Dispose of the battery as required by local ordinances or regulations. Use only the battery in the appropriate parts listing. Use of an incorrect battery can result in ignition or explosion of the battery

**Warning**

The battery pack contains small amounts of nickel. Do not disassemble it, throw it into fire or water, or short-circuit it. Dispose of the battery pack as required by local ordinances or regulations. Use only the battery in the appropriate parts listing when replacing the battery pack. Use of an incorrect battery can result in ignition or explosion of the battery.

**Warning**

If the LCD breaks and the fluid from inside the LCD gets into your eyes or on your hands, immediately wash the affected areas with water for at least 15 minutes. Seek medical care if any symptoms from the fluid are present after washing.

**Warning**

To avoid shock, do not remove the plastic cover that protects the lower part of the inverter card.

**Warning**

Though the main batteries have low voltage, a shorted or grounded battery can produce enough current to burn personnel or combustible materials.

**Warning**

Before removing any part (FRU), turn off the computer, unplug all power cords from electrical outlets, remove the battery pack, and then disconnect any interconnecting cables.

1-3. Safety information

■ General safety

Follow these rules to ensure general safety

- Observe good housekeeping in the area of the machines during and after maintenance.
- When lifting any heavy object
 1. Ensure you can stand safely without slipping.
 2. Distribute the weight of the object equally between your feet.
 3. Use a slow lifting force. Never move suddenly or twist when you attempt to lift.
 4. Lift by standing or by pushing up with your leg muscles
(This action removes the strain from the muscles in your back.)
- Do not attempt to lift any object weights more than 16kg(35lb) or object that you think are too heavy for you.
- Do not perform any action that causes hazards to the customer, or that makes the equipment unsafe.
- Before you start the machine, ensure that other service representatives and the customer's personnel are not in a hazardous position.
- Place removed covers and other parts in a safe place, away from all personnel, while you are servicing the machine.
- Keep your tool box away from walk areas so that other people will not trip over it.
- Do not wear loose clothing that can be trapped in the moving parts of a machine. Make sure that your sleeves are fastened or rolled up above your elbows. If your hair is long, fasten it.
- Insert the ends of your necktie or scarf inside clothing or fasten it with a nonconductive clip, approximately 8 centimeters(3 inches) from the end.
- Do not wear jewelry, chains, metal-frame eyeglasses, or metal fasteners for you clothing.
- Wear safety glasses when you are hammering, drilling, soldering, cutting wire, attaching springs, using solvents, or working in any other conditions that might be hazardous to your eyes.
- After service, reinstall all safety shields, guards, labels, and ground wires. Replace any safety device that is worn or defective.
- Reinstall all covers correctly before returning the machine to the customer.



Caution

Metal objects are good electrical conductors.

■ Electrical safety

Observe the following rules when working on electrical equipment.



Important

Use only approved tools and test equipment. Some hand tools have handles covered with a soft material that does not insulate you when working with live electrical currents.

Many customers have, near their equipment, rubber floor mats that contain small conductive fibers to decrease electrostatic discharges. Do not use this type of mat to protect yourself from electrical shock.

- Find the room emergency power-off switch, disconnecting switch, or electrical outlet. If an electrical outlet. If an electrical accident occurs, you can then operate the switch or unplug the power cord quickly.
- Do not work alone under hazardous conditions or near equipment that has hazardous voltages.
- Disconnect all power before
 1. Performing a mechanical inspection
 2. Working near power supplies
 3. Removing or installing main units
- Before you start to work on the machine, unplug the power cord. If you cannot unplug it, ask the customer to power-off the wall box that supplies power to the machine and to lock the wall box in the off position.
- If you need to work on a machine that has exposed electrical circuits, observe the following precautions : Ensure that another person, familiar with the power-off controls, is near you.



Caution

Another person must be there to switch off the power, if necessary.

- Use only one hand when working with powered-on electrical equipment. Keep the other hand in your pocket or behind your back



Caution

An electrical shock can occur only when there is a complete circuit. By observing the above rule, you may prevent a current from through your body.

- When using testers, set the controls correctly and use the approved probe leads and accessories for that tester

Ch1. Service information

- Stand on suitable rubber mats (obtained locally, if necessary) to insulate you from grounds such as metal floor strips and machine frames.
- Observe the special safety precautions when you work with very high voltages. These instructions are in the safety sections of maintenance information. Use extreme care when measuring high voltages.
- Regularly inspect and maintain your electrical hand tools for safe operational condition.
- Do not use worn or broken tools and testers.
- Never assume that power has been disconnected from a circuit. First check that it has been powered off.
- Always look carefully for possible hazards in your work area. Examples of these hazards are moist floors, non-grounded power extension cables, power surges, and missing safety grounds.
- Do not touch live electrical circuits with the reflective surface of a plastic dental mirror. The surface is conductive such touching can cause personal injury and machine damage.
- Do not service the following parts with the power on when they are removed from their normal operating places in a machine.
 1. Power supply units
 2. Pumps
 3. Blowers and fans
 4. Motorgeneratorsand similar units. (This practice ensure correct grounding of the units.)
- If an electrical accident occurs
 1. Use caution ; do not become a victim of yourself.
 2. Switch off power.
 3. Send another person to get medical aid.

■ Safety inspection guide

The purpose of this inspection guide is to assist you in identifying potentially unsafe conditions.

As each machine was designed and built, required safety items were installed to protect users and service personnel from injury. This guide addresses only those items. You should use good judgment to identify potential safety hazards due to attachment of non-LG features or options not covered by this inspection guide.

If any unsafe conditions are present, you must determine how serious the apparent hazard could be and whether you can continue without first correcting the problem.

· Consider these conditions and the safety hazards they present

1. Electrical hazards, especially primary power (primary voltage on the frame can cause serious or fatal electrical shock)
2. Mechanical hazards, such as loose or missing hardware

Refer to the following checklist and begin the checks with the power off, and the power cord disconnected.

· Checklist

1. Check exterior covers for damage (loose, broken, or sharp edges)
2. Power off the computer. Disconnect the power cord.
3. Check the power cord for :
 - a. A third-wire ground connector in good condition. Use a meter to measure third-wire ground continuity for 0.1 Ω or less between the external ground pin and frame ground.
 - b. The power cord should be the type specified in the parts list.
 - c. Insulation must not be frayed or worn.
4. Remove the cover.
5. Check for any obvious non-LG alterations. Use good judgment as to the safety of any non-LG alterations.
6. Check inside the unit for any obvious unsafe conditions, such as metal filings, contamination, water or other liquids, or signs of fire or smoke damage.
7. Check for worn, frayed, or pinched cables.
8. Check that the power-supply cover fasteners (screw or rivets) have not been removed or tampered with.

■ Handling devices that are sensitive to electrostatic discharge

Any computer part containing transistors or integrated circuits (ICs) should be considered sensitive to electrostatic discharge (ESD). ESD damage can occur when there is a difference in charge between objects. Protect against ESD damage by equalizing the charge so that the machine, the part, the work mat, and the person handling the part are all at the same charge.

Note

Use product-specific ESD procedures when they exceed the requirements noted here.
Make sure that the ESD protective devices you use have been certified (ISO9000) as fully effective.

- When handling ESD-sensitive parts :
 1. Keep the parts in protective packages until they are inserted into the product.
 2. Wear a grounded wrist strap against your skin to eliminate static on your body.
 3. Prevent the part from touching your clothing. Most clothing retains a charge even when you are wearing a wrist strap.
 4. Use the black side of a grounded work mat to provide a static-free work surface. The mat is especially useful when handling ESD-sensitive devices.
 5. Select a grounding system, such as those listed below, to provide protection that meets the specific service requirement.

Note

The use of a grounding system is desirable but not required to protect against ESD damage.

- a. Attach the ESD ground clip too any frame ground, ground braid, or green-wire ground.
- b. Use an ESD ground or reference point when working on a double-insulated or battery-operated system. You can use coax or connector-outside shells on these systems.
- c. Use the round ground-prong of the AC plug on AC-operated computers.

■ Grounding requirements

Electrical grounding of the computers is required for operator safety and correct system function. Proper grounding of the electrical outlet can be verified by a certified electrician.

1-4. Laser compliance statement

When a CD-ROM drive, DVD drive or the other laser product is installed, note the following :



Caution

Use of controls or adjustments or performance of procedures other than those specified here in might result in hazardous radiation exposure.

Opening the CD-ROM drive, DVD-ROM drive or the other optical storage device could result in exposure to hazardous laser radiation.

There are no serviceable parts inside those drives. Do not open



Danger

Emits visible and invisible laser radiation when open. Do not stare into the beam , do not view directly with optical instruments, and avoid direct exposure to the beam.

1-5. Backup (Standby) RTC battery safety information

When replacing or disposing of the backup (standby) RTC battery, note the following :



Caution

There is the risk of explosion if the backup (standby) RTC battery is replaced by an incorrect type. Dispose of used backup (standby) RTC battery according to your local ordinances or regulation.

Для замены, используйте соответствующий тип батареек.

Существует опасность воспламенения.

Удаляйте отработанные батарейки согласно местным правилам или нормам.

Неправильное удаление батареек может привести к их взрыву или пожару.

باتری ذخیره (بندگی) را با نوع درست از عوض کنید.

خطر انفجار وجود دارد.

باتری های ذخیره های (بندگی) استفاده شده را بر اساس دستورالعمل داخلی مصرف کنید.

مصرف باتریهای نادرست منجر به انفجار یا آتش سوزی میشود.

غير البطارية البديلة على الطراز المناسب.

وذلك احتمال الانفجار.

تخلص من البطاريات البديلة المستعملة حسب القوانين واللائحة المحلية.

البطاريات المتخلص منها بصورة غير مناسبة قد تؤدي الى انفجار او احتراق.

1-6. Read this first

Before you go to the checkout guide, be sure to read this section.

Important Notes

- Only trained personnel certified by LG should service the computer.
- Read the entire FRU removal and replacement page before replacing any FRU.
- Use new nylon-coated screws when you replace FRUs.
- Be extremely careful during such write operations as copying, saving, formatting.
Drives in the computer that you are servicing sequence might have been altered. If you selected an incorrect drive, data or programs might be overwritten.
- Replace FRUs only for the correct mode.
- When you replace a FRU, make sure the model of the machine and the FRU part number are correct by referring to the FRU parts list.
- A FRU should not be replaced because of a single, irreproducible failure. Single failures can occur for a variety of reasons that have nothing to do with a hard ware defect, such as cosmic radiation, electrostatic discharge, or software errors.
- Consider replacing a FRU only when a problem recurs. If you suspect that a FRU is defective, clear the error log and run the test again. If the error does not recur, do not replace the FRU.
- Be careful not to replace a non-defective FRU.

■ What to do first

You must fill out the record form first.

During the warranty period, the customer may be responsible for repair costs if the computer damage was caused by misuse, accident, modification, unsuitable physical or operating environment, or improper maintenance by the customer. The following list provides some common items that are not covered under warranty and some symptoms that might indicate that the system was subjected to stress beyond normal use. Before checking problems with computer, determine whether the damage is covered under the warranty by referring to the following :

Ch1. Service information

The followings are not covered under warranty :

- . CD panel cracked from the application of excessive force or from being dropped
- . Scratched (cosmetic) parts
- . Distortion, deformation, or discoloration of the cosmetic parts
- . Cracked or broken plastic parts, broken latches, broken pins, or broken connectors caused by excessive force
- . Damage caused by liquid spilled into system
- . Damage caused by improper insertion of a PC Card or the installation of an incompatible card
- . Damage caused foreign material in the diskette drive
- . Diskette drive damage caused by pressure on the diskette drive cover or by the insertion of a diskette with multiple labels
- . Damaged or bent diskette eject button
- . Fusses blown by attachment of a non-supported device
- . Forgotten computer password (making the computer unusable)
- . Sticky keys caused by spilling a liquid onto the keyboard

The following symptoms might indicate damage caused by non-warranted activities :

- . Missing parts might be a symptom of unauthorized service or modification.
- . If the spindle of a hard-disk drive becomes noisy, it may have been subjected to excessive force, or dropped.

Chapter 2. Locations

■ Front view (15")

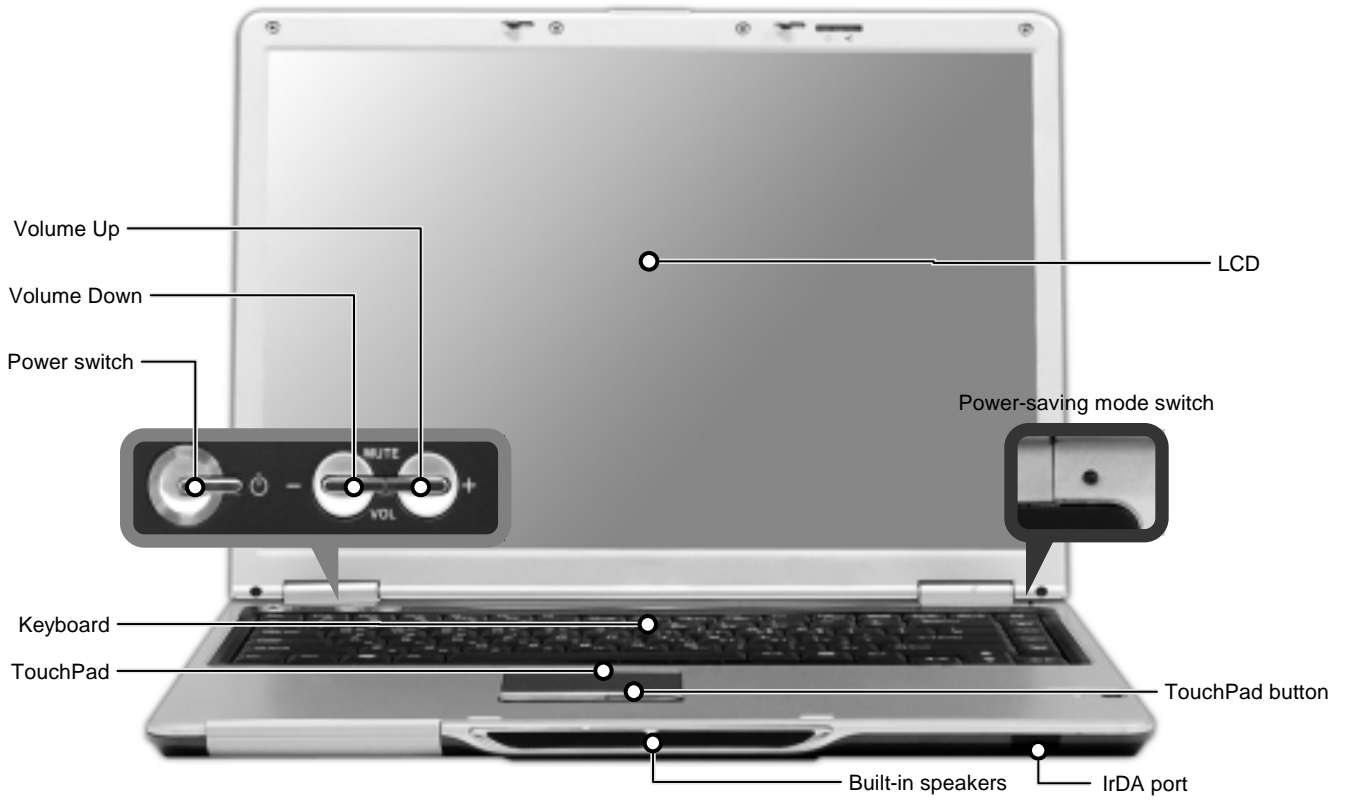

■ Front view (14.1")

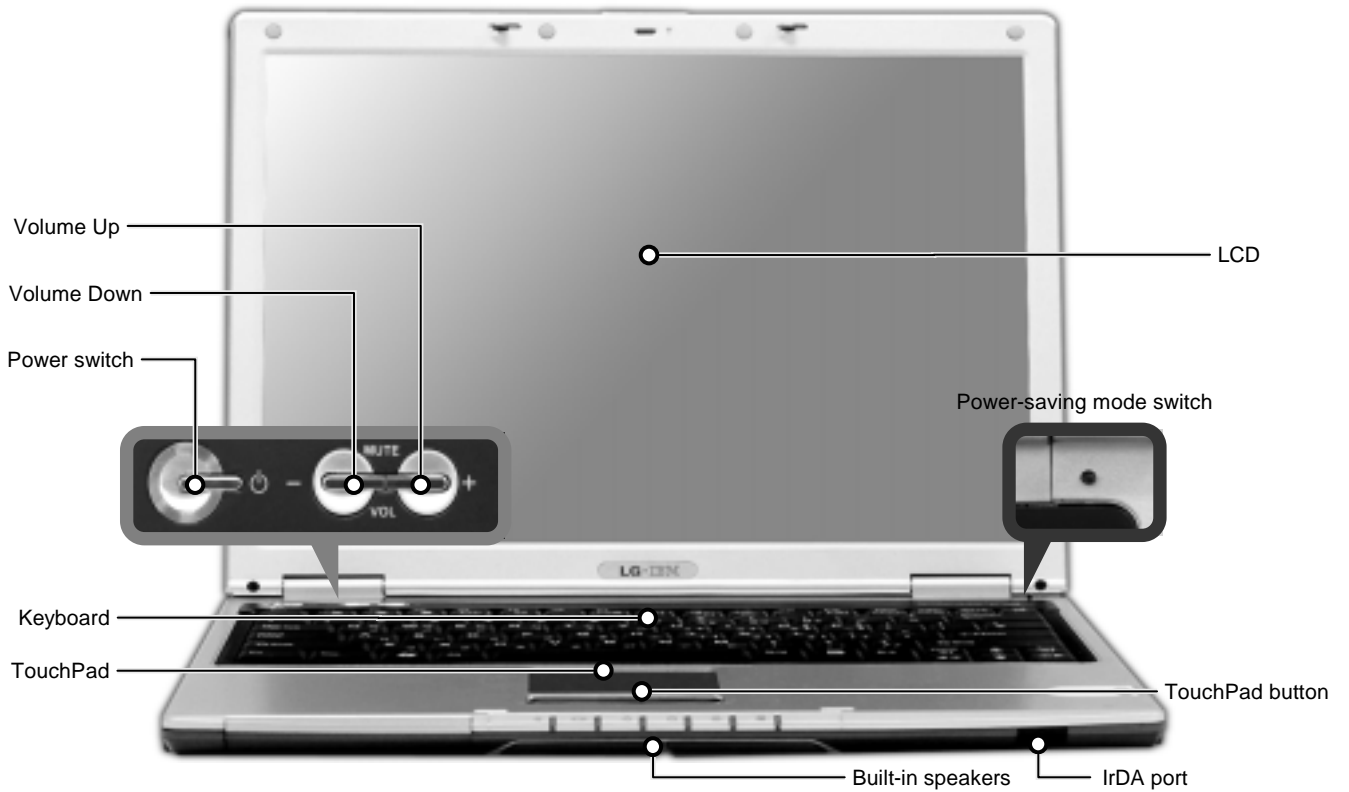

■ Rear view (15"/14.1")



■ Left view (15"/14.1")

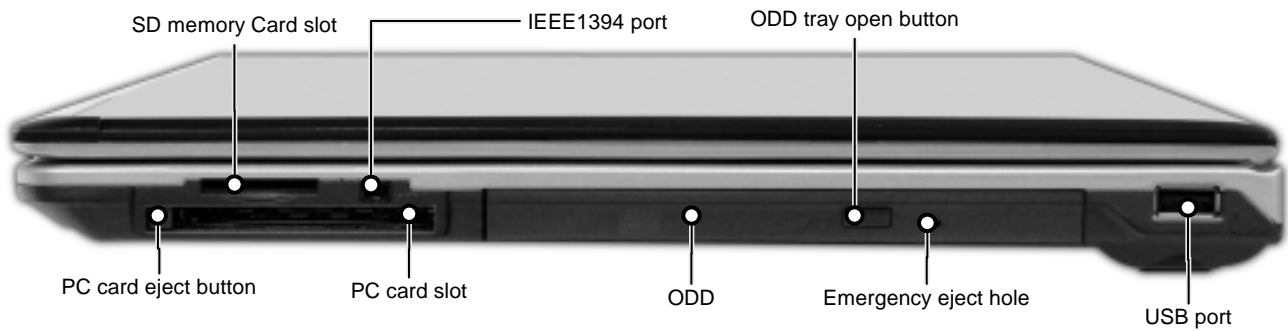

■ Right view (15"/14.1")

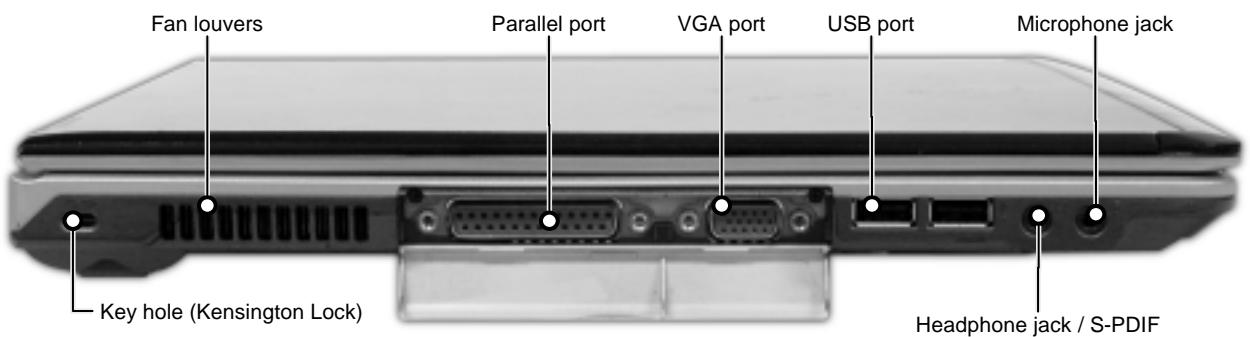

Security key hole (Kensington Lock)

User can attach a separately purchased chain lock into the security keyhole and connect it to a fixed object to prevent a notebook theft

Chapter 3. System information

■ Specification

- CPU
 - Banias 1.3 ~ 1.7 GHz / Dothan 1.7 GHz
 - μ FCPGA
- Main Chipset & Graphic
 - Intel ODEM + ICH4
 - Intel Montara GME (Graphic Controller Integrated)
 - ATi M9+ w/32MB VRAM
 - ATi M10 w/64MB VRAM
- Memory
 - 2SODIMM – Up to 2GB
 - DDR200/266/333 Capable
- HDD
 - 2.5" 9.5mm 40/60/80GB
- Communication
 - Modem, Daughter Card Type
 - 10/100 LAN on Board
 - IrDA
- Wireless LAN Solution
 - 802.11b Mini PCI Type, Quad-band Antenna
- Cardbus
 - 1 Type II Cardbus Socket
 - SD Card Slot
 - Memory Stick Slot
- ODD
 - Fixed Optical Storage
 - DVD/COMBO
- Port
 - VGA, PIO, 2X USB(2.0), 1X USB(1.1) RJ11, RJ45, Headphone-out / S-PDIF, Mic-in, DC-in, IEEE1394
- Input Devices
 - Keyboard (Full sized Keyboard, 2.5mm Key Stroke)
 - Touchpad
 - 3 Buttons (Power, Volume Up, Volume Down)
- Indicator (LED)
 - Power, HDD Activity, Caps Lock, Num Lock, Wireless LAN, Battery Charge, AC
- Power
 - 65 Watt 18.5V Adapter
- Audio
 - 2 Pro Speakers w / 16bit Stereo (SB Pro Compatible) 1W
- Material
 - McKinley CFRTP / Rear (Mg)
- Battery
 - 6 Cell 4.4Ah Cylindrical (Li-Ion)
 - 9 Cell 6.6Ah Cylindrical (Li-Ion)

■ Model Configuration















Main Specification														Sub Spec					
Model Name	CPU	LCD	HDD	ODD	VIDEO	VRAM	Memory	Wireless	OS	Card Bias	ANT	SPDIF	Batt	ICDA	S-Video	SOMAS Slot	IEEE1394		
LM50-B-AB2H	1.5GHz	14.1" XGA	40GB	Combo(0.5)	MP+	32MB	256MB*2	802.11bg	XP Pro	14.1" 7420	Y	Y	Y	Y	Y	Y	Y		
LM50-B-AB2H1	1.5GHz	14.1" XGA	40GB	Combo(0.5)	MP+	32MB	256MB*2	802.11bg	XP Pro	14.1" 7420	Y	Y	Y	Y	Y	Y	Y		
LM50-B-AB2U1	1.5GHz	14.1" XGA	40GB	Combo(0.5)	MP+	32MB	256MB*2	802.11bg	XP Pro	14.1" 7420	Y	Y	Y	Y	Y	Y	Y		
LM50-F-ABBE1	1.5GHz	14.1" XGA	40GB	Combo(0.5)	MP+	32MB	256MB	802.11b	XP Home	14.1" 7420	Y	Y	Y	Y	Y	Y	Y		
LM50-A2TE2	W/O	15" XGA	W/O	Combo(0.5)	MP+	32MB	W/O	802.11bg	W/O	15" 7420	Y	Y	Y	Y	Y	Y	Y		
LM50-A2ZE2	W/O	15" XGA	W/O	Combo(0.5)	M10	64MB	W/O	802.11bg	W/O	15" 7420	Y	Y	Y	Y	Y	Y	Y		
LM50-B-AB0Y	1.5GHz	15" XGA	40GB	Combo(0.5)	MP+	32MB	256MB	802.11bg	XP Home	15" 7420	Y	Y	Y	Y	Y	Y	Y		
LM50-B-ARUJ1	1.5GHz	15" SXGA+	60GB	Combo(0.5)	MP+	32MB	256MB*2	802.11bg	XP Pro	15" 7420	Y	Y	Y	Y	Y	Y	Y		
LM50-C-ARNP	1.5GHz	15" SXGA+	60GB	Combo(0.5)	M10	64MB	512MB	802.11bg	XP Home	15" 7420	Y	Y	Y	Y	Y	Y	Y		
LM50-C-ARUH	1.5GHz	15" SXGA+	60GB	Combo(0.5)	M10	64MB	256MB*2	802.11bg	XP Pro	15" 7420	Y	Y	Y	Y	Y	Y	Y		
LM50-C-ARUH1	1.5GHz	15" SXGA+	60GB	Combo(0.5)	M10	64MB	256MB*2	802.11bg	XP Pro	15" 7420	Y	Y	Y	Y	Y	Y	Y		
LM50-C-ARUY	1.5GHz	15" SXGA+	60GB	Combo(0.5)	M10	64MB	256MB*2	802.11bg	XP Pro	15" 7420	Y	Y	Y	Y	Y	Y	Y		
LM50-C-ATNX	1.7GHz	15" SXGA+	80GB	Combo(0.5)	M10	64MB	512MB	802.11b	XP Home	15" 7420	Y	Y	Y	Y	Y	Y	Y		
LM50-C-AUKB	1.7GHz	15" SXGA+	60GB	Combo(0.5)	M10	64MB	512MB	802.11bg	XP Home	15" 7420	Y	Y	Y	Y	Y	Y	Y		
LM50-C-AUNP	1.7GHz(D)	15" SXGA+	80GB	Combo(0.5)	M10	64MB	512MB	802.11bg	XP Home	15" 7420	Y	Y	Y	Y	Y	Y	Y		
LM50-C-AUJB	1.7GHz(D)	15" SXGA+	80GB	Combo(0.5)	M10	64MB	512MB	802.11bg	XP Pro	15" 7420	Y	Y	Y	Y	Y	Y	Y		
LM50-C-AUWP	1.7GHz(D)	15" SXGA+	80GB	Combo(0.5)	M10	64MB	512MB	802.11bg	XP Pro	15" 7420	Y	Y	Y	Y	Y	Y	Y		
LM50-F-ABHP	1.5GHz	15" XGA	40GB	Combo(0.5)	MP+	32MB	512MB	802.11b	XP Home	15" 7420	Y	Y	Y	Y	Y	Y	Y		
LM50-F-ADBE1	1.5GHz	15" XGA	40GB	Combo(0.5)	MP+	32MB	256MB	802.11b	XP Home	15" 7420	Y	Y	Y	Y	Y	Y	Y		
LM50-G-ARKP	1.5GHz	15" SXGA+	60GB	Combo(0.5)	M10	64MB	512MB	802.11b	XP Home	15" 7420	Y	Y	Y	Y	Y	Y	Y		
LM50-G-ARBR	1.5GHz	15" SXGA+	60GB	Combo(0.5)	M10	64MB	256MB*2	802.11b	XP Home	15" 7420	Y	Y	Y	Y	Y	Y	Y		
LM50-G-ARUP	1.5GHz	15" SXGA+	60GB	Combo(0.5)	M10	64MB	512MB	802.11b	XP Pro	15" 7420	Y	Y	Y	Y	Y	Y	Y		
LM50-G-ATKE1	1.7GHz	15" SXGA+	60GB	Combo(0.5)	M10	64MB	256MB*2	802.11b	XP Home	15" 7420	Y	Y	Y	Y	Y	Y	Y		
LM50-G-ATRR	1.7GHz	15" SXGA+	60GB	Combo(0.5)	M10	64MB	256MB*2	802.11b	XP Home	15" 7420	Y	Y	Y	Y	Y	Y	Y		

Ch3. System information

■ Fn key combinations

The following table shows the function of each combination of Fn with a function key.

Function of Fn keys has nothing to do with Operating System.

 +	Description
	User-defined Hot key. (Setting is available at OSD)
	User-defined Hot key. (Setting is available at OSD)
	User-defined Hot key. (Setting is available at OSD)
	Put the computer in standby mode. To turn the LCD display on again, press any key or TouchPad. (In Windows XP and Windows 2000, this combination of buttons functions as a sleep button. The setting can be changed so that pressing it puts the computer into hibernation mode or even shuts the computer down.)
	Enable / Disable TouchPad. Disable TouchPad by pressing once. Enable TouchPad by pressing once more.
	Enable / Disable Wireless LAN. Disable Wireless LAN by pressing once. Enable Wireless LAN by pressing once more.
	Switch between the computer display and an external monitor. If an external monitor is attached, computer output is displayed in the following three patterns by turns: External monitor (CRT display) Computer display and external monitor (LCD + CRT display) Computer display (LCD)
	Enable / Disable the auto sound control function with the Battery Miser if it is installed. (To enable this function, you have to install the Battery Miser first.)
	Enable / Disable the auto brightness control function with the Battery Miser if it is installed. (To enable this function, you have to install the Battery Miser first.)
	User-defined Hot key. (Setting is available at OSD)
	User-defined Hot key. (Setting is available at OSD)
	User-defined Hot key. (Setting is available at OSD)
	The computer display becomes brighter.
	The computer display becomes less bright.

■ Status indicators

- The system status indicators show the status of the computer.

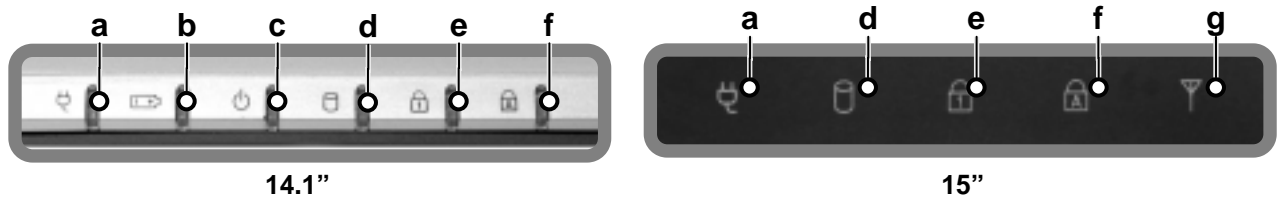

a. AC Power

Power indicator lights up when the power cord is connected to the computer.

b. Battery

Battery status indicator indicates the following status of the battery.

Green : The computer is connected to an AC adapter and is being charged.

Off : The battery is fully charged OR the computer is not connected to an AC adapter.

Blinking : The battery power is under 10% of its maximum capacity.

c. Power

Power status indicator indicates the following status of the computer.

Green : The computer is turned on.

Off : The computer is turned off or is in hibernation mode.

Blinking : The computer is in standby mode.

d. Drive in use

Drive in use indicator lights up when data is being written to or read from the hard-disk or optical disk drive.

e. Num Lock

Num Lock indicator lights up when the combination of the **Fn** and **Num Lock** key is pressed.

When this indicator lights up, you can use the embedded numeric keys.

(To use the numeric keys, you must enable the **Internal Keypad** setting under the **Advanced** menu in the **BIOS Setup Utility**)

f. Caps Lock

Caps lock indicator lights up when the Caps lock key is pressed. When this indicator lights up, you can type capital letters without pressing the **Shift** key.

g. Wireless activity indicator

Wireless activity indicator indicates the following.

Blue : The Wireless client is associated with the network.

Off : The Wireless card does not have the power or RF is off.

Blinking : The Wireless client is not associated with the network.

■ BIOS Flash

You can update BIOS using a floppy disk drive.

Because this system is not equipped with any floppy disk drive, you have to use an external USB drive for a BIOS update. In order to boot up with an USB drive, please set Removable Device as the first boot up drive in the boot menu of BIOS setup.

· How to update flash ROM in DOS

1. Create 'boot up' flash update diskette.
2. Copy a ROM image file (*.wph) into the root of the flash update diskette.
3. Copy phlash16.exe to the flash update diskette.
4. Insert the diskette into the FDD of your computer.
5. Boot your computer with the diskette, and type 'phlash16*.wph/mode=n'.
6. Cold boot and follow the instruction displayed on the screen.

· Flash options /mode=n

0 – Default mode. Keep the current DMI information and update BIOS image only.

1 – Update DMI information only.

If new DMI information is not specified, the current DMI information is left unchanged.

2 – Update BIOS and DMI information.

If new DMI information is not specified, the current DMI information is left unchanged.

3 – Update BIOS and DMI information.

DMI information is updated to the DMI string and options specified in the new BIOS image.

Note

DMI is Desktop Management Interface

■ How to update flash ROM in Windows

1. Quit all running programs.
2. Start WINPHLASH.EXE.



3. Select the procedure you want :
 - a. Backup BIOS and Flash BIOS with new settings
 - b. Backup BIOS Only
4. Specify the locations for backup and new BIOS files in BIOS Setting Locations.
 - a. Enter the name of the backup file for existing BIOS or click Browse to locate the file.
 - b. Enter the name of the new BIOS file or click Browse to locate the file.
5. Click Advanced Settings button to access the advanced settings
6. Click Flash BIOS button to start flash BIOS.
7. Wait for the operation to complete. WinPhlash may take one or two minutes to complete flash BIOS operation.

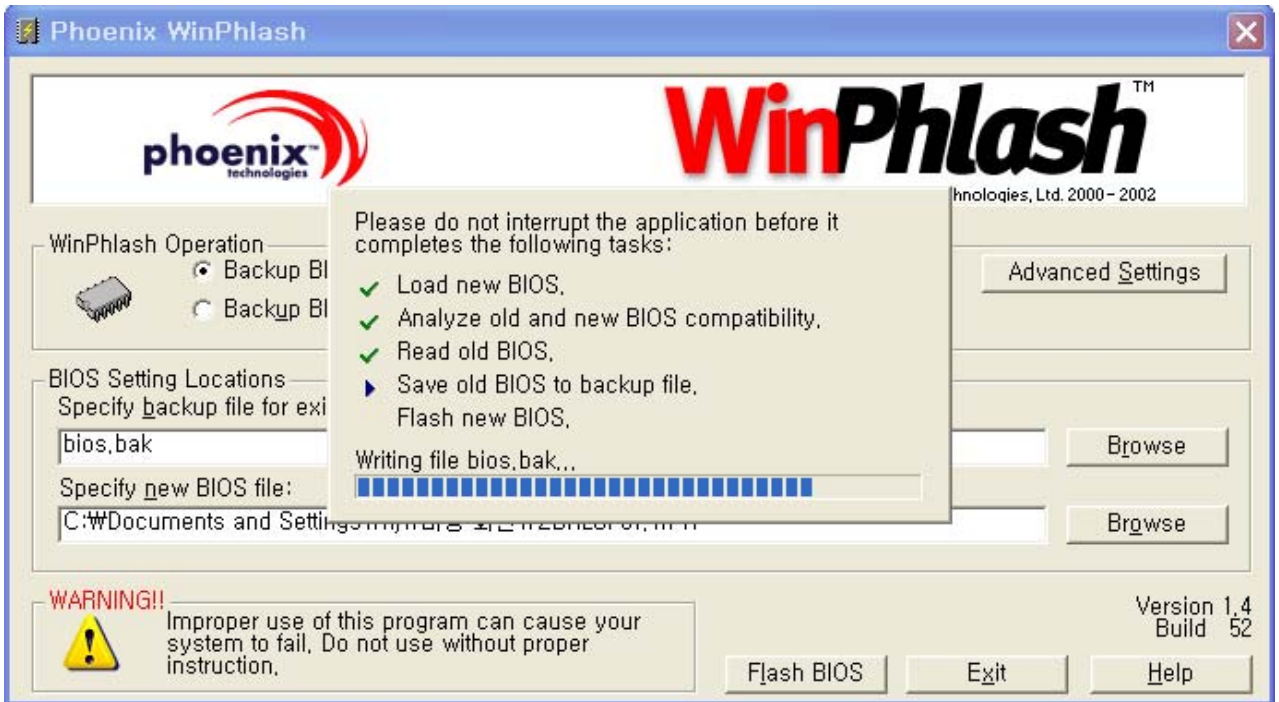

8. After the completion, 'System BIOS was successfully updated' appears on the screen, then the computer restarts.
9. After the restart, make sure the system BIOS is updated.
10. If your computer does not restart automatically, turn off your computer and then turn it back on by pressing power button.

■ BIOS Setup

BIOS (Basic Input and Output System) Setup saves the system configuration in **CMOS RAM**, and check the configurations during startup. Use the **BIOS Setup Utility** to change and save the system environment, hardware configurations, power saving mode, etc.

· Open the BIOS Setup Utility in the following situations :

1. to change the BIOS setup
2. to replace the backup battery
3. system configuration error occurs
4. to change the boot order
5. to set/change a password

Press the power button.

When the **LG** logo appears on the screen, press **F2** and enter the **BIOS Setup Utility**.

■ Default screen

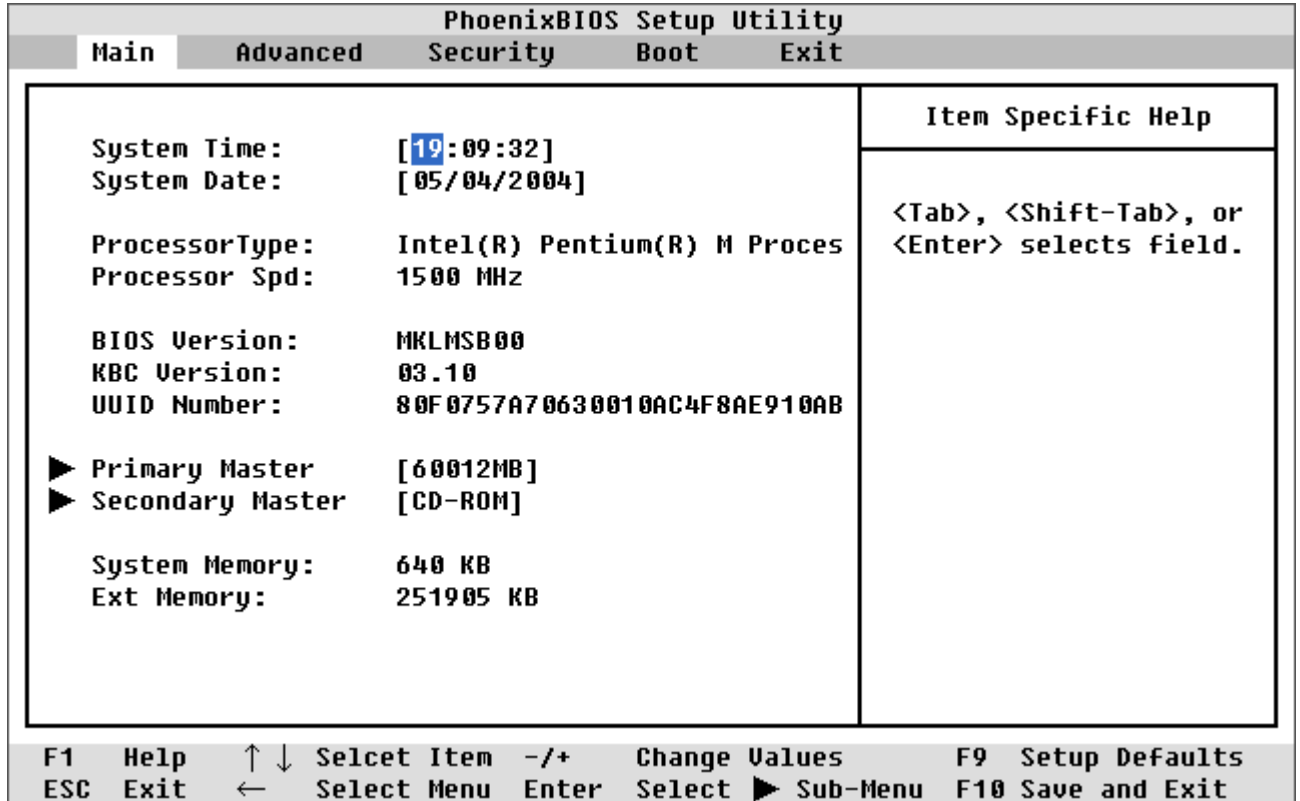

- **BIOS Setup Utility** menu bar shows the following menus
Main, Advanced, Security, Boot, Exit

- **Main** menu enables you to set the system time and date, hard disk drive setup, memory configuration, and floppy disk drive specification.

- **Advanced** menu enables you to configure the operating environment for peripheral devices, such as legacy USB, TouchPad, internal keypad, and parallel port.

- **Security** menu enables you so set or change supervisor and user passwords.

- **Boot** menu enables you to set the order of drives the system selects to find its operating system during the boot sequence. Use **Enter**, **+** and **-** keys to change the order.

- **Exit** menu enables you to save your system configuration.

■ Using the keys

The keys used in the BIOS Setup Utility and their functions are described at the bottom.

- **F1**, **Alt** + **H** : General Help

Display the descriptions of the keys used in the setup utility.

- **↓**, **↑** : Select Item

Navigate and select items in the setup utility. The selected item becomes highlighted.

- **←**, **→** : Select Menu

Move to another menu.

- **-** / **+**, **Space Bar** : Change Values

Change the value of a selected item.

- **F9** : Load Default Configuration

Display Setup Confirmation window. Press **Enter** to load default configuration.

- **Enter ↵** : Select Sub-Menu

Some items have sub-menus. Display the sub-menu for a selected item.

- **F10** : Save and Exit

Display Setup Confirmation window. Press **Enter** to save and exit.

- **Esc** : Exit

In a sub-menu, press **Esc** to move to the previous window. In Main menu, click **Esc** to move to Exit menu.

■ Main Menu

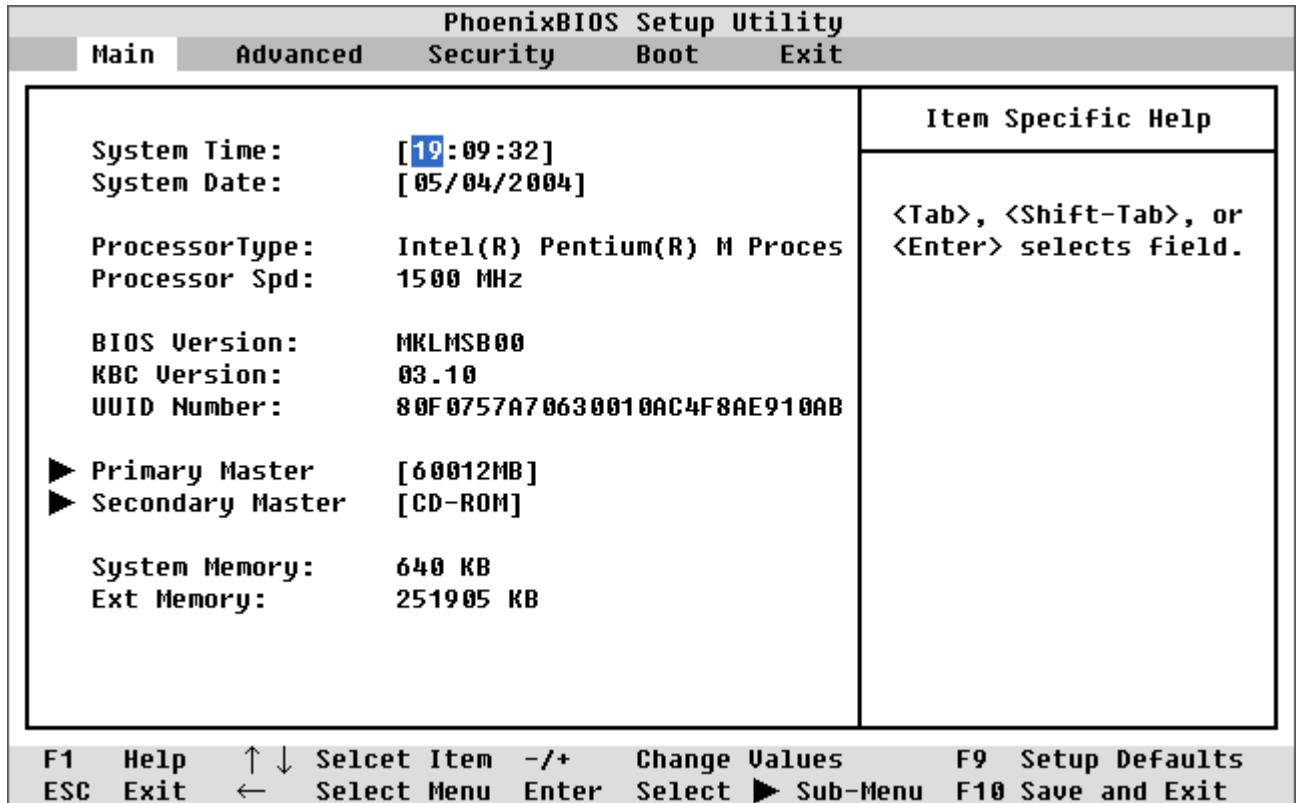

· **System Time**

Set the system time. Use **Tab** key to move to hour, minute, and second. Use **+**, **-**, or **Spacebar** to change the values.

· **System Date**

Set the system date.

· **Processor Type / Speed**

Indicate CPU type and clock speed installed on the system.

· **BIOS Version / KBC Version / UUID Number**

Display BIOS / KBC version information and UUID value.

· **Primary Master / Secondary Master**

Display the information about the device used as the primary master. Press **Enter** to set the parameters of the device at this connection.

· **System Memory / Extended Memory**

Display the memory size information.

■ Advanced Menu

PhoenixBIOS Setup Utility										
Main	Advanced	Security Boot Exit								
<pre> Legacy USB Support: [Enabled] TouchPad Support Internal keypad [Enabled] Parallel port: [Enabled] Mode: [ECP] Base I/O address: [378] Interrupt: [IRQ 5] DMA channel: [DMA 1] Boot-time Diagnostic Screen: [Disabled] </pre>	<p style="text-align: center;">Item Specific Help</p> <hr/> <p>Enable support for Legacy Universal Serial Bus</p>									
<table style="width: 100%; border: none;"> <tr> <td style="width: 15%;">F1 Help</td> <td style="width: 15%;">↑ ↓ Selcet Item</td> <td style="width: 15%;">-/+ Change Values</td> <td style="width: 15%;">F9 Setup Defaults</td> </tr> <tr> <td>ESC Exit</td> <td>← Select Menu</td> <td>Enter Select</td> <td>▶ Sub-Menu F10 Save and Exit</td> </tr> </table>			F1 Help	↑ ↓ Selcet Item	-/+ Change Values	F9 Setup Defaults	ESC Exit	← Select Menu	Enter Select	▶ Sub-Menu F10 Save and Exit
F1 Help	↑ ↓ Selcet Item	-/+ Change Values	F9 Setup Defaults							
ESC Exit	← Select Menu	Enter Select	▶ Sub-Menu F10 Save and Exit							

· **Legacy USB Support**

Enable support for the Legacy USB. (**Enabled / Disabled**)

· **TouchPad Support**

Enable support for TouchPad. (**Enabled / Disabled**)

· **Internal Keypad**

Enable support for the internal keypad. (**Enabled / Disabled**)

· **Parallel Port**

Configure the parallel port using options. (**Enabled / Disabled**)

Set the mode for the parallel port using options. (**Output only, Bi-directional, EPP, and ECP**)

Set the base I/O address for the parallel port. (**378 / 278 / 3BC**)

Set the **interrupt** for the parallel port. (**IRQ5 / IRQ7**)

· **Parallel port modes**

1. Output only

The normal mode. Use this mode when you connect a printer to the parallel port.

2. Bi-directional

Allows bi-directional high speed data transfer.

3. EPP (Extended Parallel Port)

Allows a connection to a device supporting **EPP**, **EPP** uses the existing parallel port signal to allow asymmetric bi-directional data transfer with a host device.

4. ECP (Extended Capabilities Port)

Allows a connection to a device supporting **ECP**, **ECP** increases the data transfer rate and enables you to set **DMA** channel. (**DMA1 / DMA3**)

· **Boot-time Diagnostic Screen**

Enables the Boot-time Diagnostics Screen (**Enabled / Disabled**)

■ Security Menu

· Setting a password

If you want to protect the system setup from an unauthorized user, follow the instructions below to set a password.

You can set a password in the BIOS Setup Utility program.



Caution

If you forget the password, you cannot gain access to your system.

Make sure you write down the password in a safe place only you can refer to in case you forget the password

· Set Supervisor Password

A password protects your computer from unauthorized users. The factory default setup does not have a password. A supervisor password prevents unauthorized users from changing the system setup.

- a. Start the system setup utility and use arrow keys to select **Set Supervisor Password** under **Security** menu, and then press **Enter**.
- b. If the following screen appears, select **Set Supervisor Password** by using arrow keys, and **Enter**.

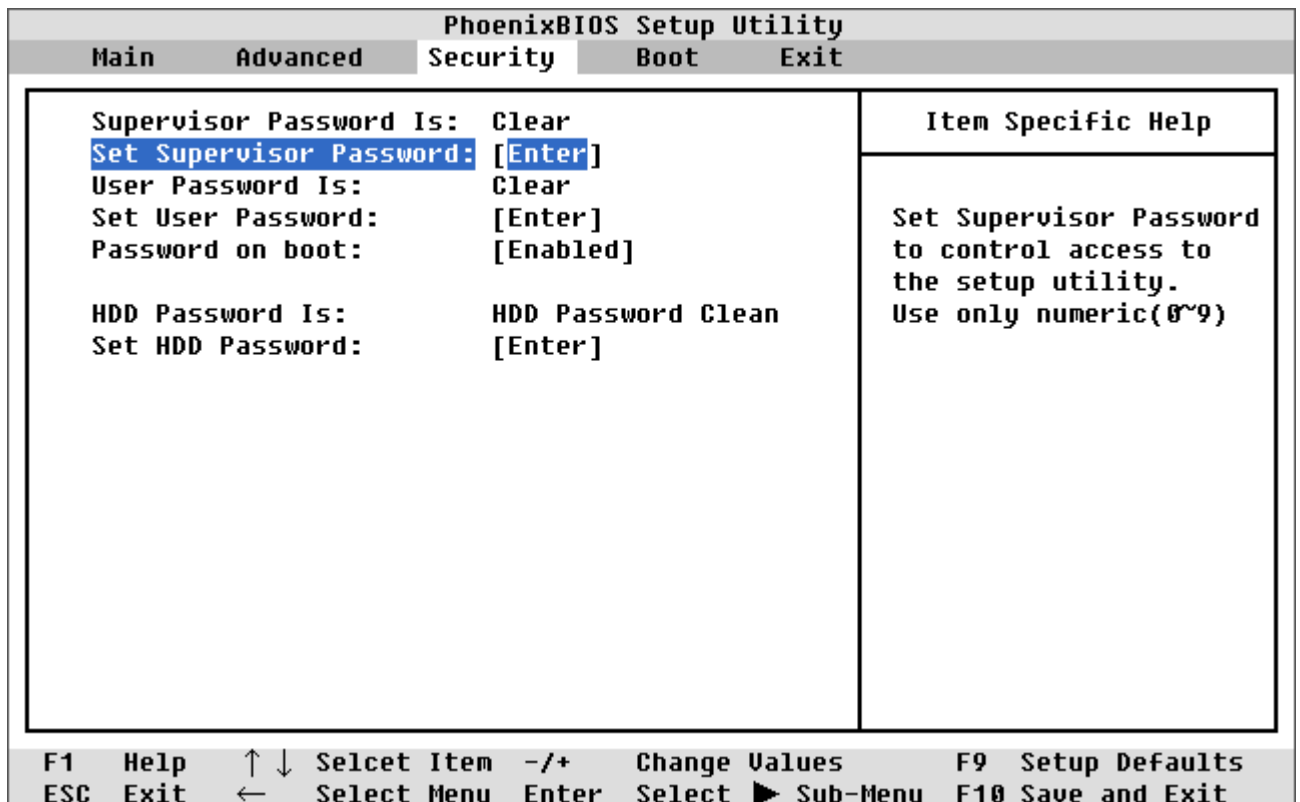

Ch3. System information

Note

A supervisor password enables you to change settings in the **BIOS Setup Utility** and to perform **Power on Boot**.

Users other than the administrator should only have user passwords.

- c. If the following message appears, enter a new supervisor password and then **Enter**.
A password must be consisted of character A~Z and numbers 0~9, and have the maximum length of 8.

Set Supervisor Password:	
Enter New Password	[]
Confirm New Password	[]

- d. If the following message appears, press **Enter**.

Setup Notice
Changes have been saved. [Continue]

- e. Press **F10** to save the new settings.
f. If the following message appears, select **Yes** and press **Enter** to restart the computer.

Setup Confirmation
Save configuration changes and exit now? [Yes] [No]

Ch3. System information

· Set User Password

A user password provides a lower level of security compared to a supervisor password.

A supervisor password must be set in order for you to set a user password.

- a. Start the **BIOS Setup Utility** and use arrow keys to select **Security** menu.
- b. Use arrow keys to selected **Set User Password** and press **Enter**.

PhoenixBIOS Setup Utility				
Main	Advanced	Security	Boot	Exit
Supervisor Password Is: Clear Set Supervisor Password: [Enter] User Password Is: Clear Set User Password: [Enter] Password on boot: [Enabled]			Item Specific Help	
HDD Password Is: HDD Password Clean Set HDD Password: [Enter]			Set Power-On password to control access to the system. Use only numeric(0~9)	
F1 Help ↑↓ Select Item -/+ Change Values F9 Setup Defaults ESC Exit ← Select Menu Enter Select ► Sub-Menu F10 Save and Exit				

Note

A user password gives limited access for changing the setting in the **BIOS Setup Utility** compared to a supervisor password.

- c. If the following message appears, enter a new password and press **Enter**.

A password must be consisted of characters A~Z and numbers 0~9, and have maximum length of 8.

Set User Password:	
Enter New Password	[]
Confirm New Password	[]

Ch3. System information

d. If the following message appears, press **Enter**.

Setup Notice
Changes have been saved. [Continue]

e. Press **F10** to save the new settings.

f. If the following message appears, select **Yes** and press **Enter** to restart the computer.

Setup Confirmation
Save configuration changes and exit now? [Yes] [No]

Ch3. System information

· Password on boot

Enables password entry on boot

- Start the **BIOS Setup Utility** and use arrow keys to select Security menu.
- If the following screen appears, select **Set Supervisor Password** or **Set User Password** by using arrow keys, and input new password.

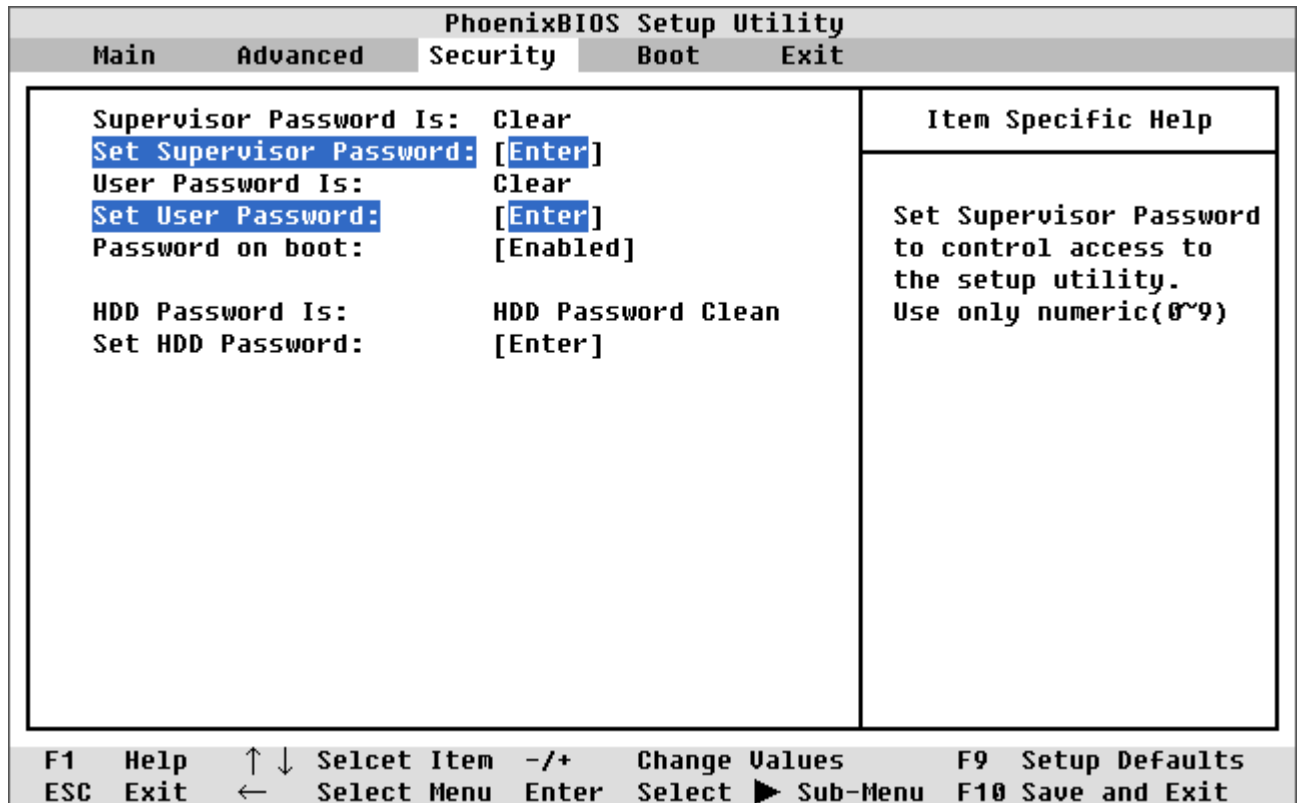

Ch3. System information

c. Select **Password on boot** menu, then change value (**Enabled**) by using **+**, **-** keys.

PhoenixBIOS Setup Utility				
Main	Advanced	Security	Boot	Exit
Supervisor Password Is: Clear Set Supervisor Password: [Enter] User Password Is: Clear Set User Password: [Enter] Password on boot: [Enabled] HDD Password Is: HDD Password Clean Set HDD Password: [Enter]			Item Specific Help Enables password entry on boot	
F1 Help ↑↓ Select Item -/+ Change Values F9 Setup Defaults ESC Exit ← Select Menu Enter Select ► Sub-Menu F10 Save and Exit				

Note

If you set a **Supervisor Password** or **User Password**, you can use **Password on boot**.

If you set **Disabled** on **Password on boot**, You don't have to enter a password.

Ch3. System information

· Set HDD Password

Set HDD Password to control access to the Hard-disk.

Press **Enter** to input, change or disable hard-disk password.

- Start the **BIOS Setup Utility** and use arrow keys to select **Security** menu.
- If the following screen appears, select **Set HDD Password** by using arrow keys, and press **Enter**.

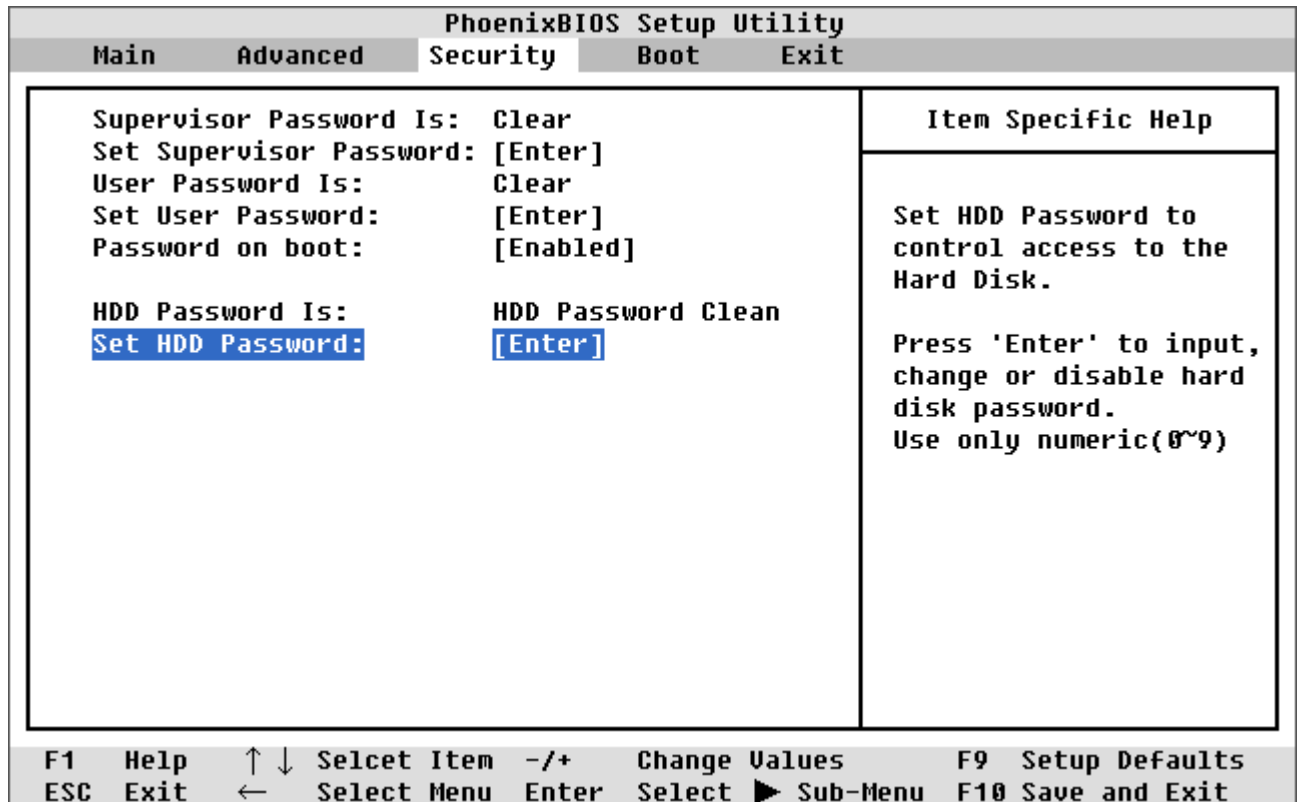

Note

When loosing your HDD Password, you can not access your Hard-disk drive.

Ch3. System information

- c. If the following message appears, enter a new supervisor password and then press **Enter**.
A password must be consisted of numbers 0~9, and have the maximum length of 8.

Set HDD Password:	
Enter New Password	[<input type="password"/>]
Confirm New Password	[<input type="password"/>]

- d. If the following message appears, press **Enter**.

Setup Notice
Changes have been saved. [Continue]

- e. Press **F10** to save the new settings.
f. If the following message appears, select **Yes** and press **Enter** to restart the computer.

Setup Confirmation	
Save configuration changes and exit now?	
[Yes]	[No]

Ch3. System information

· Changing or removing a password

You must know the password in order to change or remove it.

- Start the **BIOS Setup Utility**, enter your password, and then press **Enter**.
- To **change** the password, follow the instructions on **Set Supervisor Password** or **Set User Password**.
- To **remove** the password, follow the instructions below.

Use arrow keys to select **Security** menu, and select a password you want to remove, and then press **Enter**.

- If the following message appears, enter the current password in the bracket next to **Enter Current Password**, and then press **Enter**.

Set Supervisor Password:	
Enter Current Password	[<input type="text"/>]
Enter New Password	[<input type="text"/>]
Confirm New Password	[<input type="text"/>]

- Press **Enter** without entering a new password in each of the brackets next to **Enter New Password** and **Confirm New Password**.

Set Supervisor Password:	
Enter Current Password	[<input type="text"/>]
Enter New Password	[<input type="text"/>]
Confirm New Password	[<input type="text"/>]

- If the following message appears, press **Enter**.

Setup Notice
Changes have been saved. [Continue]

- Press **F10** to save the new setting.
- If the following message appears, select **Yes** and press **Enter** to restart the computer.

Setup Confirmation
Save configuration changes and exit now? [Yes] [No]

■ Boot Menu

PhoenixBIOS Setup Utility																
Main	Advanced	Security	Boot	Exit												
CD-ROM Drive Removable Devices +Hard Drive MBA UNDI (Bus2 Slot6)			<table border="1" style="width: 100%; border-collapse: collapse;"> <thead> <tr> <th style="text-align: center;">Item Specific Help</th> </tr> </thead> <tbody> <tr> <td style="padding: 5px;"> Keys used to view or configure devices: <Enter> expands or collapses devices with a + or - <Ctrl+Enter> expands all <Shift + 1> enables or disables a device. <+> and <-> moves the device up or down. <n> May move removable device between Hard Disk or Removable Disk <d> Remove a device that is not installed. </td> </tr> </tbody> </table>		Item Specific Help	Keys used to view or configure devices: <Enter> expands or collapses devices with a + or - <Ctrl+Enter> expands all <Shift + 1> enables or disables a device. <+> and <-> moves the device up or down. <n> May move removable device between Hard Disk or Removable Disk <d> Remove a device that is not installed.										
Item Specific Help																
Keys used to view or configure devices: <Enter> expands or collapses devices with a + or - <Ctrl+Enter> expands all <Shift + 1> enables or disables a device. <+> and <-> moves the device up or down. <n> May move removable device between Hard Disk or Removable Disk <d> Remove a device that is not installed.																
<table style="width: 100%; border: none;"> <tr> <td style="width: 15%;">F1 Help</td> <td style="width: 15%; text-align: center;">↑ ↓</td> <td style="width: 20%;">Select Item</td> <td style="width: 15%;">-/+</td> <td style="width: 20%;">Change Values</td> <td style="width: 15%;">F9 Setup Defaults</td> </tr> <tr> <td>ESC Exit</td> <td style="text-align: center;">←</td> <td>Select Menu</td> <td>Enter</td> <td>Select ► Sub-Menu</td> <td>F10 Save and Exit</td> </tr> </table>					F1 Help	↑ ↓	Select Item	-/+	Change Values	F9 Setup Defaults	ESC Exit	←	Select Menu	Enter	Select ► Sub-Menu	F10 Save and Exit
F1 Help	↑ ↓	Select Item	-/+	Change Values	F9 Setup Defaults											
ESC Exit	←	Select Menu	Enter	Select ► Sub-Menu	F10 Save and Exit											

- **Boot** menu enables you to set the boot order for the CD-ROM drive, Removable devices, Hard drive, and Network boot.

Boot menu displays the boot order of your system with higher priority given to a device higher on the list.

The default boot order is CD-ROM drive, Removable devices, Hard drive, and Network boot.

Changing the order of the devices on **Boot** menu changes the boot order of your system.

Use ↑ and ↓ keys to select a device. Press the combination of **Shift** and **+** to move the device up, and **-** to move the device down on the list.

- **CD-ROM Drive**

The CD-ROM drive has the highest priority given in the boot order. Boot your system using the CD-ROM drive by inserting a bootable CD in the CD-ROM(CD-RW/DVD combo) drive

- **Removable Devices**

You can set the boot order for more than one removable device, such as a legacy floppy drive.

- **Hard Drive**

You can set the boot order for more than one hard disk drive.

■ Exit Menu

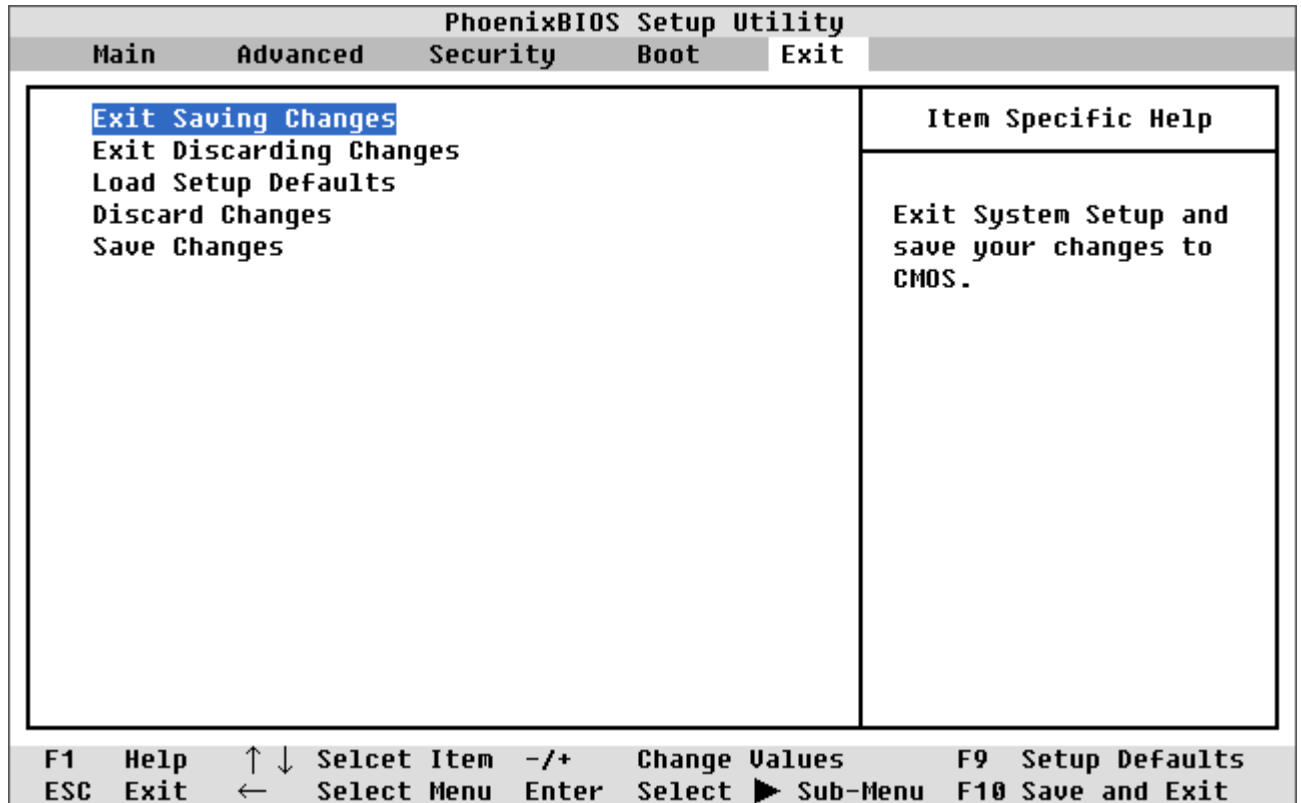

- **Exit System Setup** and save your changes to CMOS.

- **Exit Saving Changes**

Select **Exit Saving Changes** to save new setup information in CMOS RAM. CMOS RAM stores the information using the backup battery; therefore, the information will not be lost when the computer is turned off.

- **Exit Discarding Changes**

Select **Exit Discarding Changes** to discard new setup information. If you made changes to items other than date, time, and passwords, the **Setup Warning** asks you to save the new configurations.

Select **Yes** and press **Enter** to save the new configuration.

- **Load Setup Defaults**

Select **Load Setup Defaults** to change the setup information to the factory default settings. If you select **Load Setup Defaults** or press **F9**, **Setup Confirmation** asks you to confirm your selection.

Press **Yes** to load setup defaults.

Ch3. System information

- **Discard Changes**

Select **Discard Changes** to discard new setup information. **Setup Confirmation** asks you to confirm your selection. If you want to discard any new setup information, select **Yes**.

- **Save Changes**

Select **Save Changes** to save any new setup information without exiting the **BIOS Setup Utility**.

Select **Yes** to save the new setup information in the **Setup Confirmation** window.

Chapter 4. Symptom-to-part index

The symptom-to-part index in this section lists symptoms and errors and their possible causes. The most likely cause is listed first.

Note

If replacing a part (FRU) does not solve the problem, put the original part back in the computer. Do not replace a non-defective FRU.

■ Power system checkout

- To verify a symptom, do the following :
 1. Power off the computer.
 2. Remove the battery pack.
 3. Connect the AC adapter.
 4. Check that power is supplied when you power on the computer.
 5. Power off the computer.
 6. Disconnect the AC adapter and install the charged battery pack.
 7. Check that the battery pack supplies power when you power on the computer.

- If you suspect a power problem, see the appropriate one of the following power supply checkouts :
 1. Checking the AC adapter
 2. Checking the operational charging
 3. Checking the battery pack
 4. Checking the backup battery

- Checking the AC adapter

If the power-on indicator does not turn on, check the power cord of the AC adapter for correct continuity and installation.

If the computer does not charge during operation, go to 'Checking operational charging'.

To check the AC adapter, do the following :

1. Unplug the AC adapter cable from the computer.
2. Measure the output voltage at the plug of the AC adapter cable. See the following figure :

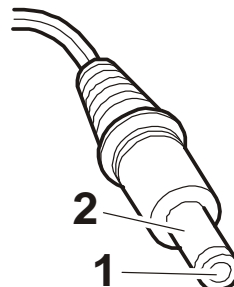

Pin	Voltage (V dc)
1	+18.0 ~ +19.2
2	Ground

Ch4. Symptom-to-part index

- If the voltage is not correct, replace the AC adapter.

- If the voltage is acceptable, do the following :
 1. Replace the system board.
 2. If the problem persists, check the AC adapter whether it is correct product or not.

Note

Noise from the AC adapter does not always indicate a defect.

- Checking operational charging
 1. To check whether the battery charges properly during operation, use a discharged battery pack or a battery pack that has less than 50% of the total power remaining when installed in the computer. Perform operational charging. If the battery status indicator or icon does not turn on, remove the battery does not turn on, replace the battery pack.
 2. If the charge indicator still does not turn on, replace the system board. Then reinstall the battery pack.

Note

Do not charge battery pack, when its temperature is below 0°C or above 60°C.

- Checking the battery pack
 1. Open the Power Meter window by clicking **Start** → **Control Panel** → **Power Options** and then; check the total power remains. Battery charging does not start until the power Meter shows that less than 95% of the total power remains; under this condition the battery pack can charge to 100% of its capacity. This protects the battery pack from being overcharged or from having a shortened life.
 2. To check the status of your batter, move your cursor to the Power Meter icon in the icon tray of the Windows taskbar and wait for a moment (but do not click), and the percentage of battery power remaining is displayed. To get detailed information about the battery, double-click the Power Meter icon.

Note

If the battery pack becomes hot, it may not be able to charge. Remove it from the computer and Leave it at room temperature for a while. After it cools down, reinstall and recharge it.

Ch4. Symptom-to-part index

- The Characteristics of the battery pack

1. Self-discharge

The battery gradually loses its power over time without ever being used.

2. Periodic full discharge / charge

Frequent recharge of the battery pack can reduce the capacity of the battery pack. When this happens, you can perform the full discharge / charge to improve the capacity. You should perform periodic full discharge /charge once every 30~60 days.

You should always use the battery until its power is low; then fully charge the battery.

3. Trickle charge

If the temperature of the battery pack drops below 10℃ , the trickle charging begins.

The trickle charging may take 32 hours for the battery pack to be fully charged.

Ch4. Symptom-to-part index

· To check the battery pack, do the following :

1. Power off the computer.
2. Remove the battery pack and measure the voltage between battery terminals 1(-) and 5(+).

See the following figure :

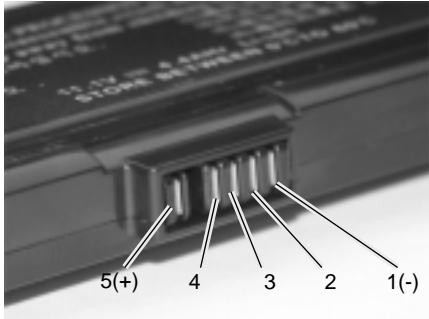

Terminal	Voltage (V dc)
1	Ground(-)
5	+0V ~ +12.6V (6 cell / 9-cell)

3. If the voltage is still less than +11.1 V DC after recharging, replace the battery.
4. If the voltage is more than +11.1 V DC, measure the resistance between battery terminals 1 and 2.
The resistance must be 2 to 4k Ω (typically 3k Ω).
5. If the resistance is not correct, replace the battery pack. If the resistance is correct, replace the system board.

Note

Charging will take at least 3 hours.

Note

Battery is an expendable supplier, so its capacity and used time can be reduced by using the computer.

· Checking the backup battery

1. Remove the backup battery.
2. Measure the voltage of the backup battery. See the following figure.

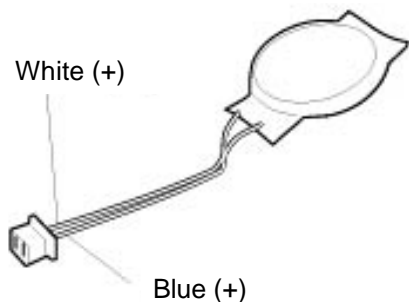

Wire	Voltage (V dc)
White	+2.5 ~ +3.2
Blue	Ground

If the voltage is correct, replace the system board.

If the voltage is not correct, replace the backup battery.

If the backup battery discharges quickly after replacement, replace the system board.

Ch4. Symptom-to-part index

■ Numeric error codes

Symptom / Error	FRU or action, in sequence
0200 Fixed disk failure (The hard disk is not working)	1.Reset the hard-disk drive. 2.Load Setup Defaults in BIOS Setup Utility. 3.Hard-disk drive. 4.System board.
0210 Stuck Key error	1.Check the keyboard if it is pressed. 2.Replace the keyboard.
0211 Keyboard error	Run interactive tests of the keyboard and the auxiliary input device.
0212 Keyboard Controller Failed	System board.
0220 Monitor type error - Monitor type does not match the one specified in CMOS.	Load Setup Defaults in BIOS Setup Utility.
0230 System RAM error - System RAM Failed at offset.	1.DIMM 2.System board
0231 Shadow RAM error - Shadow RAM failed at offset	System board
0232 Extended RAM error - Extended RAM Failed at address line	1. DIMM 2. System board
0250 System battery error - System battery is dead	Replace the backup battery and run BIOS Setup Utility to reset the time and date.

Ch4. Symptom-to-part index

Symptom / Error	FRU or action, in sequence
0251 System CMOS checksum bad - System CMOS checksum is not correct. - Default configuration used.	Replace the backup battery and run BIOS Setup Utility to reset the time and date.
0252 Password checksum bad - The password is cleared.	Reset the password by running BIOS Setup Utility.
0260 System timer error	<ol style="list-style-type: none"> 1. Replace the backup battery and run BIOS Setup Utility to reset the time and date. 2. System board.
0271 Check date and time settings - Date and time error.	Run BIOS Setup Utility to reset the time and date.
0280 Previous boot incomplete - Default configuration used	<ol style="list-style-type: none"> 1. Load 'Setup Default' in BIOS Setup Utility. 2. DIMM. 3. System board.
0281: Memory Size found by POST differed from EISA CMOS	Load Setup Defaults in BIOS Setup Utility.
02B0 Diskette drive A error	Set up the diskette type in BIOS Setup Utility.
02B1 Diskette drive B error	Set up the diskette type in BIOS Setup Utility.
02B2 Incorrect drive A type - Floppy diskette drive error	<ol style="list-style-type: none"> 1. Floppy diskette drive. 2. External FDD cable. 3. I/O card.
02B3 Incorrect Drive B type	<ol style="list-style-type: none"> 1. Floppy diskette drive. 2. External FDD cable. 3. I/O card.
02D0 System cache error - Cache disabled (RAM cache failed and BIOS disabled)	<ol style="list-style-type: none"> 1. Load 'Setup Default' in BIOS Setup Utility. 2. System board.
02F4 EISA CMOS not writable	<ol style="list-style-type: none"> 1. Load 'Setup Default' in BIOS Setup Utility. 2. Replace the backup battery. 3. System board.
02F5 DMA test failed	<ol style="list-style-type: none"> 1. DIMM 2. System board
02F6 Software NMI failed	<ol style="list-style-type: none"> 1. DIMM 2. System board

Ch4. Symptom-to-part index

Symptom / Error	FRU or action, in sequence
02F7 Fail - Safe timer NMI failed	1. DIMM 2. System board
0611 IDE configuration changed	1. Load Setup Defaults in BIOS Setup Utility. 2. System board.
0612 IDE configuration error	1. Load Setup Defaults in BIOS Setup Utility. 2. System board.
0613 Com A configuration changed	1. Load Setup Defaults in BIOS Setup Utility. 2. System board.
0614 Com A configuration error	1. Load Setup Defaults in BIOS Setup Utility. 2. System board.
0615 Com B configuration changed	1. Load Setup Defaults in BIOS Setup Utility. 2. System board.
0616 Com B configuration error	1. Load Setup Defaults in BIOS Setup Utility. 2. System board.
0617 Floppy configuration changed	1. Load Setup Defaults in BIOS Setup Utility. 2. System board.
0618 Floppy configuration error	1. Load Setup Defaults in BIOS Setup Utility. 2. System board.
0619 Parallel port configuration changed	1. Load Setup Defaults in BIOS Setup Utility. 2. System board.
061A Parallel port configuration error	1. Load Setup Defaults in BIOS Setup Utility. 2. System board.

Ch4. Symptom-to-part index

■ Error message

Symptom / Error	FRU or action, in sequence
Device address conflict.	<ol style="list-style-type: none"> 1. Load Setup Defaults in BIOS Setup Utility. 2. Backup battery. 3. System board.
Allocation error for device.	<ol style="list-style-type: none"> 1. Load Setup Defaults in BIOS Setup Utility. 2. Backup battery. 3. System board.
Failing bits: nnnn.	<ol style="list-style-type: none"> 1. DIMM. 2. System board.
Invalid System Configuration Data.	<ol style="list-style-type: none"> 1. DIMM. 2. System board.
I/O Device IRQ Conflict.	<ol style="list-style-type: none"> 1. Load Setup Defaults in BIOS Setup Utility. 2. Backup battery. 3. System board.
Operating System not found.	<ol style="list-style-type: none"> 1. Check that the operating system has no failure and is installed correctly. 2. Enter BIOS Setup Utility and see whether the hard-disk drive and the diskette drive are properly identified. 3. Reset the hard-disk drive. 4. Reinstall the operating system. 5. Diskette drive. 6. Hard-disk drive. 7. System board.
Hibernation error.	<ol style="list-style-type: none"> 1. Restore the system configuration to what it was before the computer entered hibernation mode. 2. If memory size has been changed, re-create the hibernation file.
FAN error.	Fan.
Thermal sensing error.	System board.

Ch4. Symptom-to-part index

■ LCD-related symptoms

Note

Before removing or disassembling LCD, power off the computer, unplug all power cords from electrical outlets, remove the battery pack also.

Symptom / Error	FRU or action, in sequence
LCD screen becomes dark suddenly.	Check out Battery Miser.
Nothing displayed on LCD screen.	<ol style="list-style-type: none"> 1. Check out Battery Miser. 2. Choose Never in the Turn off Monitor item on Power Options Properties. 3. Check the power save mode switch if it is pressed by something. 4. Check the System is in standby or hibernation mode.
LCD backlight not working. LCD too dark. LCD brightness cannot be adjusted.	<ol style="list-style-type: none"> 1. Reconnect inverter to the board connector. 2. Replace inverter. 3. LCD assembly. 4. System board.
LCD color cannot be adjusted. LCD screen abnormal. Characters missing pixels. LCD screen unreadable. Wrong color displayed.	<ol style="list-style-type: none"> 1. Reset all LCD connectors. 2. Replace LCD cable. 3. LCD assembly. 4. System board.
Horizontal or vertical lines displayed on LCD	LCD assembly.
Power-on indicator on, and a blank LCD during POST.	LCD assembly. System board.

■ Indeterminate problems

- You are here because the diagnostic tests did not identify which adapter or device failed, wrong devices are installed, a short circuit is suspected, or the system is inoperative.
Follow these procedures to isolate the failing FRU (do not isolate FRUs that have no defects).
- Verify that all attached devices are supported by the computer.
- Verify that the power supply being used at the time of the failure is operating correctly.
 1. Power off the computer
 2. Visually check each FRU for damage. Replace any damaged FRU.
 3. Remove or disconnected all of the following devices :
 - a. Non-LG devices.
 - b. Printer, mouse, and other external devices.
 - c. Battery pack.
 - d. PC cards.
 - e. ODD (CD-ROM, Combo) drive or FDD drive in the Bay.
 - f. Hard-disk drive.

Note

Use the other memory card because it needs when operating computer.

4. Power on the computer.
5. Determine whether the problem has changed.
6. If the problem does not recur, reconnect the removed devices one at a time until you find the failing FRU.
7. If the problem remains, replace the following FRUs one at a time.
(do not replace a non-defective FRU)
 - a. LCD assembly (Check external monitor whether the same problem recurs or not).
 - b. Keyboard.
 - c. Keydeck (TouchPad and Scroll Button assembly).
 - d. System board.

Chapter 5. Removing and replacing a part (FRU)



Danger

Before removing any FRU, power off the computer, unplug all power cords from electrical outlets, remove the battery pack, and then disconnect any interconnecting cables.



Caution

Before the computer is powered on after FRU replacement, make sure that all screws, springs, and other small parts are in place and are not loose inside the computer. Verify metal flakes can cause electrical short circuits.

Note

As for the screw, every Torque $2 \pm 0.2\text{Kgfc}\text{m}(0.196\text{Nm})$

■ 1010 Battery Pack

1. Push the battery latch in the direction shown below, then slide the battery pack out of the slot.

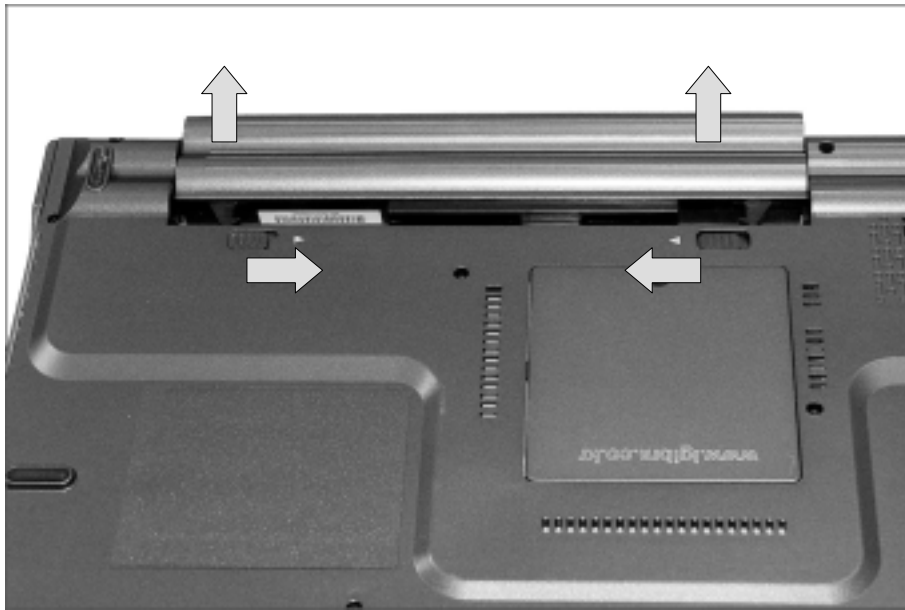

Ch5. Removing and replacing a part

■ 1020 Hard Disk Drive

Remove the following parts in order before replacing this part.

a. Battery Pack(1010)

1. Remove a screw as indicated in the picture, then pull the HDD assembly out in the direction shown below.

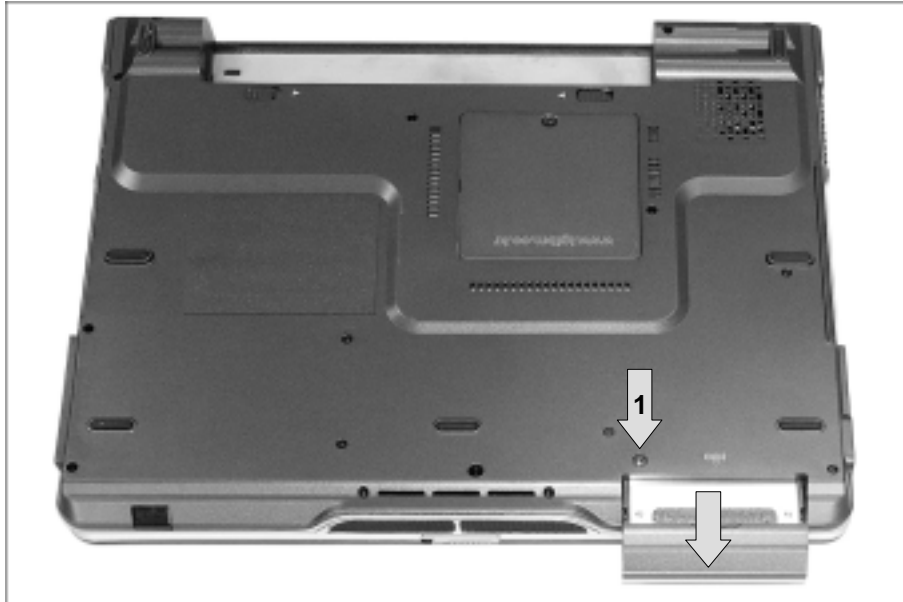

No.	FRU No.	Specification	Qty
1	1SZZBA4011E	M3.0 X L5.0	1

Ch5. Removing and replacing a part

■ 1030 Retainer

Remove the following parts in order before replacing this part.

a. Battery Pack(1010)

1. Remove 2 screws.

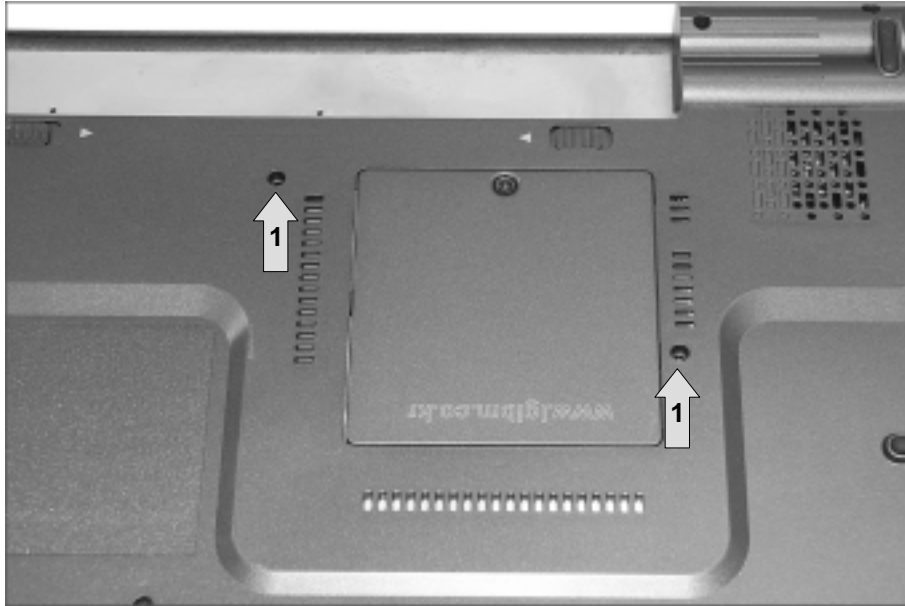

No.	FRU No.	Specification	Qty
1	1SZZBA4083A	M2.0 X L8.0	2

Ch5. Removing and replacing a part

2. To remove three hooks, insert a (-) type screwdriver into a hook located at the lower end of keyboard, and pull it up.



Ch5. Removing and replacing a part

3. Disconnect the keyboard connector.



Ch5. Removing and replacing a part

■ 1040 Retainer

Remove the following parts in order before replacing this part.

a. Battery Pack(1010) b. Keyboard(1030)

1. Pull up the retainer, and remove the connector using a (-) type screwdriver.

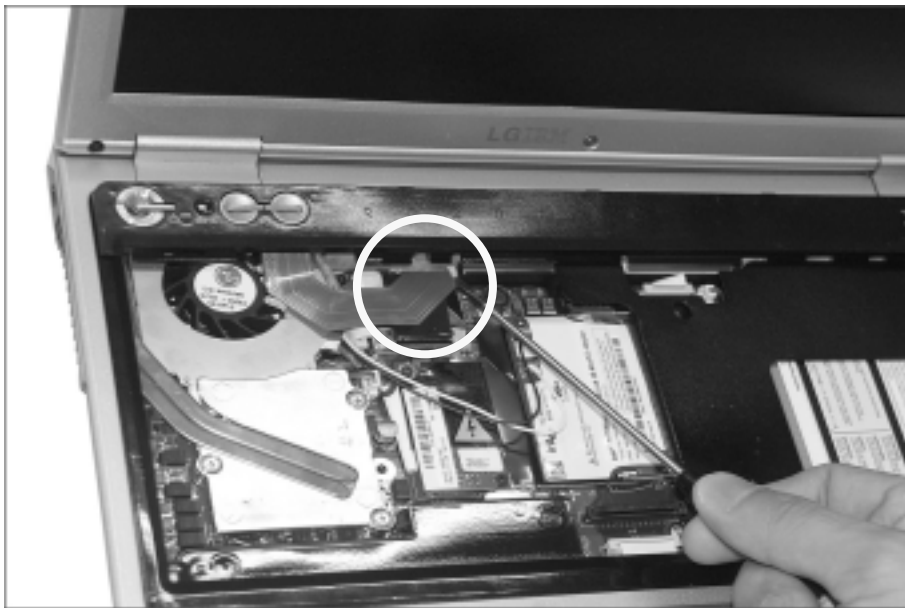
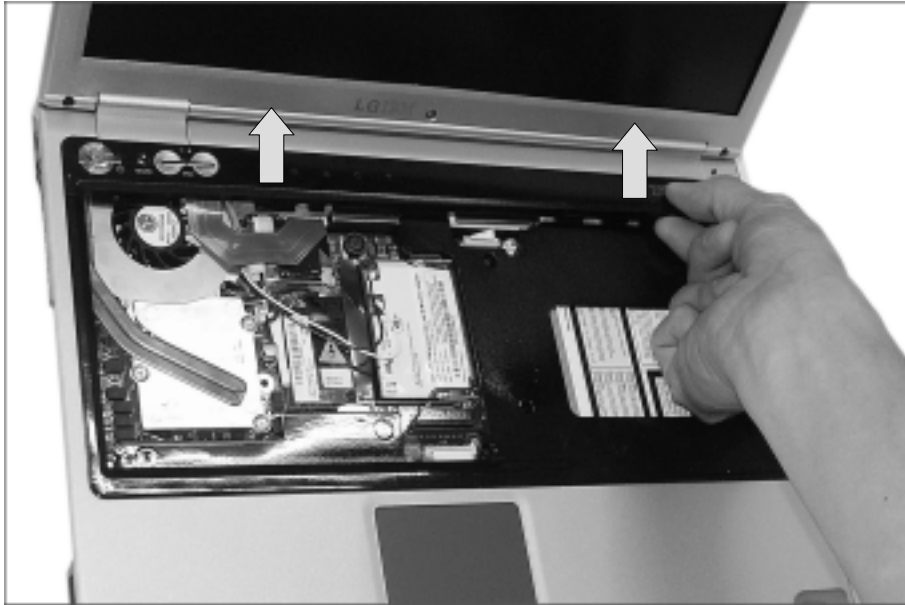

Ch5. Removing and replacing a part

■ 1050 Fan Assembly

Remove the following parts in order before replacing this part.

a. Battery Pack(1010) b. Keyboard(1030) c. Retainer(1040)

1. After removing a screw and the connector, pull up and remove the fan assembly using a (-) type screwdriver.



No.	FRU No.	Specification	Qty
1	1SZZBZ4020A	M2.0 X L8.8	3

Ch5. Removing and replacing a part

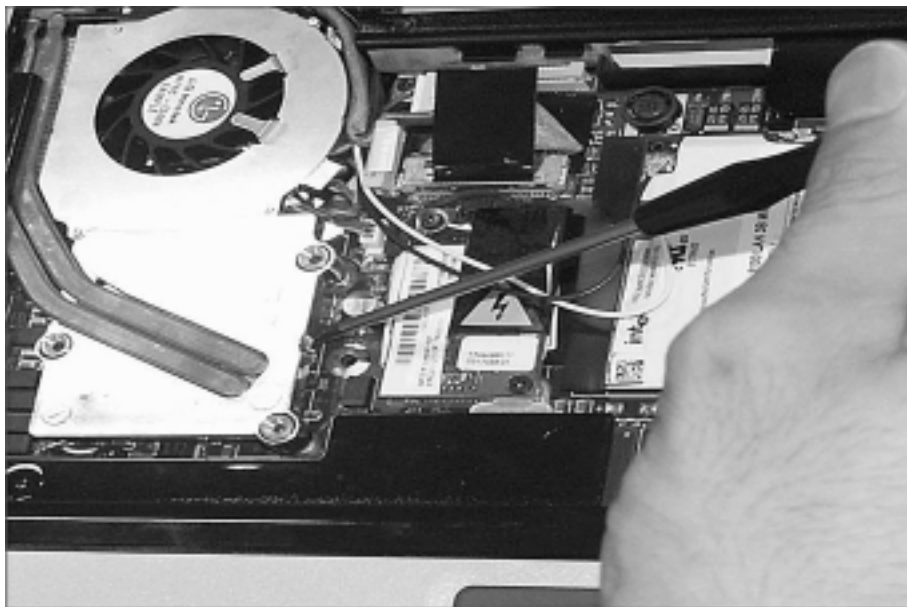
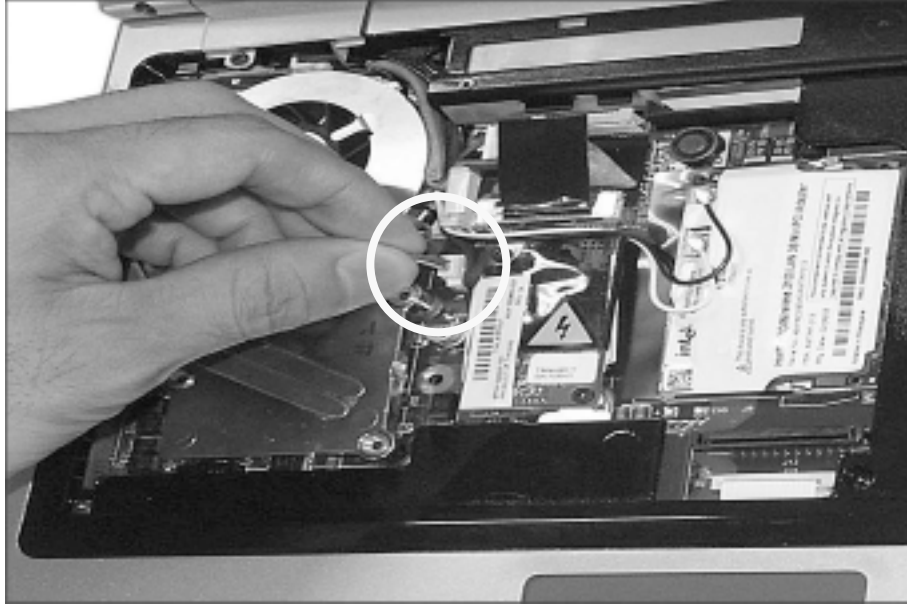

Ch5. Removing and replacing a part

■ 1060-1 Optical Disk Drive (15" Model)

Remove the following parts in order before replacing this part.

a. Battery Pack(1010) b. Keyboard(1030) c. Retainer(1040)

1. Remove a screw, insert a screwdriver into the hole located at the rear of ODD and push it out.

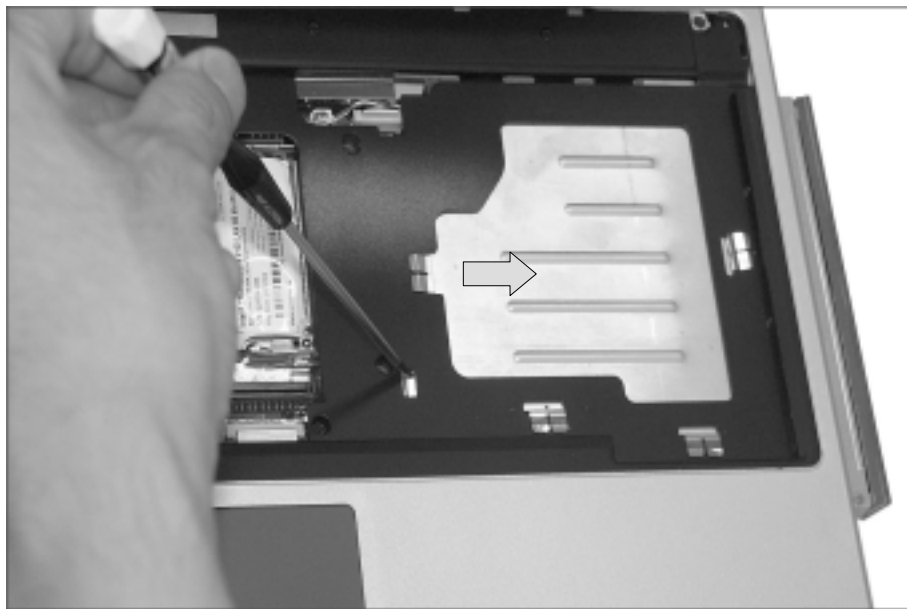
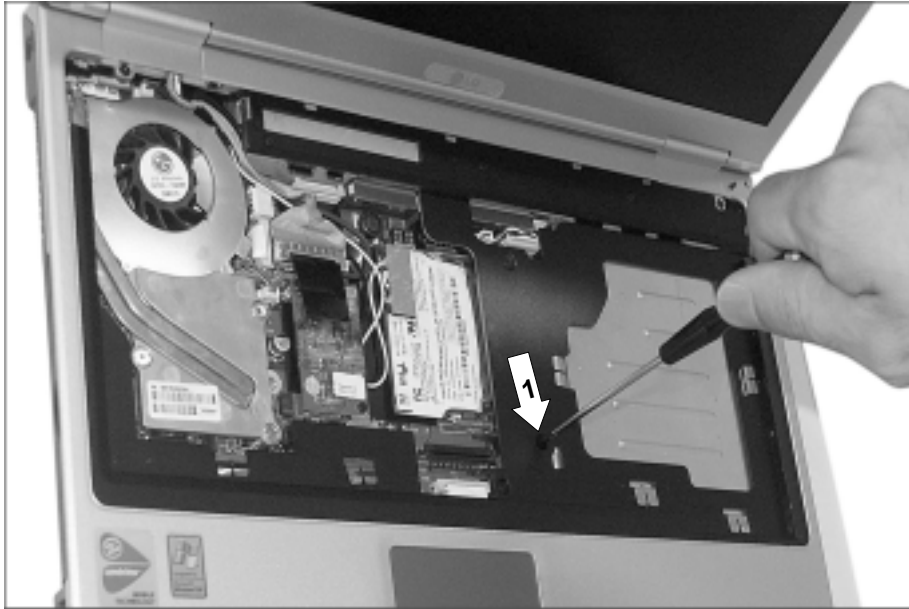

No.	FRU No.	Specification	Qty
1	1SZZBZ4014A	M2.0 X L5.0	1

Ch5. Removing and replacing a part

■ 1060-2 Optical Disk Drive (14.1" Model)

Remove the following parts in order before replacing this part.

a. Battery Pack(1010) b. Keyboard(1030) c. Retainer(1040)

1. Remove a screw, insert a screwdriver into the back side of ODD and push it out.

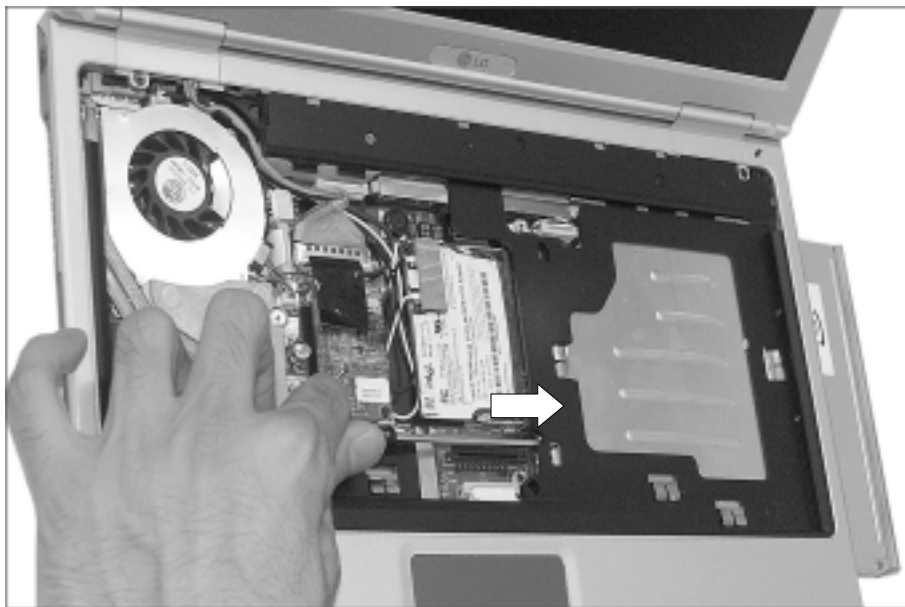
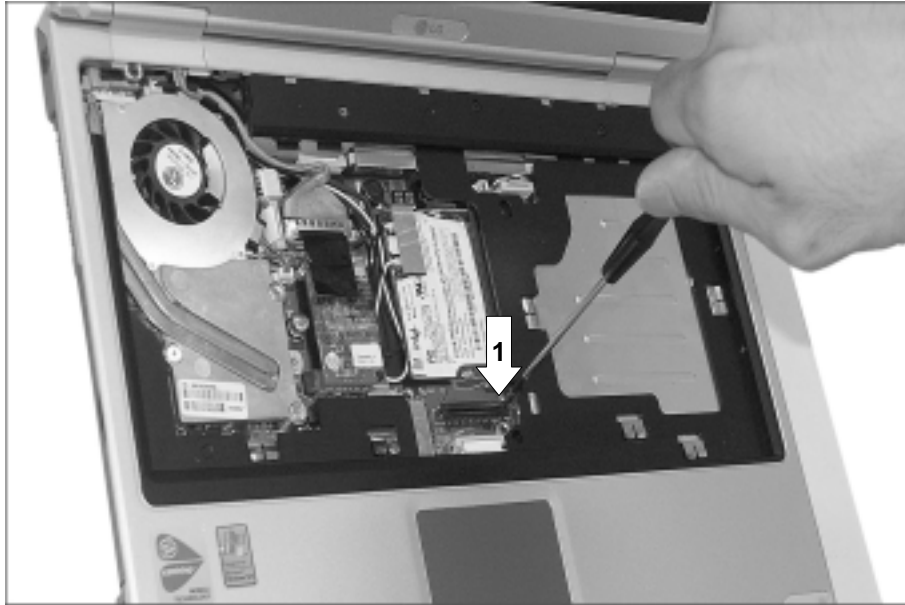

No.	FRU No.	Specification	Qty
1	1SZZBZ4014A	M2.0 X L5.0	1

Ch5. Removing and replacing a part

■ 1070 Wireless LAN Card

Remove the following parts in order before replacing this part.

a. Battery Pack(1010) b. Keyboard(1030) c. Retainer(1040)

1. Remove two wireless LAN card connector, open card knob to take out the card.

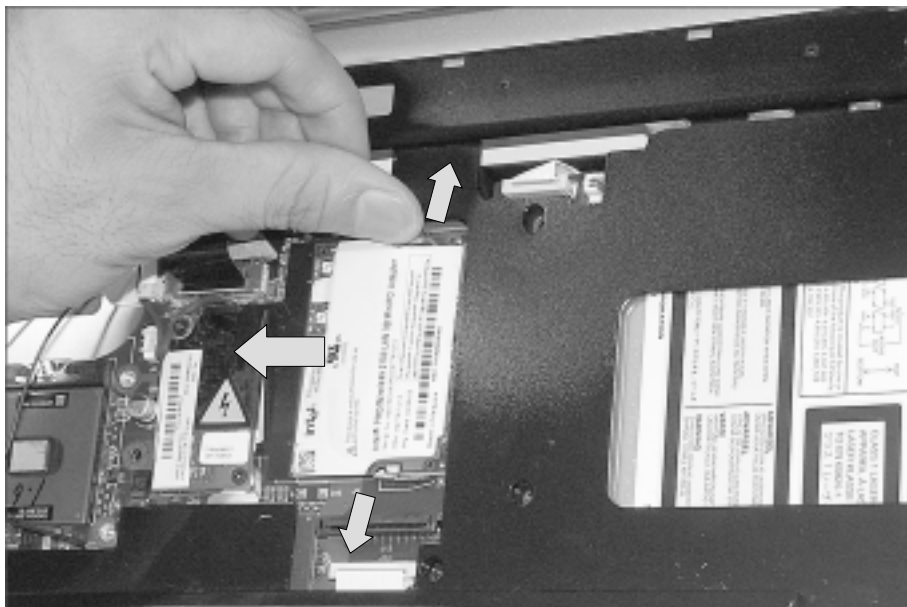
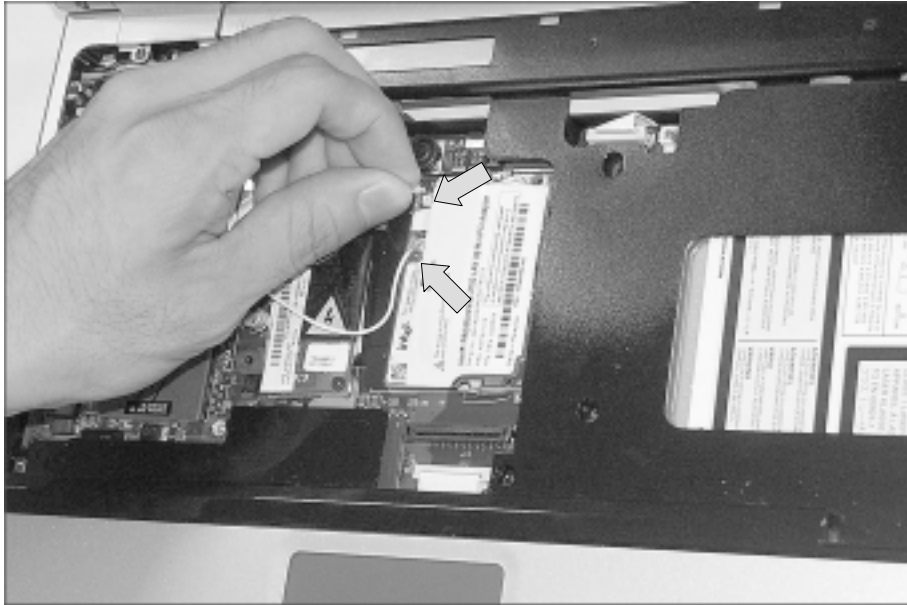

Ch5. Removing and replacing a part

■ 1080 MDC Modem Card

Remove the following parts in order before replacing this part.

a. Battery Pack(1010) b. Keyboard(1030) c. Retainer(1040)

1. Remove two screws and insert a screwdriver below the modem. Pull it up to disassemble.

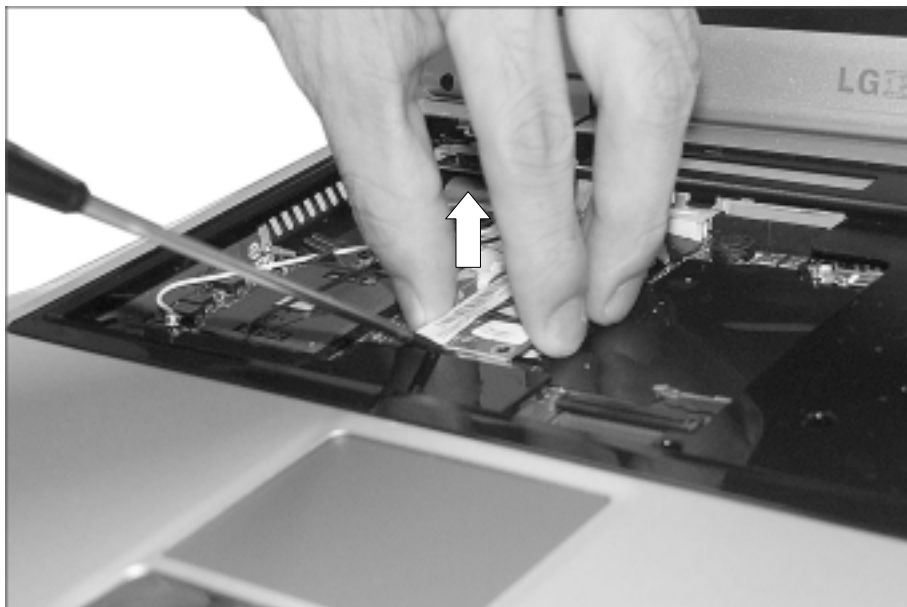
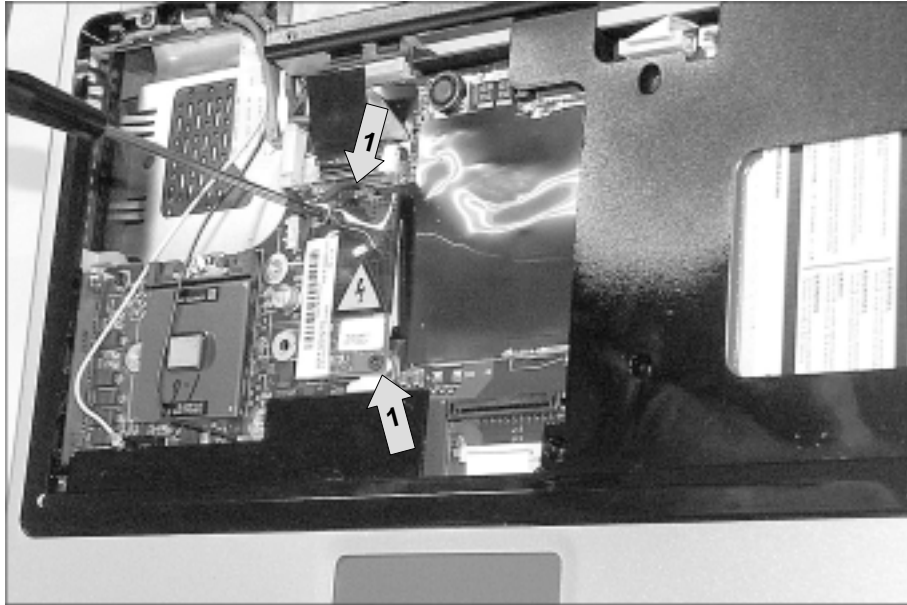

No.	FRU No.	Specification	Qty
1	1SZZBA4017B	M2.0 X L3.5	2

Ch5. Removing and replacing a part

■ 1090 Display Module

Remove the following parts in order before replacing this part.

a. Battery Pack(1010) b. Keyboard(1030) c. Retainer(1040) d. Wireless LAN Card(1070)

1. Remove two screws.

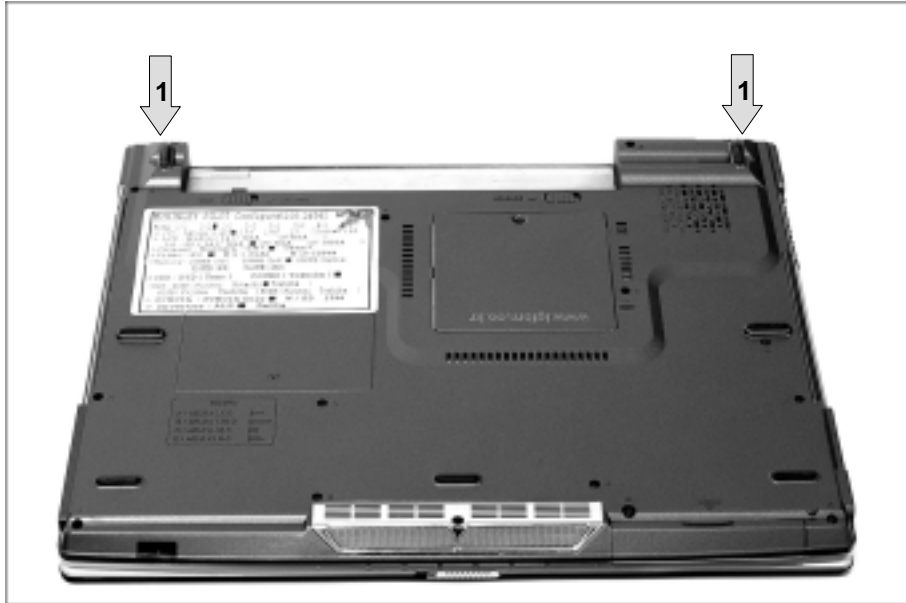

No.	FRU No.	Specification	Qty
1	1SZZBA4039B	M2.5 X L8.0	2

Ch5. Removing and replacing a part

2. Remove two hinge cover screws.

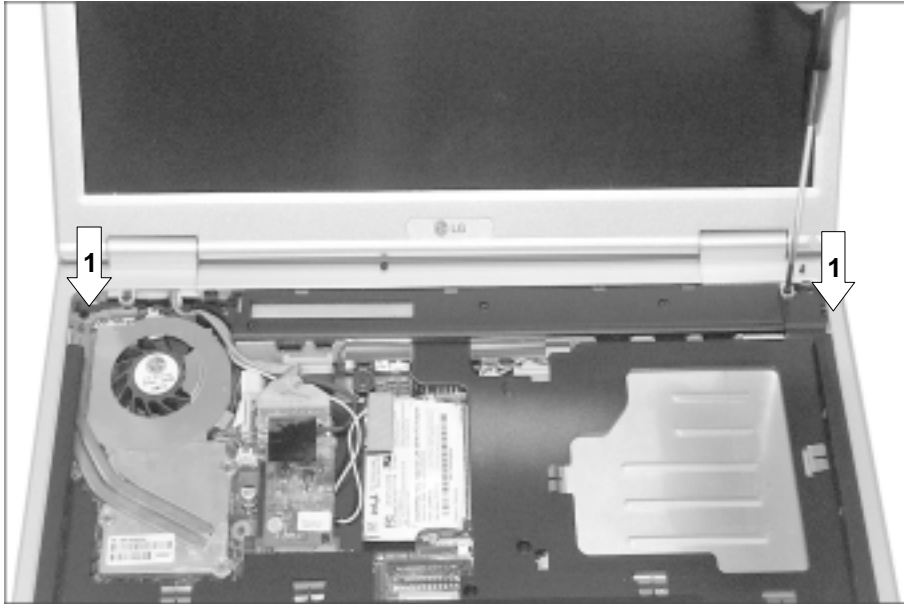

No.	FRU No.	Specification	Qty
1	1SZZBZ4014A	M2.0 X L5.0	2

Ch5. Removing and replacing a part

- Using a (-) type screwdriver from the back of LCD, pull up the hinge cover with your finger. Then more you move the LCD to the back, the easier the hinge cover will pull out. Remove another hinge cover located on the other side.

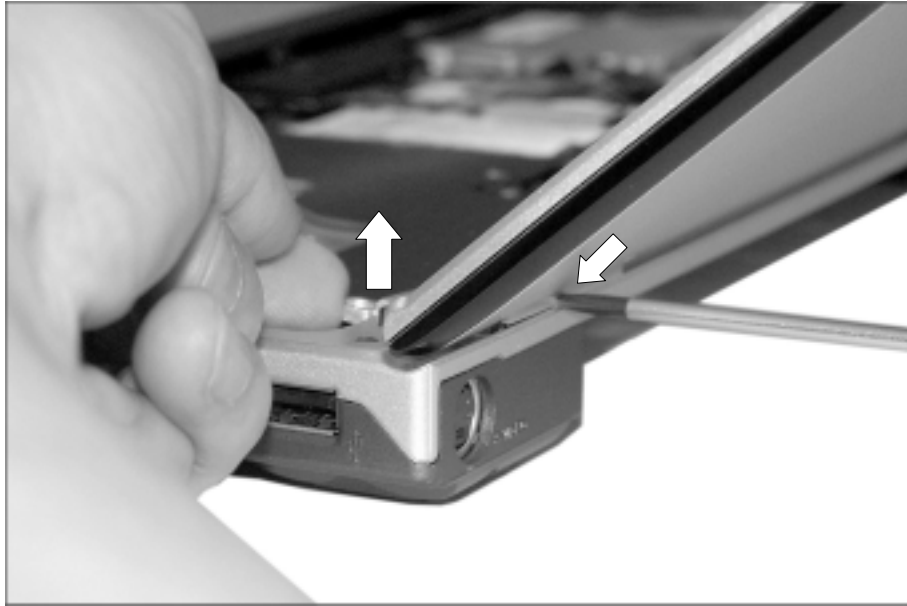

- Remove two hinge screws.

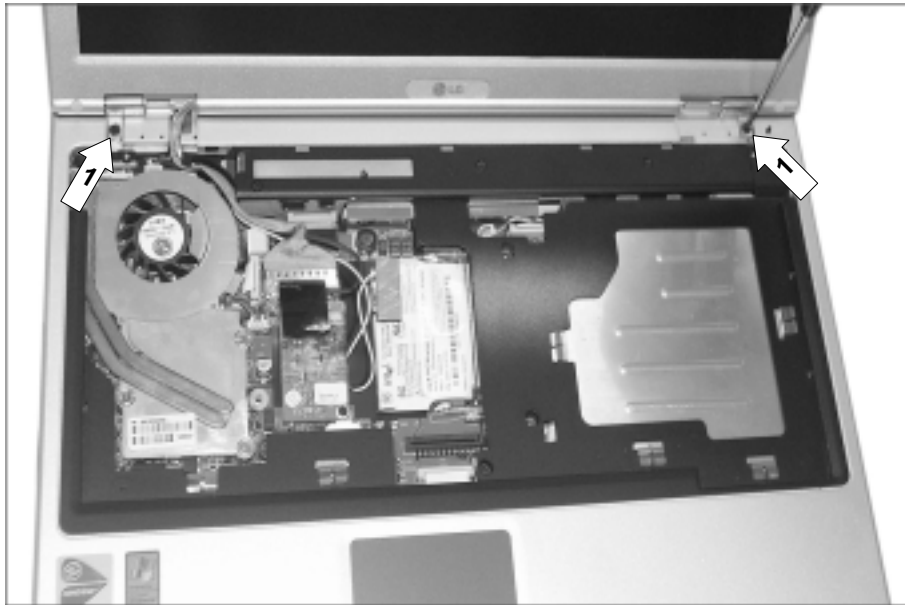

No.	FRU No.	Specification	Qty
1	1SZZBA4039B	M2.5 X L8.0	2

Ch5. Removing and replacing a part

5. Remove the LCD connector located at the upper end of MCD modem. You will see a tag designed to make work easier. Pull out the tag.

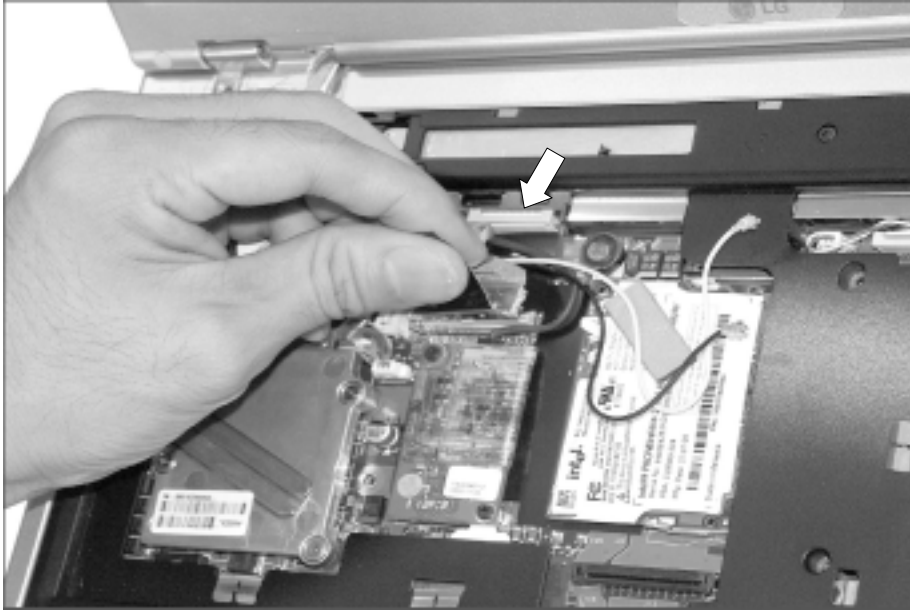

4. Remove the LCD cable.



Ch5. Removing and replacing a part

7. Hold the LCD with your both hands, and pull it up to remove.

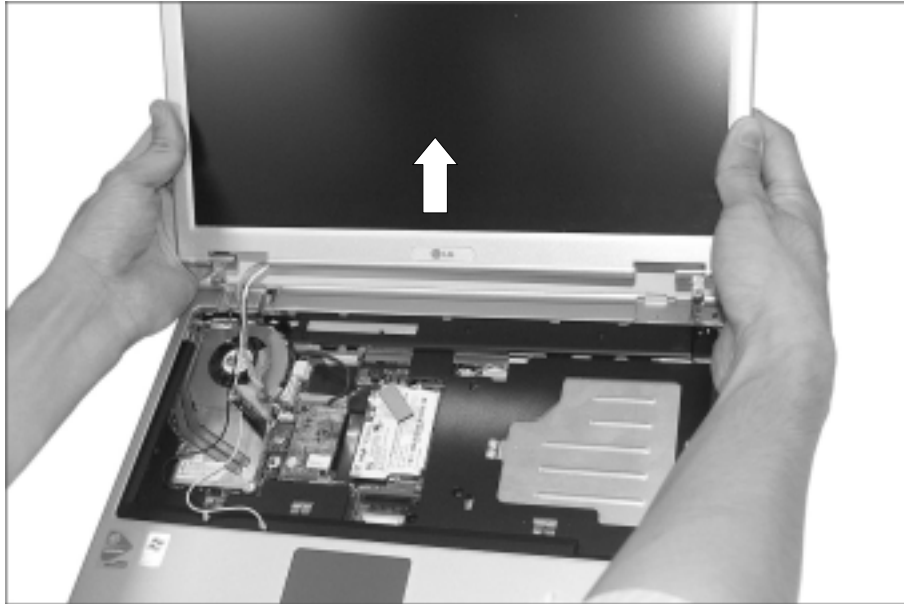

Note

Display Module disassembly in detail (1140)

Ch5. Removing and replacing a part

■ 1100 Keyboard Deck

Remove the following parts in order before replacing this part.

- a. Battery Pack(1010) b. Keyboard(1030) c. Retainer(1040) d. Fan Assembly(1050)
e. Wireless LAN Card (1070) f. MDC Modem Card(1080) g. Display Module(1090)

1. Remove 14 screws (for 15" model) or 11 screws (for 14.1" model).

The screw type is shown on the set for your reference.

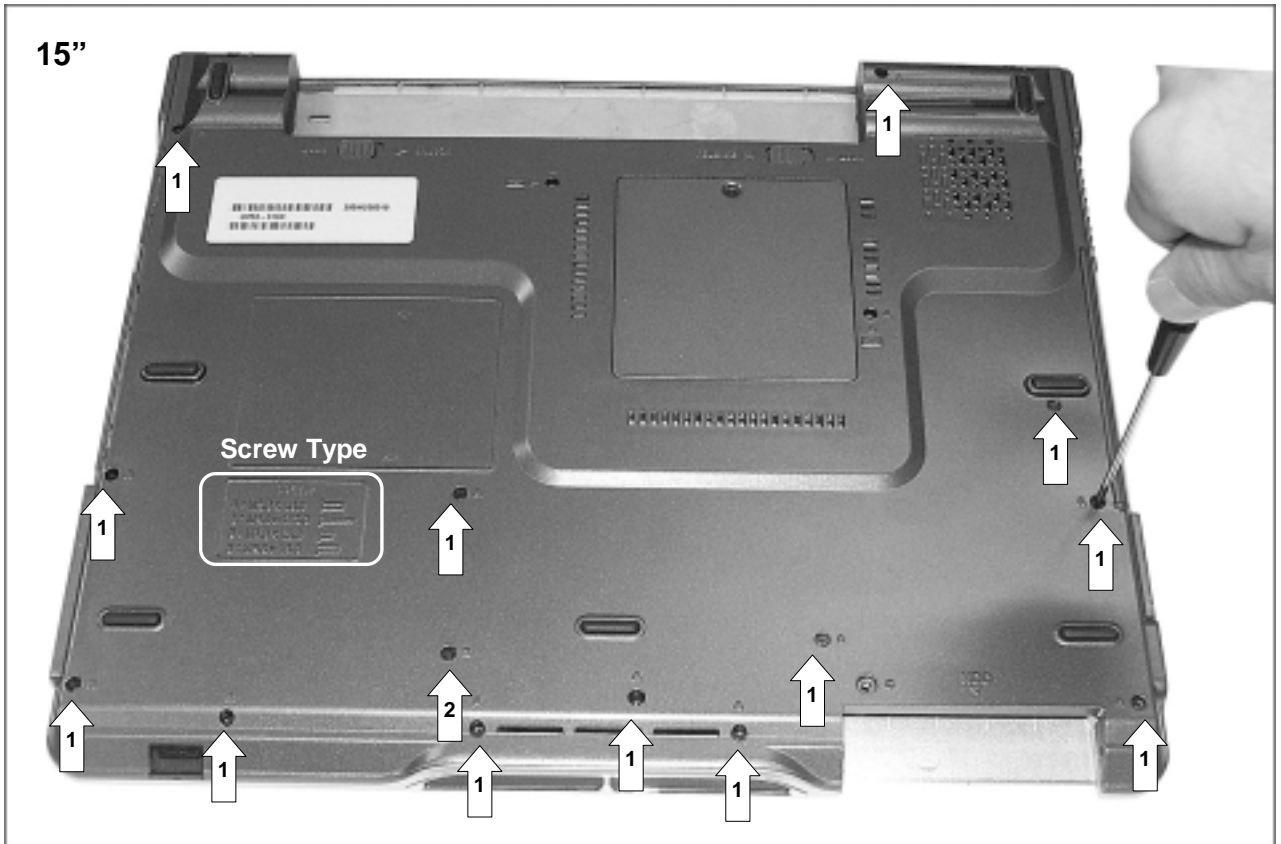

No.	FRU No.	Specification	Qty
1	1SZZBA4083A	M2.0 X L8.0	13
2	1SZZBA4067A	M2.0 X L13.0	1

Ch5. Removing and replacing a part

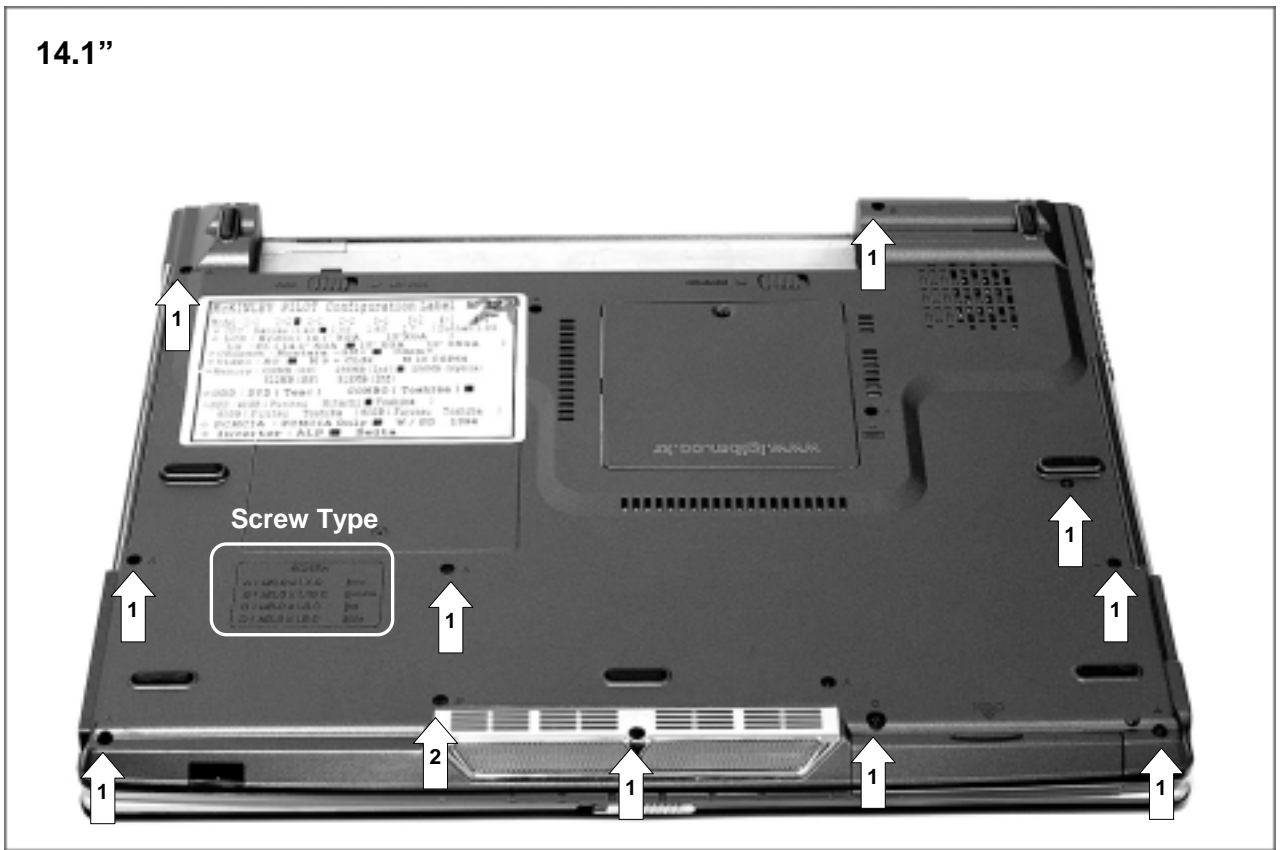

No.	FRU No.	Specification	Qty
1	1SZZBA4083A	M2.0 X L8.0	10
2	1SZZBA4067A	M2.0 X L13.0	1

Ch5. Removing and replacing a part

2. Open the I/O port cover and remove two screws.

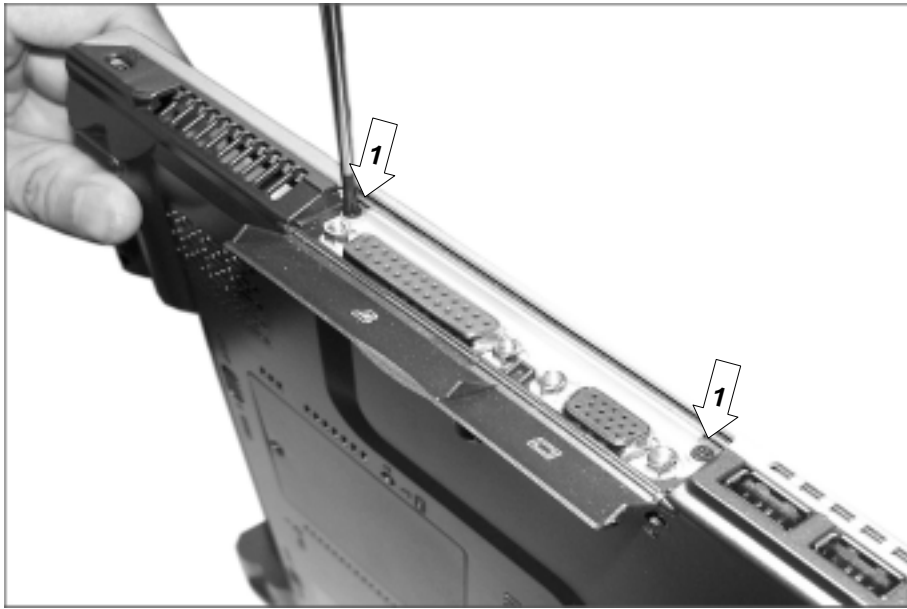

No.	FRU No.	Specification	Qty
1	1SZZBA4017B	M2.0 X L3.5	2

Ch5. Removing and replacing a part

3. Remove 3 screws.

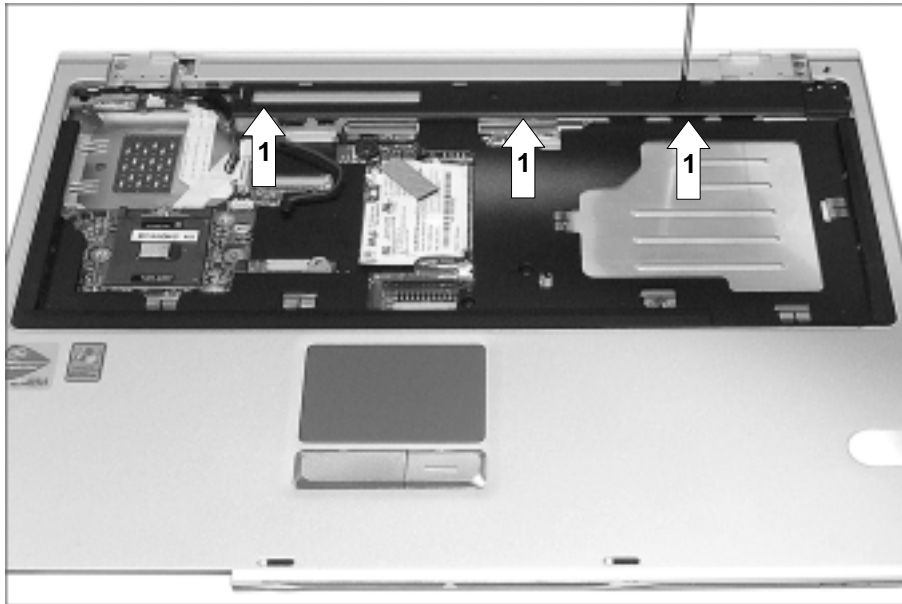

No.	FRU No.	Specification	Qty
1	1SZZBZ4018B	M2.0 X L2.0	3

Ch5. Removing and replacing a part

4. Remove the cable, hold the keyboard deck with your both hands and pull it out.

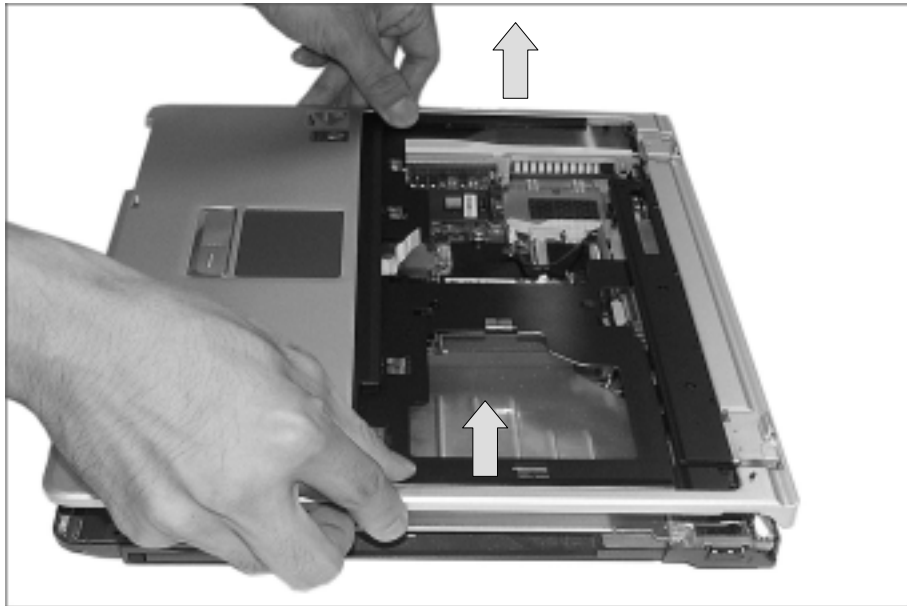
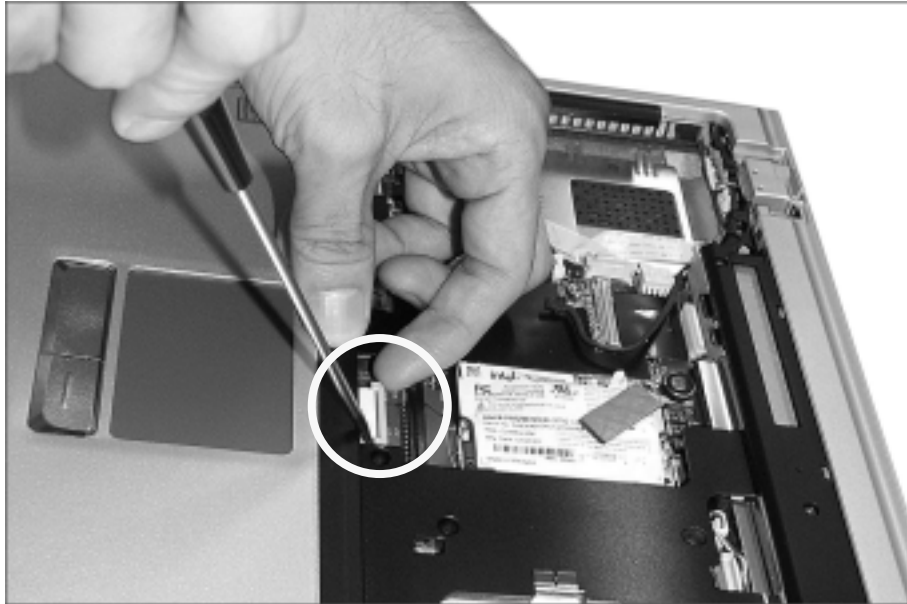

Ch5. Removing and replacing a part

5. Remove the speaker cable located at the front of key deck that is pulled up.

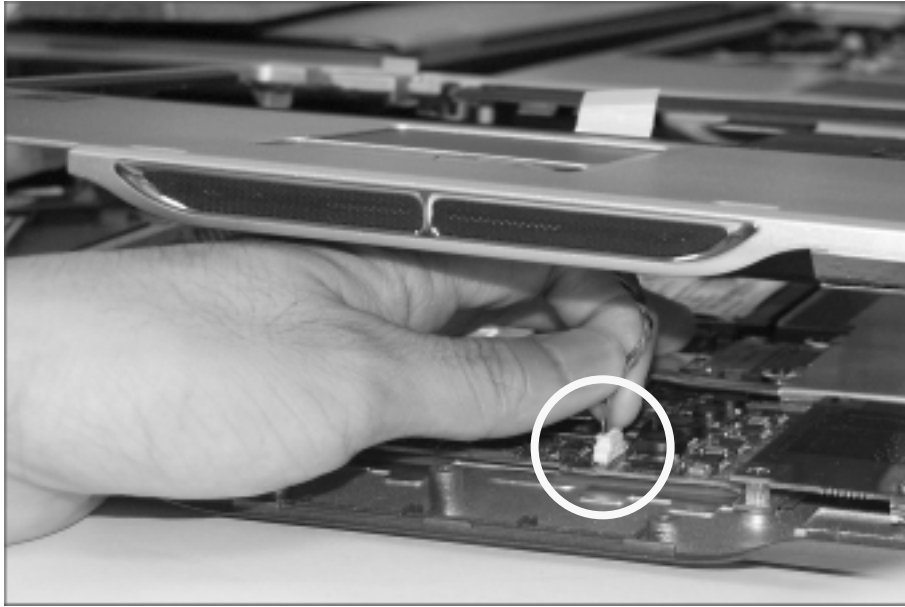

Ch5. Removing and replacing a part

■ 1110 Main Board

Remove the following parts in order before replacing this part.

- a. Battery Pack(1010) b. Keyboard(1030) c. Retainer(1040) d. Fan Assembly(1050)
- e. Wireless LAN Card (1070) f. MDC Modem Card(1080) g. Display Module(1090)
- h. Keyboard Deck(1100)

1. Remove two screws and disassemble the ODD Plate Assembly.

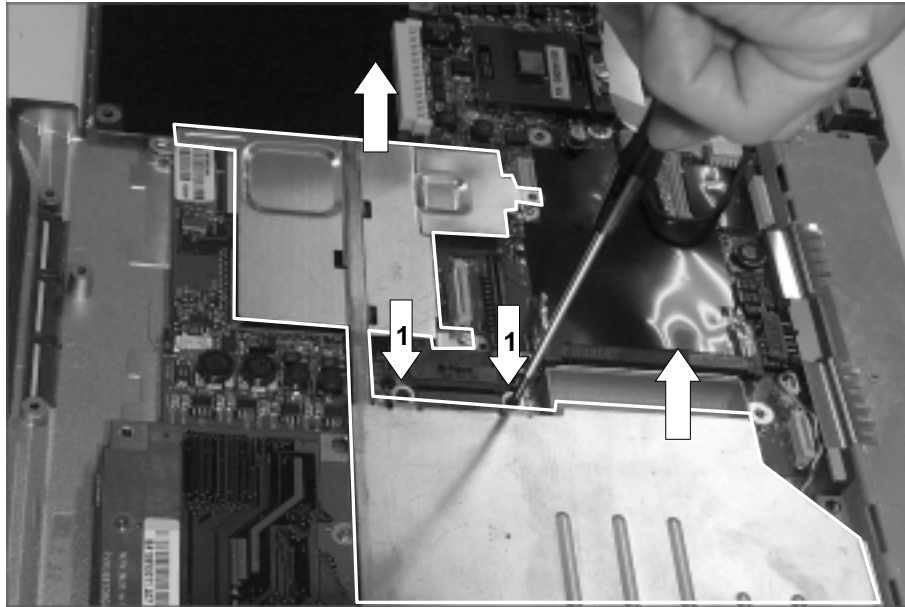

No.	FRU No.	Specification	Qty
1 (14.1")	1SZZBZ3009B	M2.0 X L2.5	2
1 (15")	1SZZBZ4014A	M2.0 X L5.0	2

Ch5. Removing and replacing a part

2. Remove the PCMCIA board.

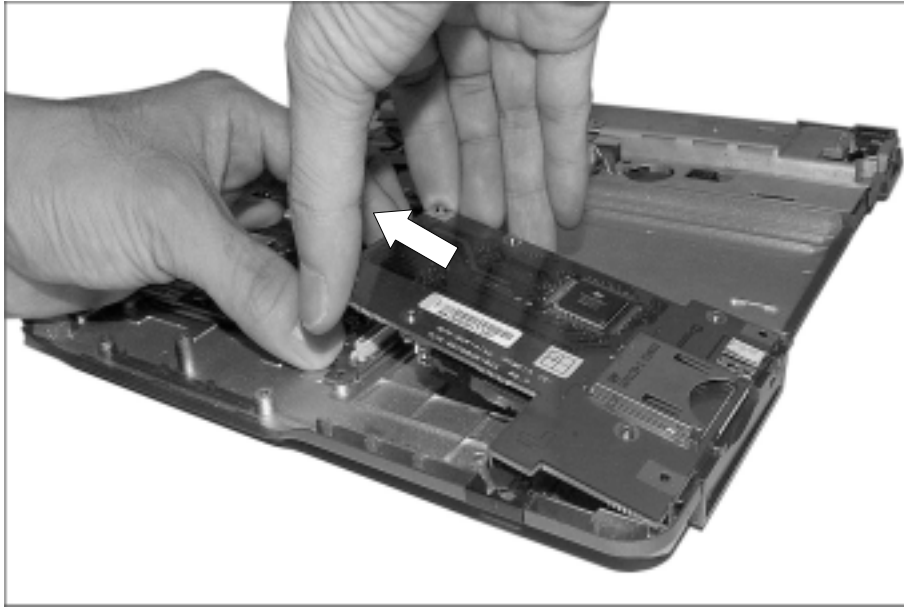

3. Remove the RTC battery connector from Main Board.

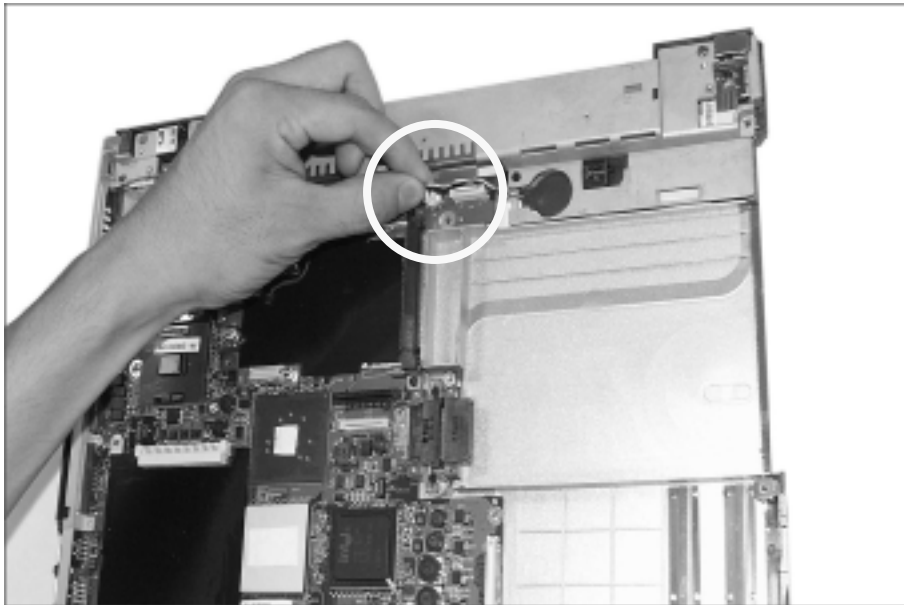

Ch5. Removing and replacing a part

4. Remove the S-Video connector.

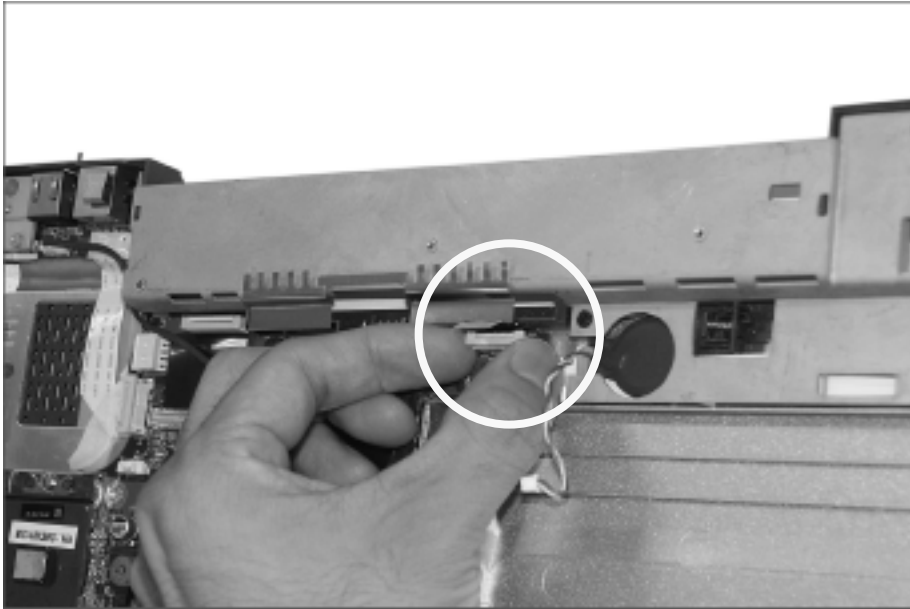

5. Remove the LAN S/B connector.

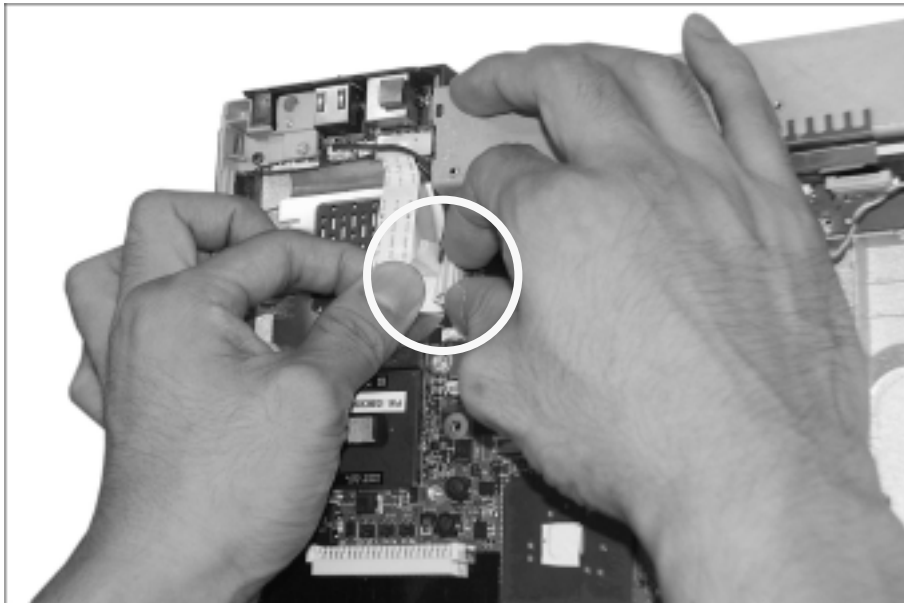

Ch5. Removing and replacing a part

6. Remove the power cable.

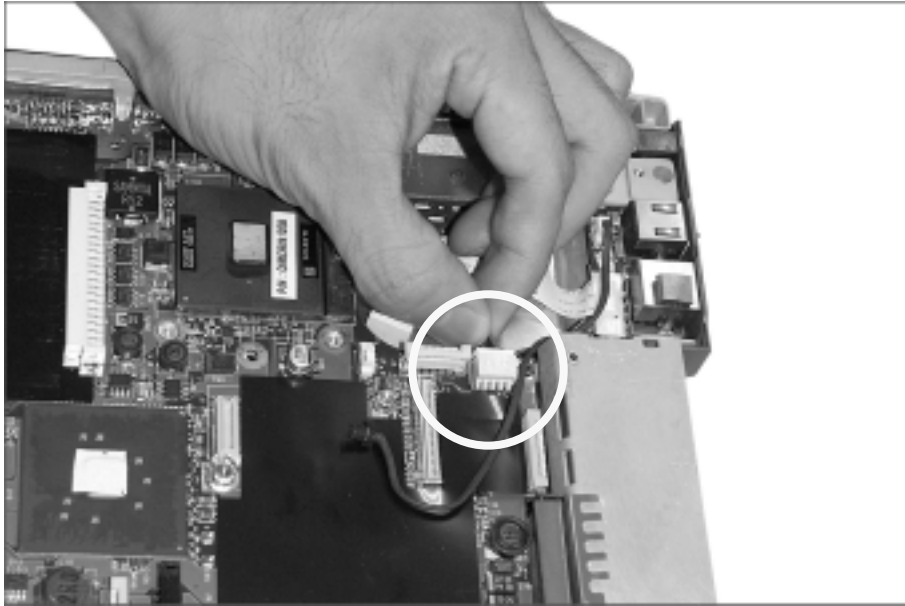

7. Remove 4M/B screws.

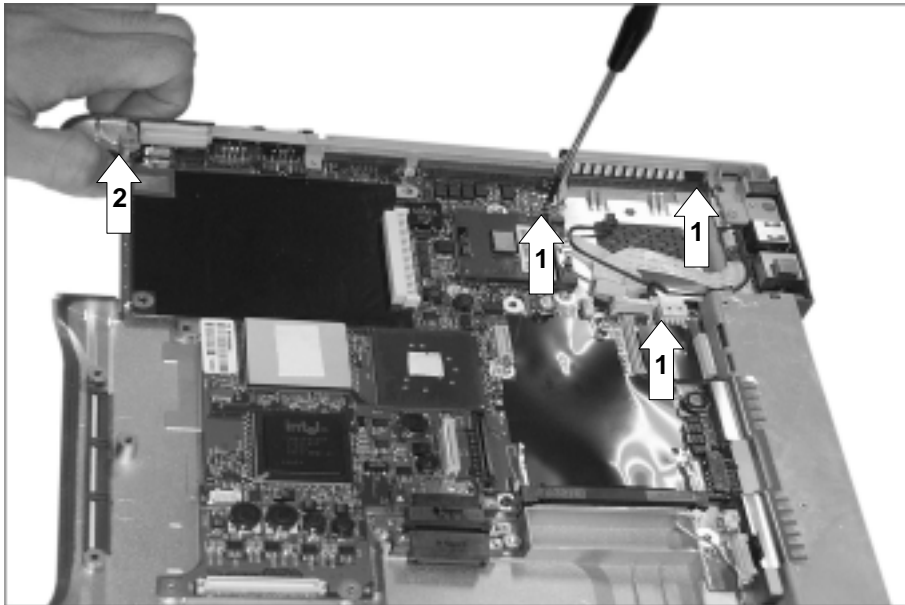

No.	FRU No.	Specification	Qty
1	1SZZBA4014A	M2.0 X L5.0	3
2	1SZZBA4017B	M2.0 X L3.5	1

Ch5. Removing and replacing a part

8. Hold M/B with your both hand and pull it up to remove.

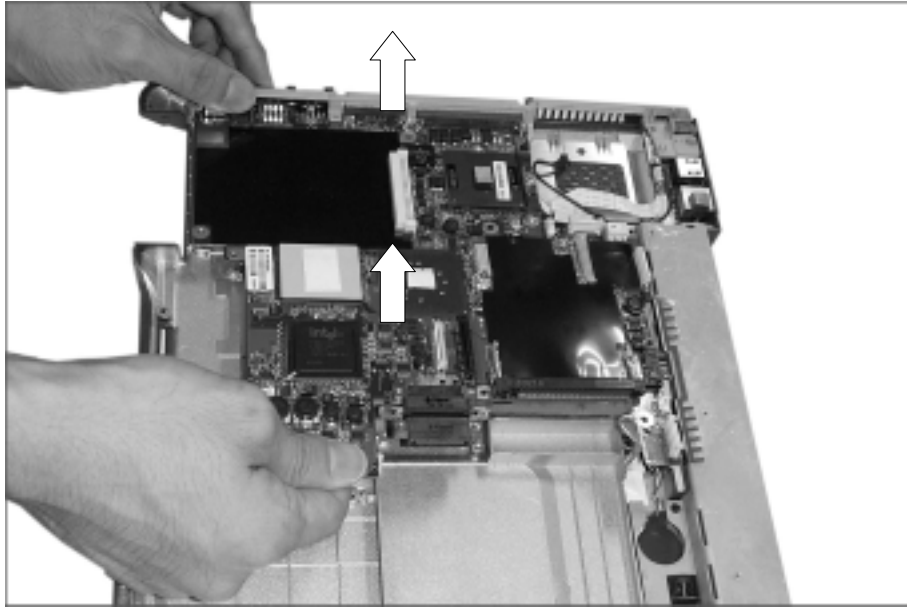

Ch5. Removing and replacing a part

■ 1120 Battery Frame Assembly

Remove the following parts in order before replacing this part.

- a. Battery Pack(1010) b. Keyboard(1030) c. Retainer(1040) d. Fan Assembly(1050)
e. Wireless LAN Card (1070) f. MDC Modem Card(1080) g. Display Module(1090)
h. Keyboard Deck(1100) i. Main Board(1110)

1. Remove a screw.

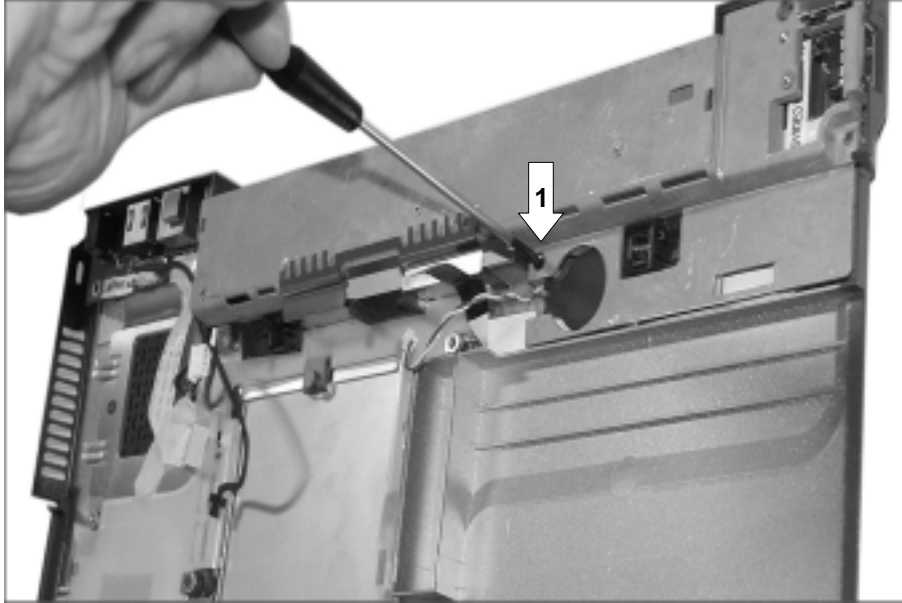

No.	FRU No.	Specification	Qty
1	1SZZBA4017B	M2.0 X L3.5	1

Ch5. Removing and replacing a part

2. Pull up the battery frame finger plate, and remove the battery frame assembly. The LAN S/B will be removed as well when the battery frame assembly is disassembled.

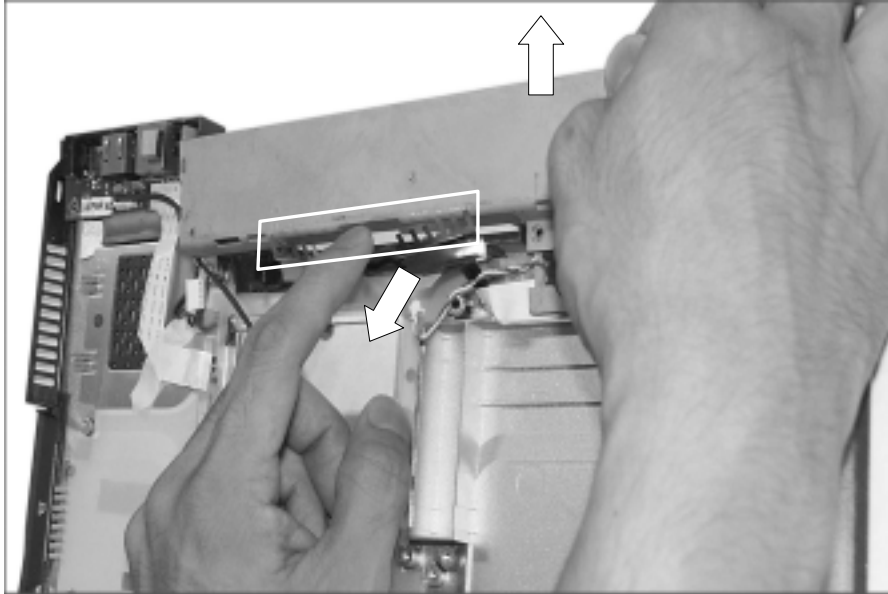

Ch5. Removing and replacing a part

■ 1130 S-Video Sub-Board

Remove the following parts in order before replacing this part.

- a. Battery Pack(1010) b. Keyboard(1030) c. Retainer(1040) d. Fan Assembly(1050)
- e. Wireless LAN Card (1070) f. MDC Modem Card(1080) g. Display Module(1090)
- h. Keyboard Deck(1100) i. Main Board(1110)

1. Remove the S-Video sub-board.

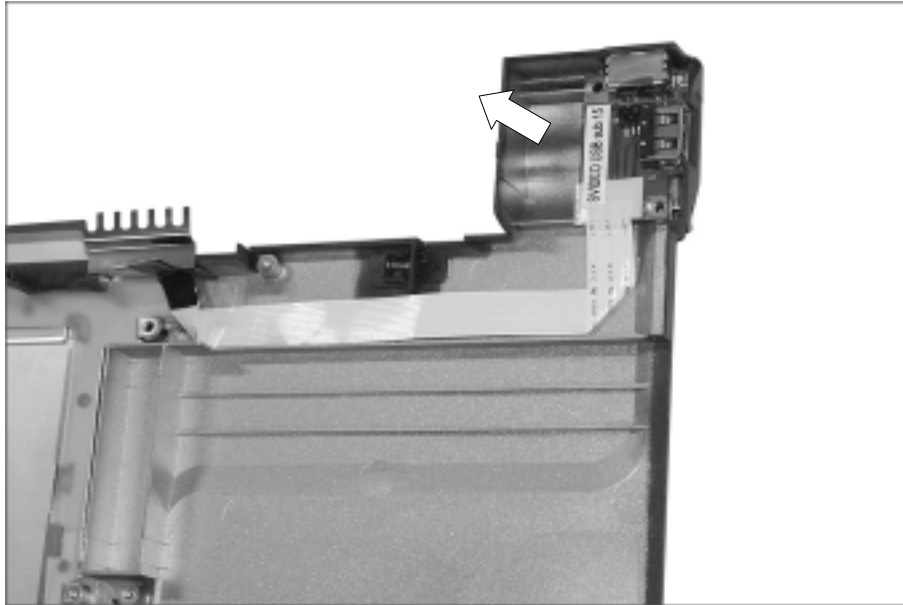

Ch5. Removing and replacing a part

■ 1140 Display Module

Remove the following parts in order before replacing this part.

- a. Battery Pack(1010) b. Keyboard(1030) c. Retainer(1040) d. Fan Assembly(1050)
e. Wireless LAN Card (1070)

1. Using a knife, remove the logo and rubbers that are covering the screws. Then remove all 7 screws.

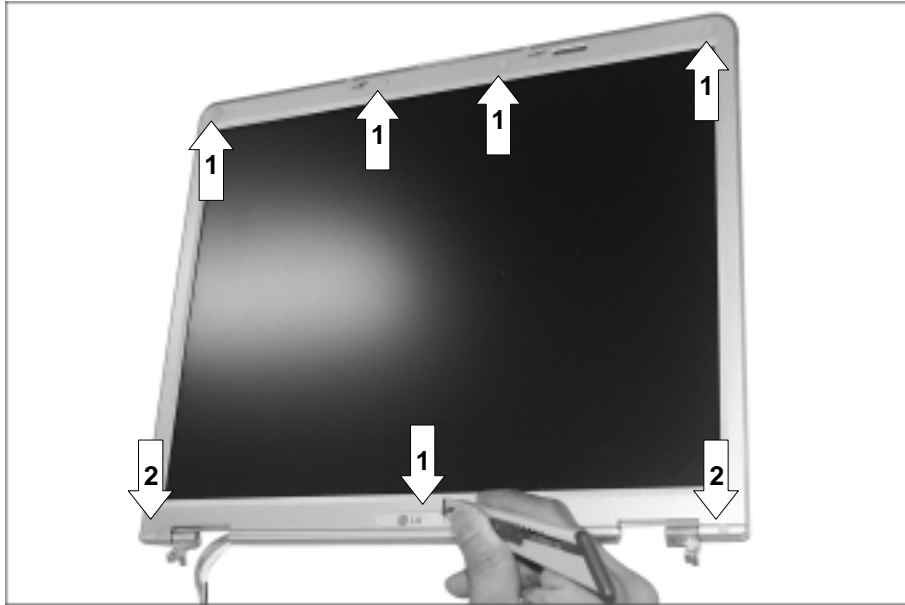

No.	FRU No.	Specification	Qty
1	1SZZBA4044B	M2.5 X L4.0	5
2	1SZZBA4068A	M2.5 XL5.0	2

Ch5. Removing and replacing a part

2. Disassemble the LCD front. The front hook located on the middle of LCD upper and lower end.
Be careful of the direction when removing because it is connected from inside out.



Ch5. Removing and replacing a part

3. Remove cable connector. Remove the cable that is arranged around LCD from LCD frame.

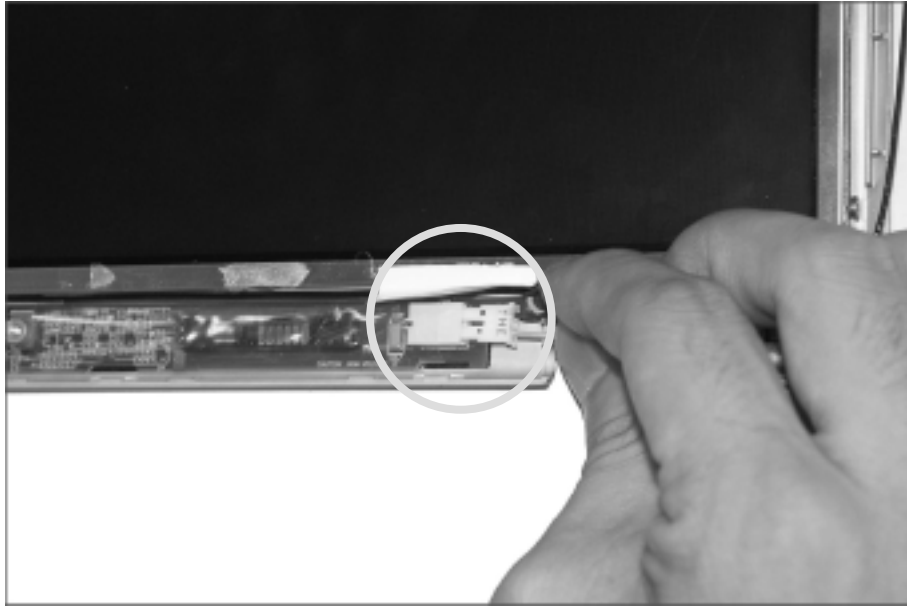

Ch5. Removing and replacing a part

4. Remove 9 screws (for 15" model) or 8 screws (for 14.1").



No.	FRU No.	Specification	Qty
1	1SZZBZ3009B	M2.0 X L2.5	4
2	1SZZBA4044B	M2.5 XL4.0	4
3 (15")	1SZZBA4041A	M2.0 X L3.0	1

Ch5. Removing and replacing a part

5. Press the hook on the both side of LCD with a (-) type screwdriver and remove from the LCD real panel.



Ch5. Removing and replacing a part

6. Remove LCD from the LCD rear panel.

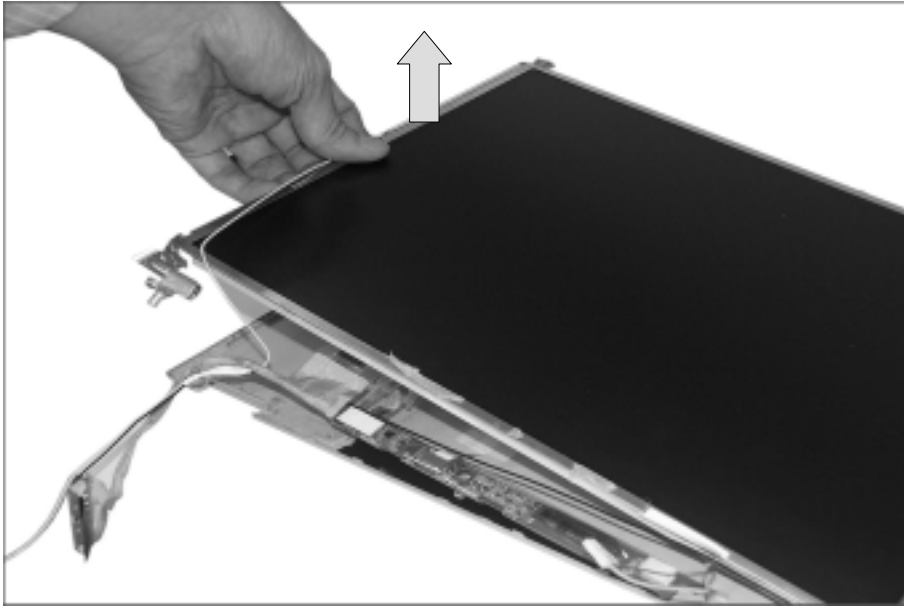

Ch6. Part lists

Chapter 6. Part lists

2004. 4. 28. MKB21

Location	LG P/N	SPECIFICATION	REMARKS
MKL02	6304FLP081A	TFT LCD, LG PHILIPS LP150E06-A2 15.0 INCH SXGA+	
MKL02	6304FLP080A	TFT LCD, LG PHILIPS LP150X08-A3M1 15.0 INCH XGA	
MKL02	6304FAU002B	TFT LCD, AU B150XG01 15.0 INCH XGA	
MKL02	6304FBH005A	TFT LCD, BOE-HYDIS HT15X34-100 15.0 INCH XGA	
MKL03	3111BZ7101A	CASE ASSY, FRONT 15.0"	
MKL04	4940BM4146A	KNOB, LATCH	
MKL05	4026BM3013A	LATCH, DISPLAY	
MKL06	4970BW4540A	SPRING, LCD LATCH	
MKL07	4850BM4010A	CUSHION, RUBBER UPPER	
MKL08	4850BM4011A	CUSHION, RUBBER LOWER	
MKL09	4775B00033A	HINGE ASSY, LEFT 15.0"	
MKL10	4775B00034A	HINGE ASSY, RIGHT 15.0"	
MKL11	6851B76028A	CABLE ASSY, LCD 15.0"	
MKL12	6871BZT17AA	CABLE FPC, WIRELESS INDICATOR 15.1"	
MKL13	6708BI0082A	INVERTER, ALPS KUBNKM063A	
MKL13	6708BI0083A	INVERTER, DELTA DAC-08B043A	
MKL14	3110BD0009B	REAR CASE, 15.0" FOR EXPORT	
MKL14	3110BD0009D	MCKINLEY MG DISPLAY REAR 15.0" FOR MC REFRESH	For refresh model
MKL15	3858BZ3019A	INSULATOR, INVERTER 14.1"/15.0"	
MKL16	3301BZ0512B	ANTENNA, WIRELESS RIGHT	
MKL17	3550BM2093B	DECORATION COVER, 15.0" FOR EXPORT	
MKL18	3301BZ0513B	ANTENNA, WIRELESS LEFT	
MKL20	6304FBH004A	TFT LCD, BOE HYDIS HT14X1B-110 14.1 INCH XGA	
MKL20	6304FLP079A	TFT LCD, LG PHILIPS LP141X13-C2 14.1 INCH XGA	
MKL20	6304FLP079B	LP141X13-C2K1 LG PHILIPS TFT COLOR 14.1 INCH XGA(1024X768) ISP STYLE B	
MKL21	3111BZ7100A	CASE ASSY, FRONT 14.1"	
MKL22	3680BM3036A	LENS, WIRELESS REAR 14.1"	
MKL23	3550BM1149B	DECORATION COVER, 14.1" FOR EXPORT	
MKL24	4775BZ1004A	HINGE ASSY, LEFT 14.1"	
MKL25	4775BZ1005A	HINGE ASSY, RIGHT 14.1"	
MKL26	6851B76024A	CABLE ASSY, LCD 14.1"	
MKL27	3858BZ3020A	INSULATOR, LED 14.1"	
MKL28	3110BD0008B	REAR CASE, 14.1" FOR EXPORT	

Ch6. Part lists

Location	LG P/N	SPECIFICATION	REMARKS
MKL28	3110BD0008D	MCKINLEY MG DISPLAY REAR 14.1" FOR MC REFRESH	For refresh
MKL29	6871BZT16ZA	CABLE FPC, WIRELESS INDICATOR 14.1"	
MKL30	3850BB3035D	MODEL NAME LABEL, MCKINLEY 14.1" FOR EXPORT	
MKL30	3850BB3035E	MODEL NAME LABEL, MCKINLEY 15.0" FOR EXPORT	
MKL30	3850BB3035P	MCKINLEY N N MODEL NAME LABEL 14.1" MCKINLEY LM40A FOR REFRESH EXPORT	For refresh model
MKL30	3850BB3035Q	MCKINLEY N N MODEL NAME LABEL 15" MCKINLEY LM50A FOR REFRESH EXPORT	For refresh model
MKL31	3858BZ4450B	MCKINLEY N N N MCKINLEY BADGE FOR EXPORT LG	For refresh model
MKB01	6871BF100A1	MAINBOARD ASSY, BH M9+ P.P LGE 8 LAYERS REV 0.5	
MKB01	6871BF200A1	MAINBOARD ASSY, BH M10 P.P LGE 8 LAYERS REV 0.5	
MKB01	6871BF300A1	MCKINLEY US007506 REFRESH MODEL . LGE 8 LAYERS REV 0.7 M11 MAINSTEAM MAIN ASSY	For refresh model
MKC01	0IMMRSS090A	MEMORY, SAMSUNG M470L3224FT0-CB3 SODIMM 256MB DDR 333MHZ	
MKC01	0IMMRHY044A	MEMORY, HYNIX HYMD232M646C6-J SODIMM 256MB DDR 333MHZ	
MKC01	0IMMRIH032A	MEMORY, INFINEON HYS64D32020GDL-6-B SODIMM 256MB DDR 333MHZ	
MKC01	0IMMRSS091A	MEMORY, SAMSUNG M470L6423EN0-CB3 SODIMM 512MB DDR 333MHZ	
MKC01	0IMMRIH033A	MEMORY, INFINEON HYS64D64020GBDL-6-B SODIMM 512MB DDR 333MHZ	
MKC02	2029BG0100A	DVD/CDRW COMBO, TOSHIBA SD-R9012 8X 16X 8X 24X BUILT IN 9.5 MM	
MKC02	6777BG0001A	DVD, TEAC DV-28E-BC-43 8X 24X BUILT IN 9.5 MM	
MKC04	6871BZT13A4	WIRELESS LAN, INTEL WM3B2100WW MINI-PCI TYPE IIIB	
MKC04	6871BZT14A4	MCKINLEY N WM3B2200BGRW PRO/WIRELESS2200BG LAN MINI-PCI TYPE INTEL 4 LAYERS 1-14 NETWORK CONNECTION	For refresh model
MKC04	6871BZT13A5	WM3B2100NA1 MINI-PCI TYPE IIIB INTEL 4 LAYERS 1-11 PRO/WIRELESS2100 LAN MINI-PCI TYPE 3B ADAPTER LIO	USA,Canada, Taiwan
MKC05	6871BG105AA	MDC MODEM, AMBIT T60M283.13 56K	
MKC06	6911BZ0045B	LI-ION BATTERY, SIMPLO 4400MAH 3S-2P	
MKC06	6911BZ0046B	LI-ION BATTERY, SIMPLO 6600MAH 3S-3P	
MKC07	5901B09265A	FAN ASSY, W/ SHEET	
MKC08	3823B70004A	MCKINLEY LG-IBM SUNREX-K021102A US-ENG 14.1" 84 KEY	
MKC08	3823B71004A	MCKINLEY LG-IBM SUNREX US-ENG LM REFRESH 14"	For refresh model

Ch6. Part lists

Location	LG P/N	SPECIFICATION	REMARKS
MKC08	3823B70004C	MCKINLEY LG-IBM SUNREX-K021102A RUSSIAN 14.1" 84 KEY	
MKC08	3823B71004C	MCKINLEY LG-IBM SUNREX RUSSIAN LM REFRESH 14"	For refresh model
MKC08	3823B70004D	MCKINLEY LG-IBM SUNREX K021167 ARABIAN 14.1" 84 KEY	
MKC08	3823B71004D	MCKINLEY LG-IBM SUNREX ARAB LM EFRESH 14"	For refresh model
MKC08	3823B70004E	MCKINLEY LG-IBM SUNREX K021167 HEBREW 14.1" 84 KEY	
MKC08	3823B71004E	MCKINLEY LG-IBM SUNREX HEBREW LM REFRESH 14"	For refresh model
MKC08	3823B70004F	MCKINLEY LG-IBM SUNREX K021167 FARSI(IRAN) 14.1" 84 KEY	
MKC08	3823B71004F	MCKINLEY LG-IBM SUNREX FARSI LM REFRESH 14"	For refresh model
MKC08	3823B70004H	MCKINLEY LG-IBM SUNREX K021167 US SOUTH AFRICA 14.1" 84 KEY	
MKC08	3823B71004H	MCKINLEY LG-IBM SUNREX US SOUTH AFRICA LM REFRESH 14"	For refresh model
MKC08	3823B70004G	MCKINLEY LG-IBM SUNREX K021167 UKRAINIAN 14.1" 84 KEY	
MKC08	3823B71004G	MCKINLEY N SUNREX UKRAINIAN LM REFRESH 14"	For refresh model
MKC08	3823B70004K	MCKINLEY LG-IBM SUNREX K021167 SPANISH 14.1" 84KEY	
MKC08	3823B70004J	MCKINLEY LG-IBM SUNREX K021167 PORTUGUESE 14.1" 84 KEY	
MKC08	3823B70004L	MCKINLEY LG-IBM SUNREX K021167 POLISH 14.1" 84KEY	
MKC08	3823B71004L	MCKINLEY LG-IBM SUNREX POLISH LM REFRESH 14"	For refresh model
MKC08	3823B70004M	MCKINLEY N SUNREX K021167 FRENCH 14.1" 84KEY	
MKC08	3823B71004M	MCKINLEY LG-IBM SUNREX FRENCH REFRESH LM 14"	For refresh model
MKC08	3823B70004N	MCKINLEY N SUNREX THAILAND 14" 84KEY	
MKC08	3823B71004N	MCKINLEY N SUNREX THAILAND LM REFRESH 14"	For refresh model
MKC08	3823B70004P	MCKINLEY LG-IBM SUNREX TAIWAN 14.1" 84KEY	
MKC08	3823B71004P	MCKINLEY N SUNREX TAIWAN LM REFRESH 14"	For refresh model
MKC08	3823B71004Q	MCKINLEY N SUNREX HUNGARY REFRESH LM 14"	For refresh model

Ch6. Part lists

Location	LG P/N	SPECIFICATION	REMARKS
MKC08	3823B71004R	MCKINLEY N SUNREX CZECH LM REFRESH 14"	For refresh model
MKC08	3823B71004S	MCKINLEY N SUNREX TURKEY REFRESH LM 14"	For refresh model
MKC08	3823B70008A	MCKINLEY LG-IBM OKI US-ENG 15" 86 KEY	
MKC08	3823B71008A	MCKINLEY LG-IBM OKI US LM REFRESH 15"	For refresh model
MKC08	3823B70008C	MCKINLEY LG-IBM OKI RUSSIAN 15" 86 KEY	
MKC08	3823B71008C	MCKINLEY LG-IBM OKI RUSSIAN LM REFRESH 15"	For refresh model
MKC08	3823B70008D	MCKINLEY LG-IBM OKI ARABIAN 15" 86 KEY	
MKC08	3823B71008D	MCKINLEY LG-IBM OKI ARAB LM REFRESH 15"	For refresh model
MKC08	3823B70008E	MCKINLEY LG-IBM SUNREX-K020346A HEBREW 15" 86 KEY	
MKC08	3823B71008E	MCKINLEY LG-IBM OKI HEBREW LM REFRESH 15"	For refresh model
MKC08	3823B70008F	MCKINLEY LG-IBM OKI FARSI 15" 86 KEY	
MKC08	3823B71008F	MCKINLEY LG-IBM OKI FARSI LM REFRESH 15"	For refresh model
MKC08	3823B70008H	MCKINLEY LG-IBM OKI US SOUTH AFRICA 15" 86KEY	
MKC08	3823B71008H	MCKINLEY LG-IBM OKI US SOUTH AFRICA LM REFRESH 15"	For refresh model
MKC08	3823B70008G	MCKINLEY LG-IBM OKI UKRAINAIN 15" 86 KEY	
MKC08	3823B71008G	MCKINLEY N OKI UKRAINAIN LM REFRESH 15"	For refresh model
MKC08	3823B70008K	MCKINLEY LG-IBM OKI SPANISH 15" 86KEY	
MKC08	3823B70008J	MCKINLEY LG-IBM OKI PORTUGUESE 15" 86KEY	
MKC08	3823B70008L	MCKINLEY LG-IBM OKI POLISH 15" 87KEY	
MKC08	3823B71008L	MCKINLEY LG-IBM OKI POLISH LM REFRESH 15"	For refresh model
MKC08	3823B70008M	MCKINLEY N OKI FRENCH 15" 87KEY	
MKC08	3823B71008M	MCKINLEY LG-IBM OKI FRENCH REFRESH LM 15"	For refresh model
MKC08	3823B70008N	MCKINLEY LG-IBM SUNREX THAILAND 15" LM 84KEY	

Ch6. Part lists

Location	LG P/N	SPECIFICATION	REMARKS
MKC08	3823B71008N	MCKINLEY N OKI THAILAND LM REFRESH 15"	For refresh model
MKC08	3823B70008P	MCKINLEY LG-IBM OKI TAIWAN 15" LM 86KEY	
MKC08	3823B71008P	MCKINLEY N OKI TAIWAN LM REFRESH 15"	For refresh model
MKC08	3823B71008Q	MCKINLEY N OKI HUNGARY LM REFRESH 15"	For refresh model
MKC08	3823B71008R	MCKINLEY N OKI CZECH LM REFRESH 15"	For refresh model
MKC08	3823B71008S	MCKINLEY N OKI TURKEY LM REFRESH 15"	For refresh model
MKC10	0IMCRIN103B	PROCESSOR, INTEL RH80535GC0131M 478P UFCPGA PENTIUM-M 1300MHZ/600MHZ B1-STEPPING(SL6N4)	
MKC10	0IMCRIN104B	PROCESSOR, INTEL RH80535GC0171M 478P UFCPGA PENTIUM-M 1400MHZ/600MHZ B1-STEPPING(SL6F8)	
MKC10	0IMCRIN105B	PROCESSOR, INTEL RH80535GC0211M 478P UFCPGA PENTIUM-M 1500MHZ/600MHZ B1-STEPPING(SL6F9)	
MKC10	0IMCRIN106B	PROCESSOR, INTEL RH80535GC0251M 478P UFCPGA PENTIUM-M 1600MHZ/600MHZ B1-STEPPING(SL6FA)	
MKC10	0IMCRIN119A	PROCESSOR, INTEL RH80535GC0291M 478P UFCPGA PENTIUM-M 1700MHZ/600MHZ B1-STEPPING(SL6N5)	
MKC10	0IMCRIN150A	RH80535NC009512 LG INTEL 478P UFCPGA TRAY NT CPU CELERON-M 1200MHZ/400MHZ B1-STEPPING(SL79S)	
MKC10	0IMCRIN132A	RH80535NC013512 LG INTEL 478P UFCPGA TRAY NT CPU CELERON-M 1300MHZ/400MHZ B1-STEPPING(SL6N7)	
MKC10	0IMCRIN133A	RH80535NC017512 LG INTEL 478P UFCPGA TRAY NT CPU CELERON-M 1400MHZ/400MHZ B1-STEPPING(SL6N6)	
MKC11	6708BA0036B	ADAPTER, LITEON PA-1650-02L1 65W 18.5V/3.5A 3PIN	
MKC11	6708BA0044B	ADAPTER, HIPRO HP-OK065B133 65W 16V/3.5A 3PIN	
MKC12	6910C00007A	RTC BATTERY, MINAMOTO CR2032 3.0 VOLT 210MAH	
MKC12	6910C00005A	RTC BATTERY, SONY CR2032 3.0 VOLT 200MA	
MKC13	6410BD21003	PF8B1CIJ10A-060 LONGWELL CEU 1830MM 3P CONN. BLACK	Germany,Iran, Portugal,Spain
MKC13	6410BK21005	PL8B1S3J10A-060 LONGWELL SAA 1830MM 3PIN CONN BLACK	Australia
MKC13	6410BK20704	213356-001(SP502A+IS34) I-SHENG SAA 1850MM 3P CONN. BLACK	Australia
MKC13	6410BK21004	213356-001 LINE TEK SAA 1830MM 3PIN CONN. BLACK	Australia

Ch6. Part lists

Location	LG P/N	SPECIFICATION	REMARKS
MKC13	6410BK21002	213356-001 VOLEX SAA 1830MM 3PIN CONN. BLACK	Australia
MKC13	6410BK20705	PL8B1SQJ10A-060 LONGWELL SAA 1830MM 3PIN CONN BLACK	Australia
MKC13	6410BK21007	SP-502B+H05VV-F+IS-034 I-SHENG SAA 1830MM 3PIN CONN. BLACK	Australia
MKC13	6410BK21006	AU10S3+H03VV-F+VAC5S VOLEX SAA 1830MM 3PIN CONN BLACK	Australia
MKC13	6410BX21601	SP-022+IS-034+H05VV-F3G I-SHENG GOST 1800MM 3P CONN. BLACK	Russia
MKC13	6410BX21602	PF8B1CIJ10A-060 LONGWELL GOST 1830MM 3PIN CONN. BLACK	Russia
MKC13	6410BD21602	PF8B1CIJ10A-060 LONGWELL CEU 1830MM 3P CONN. BLACK	Spain
MKC13	6410BD20308	213350-001 LINE TEK VDE/SEMKO 1830MM 3PIN CONN. BLACK	Spain
MKC13	6410BD20306	213350-001 VOLEX VDE/SEMKO 1830MM 3P CONN. BLACK	Spain
MKC13	6410BW21001	X-LGPC0415-001 VOLEX ISI 1830MM 3PIN CONN. BLACK	India
MKC13	6410BQ21002	BR10S3+H03VV-F+VAC5S VOLEX INMETRO 1830MM 3PIN CONN BLACK	Brazil
MKC13	6410BQ21003	SP-305+H05VV-F+IS-034 I-SHENG INMETRO 1830MM 3PIN CONN BLACK	Brazil
MKC13	6410BO20603	P48F1SAJ30A-060 LONGWELL CCC 1830MM 3P CONN BLACK	China
MKC13	6410BO20602	SP-506+RVV 3CX0.75MM2+IS-034 I-SHENG CCC 1830MM 3P CONN BLACK	China
MKC13	6410BO21008	GB10S3+RW300_300+VAC5S VOLEX CCC 1830MM 3PIN CONN BLACK	China
MKC13	6410BH21003	SP-60+IS-034 I-SHENG BSI 1830MM 3PIN CONN FOR NT-PC BLACK	UAE,Saudi Arabia
MKC13	6410BV21002	PF8B1L1J10A-060 LONGWELL SII 1830MM 3PIN CONN. BLACK	Israel
MKC13	6410BV21003	SP-86+IS-034 I-SHENG SII 1830MM 3PIN CONN. BLACK	Israel
MKC13	6410BU21602	SP-80A+H05VV-F+IS-034 I-SHENG SABS 1830MM 3PIN CONN BLACK	South Africa
MKH02	3301B00525A	HDD PLATE ASSY	
MKH03	3110BM3021A	HDD CASE 2 TONE 14.1"	
MKH03	3110BM2033A	HDD CASE 2 TONE 15.0"	
MKH04	6744C00085A	HDD, FUJITSU MHT2040AT 40GB EIDE	
MKH04	6744C00068A	HDD, TOSHIBA MK4021GAS40GB EIDE	
MKH04	6744C00105A	HDD, HGST IC25N040ATMR04-0 40GB EIDE	
MKH04	6744C00086A	HDD, FUJITSU MHT2060AT 60GB EIDE	
MKH04	6744C00069A	HDD, TOSHIBA MK6021GAS 60GB EIDE	
MKH04	6744C00106A	HDD, HGST IC25N060ATMR04-0 60GB EIDE	
MKH04	6744C00087A	HDD, FUJITSU MHT2080AT 80GB EIDE	
MKH04	6744C00090A	HDD, TOSHIBA MK8025GAS 80GB EIDE	
MKH04	6744C00107A	HDD, HGST IC25N080ATMR04-0 80GB EIDE	
MKS01	6871BG824AA	MCKINLEY LGE 4 LAYERS REV 0.4 PCMCIA WSD 15.0" SUB B/D ASSY	

Ch6. Part lists

Location	LG P/N	SPECIFICATION	REMARKS
MKS01	6871BG854AA	MCKINLEY N . . LGE 4 LAYERS REV 0.2 MCKINLEY REFRESH 15.0" PCMCIA 7420 SUB B/D MAIN ASSY	For refresh model
MKS02	6871BG821AA	MCKINLEY LGE 4 LAYERS REV 0.4 PCMCIA WSD 14.1" SUB B/D ASSY	
MKS02	6871BG851AA	MCKINLEY N . . LGE 4 LAYERS REV 0.2 MCKINLEY REFRESH 14.1" PCMCIA 7420 SUB B/D MAIN ASSY	For refresh model
MKS03	6871BJ320AB	MCKINLEY WIMTEC 2 LAYERS REV 0.4 SVIDEO, USB 15.0" SUB ASSY	
MKS04	6871BJ320AA	MCKINLEY WIMTEC 2 LAYERS REV 0.4 SVIDEO, USB SUB 14.1" B/D ASSY	
MKS05	6871BJ350AA	MCKINLEY WIMTEC 2 LAYERS REV 0.3 ODD I/F SUB B/D ASSY	
MKS06	6871BJ300AA	MCKINLEY WIMTEC 2 LAYERS REV 0.3 NETWORK, PWR SUB B/D ASSY	
MKS06	6871BJ300AB	MCKINLEY LG-IBM N N WIMTEC 2 LAYERS REV 0.4 NETWORK, PWR SUB B/D ASSY	For refresh model
MKD01	3111BZ8801A	KBD DECK ASSY 15.0"	
MKD01	3111BZ8801B	N N KBD DECK ASSY 15" MCKINLEY KBD DECK W/ UV COATED KNOB	For refresh model
MKD01	3111BZ8800A	KBD DECK ASSY 14.1"	
MKD01	3111BZ8801D	MCKINLEY N N MCKINLEY KBD DECK TOTAL ASSY 15.0" FOR MC REFRESH	For refresh model
MKD01	3111BZ8800C	MCKINLEY N N MCKINLEY KBD DECK TOTAL ASSY 14.1" FOR MC REFRESH	For refresh model
MKD03	6401B10002A	SPEAKER ASSY, ESTEC A252SX-012K14 0.8W 4PIN 166.5X27MM 8OHM 75DB	
MKD04	6871BJ340AA	MCKINLEY WIMTEC 2 LAYERS REV 0.3 TOUCHPAD (15.0") SUB B/D ASSY	
MKD04	6871BJ330AA	MCKINLEY WIMTEC 2 LAYERS REV 0.3 TOUCHPAD (14.1") SUB B/D ASSY	
MKM01	3111BZ9901A	MCKINLEY BOTTOM CASE ASSY 15.0"	
MKM01	3111BZ9901C	MCKINLEY N N MCKINLEY BOTTOM FOR MC REFRESH 15.0"	For refresh model
MKM02	3111BZ9900A	MCKINLEY BOTTOM CASE ASSY 14.1"	
MKM02	3111BZ9900B	GIRAFFE BOTTOM ASSY 14.1" ONLY PCMCIA W/ PAINT, SUB PARTS	
MKM02	3111BZ9900C	MCKINLEY N N MCKINLEY BOTTOM FOR MC REFRESH 14.1"	For refresh model
MKM03	3210BD2014A	FRAME, HINGE & BATTERY 14.1"	
MKM04	3210BD1005A	FRAME, HINGE & BATTERY 15.0"	
MKM05	3581BZ0030A	COVER, ASSY DDR MEMORY	
MKM06	3551B03007B	RETAINER ASSY 15.0" WITH SUB B/D	
MKM07	3551BZ3004B	RETAINER ASSY 14.1" WITH SUB B/D	

Ch6. Part lists

Location	LG P/N	SPECIFICATION	REMARKS
MKM08	3550BM3173B	COVER, CLUTCH LEFT	
MKM09	3550BM3172A	COVER, CLUTCH RIGHT	
MKM10	3550BM3171A	DUMMY, PCMCIA	
MKM11	3550BM4047A	DUMMY, SD	
MKM12	3301BZ9092D	PLATE, CHIPSET COVER ASSY 15.0" M9	
MKM12	3301BZ9092A	PLATE, CHIPSET COVER ASSY 14.1" M9	
MKM12	3301BZ9092B	PLATE, CHIPSET COVER ASSY 15.0" M10	
MKM12	3301BZ9092C	PLATE, CHIPSET COVER ASSY 14.1" M10	
MKM16	5022BZ4025A	THERMAL PAD 19X19 MM ON FAN	
MKM17	5022BP4010A	THERMAL PAD 15X25 MM ON ATI	
MKM18	5022BP4010B	THERMAL PAD 11X11 MM ON NORTHBRIDGE	
MKM19	1SZZBA4017B	SCREW, D2.0 M2.0 L 3.5 MM TORQUE 2.0±0.2	
MKM21	1SZZBA4068A	SCREW, D4.5 M2.5 L5.0 MM TORQUE 2.0±0.2	
MKM22	1SZZBA4044B	SCREW, D4.5 M2.5 L4.0 MM TORQUE 2.0±0.2	
MKM23	1SZZBZ3009B	SCREW, D3.8 M2.0 L 2.5 MM TORQUE 2.0±0.2	
MKM27	1SZZBA4011F	SCREW, D5.5 M3.0 L3.5 MM TORQUE 2.0±0.2	
MKM28	1SZZBA4067A	SCREW, D4.0 M2.0 L13.0 MM TORQUE 2.0±0.2	
MKM29	1SZZBZ4020A	SCREW, D4.0 M2.0 L8.8 MM TORQUE 1.5±0.2	
MKM30	1SZZBA4039B	SCREW, D4.5 M2.5 L8.0 MM TORQUE 3.0±0.2	
MKM31	1SZZBZ4018B	SCREW, D3.8 M2.0 L2.0 MM TORQUE 1.5±0.2	
MKM32	1SZZBZ4014A	SCREW, D4.3 M2.0 L5.0 MM TORQUE 2.0±0.2	
MKM33	1SZZBA4083A	SCREW, D3.8 M2.0 L8.0 MM TORQUE 2.0±0.2	
MKM34	1SZZBA4085A	SCREW, D5.5 M3.0 L6.0 MM TORQUE 2.0±0.2	
MKM39	1SZZBA4017A	SCREW, D2.0 L3.0 MM TORQUE 2.0±0.2	
MKM38	4986BZ4117A	GASKET ON MINI-PCI ANTENNA CONNECTOR	

Case : LCD 14.1"

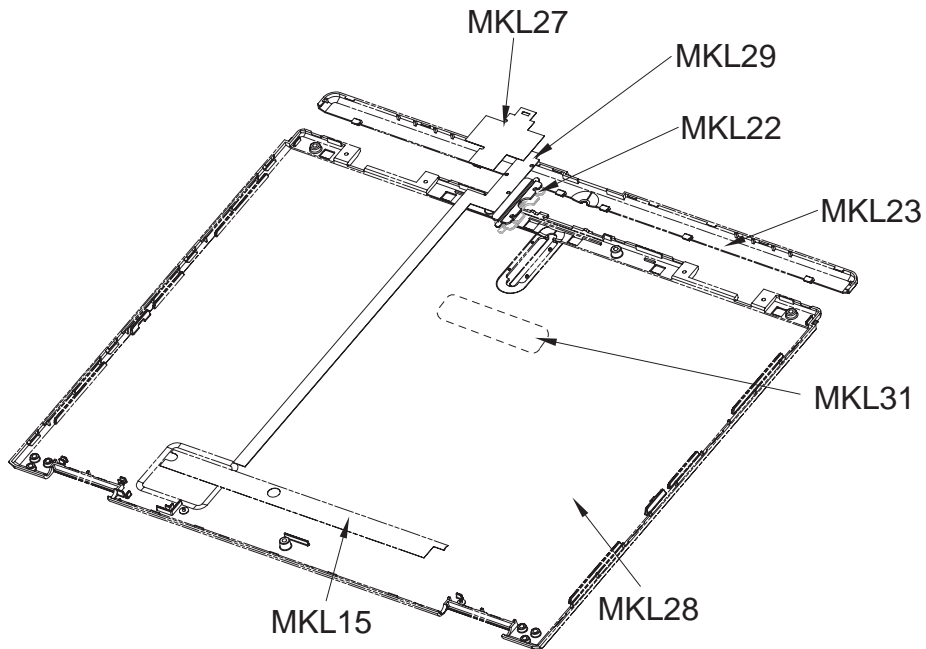

Case : LCD 14.1"

Location	LG P/N	SPECIFICATION	REMARKS
MKL15	3858BZ3019A	INSULATOR, INVERTER 14.1"/15.0"	
MKL22	3680BM3036A	LENS, WIRELESS REAR 14.1"	
MKL23	3550BM1149B	DECORATION COVER, 14.1" FOR EXPORT	
MKL27	3858BZ3020A	INSULATOR, LED 14.1"	
MKL28	3110BD0008B	REAR CASE, 14.1" FOR EXPORT	
MKL28	3110BD0008D	MCKINLEY MG DISPLAY REAR 14.1" FOR MC REFRESH	For refresh model
MKL29	6871BZT16ZA	CABLE FPC, WIRELESS INDICATOR 14.1"	
MKL31	3858BZ4450B	MCKINLEY N N N MCKINLEY BADGE FOR EXPORT LG	For refresh model

Case : LCD 15.0"

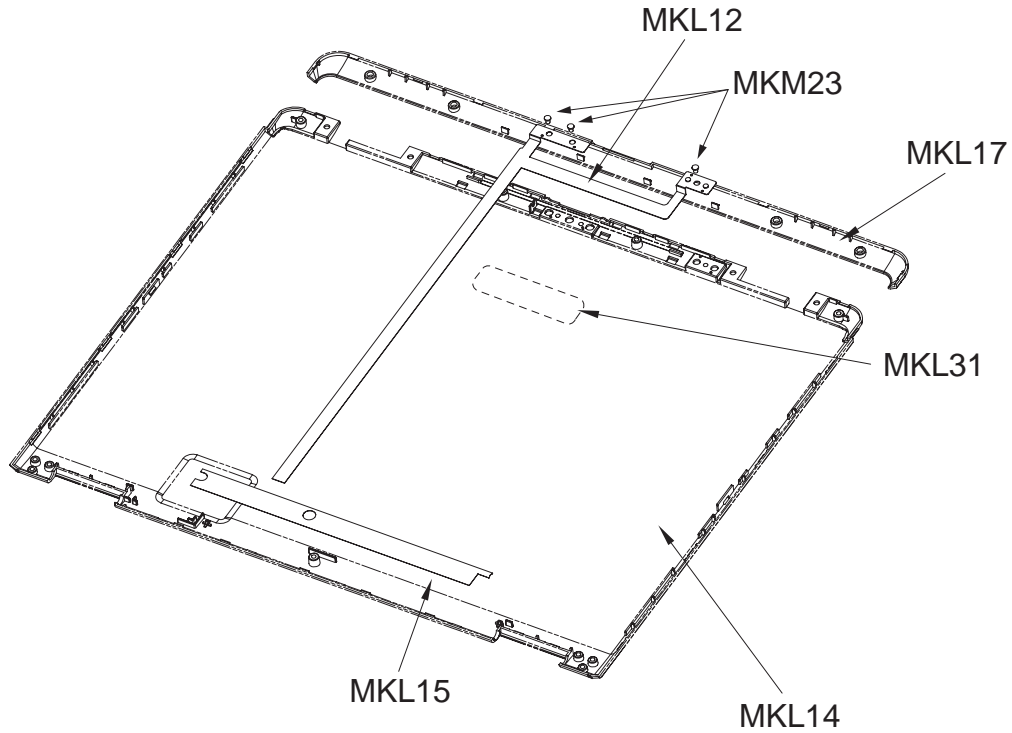

Case : LCD 15.0"

Location	LG P/N	SPECIFICATION	REMARKS
MKL12	6871BZT17AA	CABLE FPC, WIRELESS INDICATOR 15.1"	
MKL14	3110BD0009B	REAR CASE, 15.0" FOR EXPORT	
MKL14	3110BD0009D	MCKINLEY MG DISPLAY REAR 15.0" FOR MC REFRESH	For refresh model
MKL15	3858BZ3019A	INSULATOR, INVERTER 14.1"/15.0"	
MKL17	3550BM2093B	DECORATION COVER, 15.0" FOR EXPORT	
MKL23	3550BM1149B	DECORATION COVER, 14.1" FOR EXPORT	
MKL31	3858BZ4450B	MCKINLEY N N N MCKINLEY BADGE FOR EXPORT LG	For refresh model

See Detail "a" Drawing

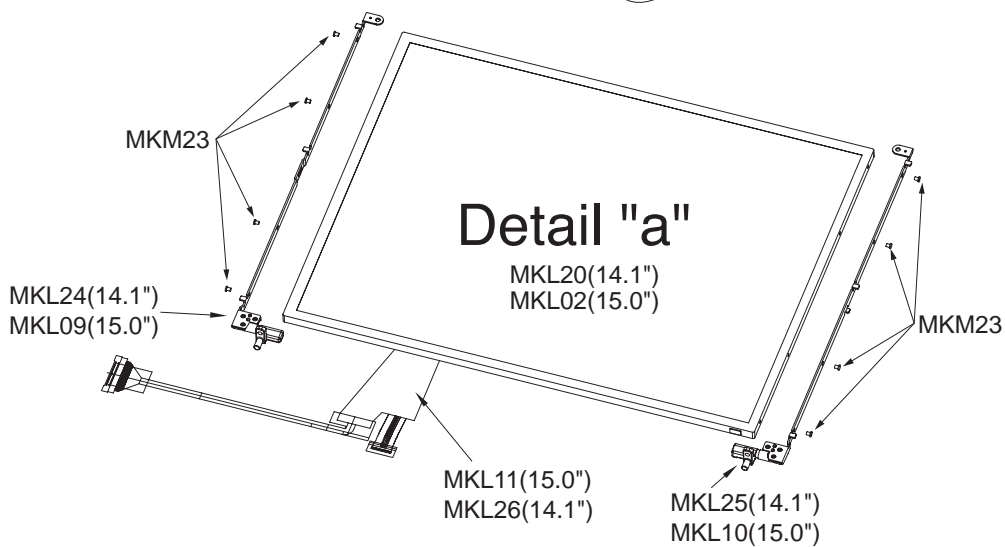
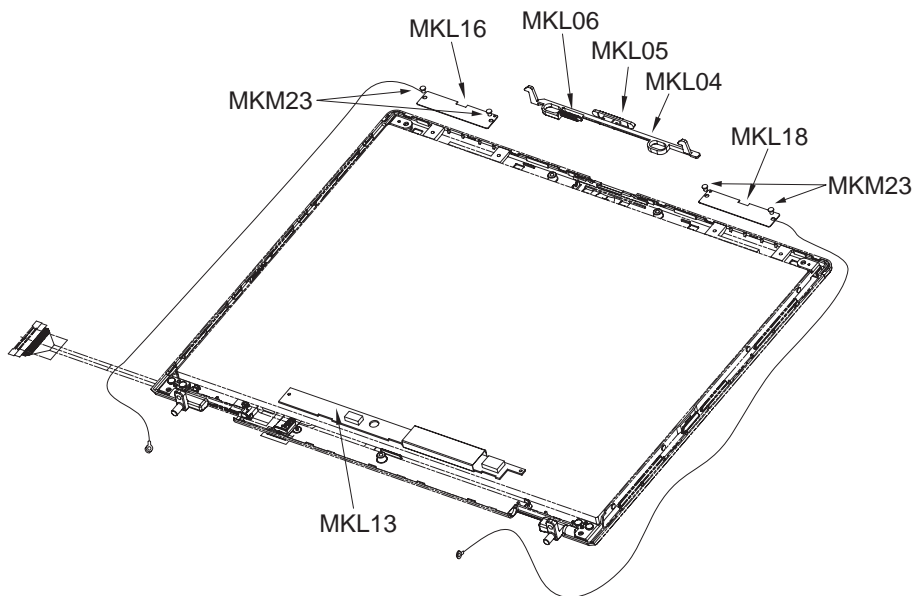
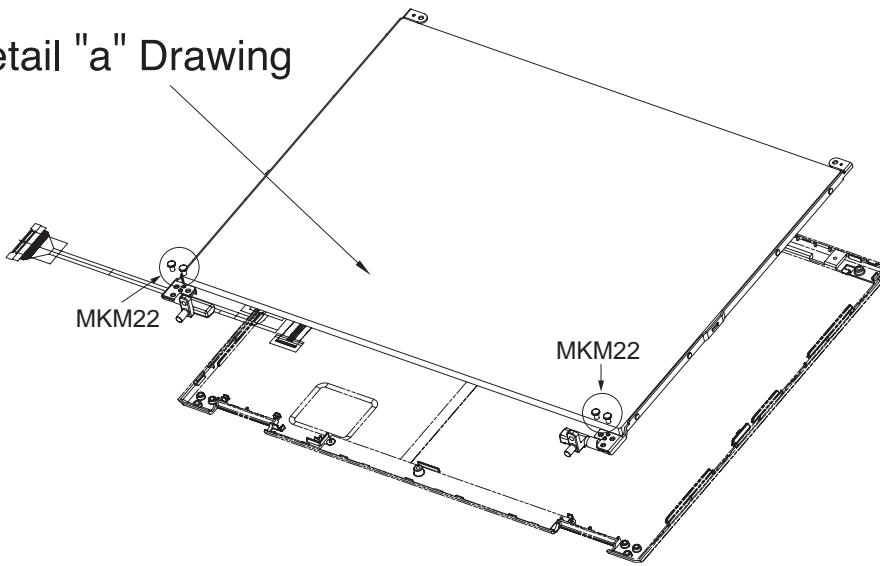

EXPLODED VIEW

Location	LG P/N	SPECIFICATION	REMARKS
MKL02	6304FLP081A	TFT LCD, LG PHILIPS LP150E06-A2 15.0 INCH SXGA+	
MKL02	6304FLP080A	TFT LCD, LG PHILIPS LP150X08-A3M1 15.0 INCH XGA	
MKL02	6304FAU002B	TFT LCD, AU B150XG01 15.0 INCH XGA	
MKL02	6304FBH005A	TFT LCD, BOE-HYDIS HT15X34-100 15.0 INCH XGA	
MKL04	4940BM4146A	KNOB, LATCH	
MKL05	4026BM3013A	LATCH, DISPLAY	
MKL06	4970BW4540A	SPRING, LCD LATCH	
MKL09	4775B00033A	HINGE ASSY, LEFT 15.0"	
MKL10	4775B00034A	HINGE ASSY, RIGHT 15.0"	
MKL11	6851B76028A	CABLE ASSY, LCD 15.0"	
MKL13	6708BI0082A	INVERTER, ALPS KUBNKM063A	
MKL13	6708BI0083A	INVERTER, DELTA DAC-08B043A	
MKL16	3301BZ0512B	ANTENNA, WIRELESS RIGHT	
MKL18	3301BZ0513B	ANTENNA, WIRELESS LEFT	
MKL20	6304FBH004A	TFT LCD, BOE HYDIS HT14X1B-110 14.1 INCH XGA	
MKL20	6304FLP079A	TFT LCD, LG PHILIPS LP141X13-C2 14.1 INCH XGA	
MKL20	6304FLP079B	LP141X13-C2K1 LG PHILIPS TFT COLOR 14.1 INCH XGA(1024X768) ISP STYLE B	
MKL24	4775BZ1004A	HINGE ASSY, LEFT 14.1"	
MKL25	4775BZ1005A	HINGE ASSY, RIGHT 14.1"	
MKL26	6851B76024A	CABLE ASSY, LCD 14.1"	
MKM22	1SZZBA4044B	SCREW, D4.5 M2.5 L4.0 MM TORQUE 2.0 ±0.2	
MKM23	1SZZBZ3009B	SCREW, D3.8 M2.0 L 2.5 MM TORQUE 2.0 ±0.2	

EXPLODED VIEW

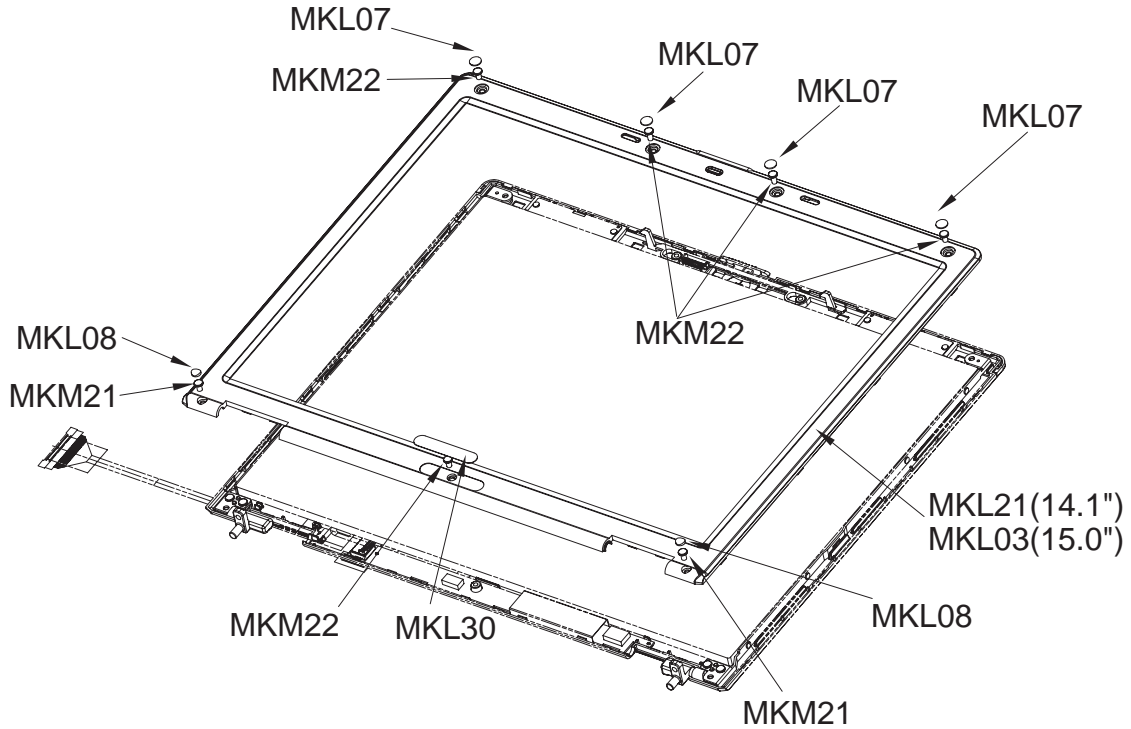

Location	LG P/N	SPECIFICATION	REMARKS
MKL03	3111BZ7101A	CASE ASSY, FRONT 15.0	
MKL07	4850BM4010A	CUSHION, RUBBER UPPER	
MKL08	4850BM4011A	CUSHION, RUBBER LOWER	
MKL21	3111BZ7100A	CASE ASSY, FRONT 14.1"	
MKL30	3850BB3035D	MODEL NAME LABEL, MCKINLEY 14.1" FOR EXPORT	
MKL30	3850BB3035E	MODEL NAME LABEL, MCKINLEY 15.0" FOR EXPORT	
MKL30	3850BB3035P	MCKINLEY N N MODEL NAME LABEL 14.1" MCKINLEY LM40A FOR REFRESH EXPORT	For refresh model
MKL30	3850BB3035Q	MCKINLEY N N MODEL NAME LABEL 15" MCKINLEY LM50A FOR REFRESH EXPORT	For refresh model
MKM21	1SZZBA4068A	SCREW, D4.5 M2.5 L5.0 MM TORQUE 2.0 ± 0.2	
MKM22	1SZZBA4044B	SCREW, D4.5 M2.5 L4.0 MM TORQUE 2.0 ± 0.2	

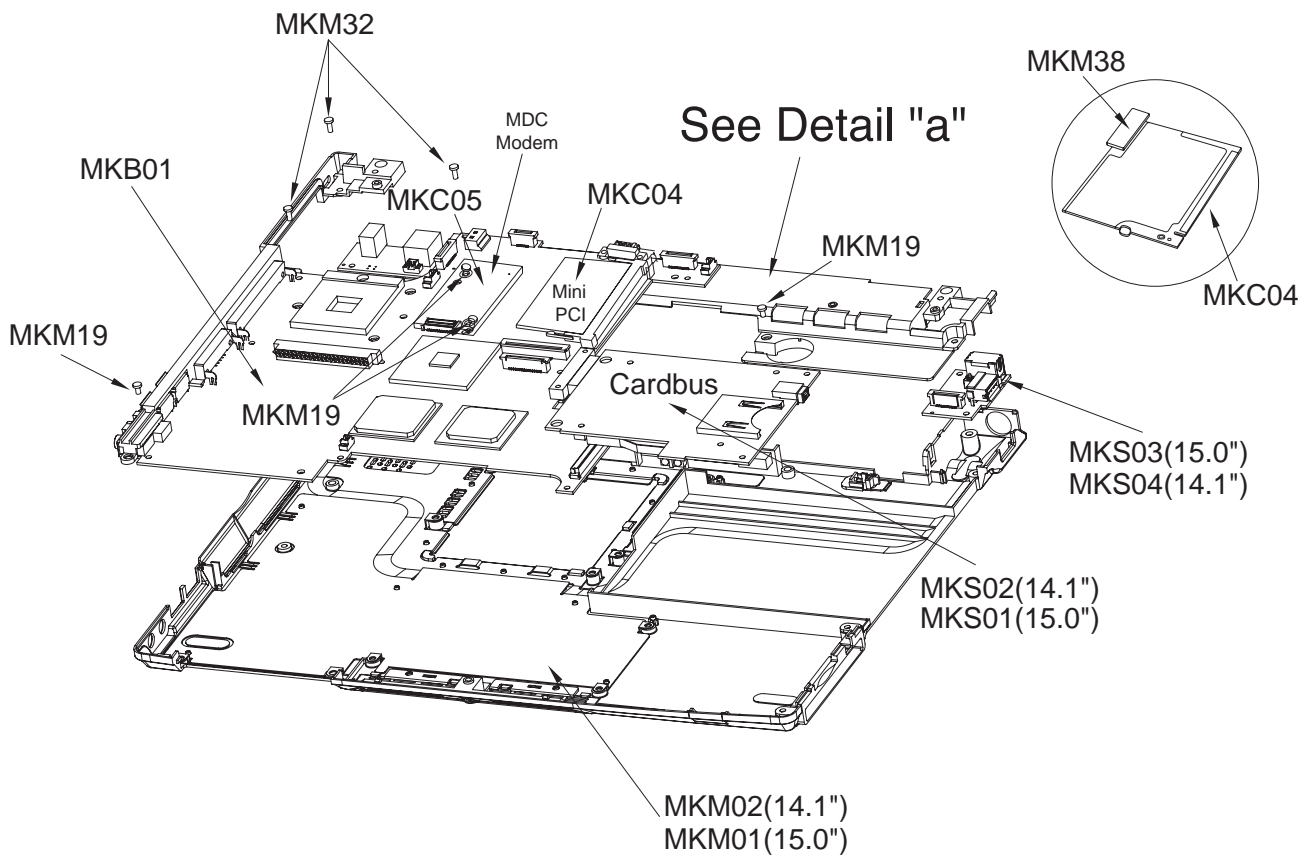

Detail "a"

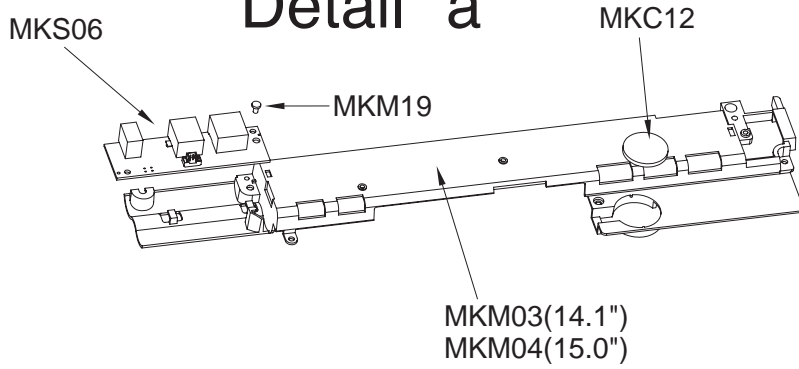

EXPLODED VIEW

Location	LG P/N	SPECIFICATION	REMARKS
MKB01	6871BF100A1	MAINBOARD ASSY, BH M9+ P.P LGE 8 LAYERS REV 0.5	
MKB01	6871BF200A1	MAINBOARD ASSY, BH M10 P.P LGE 8 LAYERS REV 0.5	
MKB01	6871BF300A1	MCKINLEY US007506 REFRESH MODEL . LGE 8 LAYERS REV 0.7 M11 MAINSTEAM MAIN ASSY	For refresh model
MKC04	6871BZT13A4	WIRELESS LAN, INTEL WM3B2100WW MINI-PCI TYPE IIIB	
MKC04	6871BZT14A4	MCKINLEY N WM3B2200BGRW PRO/WIRELESS2200BG LAN MINI-PCI TYPE INTEL 4 LAYERS 1-14 NETWORK CONNECTION	For refresh model
MKC04	6871BZT13A5	WM3B2100NA1 MINI-PCI TYPE IIIB INTEL 4 LAYERS 1-11 PRO/WIRELESS2100 LAN MINI-PCI TYPE 3B ADAPTER LIO	USA,Canada, Taiwan
MKC05	6871BG105AA	MDC MODEM, AMBIT T60M283.13 56K	
MKC12	6910C00007A	RTC BATTERY, MINAMOTO CR2032 3.0 VOLT 210MAH	
MKC12	6910C00005A	RTC BATTERY, SONY CR2032 3.0 VOLT 200MA	
MKM01	3111BZ9901A	MCKINLEY BOTTOM CASE ASSY 15.0"	
MKM01	3111BZ9901C	MCKINLEY N N MCKINLEY BOTTOM FOR MC REFRESH 15.0"	For refresh model
MKM02	3111BZ9900A	MCKINLEY BOTTOM CASE ASSY 14.1"	
MKM02	3111BZ9900B	GIRAFFE BOTTOM ASSY 14.1" ONLY PCMCIA W/ PAINT, SUB PARTS	
MKM02	3111BZ9900C	MCKINLEY N N MCKINLEY BOTTOM FOR MC REFRESH 14.1"	For refresh model
MKM03	3210BD2014A	FRAME, HINGE & BATTERY 14.1"	
MKM04	3210BD1005A	FRAME, HINGE & BATTERY 15.0"	
MKM19	1SZZBA4017B	SCREW, D2.0 M2.0 L 3.5 MM TORQUE 2.0 ± 0.2	
MKM32	1SZZBZ4014A	SCREW, D4.3 M2.0 L5.0 MM TORQUE 2.0 ± 0.2	
MKM38	4986BZ4117A	GASKET ON MINI-PCI ANTENNA CONNECTOR	
MKS01	6871BG824AA	MCKINLEY LGE 4 LAYERS REV 0.4 PCMCIA WSD 15.0" SUB B/D ASSY	
MKS01	6871BG854AA	MCKINLEY N . . LGE 4 LAYERS REV 0.2 MCKINLEY REFRESH 15.0" PCMCIA 7420 SUB B/D MAIN ASSY	For refresh model
MKS02	6871BG821AA	MCKINLEY LGE 4 LAYERS REV 0.4 PCMCIA WSD 14.1" SUB B/D ASSY	
MKS02	6871BG851AA	MCKINLEY N . . LGE 4 LAYERS REV 0.2 MCKINLEY REFRESH 14.1" PCMCIA 7420 SUB B/D MAIN ASSY	For refresh model
MKS03	6871BJ320AB	MCKINLEY WIMTEC 2 LAYERS REV 0.4 SVIDEO, USB 15.0" SUB ASSY	
MKS04	6871BJ320AA	MCKINLEY WIMTEC 2 LAYERS REV 0.4 SVIDEO, USB SUB 14.1" B/D ASSY	
MKS06	6871BJ300AA	MCKINLEY WIMTEC 2 LAYERS REV 0.3 NETWORK, PWR SUB B/D ASSY	
MKS06	6871BJ300AB	MCKINLEY LG-IBM N N WIMTEC 2 LAYERS REV 0.4 NETWORK, PWR SUB B/D ASSY	For refresh model

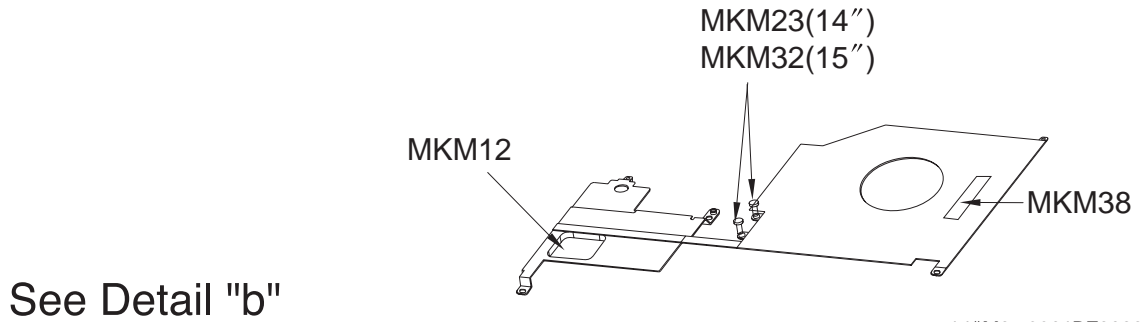

14" M9 : 3301BZ9092A
M10 : 3301BZ9092C
15" M9 : 3301BZ9092D
M10 : 3301BZ9092B

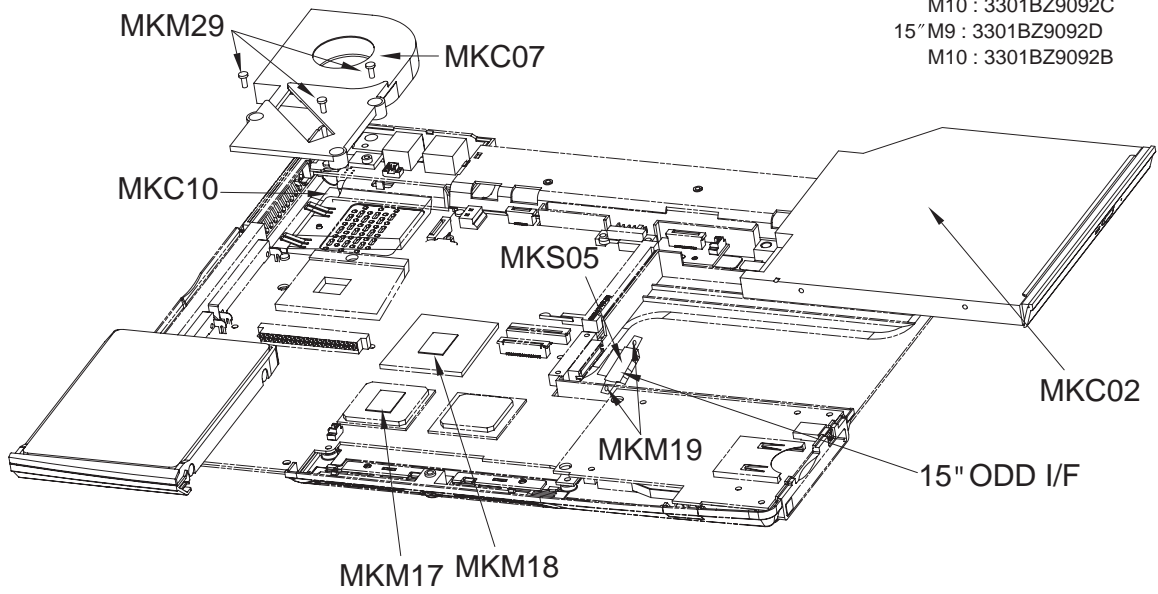

See Detail "C"

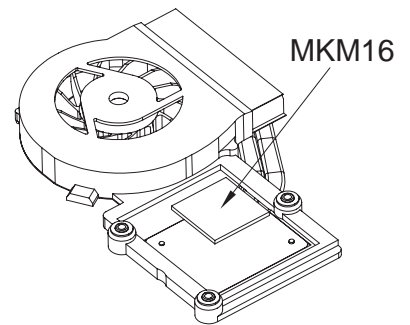
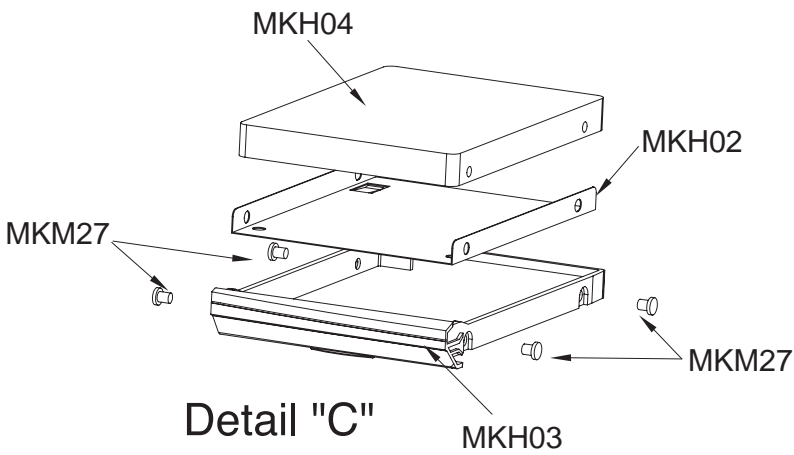

Detail "b"

EXPLODED VIEW

Location	LG P/N	SPECIFICATION	REMARKS
MKC02	2029BG0100A	DVD/CDRW COMBO, TOSHIBA SD-R9012 8X 16X 8X 24X BUILT IN 9.5 MM	
MKC02	6777BG0001A	DVD, TEAC DV-28E-BC-43 8X 24X BUILT IN 9.5 MM	
MKC07	5901B09265A	FAN ASSY, W/ SHEET	
MKC10	01MCRIN103B	PROCESSOR, INTEL RH80535GC0131M 478P UFCPGA PENTIUM-M	
		1300MHZ/600MHZ B1-STEPPING(SL6N4)	
MKC10	01MCRIN104B	PROCESSOR, INTEL RH80535GC0171M 478P UFCPGA PENTIUM-M	
		1400MHZ/600MHZ B1-STEPPING(SL6F8)	
MKC10	01MCRIN105B	PROCESSOR, INTEL RH80535GC0211M 478P UFCPGA PENTIUM-M	
		1500MHZ/600MHZ B1-STEPPING(SL6F9)	
MKC10	01MCRIN106B	PROCESSOR, INTEL RH80535GC0251M 478P UFCPGA PENTIUM-M	
		1600MHZ/600MHZ B1-STEPPING(SL6FA)	
MKC10	01MCRIN119A	PROCESSOR, INTEL RH80535GC0291M 478P UFCPGA PENTIUM-M	
		1700MHZ/600MHZ B1-STEPPING(SL6N5)	
MKC10	01MCRIN150A	RH80535NC009512 LG INTEL 478P UFCPGA TRAY NT CPU CELERON-M	
		1200MHZ/400MHZ B1-STEPPING(SL79S)	
MKC10	01MCRIN132A	RH80535NC013512 LG INTEL 478P UFCPGA TRAY NT CPU CELERON-M	
		1300MHZ/400MHZ B1-STEPPING(SL6N7)	
MKC10	01MCRIN133A	RH80535NC017512 LG INTEL 478P UFCPGA TRAY NT CPU CELERON-M	
		1400MHZ/400MHZ B1-STEPPING(SL6N6)	
MKH02	3301B00525A	HDD PLATE ASSY	
MKH03	3110BM3021A	HDD CASE 2 TONE 14.1"	
MKH03	3110BM2033A	HDD CASE 2 TONE 15.0"	
MKH04	6744C00085A	HDD, FUJITSU MHT2040AT 40GB EIDE	
MKH04	6744C00068A	HDD, TOSHIBA MK4021GAS40GB EIDE	
MKH04	6744C00105A	HDD, HGST IC25N040ATMR04-0 40GB EIDE	
MKH04	6744C00086A	HDD, FUJITSU MHT2060AT 60GB EIDE	
MKH04	6744C00069A	HDD, TOSHIBA MK6021GAS 60GB EIDE	
MKH04	6744C00106A	HDD, HGST IC25N060ATMR04-0 60GB EIDE	
MKH04	6744C00087A	HDD, FUJITSU MHT2080AT 80GB EIDE	
MKH04	6744C00090A	HDD, TOSHIBA MK8025GAS 80GB EIDE	
MKH04	6744C00107A	HDD, HGST IC25N080ATMR04-0 80GB EIDE	

EXPLODED VIEW

Location	LG P/N	SPECIFICATION	REMARKS
MKM12	3301BZ9092D	PLATE, CHIPSET COVER ASSY 15.0" M9	
MKM12	3301BZ9092A	PLATE, CHIPSET COVER ASSY 14.1" M9	
MKM12	3301BZ9092B	PLATE, CHIPSET COVER ASSY 15.0" M10	
MKM12	301BZ9092C	PLATE, CHIPSET COVER ASSY 14.1" M10	
MKM16	5022BZ4025A	THERMAL PAD 19X19 MM ON FAN	
MKM17	5022BP4010A	THERMAL PAD 15X25 MM ON ATI	
MKM18	5022BP4010B	THERMAL PAD 11X11 MM ON NORTHBRIDGE	
MKM19	1SZZBA4017B	SCREW, D2.0 M2.0 L 3.5 MM TORQUE 2.0 ±0.2	
MKM23	1SZZBZ3009B	SCREW, D3.8 M2.0 L 2.5 MM TORQUE 2.0 ±0.2	
MKM27	1SZZBA4011F	SCREW, D5.5 M3.0 L3.5 MM TORQUE 2.0 ±0.2	
MKM29	1SZZBZ4020A	SCREW, D4.0 M2.0 L8.8 MM TORQUE 1.5 ±0.2	
MKM32	1SZZBZ4014A	SCREW, D4.3 M2.0 L5.0 MM TORQUE 2.0 ±0.2	
MKM38	4986BZ4117A	GASKET ON MINI-PCI ANTENNA CONNECTOR	
MKS05	6871BJ350AA	MCKINLEY WIMTEC 2 LAYERS REV 0.3 ODD I/F SUB B/D ASSY	

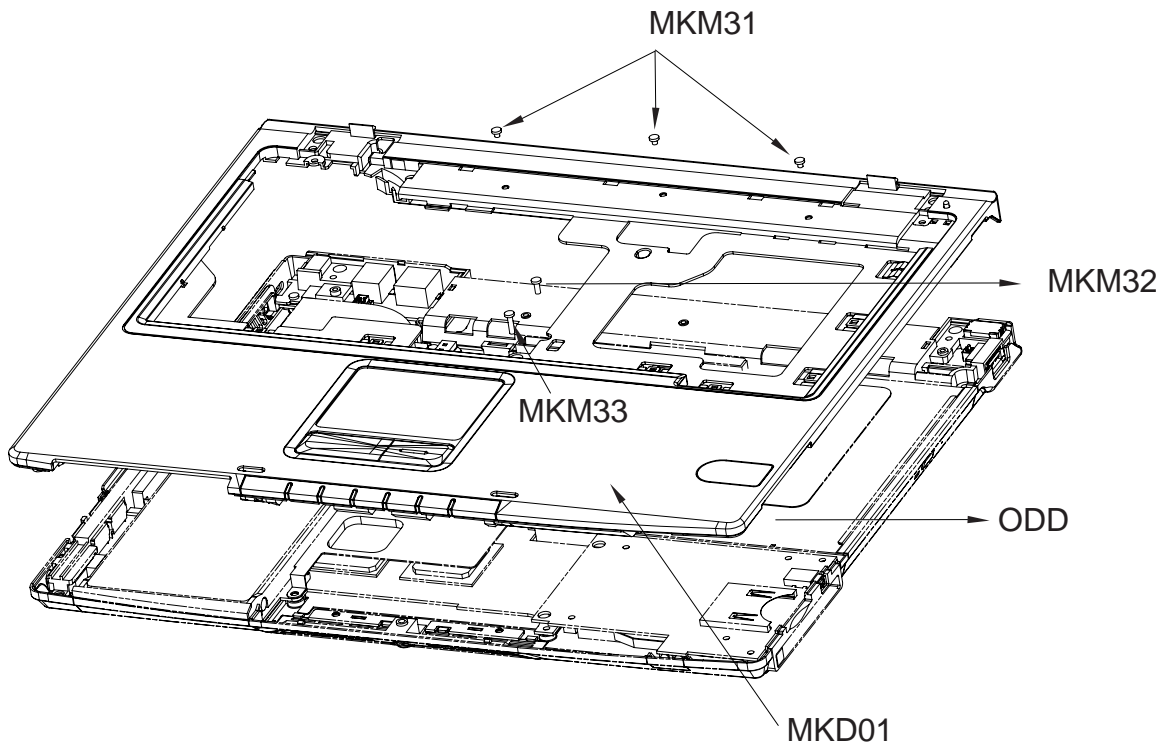

See Detail "d"

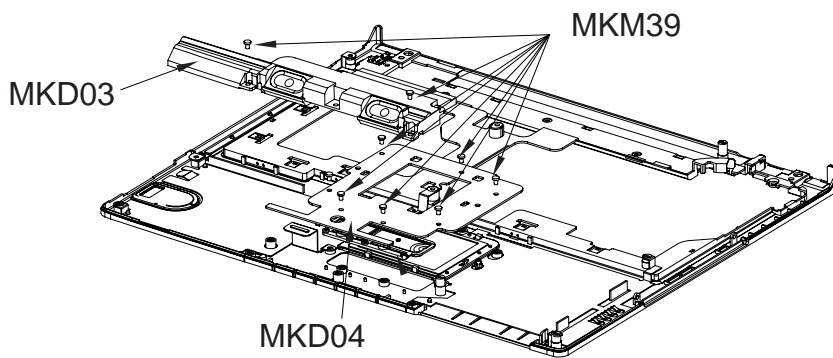

Detail "d"

EXPLODED VIEW

Location	LG P/N	SPECIFICATION	REMARKS
MKD01	3111BZ8801A	KBD DECK ASSY 15.0"	
MKD01	3111BZ8801B	N N KBD DECK ASSY 15" MCKINLEY KBD DECK W/ UV COATED KNOB	For refresh model
MKD01	3111BZ8800A	KBD DECK ASSY 14.1"	
MKD01	3111BZ8801D	MCKINLEY N N MCKINLEY KBD DECK TOTAL ASSY 15.0" FOR MC REFRESH	For refresh model
MKD01	3111BZ8800C	MCKINLEY N N MCKINLEY KBD DECK TOTAL ASSY 14.1" FOR MC REFRESH	For refresh model
MKD03	6401B10002A	SPEAKER ASSY, ESTEC A252SX-012K14 0.8W 4PIN 166.5X27MM 8OHM 75DB	
MKD04	6871BJ340AA	MCKINLEY WIMTEC 2 LAYERS REV 0.3 TOUCHPAD (15.0") SUB B/D ASSY	
MKD04	6871BJ330AA	MCKINLEY WIMTEC 2 LAYERS REV 0.3 TOUCHPAD (14.1") SUB B/D ASSY	
MKM31	1SZZBZ4018B	SCREW, D3.8 M2.0 L2.0 MM TORQUE 1.5 ±0.2	
MKM32	1SZZBZ4014A	SCREW, D4.3 M2.0 L5.0 MM TORQUE 2.0 ±0.2	
MKM33	1SZZBA4083A	SCREW, D3.8 M2.0 L8.0 MM TORQUE 2.0 ±0.2	
MKM39	1SZZBA4017A	SCREW, D2.0 L3.0 MM TORQUE 2.0 ±0.2	

EXPLODED VIEW

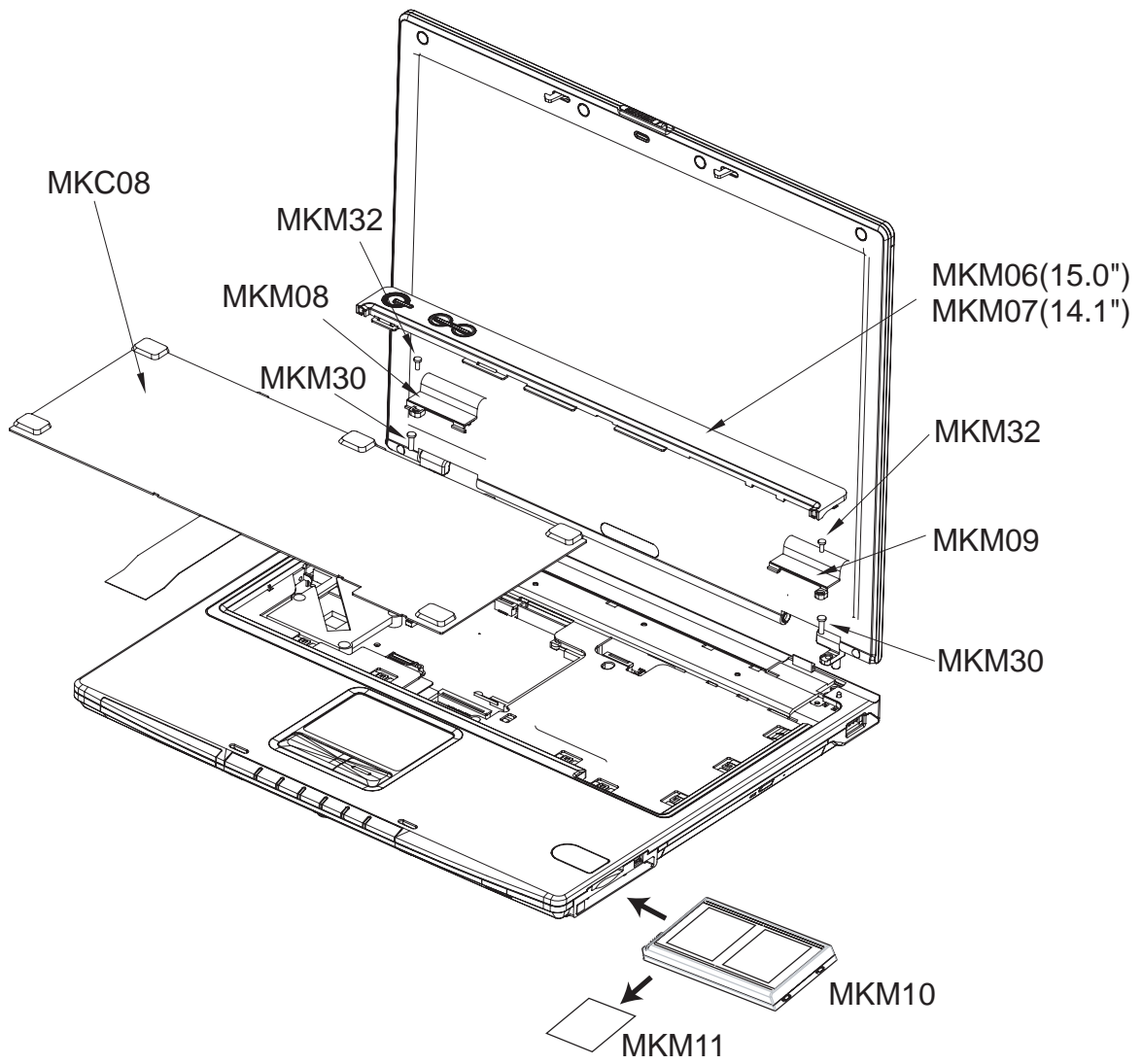

EXPLODED VIEW

Location	LG P/N	SPECIFICATION	REMARKS
MKC08	3823B70004A	MCKINLEY LG-IBM SUNREX-K021102A US-ENG 14.1" 84 KEY	
MKC08	3823B71004A	MCKINLEY LG-IBM SUNREX US-ENG LM REFRESH 14"	For refresh model
MKC08	3823B70004C	MCKINLEY LG-IBM SUNREX-K021102A RUSSIAN 14.1" 84 KEY	
MKC08	3823B71004C	MCKINLEY LG-IBM SUNREX RUSSIAN LM REFRESH 14"	For refresh model
MKC08	3823B70004D	MCKINLEY LG-IBM SUNREX K021167 ARABIAN 14.1" 84 KEY	
MKC08	3823B71004D	MCKINLEY LG-IBM SUNREX ARAB LM EFRESH 14"	For refresh model
MKC08	3823B70004E	MCKINLEY LG-IBM SUNREX K021167 HEBREW 14.1" 84 KEY	
MKC08	3823B71004E	MCKINLEY LG-IBM SUNREX HEBREW LM REFRESH 14"	For refresh model
MKC08	3823B70004F	MCKINLEY LG-IBM SUNREX K021167 FARSI(IRAN) 14.1" 84 KEY	
MKC08	3823B71004F	MCKINLEY LG-IBM SUNREX FARSI LM REFRESH 14"	For refresh model
MKC08	3823B70004H	MCKINLEY LG-IBM SUNREX K021167 US SOUTH AFRICA 14.1" 84 KEY	
MKC08	3823B71004H	MCKINLEY LG-IBM SUNREX US SOUTH AFRICA LM REFRESH 14"	For refresh model
MKC08	3823B70004G	MCKINLEY LG-IBM SUNREX K021167 UKRAINIAN 14.1" 84 KEY	
MKC08	3823B71004G	MCKINLEY N SUNREX UKRAINIAN LM REFRESH 14"	For refresh model
MKC08	3823B70004K	MCKINLEY LG-IBM SUNREX K021167 SPANISH 14.1" 84KEY	
MKC08	3823B70004J	MCKINLEY LG-IBM SUNREX K021167 PORTUGUESE 14.1" 84 KEY	
MKC08	3823B70004L	MCKINLEY LG-IBM SUNREX K021167 POLISH 14.1" 84KEY	
MKC08	3823B71004L	MCKINLEY LG-IBM SUNREX POLISH LM REFRESH 14"	For refresh model
MKC08	3823B70004M	MCKINLEY N SUNREX K021167 FRENCH 14.1" 84KEY	
MKC08	3823B71004M	MCKINLEY LG-IBM SUNREX FRENCH REFRESH LM 14"	For refresh model
MKC08	3823B70004N	MCKINLEY N SUNREX THAILAND 14" 84KEY	
MKC08	3823B71004N	MCKINLEY N SUNREX THAILAND LM REFRESH 14"	For refresh model
MKC08	3823B70004P	MCKINLEY LG-IBM SUNREX TAIWAN 14.1" 84KEY	
MKC08	3823B71004P	MCKINLEY N SUNREX TAIWAN LM REFRESH 14"	For refresh model
MKC08	3823B71004Q	MCKINLEY N SUNREX HUNGARY REFRESH LM 14"	For refresh model
MKC08	3823B71004R	MCKINLEY N SUNREX CZECH LM REFRESH 14"	For refresh model
MKC08	3823B71004S	MCKINLEY N SUNREX TURKEY REFRESH LM 14"	For refresh model
MKC08	3823B70008A	MCKINLEY LG-IBM OKI US-ENG 15" 86 KEY	
MKC08	3823B71008A	MCKINLEY LG-IBM OKI US LM REFRESH 15"	For refresh model
MKC08	3823B70008C	MCKINLEY LG-IBM OKI RUSSIAN 15" 86 KEY	
MKC08	3823B71008C	MCKINLEY LG-IBM OKI RUSSIAN LM REFRESH 15"	For refresh model
MKC08	3823B70008D	MCKINLEY LG-IBM OKI ARABIAN 15" 86 KEY	
MKC08	3823B71008D	MCKINLEY LG-IBM OKI ARAB LM REFRESH 15"	For refresh model
MKC08	3823B70008E	MCKINLEY LG-IBM SUNREX-K020346A HEBREW 15" 86 KEY	
MKC08	3823B71008E	MCKINLEY LG-IBM OKI HEBREW LM REFRESH 15"	For refresh model
MKC08	3823B70008F	MCKINLEY LG-IBM OKI FARSI 15" 86 KEY	

EXPLODED VIEW

Location	LG P/N	SPECIFICATION	REMARKS
MKC08	3823B71008F	MCKINLEY LG-IBM OKI FARSI LM REFRESH 15"	For refresh model
MKC08	3823B70008H	MCKINLEY LG-IBM OKI US SOUTH AFRICA 15" 86KEY	
MKC08	3823B71008H	MCKINLEY LG-IBM OKI US SOUTH AFRICA LM REFRESH 15"	For refresh model
MKC08	3823B70008G	MCKINLEY LG-IBM OKI UKRAINAIN 15" 86 KEY	
MKC08	3823B71008G	MCKINLEY N OKI UKRAINAIN LM REFRESH 15"	For refresh model
MKC08	3823B70008K	MCKINLEY LG-IBM OKI SPANISH 15" 86KEY	
MKC08	3823B70008J	MCKINLEY LG-IBM OKI PORTUGUESE 15" 86KEY	
MKC08	3823B70008L	MCKINLEY LG-IBM OKI POLISH 15" 87KEY	
MKC08	3823B71008L	MCKINLEY LG-IBM OKI POLISH LM REFRESH 15"	For refresh model
MKC08	3823B70008M	MCKINLEY N OKI FRENCH 15" 87KEY	
MKC08	3823B71008M	MCKINLEY LG-IBM OKI FRENCH REFRESH LM 15"	For refresh model
MKC08	3823B70008N	MCKINLEY LG-IBM SUNREX THAILAND 15" LM 84KEY	
MKC08	3823B71008N	MCKINLEY N OKI THAILAND LM REFRESH 15"	For refresh model
MKC08	3823B70008P	MCKINLEY LG-IBM OKI TAIWAN 15" LM 86KEY	
MKC08	3823B71008P	MCKINLEY N OKI TAIWAN LM REFRESH 15"	For refresh model
MKC08	3823B71008Q	MCKINLEY N OKI HUNGARY LM REFRESH 15"	For refresh model
MKC08	3823B71008R	MCKINLEY N OKI CZECH LM REFRESH 15"	For refresh model
MKC08	3823B71008S	MCKINLEY N OKI TURKEY LM REFRESH 15"	For refresh model
MKM06	3551B03007B	RETAINER ASSY 15.0" WITH SUB B/D	
MKM07	3551BZ3004B	RETAINER ASSY 14.1" WITH SUB B/D	
MKM08	3550BM3173B	COVER, CLUTCH LEFT	
MKM09	3550BM3172A	COVER, CLUTCH RIGHT	
MKM10	3550BM3171A	DUMMY, PCMCIA	
MKM11	3550BM4047A	DUMMY, SD	
MKM30	1SZZBA4039B	SCREW, D4.5 M2.5 L8.0 MM TORQUE 3.0 ±0.2	
MKM32	1SZZBZ4014A	SCREW, D4.3 M2.0 L5.0 MM TORQUE 2.0 ±0.2	

EXPLODED VIEW

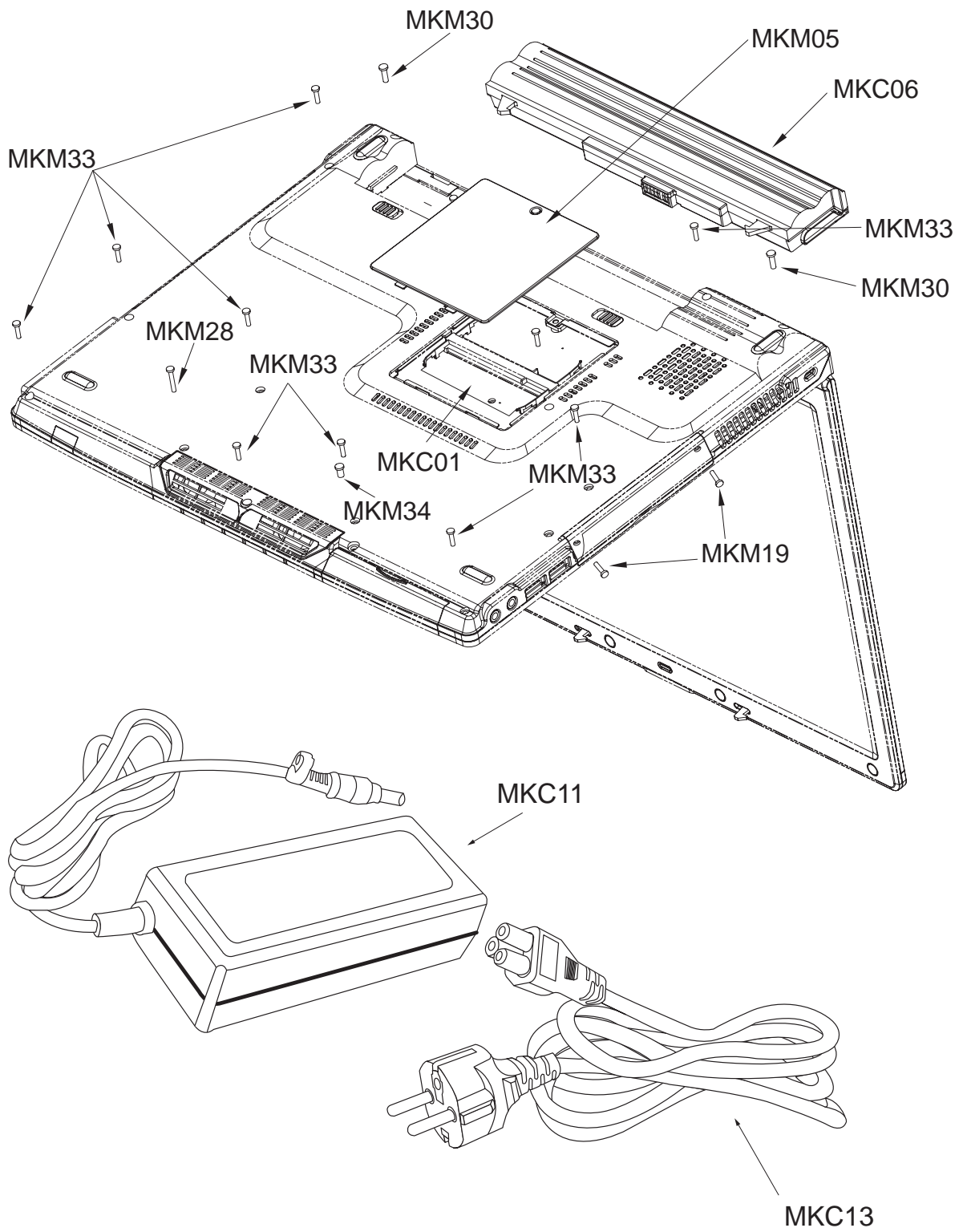

EXPLODED VIEW

Location	LG P/N	SPECIFICATION	REMARKS
MKC01	0IMMRSS090A	MEMORY, SAMSUNG M470L3224FT0-CB3 SODIMM 256MB DDR 333MHZ	
MKC01	0IMMRHY044A	MEMORY, HYNIX HYMD232M646C6-J SODIMM 256MB DDR 333MHZ	
MKC01	0IMMRIH032A	MEMORY, INFINEON HYS64D32020GDL-6-B SODIMM 256MB DDR 333MHZ	
MKC01	0IMMRSS091A	MEMORY, SAMSUNG M470L6423EN0-CB3 SODIMM 512MB DDR 333MHZ	
MKC01	0IMMRIH033A	MEMORY, INFINEON HYS64D64020GBDL-6-B SODIMM 512MB DDR 333MHZ	
MKC06	6911BZ0045B	LI-ION BATTERY, SIMPLO 4400MAH 3S-2P	
MKC06	6911BZ0046B	LI-ION BATTERY, SIMPLO 6600MAH 3S-3P	
MKC11	6708BA0036B	ADAPTER, LITEON PA-1650-02L1 65W 18.5V/3.5A 3PIN	
MKC11	6708BA0044B	ADAPTER, HIPRO HP-OK065B133 65W 16V/3.5A 3PIN	
MKC13	6410BD21003	PF8B1CIJ10A-060 LONGWELL CEU 1830MM 3P CONN. BLACK	Germany,Iran, Portugal,Spain
MKC13	6410BK21005	PL8B1S3J10A-060 LONGWELL SAA 1830MM 3PIN CONN BLACK	Australia
MKC13	6410BK20704	213356-001(SP502A+IS34) I-SHENG SAA 1850MM 3P CONN. BLACK	Australia
MKC13	6410BK21004	213356-001 LINE TEK SAA 1830MM 3PIN CONN. BLACK	Australia
MKC13	6410BK21002	213356-001 VOLEX SAA 1830MM 3PIN CONN. BLACK	Australia
MKC13	6410BK20705	PL8B1SQJ10A-060 LONGWELL SAA 1830MM 3PIN CONN BLACK	Australia
MKC13	6410BK21007	SP-502B+H05VV-F+IS-034 I-SHENG SAA 1830MM 3PIN CONN. BLACK	Australia
MKC13	6410BK21006	AU10S3+H03VV-F+VAC5S VOLEX SAA 1830MM 3PIN CONN BLACK	Australia
MKC13	6410BX21601	SP-022+IS-034+H05VV-F3G I-SHENG GOST 1800MM 3P CONN. BLACK	Russia
MKC13	6410BX21602	PF8B1CIJ10A-060 LONGWELL GOST 1830MM 3PIN CONN. BLACK	Russia
MKC13	6410BD21602	PF8B1CIJ10A-060 LONGWELL CEU 1830MM 3P CONN. BLACK	Spain
MKC13	6410BD20308	213350-001 LINE TEK VDE/SEMKO 1830MM 3PIN CONN. BLACK	Spain
MKC13	6410BD20306	213350-001 VOLEX VDE/SEMKO 1830MM 3P CONN. BLACK	Spain
MKC13	6410BW21001	X-LGPC0415-001 VOLEX ISI 1830MM 3PIN CONN. BLACK	India
MKC13	6410BQ21002	BR10S3+H03VV-F+VAC5S VOLEX INMETRO 1830MM 3PIN CONN BLACK	Brazil
MKC13	6410BQ21003	SP-305+H05VV-F+IS-034 I-SHENG INMETRO 1830MM 3PIN CONN BLACK	Brazil
MKC13	6410BO20603	P48F1SAJ30A-060 LONGWELL CCC 1830MM 3P CONN BLACK	China
MKC13	6410BO20602	SP-506+RVV 3CX0.75MM2+IS-034 I-SHENG CCC 1830MM 3P CONN BLACK	China
MKC13	6410BO21008	GB10S3+RW300_300+VAC5S VOLEX CCC 1830MM 3PIN CONN BLACK	China
MKC13	6410BH21003	SP-60+IS-034 I-SHENG BSI 1830MM 3PIN CONN FOR NT-PC BLACK	UAE,Saudi Arabia
MKC13	6410BV21002	PF8B1L1J10A-060 LONGWELL SII 1830MM 3PIN CONN. BLACK	Israel
MKC13	6410BV21003	SP-86+IS-034 I-SHENG SII 1830MM 3PIN CONN. BLACK	Israel
MKC13	6410BU21602	SP-80A+H05VV-F+IS-034 I-SHENG SABS 1830MM 3PIN CONN BLACK	South Africa

EXPLODED VIEW

Location	LG P/N	SPECIFICATION	REMARKS
MKM05	3581BZ0030A	COVER, ASSY DDR MEMORY	
MKM19	1SZZBA4017B	SCREW, D2.0 M2.0 L 3.5 MM TORQUE 2.0 ±0.2	
MKM28	1SZZBA4067A	SCREW, D4.0 M2.0 L13.0 MM TORQUE 2.0 ±0.2	
MKM30	1SZZBA4039B	SCREW, D4.5 M2.5 L8.0 MM TORQUE 3.0 ±0.2	
MKM33	1SZZBA4083A	SCREW, D3.8 M2.0 L8.0 MM TORQUE 2.0 ±0.2	
MKM34	1SZZBA4085A	SCREW, D5.5 M3.0 L6.0 MM TORQUE 2.0 ±0.2	