



**STB1000**

**HD Commercial Interface Set-top Box  
for use in Lodging Environments**

---

**Installation & Setup Guide  
Warranty**

For Customer Support/Service, please call:

**1-888-865-3026**

The latest product information and documentation is available online at:

**www.LG solutions.com/products**

MODEL and SERIAL NUMBER

The model and serial numbers of this STB are located on the back of the cabinet. For future reference, LG suggests that you record those numbers here:

Model No. \_\_\_\_\_ Serial No. \_\_\_\_\_



**WARNING:**

TO REDUCE THE RISK OF ELECTRIC SHOCK DO NOT REMOVE COVER (OR BACK). NO USER-SERVICEABLE PARTS INSIDE. REFER TO QUALIFIED SERVICE PERSONNEL.



The lightning flash with arrowhead symbol, within an equilateral triangle, is intended to alert the user to the presence of uninsulated "dangerous voltage" within the product's enclosure that may be of sufficient magnitude to constitute a risk of electric shock to persons.



The exclamation point within an equilateral triangle is intended to alert the user to the presence of important operating and maintenance (servicing) instructions in the literature accompanying the appliance.

**WARNING:**

TO PREVENT FIRE OR SHOCK HAZARDS, DO NOT EXPOSE THIS PRODUCT TO RAIN OR MOISTURE.

**POWER CORD POLARIZATION:**

This product is equipped with a 3-wire grounding-type alternating current power plug. This plug will fit into the power outlet only one way. This is a safety feature. If you are unable to insert the plug fully into the outlet, contact your electrician to replace your obsolete outlet. Do not defeat the safety purpose of the 3-wire grounding-type plug.

**NOTE TO CABLE/TV INSTALLER:**

This reminder is provided to call the cable TV system installer's attention to Article 820-40 of the National Electric Code (U.S.A.). The code provides guidelines for proper grounding and, in particular, specifies that the cable ground shall be connected to the grounding system of the building, as close to the point of the cable entry as practical.

**REGULATORY INFORMATION:**

This equipment has been tested and found to comply with the limits for a Class B digital device, pursuant to Part 15 of the FCC Rules. These limits are designed to provide reasonable protection against harmful interference when the equipment is operated in a residential installation. This equipment generates, uses and can radiate radio frequency energy and, if not installed and used in accordance with the instruction manual, may cause harmful interference to radio communications. However, there is no guarantee that interference will not occur in a particular installation. If this equipment does cause harmful interference to radio or television reception, which can be determined by turning the equipment off and on, the user is encouraged to try to correct the interference by one or more of the following measures:

- Reorient or relocate the receiving antenna.
- Increase the separation between the equipment and receiver.
- Connect the equipment to an outlet on a circuit different from that to which the receiver is connected.
- Consult the dealer or an experienced radio/TV technician for help.

**CAUTION:**

Do not attempt to modify this product in any way without written authorization from LG Electronics U.S.A., Inc. Unauthorized modification could void the user's authority to operate this product.

**COMPLIANCE:**

The responsible party for this product's compliance is: LG Electronics U.S.A., Inc.  
2000 Millbrook Drive, Lincolnshire, IL 60069, USA • Phone: 1-847-941-8000

Marketed and Distributed in the United States by LG Electronics U.S.A., Inc.  
2000 Millbrook Drive, Lincolnshire, IL 60069

# IMPORTANT SAFETY INSTRUCTIONS

---

1. Read these instructions.
2. Keep these instructions.
3. Heed all warnings.
4. Follow all instructions.
5. Do not use this apparatus near water.
6. Clean only with dry cloth.
7. Do not block any ventilation openings. Install in accordance with the manufacturer's instructions.
8. Do not install near any heat sources, such as radiators, heat registers, stoves, or other apparatus (including amplifiers) that produce heat.
9. Do not defeat the safety purpose of the polarized or grounding-type plug. A polarized plug has two blades with one wider than the other. A grounding-type plug has two blades and a third grounding prong. The wide blade or the third prong are provided for your safety. If the provided plug does not fit into your outlet, consult an electrician for replacement of the obsolete outlet.
10. Protect the power cord from being walked on or pinched, particularly at plugs, convenience receptacles, and the point where it exits from the apparatus.
11. Only use attachments/accessories specified by the manufacturer.
12. Use only with the cart, stand, tripod, bracket, or table specified by the manufacturer or sold with the apparatus. When a cart is used, use caution when moving the cart/apparatus combination in order to avoid injury from tip-over.
13. Refer all servicing to qualified service personnel. Servicing is required when the apparatus has been damaged in any way, such as power-supply cord or plug is damaged, liquid has been spilled or objects have fallen into the apparatus, the apparatus has been exposed to rain or moisture, does not operate normally, or has been dropped.
14. Never touch this apparatus or antenna during a thunder or lightning storm.
15. When mounting an STB on the wall, make sure not to install the STB by the hanging power and signal cables on the back of the STB.
16. Do not allow an impact shock or any objects to fall into the product.
17. **Power Cord**  
**Caution: It is recommended that appliances be placed upon a dedicated circuit; that is, a single outlet circuit which powers only that appliance and has no additional outlets or branch circuits. Check the appliance specifications.**  
Periodically examine the cord of your appliance, and if its appearance indicates damage or deterioration, unplug it, discontinue use of the appliance, and have the cord replaced with an exact replacement part by an authorized servicer. Protect the power cord from physical or mechanical abuse, such as twisting, kinking, or pinching or being closed in a door or walked upon. Pay particular attention to plugs, wall outlets, and the point where the cord exits the appliance.  
Do not use a damaged or loose power cord. Be sure to grasp the plug when unplugging the power cord. Do not pull on the power cord to unplug the STB.
18. **Overloading**  
Do not connect too many appliances to the same AC power outlet as this could result in fire or electric shock. Do not overload wall outlets. Overloaded wall outlets, loose or damaged wall outlets, extension cords, frayed power cords, or damaged or cracked wire insulation are dangerous. Any of these conditions could result in fire or electric shock.
19. **Outdoor Use/Wet Location**  
 **Warning: To reduce the risk of fire or electrical shock, do not expose this product to rain, moisture or other liquids.**  
Do not touch the STB with wet hands. Do not install this product near flammable objects such as gasoline or candles or expose the STB to direct air conditioning.  
Do not expose to dripping or splashing and do not place objects filled with liquids, such as vases, cups, etc., on or over the apparatus (e.g., on shelves above the unit).



(Continued on next page)

# IMPORTANT SAFETY INSTRUCTIONS

(Continued from previous page)

## 20. Grounding

Ensure that you connect the earth ground wire to prevent possible electric shock (i.e., an STB with a three-prong grounded AC plug must be connected to a three-prong grounded AC outlet). If grounding methods are not possible, have a qualified electrician install a separate circuit breaker. Do not try to ground the unit by connecting it to telephone wires, lightning rods, or gas pipes.

## 21. Disconnect Device

The mains plug is the disconnecting device. The plug must remain readily operable.

As long as this unit is connected to the AC wall outlet, it is not disconnected from the AC power source even if you turn off this unit by SWITCH.

## 22. Outdoor Antenna Grounding

If an outside antenna or cable system is connected to the product, follow the precautions below.

An outdoor antenna system should not be located in the vicinity of overhead power lines or other electric light or power circuits or where it can come into contact with such power lines or circuits as death or serious injury can occur.

Be sure the antenna system is grounded so as to provide some protection against voltage surges and built-up static charges.

Article 810 of the National Electrical Code (NEC) in the U.S.A. provides information with respect to proper grounding of the mast and supporting structure, grounding of the lead-in wire to an antenna-discharge unit, size of grounding conductors, location of antenna-discharge unit, connection to grounding electrodes, and requirements for the grounding electrode.

## Antenna Grounding According to NEC, ANSI/NFPA 70

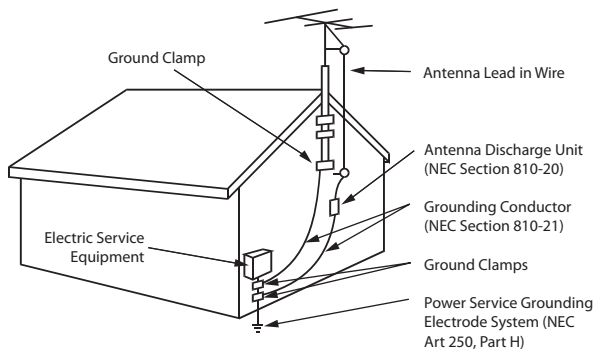

## 23. Cleaning

When cleaning, unplug the power cord and rub gently with a soft cloth to prevent scratching. Do not spray water or other liquids directly on the STB as electric shock may occur. Do not clean with chemicals such as alcohol, thinners, or benzene.

## 24. Transporting Product

Make sure the product is turned Off and unplugged and that all cables have been removed. Do not press against or put stress on the STB.

## 25. Ventilation

Install the STB where there is proper ventilation. Do not install in a confined space such as a bookcase. Do not cover the product with cloth or other materials (e.g., plastic) while it is plugged in. Do not install in excessively dusty places.

26. Do not touch the ventilation openings, as they may become hot while the STB is operating.

27. If you smell smoke or other odors coming from the STB or hear strange sounds, unplug the power cord, and contact an authorized service center.

28. Keep the product away from direct sunlight.

# Table of Contents

---

Safety Warnings . . . . .	2	Remote Jack Pack Connections & Setup . . . . .	62
Important Safety Instructions . . . . .	3–4	External Equipment Setup . . . . .	63–65
Table of Contents . . . . .	5	Digital Audio Optical Connections / Component Connections . . . . .	63
Setup Checklist . . . . .	6	HDMI/DVI Connections / RGB Hookup to PC . . . . .	64
STB1000 Rear and Front Panel Overview . . . . .	7	Composite Connections . . . . .	65
STB1000 Jack Panel Overview . . . . .	8	<b>References</b>	
Ventilation / Mounting the STB1000 . . . . .	9	Upgrading STB1000 Software using a USB Memory Device . . . . .	66
<b>STB1000 Cabling Connections . . . . .</b>	<b>10–11</b>	Downloading a Splash Screen using a USB Memory Device . . . . .	67
STB1000 Installer Remote . . . . .	12	RS-232 Display Panel Requirements . . . . .	68
Installer Remote Control Typical Key Functions . . . . .	13	Display Panel Type Specifications . . . . .	69
Pro:Centric Interactive Menu Functions . . . . .	14	STB1000 Aux Input Configuration . . . . .	70
<b>STB1000 Setup Menus . . . . .</b>	<b>15</b>	STB1000 Camport Auto Sense Operation . . . . .	71
Channel Setup Options . . . . .	16–18	<i>b</i> -LAN Setup & Overview . . . . .	72
Picture Setup Options . . . . .	19–23	RJP Model List and Input Auto-sensing Hierarchy . . . . .	73
Option Settings . . . . .	24–26	Programming the Installer Remote . . . . .	74
Audio Setup Options . . . . .	27–29	Remote Control Codes . . . . .	75–76
Time Setup Options . . . . .	30–31	IR Codes . . . . .	77–78
Lock Setup Options . . . . .	32–37	Troubleshooting . . . . .	79–82
Input Settings . . . . .	38	General Troubleshooting . . . . .	79
Commercial Mode Setup Overview . . . . .	39	Troubleshooting Flow Chart . . . . .	80
<b>Commercial Mode Setup for Master STB1000 . . . . .</b>	<b>40–41</b>	Commercial Mode Check / FTG Operation Troubleshooting . . . . .	81
Installer Menu . . . . .	42–48	Clone Programmer Troubleshooting . . . . .	82
Adding Channel Icons / Custom Channel Labels (2-5-4 + MENU Mode) . . . . .	49	Specifications . . . . .	83
Cloning Overview / Clonable Menu Features . . . . .	50	Glossary of Terms . . . . .	84
Cloning Procedures . . . . .	51–57	Document Revision History / Notes . . . . .	85
Learning / Teaching a Master STB1000 Setup using a USB Memory Device . . . . .	51	Warranty . . . . .	Back Cover
Learning / Teaching a Master STB1000 Setup using a TLL-1100A Clone Programmer . . . . .	52–54		
Learning / Teaching a Master STB1000 Setup using an LT2002 Clone Programmer . . . . .	55–57		
<b>FTG Mode of Operation . . . . .</b>	<b>58–61</b>		

---

## Notes

- Installer Menu content is intended for use primarily by qualified STB/TV electronics technicians.
- For additional information, contact your LG representative.

Note: Design and specifications subject to change without prior notice.

# Setup Checklist

---

## Installation and Setup

\_\_\_ Unpack the STB1000 and all accessories.

Accessories provided:

- 6 ft AC power cord
- 5 ft RS-232C-F to RS-232C-F null-modem cable with 3.5 mm stereo plug
- 5 ft RS-232C-M to RS-232C-F straight-through cable
- 5 ft HDMI to DVI-M cable
- 1 ft DVI-F to HDMI adapter cable
- 5 ft Audio cable with 3.5 mm stereo plugs
- IR receiver with attached 3.5 mm stereo plug cable (3 ft), plus mounting bracket
- 5 wall mount brackets with 5 screws for attaching the STB1000 to a wall
- Installer Remote with batteries

\_\_\_ Determine the installation location for the STB1000, display panel stand, or mount.

\_\_\_ Determine mounting and installation requirements, for example, AC power source outlet, antenna/cable service connectors, any external equipment required for system operation, all necessary cables, wires, and connectors, and any other additional required hardware, etc.

\_\_\_ Install batteries in the remote control.

\_\_\_ Install the display panel on VESA mount or stand, as necessary, following the manufacturer's instructions.

**Note:** It may be advisable to make all cable connections before installing on VESA mount or stand.

## Hardware Connections

\_\_\_ Install any additional hardware as appropriate to your institution, LAN, etc.

## STB1000 Cable Connections

\_\_\_ Make all connections to the rear and jack panel connectors.

\_\_\_ Connect the STB1000 to a standard 120V 60 Hz AC power source.

## Commercial Mode Setup

\_\_\_ Complete Commercial Mode Setup (configure all relevant Installer Menu items as required of your institution and configure display features for the end user).

## Software Installation

\_\_\_ Install or configure any software as applicable, for example, PPV, etc.

# STB1000 Rear and Front Panel Overview

## STB1000 Rear Panel

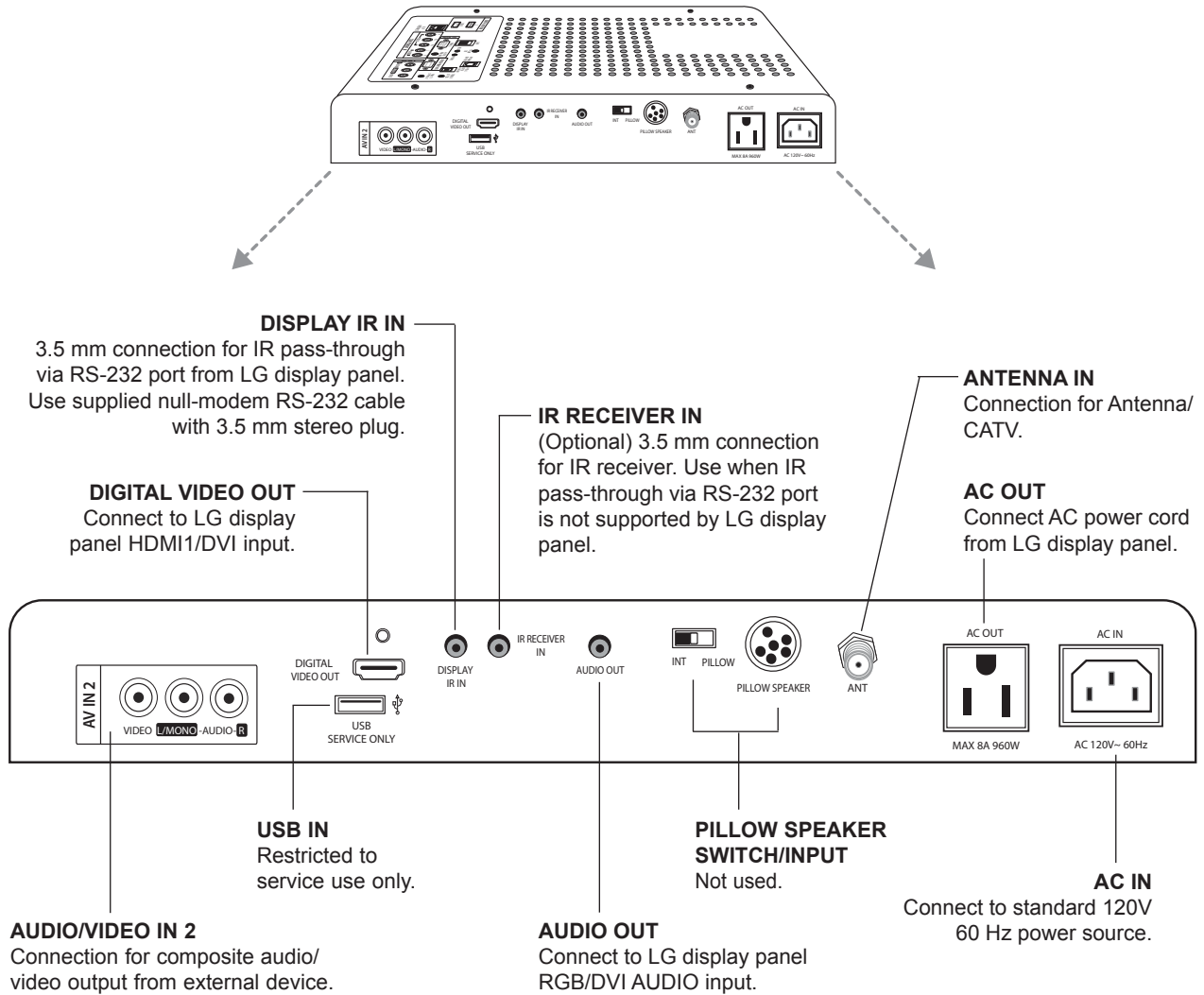

## STB1000 Front Panel

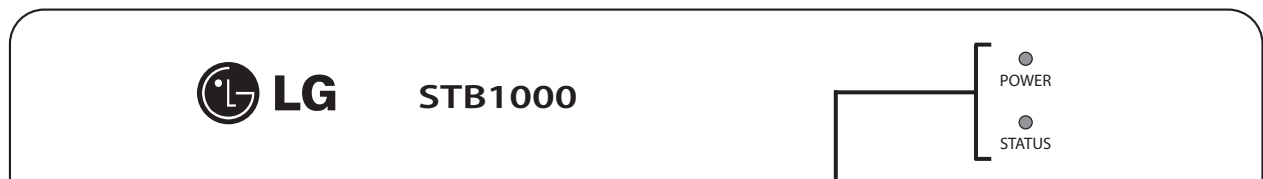

# STB1000 Jack Panel Overview

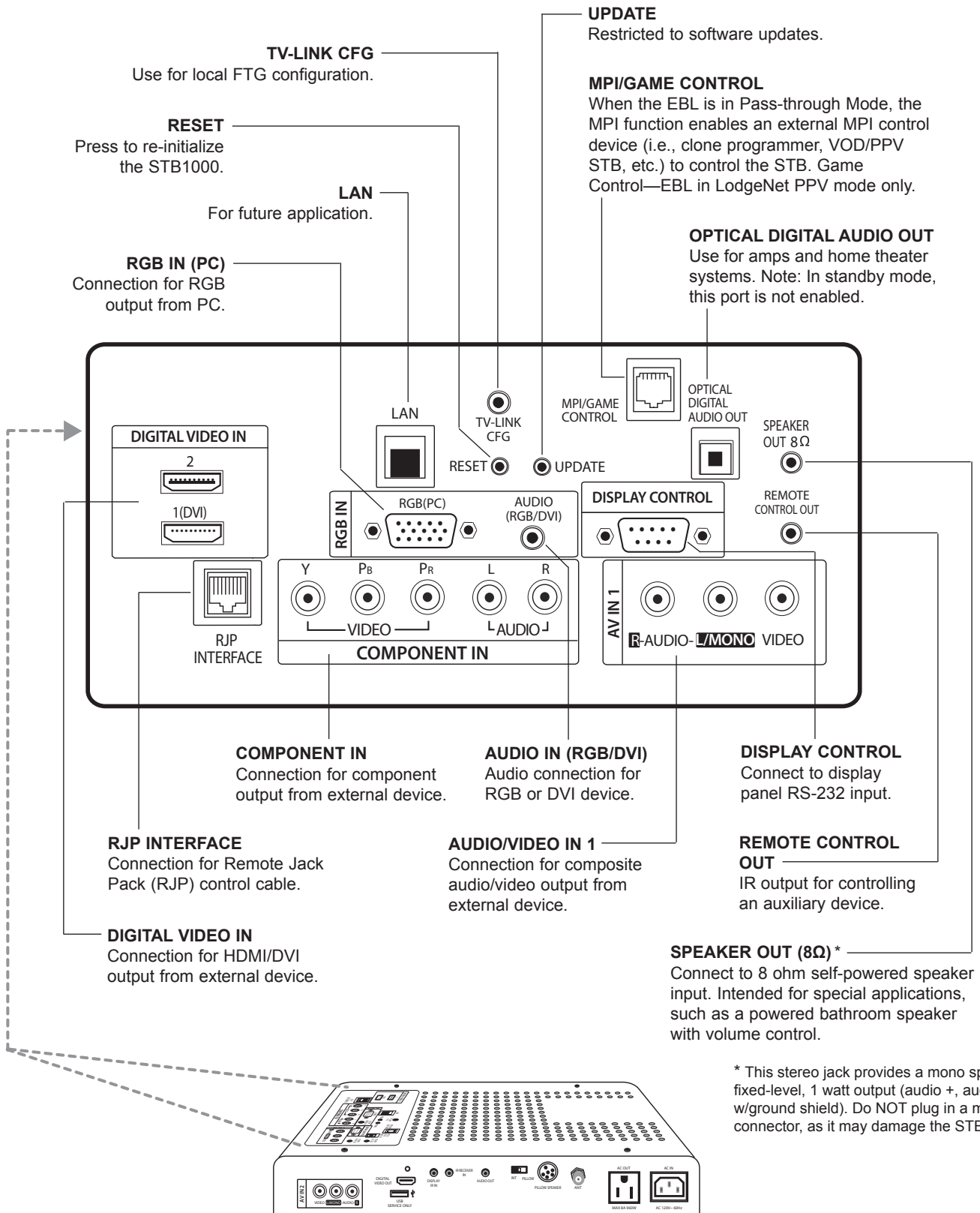



## Ventilation

The STB1000 generates heat during operation and needs to be provided with adequate ventilation to assure continued reliable operation. See recommendations below.

**⚠ Proper clearance for air to flow around the STB1000 must be provided.**

**Note:** While accommodating STB1000 ventilation requirements, also be sure proper ventilation is provided for the display panel. Refer to display panel installation documentation for ventilation requirements and specifications.

**Note:** In addition to the ventilation requirements indicated below, be sure to allow enough clearance (4 to 5 inches) for wiring clusters attached to the STB1000.

1. Ventilation holes on the top and bottom of the STB1000 are provided for ventilation cooling (see figures at right).
2. The vent holes should never be blocked or obstructed to airflow but have an unimpeded path through any enclosure back to room temperature air.
3. The unit and its venting, should not be installed near heat sources, such as radiators or heating ducts.
4. If the unit is placed in an enclosure, tests should be run to confirm that the ambient temperature around the unit under normal expected operating conditions is stable and does not exceed 40 degrees Celsius (104° F). The ambient temperature can be determined by placing a thermometer near the air intake vents in the proposed enclosure and measuring the temperature every hour, under normal operating conditions, until two successive readings repeat.  
If the temperature does not stabilize but keeps increasing above 40 degrees Celsius (104° F), ventilation is inadequate and needs to be improved.
5. Always provide adequate air space between the ventilation areas and adjacent structures.

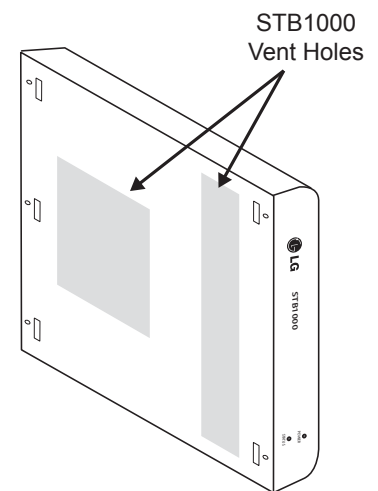
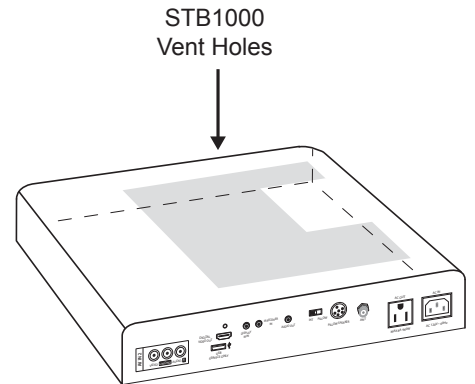

## Vertical Installation (Wall Mount) Using Supplied Angled L-Brackets

Angled brackets are provided so that the STB1000 can be mounted on a flat vertical surface, like a wall. Install the angled brackets with the screws provided. Then, mount the STB1000 on the wall using appropriate screws.

**Note:** The brackets are designed to be mounted to typical 16-inch spaced wall studs. Do not mount the STB1000 on a weak wall surface. If wall studs are not available, use another appropriate fastening system.

## Monitor/STB1000 Wall Mounting System

The display panel and STB1000 can be mounted to a wall using an optional monitor/interface STB wall mounting system. For further information on the mounting system, contact your LG dealer.

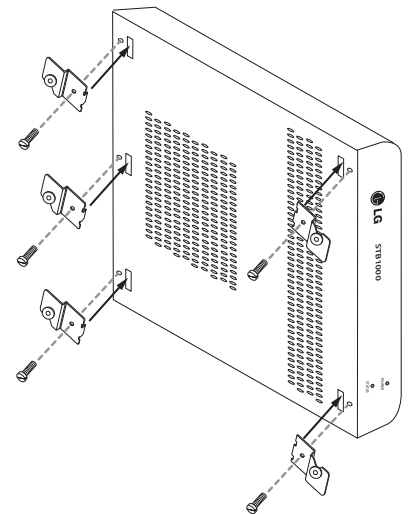

# STB1000 Cabling Connections

Refer to the cabling diagram below, and complete the procedure on page 11 to connect the STB1000 to a compatible LG display panel.

**Notes:**

- This diagram shows a typical installation using the supplied RS-232 null-modem cable.
- Refer to the Reference, "RS-232 Display Panel Requirements," for a list of compatible LG monitors/TVs.

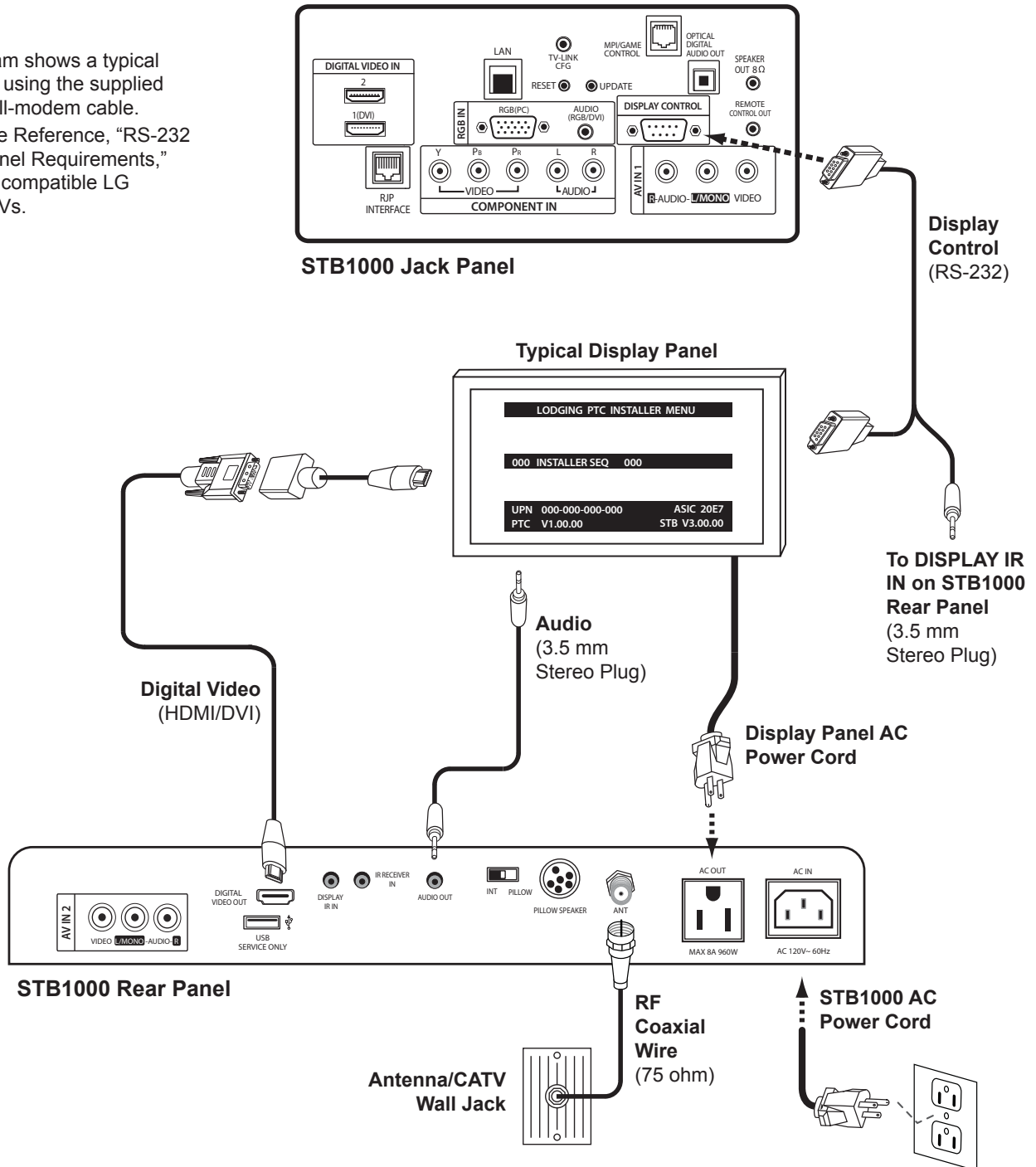

## STB1000 Cabling Connections (Cont.)

1. Use one of the supplied RS-232 cables—either the serial DB9-Female to DB9-Female null-modem cable or the DB9-Female to DB9-Male straight-through cable, depending on display panel requirements—to connect the DISPLAY CONTROL connector on the STB1000 jack panel to the RS-232 IN connector on the LG display panel.

**Note:** Once the RS-232 connection is made between the STB1000 and the LG display panel, the display panel functions can only be controlled by the STB1000 RS-232 commands.

2. Make the appropriate IR connection:

- If the LG display panel supports IR pass-through and you are using the null-modem RS-232 cable with 3.5 mm stereo plug, connect the 3.5 mm plug to the DISPLAY IR IN jack on the STB1000 rear panel.
- If the display panel does not support IR pass-through via the RS-232 port, attach the supplied IR receiver and bracket assembly (see diagram below) to the back of the display panel, and connect the 3.5 mm plug to the IR RECEIVER IN jack on the STB1000 rear panel.

The IR receiver should be installed in the IR bracket. When the IR bracket assembly is attached to the display, it should be mounted with two-sided tape on the bottom-back side of the display panel. The IR receiver should be aimed toward the TV viewer and be visible at the bottom front of the display, in order that it be able to receive IR signals from the user remote.

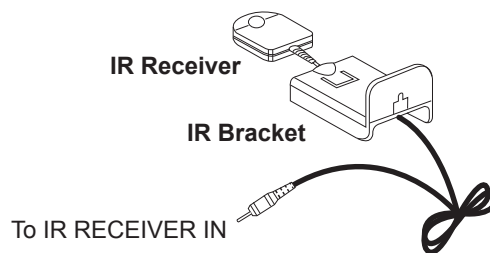

3. Use the supplied HDMI cable (with adapter, if necessary) to connect the DIGITAL VIDEO OUT connector on the STB1000 rear panel to the HDMI1/DVI input connector on the LG display panel.
4. Use the supplied Audio cable to connect the AUDIO OUT connector on the STB1000 rear panel to the RGB/DVI AUDIO input connector on the LG display panel.
5. Connect a 75 ohm coaxial wire from the Antenna/CATV wall jack to the ANT (Antenna In) jack on the STB1000 rear panel.
6. Plug the display panel AC power cord into the AC power outlet (AC OUT) provided on the STB1000 rear panel.
7. Plug the STB1000 AC power cord into a standard 120V 60 Hz power outlet. Once power is applied to the STB1000, the AC power outlet (AC OUT) is active. Also, the STATUS LED on the STB1000 front panel will begin blinking, indicating that the panel is in standby mode.
8. Use the supplied Installer Remote to turn ON the STB/display panel.

**Note:** It is recommended that you complete STB1000 Commercial Mode Setup and Cloning procedures before you make external equipment connections to the STB1000.

# STB1000 Installer Remote

The LG Installer Remote is supplied with and dedicated to operate the STB1000. See next page for typical key functions. Some DVD and VCR controls may be available for selected LG DVD/VCR products.

## Installing Batteries in Installer Remote

- Open the battery compartment cover on the back side of the remote.
- Install two high-quality alkaline 1.5V AAA batteries. Never mix old or used batteries with new ones. Install batteries matching correct polarity as shown (+ with + and - with -).
- Replace the battery compartment cover.

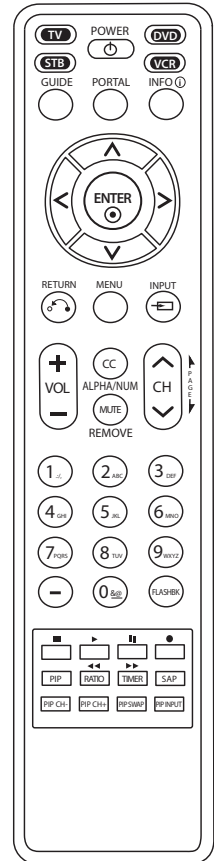
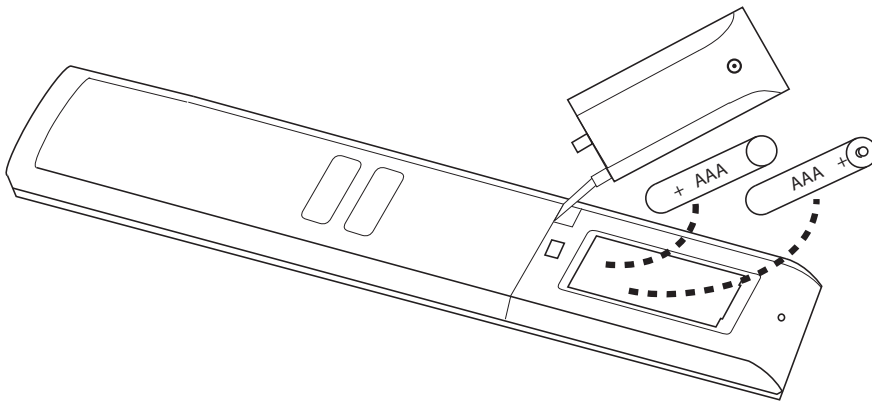

# Installer Remote Control Typical Key Functions

The LG Installer Remote illustrated below shows typical remote control functions and is provided for reference only. This Installer Remote may vary from the Installer Remote supplied with the STB1000.

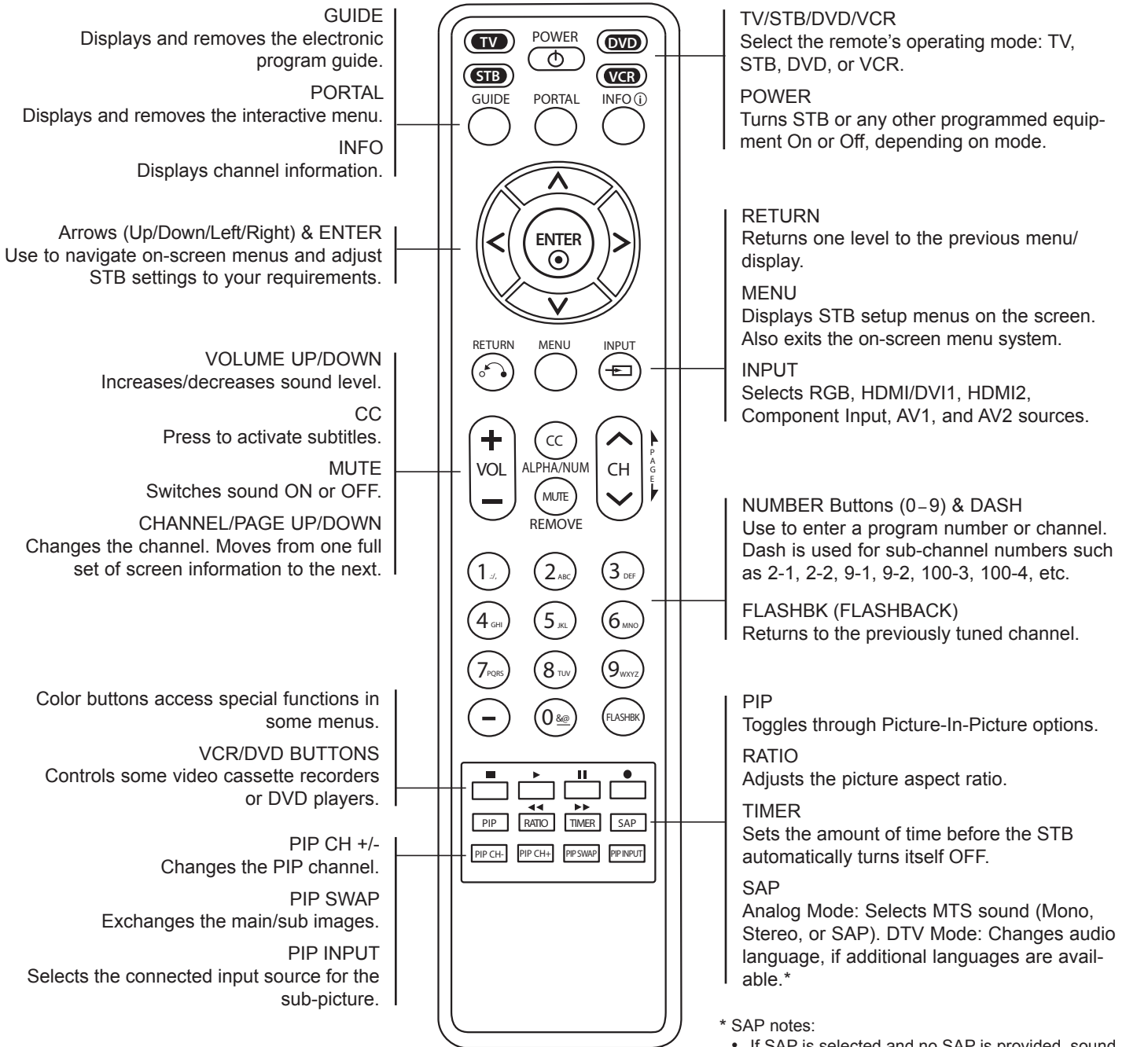

\* SAP notes:

- If SAP is selected and no SAP is provided, sound may not be heard on channel.
- Each analog channel may have its own SAP setting.
- Digital channels will reset to default audio language with a power off/on.

# Pro:Centric Interactive Menu Features

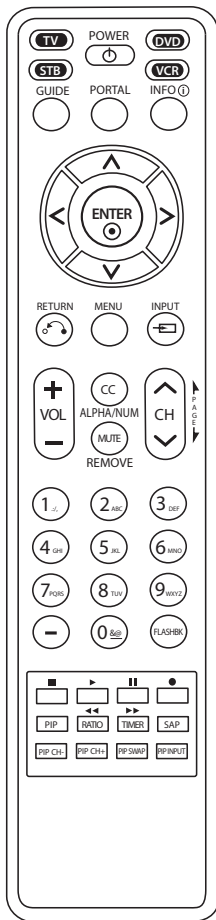
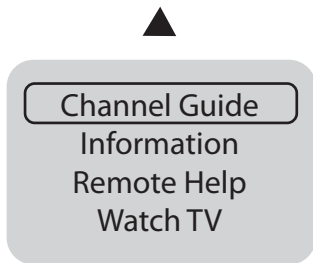

**Important: Pro:Centric operation requires that Installer Menu item 119 DATA CHANNEL be set appropriately and that the STB1000 be in PPV or FTG Mode.**

The interactive Pro:Centric STB enables guests—from the comfort of their rooms—to view and select from a complete listing of hotel/institution services and amenities. The Pro:Centric STB is connected to the institution's billing computer, and service/amenities charges are billed at the time of order.

Interactive amenities may include:

- Hotel/institution information, news, and events
- Directory services (tourist attractions, restaurants, etc.)
- Reservation services (business meetings, fitness, spa, etc.)
- Weather and traffic information
- Shopping services (delivery to guest room)
- Room service (menu ordering, memo service, morning wake up call, laundry, etc.)
- Ticketing services
- Check-out service (in the guest room)
- Gaming services
- E-mail resources/account access

Use the Installer Remote to operate both interactive menus and regular STB1000 features. Press **PORTAL** on the Installer Remote to access the interactive menus.

**Note:** Interactive menu options may vary, depending on Pro:Centric features enabled for the site. The following are default interactive menus.

## Channel Guide

Shows available TV networks and channels. When available, Electronic Program Guide (EPG) data indicates the channel and the program start and finish times.

## Information

Typically displays hotel information, for example, photos of guest rooms, dining rooms, business centers, fitness and pool facilities, etc. Information may also include resources, such as local school programs, run in cooperation with the hotel.

## Remote Help

Provides help for navigating the interactive menus.

## Watch TV

Removes the interactive menu from the screen and returns to the previously tuned channel.

# STB1000 Setup Menus

On-screen setup menus control the basic features of the STB1000/display. Press **MENU** on the Installer Remote to access the STB1000 setup menus. Setup menu options are described in detail on pages 16 to 38. Note that on-screen displays (OSDs) shown in this manual may differ from those shown on the display panel. This document provides typical examples to familiarize you with the STB1000 options.

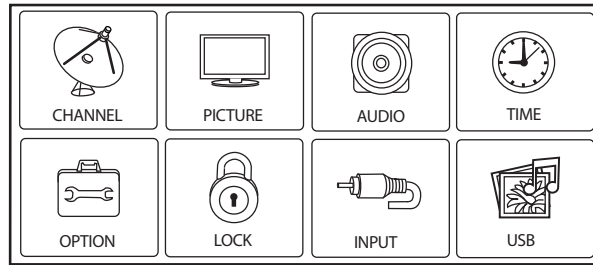

**Note:** The USB menu option is not applicable for the STB1000.

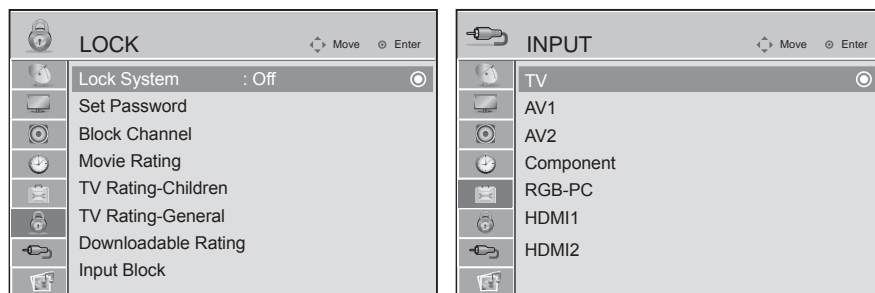
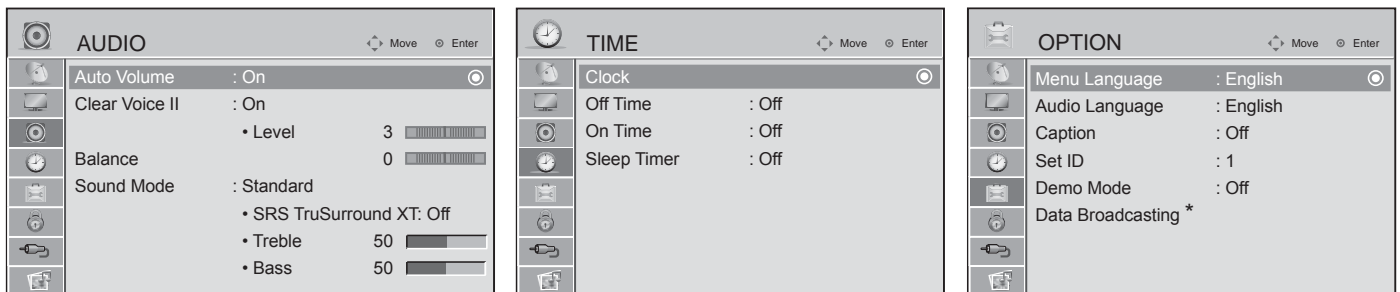
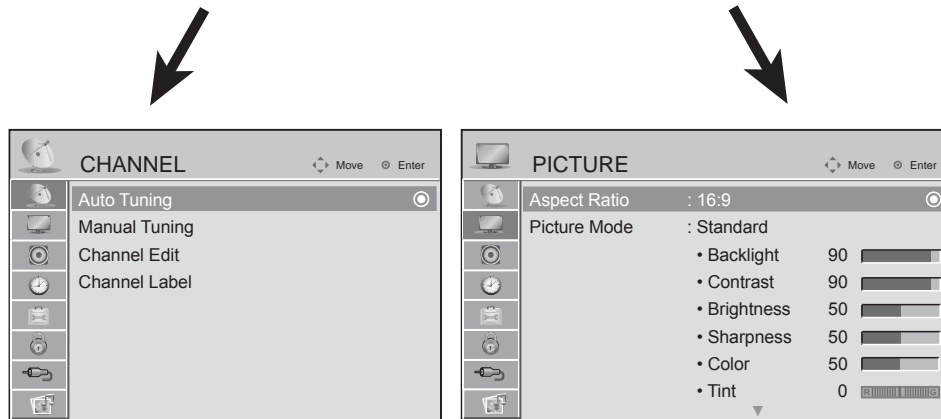

\* Data Broadcasting is not applicable for the STB1000.

# Channel Setup Options

## Auto Tuning (Channel Search)

### Auto Tuning (Channel Search)

Auto Tuning automatically finds and stores all digital and analog channels available through antenna or cable inputs.

1. Press **MENU** on the Installer Remote, and use the arrow navigation keys to select/highlight the **CHANNEL** menu option. Then, press **ENTER**.
2. Use the Up/Down arrows to select **Auto Tuning**, and then press **ENTER**.
3. In the Auto Tuning pop-up window, use the Up/Down arrows to select **Yes**, and then press **ENTER** to initiate the channel search.
4. The STB1000 will search for digital channels first. After the digital channel search is completed, the STB will search for analog channels as well.

Select **Next(Analog)**, if desired, to bypass the digital channel search and initiate the search for analog channels.

A progress bar shows the percentage complete of the channel search, and DIGITAL and ANALOG fields track the number of channels found.

5. When Auto Tuning is complete, select **Close** and press **ENTER** to close the pop-up window and return to the Channel Menu.
6. Press **MENU** to return to TV viewing, or press **RETURN** to return to the previous menu level.

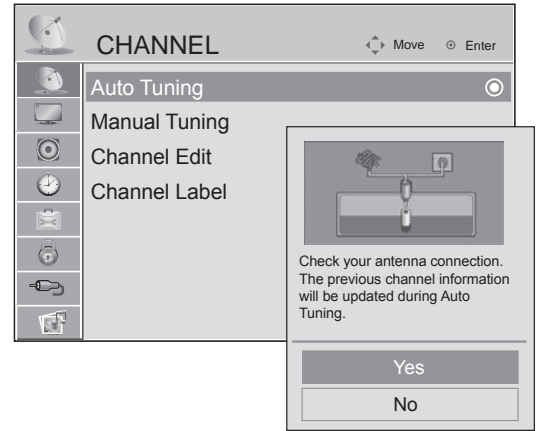

#### Notes:

- A password is required to gain access to Auto Tuning if the Lock System is turned ON.
- The Tuning Band must be set in the Installer Menu before the channel search is initiated. The default Tuning Band is CATV (Installer Menu item 003 BAND/ AFC is set to 1). Update the setting, as necessary (see the "Installer Menu" section of this document for further information).
- If this is the first time the STB/display has been turned ON, a "Press Enter (⊙) to set your channel settings" message will be displayed at the bottom of the screen. Press **ENTER** to initiate Auto Tuning, if desired, from this message.
- Running Auto Tuning automatically removes any assigned/existing channel labels.
- Cable will not work unless you subscribe to a cable service.



# Channel Setup Options (Cont.)

## Manual Tuning (Add/Delete Channels) / View Digital Signal Strength

### Manual Tuning (Add/Delete Channels)

Use this option to manually add active channels or remove unwanted channels. See also “Edit Channels” on the following page.

1. Press **MENU** on the Installer Remote, and use the arrow navigation keys to select/highlight the **CHANNEL** menu option. Then, press **ENTER**.
2. Use the Up/Down arrows to select **Manual Tuning**, and then press **ENTER**.
3. In the Manual Tuning pop-up window, use the Left/Right arrows to select **DIGITAL** or **ANALOG**. Then, use the Up/Down arrows to highlight the Channel field.
4. In the Channel field, use the Left/Right arrows to select the required channel. Then, use the Up/Down arrows to select **Add** or **Delete** (if the channel is not currently active, there will be an “Add” button; otherwise, there will be a “Delete” button as shown in the example at right).
5. Repeat steps 3 and 4 to add/delete additional channels.
6. When you are done adding/deleting channels, select **Close** and press **ENTER** to close the pop-up window and return to the Channel Menu.
7. Press **MENU** to return to TV viewing, or press **RETURN** to return to the previous menu level.

### View Digital Signal Strength

The Manual Tuning option described above enables you to view the signal strength for digital inputs. Select the desired digital channel in the Manual Tuning pop-up window to view the quality of the digital signal being received.

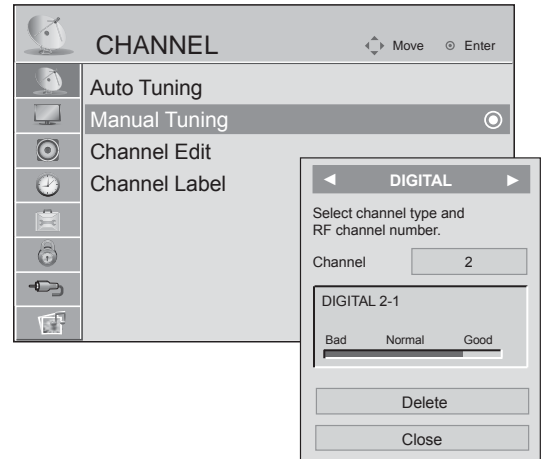

#### Notes:

- A password is required to gain access to Manual Tuning if the Lock System is turned ON.
- If you are/will be setting up this STB1000 as a Master STB, complete any manual channel tuning/editing BEFORE transferring the STB setup to the internal STB controller (PTC). Refer to the Commercial Mode Setup procedure on pages 40 to 41 for further information.
- If you delete a found channel, it isn't gone forever. Simply re-add the channel to the channel lineup as described in the “Edit Channels” procedure on the following page.

# Channel Setup Options (Cont.)

## Edit Channels / Channel Labels

### Edit Channels

Use this option to add or delete channels from the channel lineup.

1. Press **MENU** on the Installer Remote, and use the arrow navigation keys to select/highlight the **CHANNEL** menu option. Then, press **ENTER**.
2. Use the Up/Down arrows to select **Channel Edit**, and then press **ENTER**.
3. In the Edit Channel pop-up window, active channels are displayed in black, while (manually) deleted channels are displayed in blue. Submenu options are displayed at the bottom of the pop-up window.

Use the arrow keys to select the Digital or Analog tab, and then select the channel to edit (add or delete).

4. Press the blue (Add/Delete) button on the Installer Remote to add or delete the selected channel.
5. Repeat steps 3 and 4 to edit additional channels.
6. When you are done editing channels, press **MENU** or **ENTER** to return to TV viewing, or press **RETURN** to return to the Channel Menu.



**Note:** The picture view at the left of the pop-up window provides a preview of the currently tuned channel.

### Channel Labels

Channel labels (AMC, ESPN, HBO, etc.) help users identify the channel or network being viewed. The Channel Label menu option provides a series of preset labels for the more common networks. Use any of these to label the channels in the STB's memory.

1. Press **MENU** on the Installer Remote, and use the arrow navigation keys to select/highlight the **CHANNEL** menu option. Then, press **ENTER**.
2. Use the Up/Down arrows to select **Channel Label**, and then press **ENTER**.
3. In the Channel Label pop-up window, use the Left/Right arrows to select a channel in the Channel field. Then, use the Up/Down arrows to highlight the Logo field.
4. In the Logo field, use the Left/Right arrows to select the appropriate logo. Each logo is previewed in the space just below the Logo field.
5. Repeat steps 3 and 4 to assign labels for additional channels.
6. When you are done adding labels, select **Close** and press **ENTER** to close the pop-up window and return to the Channel Menu.
7. Press **MENU** to return to TV viewing, or press **RETURN** to return to the previous menu level.

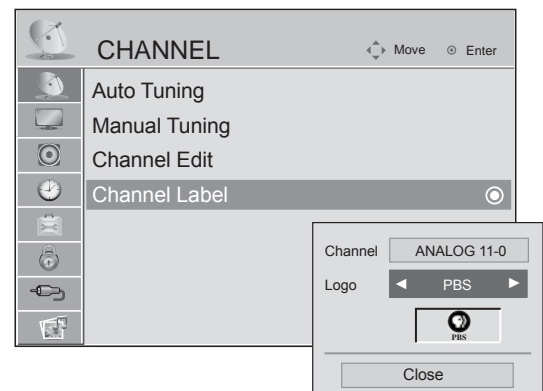

## Aspect Ratio (Picture Size) Control

### Aspect Ratio (Picture Size) Control

This option enables you to choose the appropriate picture aspect ratio depending on the input source. Use the **RATIO** button on the Installer Remote or use the procedure below.

1. Press **MENU** on the Installer Remote, and use the arrow navigation keys to select/highlight the **PICTURE** menu option. Then, press **ENTER**.
2. Use the Up/Down arrows to select **Aspect Ratio**, and then press **ENTER**.
3. Use the Up/Down arrows to select the appropriate setting from the pop-up window of aspect ratio options (see descriptions below), and then press **ENTER**.
4. Press **MENU** to return to TV viewing, or press **RETURN** to return to the previous menu level.

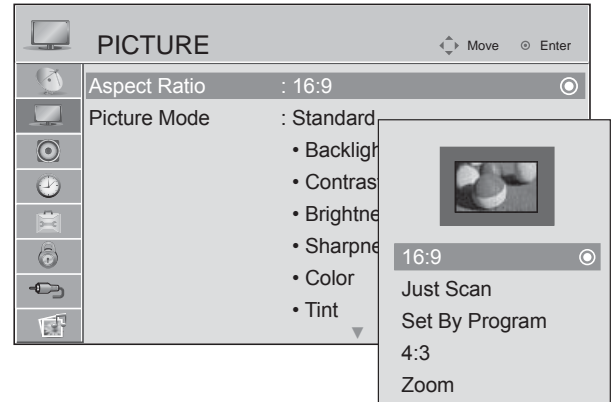

#### Notes:

- The RGB-PC input source can only use the 4:3 or 16:9 aspect ratio.
- To set the aspect ratio using the Installer Remote, press the **RATIO** button repeatedly until the desired option displays on-screen.

#### Aspect Ratio Options

- **16:9:** Adjusts the picture horizontally, in a linear proportion, to fill the entire screen.
- **Just Scan:** Normally the edges of video signals are cropped 1 to 2%. This option turns off the cropping and shows the complete video.

**Note:** If there is noise on the edges of the original signal, it will be visible when Just Scan is activated.

**Note:** Just Scan operates only with DTV/CADTV/HDMI-DTV/DVI-DTV (720p/1080i) and Component (720p/1080i) input sources.

- **Set By Program:** Selects the proper picture proportion (16:9 or 4:3) to match the source's image.
- **4:3:** Choose this option to view a picture with an original 4:3 aspect ratio.
- **Zoom:** Choose this option to view the picture without any alteration. Note, however, that the top and bottom portions of the picture will be cropped.

# Picture Setup Options (Cont.)

## Picture Mode

### Picture Mode

This feature enables you to select a preconfigured Picture Mode option and/or customize picture settings manually.

1. Press **MENU** on the Installer Remote, and use the arrow navigation keys to select/highlight the **PICTURE** menu option. Then, press **ENTER**.
2. To select a preconfigured Picture Mode option:
  - Use the Up/Down arrows to select **Picture Mode**, and then press **ENTER**.
  - Use the Up/Down arrows to select the appropriate option (see descriptions below) from the Picture Mode pop-up window, and then press **ENTER**.
3. To manually adjust individual Picture Mode settings (Contrast, Sharpness, etc.):
  - Use the Up/Down arrows to select the setting to adjust (see descriptions below), and then press **ENTER**.
  - A pop-up window will appear at the bottom of the display screen. Use the Left/Right arrows to make the appropriate adjustment to the selected picture setting, and/or use the Up/Down arrows to navigate between settings.
  - When you have completed all necessary adjustments, press **ENTER** to close the pop-up window.
4. Press **MENU** to return to TV viewing, or press **RETURN** to return to the previous menu level.

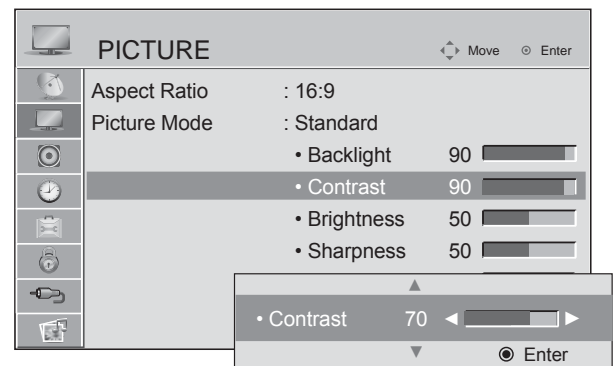
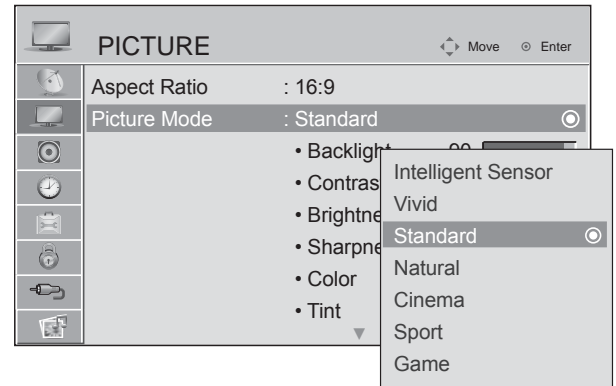

#### Notes:

- Most manual options are disabled (grayed out) if the Picture Mode is set to Intelligent Sensor—see description.
- The Backlight option is not applicable for the STB1000.

#### Preconfigured Picture Mode Options

- **Intelligent Sensor:** Enables the STB to adjust to the most suitable, optimal picture settings based on surrounding conditions. If selected, all manual picture adjustment options, with the exceptions of Advanced Control and Picture Reset, will be disabled.
- **Vivid:** Maximizes contrast, brightness, color, and sharpness for a vivid picture.
- **Standard:** Provides an optimum viewing condition for general users.
- **Natural:** Maximizes natural screen tones.
- **Cinema:** Optimizes video for movie viewing.
- **Sport:** Emphasizes dynamic video and primary colors (e.g., white, grass, sky blue, etc.) to optimize sport viewing.
- **Game:** Maximizes response speed in a fast gaming screen.

#### Adjustable Picture Mode Options

- **Contrast:** Increases or decreases the gradient of the video signal. Adjust Contrast when the bright part of the picture is saturated.
- **Brightness:** Increases or decreases the base level of the signal in the picture. Adjust Brightness when the dark part of the picture is saturated.
- **Sharpness:** Adjusts the level of crispness in the edges between the light and dark areas of the picture. The lower the level, the softer the image.
- **Color:** Adjusts the intensity of all colors.
- **Tint:** Adjusts the balance between red and green levels.

### Advanced Control

1. Press **MENU** on the Installer Remote, and use the arrow navigation keys to select/highlight the **PICTURE** menu option. Then, press **ENTER**.
2. Use the Up/Down arrows to select **Advanced Control** under Picture Mode, and then press **ENTER**.
3. In the Advanced Control pop-up window, use the arrow keys to select and/or adjust the appropriate settings (see descriptions below).
4. When you are finished, select **Close** and press **ENTER** to close the pop-up window and return to the Picture Menu.
5. Press **MENU** to return to TV viewing, or press **RETURN** to return to the previous menu level.

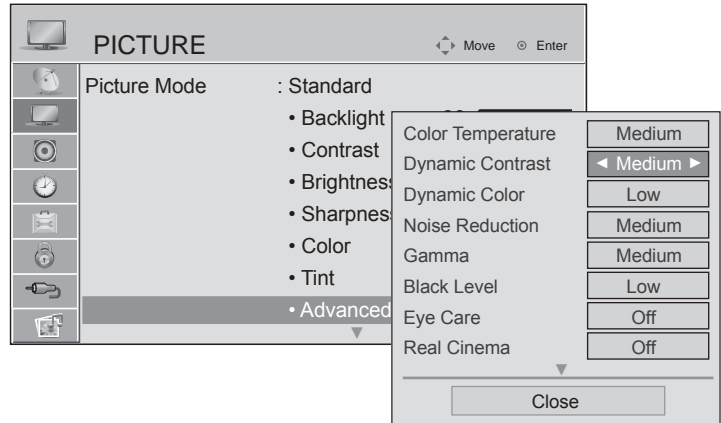

### Advanced Control Options

- **Color Temperature:** A Warm setting enhances hotter colors, such as red. A Cool setting enhances cooler colors, such as blue.
- **Dynamic Contrast:** Enables you to adjust contrast to improve the picture by making bright parts brighter and dark parts darker. Low, Medium, or High setting options. Set to "Off" to disable this feature.
- **Dynamic Color:** Enables you to enhance hue, saturation, and luminance so that red, blue, green, and white colors are more vivid, lively, rich, and clear. Low or High setting options. Set to "Off" to disable this feature.
- **Noise Reduction:** Enables you to reduce screen noise without compromising video quality. Low, Medium, or High setting options. Set to "Off" to disable this feature.
- **Gamma:** A Low setting brightens dark and middle gray level areas of the picture, a Medium setting expresses original picture levels, and a High setting darkens dark and middle gray level areas of the picture.
- **Black Level:** A Low setting darkens the reflection of the screen. A High setting brightens the reflection of the screen. This feature is available in the following modes: AV (NTSC-M), HDMI, or Component.
- **Eye Care:** If set to "On," this feature adjusts the brightness of the screen to dim extremely bright pictures. Eye Care is disabled in the Intelligent Sensor, Vivid, and Cinema picture modes.
- **Real Cinema:** If set to "On," this feature makes video clips recorded in film look more natural by eliminating judder effect.
- **Color Gamut:** The Standard setting displays the standard set of colors. The Wide setting increases the number of colors used. Maximize the use of color to increase color quality.

# Picture Setup Options (Cont.)

## Picture Reset / RGB-PC Screen Settings

### Picture Reset

This option restores the Picture Mode to factory default settings.

1. Press **MENU** on the Installer Remote, and use the arrow navigation keys to select/highlight the **PICTURE** menu option. Then, press **ENTER**.
2. Use the Up/Down arrows to select **Picture Reset** under Picture Mode, and then press **ENTER**.
3. At the prompt for confirmation, select **Yes** and press **ENTER** to continue. The picture settings will be reset immediately, and you will see a “Resetting video configuration...” on-screen message.
4. Press **MENU** to return to TV viewing, or press **RETURN** to return to the previous menu level.

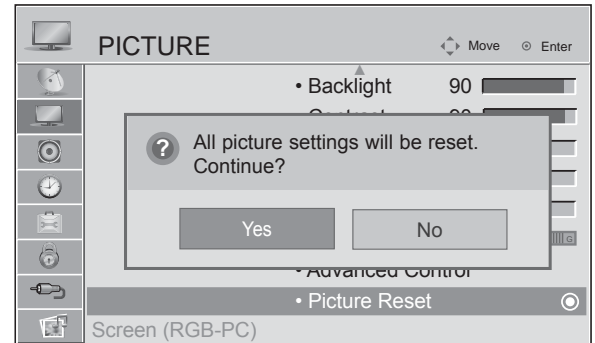

### RGB-PC Screen Settings

1. If not already done, connect the PC to the STB, select the RGB input on the STB, and then turn ON the computer. (See page 64 for information on connecting a PC to the STB. See page 38 for information on selecting the input.)
2. Press **MENU** on the Installer Remote, and use the arrow navigation keys to select/highlight the **PICTURE** menu option. Then, press **ENTER**.
3. Use the Up/Down arrows to select **Screen (RGB-PC)** under Picture Mode, and then press **ENTER**. (This option is only available for selection when the Input is set to RGB-PC and the PC is connected properly to the STB.)

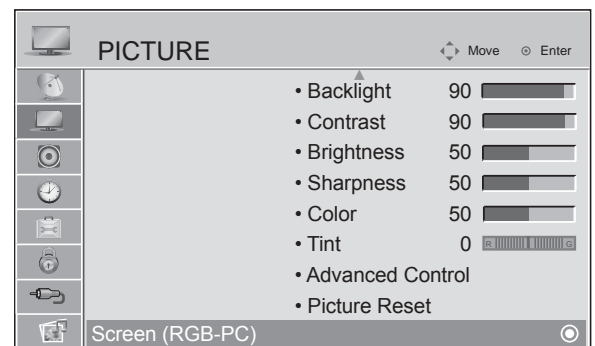

A pop-up Screen Menu enables you to configure multiple settings, including resolution, position, size, etc. The following subsections describe the RGB-PC Screen Menu options.

### Screen Resolution

Where possible, the resolution setting on the STB1000 should match the PC's resolution setting. This option is only available when the PC's resolution is set to: 1024 x 768, 1280 x 768, or 1360 x 768.

1. In the Screen Menu, use the Up/Down arrows to select **Resolution**, and then press **ENTER**.
2. Use the Up/Down arrows to select the appropriate resolution setting. Then, press **ENTER** to save your selection and return to the Screen Menu.

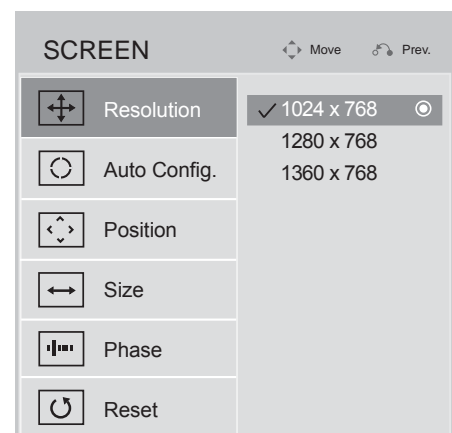

# Picture Setup Options (Cont.)

## RGB-PC Screen Settings (Cont.)

### Screen Auto Configuration

This option automatically adjusts the picture position and minimizes image instability.

1. In the Screen Menu, use the Up/Down arrows to select **Auto Config**, and then press **ENTER**.
2. Use the Left/Right arrows to select **Yes**, and then press **ENTER** to initiate the auto adjustment.
3. After adjustment, if the picture position is still not correct or if the picture is not clear or text is shaking, try running Auto Configuration again, or use the Position, Size, or Phase options (see below) to adjust the picture manually. You can also try a different resolution.

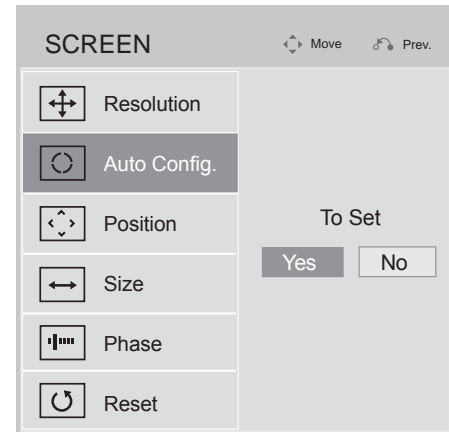

### Screen Position, Size, and Phase

Use these options, as necessary, to manually adjust the picture.

1. In the Screen Menu, use the Up/Down arrows to select **Position**, **Size**, or **Phase**, as appropriate:
  - Position: Enables you to adjust the picture left/right and/or up/down as desired.
  - Size: Enables you to minimize any vertical bars or stripes visible on the screen background. The horizontal screen size will also change.
  - Phase: Enables you to remove any horizontal noise and clear and sharpen the image of characters.

Then, press **ENTER**.

2. Make adjustments, as required. When you have completed your adjustments, press **ENTER** to return to the Screen Menu.

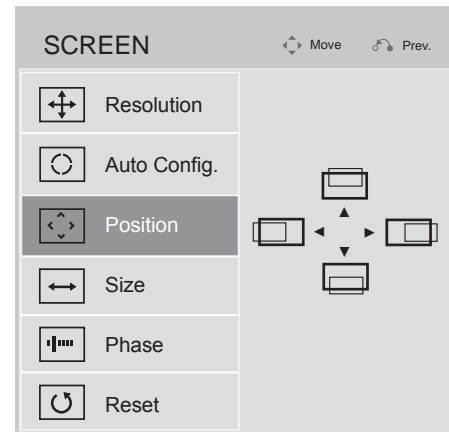

### Screen Reset

This option restores the picture position, size, and phase to the default settings.

1. In the Screen Menu, use the Up/Down arrows to select **Reset**, and then press **ENTER**.
2. Use the Left/Right arrows to select **Yes**, and then press **ENTER** to initiate the reset.

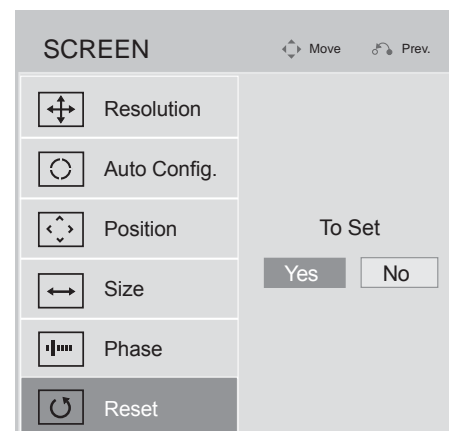

# Option Settings

## Menu Language / Audio Language

---

### Menu Language

Use this option to select the language of on-screen menus.

1. Press **MENU** on the Installer Remote, and use the arrow navigation keys to select/highlight the **OPTION** menu option. Then, press **ENTER**.
2. Use the Up/Down arrows to select **Menu Language**, and then press **ENTER**.
3. In the Menu Language pop-up window, use the Up/Down arrows to select the desired language, and then press **ENTER**.

From this point forward, the on-screen menus will display in the selected language.

4. Press **MENU** to return to TV viewing, or press **RETURN** to return to the previous menu level.

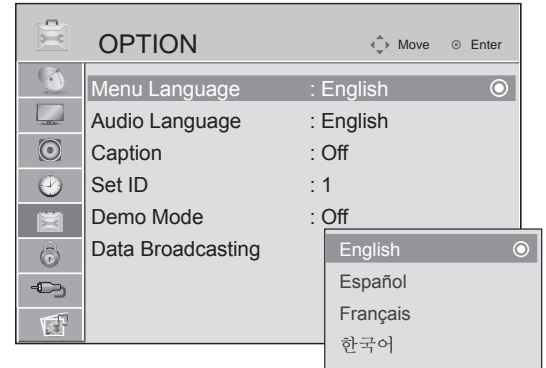

### Audio Language

Additional language options may be available if a digital signal is provided by the broadcasting station. This feature operates only in DTV/Cable TV mode.

1. Press **MENU** on the Installer Remote, and use the arrow navigation keys to select/highlight the **OPTION** menu option. Then, press **ENTER**.
2. Use the Up/Down arrows to select **Audio Language**, and then press **ENTER**.
3. In the Audio Language pop-up window, use the Up/Down arrows to select the desired language, and then press **ENTER**.
4. Press **MENU** to return to TV viewing, or press **RETURN** to return to the previous menu level.

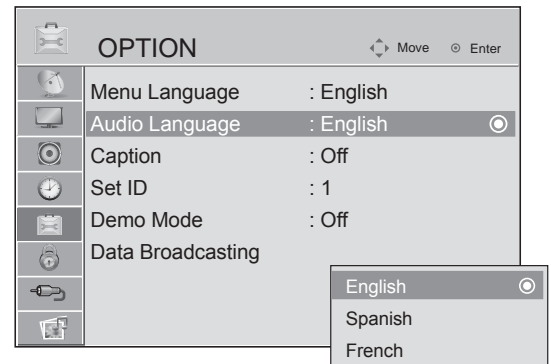



### Captions

Use this option to select the appropriate mode for displaying captions. Caption text, if provided by the broadcaster, is available for both digital and analog channels on the antenna/cable.

#### Turn Captions On/Off

1. Press **MENU** on the Installer Remote, and use the arrow navigation keys to select/highlight the **OPTION** menu option. Then, press **ENTER**.
2. Use the Up/Down arrows to select **Caption**, and then press **ENTER**.
3. In the Caption pop-up window, use the Left/Right arrows to turn captions On or Off.
4. If you turn captions "Off," all additional options in the pop-up window will become disabled (and you can press **ENTER** to exit the pop-up window). Otherwise, use the Up/Down arrows to highlight the Mode field.
5. In the Mode field, select the appropriate Caption Mode:
  - For analog channels: Select the appropriate option from CC (1-4) or Text (1-4). Then, press **ENTER** to close the pop-up window, and continue with step 6.
  - For digital channels: Select the appropriate option from CC (1-4), Text (1-4), or Service (1-6). Then, either press **ENTER** to close the pop-up window, or configure digital caption options as described below.
6. Press **MENU** to return to TV viewing, or press **RETURN** to return to the previous menu level.

#### Digital Caption Options

1. Turn captions On and select a Caption Mode as described above. Then, use the Up/Down arrows to highlight the Digital Option field. Press **ENTER**.
2. In the Digital Option pop-up window, use the Left/Right arrows to select the appropriate digital option:
  - Set By Program: If selected, all custom options will be grayed out. Press **ENTER** to close the pop-up window.
  - Custom: This option enables you to customize caption attributes, including, font size and style, text color and opacity, background color and opacity, and edge type and color. Use the arrow keys to navigate between fields and select settings. Each option is previewed at the bottom of the display screen. When you have set all attributes as desired, press **ENTER** to close the pop-up window.
3. Press **MENU** to return to TV viewing, or press **RETURN** to return to the previous menu level.

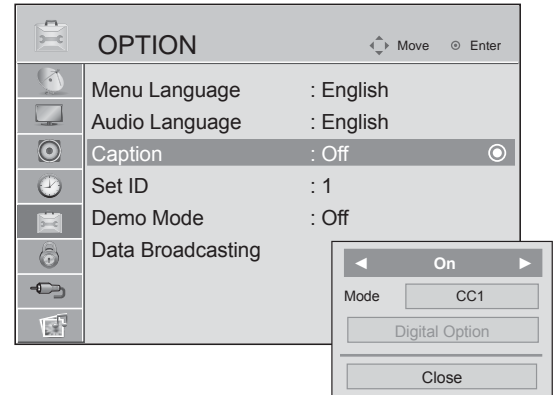

#### Notes:

- Closed Captions typically scroll across the bottom or top of the display screen and usually comprise the audio portion of a program.
- To select Closed Captions using the Installer Remote, press the **CC** button repeatedly until the desired option displays on-screen.
- Analog Captions will display on-screen whether the signal is from an RF channel or external equipment input.

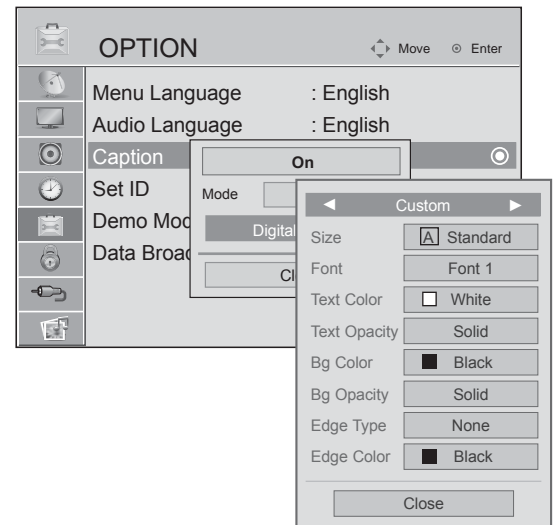

**Note:** If custom digital caption settings are to be cloned, all attributes should be set to any option other than Default. If Default is left as the setting for any one option, then all the attributes will be reset to default after cloning.

# Option Settings (Cont.)

## Set ID / Demo Mode

---

### Set ID

1. Press **MENU** on the Installer Remote, and use the arrow navigation keys to select/highlight the **OPTION** menu option. Then, press **ENTER**.
2. Use the Up/Down arrows to select **Set ID**, and then press **ENTER**.
3. In the Set ID pop-up window, use the Left/Right arrows to select the appropriate Set ID number. Then, press **ENTER**.
4. Press **MENU** to return to TV viewing, or press **RETURN** to return to the previous menu level.

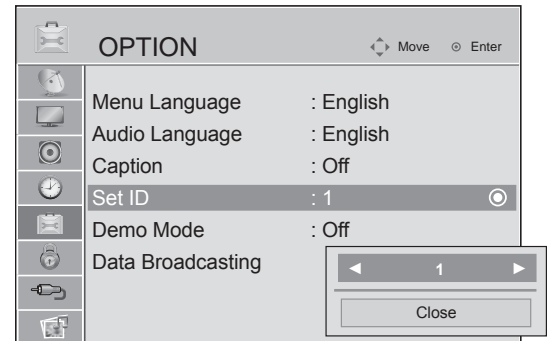

### Demo Mode

This option displays a slide show to explain the features of the STB.

1. Press **MENU** on the Installer Remote, and use the arrow navigation keys to select/highlight the **OPTION** menu option. Then, press **ENTER**.
2. Use the Up/Down arrows to select **Demo Mode**, and then press **ENTER**.
3. In the Demo Mode pop-up window, use the Up/Down arrows to turn Demo Mode On or Off. Then, press **ENTER**.
4. Press **MENU** to return to TV viewing, or press **RETURN** to return to the previous menu level.

If activated, the demonstration will begin shortly. If you want to stop the demonstration, press any button on the remote except for volume keys (VOL Up/Down or MUTE).

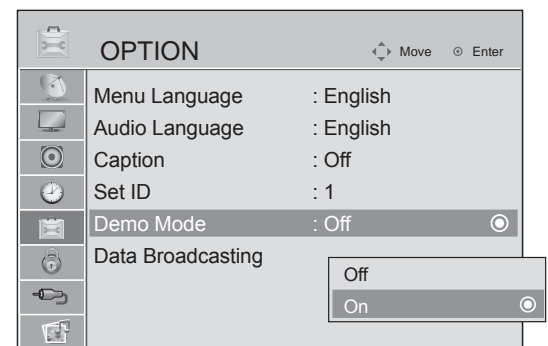

### Auto Volume

Each broadcasting station has its own signal conditions, which may result in different volume levels for different programs/channels. This option enables the STB1000 to make automatic adjustments to maintain a consistent volume level between channels. It also ensures a consistent volume level whether you are watching a commercial or a regular TV program.

1. Press **MENU** on the Installer Remote, and use the arrow navigation keys to select/highlight the **AUDIO** menu option. Then, press **ENTER**.
2. Use the Up/Down arrows to select **Auto Volume**, and then press **ENTER**.
3. In the Auto Volume pop-up window, use the Up/Down arrows to select On or Off. Then, press **ENTER**.
4. Press **MENU** to return to TV viewing, or press **RETURN** to return to the previous menu level.

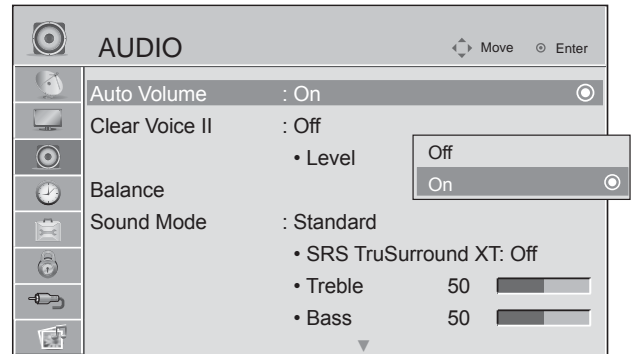

### Clear Voice II

By differentiating the human sound range from others, Clear Voice improves the sound quality of voices.

1. Press **MENU** on the Installer Remote, and use the arrow navigation keys to select/highlight the **AUDIO** menu option. Then, press **ENTER**.
2. Use the Up/Down arrows to select **Clear Voice II**, and then press **ENTER**.
3. In the Clear Voice pop-up window, use the Up/Down arrows to select On or Off. Then, press **ENTER**.
4. If setting Clear Voice to "On," select **Level** next, and make appropriate adjustments using the Left/Right arrows.
5. Press **MENU** to return to TV viewing, or press **RETURN** to return to the previous menu level.

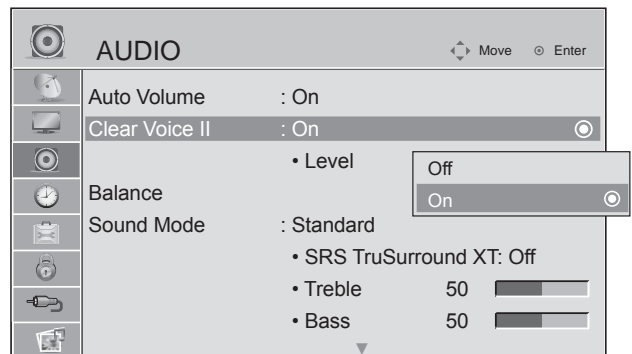

### Balance

1. Press **MENU** on the Installer Remote, and use the arrow navigation keys to select/highlight the **AUDIO** menu option. Then, press **ENTER**.
2. Use the Up/Down arrows to select **Balance**, and then press **ENTER**.
3. In the Balance pop-up window, use the Left/Right arrows to make the appropriate adjustments. Then, press **ENTER**.
4. Press **MENU** to return to TV viewing, or press **RETURN** to return to the previous menu level.

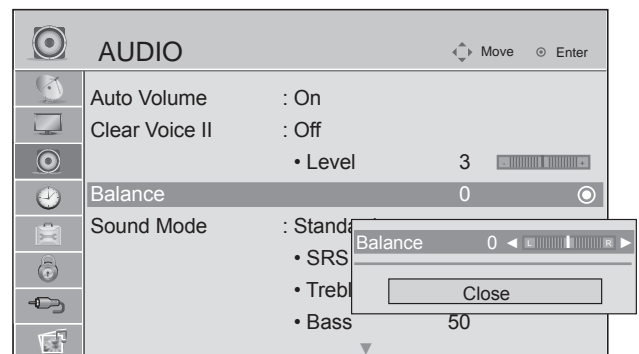

# Audio Setup Options (Cont.)

## Sound Mode

### Sound Mode

This feature enables you to select a preset Sound Mode option and/or customize sound settings manually.

1. Press **MENU** on the Installer Remote, and use the arrow navigation keys to select/highlight the **AUDIO** menu option. Then, press **ENTER**.
2. To select a preset Sound Mode option:
  - Use the Up/Down arrows to select **Sound Mode**, and then press **ENTER**.
  - Use the Up/Down arrows to select the appropriate option (see descriptions below) from the Sound Mode pop-up window, and then press **ENTER**.
3. To manually adjust individual Sound Mode settings (SRS TruSurround XT, Treble, or Bass):
  - Use the Up/Down arrows to select the setting to adjust, and then press **ENTER**.
  - A pop-up window will appear at the bottom of the display screen. (All three manual options are adjustable from one pop-up window). Use the Left/Right arrows to make the appropriate adjustments to the individual sound settings, and/or use the Up/Down arrows to navigate between settings.
  - When you have completed all necessary adjustments, press **ENTER** to close the pop-up window.
4. Press **MENU** to return to TV viewing, or press **RETURN** to return to the previous menu level.

#### Preset Sound Mode Options

- Standard: Offers standard-quality sound.
- Music: Optimizes sound for music listening.
- Cinema: Optimizes sound for movie viewing.
- Sport: Optimizes sound for sporting events.
- Game: Optimizes sound for game playing.

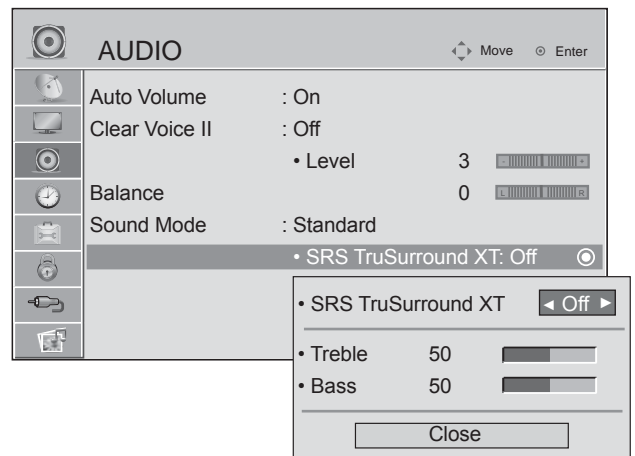
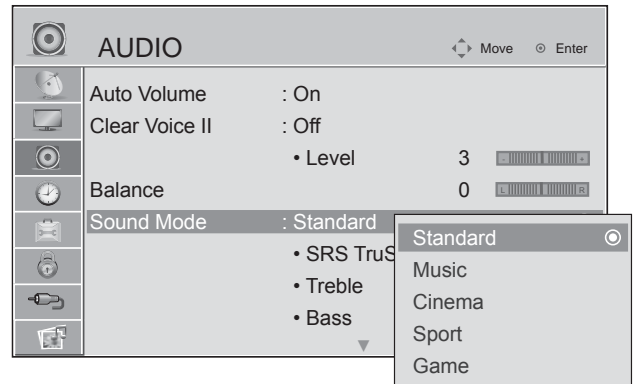

#### Notes:

- With preset Sound Mode options, the STB sets the appropriate sound options based on program content. Each option is preset for optimum sound quality at the factory.
- TruSurround XT is a patented SRS technology that enables playback of 5.1 multichannel content over two speakers. Note that if Clear Voice II is set to "On," SRS TruSurround XT is not available.

# Audio Setup Options (Cont.)

## Audio Reset / TV Speaker / Secondary Audio Program (SAP) Setup

### Audio Reset

This option restores the Sound Mode to factory default settings.

1. Press **MENU** on the Installer Remote, and use the arrow navigation keys to select/highlight the **AUDIO** menu option. Then, press **ENTER**.
2. Use the Up/Down arrows to select the **Reset** option under Sound Mode, and then press **ENTER**.
3. At the prompt for confirmation, select **Yes** and press **ENTER** to continue. The audio settings will be reset immediately, and you will see a "Resetting audio configuration..." on-screen message.
4. Press **MENU** to return to TV viewing, or press **RETURN** to return to the previous menu level.

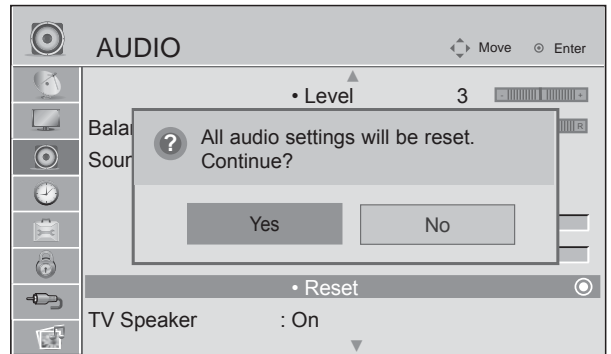

### TV Speaker

If using an external audio equipment (a Hi-Fi system or an SRS system), turn OFF the display panel's internal speakers. In AV, Component, RGB, and HDMI with HDMI to DVI cable, the display panel speaker can be operational even when there is no video signal.

1. Press **MENU** on the Installer Remote, and use the arrow navigation keys to select/highlight the **AUDIO** menu option. Then, press **ENTER**.
2. Use the Up/Down arrows to select the **TV Speaker** option, and then press **ENTER**.
3. In the TV Speaker pop-up window, use the Up/Down arrows to select On or Off. Then, press **ENTER**.
4. Press **MENU** to return to TV viewing, or press **RETURN** to return to the previous menu level.

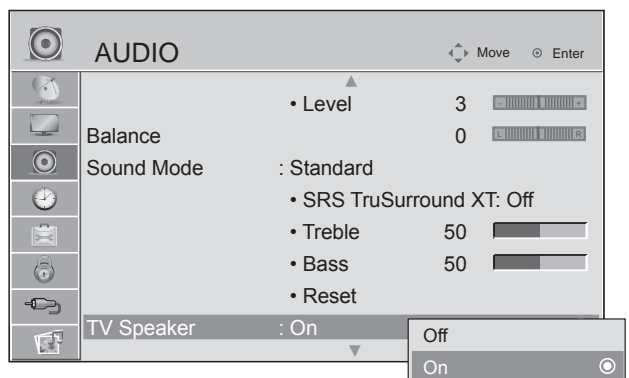

### Secondary Audio Program (SAP) Setup

- For analog signal: The STB1000 can receive MTS stereo programs and any SAP that accompanies the stereo program if the station transmits an additional sound signal. Mono sound is automatically used if the broadcast is only in Mono.
- For digital signal: If other languages are available on the digital signal, select them using the SAP button on the Installer Remote.

Press the **SAP** button on the Installer Remote repeatedly until the desired option (Mono, Stereo, or SAP) displays on-screen.

# Time Setup Options

## Set the STB Clock / STB On and Off Time Settings

### Set the STB Clock

The STB1000 clock is set automatically from a digital channel signal. The signal includes clock information provided by the broadcasting station. You can also set the clock manually if the auto clock function does not set the current time correctly.

1. Press **MENU** on the Installer Remote, and use the arrow navigation keys to select/highlight the **TIME** menu option. Then, press **ENTER**.
2. Use the Up/Down arrows to select **Clock**, and then press **ENTER**.
3. In the Clock pop-up window, use the Left/Right arrows to select **Auto** or **Manual** clock settings.
4. Depending on your selection in step 3:
  - Auto: Select the appropriate settings in the Time Zone and Daylight Saving fields. All other fields will be set automatically and are disabled (grayed out) on-screen.
  - Manual: Select the appropriate settings in the Month, Date, Year, Hour, and Minute fields. The Time Zone and Daylight Saving fields will be disabled (grayed out) on-screen.

Use the Up/Down arrows to navigate between the fields, and use the Left/Right arrows to make your selections.

5. When you have completed the clock settings as required, select **Close** and press **ENTER** to close the pop-up window and return to the Time Menu.
6. Press **MENU** to return to TV viewing, or press **RETURN** to return to the previous menu level.

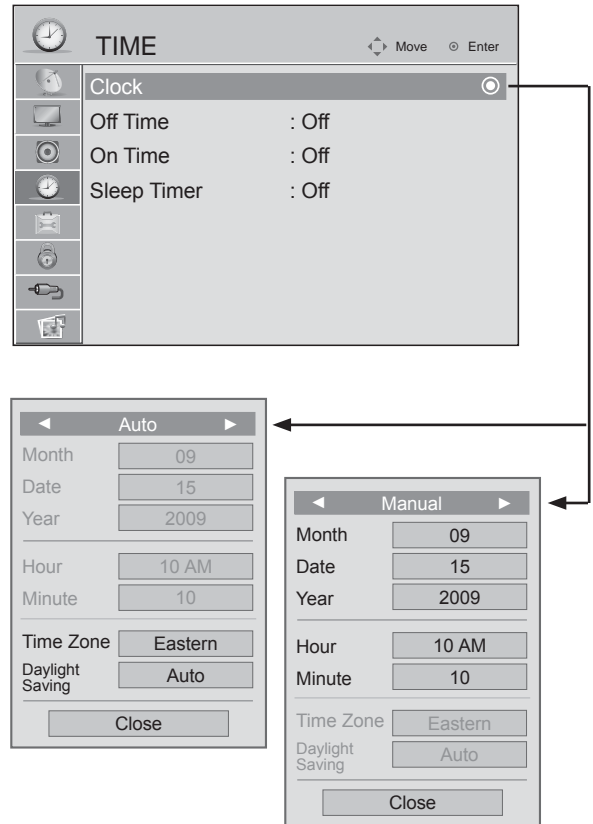

### STB On and Off Time Settings

These options enable you to set times for the STB1000 to automatically turn Off or On.

1. Press **MENU** on the Installer Remote, and use the arrow navigation keys to select/highlight the **TIME** menu option. Then, press **ENTER**.
2. Use the Up/Down arrows to select **Off Time** or **On Time**, and then press **ENTER**.
3. In the Off/On Time pop-up window, select the hour and minute and how often to repeat (Off, Once, Daily, Mon.~Fri., Mon.~ Sat., Sat.~Sun., or Sun.).
4. When you have completed the settings, select **Close** and press **ENTER** to close the pop-up window and return to the Time Menu.
5. Press **MENU** to return to TV viewing, or press **RETURN** to return to the previous menu level.

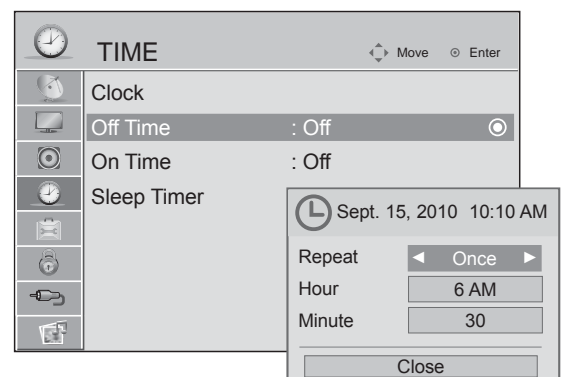

### Sleep Timer

1. Press **MENU** on the Installer Remote, and use the arrow navigation keys to select/highlight the **TIME** menu option. Then, press **ENTER**
2. Use the Up/Down arrows to select **Sleep Timer**, and then press **ENTER**.
3. In the Sleep Timer pop-up window, use the Up/Down arrows to select the desired number of minutes before the STB/display automatically turns OFF. Then, press **ENTER**.
4. Press **MENU** to return to TV viewing, or press **RETURN** to return to the previous menu level.

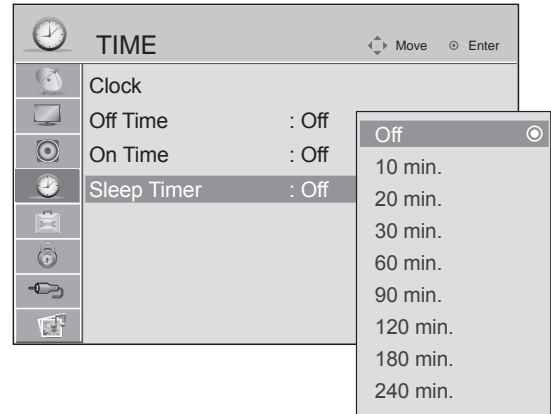

# Lock Setup Options

## Lock System Overview / Enable or Disable the Lock System

---

### Lock System Overview

Parental Control can be used to block individual channels, programs with specific ratings or in specific categories, and external viewing sources. It is also possible to block all program viewing for a time period.

The Parental Control function (V-Chip) blocks program viewing based on the ratings guidelines provided by broadcasting stations. Most television programs and television movies can be blocked by TV rating and/or individual categories. Movies that have been shown in theaters or direct-to-video movies use the Movie Rating System (MPAA) only. The default setting is to allow all programs to be viewed.

The following sections describe how to enable or disable the Lock System, how to set a password for the Lock System, and how to set up blocking schemes.

#### Notes:

- If the Lock System has been enabled previously, a password is required to gain access to the Lock Menu. The following prompt will appear when the Lock option is selected:



- The STB1000 is set up with the initial password: 0-0-0-0.
- If you forget your password, press **7-7-7-7** + **ENTER**, and set a new password at the system prompts.

### Enable or Disable the Lock System

This option allows you to enable or disable a blocking scheme.

1. Press **MENU** on the Installer Remote, and use the arrow navigation keys to select/highlight the **LOCK** menu option. Then, press **ENTER**.
2. If prompted for it, enter the Lock System password.
3. Use the Up/Down arrows to select **Lock System**, and then press **ENTER**.
4. In the Lock System pop-up window, select "On" to enable the Lock System, or select "Off" to disable the Lock System.
5. Press **MENU** to return to TV viewing, or press **RETURN** to return to the previous menu level.

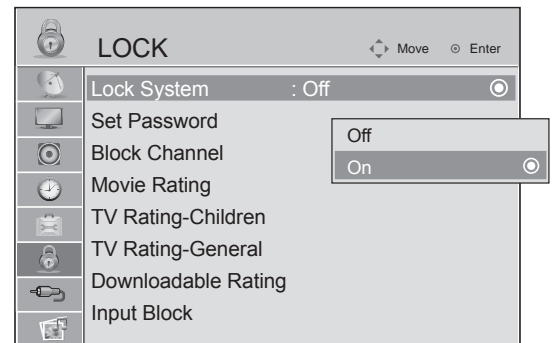



# Lock Setup Options (Cont.)

## Set Password / Channel Blocking

### Set Password

Use the following procedure to set a new password for the Lock System.

1. Press **MENU** on the Installer Remote, and use the arrow navigation keys to select/highlight the **LOCK** menu option. Then, press **ENTER**.
2. If prompted for it, enter the Lock System password.
3. Use the Up/Down arrows to select **Set Password**, and then press **ENTER**.
4. Choose any four digits for your new password. Key in the new password in the Set Password pop-up window New and Confirm fields, and then press **ENTER**.
5. Press **MENU** to return to TV viewing, or press **RETURN** to return to the previous menu level.

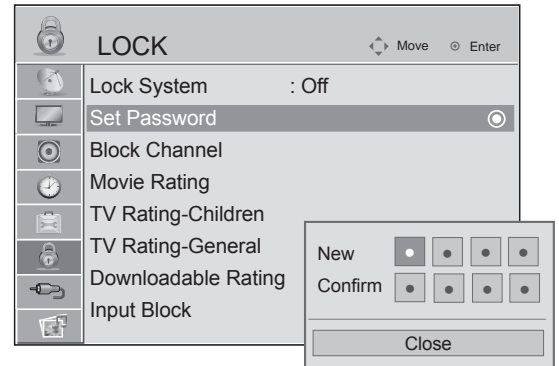

### Channel Blocking

This option enables you to block specified channels.

1. Press **MENU** on the Installer Remote, and use the arrow navigation keys to select/highlight the **LOCK** menu option. Then, press **ENTER**.
2. If prompted for it, enter the Lock System password.
3. Use the Up/Down arrows to select **Block Channel**, and then press **ENTER**.
4. In the Block Channel pop-up window, blocked channels are identified by a small lock icon to the left of the channel number. Submenu options are displayed at the bottom of the pop-up window.  
Use the arrow keys to select the Digital or Analog tab, and then select the channel to block or unblock.
5. Press the green (Block/Unblock) button on the Installer Remote to block or unblock the selected channel.
6. Repeat steps 4 and 5 to block/unblock additional channels.
7. When you are finished, press **MENU** or **ENTER** to return to TV viewing, or press **RETURN** to return to the previous menu level.

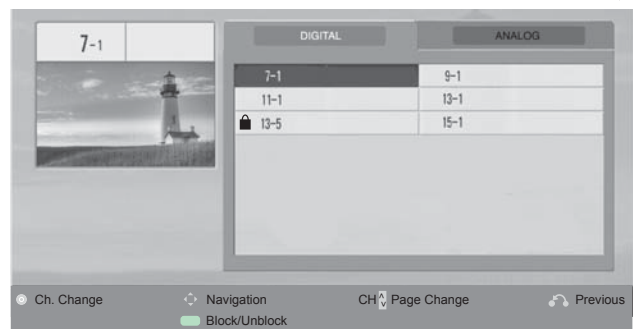
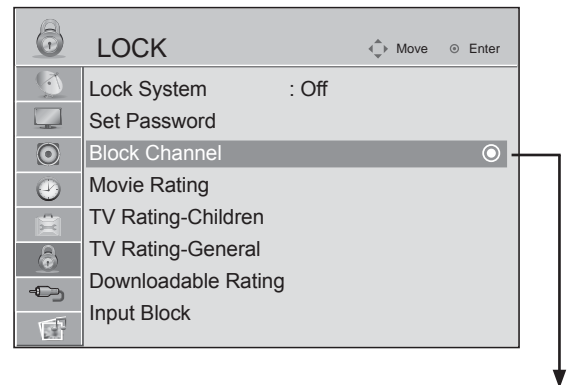

# Lock Setup Options (Cont.)

## Movie Rating / TV Rating-Children

### Movie Rating (MPAA) (for USA)

This option blocks movies according to movie ratings limits. You can set the ratings limit by blocking out all movies with ratings above a specified level. Note that the movie ratings limit only applies to movies shown on TV, not TV programs, such as soap operas.

1. Press **MENU** on the Installer Remote, and use the arrow navigation keys to select/highlight the **LOCK** menu option. Then, press **ENTER**.
2. If prompted for it, enter the Lock System password.
3. Use the Up/Down arrows to select **Movie Rating**, and then press **ENTER**.
4. Use the Up/Down arrows to select the appropriate block option from the Movie Rating pop-up window. Then, press **ENTER**. (Example: If you set the movie rating limit to PG-13, G and PG movies will be available, while PG-13, R, NC-17, and X movies will be blocked.)
5. Press **MENU** to return to TV viewing, or press **RETURN** to return to the previous menu level.

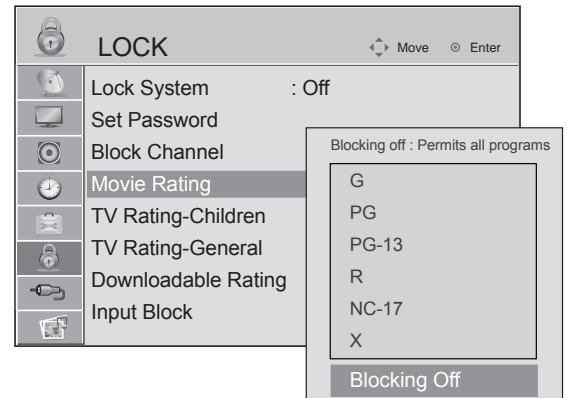

- G: General audience
- PG: Parental guidance suggested
- PG-13: Parents strongly cautioned
- R: Restricted
- NC-17: No one 17 and under admitted
- X: Adult only

### TV Rating-Children (for USA)

This option blocks children's TV programs based on ratings. Note that children's TV ratings do not apply to other TV programs. Unless you block certain TV programs intended for mature audiences (see TV Rating-General option), children can view those programs.

1. Press **MENU** on the Installer Remote, and use the arrow navigation keys to select/highlight the **LOCK** menu option. Then, press **ENTER**.
2. If prompted for it, enter the Lock System password.
3. Use the Up/Down arrows to select **TV Rating-Children**, and then press **ENTER**.
4. In the TV Rating pop-up window, use the Up/Down arrows to select **Age** or **Fantasy Violence**. Then, press **ENTER**.
  - Age: Enables you to block programming for all children or for children under 7 years of age.
  - Fantasy Violence: Enables you to block programming for children under 7 years of age.
5. In the second TV Rating pop-up window, select the desired block option, and then press **ENTER**.
6. In the initial pop-up window, select **Close** and press **ENTER** to close the pop-up window and return to the Lock Menu.
7. Press **MENU** to return to TV viewing, or press **RETURN** to return to the previous menu level.

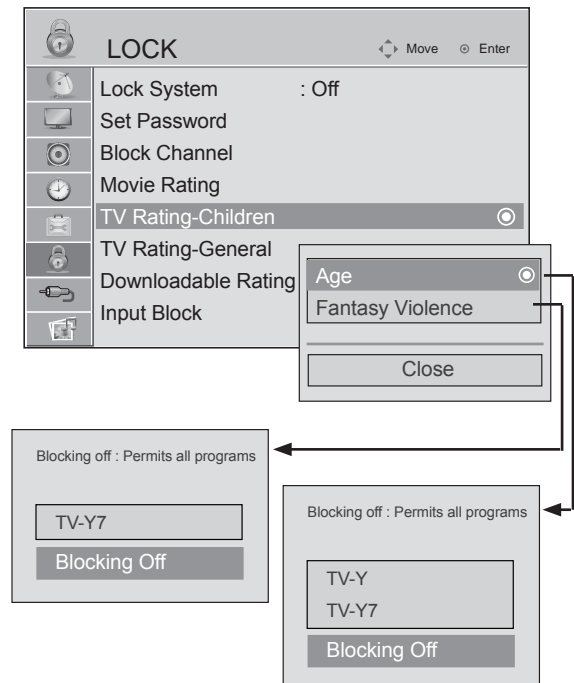

- TV-Y: All children
- TV-Y7: Children 7 years and older

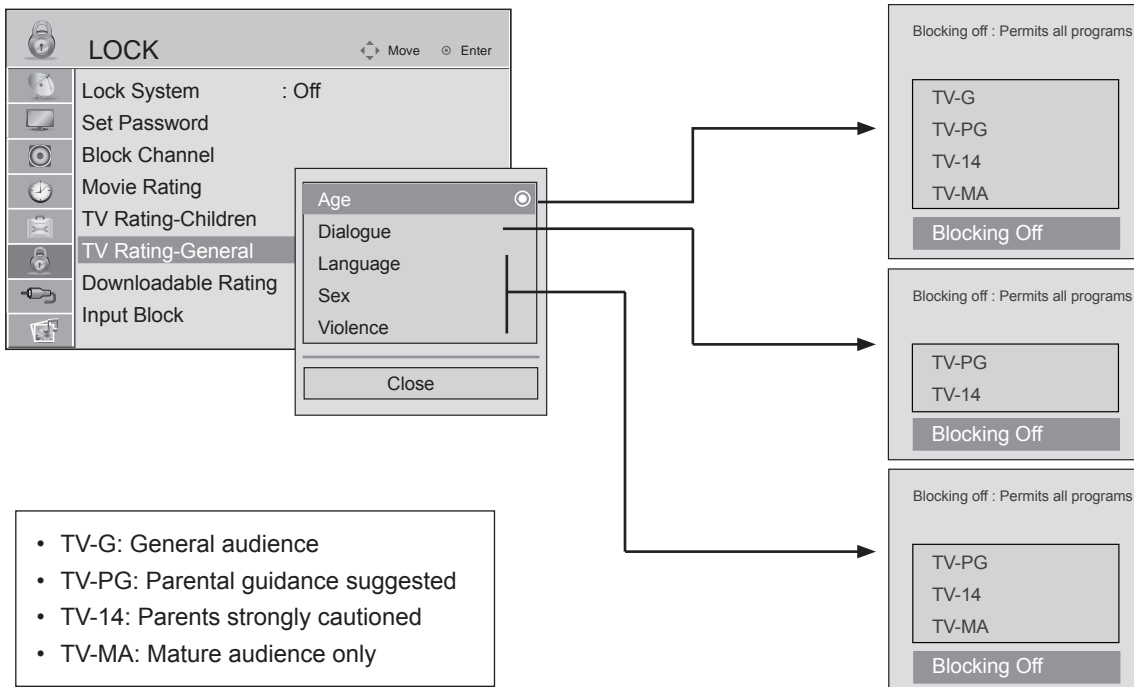

### TV Rating-General (for USA)

This option blocks TV programs based on US ratings.

1. Press **MENU** on the Installer Remote, and use the arrow navigation keys to select/highlight the **LOCK** menu option. Then, press **ENTER**.
2. If prompted for it, enter the Lock System password.
3. Use the Up/Down arrows to select **TV Rating-General**, and then press **ENTER**.
4. In the TV Rating pop-up window, use the Up/Down arrows to select a rating category. Then, press **ENTER**.
  - Age: Enables you to block programming to TV-G, TV-PG, TV-14, or TV-MA.
  - Dialogue: Enables you to block programming with sexual dialogue to TV-PG or TV-14.
  - Language: Enables you to block programming with adult language to TV-PG, TV-14, or TV-MA.
  - Sex: Enables you to block programming with sexual situations to TV-PG, TV-14, or TV-MA.
  - Violence: Enables you to block programming to TV-PG, TV-14, or TV-MA.
5. In the second TV Rating pop-up window, select the desired block option, and then press **ENTER**.
6. In the initial pop-up window, select **Close** and press **ENTER** to close the pop-up window and return to the Lock Menu.
7. Press **MENU** to return to TV viewing, or press **RETURN** to return to the previous menu level.

# Lock Setup Options (Cont.)

## TV Rating-English / TV Rating-French

### TV Rating-English (for Canada)

This option blocks TV programs based on the Canadian English rating system.

1. Press **MENU** on the Installer Remote, and use the arrow navigation keys to select/highlight the **LOCK** menu option. Then, press **ENTER**.
2. If prompted for it, enter the Lock System password.
3. Use the Up/Down arrows to select **TV Rating-English**, and then press **ENTER**.
4. Use the Up/Down arrows to select the appropriate block option from the TV Rating pop-up window. Then, press **ENTER**.
5. Press **MENU** to return to TV viewing, or press **RETURN** to return to the previous menu level.

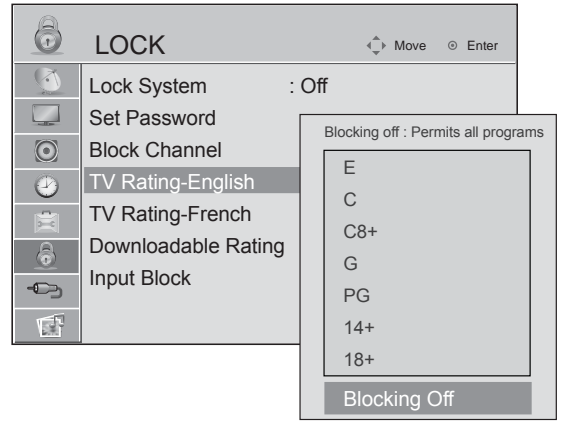

- E: Exempt
- C: Children
- C8+: Children eight years and older
- G: General audience
- PG: Parental Guidance suggested
- 14+: Viewers 14 years and older
- 18+: Adult programming

### TV Rating-French (for Canada)

This option blocks TV programs based on the Canadian French rating system.

1. Press **MENU** on the Installer Remote, and use the arrow navigation keys to select/highlight the **LOCK** menu option. Then, press **ENTER**.
2. If prompted for it, enter the Lock System password.
3. Use the Up/Down arrows to select **TV Rating-French**, and then press **ENTER**.
4. Use the Up/Down arrows to select the appropriate block option from the TV Rating pop-up window. Then, press **ENTER**.
5. Press **MENU** to return to TV viewing, or press **RETURN** to return to the previous menu level.

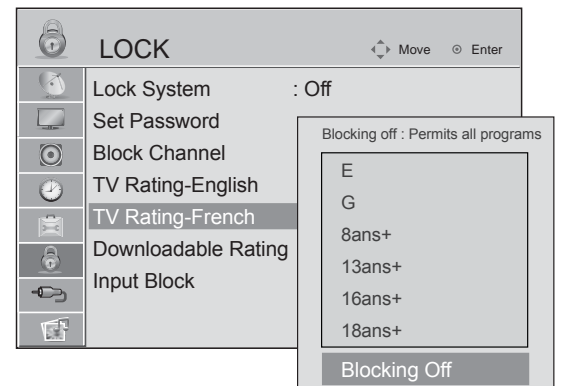

- E: Exempt
- G: General audience
- 8ans+: Children eight years and older
- 13ans+: Children 13 years and older
- 16ans+: Children 16 years and older
- 18ans+: Adult programming

# Lock Setup Options (Cont.)

## Downloadable Rating / Input Block

### Downloadable Rating

This option is available only for digital channels and operates only when the STB has received Region 5 rating data.

1. Press **MENU** on the Installer Remote, and use the arrow navigation keys to select/highlight the **LOCK** menu option. Then, press **ENTER**.
2. If prompted for it, enter the Lock System password.
3. Use the Up/Down arrows to select **Downloadable Rating**, and then press **ENTER**.
4. In the Downloadable Rating pop-up window, use the Up/Down arrows to select the desired option. Then, press **ENTER**.
5. Press **MENU** to return to TV viewing, or press **RETURN** to return to the previous menu level.

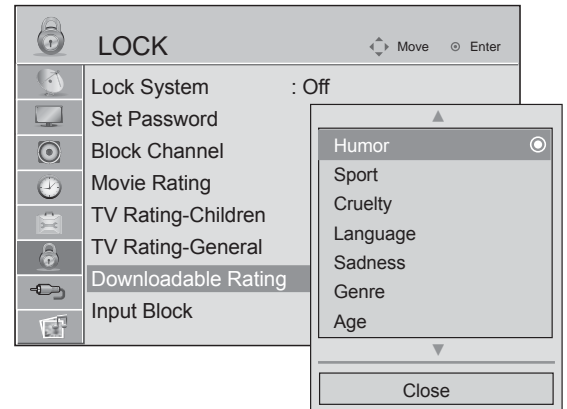

### Input Block

This option blocks an external input.

1. Press **MENU** on the Installer Remote, and use the arrow navigation keys to select/highlight the **LOCK** menu option. Then, press **ENTER**.
2. If prompted for it, enter the Lock System password.
3. Use the Up/Down arrows to select **Input Block**, and then press **ENTER**.
4. In the Input Block pop-up window, use the arrow keys to set blocking "On" or "Off," as necessary, for the individual input sources. Use the Up/Down arrows to navigate between the fields, and use the Left/Right arrows to make your selections.
5. Press **MENU** to return to TV viewing, or press **RETURN** to return to the previous menu level.

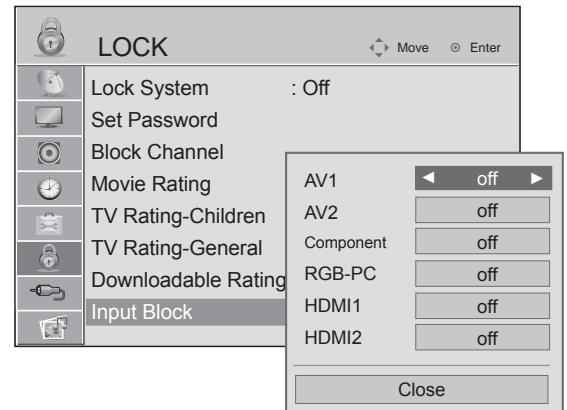

# Input Settings

---

## Select the Input Source

1. Press **MENU** on the Installer Remote, and use the arrow navigation keys to select/highlight the **INPUT** menu option. Then, press **ENTER**.
2. Use the Up/Down arrows to select the appropriate input source (see descriptions below). Then, press **ENTER**.
3. Press **MENU** to return to TV viewing, or press **RETURN** to return to the previous menu level.

### Input Source

- **TV:** Select to watch over-the-air, cable, and digital cable broadcasts.
- **AV1/AV2:** Select to watch programming from a VCR or other external equipment.
- **Component:** Select to watch programming from a DVD player or other external equipment.
- **RGB-PC:** Select to view PC input.
- **HDMI1/HDMI2:** Select to watch programming from high definition devices.

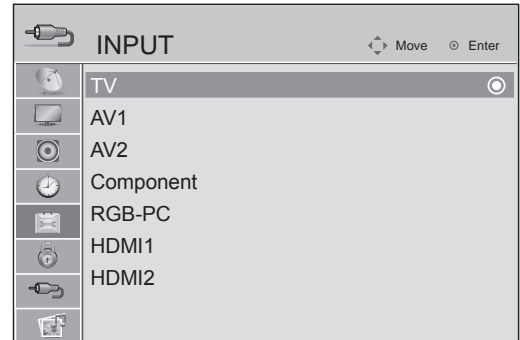

**Note:** You can also use the INPUT button on the Installer Remote to select the input source. Press **INPUT**, and then use the Left/Right arrow keys to select the desired input source from the options displayed at the bottom of the screen. Press **ENTER** to activate your selection.

## Overview

This document describes how to set up the STB1000 for Commercial Mode either while in the Embedded *b*-LAN™ (EBL) module's Pass-through Mode or its Free-To-Guest (FTG) Mode.

**Note:** The *b*-LAN module is internal to the STB1000 and allows the institution head end equipment to communicate with the STB for configuration and control. The *b*-LAN module also comprises the data tuner required for Pro:Centric operation.

## Pass-through Mode

This mode allows you to configure a Master STB1000 Setup for cloning purposes as well as external VOD/PPV control. Use the Installer Remote to configure Installer Menu items as required for STB1000 operation and set up display features (Channel, Picture, Audio, etc.). See pages 40 to 41 for detailed information.

## FTG Mode

This mode enables Pro:Idiom® decryption and also allows logical channel mapping of physical channels to remove the need for dash tuning. FTG Configuration Application software is used to configure and/or edit FTG Channel Map and FTG Installer Menu settings. See pages 58 to 61 for basic information on FTG Mode and local configuration using a PC with the FTG Configuration Application. Since the STB1000 is equipped with the EBL module, it can also be broadcast configured in FTG Mode by a Free-To-Guest Management Appliance (FMA) head end device. Refer to the ***Free-To-Guest (FTG) Configuration Application*** manual and/or the Installation & Setup manual for the FMA device.

## Installer Menu

To set up a Master STB1000, you will need to know how to enter the STB Installer Menu and make changes to the default values as required. Similarly, to configure an STB1000's Installer Menu settings in FTG Mode, you will need to know how to access and use the FTG Configuration Application utilities. If necessary, familiarize yourself with the Installer Menu and how to make and save changes. Refer to page 42 for information on accessing the Installer Menu in Pass-through Mode. Pages 43 to 48 describe Installer Menu items in detail. Refer to pages 58 to 61 for information on entering FTG Mode and using the FTG Configuration Application utilities.

## Cloning

Cloning refers to the process of capturing a Master STB1000 Setup and transferring it to a Target STB1000. The Master STB's clonable features need to be configured as part of the Commercial Mode Setup. This is a critical step. If the Master STB1000's clonable features—channel icons or labels, digital font options, etc.—are not set up correctly, the cloned STB1000s will all have problems. Pages 50 to 57 provide detailed information on cloning requirements and procedures.

# Commercial Mode Setup for Master STB1000

This section describes how to set up a Master STB1000 when the EBL is in Pass-through Mode.

**Note:** Disconnect all Aux inputs. Under certain conditions, Auto Tuning (Channel Search) is disabled if there is an Aux input active.

**Note:** Refer to “FTG Mode of Operation” on pages 58 to 61 for information on configuring/editing FTG Channel Map and Installer Menu settings for an individual STB1000 in FTG Mode.

## 1. Set Installer Menu items.

This step provides specific instruction only on the Installer Menu items that should be set on a Master TV. Refer to pages 43 to 48 for detailed information on all Installer Menu items.

- Make sure the STB1000/display panel is ON. Then, use the Installer Remote to enter the STB1000 Installer Menu: Press **MENU** repeatedly until the on-screen setup menus lock up, and then press **9-8-7-6 + ENTER**.
- Set Installer Menu item **117 FACT DEFAULT** to **001** and press **ENTER** on the Installer Remote.

This exits the Installer Menu and then clears all Installer Menu custom settings, channel labels/icons, etc. and reloads the factory default settings. The value will change back to 0 after the internal STB controller (Protocol Translator Card [PTC]) has been restored to factory default condition. This step ensures that the STB Channel Memory will be the active channel lineup.

- Re-enter the Installer Menu as described above, and set Installer Menu item **003 BAND/AFC**, as appropriate.
  - Broadcast: Set to 000.
  - CATV: Set to 001 (default).
  - HRC: Set to 002.
  - IRC: Set to 003.
- Set any other Installer Menu items that affect your TV programming network to the required configuration. For example, enable/disable Aux sources, set a Start Channel, etc.
- After you have adjusted all required Installer Menu item settings, press **ENTER** once on the Installer Remote to save your changes; then, press **ENTER** again to exit the menu.

## 2. Set up display features.

On-screen setup menus control the features of the display (see pages 15 to 38). Press **MENU** on the Installer Remote to access the setup menus, and then set Channel, Picture, Audio, Lock, Time, etc. options to the desired configurations. See also the Clonable Menu Features list on page 50.

**Note:** If desired, you can run Auto Tuning (see step 3) prior to completing this step.

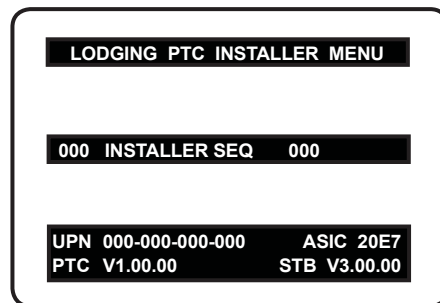

Typical STB1000 Installer Menu

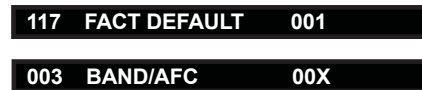

Adjust the settings for these Installer Menu items.

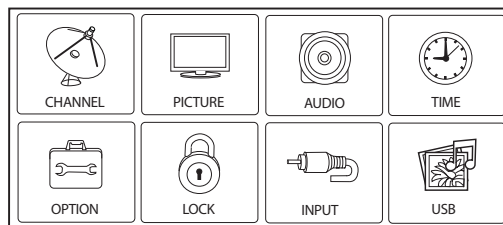

Set the display features to the desired configuration for the end user.

(Continued on next page)



# Commercial Mode Setup for Master STB1000 (Cont.)

(Continued from previous page)

## 3. Run Auto Tuning (Channel Search).

- a) Search for all available analog and digital channels: Go to the Channel Menu, select the **Auto Tuning** option, and follow the on-screen instructions.
- b) Use the **Channel Edit** option in the Channel Menu to edit the channel lineup, as necessary, to include free to guest channels only.
  - Add/delete channels per your system requirements. Note that physical channel numbers are used to identify virtual channels. Also, channel numbers cannot be higher than 255.
  - Use the **Channel Label** option in the Channel Menu to add familiar channel trademarks/logos such as ABC, CBS, NBC, etc. to the Channel-Time on-screen display. Identifiable labels (logos) should enable the end user to readily know what common networks are available. (You can add the channel labels in this step, or you can add channel logos or labels for channels without icons in step 5.)

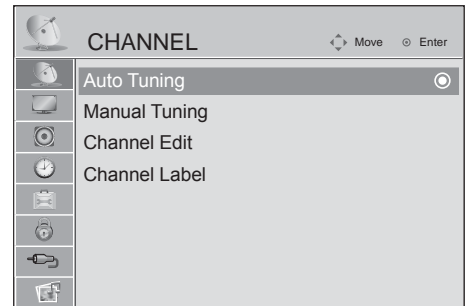

Run Auto Tuning, edit channels, and select familiar channel trademarks/logos using Channel Menu options.

## 4. Transfer the STB1000 Setup to the internal STB Controller (PTC): 2-5-5 + MENU Mode

After the STB channel lineup has been edited and channel labels added, enter the Installer Menu. Once in the Installer Menu, press **2-5-5 + MENU** on the Installer Remote to initiate the transfer of the Master STB Setup to the PTC. The STB exits the Installer Menu and then tunes through the channels in the channel lineup during the transfer. When the transfer is complete, the STB tunes back to the channel that was tuned before the transfer began.

**Note:** The maximum number of active channels that can be transferred is 141. Total channels numbering more than 141 will result in erratic STB operation.

## 5. Add Custom Channel and Aux Source Labels for Analog Channels: 2-5-4 + MENU Mode

Enter the Installer Menu, and press **2-5-4 + MENU** on the Installer Remote. Add/edit custom text labels to channel on-screen displays. Note that digital channels often have a broadcaster generated label (see 2-5-4 + MENU procedural information on page 49). When you are finished, press **MENU** to exit 2-5-4 + MENU Mode.

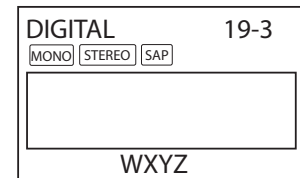

Custom Text Label "WXYZ" created in 2-5-4 + MENU (Add Channel Label) Mode.

## 6. Verify the STB1000 setup.

At this point, verify that the channel lineup, channel icons, and custom labels are correct. Make sure the display features are set per your requirements.

## 7. Lock the channel lineup.

Enter the Installer Menu. Then, set item **028 CH. OVERRIDE** to **000** and press **ENTER** to lock the channel lineup and restrict access to the STB1000 setup menus. Press **ENTER** again to save your changes and exit the Installer Menu.\*

The Master STB1000 Setup is now ready to be copied to a USB memory device or a clone programmer (see cloning information in this document).

**028 CH. OVERRIDE 000**

After verifying the STB Setup, set Installer Menu item 028 CH. OVERRIDE to 000.\*

\* This step prevents end users from accessing channel settings (i.e., the Channel Menu will be inaccessible/grayed out).

# Installer Menu

---

Use the Installer Menu to set up or change operational settings. Refer to the table starting on the next page for brief descriptions of Installer Menu items. More detailed descriptions follow the table listing.

## Accessing the Installer Menu

1. Make sure the STB1000/display panel is ON.
2. Using the Installer Remote, press **MENU** repeatedly until the on-screen setup menus lock up, and then press **9-8-7-6 + ENTER** to access the Installer Menu.

The Installer Menu opens with item 000 INSTALLER SEQ 000.

## Using the Installer Menu

Items 000 ~ 119 are accessible only upon entering the Installer Menu. Refer to the table on pages 43 and 44 for an overview of Installer Menu items, including item numbers, functions, ranges, and default values. Installer Menu items not relevant to the STB1000 are not present on the Installer Menu; therefore, some numbers are missing. For example, item 006 will not appear.

## Navigation within the Installer Menu

Use the Up/Down arrow keys on the Installer Remote to sequence through the available menu items, or access an item directly by keying in the line number and then pressing **MENU**. For example, to access the SLEEP TIMER option, which is item 015, press 0-1-5 + MENU.

## Changing Installer Menu Settings

To change an Installer Menu item setting, use the Left/Right arrow keys on the Installer Remote, or enter a value directly. Press **ENTER** to save the new setting, or use the Up/Down arrow keys to navigate to a new Installer Menu item if you have additional items to edit.

## Exiting the Installer Menu and Activating Updates

After you have adjusted all required Installer Menu item settings, press **ENTER** once on the Installer Remote to save your changes; then, press **ENTER** again to exit the Installer Menu. Any changes you make will be stored in non-volatile memory.

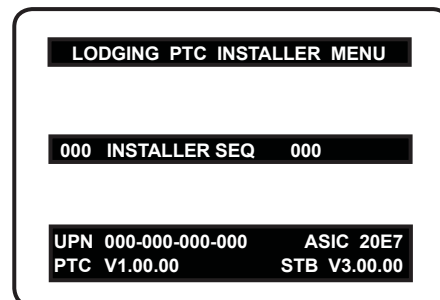

Typical STB1000 Installer Menu

# Installer Menu (Cont.)

## Installer Menu Items 000 through 071

Menu Item	Function	Value Range	Default Value	Brief Description of Function and Comments
000	INSTALLER SEQ	0 ~ 3	0	Leave default set to 0.
001	POWER MANAGE	0 ~ 7	0	Sets number of hours of no activity before automatic shutoff.
002	AC ON	0 / 1	0	Set to 1 to enable Auto Turn ON when AC power is applied.
003	BAND/AFC	0 ~ 3	1	Selects Tuning Band: 0=Broadcast, 1=CATV, 2=HRC, 3=IRC
004	STRT CHANNEL	0 ~ 127, 255	255	Channel tuned when STB is turned ON. (Set to 255 to tune to channel tuned before STB turned OFF.)
005	CHAN LOCK	0 / 1	0	If set to 1, cannot tune from current channel.
007	STRT VOLUME	0 ~ 63, 255	255	Volume level when STB is turned ON. (Set to 255 to use volume level before STB turned OFF.)
008	MIN VOLUME	0 ~ 63	0	Sets minimum allowable volume setting.
009	MAX VOLUME	0 ~ 63	63	Sets maximum allowable volume setting.
010	MUTE DISABLE	0 / 1	0	Set to 1 to disable Mute Function.
015	SLEEP TIMER	0 / 1	1	Set to 1 to enable Sleep Timer.
016	EN TIMER	0 / 1	0	Set to 1 to enable On/Off Timers.
017	ALARM	0 / 1	1	Set to 1 to enable Alarm.
021	V-CHIP	0 / 1	1	Set to 1 to enable V-Chip (Parental Control) functions.
022	MAX BLK HRS	0 ~ 99	12	Sets number of V-Chip blocking hours.
023	CAPTION LOCK	0 / 1	0	Set to 1 to retain caption setting set before STB turned OFF.
028	CH. OVERRIDE	0 / 1	1	If set to 0, limits direct access to favorite channels.
029	OLD OCV	0 / 1	0	Set to 1 to change MPI operation to OCV.
030	ACK MASK	0 / 1	0	If set to 1, changes MPI for some OCV boxes.
031	POLL RATE	20 ~ 169	94	Selects poll rate for MPI.
032	TIMING PULSE	186 ~ 227	207	Sets baud rate for MPI.
034	CAMPORT EN	0 / 1	1	Set to 1 to enable Video 2 input.
035	COMPPOINT EN.	0 / 1	1	Set to 0 to disable HDMI 1. Set to 1 enable HDMI 1.
038	YPrPb EN.	0 / 1	1	Set to 1 to enable display panel Component Video 1 input jacks.
039	REAR AUX EN	0 / 1	1	Set to 1 to enable display panel Video 1 input jack.
040	AUTO CAMPORT	0 / 1	1	Set to 1 to automatically switch to Camport. If set to 1, STRT AUX SRCE cannot be set to 2.
046	STRT AUX SRCE	1 ~ 6, 255	6	Sets the starting Aux source (if item 004 STRT CHANNEL is set to 0).
047	AUX STATUS	0 / 1	0	Set to 1 for MPI Aux source to be reported as a channel number instead of Channel 0.
053	DIS. CH-TIME	0 / 1	0	Set to 1 to disable Channel-Time display.
069	EN. CH-T COL.	0 / 1	1	Set to 1 to enable custom color for the Channel-Time display.
070	FOR. CH-TIME	0 ~ 7	2	Chooses custom foreground color for the Channel-Time display.
071	BCK. CH-TIME	0 ~ 7	2	Chooses custom background color for the Channel-Time display.

## Installer Menu (Cont.)

### Installer Menu Items 073 through 119

Menu Item	Function	Value Range	Default Value	Brief Description of Function and Comments
073	CH NOT AVBLE	0 / 1	0	If set to 1 and Channel Override is 0, "NOT AVAILABLE" message is displayed when directly accessing a channel not in the favorite Channel List.
075	REVERT CH	0 / 1	0	If set to 1 and loss of MPI communication occurs, STB tunes to Start Channel.
078	UPN MSB	0 ~ 255	0	User programmable number, most significant byte.
079	UPN MSB-1	0 ~ 255	0	User programmable number, most significant byte - 1.
080	UPN MSB-2	0 ~ 255	0	User programmable number, most significant byte - 2.
081	UPN LSB	0 ~ 255	0	User programmable number, least significant byte.
082	CHKSM ERROR	0 / 1	1	Enforces rigid MPI checksum.
083	HANDSHK TIME	0 ~ 5	5	Relaxes MPI timing to be compatible with PC-based Windows-controlled systems.
084	PERMANENT BLK	0 / 1	0	Removes block hours setting for Parental Control and makes block permanent.
087	REAR RGB EN.	0 / 1 / 17	1	Dependent on item 093 RJP AVAILABLE setting. Set to 0 to disable RGB input. Set to 1 to enable RGB input. Set to 17 for Auto Configure.
088	EN NOISE MUTE	0 / 1	1	If set to 1, audio is muted if no signal is present.
090	KEY LOCK	0 / 1	1	If set to 1, keyboard is locked out, IR is still functional.
091	YPrPb2 EN	0 / 1	1	Set to 1 to enable HDMI 2 input.
093	RJP AVAILABLE	0, 1, 2, 5, 6	0	Set to 0 to disable. Set to 1, 2, 5, or 6 for HDMI or DVI Mode. (See detailed descriptions.)
094	SAP MENU EN	0 / 1	1	Set to 0 to disable feature on Function Menu. Set to 1 to enable feature on Function Menu.
096	DEF. ASP. RATIO	0 ~ 4	2	Sets default aspect ratio at power up. See detailed descriptions and item 106.
102	ATSC BAND	0 ~ 4	4	Selects ATSC band.
103	ATSC TUNE MODE	0 / 1	1	Set to 1 (default) for Physical Channel scan. Set to 0 for Virtual Channel scan.
104	START MINOR CH	0 ~ 255	0	Selects Minor Start Channel. Set to 0 for NTSC.
106	ASP RATIO LOCK	0 / 1	0	To retain set aspect ratio on power cycle, set to 1. Set to 0 for default ratio on power cycle.
108	PANEL COM	0 ~ 3	2	Sets display panel baud rate: 0 = 1200, 1 = 2400, 2 = 9600, 3 = 115200
110	PANEL DELAY	0 ~ 15	8	Sets the display panel communication delay time.
111	PANEL VOL PRE	0 ~ 100	79	Preset panel volume to achieve volume levels in parallel with external equipment.
113	PANEL TYPE	0 ~ 4	2	Selects display panel type. (See detailed descriptions.)
116	VIDEO MUTE EN	0 / 1	0	Set to 0 for Normal. Set to 1 for Blank.
117	FACT DEFAULT	0 / 1	0	Set to 0 for Normal. Set to 1 to load presets for all Installer Menu settings.
118	POWER SAVINGS	1 / 3	3	Set to 3 (default— <i>b</i> -LAN module only powered when STB is turned ON), or set to 1 ( <i>b</i> -LAN module is always powered).
119	DATA CHANNEL	0 ~ 135	0	Set to 0 to disable. Set to the RF channel number of the Data Channel for Pro:Centric or E-Z Installation data. (See detailed descriptions.)

## Detailed Descriptions of Installer Menu Items

### 000 - INSTALLER SEQUENCE

Specifies entry sequence to the Installer Menu.

0 = 9876	1 = 4321
2 = 1478	3 = 3698

### 001 - POWER MANAGE (Power Management)

Determines hours of no activity before automatic shutoff. The Power Management function is for saving energy. If set to 0, Power Manage is Off. Settings range from 0 ~ 7, with 1 ~ 7 representing the hours that the unit will remain ON, unless there has been activity from either the control panel or remote control.

### 002 - AC ON (AC Power Switchable)

If set to 1, this allows the STB to turn ON when AC power is applied. Pressing the ON button is not necessary. This is desirable if the STB is plugged into a cable box or a power outlet controlled by a wall switch. Use the Left/Right arrow keys to choose 0 or 1, where 0 is the default (OFF), and 1 is ON.

**Note:** If set to 1 (ON), the STB does not respond to On/Off commands from either the remote or the display control panel, and the SLEEP TIMER is also nonfunctional.

### 003 - BAND/AFC (Band/Automatic Frequency Control)

There are four possible settings for this option:

0 = Broadcast	1 = CATV (default)
2 = HRC	3 = IRC

If some channels were not found by Auto Tuning (Channel Search), select the appropriate Band setting here, and add the channels using the Channel Edit option in the Channel Menu.

### 004 - STRT CHANNEL (Start Channel)

If active, this function allows you to determine the initial channel number when the STB is turned ON. This feature is useful for an in-house information channel, since the STB would always select that channel when it is turned ON. Setting this to 255 causes the last channel viewed when the STB was turned OFF, to be the tuned to channel when the STB is turned ON again.

**Note:** For a digital Start Channel, always remember to set item 104 to the Minor Start Channel number.

255 = Last channel	1 ~ 125 = Major Ch. #	0 = Aux
126 Map to Channel 3.	127 Map to Channel 4.	

### 005 - CHAN LOCK (Channel Lock)

Channel Lock is ideal if the system must always be on the same channel. Changing channels with the Channel Up/Down or keypad numbers is impossible. Channel Lock is inactive if set to 0 (default).

Generally, this feature is used in connection with STRT CHANNEL (Installer Menu item 004) where the Start Channel may, for example, be set to 3 or 4. If the Start Channel is 3, then the STB will remain locked on channel 3.

**NOTE:** For items 007, 008, and 009

For legacy reasons, the scale used is 0–63. The PTC software will translate this to the 0–100 scale used by the STB.

To translate an STB volume level to the Installer Menu value, use the following formula:

$$\text{Installer Value} = \frac{\text{STB Value} \times 63}{100}$$

Enter only the whole number (disregard fractions).

### 007 - STRT VOLUME (Start Volume)

This function allows the Installer to determine the initial volume level setting when the STB is turned ON. This feature is useful for an in-house information channel, since the STB would always select that volume level when it is turned ON. The range of values is 0 - 63, 255. If 255 is selected, the current volume level will be retained in memory when the STB is turned OFF; at turn ON, the volume level will be automatically set at the previous or last level.

### 008 - MIN VOLUME (Minimum Volume)

This function determines the minimum volume level allowable with the Volume (VOL) Up/Down control. In this way, for example, someone cannot set the volume too low to hear. The value range is from 0 to 63. Use the Left/Right arrow keys to change values. The factory default is 0, which provides the full range of volume control, if item 009 MAX VOLUME is also set to 63. It may be best to set the same value on every STB.

**Note:** The minimum volume level cannot have a value setting higher than the maximum volume level (described below).

### 009 - MAX VOLUME (Maximum Volume)

This function determines the maximum volume level allowable with the Volume (VOL) Up/Down control. In this way, for example, someone cannot set the volume level high enough to disturb others. The value range is 0 to 63, with 63 as the default, which gives the user the full range of volume control, if item 008 MIN VOLUME is also set at 0. Use the Left/Right arrow keys to change values. It may be best to set the same value on every STB.

**Note:** The maximum volume level cannot have a value setting lower than the minimum volume level (described above).

### 010 - MUTE DISABLE

Enables or disables sound mute function. If set to 1, sound cannot be muted. If set to 0, sound can be muted.

### 015 - SLEEP TIMER

If set to 1, the Sleep Timer feature may be used. If set to 0, the Sleep Timer is not available.

# Installer Menu (Cont.)

---

## **016 - EN TIMER (Enable On/Off Timers) \***

If set to 1, the Timer function is available to the end user and enabled continuously. Set to 0 to disable On/Off Timers.

**Note:** Clock must be set in order to use timers.

## **017 - ALARM \***

Gives the installer the option of making the Alarm function available to the end user. If set to 1, the Alarm function is available to the end user. Set to 0 to disable the Alarm function.

**Note:** Clock must be set before the Alarm function will work.

## **021 - V-CHIP (Parental Control) \***

Set to 1 to activate V-Chip (Parental Control) and have it available to the end user to filter and control or otherwise restrict programming content that can appear. Set to 0 to turn the V-Chip feature Off (not available to user); no programming restrictions can be set.

## **022 - MAX BLK HRS (Maximum Block Hours) \***

Sets hours from 0 to 99 for the maximum V-Chip (Parental Control) block hours. Default setting is for 12 blocking hours.

## **023 - CAPTION LOCK**

If set to 0, captions are OFF when the STB is turned ON. Set to 1 to use the caption setting configured before the STB was turned OFF when the STB is turned ON.

## **028 - CH. OVERRIDE (Channel Override)**

If set to 1, the user can select channels with either Channel Up/Down or by direct keypad entry. If set to 0, only those channels that are active in the STB's memory can be selected.

## **029 - OLD OCV (On Command Video™)**

Set to 1 for operation with systems from On Command Corporation.

## **030 - ACK MASK**

MPI Communication Parameter. Leave at default setting unless changed by Pay-Per-View provider. When set to 1, changes MPI for some OCV boxes.

## **031 - POLL RATE**

MPI Communication Parameter. Selects Poll Rate for MPI. Leave at default setting unless changed by Pay-Per-View provider. Step size of 16 ms.

## **032 - TIMING PULSE**

MPI Communication Parameter. Leave at default setting unless changed by Pay-Per-View provider. Sets baud rate. Step size of 4.3 uS.

## **034 - CAMPORT EN. (Camera Port Enable)**

Set to 1 to enable Video 2 input on display panel. If set to 0, Video 2 input on display panel is not functional.

## **035 - COMPPORT EN. (Computer Port Enable)**

Enable/disable STB HDMI 1 input jack. Set to 0 to disable HDMI1. Set to 1 to enable HDMI1.

**Note:** This setting is ignored if item 093 RJP AVAILABLE is set to 1.

## **038 - YPrPb EN. (Rear Component Video Enable)**

Set to 1 to enable display panel rear Component Video input jacks. Set to 0 to disable display panel rear Component Video input jacks.

## **039 - REAR AUX EN. (Rear Aux Enable)**

Set to 1 to enable display panel rear Aux (Video 1) input. Set to 0 to disable display panel rear Aux (Video 1) input.

## **040 - AUTO CAMPORT**

Set to 1 to automatically switch to Camport when equipment is connected to Video input on the STB rear panel. Set to 0 to disable STB rear panel Video automatic source selection.

**Note:** If set to 1, item 093 RJP AVAILABLE is automatically set to 0 and item 046 STRT AUX SRCE cannot be set to 2.

## **046 - STRT AUX SRCE (Start Aux Source)**

Sets the starting Aux source. When turned ON, the STB will tune to starting Aux source if item 004 STRT CHANNEL is set to 0.

If item 093 RJP AVAILABLE is set to 0 and item 040 AUTO CAMPORT is set to 0:

1 = Video 1	4 = RGB	255 = Last Aux
2 = Video 2	5 = HDMI 2	
3 = HDMI 1	6 = Component	

If item 093 RJP AVAILABLE is set to 1:

2 = Video 2	5 = HDMI 2	6 = Component
-------------	------------	---------------

If item 040 AUTO CAMPORT is set to 1:

1 = Video 1	5 = HDMI 2
3 = HDMI 1	6 = Component
4 = RGB	

## **047 - AUX STATUS**

Set to 1 for MPI Aux source to be reported as a channel number instead of channel 0. Set to 0 to disable Aux identification change. Controls MPI status channel response for Aux inputs.

## **053 - DIS. CH-TIME (Disable Channel-Time)**

Set to 1 to disable the Channel-Time display; Channel-Time display will not appear. Set to 0 to enable the Channel-Time display.

## **069 - EN. CH-T COL. (Enable Channel-Time Custom Color)**

Set to 1 to enable custom color for the Channel-Time display. Set to 0 to disable custom color for the Channel-Time display.

\* Only affects Function Menu if enabled by some PPV providers.

## 070 - FOR. CH-TIME (Channel-Time Display Foreground Color)

Set according to Color Chart:

0 = Black	3 = Cyan	6 = Yellow
1 = Blue	4 = Red	7 = White
2 = Green	5 = Violet	

**Note:** Applies only to "Channel Not Available" message if item 073 is set to 1 (enabled). If foreground color and background color are the same, the menu background will be transparent.

## 071 - BCK. CH-TIME (Channel-Time Display Background Color)

Set according to Color Chart:

0 = Black	3 = Cyan	6 = Yellow
1 = Blue	4 = Red	7 = White
2 = Green	5 = Violet	

**Note:** Applies only to "Channel Not Available" message if item 073 is set to 1 (enabled). If foreground color and background color are the same, the menu background will be transparent.

## 073 - CH NOT AVBLE (Channel Not Available)

If set to 1 and item 028 CH. OVERRIDE is set to 0, a "NOT AVAILABLE" message is displayed when directly accessing a channel not in the channel scan list available in memory.

## 075 - REVERT CH (Revert to Start Channel)

If set to 1 and loss of MPI communication occurs, STB automatically tunes to the specified Start Channel.

## 078 - UPN MSB (UPN Most Significant Byte)

User programmable number, most significant byte readable by MPI command. Not linked to serial number.

## 079 - UPN MSB-1 (UPN Most Significant Byte-1)

User programmable number, most significant byte-1 readable by MPI command. Not linked to serial number.

## 080 - UPN MSB-2 (UPN Most Significant Byte-2)

User programmable number, most significant byte-2 readable by MPI command. Note: Not linked to serial number.

## 081 - UPN LSB (UPN Least Significant Byte)

User programmable number, least significant byte readable by MPI command. Note: Not linked to serial number.

## 082 - CHKSM ERROR (Checksum Error)

Enforces rigid MPI checksum validation. Set to 1 for validation. Set to 0 to disable (does not check checksum on MPI async port). SPI is always checked.

## 083 - HANDSHK TIME (Handshake Time)

Adds an additional delay to the handshake time which is 64 msec, thus relaxing MPI timing requirements to be compatible with PC-based Windows controlled systems. Range is 0 - 5. (Timeout = 25.5MS + [25.5 MS\* Handshake time].)

## 084 - PERMANENT BLK (Permanent Block)

Allows Lock (Parental Control) blocking schemes to be permanent by disabling the blocking hours function. Set to 1 to install Parental Control restrictions permanently. Set to 0 for user-specified hours control of blocking schemes.

## 087 - REAR RGB EN. (Rear RGB Enable)

Controls access to the RGB input on STB jack panel. Set to 0 to disable RGB input. Set to 1 to enable RGB input. Set to 17 to initiate a one-time automatic configuration after an AC power cycle; otherwise, automatic adjustment will be performed each time the RGB input is accessed.

## 088 - EN NOISE MUTE (Enable Noise Mute)

If set to 1, audio mutes if no signal is present.

## 090 - KEY LOCK

If set to 1, display panel Channel, Volume, and Captions buttons are disabled, Power button remains enabled. If set to 0, display panel Channel, Volume, Captions and Power buttons are all enabled.

## 091 - YPrPb2 EN. (HDMI2 Enable)

Set to 0 to disable STB HDMI2 input. Set to 1 to enable DTV mode. Set to 2 to enable PC mode.

## 093 - RJP AVAILABLE (Remote Jack Pack Available)

- 0 = Remote jack pack is not available or disabled.
- 1 = Legacy Model RJPs: HDMI Mode  
Enables RJP feature for use with full cable bundle models. In this mode, when an HDMI source is connected to the RJP, both digital video and audio are expected via the HDMI cable. If no digital audio is present, no audio will be heard.
- 2 = Legacy Model RJPs: DVI Mode  
Enables RJP feature for use with full cable bundle models. In this mode, when an HDMI/DVI source is connected to the RJP, only digital video is expected via the HDMI cable. Analog audio is provided via a separate cable, from the source, connected to an RJP AUDIO IN. If no analog audio cable is connected, tuner audio will be heard.
- 5 = Scaler Model RJPs: HDMI Mode  
Enables RJP feature for use with reduced cable bundle models. In this mode, when an HDMI source is connected to the RJP, both digital video and audio are expected via the HDMI cable. If no digital audio is present, no audio will be heard.

# Installer Menu (Cont.)

---

- **6 = Scaler Model RJP: DVI Mode**  
Enables RJP feature for use with reduced cable bundle models. In this mode, when an HDMI/DVI source is connected to the RJP, only digital video is expected via the HDMI cable. Analog audio is provided via separate cable, from the source, connected to an RJP AUDIO IN. If no analog audio cable is connected, tuner audio will be heard.

## Notes:

See Reference section, "RJP Model List and Input Auto-sensing Hierarchy." If RJP AVAILABLE is set to 1, 2, 5, or 6, item 040 AUTO CAMPORT is automatically set to 0. Settings 1, 2, 5, and 6 allow the lodge staff to customize each STB's RJP setup based on customer requirements.

## 094 - SAP MENU EN (2nd Audio Program)

Set to 1 to enable SAP feature on Function Menu, if Function Menu is available. Set to 0 to disable SAP feature on Function Menu, if Function Menu is available.

## 096 - DEF. ASP. RATIO (Default Aspect Ratio)

Selects default aspect ratio at power up.

- Set to 0 for Set By System.
- Set to 1 for 4:3.
- Set to 2 for 16:9 (Factory Default).
- Set to 3 for Just Scan.
- Set to 4 for Zoom.

**Note:** Only applies if item 106 ASP RATIO LOCK is disabled, set to 0.

## 102 - ATSC BAND

Sets up STB to receive different types of incoming signals:  
0 = Broadcast, 1 = CATV, 2 = HRC, 3 = IRC, 4 = Same as NTSC.

## 103 - ATSC TUNE MODE

Sets ATSC tuning mode: Default set to 1 for Physical Channel scan. Set to 0 for Virtual Channel scan.

## 104 - START MINOR CHANNEL

Sets Minor Start Channel number at power up. 0 = NTSC. If not 0, number selected is the digital channel's Minor Start Channel number.

## 106 - ASP RATIO LOCK (Aspect Ratio Lock)

Set to 1 to retain previous aspect ratio with power off. Set to 0 to retain default aspect ratio with power off. See item 096 DEF. ASP. RATIO above.

## 108 - PANEL COM (Panel Communication)

Sets the display panel baud rate:  
0 = 1200, 1 = 2400, 2 = 9600 (default), 3 = 115200

## 110 - PANEL DELAY

Sets the delay time in seconds before the STB initiates RS-232 communication with the display panel after the STB/display is turned ON. 8 seconds is the default.

## 111 - PANEL VOL PRE (Panel Volume Preset)

Preset the display panel volume to achieve volume levels in parallel with external equipment. 79 is the default.

## 113 - PANEL TYPE

Selects the display panel type. See Reference section, "Display Panel Type Specifications" to determine the appropriate setting for the display panel being used. (Reference section, "RS-232 Display Panel Requirements," also provides a list of compatible displays.)

## 116 - VIDEO MUTE EN (Video Mute Enable)

Set to 0 for Normal. Set to 1 for Blank.

## 117 - FACT DEFAULT (Factory Default)

Set to 0 for normal. Set to 1 to load presets of all Installer Menu item settings.



**Warning: If set to 1, this will reload the factory defaults and clear the Channel List, including any assigned channel icons and custom channel labels.**

## 118 - POWER SAVINGS

Default is set to 3. When the STB is in Standby mode, the MPI card slot is powered by the Standby power supply and embedded *b*-LAN is not powered. When the STB is in Power On mode, the MPI card slot is powered by the main 12V power supply and embedded *b*-LAN is powered. Note that the STB must be turned ON in order to communicate with the embedded *b*-LAN module for configuration and control when POWER SAVINGS is set to 3.

- 1 = MPI card slot Standby Mode power provided from Standby power supply, and embedded *b*-LAN is always powered.
- 3 = MPI card slot Standby Mode power provided from Standby power supply, and embedded *b*-LAN is only powered when the STB is turned ON.

**Note:** See Reference section, "*b*-LAN Setup and Overview," for further information.

## 119 - DATA CHANNEL

Set to 0 (default) to disable. Set to the RF channel number of the Data Channel for Pro:Centric or E-Z Installation (splash screen, configuration, or firmware) data. The STB may take several minutes to load EPG data after AC power is initially applied.



# Adding Channel Label Icons / Custom Channel Labels (2-5-4 + MENU Mode)

## Editing/Adding Channel Icons and/or Labels

If there is no pre-assigned icon, you can make a custom channel label of up to seven (7) characters to help identify a channel or network. If desired, channel labels can also be added in addition to a pre-assigned icon. You may also add labels for the Aux input sources to clearly identify the devices that are connected to the Aux inputs.

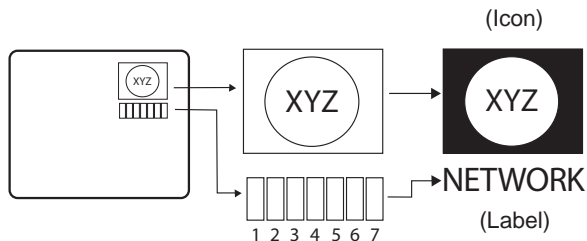

Editing and adding the labels can only be done if there are channels entered into the STB's Channel Map either during Commercial Mode Setup (see pages 40 to 41), by cloning, or by using some PPV providers' master remote controls.

**Note:** A blank letter space is available between "Z" and "I".

## To perform channel editing/labeling:

1. Enter the STB Installer Menu: Press **MENU** repeatedly until the on-screen setup menus lock up, and then press **9-8-7-6 + ENTER**.
2. Press **2-5-4 + MENU** on the Installer Remote to enter the Channel Label Editing Mode.
3. Add channel icons and channel labels as described in the procedures below. (You can do this more than once.)
4. To exit the menu when you are done, press **MENU**.

## Changing a Channel's Icon on the Master STB1000

1. Use Channel Up/Down to select the desired channel.
2. Use the Left/Right arrow keys to select the thin letter "I" on the Channel ID display.
3. Use the Up/Down arrow keys to select the icon with which you want to identify the channel. (If you know the icon number, enter the number, and press **ENTER**.)
4. Proceed to change/add channel labels, or go to the next channel.

## Changing/Adding Channel Labels on the Master STB1000

1. Use Channel Up/Down to select the desired channel.
2. Press the Left or Right arrow repeatedly until the numbers 1 to 7 appear on the display. The number shows the position of the character that can be changed. Number 1 is the first character, number 2 the second character, etc.
3. Use the Up/Down arrow keys to select the desired character.
4. Proceed to the next number position, or use Channel Up/Down to go to the next channel.

## Changing Source Labels on the Master STB1000

1. Press **INPUT** to select the desired Aux input source: A/V 1, A/V 2, HDMI Component, RGB, etc.
2. Press the Left or Right arrow repeatedly until the numbers 0 to 9 appear on the display. The number shows the position of the character that can be changed.
3. Use the Up/Down arrow keys to select the desired character.
4. Press **INPUT** for the next Aux source, or use Channel Up/Down to return to channels.

## Installer Remote Control Key Functions for Master STB1000 Channel Editing/Labeling Menu

- **Channel Up/Down:** Tunes in the next channel in scan.
- **Left/Right Arrows:** Select the item to change. If "I" is shown, the icon can be changed. If a number is shown, it indicates the position of the character that can be changed.
- **Up/Down Arrows:** Select the icon or the character to be displayed. Tip: Arrows can be held down for fast scrolling.
- **0 – 9:** Use to enter the index number of the icon, if known.
- **ENTER:** Changes the icon after the number has been entered.
- **INPUT:** Changes the Aux input label.
- **MENU:** Exits the editing process.

# Cloning Overview / Clonable Menu Features

## IMPORTANT CLONING INFORMATION

Use one of the following options to Learn and Teach the Master STB1000 Setup:

- Using a USB memory device
- Using a TLL-1100A clone programmer
- Using a LT2002 clone programmer

Each option is described in further detail on the pages that follow. As you perform cloning procedures, be sure to complete each task as indicated. If a procedure or step is omitted or not performed completely, cloning may not work. At each step, pay attention to ensure the display panel screen shows the proper message when cloning. If the message indicated does not appear, there is a problem with that step, and cloning may not be successful.



**Warning: Copying a blank or incorrect memory into the STB1000 will cause the STB to operate erratically or become inoperable.**



**Warning: Do not connect a clone programmer to the STB1000 MPI/GAME CONTROL port while the STB is in LodgeNet PPV Mode, as this will damage the clone programmer.**

### Before you begin cloning:

- Complete the Commercial Mode Setup procedure on pages 40 to 41.
- Ensure Installer Menu items on Target STB1000s are set/restored to factory default settings (i.e., set Installer Menu item 117 FACT DEFAULT to 001 on Target STBs) before Teaching is initiated.
- All equipment should be connected to power and turned ON.
- Learning and Teaching is only possible between identical model STBs.
- For both Master and Target STB1000s—The STB EBL must be in Pass-through Mode.
- If using a USB memory device, ensure the USB device has been formatted with FAT format.
- For both Master and Target STB1000s—If using a clone programmer, ensure the STB signal source is either an Aux or TV (RF) source. If a TV (RF) source, the STB must be tuned to an analog (not a digital) channel.
- LT2002 only—Make sure the batteries in the clone programmer are fresh. If batteries are removed, the clone programmer clock time (if set) will be lost (see page 56 for information on the clone programmer clock).
- Do not unplug the STB1000 power cord or remove/disconnect the USB memory device/clone programmer while Learning or Teaching, as doing so may cause the STB to malfunction or harm the USB device/clone programmer, respectively.

## Clonable Menu Features

### Installer Menu

Installer Menu item settings

### Channel

Auto Tuning (Channel Lineup)  
Manual Tuning  
Channel Edit  
Channel Label

### Picture

Aspect Ratio  
Picture Mode  
Advanced Control

### Audio

Auto Volume  
Clear Voice  
Sound Mode  
Balance  
TV Speaker

### Option

Menu Language  
Audio Language  
Caption  
Caption Mode  
Digital Caption Options

### Lock

Movie Rating  
TV Rating-Children  
TV Rating-General  
Input Block

### Time

Auto Clock  
Manual Clock  
Off Time  
On Time  
Auto Off (Sleep Timer)

**Note:** Some menu options vary between analog and digital channels and Aux sources.

## Learning / Teaching a Master STB1000 Setup using a USB Memory Device

### USB Cloning Notes

- Read the IMPORTANT CLONING INFORMATION on page 50 before beginning any cloning procedures.
- You may edit a filename as part of the Learning procedure; however, a file with edited contents will not be recognized.
- It is not possible to clone a Master STB1000's clock using a USB memory device. Either set a Target STB's clock manually, or use the Auto Clock setting in the STB setup menus.

### Learn Setup from Master STB1000

1. Ensure the Master STB1000 is set up completely and the EBL is in Pass-through Mode.
2. Plug the USB memory device into the USB port on the Master STB1000 rear panel.
3. Press **MENU** on the Installer Remote to display the STB setup menus, use the arrow navigation keys to select/highlight the **Option** menu icon, and then press the number "7" key a total of seven times to display the USB Download Menu.
4. To gain access to the "Learn From TV" option in the USB Download Menu, key in the password used to enter the Installer Menu (Example: Press **9-8-7-6**).
5. Use the Up/Down arrow keys to select **Learn From TV**, and then press **ENTER**.
6. To identify the profile from others, you can use the Up/Down arrow keys to change the last five digits of the filename. Press **ENTER** when you are ready to initiate Learning. Learning status will be shown on the progress bar. When the Learning process is complete, the USB Download menu will reappear on screen.
7. Remove the USB memory device from the Master STB1000.



### Teach Master STB1000 Setup to Target STB1000

1. Ensure the Target STB1000 EBL is in Pass-through Mode, and then use the Installer Remote to enter the Target STB1000 Installer Menu: Press **MENU** repeatedly until the on-screen setup menus lock up, and then press **9-8-7-6 + ENTER**.
2. Set Installer Menu item **117 FACT DEFAULT** to **001**, and press **ENTER**.
3. Plug the USB memory device with the Master STB1000 Setup file into the Target STB1000 USB port.
4. Press **MENU** on the Installer Remote to display the STB setup menus, use the arrow navigation keys to select/highlight the **Option** menu icon, and then press the number "7" key a total of seven times to display the USB Download Menu.
5. Use the Up/Down arrow keys to select **Teach To TV**, and then press **ENTER**.
6. Use the Up/Down arrow keys to select the Master STB1000 Setup you want to install, and then press **ENTER**. Note: Filenames identify the STB and the TLL version (see example at right). Teaching status will be shown on the progress bar. When the Teaching process is complete, the USB Download menu will reappear on screen.
7. When Teaching is done, remove the USB memory device from the Target STB1000, turn OFF the STB, and unplug the STB power cord for 15 seconds.
8. Reconnect the STB power cord, and turn ON the STB/display panel. The Master STB1000 Setup should be resident on the Target STB1000.

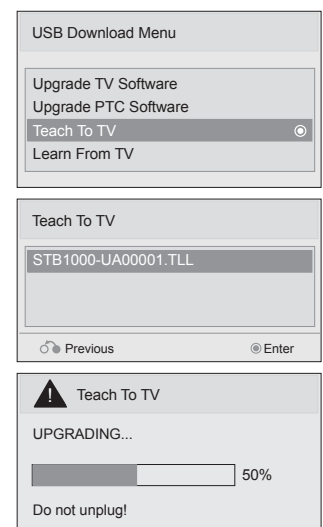

# Cloning Procedures (Cont.)

## Learning / Teaching a Master STB1000 Setup using a TLL-1100A Clone Programmer

**Warning:** Do not connect a clone programmer to the STB1000 MPI/GAME CONTROL port while the STB is in LodgeNet PPV Mode, as this will damage the clone programmer.

Cloning is accomplished using the STB/clone programmer MPI ports for communication (see diagram).

### TLL-1100A Cloning Notes

- Read the IMPORTANT CLONING INFORMATION on page 50 before beginning any cloning procedures.
- Ensure the TLL-1100A is either fully charged or connected to AC power.
- Teaching and Learning is only possible between identical model STBs; however, the TLL-1100A clone programmer can store up to eight different Master STB Setups.

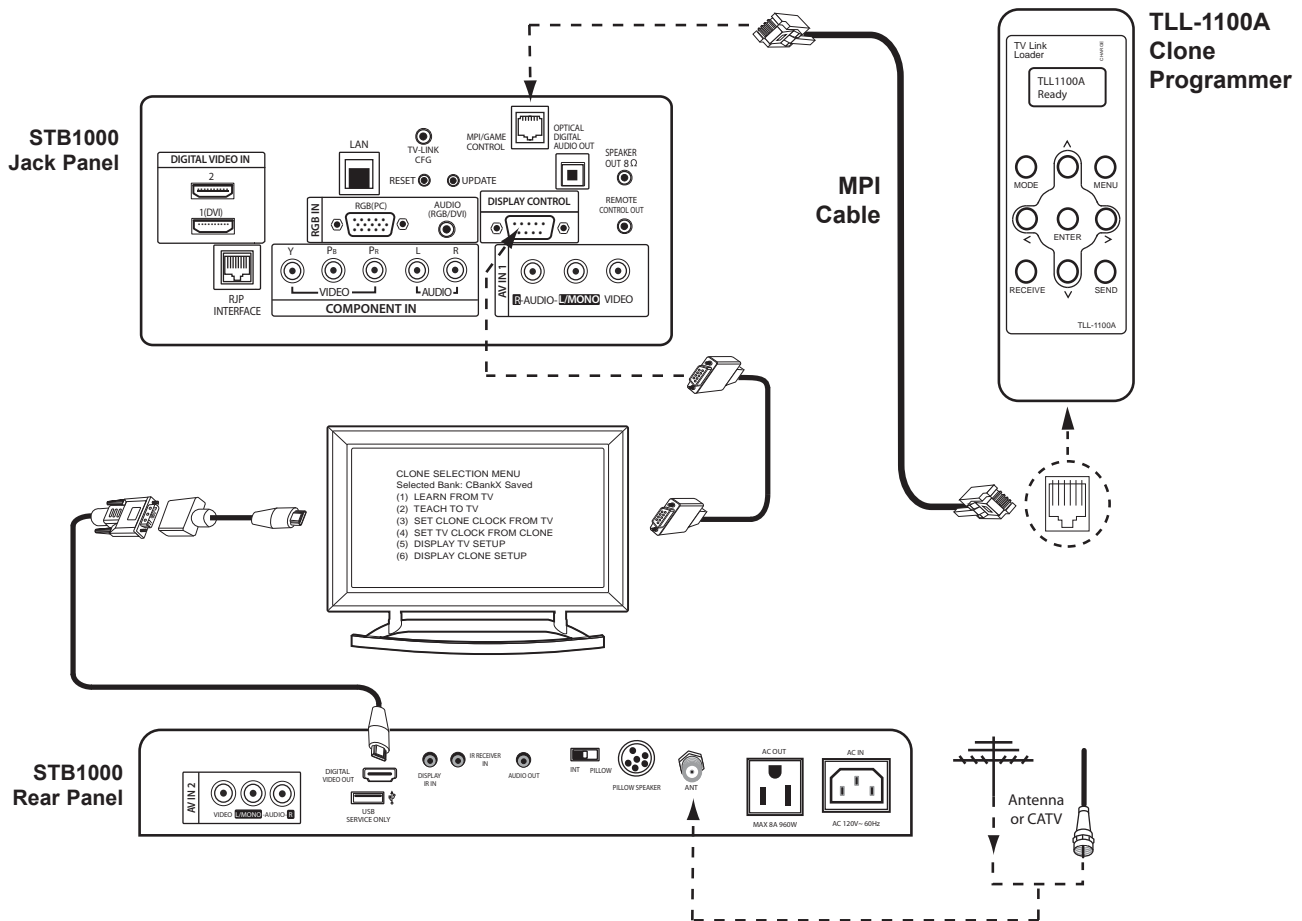

## Learning / Teaching a Master STB1000 Setup using a TLL-1100A Clone Programmer (Cont.)

---

### Learn Setup from Master STB1000

1. Ensure the Master STB1000 is set up completely and the EBL is in Pass-through Mode.
2. If an analog channel is not available, direct tune the Master STB1000 to an Aux source, or select an Aux source, such as AV-1, from the Input Menu. Then, plug one end of the MPI cable into the MPI port on the STB jack panel.
3. Turn ON the TLL-1100A.
4. Use the **MODE** button on the TLL-1100A to select **Clone Mode**.
5. Use the Left/Right arrows on the TLL-1100A to select the Memory CBank (1 to 8) in which to store the Master STB Setup.
6. Plug the other end of the MPI cable into the MPI port on the bottom of the TLL-1100A. The Clone Selection Menu will display on the screen.
7. Press **1** on the Installer Remote to select **LEARN FROM TV** from the Clone Selection Menu. Then, press **ENTER** to transfer the Master STB Setup into CBankX on the TLL-1100A.

Learning usually takes about 90 seconds. "LEARNING IN PROGRESS" will be displayed on the screen while the TLL-1100A copies the Master Setup. When the Learning process is complete, a "LEARNING COMPLETE" message will be displayed.

8. When Learning is complete, disconnect the MPI cable from the Master STB1000.

### (Optional) Set the Clock

Set the time on a Master STB's clock. (If the time has already been copied from an STB1000 into the TLL-1100A clone programmer, you can set the Master STB's clock by copying the time from the clone programmer.) The TLL-1100A can copy the current time to both a Master STB and to the clone's internal clock—accurate to within one minute.

Since the TLL-1100A's time cannot be set directly, the current time needs to be copied from an LG STB equipped with an enabled MPI port.

After the time is copied to the TLL-1100A clone programmer, the current time will be maintained and can then be transferred to another STB. (This can be a Master STB or another STB which has already had the features set up.)

CLONE SELECTION MENU  
Selected Bank: CBankX Saved  
(1) LEARN FROM TV  
(2) TEACH TO TV  
(3) SET CLONE CLOCK FROM TV  
(4) SET TV CLOCK FROM CLONE  
(5) DISPLAY TV SETUP  
(6) DISPLAY CLONE SETUP

CLONE CLOCK = XX:XX  
TV CLOCK = XX:XX  
THE CLONE IS VERSION VX.X.X  
- To change menu items, press channel keys or digits.  
- To execute item, press Enter.

CLONE SELECTION MENU  
Selected Bank: CBankX Saved  
(1) LEARN FROM TV  
(2) TEACH TO TV  
(3) SET CLONE CLOCK FROM TV  
(4) SET TV CLOCK FROM CLONE  
(5) DISPLAY TV SETUP  
(6) DISPLAY CLONE SETUP

CLONE CLOCK = XX:XX  
TV CLOCK = XX:XX  
THE CLONE IS VERSION VX.X.X  
- To change menu items, press channel keys or digits.  
- To execute item, press Enter.

# Cloning Procedures (Cont.)

## Learning / Teaching a Master STB1000 Setup using a TLL-1100A Clone Programmer (Cont.)

---

### Teach Master STB1000 Setup to Target STB1000

1. Ensure the Target STB1000 EBL is in Pass-through Mode, and then use the Installer Remote to enter the Target STB Installer Menu: Press **MENU** repeatedly until the on-screen setup menus lock up, and then press **9-8-7-6 + ENTER**.
2. Set Installer Menu item **117 FACT DEFAULT** to **001**, and press **ENTER**.
3. Tune/set the STB to an analog channel or Aux source, and then connect the MPI cable to the MPI port on the Target STB jack panel. The Clone Selection Menu will display on the screen.
4. Ensure the correct Memory CBank(X) is selected on the TLL-1100A.
5. Press **2** on the Installer Remote to select **TEACH TO TV** from the Clone Selection Menu. Then, press **ENTER** to transfer the Master STB1000 Setup to the Target STB1000.  
Teaching usually takes 3 to 4 minutes. "TEACHING IN PROGRESS" will be displayed on the screen during Teaching. When the Teaching process is complete, a "TEACHING COMPLETE" message will be displayed.
6. When Teaching is done, disconnect the MPI cable from the Target STB, turn OFF the STB, and unplug the STB power cord for 15 seconds.
7. Reconnect the STB power cord, and turn ON the STB/display panel. The Master STB1000 Setup should be resident on the Target STB1000.

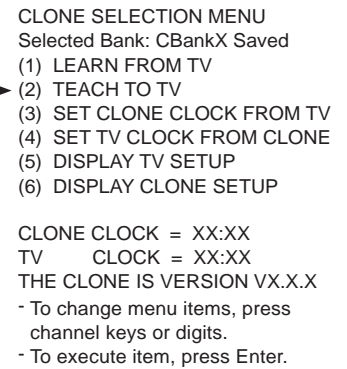

CLONE SELECTION MENU  
Selected Bank: CBankX Saved  
(1) LEARN FROM TV  
(2) TEACH TO TV  
(3) SET CLONE CLOCK FROM TV  
(4) SET TV CLOCK FROM CLONE  
(5) DISPLAY TV SETUP  
(6) DISPLAY CLONE SETUP

CLONE CLOCK = XX:XX  
TV CLOCK = XX:XX  
THE CLONE IS VERSION VX.X.X  
- To change menu items, press channel keys or digits.  
- To execute item, press Enter.

# Cloning Procedures (Cont.)

## Learning / Teaching a Master STB1000 Setup using an LT2002 Clone Programmer

**Warning:** Do not connect a clone programmer to the STB1000 MPI/GAME CONTROL port while the STB is in LodgeNet PPV Mode, as this will damage the clone programmer.

Cloning is accomplished using the STB/clone programmer MPI ports for communication (see diagram).

### LT2002 Cloning Notes

- Read the IMPORTANT CLONING INFORMATION on page 50 before beginning any cloning procedures.
- A slow flashing green light indicates that there are communication problems between the STB1000 and the LT2002. If this is the case, check for a damaged cable, poor contacts, or other connection troubles.
- If the status indicator is red, the LT2002 batteries are low and should be replaced. Install four (4) high-quality alkaline AA batteries.
- Teaching and Learning is only possible between identical model STBs; however, the LT2002 clone programmer can store up to three different Master STB Setups.

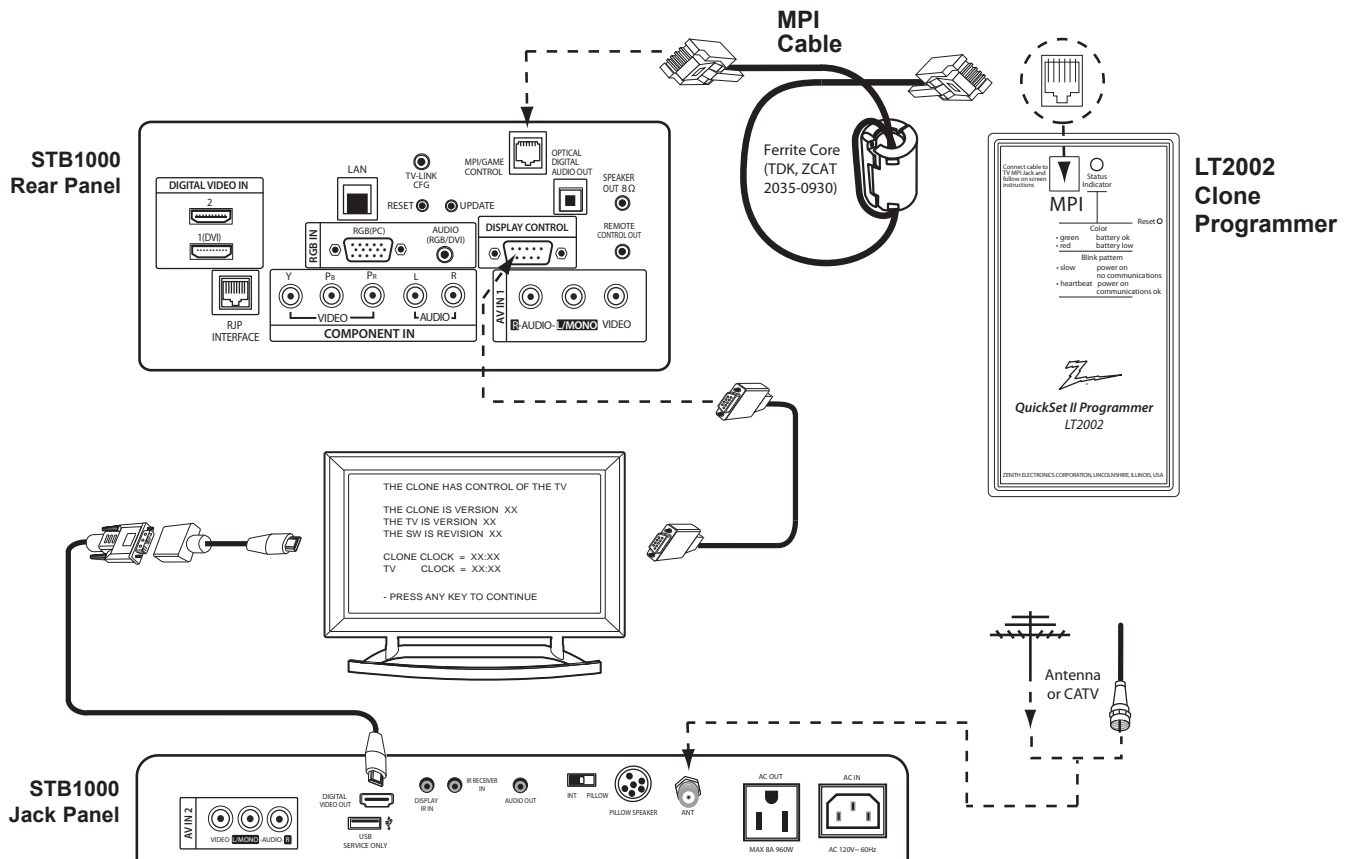

# Cloning Procedures (Cont.)

## Learning / Teaching a Master STB1000 Setup using an LT2002 Clone Programmer (Cont.)

### Learn Setup from Master STB1000

1. Ensure the Master STB is set up completely and the EBL is in Pass-through Mode.
2. If an analog channel is not available, direct tune the Master STB1000 to an Aux source, or select an Aux source, such as AV-1, from the Input Menu. Then, plug one end of the MPI cable into the MPI port on the STB jack panel.
3. If there is a good connection after the LT2002 is connected to the STB MPI port, "THE CLONE HAS CONTROL OF THE TV" message will appear on the display panel screen. Press any key on the Installer Remote to access the LT2002 Clone Selection Menu.
4. Press **1** on the Installer Remote to select **LEARN FROM TV** from the Clone Selection Menu; then press **ENTER** to proceed to the Memory Bank Selection Menu.
5. Press 1, 2, or 3 on the Installer Remote to select the clone Memory Bank in which to store the Master Setup. Then, press **ENTER**.

**Note:** If you choose a Memory Bank that already has a Master device's setup programmed into it, that setup will be overwritten by the new Master STB Setup.

6. Verify the Learning setup information on the next screen, and then press **POWER** to transfer the Master STB Setup into the selected Memory Bank on the LT2002.

Learning usually takes about 90 seconds. "LEARNING IN PROGRESS" will be displayed on the screen while the LT2002 copies the Master Setup. When the Learning process is complete, a "LEARNING COMPLETE" message will be displayed.

7. When Learning is complete, disconnect the MPI cable from the Master STB1000.

### (Optional) Set the Clock

Set the time on a Master STB's clock. (If the time has already been copied from a TV into the LT2002 clone programmer, you can set the Master STB's clock by copying the time from the clone programmer.) The LT2002 can copy the current time to both a Master STB and to the clone's internal clock—accurate to within one minute. (Another reason the LT2002 should be equipped with fresh, high-quality alkaline batteries, is for it to keep the time as accurately as possible.)

Since the LT2002's time cannot be set directly, the current time needs to be copied from an LG STB equipped with an enabled MPI port.

After the time is copied to the LT2002 clone programmer, the current time will be maintained and can then be transferred to another STB. (This can be a Master STB or another STB which has already had the features set up.)

THE CLONE HAS CONTROL OF THE TV

THE CLONE IS VERSION XX  
THE TV IS VERSION XX  
THE SW IS REVISION XX

CLONE CLOCK = XX:XX  
TV CLOCK = XX:XX

- PRESS ANY KEY TO CONTINUE.

- DISCONNECT CLONE WHEN DONE.

CLONE SELECTION MENU

- (1) LEARN FROM TV
- (2) TEACH TO TV
- (3) SET CLONE CLOCK FROM TV
- (4) SET TV CLOCK FROM CLONE
- (5) DISPLAY TV SETUP
- (6) DISPLAY CLONE SETUP

- TO CHANGE MENU ITEMS, PRESS CHANNEL KEYS OR DIGITS.

- TO EXECUTE ITEM, PRESS ON/OFF, POWER, OR ENTER.

SAVE TV SETUP IN SELECTED CLONE MEMORY

- (1) MEMORY 1 VER XX REV XX
- (2) MEMORY 2 VER XX REV XX
- (3) MEMORY 3 VER XX REV XX
- (4) RETURN TO CLONE MENU

- TO CHANGE MENU ITEMS, PRESS CHANNEL KEYS OR DIGITS.

- TO EXECUTE ITEM, PRESS ON/OFF, POWER, OR ENTER.

CLONE SELECTION MENU

- (1) LEARN FROM TV
- (2) TEACH TO TV
- (3) SET CLONE CLOCK FROM TV
- (4) SET TV CLOCK FROM CLONE
- (5) DISPLAY TV SETUP
- (6) DISPLAY CLONE SETUP

- TO CHANGE MENU ITEMS, PRESS CHANNEL KEYS OR DIGITS.

- TO EXECUTE ITEM, PRESS ON/OFF, POWER, OR ENTER.



## Learning / Teaching a Master STB1000 Setup using an LT2002 Clone Programmer (Cont.)

---

### Teach Master STB1000 Setup to Target STB1000

1. Ensure the Target STB1000 EBL is in Pass-through Mode, and then use the Installer Remote to enter the Target STB Installer Menu: Press **MENU** repeatedly until the on-screen setup menus lock up, and then press **9-8-7-6 + ENTER**.
2. Set Installer Menu item **117 FACT DEFAULT** to **001**, and press **ENTER**.
3. Tune/set the STB to an analog channel or Aux source, and then connect the MPI cable to the MPI port on the Target STB jack panel.
4. With "THE CLONE HAS CONTROL OF TV" message on display, press **2** on the Installer Remote to select **TEACH TO TV** from the LT2002 Clone Selection Menu. Then, press **ENTER**.
5. Select the LT2002 Memory Bank in which the new Master TV Setup is located, and press **ENTER**.
6. Verify the Teaching setup information on the next screen, and then press **POWER** to transfer the Master STB Setup to the Target STB.  
Teaching usually takes 3 to 4 minutes. "TEACHING IN PROGRESS" will be displayed on-screen during Teaching. When the Teaching process is complete, a "TEACHING COMPLETE" message will be displayed.
7. When Teaching is done, disconnect the MPI cable from the Target STB, turn OFF the STB, and unplug the STB power cord for 15 seconds.
8. Reconnect the STB power cord, and turn ON the STB/display panel. The Master STB1000 Setup should be resident on the Target STB1000.

#### CLONE SELECTION MENU

- (1) LEARN FROM TV
- (2) TEACH TO TV
- (3) SET CLONE CLOCK FROM TV
- (4) SET TV CLOCK FROM CLONE
- (5) DISPLAY TV SETUP
- (6) DISPLAY CLONE SETUP

- TO CHANGE MENU ITEMS, PRESS CHANNEL KEYS OR DIGITS.

- TO EXECUTE ITEM, PRESS ON/OFF, POWER, OR ENTER.

#### SAVE TV SETUP IN SELECTED CLONE MEMORY

- (1) MEMORY 1 VER XX REV XX
- (2) MEMORY 2 VER XX REV XX
- (3) MEMORY 3 VER XX REV XX
- (4) RETURN TO CLONE MENU

- TO CHANGE MENU ITEMS, PRESS CHANNEL KEYS OR DIGITS.

- TO EXECUTE ITEM, PRESS ON/OFF, POWER, OR ENTER.

# FTG Mode of Operation

## FTG Configuration Overview

The following steps outline local FTG configuration of individual STB1000s. Since these models are equipped with the EBL module, they can also be broadcast configured in FTG Mode by a Free-To-Guest Management Appliance (FMA) head end device. Refer to the **Free-To-Guest (FTG) Configuration Application** manual and/or the Installation & Setup manual for the FMA device for further information.

**Note:** FTG Configuration Application software is available online at: [www.LGcommercial.com/FTGsoftware](http://www.LGcommercial.com/FTGsoftware).

1. Install (if necessary) and launch the FTG Configuration Application (v5.0.0 or higher) on the PC that will be used to configure the EBL.
2. Build a Channel Map using the FTG Channel Map Editor in the FTG Channel Map Configuration Utility (or, if applicable, open an existing FTG Configuration (.rml) file).
3. Connect the PC to the TV-LINK CFG jack on the STB1000 jack panel using a USB-to-TTL serial cable (TTL-232R-5V-AJ). If necessary, install the device driver on the PC.
4. Turn ON the STB/display panel. Note: A green text banner that shows the EBL firmware version and release date will briefly appear on the display panel.
5. "Write" the FTG Channel Map to the EBL (converts EBL from Pass-through Mode to FTG Mode).
6. "Read" the current FTG Installer Menu settings from the EBL using the FTG Installer Menu Configuration Utility. If necessary to make changes to Installer Menu items, "Write" them back to the EBL in FTG Mode.
7. Save the FTG Channel Map and FTG Installer Menu settings to an FTG Configuration (.rml) file for future use.
8. Tune the STB1000 to a Logical Channel in the FTG Channel Map.

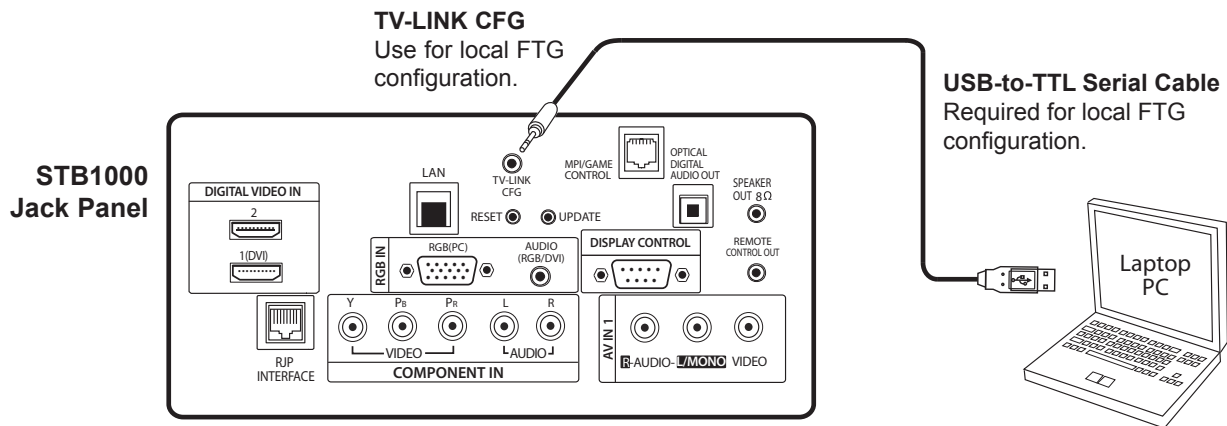

# FTG Mode of Operation (Cont.)

## Determining the STB Operating Mode / FTG Channel Map Configuration Utility Overview

To determine the operating mode of the STB1000, press **MENU** on the Installer Remote. If the end user Function Menu (showing aspect ratio options) appears, the STB EBL is in FTG Mode. If the STB setup menus appear, the EBL is in Pass-through Mode.

The following pages provide overviews of the FTG Channel Map and FTG Installer Menu Configuration Utilities that comprise the FTG Configuration Application. Refer to the **Free-To-Guest (FTG) Configuration Application** manual for further information.

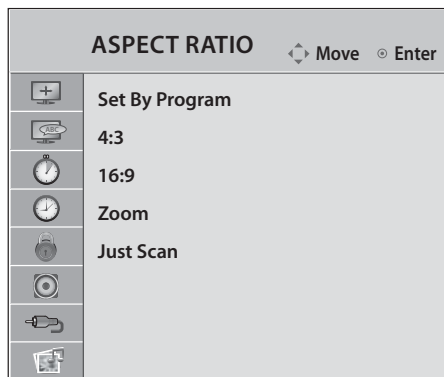

### Function Menu

Shows that the EBL is in FTG Mode. While this menu is present on-screen, Installer Menu settings can ONLY be accessed/changed using the FTG Configuration Application.

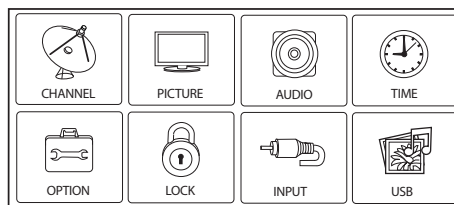

### STB Setup Menus

Shows that the EBL is in Pass-through Mode.

Writing an FTG Channel Map into the EBL will switch the EBL from Pass-through Mode to FTG Mode.

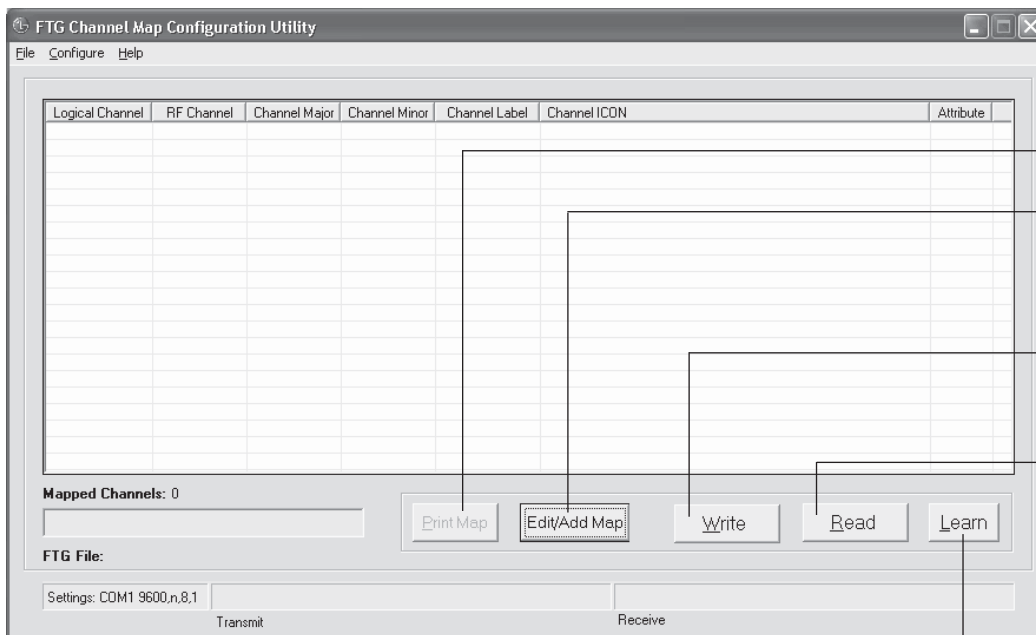

### PRINT MAP

Click to display a printable FTG Channel Map Report. The report can also be exported as an HTML or Text file.

### EDIT/ADD MAP

Click to open the FTG Channel Map Editor to create or edit an FTG Channel Map (see next page).

### WRITE

Click to transfer the FTG Channel Map to the EBL.

### READ

Click to transfer the FTG Channel Map from the EBL to the FTG Configuration Application.

### FTG CHANNEL MAP CONFIGURATION UTILITY

### LEARN

Click to transfer the STB Channel Map from the PTC to the EBL and the FTG Configuration Application. (Requires that 2-5-5 + MENU was performed to transfer STB Channel Map to PTC.) \*

\* Logical Channel numbers will automatically be assigned in ascending order, starting with 0 (zero), to the Physical Channels from the STB Channel Map.

# FTG Mode of Operation (Cont.)

## FTG Channel Map Configuration Utility / FTG Channel Map Editor Overview

The FTG Channel Map Editor shows a single Logical Channel's Data and the FTG Channel Map.

### LOGICAL CHANNEL MAPPING

Select a Logical Channel number, then assign it the RF, Major, and Minor channel numbers to complete the mapping.

### CUSTOM CHANNEL LABELS/ICONS

Enter custom labels and select icons by name on menu or by number.

### SET CHANNEL ATTRIBUTES

Check/select Encrypted, OSD, or Blank Video.

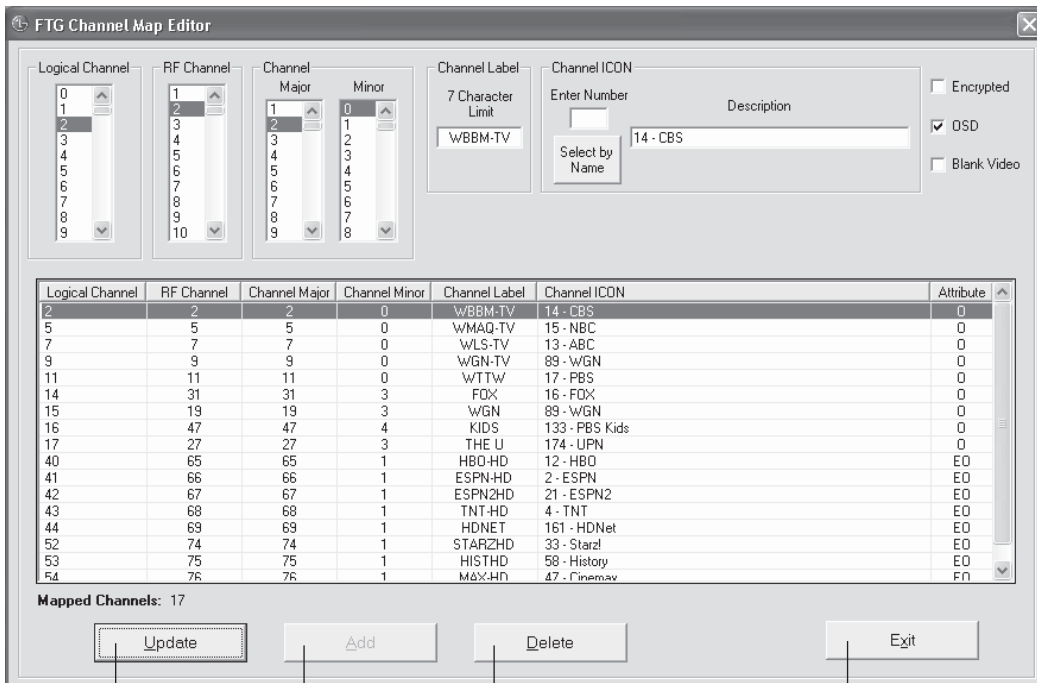

### UPDATE

After editing an existing Logical Channel's data, click to commit the changes in the FTG Channel Map.

### ADD

After defining a new Logical Channel, click to add channel to the FTG Channel Map.

### DELETE

Click to remove highlighted channel from FTG Channel Map.

### EXIT

Click to exit editor and return to FTG Channel Map Configuration Utility.

# FTG Mode of Operation (Cont.)

## FTG Installer Menu Configuration Utility Overview

### CONFIGURATION SETTINGS

Select tabs for categories of Installer Menu items to set up STB.

### HOSPITAL-GRADE STB ONLY

Set Hospital items on Installer Menu for hospital-grade STBs.

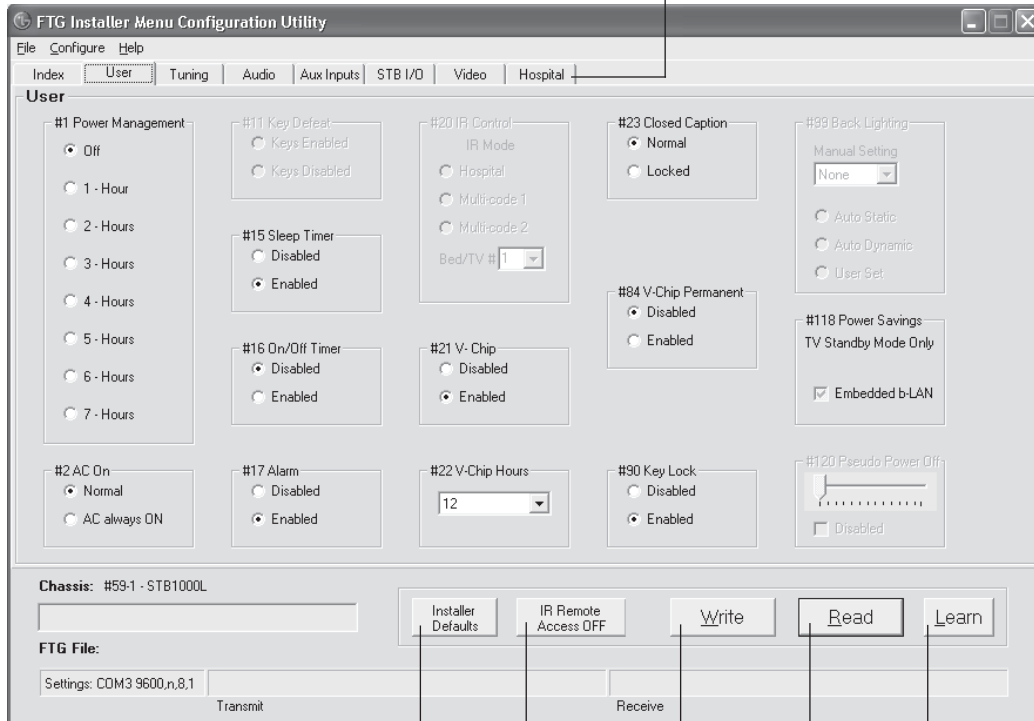

### INSTALLER DEFAULTS

Click to reset FTG Installer Menu items shown in the FTG Configuration Application to defaults.

### IR REMOTE ACCESS

Toggle IR Remote Access to ON to obtain access to STB setup menus and Installer Menu.

### WRITE

Click to transfer the FTG Installer Menu settings to the EBL.

### LEARN

Click to transfer Installer Menu settings from the PTC to the EBL and FTG Configuration Application. \*

### READ

Click to transfer the Installer Menu settings in the EBL to the FTG Configuration Application.

\* Logical Channel numbers will automatically be assigned in ascending order, starting with 0 (zero), to the Physical Channels from the STB Channel Map.

# Remote Jack Pack Connections & Setup

## Remote Jack Pack Setup

RJP Available? If you will use a Remote Jack Pack (RJP) in your system, set Installer Menu item **093 RJP AVAILABLE** appropriately (for example, on a legacy model RJP: HDMI Mode, set RJP AVAILABLE to 001). See Installer Menu detailed descriptions for further information.

**093 RJP AVAILABLE 001**

## STB Connections

**!** Make these connections **ONLY** after **Commercial Mode Setup and STB1000 Cloning** procedures are complete.

Refer to the figure below, and connect the RJ-45 Control cable from the RJP cable bundle to the RJP INTERFACE port on the STB1000's jack panel. Then, connect HDMI, RGB, and Composite Video/Audio connectors, as applicable, for the cable bundle.

**HDMI/DVI IN 1 PORT**  
Connect HDMI connector from RJP cable bundle.

**RGB IN (PC)**  
Connect RGB connector from RJP cable bundle (legacy RJP only).

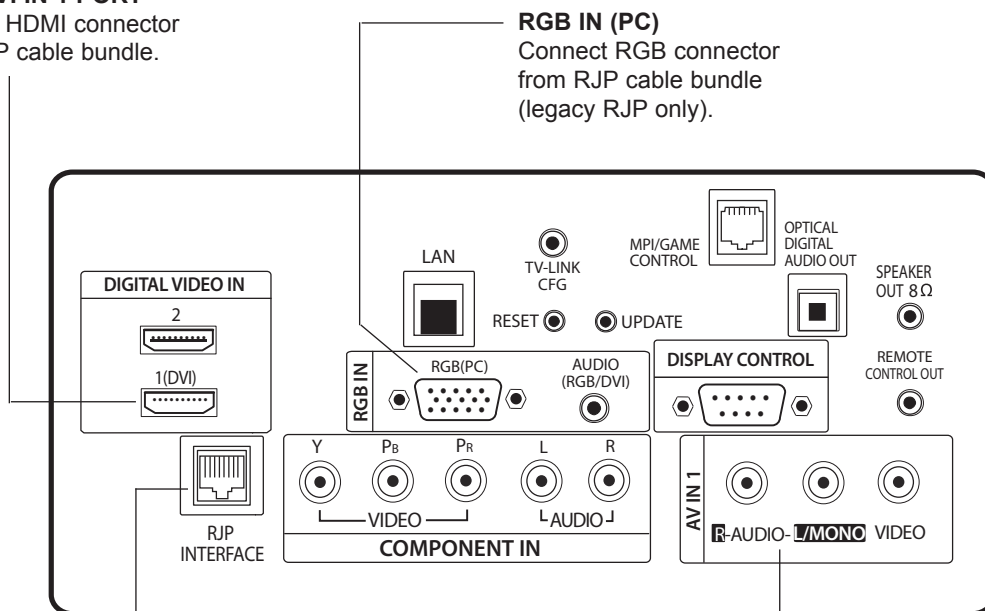

**RJP INTERFACE**  
Connect RJ-45 Control cable from RJP cable bundle.

**AUDIO/VIDEO IN 1**  
Connect Composite Video/Audio connectors from RJP cable bundle. (Composite Video on legacy RJP only.)

# External Equipment Setup

## Digital Audio Optical Connections / Component Connections

### Digital Audio Optical Connections

1. Connect an optical cable between the OPTICAL DIGITAL AUDIO OUT connector on the STB1000 jack panel and the digital audio input connector on the external Digital Audio Amplifier System.
2. Select the Optical Digital Audio input source on the amplifier.
3. If not already done, turn ON the STB/display panel and external equipment.
4. Access the STB Audio Menu, and set TV Speaker to "Off."

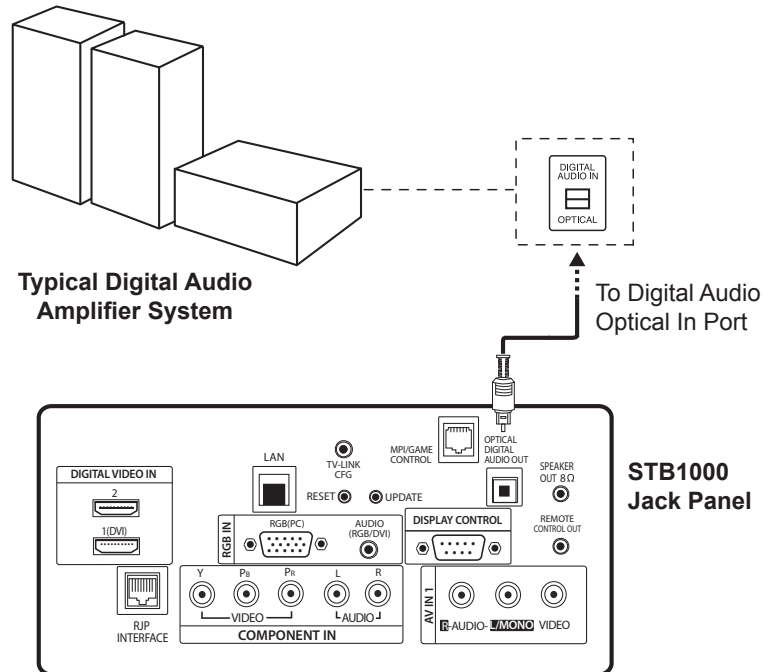

### Component Connections

1. Connect a component cable between the video (Y, Pb, Pr) and audio (L, R) outputs on the external equipment and the COMPONENT IN Video and Audio jacks on the STB1000 jack panel. Match the cable/jack colors.
2. If not already done, turn ON the STB/display panel and external equipment.
3. Select the component input source on the STB using the INPUT button on the Installer Remote or via the STB Input Menu.

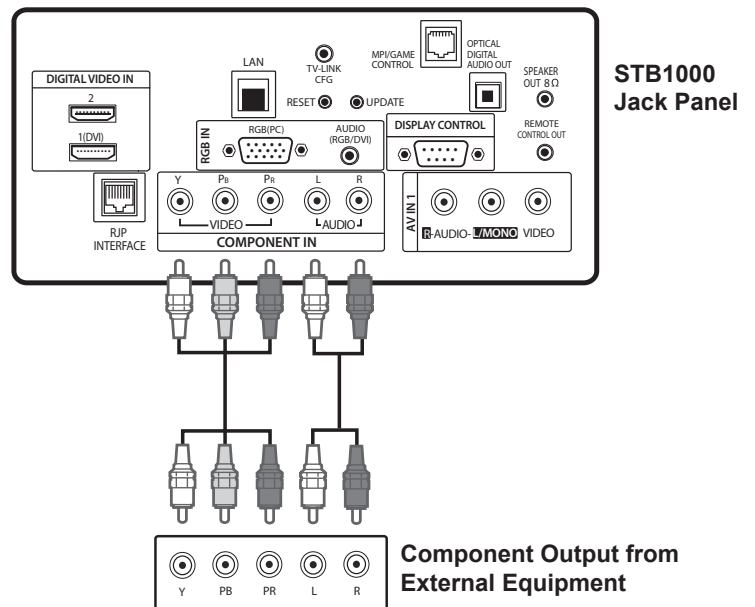

# External Equipment Setup (Cont.)

## HDMI/DVI Connections / RGB Hookup to PC

### HDMI/DVI Connections

1. Connect an HDMI/DVI cable between the HDMI/DVI output on the external equipment and the appropriate HDMI/DVI IN connector on the STB1000 jack panel.
2. If required, connect an audio cable between the audio output on the external equipment and the AUDIO (RGB/DVI) input jack on the STB1000 jack panel.

**Note:** A separate audio connection is not required for HDMI.

3. If not already done, turn ON the STB/display panel and external equipment.
4. Select the appropriate HDMI/DVI input source on the STB using the INPUT button on the Installer Remote or via the STB Input Menu.

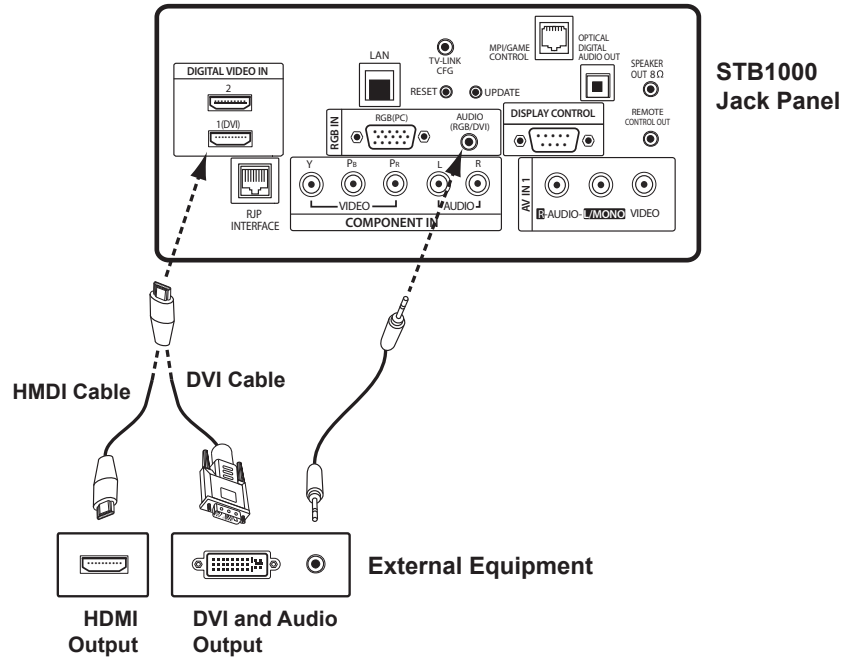

### RGB Hookup to PC

1. Connect an RGB cable between the RGB output connector on the PC and the RGB (PC) input connector on the STB jack panel.
2. If PC sound is required, connect the PC audio output to the AUDIO (RGB/DVI) input jack on the STB1000 jack panel.
3. If not already done, turn ON the STB/display panel and external equipment.
4. Select the RGB-PC input source on the STB using the INPUT button on the Installer Remote or via the STB Input Menu.

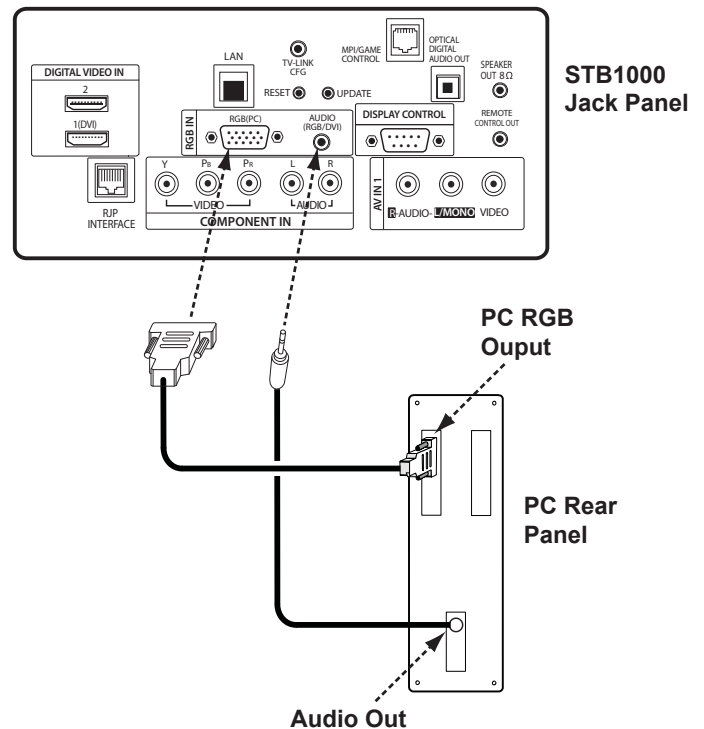



# External Equipment Setup (Cont.)

## Composite Connections

### Composite Connections

1. Connect a composite cable between the Video and Audio (L, R) outputs on the external equipment and the AV IN Video and Audio jacks on either the STB1000 jack panel or the STB1000 rear panel. Match the cable/jack colors.
2. If not already done, turn ON the STB/display panel and external equipment.
3. Select the appropriate AV input source on the STB using the INPUT button on the Installer Remote or via the STB Input Menu.

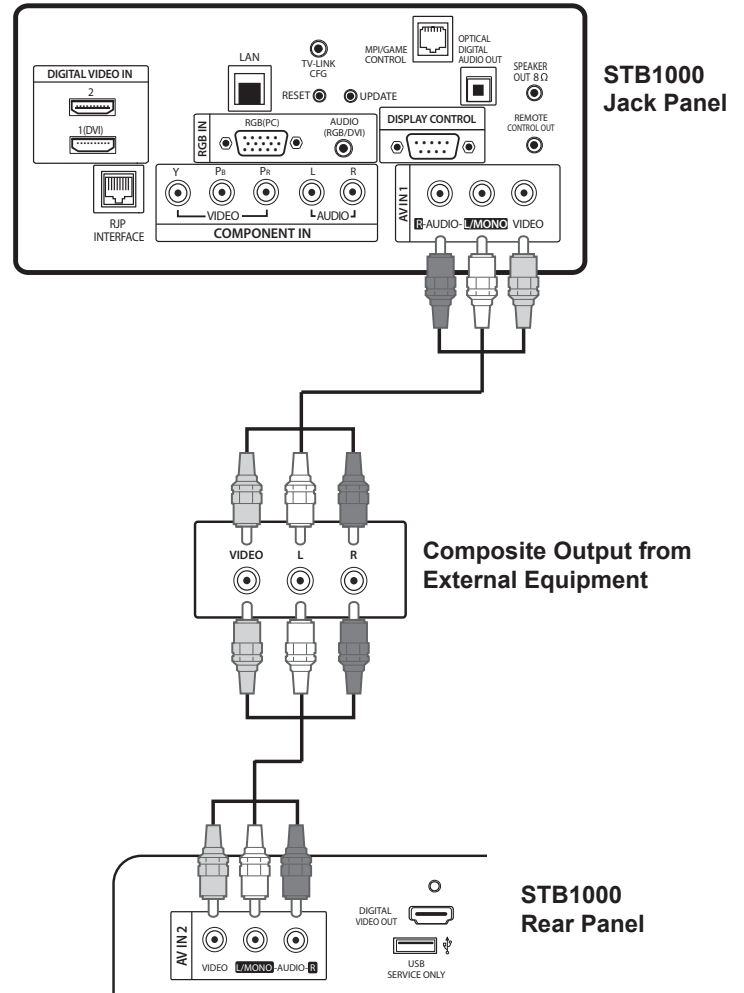

# Reference: Upgrading STB Software using a USB Memory Device

## Checking the Software Versions

**Note:** This function is not accessible while the TV is in FTG or PPV Mode.

You can check the software versions of the STB by accessing the Installer Menu with the Installer Remote: Press **MENU** repeatedly until the on-screen setup menus lock up, and then press **9-8-7-6 + ENTER**. When you are finished, press **ENTER** again to exit the Installer Menu.

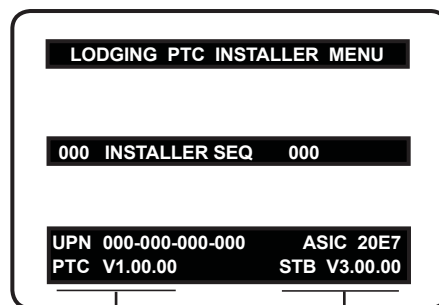

Typical Installer Menu

PTC Version

CPU Version

## Upgrading TV/PTC Software

Before you begin, note that the software upgrade files must be stored in a folder named "LG\_DTV" in the root directory of the USB memory device. Also, ensure the USB device has been formatted with FAT format.

**Note for STB1000 Software Upgrade only:** If the STB detects a later version of software on the USB device, it will automatically display a dialog from which you can start the software upgrade immediately. Otherwise, you can close the dialog and access the USB Download Menu as described below.

1. Turn ON the STB1000/display panel.
2. Plug the USB memory device into the USB port on the STB rear panel.
3. Press **MENU** on the Installer Remote to display the STB setup menus.
4. Use the arrow navigation keys to select/highlight either the **Option** (if EBL is in Pass-through Mode) or **Lock** (if STB is in FTG or LodgeNet PPV Mode) menu icon; then, press the number "7" key a total of seven times to display the USB Download Menu.
5. Use the Up/Down arrow keys to select **Upgrade TV Software** or **Upgrade PTC Software**, as applicable, and then press **ENTER**. (See screen samples at right.)
6. Use the Up/Down arrow keys to select the upgrade to install, and then press **ENTER**.

Update completion progress will be displayed on the screen in a new window. Do NOT remove the USB device until the software upgrade is complete. When a software upgrade is complete, the STB will reset itself with an automatic restart. When a PTC upgrade is complete, the STB will turn OFF.

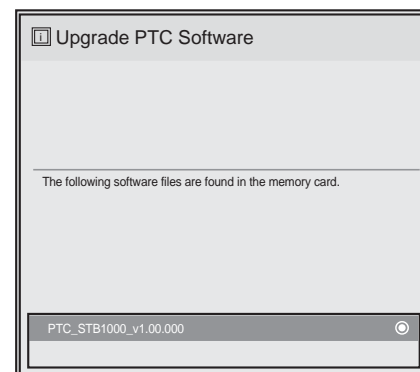
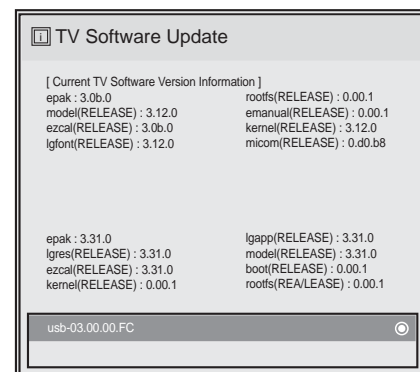
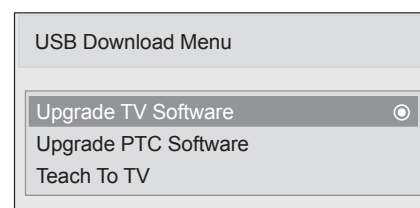

# Reference: Downloading a Splash Screen using a USB Memory Device

---

## Splash Screen Image File Guidelines

- The splash screen image must be a 24-bit (RGB 8x8x8) BMP.
- The image should be no larger than 3 MB.
- The ideal resolution for the image is 1366 x 768 pixels.
- The image file must be stored in a folder named “LG\_DTV” in the root directory of USB memory device.
- Ensure the USB device has been formatted with FAT format.

## Downloading a Splash Screen Image

1. Turn the TV ON.
2. Plug the USB memory device into the USB port on the STB rear panel.
3. Press **MENU** on the Installer Remote to display the STB setup menus.
4. Use the arrow navigation keys to select/highlight either the **Option** (if EBL is in Pass-through Mode) or **Lock** (if STB is in FTG or LodgeNet PPV Mode) menu icon; then, press the number “7” key a total of seven times to display the USB Download Menu (see sample screen on previous page).
5. Use the Up/Down arrow keys to select **Upgrade TV Software**, and then press **ENTER**.
6. Use the Up/Down arrow keys to select the image file to download, and then press **ENTER**.

The STB will show download completion progress in a new window. Do NOT remove the USB device until the image download is complete. When the image download is complete, the STB will reset itself with an automatic restart. Upon the restart, you should see the new splash screen on the display panel.

# Reference: RS-232 Display Panel Requirements

## DISPLAY CONTROL RS-232 Pin Configuration (DB9 Male)

Pin Number	Description
1	No Connection
2	RXD (Receive Data)
3	TXD (Transmit Data)
4	No Connection
5	GND
6	No Connection
7	No Connection
8	No Connection
9	No Connection

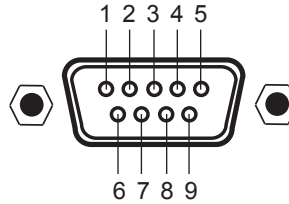

LG monitors/displays listed below require an RS-232 serial null-modem DB9 cable with female connectors at each end.

### RS-232 Null Configuration

3-Wire Configuration  
(serial Female-Female null-modem cable)

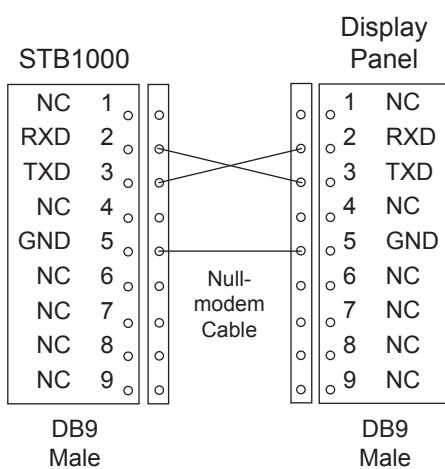

Compatible Monitors/ Displays:

- M3203CCBA
- M3204C
- LD350C series
- LD450C series
- 55LD520C
- LG30DC series
- LG50DC series
- 22LH200C
- 26LH210C
- LH300C series
- 52LH400C
- PJ350C series
- PK550C series
- PQ30C series
- 50/60PS60C

Some LG monitors/displays may require an RS-232 straight-through DB9 cable with a male connector on one end and a female connector on the other end. Please contact LG for information on compatibility.

### RS-232 Straight Configuration

3-Wire Configuration  
(straight-through Female-Male cable)

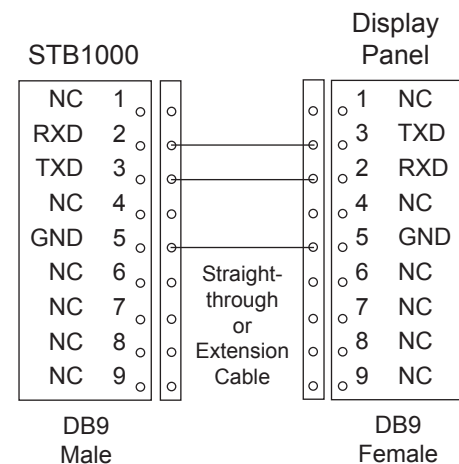

## Reference: Display Panel Type Specifications

---

The following table identifies the Installer Menu item 113 PANEL TYPE setting for each of the compatible monitors/TVs listed in the “RS-232 Display Panel Requirements” Reference.

Monitor/Display	PANEL TYPE Setting				
	0	1	2	3	4
M3203CCBA			X		
M3204C			X		
LD350C series					X
LD450C series					X
55LD520C					X
LG30DC series					X
LG50DC series					X
22LH200C					X
26LH210C					X
LH300C series					X
52LH400C					X
PJ350C series					X
PK550C series					X
PQ30C series					X
50/60PS60C					X

# Reference: STB1000 Aux Input Configuration

DIRECT ACCESS Tuning		STB		ENABLE				MPI DATA			START AUX SOURCE ASSIGN- MENT
				Installer Menu		MPI DATA STATUS TYPE 0x41 SOURCES ENABLED (R/W)		DATA STATUS TYPE 0xD2 CURRENT AV SOURCE (R)		DATA STATUS TYPE 0x0D AUX SOURCE (R)	
OLD_ OCV = 0	OLD_ OCV = 1	Source Input	Source Mode	Number	Labeling	Value	Labeling	Value	Labeling		
130	90	Video2 (Side)	CV	34	CAMPORT_EN	0x01	Video Front (Camport)	0	Video Front (Camport)	0 (VIDEO)	2
131	91	Video1 (Rear)	CV	39	REAR_AUX_EN	0x02	Rear Video (Aux)	1	Rear Video (Aux)	0 (VIDEO)	1
132	92	HDMI2	DTV/PC	91	YPrPb2 EN = 1	0x04	S-Video Rear	2	S-Video Rear	0 (VIDEO)	5
133	93	HDMI1/DVI	DTV/PC	35	COMPPOINT_EN = 1	0x08	Front Computer	3	Front Computer	0 (VIDEO)	3
134	94	RGB	PC	87	REAR RGB EN = 2	0x10	SVGA Rear Computer	4	SVGA Rear Computer	2 (COMPUTER)	4
136	96	Component		38	YPrPb EN	0x40	Y/UV Component	6	Rear Y/PrPb Component Video	0 (VIDEO)	6

# Reference: STB1000 Camport Auto Sense Operation

The Camport Auto Sense function is enabled when:

1. Installer Menu item 034 CAMPORT EN is set to 1 AND
2. Installer Menu item 040 AUTO CAMPORT is enabled (1).

**Selectable:** Can be accessed with INPUT key, direct access, etc.

**Auto Sense:** STB switches to this input when connector is inserted. The Camport (AV IN 2 Video) has the highest priority and will override any commands including tuning to the Start Channel.

## CAMPOR (AV IN 2 Video) Functionality Control

Item 034 CAMPORT EN	Item 040 AUTO CAMPORT	Side Video Operation
0	0	Disabled
0	1	Disabled
1	0	Selectable
1	1	Auto Sense

### Campport Operation (Stand-Alone)

When Campport Auto Sense is enabled as above, the STB's source will switch to the AV IN 2 Video Aux source whenever a plug is inserted into the AV IN 2 Video input.

When the plug is removed, the STB will switch back to the previous channel or input source that was being displayed before the plug was inserted. However, if any direct access to an RF channel or Aux channel is requested while the Campport is active, then, when the video plug is removed, the STB will switch to the last requested channel. Source changes using any Source keys (INPUT) are ignored. Channel Up/Down and Flashback commands are not direct access tuning commands, and they are also ignored.

Previous State Before Inserting CAMPORT	Operation While CAMPORT is Active	State Upon Removal of CAMPORT
Aux or RF Channel	None	Previous Aux or RF Channel
Aux or RF Channel	Direct Access	Last Requested Aux or RF Channel
Aux or RF Channel	Ch Up/Down, Flashback, and Input Keys	Previous Aux or RF Channel

### Campport Operation (FTG or PPV)

The operation will be similar to that of the Stand-alone Mode. However, when the Channel Map is maintained external to the PTC (i.e., FTG and PPV), Channel Up/Down or Flashback keys are sent as Direct Access tuning commands to the PTC/STB.

Previous State Before Inserting CAMPORT	Operation While CAMPORT is Active	State Upon Removal of CAMPORT
Aux or RF Channel	None	Previous Aux or RF Channel
Aux or RF Channel	Direct Access	Last Requested Aux or RF Channel
Aux or RF Channel	Ch Up/Down, Flashback, and Input Keys	Last Requested Aux or RF Channel

## Reference: *b*-LAN Setup & Overview

---

The *b*-LAN module is internal to the STB1000. It allows the hotel/institution head end equipment to communicate, via the institution's RF distribution system, with the STB1000 for configuration and control. The *b*-LAN module also comprises the data tuner required for Pro:Centric operation.

Power to the *b*-LAN module is controlled by Installer Menu item 118 POWER SAVINGS. The default value is 003—the *b*-LAN module is only powered when the STB is turned ON. See chart below.

POWER SAVINGS	STB Standby State	STB Power On State
	<i>b</i> -LAN Power	<i>b</i> -LAN Power
001	On	On
003 (default)	Off	On

The control device at the head end, for example, an FMA-LG101 or a PCS150R, can control multiple STBs. When the STB1000 is first installed, it must be turned ON in order for the head end to be able to communicate with the *b*-LAN. At this point, if it is desired for the *b*-LAN to always be powered, including while the TV is in Standby, set Installer Menu item 118 POWER SAVINGS to 001.



## Reference: RJP Model List and Input Auto-sensing Hierarchy

---

### RJP Model List

<b>Legacy Models</b>	<b>Scaler Models</b>
RJP-101M	RJP-201M
RJP-101ML	N/A
RJP-110F	N/A
RJP-110FW	N/A
RJP-110W	N/A
RJP-110WBR	N/A
RJP-110S	N/A
RJP-120G	N/A
RJP-120T	N/A
RJP-201B	RJP-301B, RJP-401W
RJP-202B	N/A

### RJP Input Auto-sensing Hierarchy

<b>Priority</b>	<b>Video</b>	<b>Audio</b>
1st (Highest)	Digital Video In	Audio In (3.5mm)
2nd	PC Video In	Audio In (L/R)
3rd	Video In	Digital Video In

## Reference: Programming the Installer Remote

---

The Installer Remote can be programmed to operate most remote-controllable devices. Note that the Installer Remote may not control all models of other brands.

1. Test the remote to find out whether it can operate other components without programming. For example, turn ON a component such as a DVD player, and press the corresponding Mode button (DVD) on the remote, while pointing at the component. Test the POWER and Channel Up/Down buttons to see if the component responds correctly. If the component does not operate correctly, the remote control requires programming to operate the device. Continue with step 2.
2. Turn ON the component to be programmed, and then press the corresponding Mode button (DVD, VCR, etc.) on the remote.
3. Press **MENU** and **MUTE** simultaneously. The remote is now ready to be programmed with the code.
4. Enter a code number using the number buttons on the remote. Programming code numbers for the corresponding component can be found on the following pages. If the code is correct, the device will turn OFF.
5. Press **MENU** on the remote to store the code.
6. Test the remote control functions to see if the component responds correctly. If not, repeat from step 2.

## Reference: Remote Control Codes

### VCR Codes

Brand	Code(s)
AIWA	034
AKAI	016, 043, 046, 124, 125, 146
AMPRO	072
ANAM	031, 033, 103
AUDIO DYNAMICS	012, 023, 039, 043
BROKSONIC	035, 037, 129
CANON	028, 031, 033
CAPEHART	108
CRAIG	003, 040, 135
CURTIS MATHES	031, 033, 041
DAEWOO	005, 007, 010, 064, 065, 108, 110, 111, 112, 116, 117, 119
DAYTRON	108
DBX	012, 023, 039, 043
DYNATECH	034, 053
ELECTROHOME	059
EMERSON	006, 017, 025, 027, 029, 031, 034, 035, 036, 037, 046, 101, 129, 131, 138, 153
FISHER	003, 008, 009, 010
FUNAI	034
GE	031, 033, 063, 072, 107, 109, 144, 147
GO VIDEO	132, 136
HARMAN KARDON	012, 045
HITACHI	004, 018, 026, 034, 043, 063, 137, 150
INSTANTREPLAY	031, 033
JCL	031, 033
JCPENNY	012, 013, 015, 033, 040, 066, 101
JENSEN	043
JVC	012, 031, 033, 043, 048, 050, 055, 060, 130, 150, 152
KENWOOD	014, 034, 039, 043, 047, 048
LG (GOLDSTAR)	001, 012, 013, 020, 101, 106, 114, 123

Brand	Code(s)
LLOYD	034
LXI	003, 009, 013, 014, 017, 034, 101, 106
MAGIN	040
MAGNAVOX	031, 033, 034, 041, 067, 068
MARANTZ	012, 031, 033, 067, 069
MARTA	101
MATSUI	027, 030
MEI	031, 033
MEMOREX	003, 010, 014, 031, 033, 034, 053, 072, 101, 102, 134, 139
MGA	045, 046, 059
MINOLTA	013, 020
MITSUBISHI	013, 020, 045, 046, 049, 051, 059, 061, 151
MTC	034, 040
MULTITECH	024, 034
NEC	012, 023, 039, 043, 048
NORDMENDE	043
OPTONICA	053, 054
PANASONIC	066, 070, 074, 083, 133, 140, 145
PENTAX	013, 020, 031, 033, 063
PHILCO	031, 034, 067
PHILIPS	031, 033, 034, 054, 067, 071, 101
PILOT	101
PIONEER	013, 021, 048
PORTLAND	108
PULSAR	072
QUARTZ	011, 014
QUASAR	033, 066, 075, 145
RCA	013, 020, 033, 034, 040, 041, 062, 063, 107, 109, 140, 144, 145, 147
REALISTIC	003, 008, 010, 014, 031, 033, 034, 040, 053, 054, 101
RICO	058

Brand	Code(s)
RUNCO	148
SALORA	014
SAMSUNG	032, 040, 102, 104, 105, 107, 109, 112, 113, 115, 120, 122, 125
SANSUI	022, 043, 048, 135
SANYO	003, 007, 010, 014, 102, 134
SCOTT	017, 037, 112, 129, 131
SEARS	003, 008, 009, 010, 013, 014, 017, 020, 031, 042, 073, 081, 101
SHARP	031, 054, 149
SHINTOM	024
SONY	003, 009, 031, 052, 056, 057, 058, 076, 077, 078, 149
SOUNDESIGN	034
STS	013
SYLVANIA	031, 033, 034, 059, 067
SYMPHONIC	034
TANDY	010, 034
TATUNG	039, 043
TEAC	034, 039, 043
TECHNICS	031, 033, 070
TEKNIKA	019, 031, 033, 034, 101
THOMAS	034
TMK	006
TOSHIBA	008, 013, 042, 047, 059, 082, 112, 131
TOTEVISION	040, 101
UNITECH	040
VECTOR RESEARCH	012
VICTOR	048
VIDEO CONCEPTS	012, 034, 046
VIDEOSONIC	040
WARDS	003, 013, 017, 024, 031, 033, 034, 040, 053, 054, 131
YAMAHA	012, 034, 039, 043
ZENITH	034, 048, 056, 058, 072, 080, 101

## Reference: Remote Control Codes (Cont.)

---

### DVD Codes

Brand	Code(s)
APEX DIGITAL	022
ONKYO	008, 017
PANASONIC	003, 009
PHILIPS	013
PIONEER	004, 026
PROCEED	021
PROSCAN	005, 006
RCA	005, 006
SAMSUNG	011, 015
SONY	007
THOMPSON	005, 006
TOSHIBA	008, 019
YAMAHA	009, 018
ZENITH	010, 016, 025

## Remote Control Connection

Connect your wired remote control to the REMOTE CONTROL OUT port on the STB1000 jack panel.

## Remote Control IR Codes

### Output Waveform

Single pulse, modulated with 37.917KHz signal at 455KHz



### Configuration of Frame

1st frame

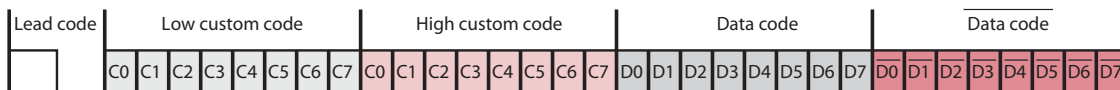

Repeat frame

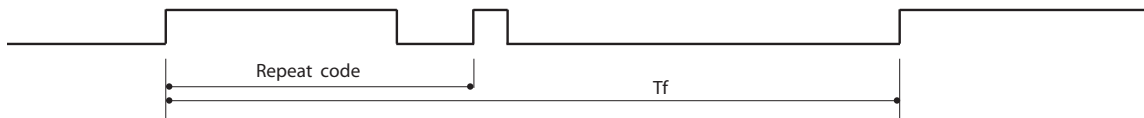

### Lead Code

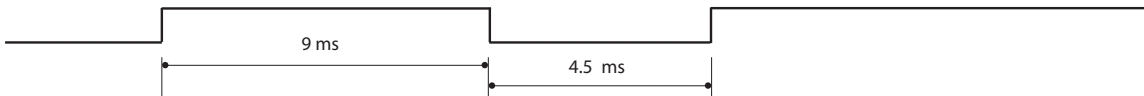

### Repeat Code

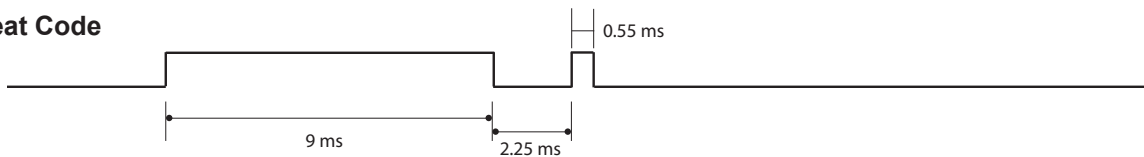

### Bit Description

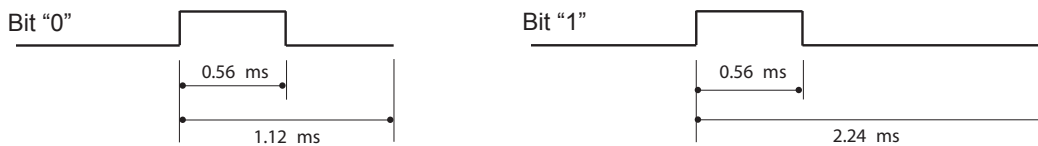

### Frame Interval: Tf

The waveform is transmitted as long as a key is depressed.

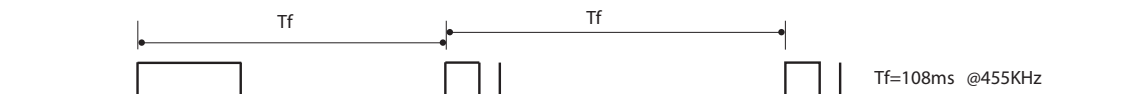

## Reference: IR Codes (Cont.)

Code (Hexa)	Function	Note
08	POWER	Remote Control Button (Power On/Off)
0F	TV	Remote Control Button
0B	INPUT	Remote Control Button
0A	SAP	Remote Control Button
AB	◀◀ RATIO	Remote Control Button
AA	GUIDE	Remote Control Button
4C	PORTAL	Remote Control Button
AA	INFO	Remote Control Button
10-19	Number Key 0–9	Remote Control Button
4C	- (Dash)	Remote Control Button
1A	FLASHBK	Remote Control Button
02	VOL +	Remote Control Button
03	VOL -	Remote Control Button
00	CH ^	Remote Control Button
01	CH v	Remote Control Button
0E	▶▶ TIMER	Remote Control Button
39	CC	Remote Control Button
09	MUTE	Remote Control Button
43	MENU	Remote Control Button
5B	RETURN	Remote Control Button
40	^	Remote Control Button
41	v	Remote Control Button
07	<	Remote Control Button
06	>	Remote Control Button
44	ENTER	Remote Control Button
60	PIP	Remote Control Button
71	PIP CH +	Remote Control Button
72	PIP CH -	Remote Control Button
63	PIP SWAP	Remote Control Button
61	PIP INPUT	Remote Control Button
C1	■ Stop	Remote Control Button
C0	▶ Play	Remote Control Button
C2	Pause	Remote Control Button
C3	● (Record)	Remote Control Button

Code (Hexa)	Function	Note
D6	TV	Discrete IR Code (TV Input Selection)
5A	AV1	Discrete IR Code (AV1 Input Selection)
D0	AV2	Discrete IR Code (AV2 Input Selection)
BF	COMPONENT	Discrete IR Code (COMPONENT Input Selection)
D5	RGB-PC	Discrete IR Code (RGB Input Selection)
CE	HDMI1	Discrete IR Code (HDMI1 Input Selection)
CC	HDMI2	Discrete IR Code (HDMI2 Input Selection)
76	Ratio 4:3	Discrete IR Code (Only 4:3 Mode)
77	Ratio 16:9	Discrete IR Code (Only 16:9 Mode)
AF	Ratio Zoom	Discrete IR Code (Only Zoom Mode)
C4	POWER ON	Discrete IR Code (Only Power On)
C5	POWER OFF	Discrete IR Code (Only Power Off)

### Some Quick and Easy Tips for Resolving Problems

Symptom	Possible Cause(s)	Possible Solution(s)
<b>Software Problems</b>		
Cannot direct enter channel number or "No Signal" appears.	Channel not included in channel lineup in internal STB controller (PTC).	After 2-5-5 + MENU, only channels included in STB PTC will appear. If channel is available, it can be added to channel lineup. If it is not available, the "No Signal" message appears on the display screen.

### Power

No power.	See troubleshooting flow chart on following page.
-----------	---

### Display Panel Picture

No picture.	Display panel is turned off.	<ul style="list-style-type: none"> <li>• Turn STB ON.</li> <li>• Power failure?</li> </ul>
	Antenna/cable not connected.	Connect antenna/cable signal to STB.
	Connections incorrect.	Check connections on STB.
	MPI not connected.	If applicable, connect MPI cable to MPI device.
	Encrypted program.	Try another channel.
	Wrong tuning band.	Adjust Installer Menu settings.

### Erratic Operation

Installer Menu setup.	Wrong Installer Menu settings.	Adjust Installer Menu settings as required.
-----------------------	--------------------------------	---

### Installer Remote

Remote doesn't work.	Remote not in TV Mode.	Use MODE key to select "TV"; puts remote into TV Mode.
	Not aimed at IR remote sensor.	Point remote at IR receiver on display panel.
	Remote too far from IR sensor.	Move remote closer to IR receiver on display panel or darken room.
	MPI not connected.	If applicable, connect MPI cable to MPI device.
	IR path to STB's receiver obstructed.	Remove obstructions.
	Weak batteries.	Replace batteries.
	Wrong battery polarity.	Check that "+" and "-" match in battery compartment.
	Too much light in room.	Dim room light.
Wrong Installer Remote.	Requires compatible Installer Remote. Contact your LG dealer.	

### Picture Reception

Normal picture, poor or no sound.	Audio muted.	Press MUTE or use Volume Up key to increase sound level.
	Broadcast problem.	Try a different channel.

**Note:** For other problems not caused by the STB, refer to the other devices' operating guide(s).

# Troubleshooting (Cont.)

## Troubleshooting Flow Chart

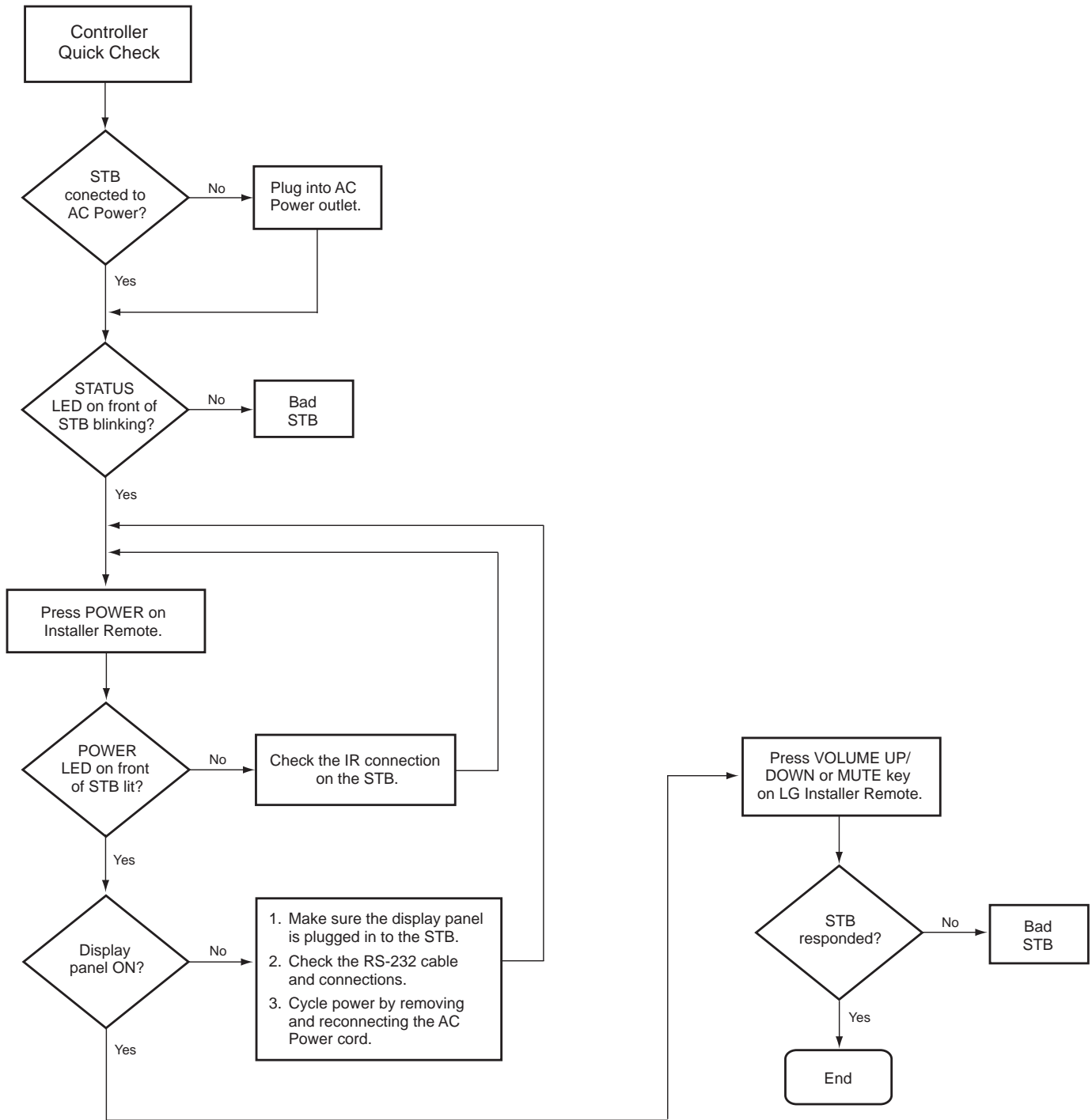



## Commercial Mode Check / FTG Operation Troubleshooting

### Commercial Mode Check

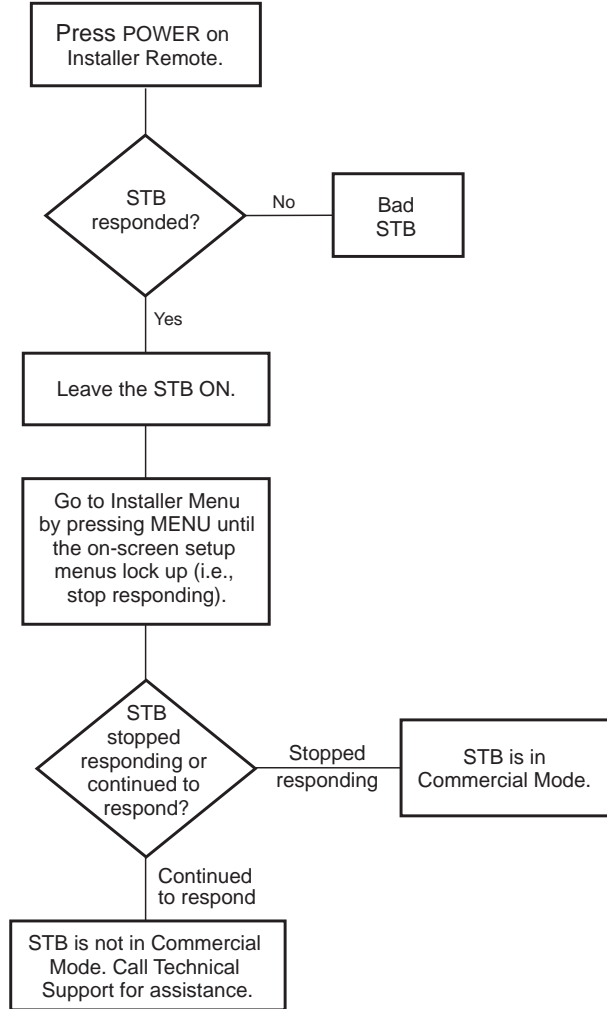

### FTG Operation Troubleshooting

The following table provides troubleshooting information for when the EBL is configured in the FTG Mode of operation.

Symptom	Possible Cause(s)	Solution(s)
Communication Error ("Communications Timeout")	Cable(s) not connected.	Check and connect communication cables.
	STB/display not powered.	Check/connect the STB power cord.
	STB/display not turned ON.	STB/display needs to be turned ON (default FTG Mode).
	Wrong COM (communication) port.	In the FTG Configuration Application, select the correct COM port for the cable being used.

# Troubleshooting (Cont.)

## Clone Programmer Troubleshooting



**Warning:** Do not connect a clone programmer to the STB1000 MPI/GAME CONTROL port while the STB is in LodgeNet PPV Mode, as this will damage the clone programmer.

### Reset Clone Programmer After Static Shock

After replacing exhausted batteries (LT2002 only), or if the clone programmer behaves strangely after a static shock:

- TLL-1100A: Turn the TLL-1100A OFF and then ON.
- LT2002: Use a paper clip or similar instrument inserted through the small hole marked RESET to activate the internal reset switch and restore normal operation.

After a reset, check the real-time clock setting. It may be necessary to reset the clone programmer clock from an STB containing the correct time.

**Note:** For both Master and Target STB1000s—The STB EBL must be in Pass-through Mode.

Symptom	Possible Cause(s)	Possible Solution(s)
<b>Clone Programmer</b>		
Clone copies setup in less than 30 seconds.	Not enough time to copy entire STB setup.	TLL-1100A: Turn the TLL-1100A OFF and then ON. LT2002: Press RESET on clone programmer. Then redo Learn/Teach. (Learning usually takes about 90 seconds; Teaching usually takes 3 to 4 minutes.)
Remote does not operate clone programmer.	Wrong Installer Remote.	Only use an LG Installer Remote to operate clone programmer with STB.
Clone menu does not appear on display panel screen, TLL-1100A shows error message, or LT2002 LED does not blink.	MPI cord not connected.	Connect MPI cord properly, and ensure good connection.
	STB/display not turned ON.	STB/display must be powered ON for clone programmer to work.
	(LT2002 only) Weak batteries.	Install four (4) fresh AA high-quality alkaline batteries.
	(TLL-1100A only) No charge.	Ensure the TLL-1100A is fully charged or connected to AC power.
Clone menu hard to read.	Weak signal.	Connect STB to a reliable analog channel signal source.
No time set.	Time not available.	Set time on an STB, and copy time to clone programmer.
Clone not working.	Clone programmer problem.	Try a different clone programmer.
		Reset the clone programmer.
Clone scans channels more than once.	Clone should only scan channels once.	Ensure STB is set up correctly, and try cloning again.

### Master and Target STBs

Cloning did not work.	Procedure interrupted.	Wait until procedure complete message is displayed.
	Different STB models.	Cloning is only possible with identical model STBs.
	Step(s) omitted or not performed.	Refer to the applicable cloning procedure(s), and make sure all tasks were performed.
(LT2002 only) Clone time disappeared.	Batteries were removed.	Batteries must remain installed to retain time settings.
New setup not present.	Target STB not reset.	Disconnect Target STB from AC power for 15 seconds.

- After cloning operations are complete, unplug the TLL-1100A/LT2002 from the STB.
- If the display panel does not show a picture on the (blank) screen after a few seconds, just change channels.

## Dimensions

Height: 1.77 inches (45 mm)  
Width: 13.875 inches (352.42 mm)  
Depth: 9.72 inches (247 mm)  
Weight: 6.4 pounds (2.90 kgms)

## Environmental Storage Conditions

Temperature: -20 to 50 degrees Celsius  
-4 to 122 degrees Fahrenheit  
Humidity: 10% to 90%

## Environmental Operating Conditions

Temperature: 0 to 40 degrees Celsius  
32 to 104 degrees Fahrenheit  
Humidity: 10% to 80% RH, non-condensing

## Power Supply

Input: AC 100 to 120V @ 50 to 60 Hz

## Television System

NTSC-M, 64 & 256 QAM, VSB

## Program Coverage

VHF : 02~13, UHF : 14~69, CATV : 01~135, DTV : 02-69, CADTV : 01~135

## Digital Video Out

DVI Format (1360\*768 @ 60 Hz, reduced blanking)

## Audio Out

Stereo (Analog, variable output)

## External Antenna Impedance

75 ohm

Note: Design and specifications subject to change without prior notice.

# Glossary of Terms

---

A list of definitions for some of the words found in this guide.

## **75 OHM RF CABLE**

The wire that comes from an off-air antenna or cable service provider. The end looks like a hex-shaped nut with a wire through the middle. It screws onto the Antenna/Cable threaded jack on the back of the TV.

## **300 TO 75 OHM ADAPTER**

A small device that connects a 2-wire 300 ohm antenna to a 75 ohm RF jack. It is usually about an inch long with two screws on one end and a round opening with a wire extending out the other end.

## **A/V CABLES**

Audio/Video cables. Three cables bunched together—right audio (red), left audio (white), and video (yellow). A/V cables are used for stereo playback of videocassettes and for higher quality picture and sound from other A/V devices.

## **A/V DEVICE**

Any device that produces video or sound (VCR, DVD, cable box, or television).

## **AMPLIFIER**

An electronic device that amplifies sound from a television, CD player, VCR, DVD, or other Audio/Video device.

## **ANTENNA**

The physical receiver of television signals sent over the air. A large metal piece of equipment does not always have to be visible to be using an antenna.

## **b-LAN**

Licensed proprietary RF communication system used to configure/control TV via RF distribution system.

## **CABLE**

Cable service box. Refers to the descrambler box cable subscribers use to receive cable programming signals.

## **CATV**

Programming provided by a cable service.

## **COMPONENT VIDEO**

Uses three wires for transporting three-color video signals. The end result is usually better video quality.

## **COMPOSITE VIDEO**

Typical video jack, uses one wire for transporting three-color video signals.

## **DELETE**

Lets you remove channels from the list that the end user can scroll through using Channel Up/Down.

## **DIGITAL TELEVISION**

High-resolution, cinema-quality television signals transmitted digitally.

## **DVI**

Digital Video Interface. Accommodates analog and digital interfaces with a single connector.

## **HDMI**

High-definition multi-media interface.

## **HDSTB**

High-definition set top box. Refers to a tuner device that receives high-definition television signals which have higher resolution than ordinary analog TV signals.

## **HDTV**

High-definition television. Refers to television signals that have higher resolution than ordinary analog TV signals.

## **INPUT**

Refers to the input jack that receives a signal from a TV, VCR, DVD Player or other Audio/Video device.

## **JACK**

An input or output connector on the back of a TV, VCR, DVD Player or other Audio/Video device.

## **MONO SOUND**

Mono (monaural) sound is one channel of sound. On more than one speaker, all the speakers play the same audio.

## **OUTPUT**

Refers to the output jack that sends a signal out of a VCR, DVD, or other A/V device.

## **PHYSICAL CHANNEL NUMBER**

The actual channel number. Analog channels use the Physical Channel number and digital channels can use a Virtual Channel number.

## **RGB (RED, GREEN, BLUE)**

Connection input or output port available for producing a video image using three separate colors: Red, Green, and Blue.

## **RS-232**

Serial communication port through which firmware is downloaded.

## **2ND AUDIO PROGRAMMING/SAP**

Second Audio Programming (SAP) is another, separate audio channel available with some programming. Choosing SAP often refers to listening to audio in another language, such as Spanish or French.

## **SIGNAL**

Picture and sound traveling through a cable, or over the air, to the TV.

## **STEREO SOUND**

Stereo (Stereophonic) sound refers to audio that's divided into right and left sides.

## **TUNER**

Device that picks up the broadcast signal and turns it into picture and sound.

## **VIRTUAL CHANNEL NUMBER**

A re-mapped channel number. Analog channels use the Physical Channel number; however digital channels use a Virtual (or false) Channel number.

## **XDS**

Extended Data Service (XDS) is additional program information included on the signal provided at the discretion of the broadcaster.

---

Note: Refer to [www.atsc.org](http://www.atsc.org) for further information.

## Document Revision History

Date	Description
February 2011	Revision A: New document

Product documentation is available online at: [www.LGolutions.com/products](http://www.LGolutions.com/products). From the Products page, select **TVs, Systems & Solutions**, then **Interface / Control Boxes & Cards**, then **STB1000**. Click the **Literature & Downloads** tab at the bottom of the STB1000 page, and select the required document(s) from the Downloads list.

---

## Notes

# LG STB1000 HD Commercial Interface STB Warranty

**Broadcast Products** Welcome to the LG family! We believe that you will be pleased with your new STB1000 HD Commercial Interface STB. Please read this warranty carefully, it is a "LIMITED WARRANTY" as defined under Federal Law. This warranty gives you specific legal rights, and you may also have other rights that vary from state-to-state within the U.S.A.

## LG's RESPONSIBILITY

**Warranty Term** One year parts and labor from date of purchase or delivery date.

**Parts** New or remanufactured replacements for factory-defective parts may be used. Such replacement parts are warranted for the remaining portion of the original warranty period.

**Warranty Service** Warranty service is provided at LG. Customer pays for shipping charges to LG; LG pays for return shipping charges to return STB1000 to customer. Call 1-888-865-3026 for further information.

**Not Covered** This warranty covers manufacturing defects and does not cover installation, adjustment of customer controls, installation or repair of antenna systems, cable converters or cable company-supplied equipment; it also does not cover damage due to misuse, abuse, negligence, acts of God or other causes beyond the control of LG. Any alteration of the product after manufacture voids this warranty in its entirety.

THIS WARRANTY IS IN LIEU OF ANY OTHER WARRANTY, EXPRESS OR IMPLIED, INCLUDING WITHOUT LIMITATION, ANY WARRANTY OF MERCHANTABILITY OR FITNESS FOR A PARTICULAR PURPOSE, AND LG SHALL NOT BE LIABLE FOR ANY CONSEQUENTIAL, INDIRECT, OR INCIDENTAL DAMAGES OF ANY KIND, INCLUDING LOST REVENUES OR PROFITS IN CONNECTION WITH THIS PRODUCT. SOME STATES DO NOT ALLOW LIMITATIONS ON HOW LONG AN IMPLIED WARRANTY LASTS OR THE EXCLUSION OR LIMITATION OF INCIDENTAL OR CONSEQUENTIAL DAMAGES, SO THE ABOVE LIMITATIONS OR EXCLUSIONS MAY NOT APPLY TO YOU.

## OWNER'S RESPONSIBILITY

**Effective Warranty Date** Warranty begins on the date of delivery of the STB1000.  
For your convenience, keep the dealer's dated bill of sale or delivery ticket as evidence of the purchase date.

**Installation Guide** Read the Installation & Setup Guide carefully so that you will understand the operation of the STB1000 and how to adjust the controls.

**Antenna** Reception problems caused by inadequate antenna or faulty antenna connections are the owner's responsibility.

**Warranty Service** For warranty service information, call 1-888-865-3026. Parts and service labor that are LG's responsibility (see above) will be provided without charge. Other service is at the owner's expense. If you have any problem in obtaining satisfactory warranty service, call 1-888-865-3026.  
You must provide the model number, serial number and date of purchase or date of original installation.

For Customer Support/Service, please call:

**1-888-865-3026**

[www.LGolutions.com](http://www.LGolutions.com)

Pro:Idiom is a registered trademark of Zenith Electronics LLC. Pro:Centric is a trademark of LG Electronics, Inc. b-LAN is a trademark of LodgeNet Interactive Corporation. All other trademarks or registered trademarks are the property of their respective owners.

GNU General Public License (GPL) Version 2 and GNU Lesser General Public License (LGPL) Version 2.1 Agreements are applicable to this product. You can obtain a copy of the GPL and LGPL licenses from: <http://www.gnu.org/licenses/old-licenses/gpl-2.0.html> and <http://www.gnu.org/licenses/old-licenses/lgpl-2.1.html>.

Mozilla Public License (MPL) Version 1.1 is also applicable to this product. You can obtain a copy of the license from: <http://www.mozilla.org/MPL/MPL-1.1.html>.