

Precision Cooling
For Business-Critical Continuity™

Liebert® XDP™ with Liebert® iCOM® Control

User Manual—50-60 Hz; 160kW Nominal Capacity



TABLE OF CONTENTS

IMPORTANT SAFETY INSTRUCTIONS	INSIDE FRONT COVER
1.0 PRODUCT DESCRIPTION	3
1.1 General Product Information	3
1.1.1 Product/System Description	3
1.1.2 Minimum Load	3
1.2 Equipment Inspection	3
1.3 Equipment Handling	4
1.3.1 Handling the Liebert XDP While it is on Skid and Packaged	4
1.3.2 Unpacking the Liebert XDP	5
1.3.3 Removing the Unit from the Skid Using a Forklift	5
1.3.4 Removing the Unit from the Skid using Rigging	6
1.3.5 Moving the Liebert XDP Using Piano Jacks	7
1.3.6 Removing the Unit from the Piano Jacks	8
2.0 INSTALLATION	9
2.1 Mechanical Considerations	9
2.1.1 Positioning the Liebert XDP	9
2.2 Electrical Considerations	10
2.2.1 Connecting High-Voltage Cables	11
2.2.2 Extra Low Voltage (ELV) Connections	13
2.2.3 DIP Switch and Jumper Settings for Remote Sensors	15
2.3 Field Connections—Optional for All Units	16
2.4 Remote Sensor Installation—Proper Placement	17
3.0 PIPING	18
3.1 European Union Fluorinated Greenhouse Gas Requirements	18
3.2 Connection Sizes	18
3.2.1 Recommended Pipe Size	18
3.3 Liebert XDP Interconnection with Liebert XD Cooling Modules	19
3.4 Piping Installation Methods	19
3.4.1 Piping Installation—R-134a Pumped Circuit	19
3.4.2 Piping Mains	20
3.4.3 Bypass Flow Controller	20
3.5 Piping Details—Shutoff/Isolation Valves	21
3.5.1 Evacuation and Leak Check—R-134a Pumped Circuit	22
3.5.2 Insulation	22
3.6 Filling the Pumped Circuit—R-134a	23
3.6.1 Calculating Refrigerant Charge—Example	24
3.7 Checklist for Proper Installation	25
4.0 LIEBERT ICOM CONTROL—FIRMWARE VERSION XP1.00.010.STD	26
4.1 Liebert iCOM Components and Functions	26
4.2 Display Lamp Indicators	27

4.3	Navigating Through the Liebert iCOM Display	28
4.3.1	Accessing Menus and Settings	28
4.3.2	Cooling Module Overview	29
4.3.3	Entering the Password	30
4.4	Changing Liebert iCOM's Display Settings	31
4.5	Changing Operational Settings	31
4.6	Graphical Data Record	32
4.7	Liebert iCOM User Menu Icons and Legend	32
4.8	Liebert iCOM User Menu Screens	34
4.9	Liebert iCOM Service Menu Icons and Legend	41
4.10	Liebert iCOM Service Menu Screens	42
5.0	START THE LIEBERT XDP WITH LIEBERT iCOM	64
5.1	Checklist for Liebert XDP Startup	64
5.2	Starting the Liebert XDP with Liebert iCOM Controller	65
6.0	ALARM DESCRIPTIONS AND SOLUTIONS	66
6.1	Alarm Descriptions	66
6.2	Warning Descriptions	68
6.3	System Shutdown Causes	68
7.0	TROUBLESHOOTING	69
8.0	MAINTENANCE	71
8.1	Fluorinated Greenhouse Gas Requirements	71
9.0	SPECIFICATIONS	72
	COMPLIANCE WITH EUROPEAN UNION DIRECTIVES	INSIDE BACK COVER

FIGURES

Figure 1	Model number nomenclature	2
Figure 2	Liebert XDP components	3
Figure 3	Unpacking the Liebert XDP	5
Figure 4	Use a forklift to remove the Liebert XDP from the skid	6
Figure 5	Removing the unit from the skid using rigging	7
Figure 6	Securing the Liebert XDP to piano jacks	8
Figure 7	Dimensions	9
Figure 8	Piping access points	10
Figure 9	Front view of Liebert XDP and electrical enclosure	11
Figure 10	Electrical enclosure knockout location for hazardous voltage wiring	12
Figure 11	High voltage connections—60Hz	12
Figure 12	High voltage connections—50Hz	13
Figure 13	Electrical enclosure knockout locations for Extra Low Voltage	13
Figure 14	Connecting the remote temperature/humidity sensors	14
Figure 15	DIP switch and jumper settings	15
Figure 16	Unit-to-unit networking connections	15
Figure 17	Liebert XDP extra low voltage field connections points	16
Figure 18	Suggested remote sensor placement	17
Figure 19	Liebert XD system diagram	19
Figure 20	Bypass flow controller details, dimensions	20
Figure 21	Bypass flow controller arrangement	21
Figure 22	Bypass flow controller piping	21
Figure 23	General piping details	22
Figure 24	Liebert iCOM display components	26
Figure 25	Liebert iCOM default home screen	28
Figure 26	Cooling module overview, first 10 modules	29
Figure 27	Entering the password	30
Figure 28	Display setup screen	31
Figure 29	Liebert iCOM User Menu icons	32
Figure 30	Liebert XDP User Menu screen	33
Figure 31	Setpoints screen	34
Figure 32	Set Alarms screen	35
Figure 33	Sensor Data screen, page 1 of 2	36
Figure 34	Sensor Data screen, page 2 of 2	37
Figure 35	Display Setup screen	38
Figure 36	Module Status screen, page 1 of 20	39
Figure 37	Liebert XDV Smart Module Status screen	39
Figure 38	Liebert XDH Smart Module Status screen—each bank shown separately	40
Figure 39	Liebert XDO Smart Module Status screen	40
Figure 40	Total Run Hours screen	41
Figure 41	Liebert iCOM Service Menu icons	41
Figure 42	Liebert XDP Service Menu screen	42
Figure 43	Setpoints screen	42
Figure 44	Maintenance—Basic Settings screen, page 1 of 7	44
Figure 45	Maintenance—Pump 1 Settings screen, page 2 of 7	45
Figure 46	Maintenance—Pump 2 Settings screen, page 3 of 7	46
Figure 47	Maintenance screens, pages 4 through 7	46
Figure 48	Diagnostics/Service Mode screen, page 1 of 6	47
Figure 49	Diagnostics/Service Mode screen, page 2 of 6	47

Figure 50	Diagnostics/Service Mode screen, page 3 of 6	48
Figure 51	Diagnostics/Service Mode screen, page 4 of 6	48
Figure 52	Diagnostics/Service Mode screen, page 5 of 6	49
Figure 53	Diagnostics/Service Mode screen, page 6 of 6	49
Figure 54	Set Alarms screen, page 1 of 7	50
Figure 55	Set Alarms screen, page 2 of 7	51
Figure 56	Set Alarms screen, page 3 of 7	52
Figure 57	Set Alarms screen, page 4 of 7	53
Figure 58	Set Alarms screens, pages 5 and 6	54
Figure 59	Set Alarms screen, page 7 of 7	54
Figure 60	Sensor Calibration/Setup screen, page 1 of 3	55
Figure 61	Sensor Calibration/Setup screen, page 2 of 3	56
Figure 62	Sensor Calibration/Setup screen, page 3 of 3	56
Figure 63	System/Network Setup screen—System, page 1 of 2	57
Figure 64	System/Network Setup screen—System, page 2 of 2	58
Figure 65	System/Network Setup screen—Unit, page 1 of 2	59
Figure 66	System/Network Setup screen—Unit, page 2 of 2	60
Figure 67	Options Setup screen, page 1 of 2	61
Figure 68	Options Setup screen, page 2 of 2	62
Figure 69	Module Setup screen, page 1 of 20	62
Figure 70	Module Setup screen, page 1 of 20	63
Figure 71	System R-134a liquid level at 160kW load	65

TABLES

Table 1	Number of Liebert XD cooling modules required to achieve at least 48kW (163,800 BTU/H) load.	3
Table 2	Liebert XDP dimensions	9
Table 3	Unit piping outlet connection sizes, inches, OD Cu	10
Table 4	Supply, return pipe sizes for refrigerant loop	18
Table 5	Bypass flow controllers for a Liebert XDP-based system	20
Table 6	System R-134a charge for a Liebert XDP with any model Liebert XDH/Liebert XDO/Liebert XDV/Liebert XDCF/Liebert XDR	23
Table 7	System refrigerant charge for the supply and return mains	23
Table 8	R-134a refrigerant charge for hard-piped connector lines to and from any model Liebert XDH/Liebert XDO/Liebert XDV/Liebert XDCF/Liebert XDR	23
Table 9	R-134a refrigerant charge for Flex Pipe connector lines to and from any model Liebert XDO/Liebert XDH/Liebert XDV/Liebert XDCF/Liebert XDR	24
Table 10	Calculating refrigerant charge—example	24
Table 11	Worksheet to calculate refrigerant charge	24
Table 12	Keyboard icons and functions.	27
Table 13	Liebert XDP pump light indicator—208V and 400V units.	64
Table 14	Troubleshooting the Liebert XDP	69
Table 15	Liebert XDP160 specifications	72

IMPORTANT SAFETY INSTRUCTIONS

SAVE THESE INSTRUCTIONS

This manual contains important safety instructions that should be followed during the installation and maintenance of the Liebert XDP. Read this manual thoroughly before attempting to install or operate this unit.

Only qualified personnel should move, install or service this equipment.

Adhere to all warnings, cautions, notices and installation, operating and safety instructions on the unit and in this manual. Follow all operating and user instructions.

Follow all local codes.



WARNING

Risk of arc flash and electric shock. Can cause property damage, injury or death.

Disconnect all local and remote electric power supplies and wear protective equipment per NFPA 70E before working within electric control enclosure. Failure to comply can cause serious injury or death.

Customer must provide earth ground to unit, per NEC, CEC and local codes, as applicable.

Before proceeding with installation, read all instructions, verify that all the parts are included and check the nameplate to be sure the voltage matches available utility power.

The Liebert iCOM microprocessor does not isolate power from the unit, even in the Unit Off mode. Some internal components require and receive power even during the Unit Off mode of Liebert iCOM control.

The line side of the disconnect switch on the front of the unit contains live high-voltage.

The only way to ensure that there is NO voltage inside the unit is to install and open a remote disconnect switch. Refer to unit electrical schematic.

Follow all local codes.



WARNING

Risk of unit falling over. Can cause property damage, injury or death.

The XDP is top-heavy. Use extreme caution and care when moving and installing this unit.



CAUTION

Risk of piping and component rupture. Can cause injury or equipment damage.

System is pressurized. Relieve pressure through access valve before working on unit. Closing service valves may isolate liquid refrigerant, causing high pressure and rupture of piping. Do not close valves without following recommended procedures for repair, maintenance and replacement of components. Install pressure relief valves in field piping that may become isolated by service valves. System is pressurized. Relieve pressure through access valve before working on unit



NOTE

This document is intended to be used together with site specific documentation and documentation for other parts of the system (heat rejection devices and cooling modules).



NOTE

Before any action that could cause a disturbance in the XD system's cooling function is begun, the facility manager MUST be informed. In addition, after the action is taken and the work is finished, the facility manager MUST be informed.

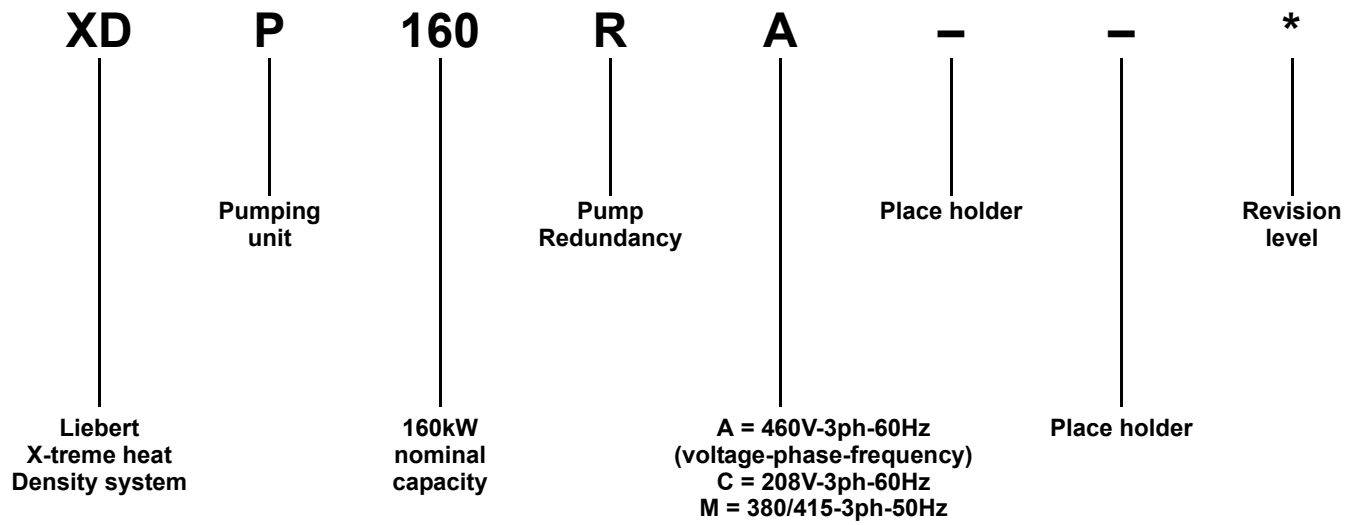
NOTICE

Risk of leaking chilled water lines. Can cause equipment and building damage.

Lines and joints must be inspected regularly. Improper installation, application and service practices can result in water leakage from the unit. Water leakage can result in severe property damage and loss of critical data center equipment. Do not locate unit directly above any equipment that could sustain water damage. Emerson Network Power recommends installing monitored leak detection equipment for the unit and supply and return lines.

Figure 1 Model number nomenclature

Example: XDP160RA--4



1.0 PRODUCT DESCRIPTION

1.1 General Product Information

1.1.1 Product/System Description

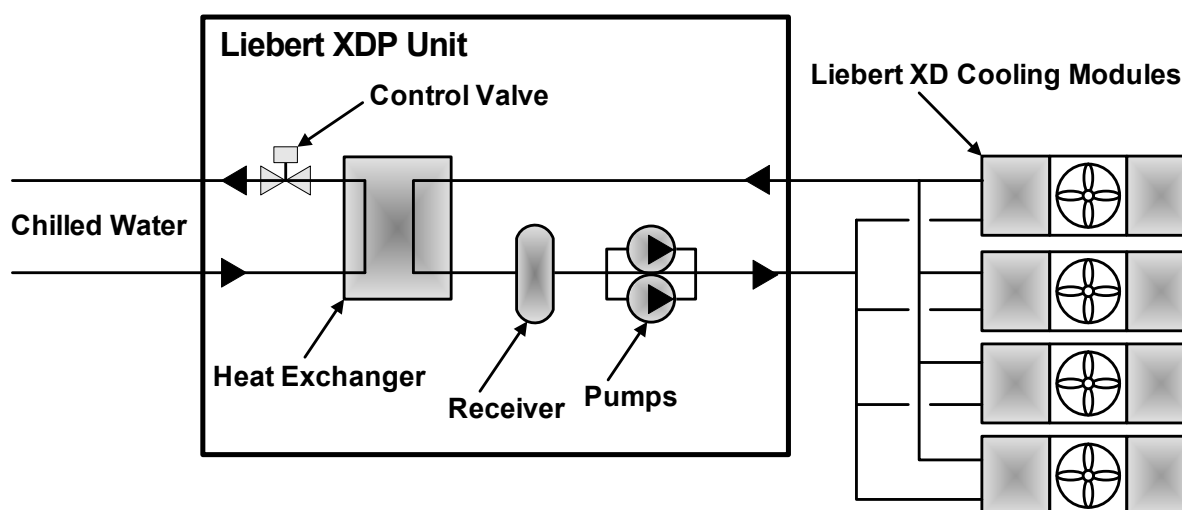
Liebert's XDP refrigerant distribution unit is an interface between the building chilled water system and the cooling modules in the Liebert XD system. It is designed to circulate and control refrigerant to the cooling modules that are in the room with heat-producing equipment. The Liebert XDP is rated for 160kW (546,000BTU/H) of cooling.

The Liebert XDP consists of a cabinet that includes a heat exchanger, circulating pump(s), control valve, receiver, controls, valves and piping.

The Liebert XDP monitors room conditions and prevents coil condensation by maintaining the refrigerant being pumped to the cooling modules at a temperature above the room's dew point.

All functions, such as switching pumps (if applicable), controlling refrigerant temperature, etc., are automatic.

Figure 2 Liebert XDP components



1.1.2 Minimum Load

The Liebert XDP's minimum recommended operating load is 30% of system nominal capacity. The Liebert XDP160 is rated for 160kW (546,000BTU/H) of cooling, therefore the system's minimum recommended load is 48kW (163,800BTU/H). Loading below this value can unfavorably affect system operation. Consult the factory for any loading below this recommendation.

To achieve the minimum recommended load, the capacity of all connected modules must total at least 48kW (163,800BTU/H). See **Table 1**.

Table 1 Number of Liebert XD cooling modules required to achieve at least 48kW (163,800 BTU/H) load

	Liebert XD Module Type							
	XDCF10	XDV8	XDV10	XDO16	XDO20	XDH20	XDH32	XDR20
Number of Liebert XD cooling modules required to achieve at least 48kW (163,800BTU/H) load	5	6	5	3	3	3	2	3

1.2 Equipment Inspection

When the unit is delivered, inspect all items for visible and concealed damage. Damage should be immediately reported to the carrier and a damage claim filed with a copy sent to Emerson and to your sales representative.

1.3 Equipment Handling



WARNING

Risk of unit falling over. Can cause injury or death.

The Liebert XDP is top-heavy. Use extreme caution and care when moving and installing this unit. Use lifting equipment that is rated for the weight of the unit by an OSHA-certified rating organization. See **Table 15** for unit weights. Unit weights are specified in section 9.0 Personnel should be properly trained and certified to move and rig equipment



CAUTION

Risk of sharp edges, splinters and exposed fasteners. Can cause injury.

Only properly trained and qualified personnel wearing appropriate safety headgear, gloves, shoes and glasses should attempt to move, lift, remove packaging from or prepare the unit for installation.

1.3.1 Handling the Liebert XDP While it is on Skid and Packaged

- Always keep the unit upright, indoors and protected from damage.
- If possible, transport the unit using a forklift truck. Otherwise use a crane with belts or cables. In either case, do NOT press on the top edges of the packaging.
- If using a forklift, make sure the forks (if adjustable) are spread to the widest allowable distance to still fit under the skid.
- When moving the skidded unit with a forklift truck, do not lift the unit any higher than 6" (152mm). If circumstances require the unit to be lifted higher than 6" (152mm), great care must be exercised and all by-standing personnel are to be no closer than 20 feet (6m) from the lift point of the unit.

NOTICE

Risk of structural interference. Can cause equipment or building damage.

While on the skid, the unit is too tall (83" [2108mm] overall height) to fit through a standard doorway. Any attempt to move the unit, while skidded, through a standard doorway will cause damage to the unit and to the building.

NOTICE

Risk of damage from forklift. Can cause unit damage.

Keep tines of the forklift level and at a height suitable to fit below the skid and/or unit to prevent exterior and/or underside damage.

NOTICE

Risk of improper storage. Can cause unit damage.

Keep the Liebert XDP upright, indoors and protected from dampness, freezing temperatures and contact damage.

NOTICE

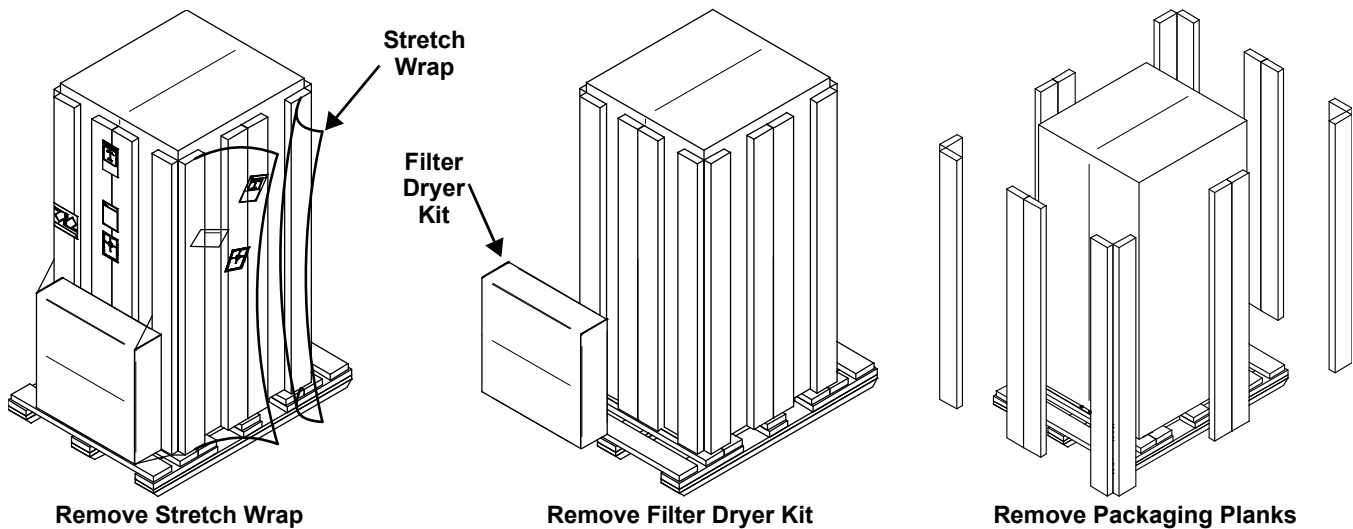
Risk of overtightening securing straps. Can cause damage to panels.

Place a protective material between the straps of the piano jacks and the unit. Ensure that the straps are not tightened to a point of damaging panels.

1.3.2 Unpacking the Liebert XDP

1. Remove the exterior stretch wrap packaging from the unit, exposing the protective corner and side packaging planks.
2. Remove and set aside filter dryer kit.
3. Remove the corner and side packaging planks from the unit, exposing the bag over the unit. The bag may remain in place for dust and panel protection or removed for immediate unit installation.
4. Remove the bag from the unit when ready to remove the skid for installation.

Figure 3 Unpacking the Liebert XDP



1.3.3 Removing the Unit from the Skid Using a Forklift

1. Align the forklift with either the front or rear side of the unit.
Make sure the tines of the forklift are locked to the widest position.
Use the center of gravity indicators to determine the entry points for the tines. The tines must be equally spaced on either side of the center of gravity indicator.
2. Insert the tines of the forklift under the unit.
Make sure the tines are level. The tines must be low enough to fit under the unit without damaging it.
Make sure the tines extend beyond the opposite side of the unit.
3. Remove the 12 lag bolts and two brackets that secure the unit to the skid.

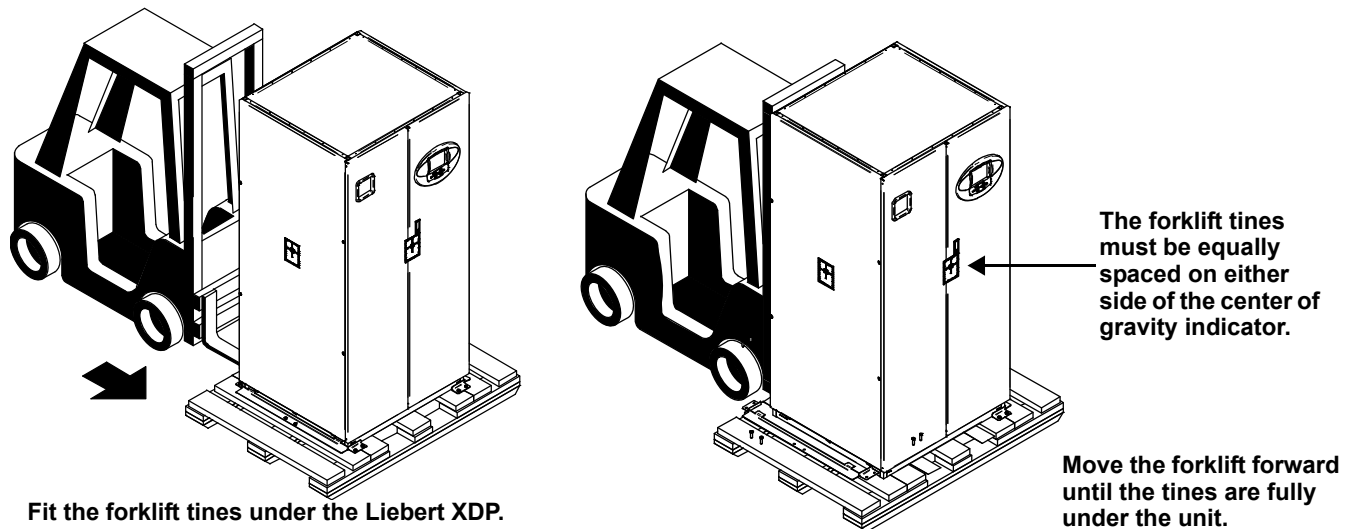


NOTE

Each lag bolt is 1-1/2" (38mm) long. They can be removed with a 9/16" socket or wrench.

4. Lift the unit to a height that it is not being support by the skid.
5. Move the skid from under the unit.

Figure 4 Use a forklift to remove the Liebert XDP from the skid



1.3.4 Removing the Unit from the Skid using Rigging

1. Use the center of gravity indicators on the unit to position the slings. The slings must be equally spaced on either side of the center of gravity indicator. Refer to **Figure 5**.
2. Place slings under the unit using spaces provided between the skid deck boards.



NOTE

Unit is shown without outer packaging. These instructions may be applied with the outer packaging in place.

3. Use spreader bars or an equivalent method to ensure proper protection of the unit.
4. Ensure that the panels, if attached, are well protected from the slings.



NOTE

If rigging is to be used to move the unit closer to the site for installation, place one or two horizontal straps around the unit and vertical straps at mid height.

5. Remove the 12 lag bolts and two brackets that secure the unit to the skid.



NOTE

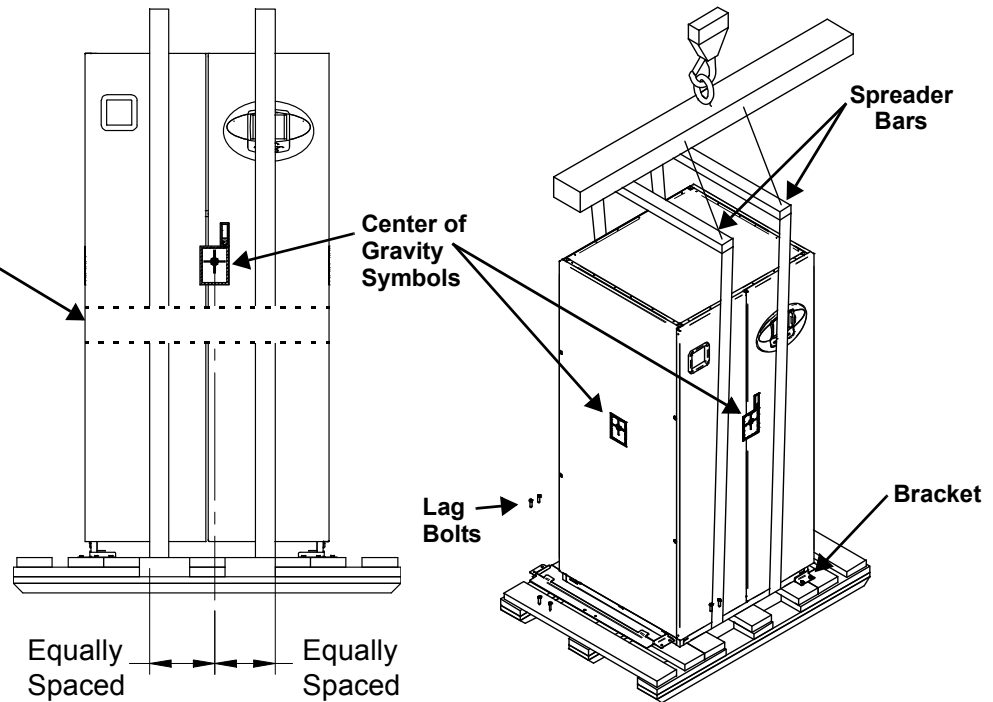
Each lag bolt is 1-1/2" (38mm) long. They can be removed with a 9/16" socket or wrench.

6. Lift the unit off of the skid to an elevation point where the skid is not supporting the weight of the unit.
7. Remove the skid from under the unit.

Figure 5 Removing the unit from the skid using rigging

Cushioning material not shown for clarity.

If rigging will be used to transport the Liebert XDP, place one or two horizontal straps around the unit and the vertical steps about this height.

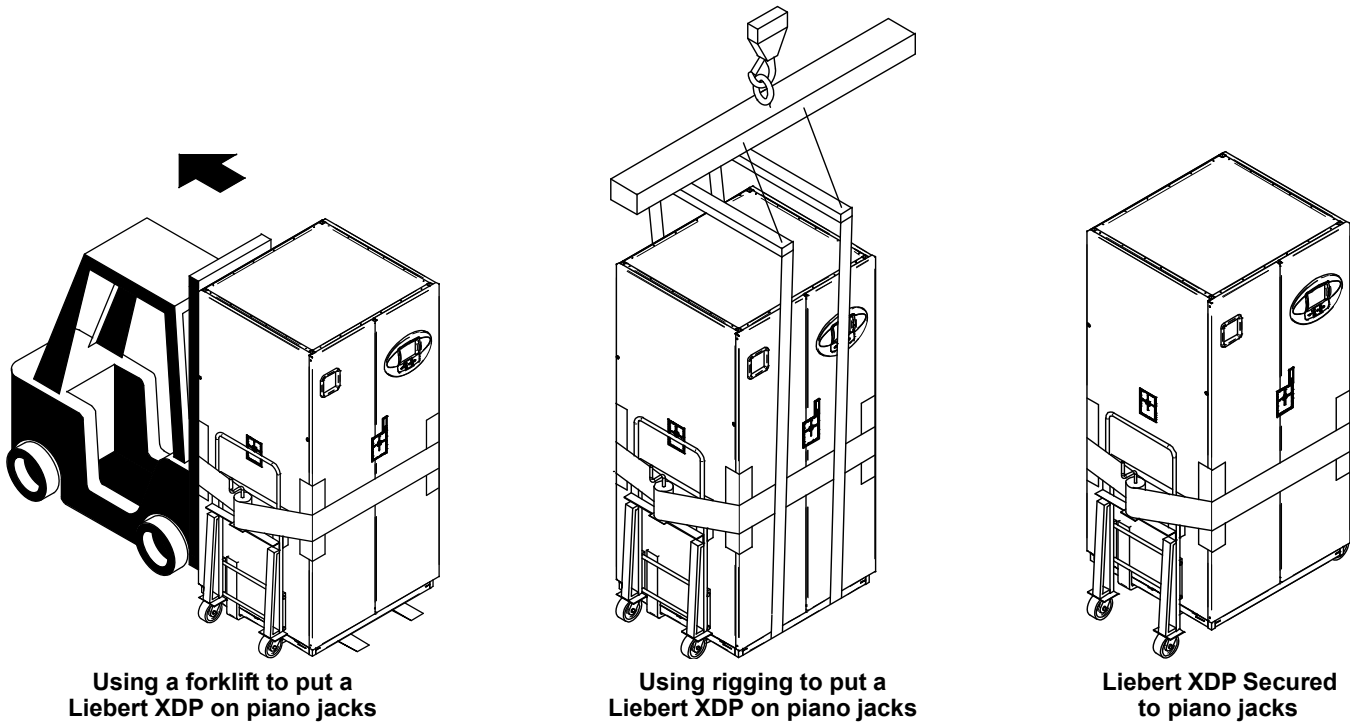


1.3.5 Moving the Liebert XDP Using Piano Jacks

1. Elevate the Liebert XDP with a lifting mechanism, such as a forklift or rigging.
2. Position one piano jack at each end of the Liebert XDP.
3. Lower the unit to a height suitable for placing it on the piano jacks.
4. Put protective material between the Liebert XDP and the piano jacks and straps.
5. Secure the Liebert XDP to the piano jacks.
6. Release the the Liebert XDP from the straps securing it to the lifting mechanism and move the mechanism away from the unit.

Using the piano jacks, at least two properly trained and qualified personnel can move the unit.

Figure 6 Securing the Liebert XDP to piano jacks



1.3.6 Removing the Unit from the Piano Jacks

1. Lower the Liebert XDP as far as the piano jacks will allow.
2. Undo all strapping holding the piano jacks to the unit.
3. Lift one end of the Liebert XDP off one piano jack with a pry bar or similar device, taking care not to damage the unit's cabinet.
4. Repeat **Step 3** to remove the piano jack from under the opposite end of the Liebert XDP.
5. Remove all material used to protect the unit from the piano jacks and strapping.

2.0 INSTALLATION

2.1 Mechanical Considerations

2.1.1 Positioning the Liebert XDP

Install the Liebert XDP according to the site specific documentation and secure the unit to the floor.

The Liebert XDP can be installed near a wall or another Liebert XDP. However, there must be at least 3 feet (92cm) clearance in front of the Liebert XDP as service access for components in the unit.

For additional technical information, refer to the System Design and Configuration Document for the Liebert XD™ System, SL-16655. The document is available in electronic format at Liebert's Web site, www.liebert.com, as well as from your local Emerson representative.

Figure 7 Dimensions

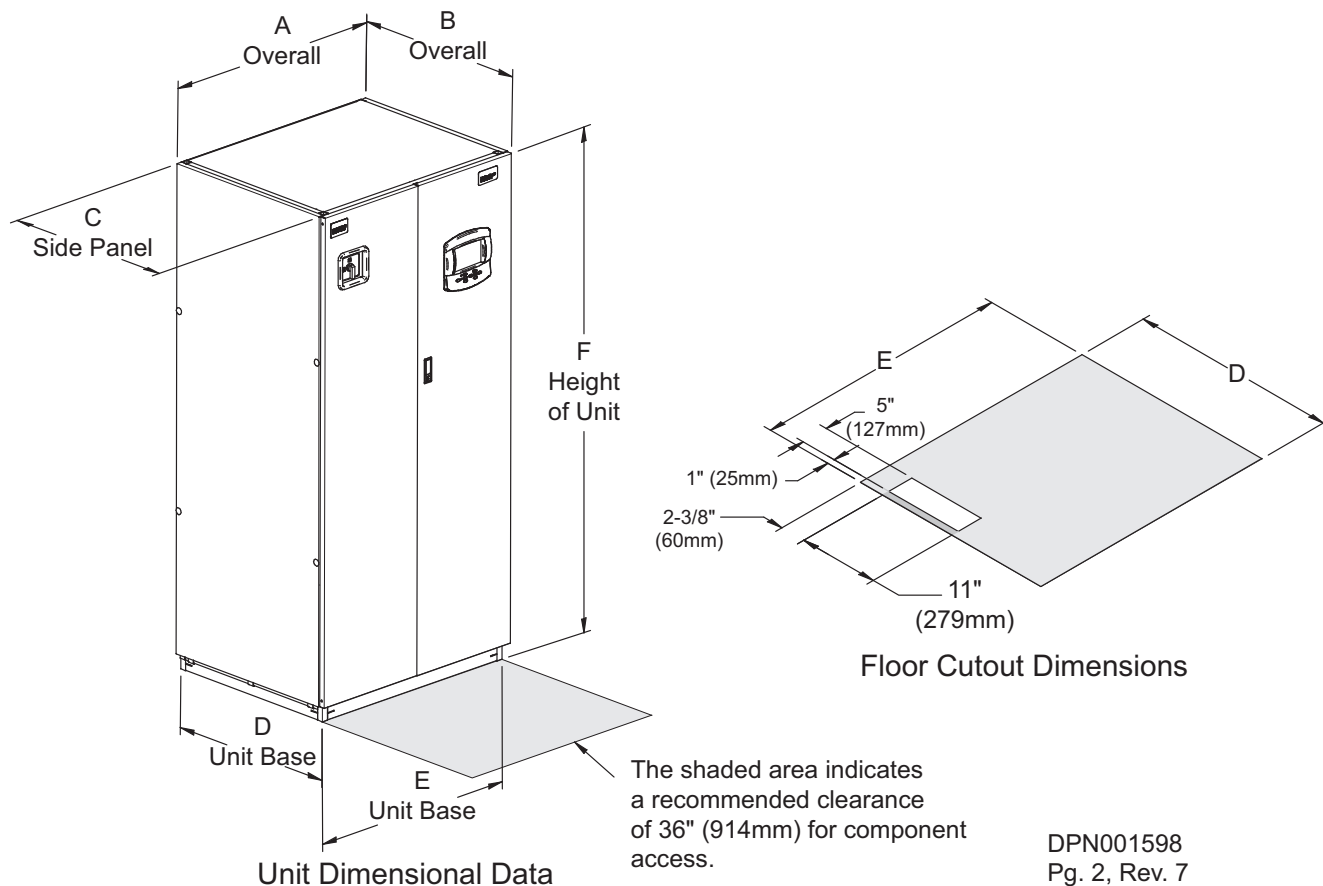


Table 2 Liebert XDP dimensions

Model 50/60Hz	Dimensional Data, inches (mm)						Shipping Weight, lb. (kg)	
	A	B*	C	D	E	H	Domestic	Export
XDP160	38 (965)	34 (864)	33-1/8 (841)	33 (838)	36 (914)	78 (1981)	1020(462)	1083 (491)

* The dimension does not include the bezel of the disconnect switch.

Figure 8 Piping access points

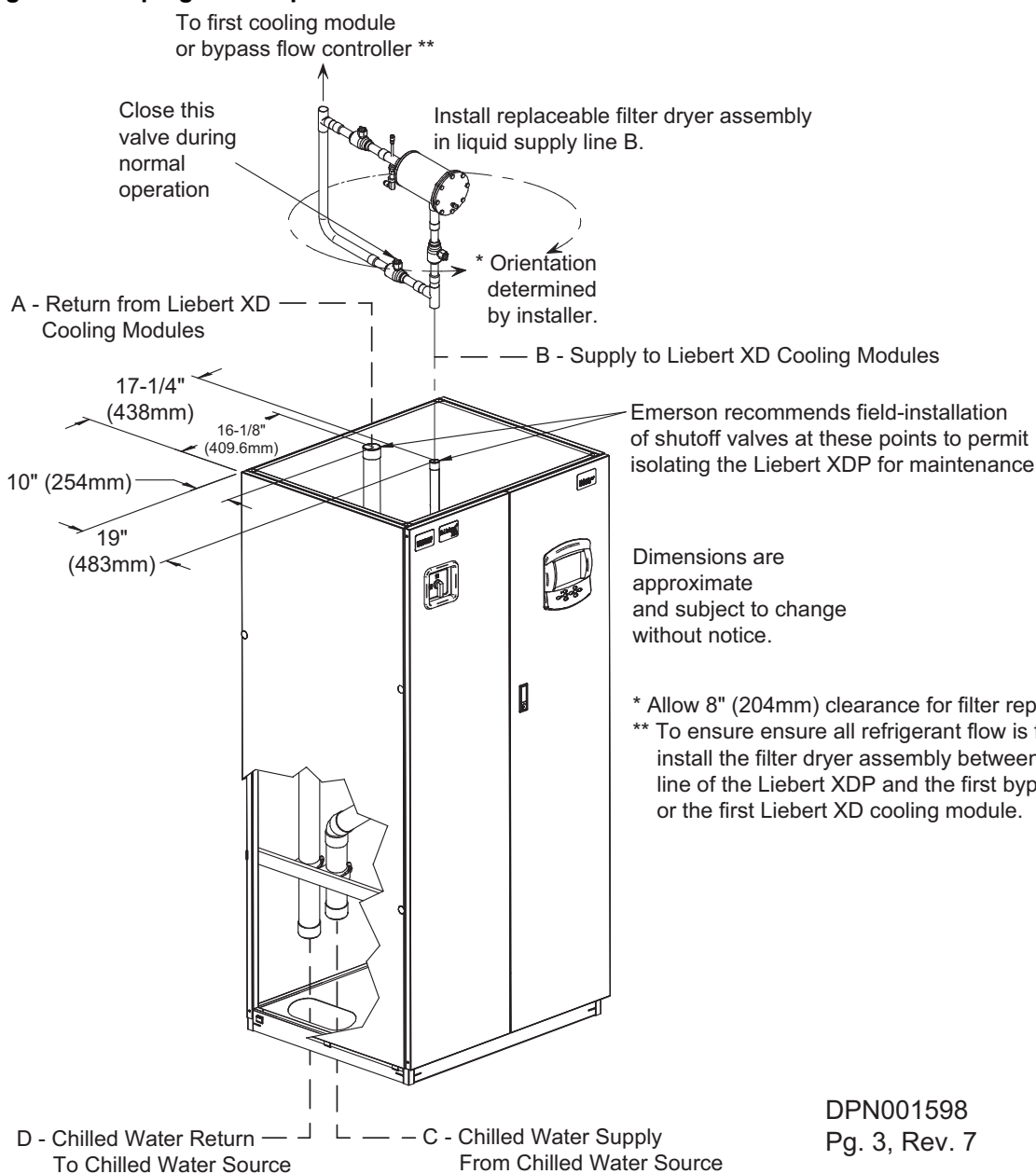


Table 3 Unit piping outlet connection sizes, inches, OD Cu

Model	Pipe Connection Point			
	A	B	C	D
50/60 Hz				
XDP160	2-1/8	1-1/8	2-5/8	2-5/8

2.2 Electrical Considerations

Make sure the actual supply voltage and frequency correspond to the voltage and frequency indicated on the Liebert XDP's rating plate. The unit must be installed in accordance with national wiring regulations.

Connect cables for high voltage supply to the electrical box in the Liebert XDP according to **Figure 11** and make sure that the phases are correctly connected.



WARNING

Risk of electric shock. Can cause injury or death.

Disconnect all local and remote electric power before working within the unit.

WARNING

Risk of electrical shock, short circuit and/or control malfunction. Can cause equipment damage, injury or death.

Damage to wiring or components can make unit unsafe to operate.

Use caution when installing wiring to prevent damage to factory wiring.

Install protective bushings in wiring knockouts as required to protect wiring from sharp edges.

Do not disturb factory wiring or route field-installed wiring over electrical terminals.

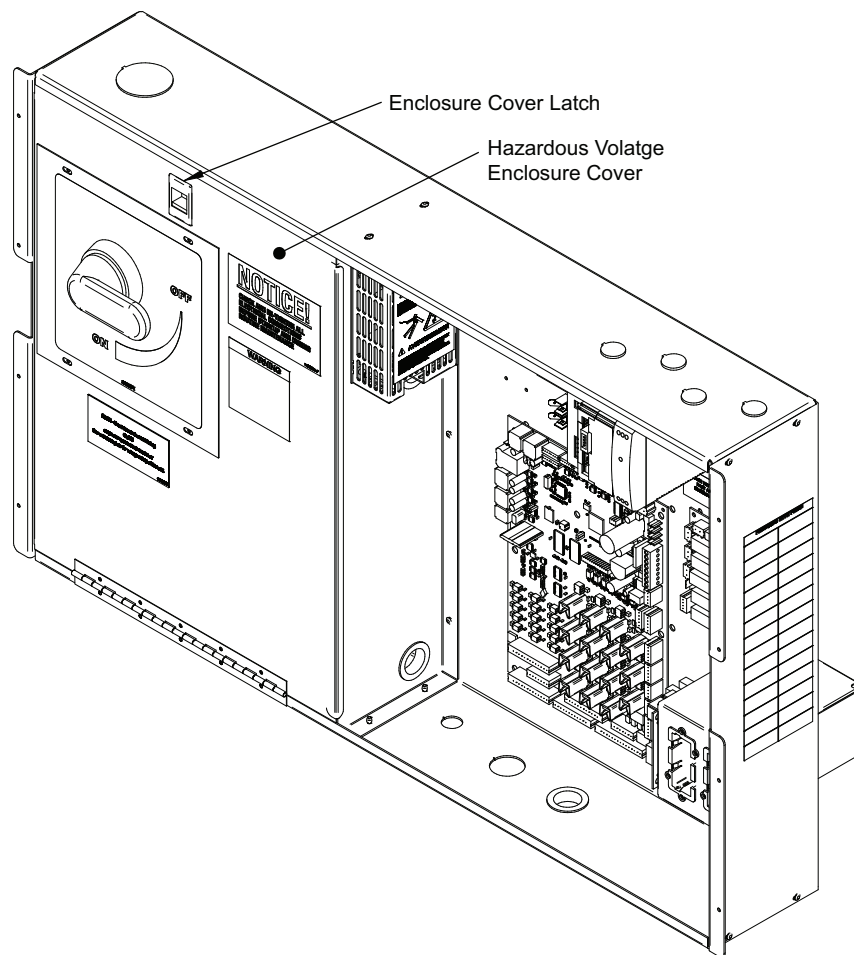
Use NEC Class 1 wiring for all hazardous voltage electrical power supplies.

Check and retighten **all** wiring connections before starting the unit.

2.2.1 Connecting High-Voltage Cables

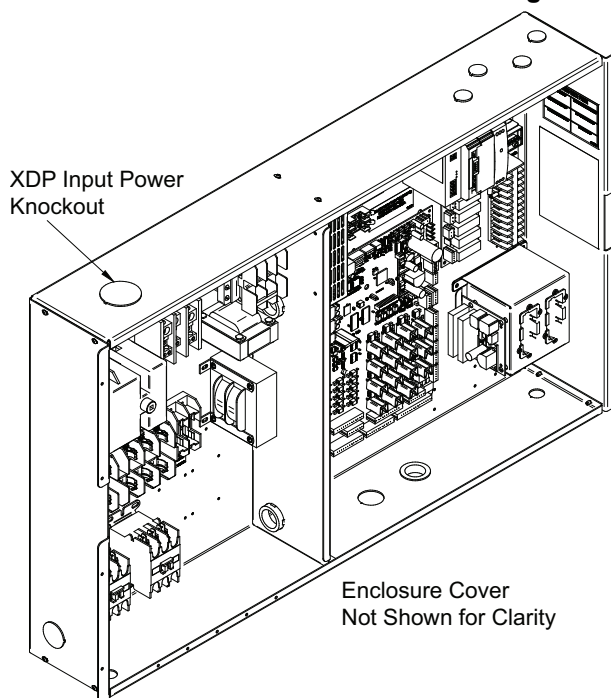
1. Turn the Liebert XDP's disconnect switch to the Off position (see **Figure 9**). Open the front doors and push down on the enclosure cover latch to open the hazardous voltage enclosure cover.

Figure 9 Front view of Liebert XDP and electrical enclosure



2. Determine which knockouts in the electrical enclosure will be used and remove them (see **Figure 10**).

Figure 10 Electrical enclosure knockout location for hazardous voltage wiring



3. Route the input hazardous voltage electrical power wiring through the top left knockout (see **Figure 10**) to the disconnect switch L1, L2 and L3 (see **Figures 11** and **12**). Observe proper phasing.
4. Connect the ground wire to the ground lug (see **Figures 11** and **12**), which is in the middle left of the enclosure.

Figure 11 High voltage connections—60Hz

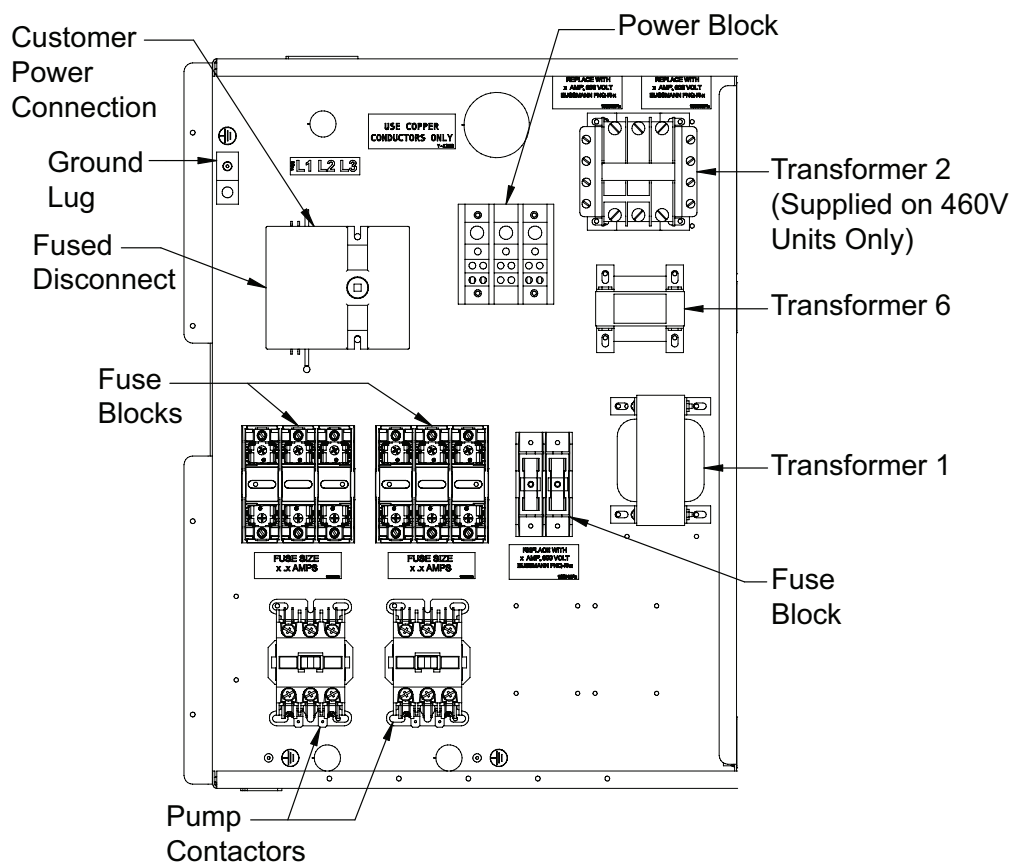
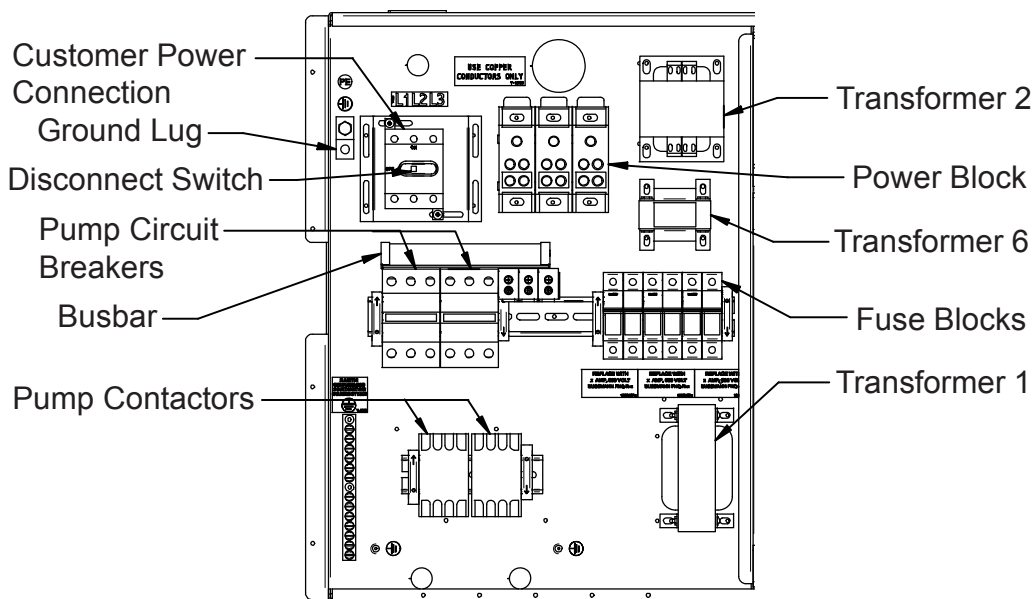


Figure 12 High voltage connections—50Hz



2.2.2 Extra Low Voltage (ELV) Connections

Extra Low Voltage power output is 30V and 100VA or less.

1. Turn off all unit power before connecting cables or wires. Failure to do so may damage this equipment (refer to **Figure 13**).
2. Route low voltage electrical connections through the appropriate knockouts as indicated below.

Figure 13 Electrical enclosure knockout locations for Extra Low Voltage

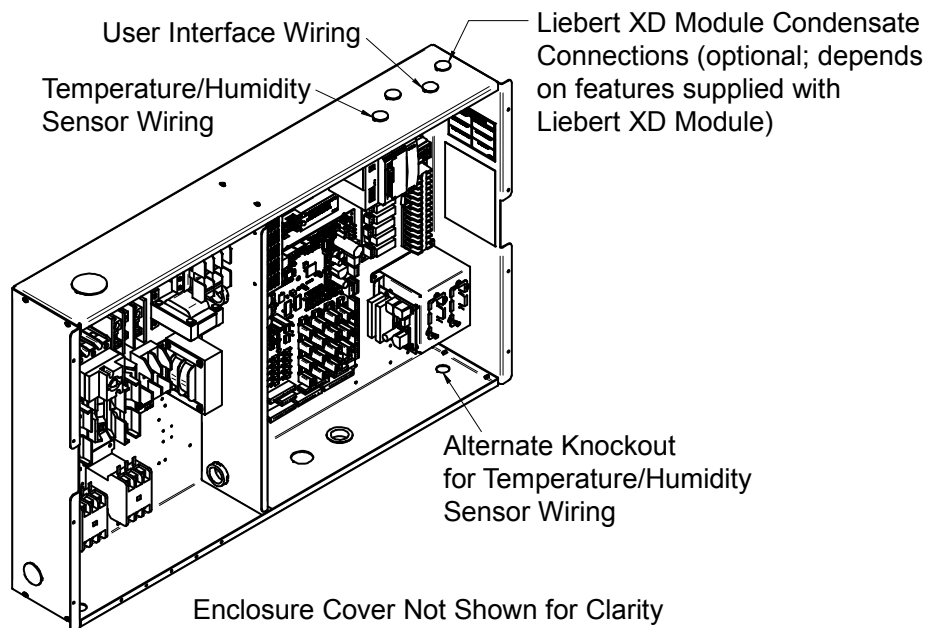
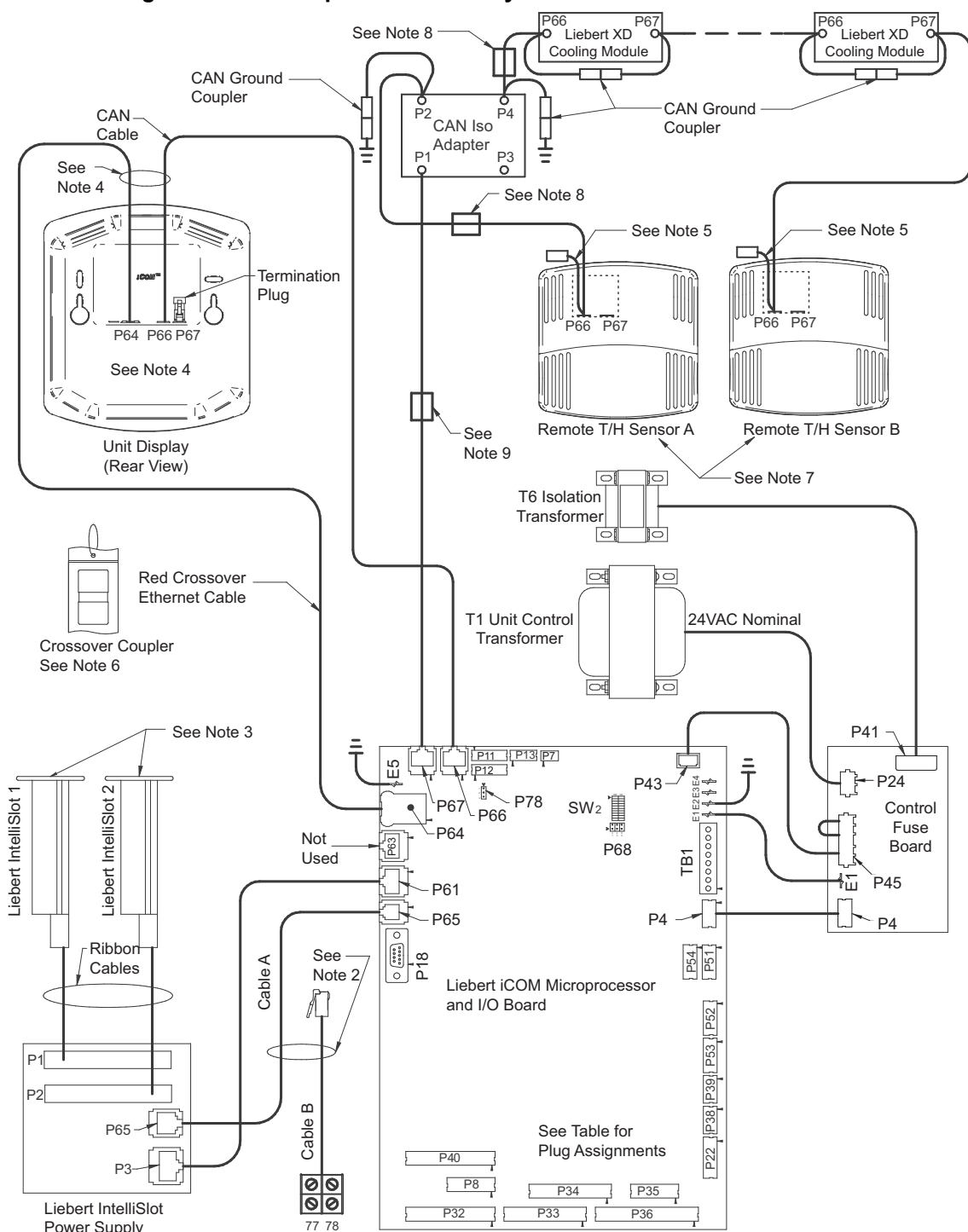


Figure 14 Connecting the remote temperature/humidity sensors



1. See unit electrical schematic, installation and user manuals.
2. Cables "A" and "B" provided with each unit. Only one is used as follows:
Liebert IntelliSlot-based communications - Cable "A" is preconnected to P65 on microprocessor and input/output board and P65 on Liebert IntelliSlot power supply
non-Liebert IntelliSlot-based communications - Cable "B" is pre-connected to Terminals 77 and 78 but must be exchanged with Cable "A" at P65 on the microprocessor and input/output board.
3. Install applicable Liebert IntelliSlot cards.
4. Both cables (P64 and P66) are required.
5. It is not necessary to connect ground coupling on end of cable connected to Sensor "A" or Sensor "B."
6. A crossover coupler is provided for unit-to-unit (U2U) networking. Unplug the red cable from P64 on the microprocessor and input/output board and connect to one side of the crossover coupler. The first customer connection point is to P64 on the microprocessor and input/output board. The second customer connection point is to the other side of the crossover coupler. This connects the microprocessor and input/output board and display to the private U2U network.
7. The remote sensors are interchangeable as to which connects to the Liebert XD cooling module and which connects to P2 on CAN Iso.
8. Field-install cables with factory-installed ferrite beads (when provided, typical two places). Each cable must make three passes through the ferrite bead. Locate the ferrite bead on top of the electric box. See instruction sheet provided with the cable assembly.
9. Factory-installed ferrite bead (when provided). Cable passes through ferrite bead three times

302211
Rev. 2

2.2.3 DIP Switch and Jumper Settings for Remote Sensors

The Liebert XDP is shipped with jumpers and DIP switch settings for normal operation. See Figure 15.

Figure 15 DIP switch and jumper settings

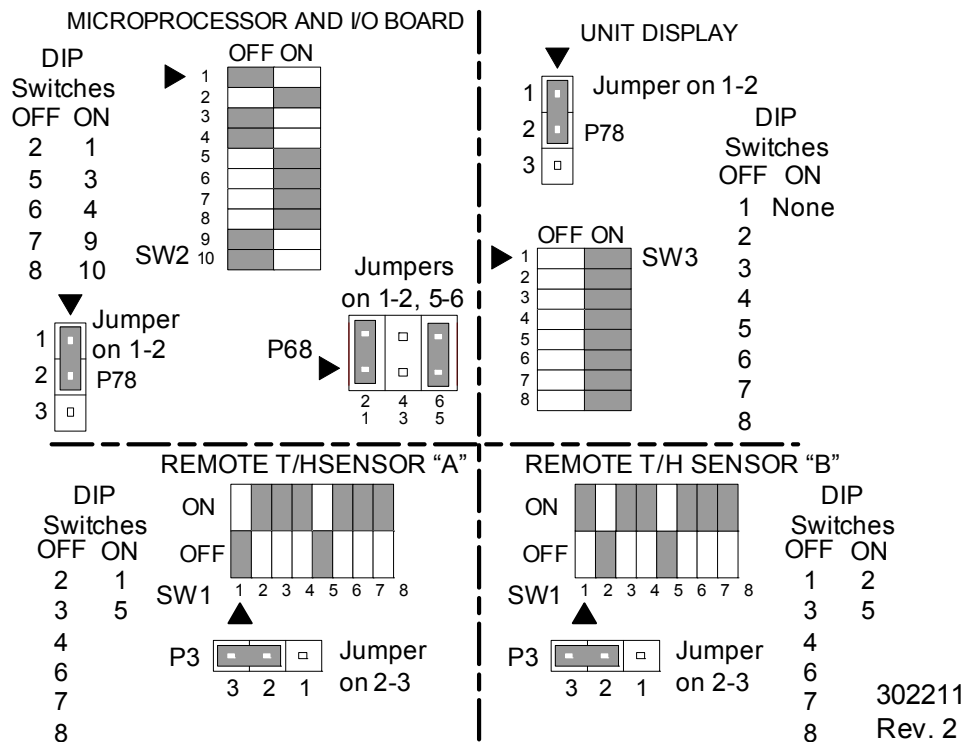
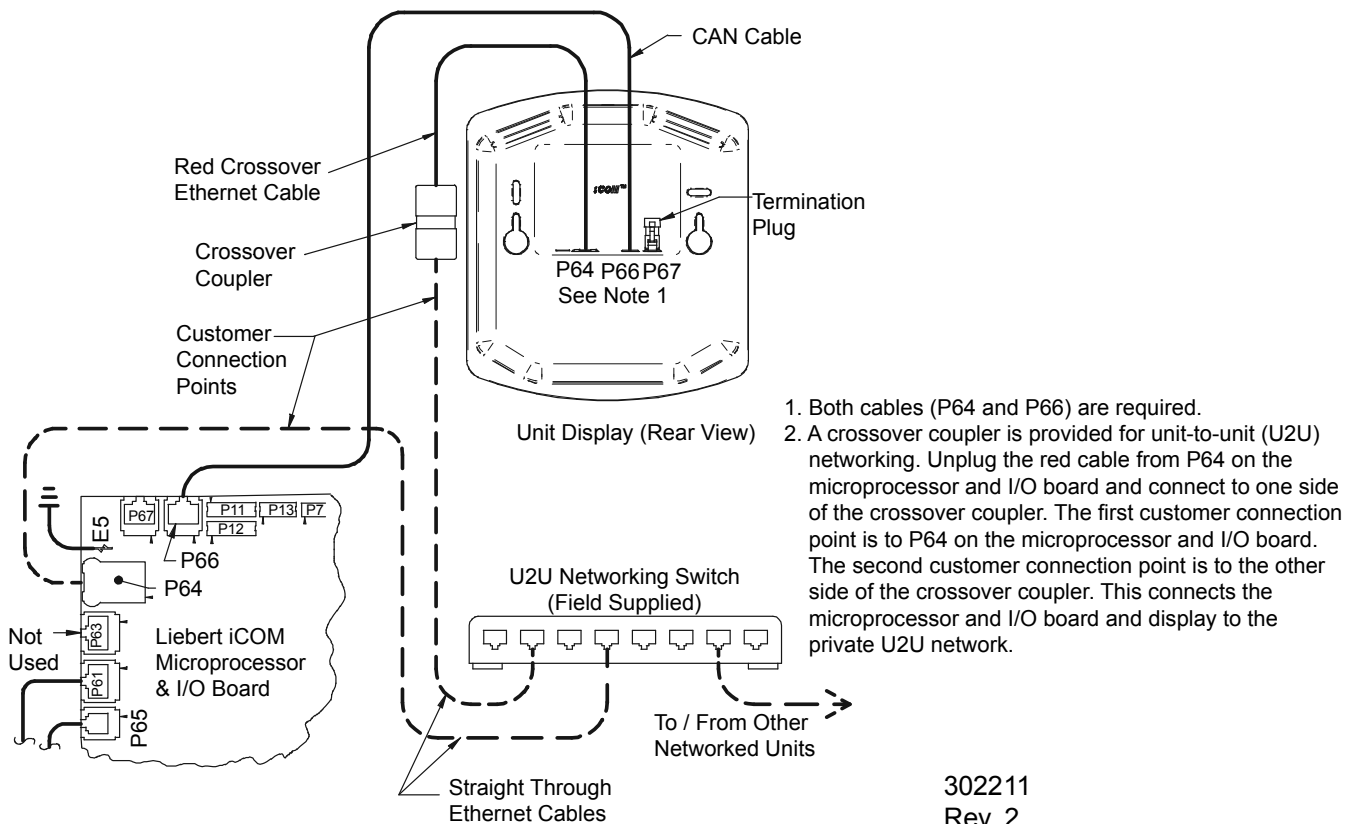


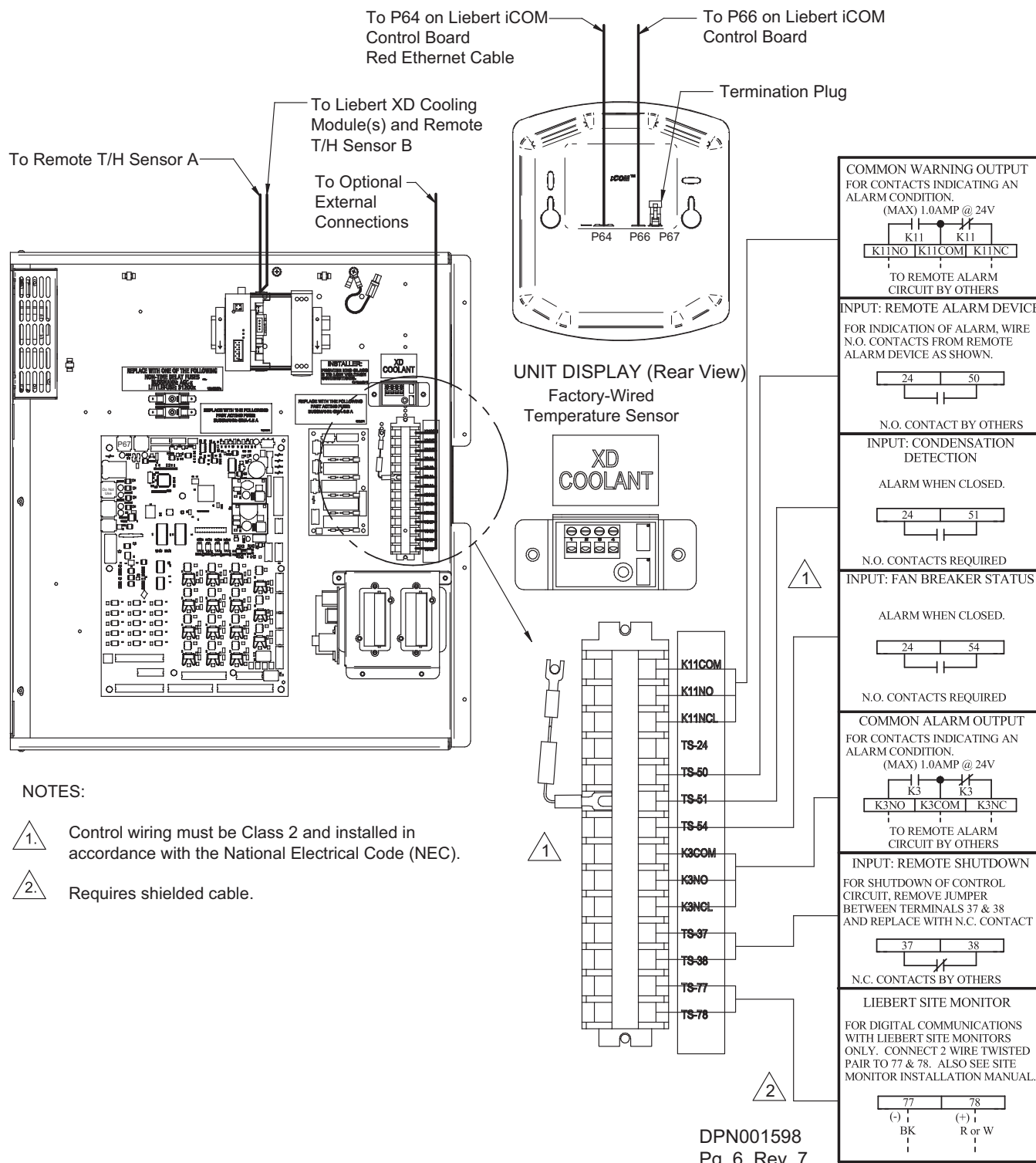
Figure 16 Unit-to-unit networking connections



2.3 Field Connections—Optional for All Units

- Connect field wiring from the optional Liebert XD cooling module condensation detection circuit to terminal strip locations COMM. (24) and H2O (51).
- Connect optional field wiring from remote devices to remote alarm device, common alarm outputs, site monitor and remote shutdown, if applicable. See terminal strip descriptions in **Figure 17**.

Figure 17 Liebert XDP extra low voltage field connections points



2.4 Remote Sensor Installation—Proper Placement

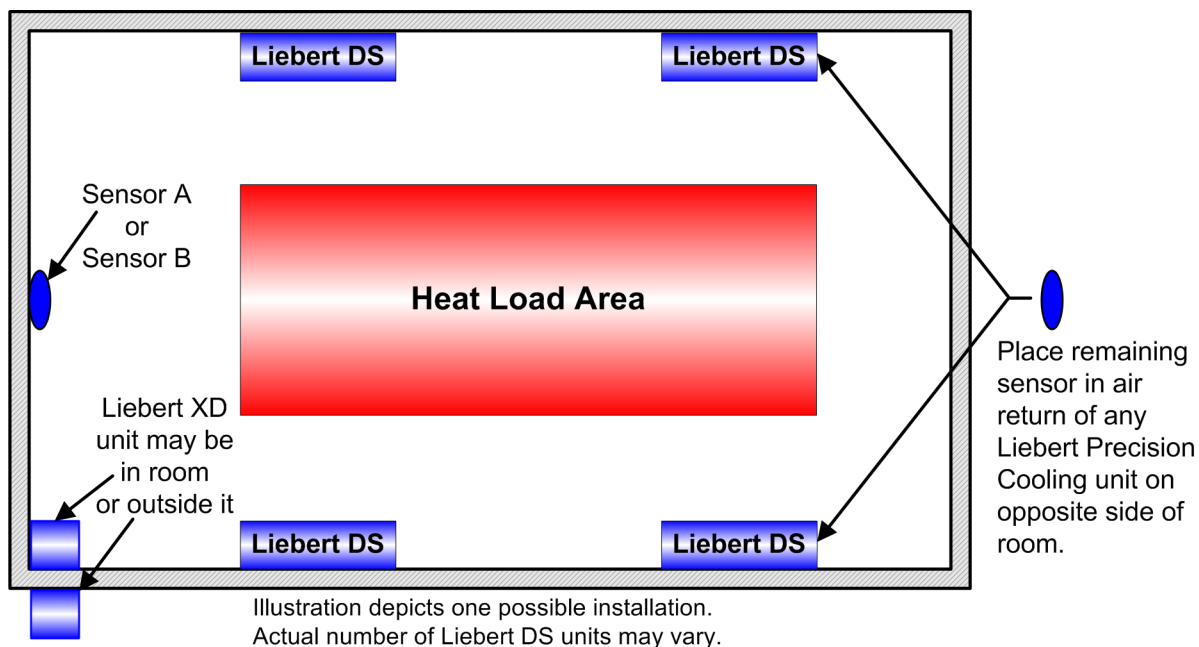
Placement of the two remote temperature/humidity sensors is critical to effective cooling of the conditioned space.

The remote sensors must be installed in areas where conditions are representative of the space conditioned by the Liebert XDP. Emerson recommends installing the sensors in different areas near the cooling modules served by the Liebert XDP. If the return air side of the primary air mover, such as a Liebert DS, represents the conditions where the Liebert XD cooling modules are located, one sensor could be placed there. Emerson suggests placing the other sensor on the wall opposite the heat load area (see **Figure 18** for guidance).

Do not install the sensors where ambient air might cause false readings, for example, near unsealed doors or windows, or areas with stagnant air.

1. Unpack the two remote temperature/humidity sensors and cables.
One sensor is labeled Sensor A and the other Sensor B. The sensor cables are interchangeable; each bears labels indicating Sensor End and Unit End.
2. Connect the Sensor End of one of the supplied sensor cables to P66 on Sensor A (see **Figure 14**).
3. Connect the Unit End of the sensor cable to P67 on the Liebert iCOM input/output board inside the Liebert XDP. Secure the ring terminal on the cable shield to the electric box adjacent to P67 (see **Figure 14**).
4. Connect the Sensor End of the second sensor cable to P66 on Sensor B (see **Figure 14**).
5. Connect the Unit End of the cable to P67 on the Liebert iCOM display (see **Figure 14**). Secure the ring terminal on the cable shield to the grounding screw adjacent to P67.

Figure 18 Suggested remote sensor placement



3.0 PIPING

3.1 European Union Fluorinated Greenhouse Gas Requirements

Stationary air conditioning, refrigeration, heat pump equipment and stationary fire protection systems in the European Community market and operating with fluorinated greenhouse gases (f-gas), such as R407C, R134a, R410A, must comply with the F-Gas Regulation: (EC) No. 842/2006 (F-gas). The regulation prohibits, among other actions, venting fluorinated greenhouse gases to the atmosphere.

The F-Gas Regulation requires operators to use all measures that are technically feasible and do not entail disproportionate cost to prevent leakage of these gases, to test for leakage regularly and to recover f-gas before disposing of equipment, as well as during service and maintenance.

Refer to the full regulation for additional details.

3.2 Connection Sizes

The copper pipe connections on the Liebert XDP are:

Building Chilled Water Supply	2-5/8" OD
Building Chilled Water Return	2-5/8" OD
Refrigerant Supply	1-1/8" OD
Refrigerant Return	2-1/8" OD

3.2.1 Recommended Pipe Size

Connect the main pipes between the Liebert XDP and the Liebert XD cooling modules according to site specific documentation and the configuration guide for the Liebert XD system.

Elbows and restrictions must be minimized to get good fluid flow.

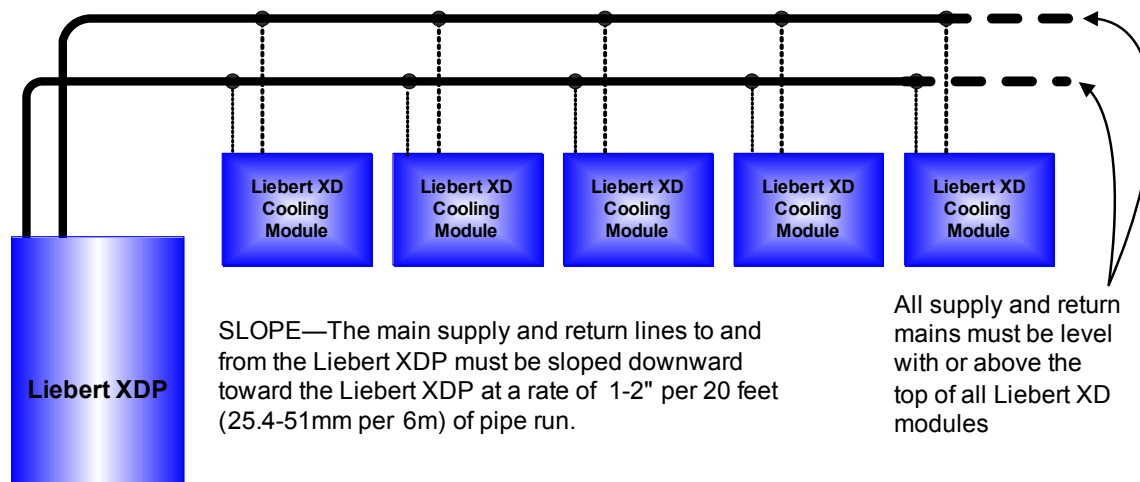
Table 4 Supply, return pipe sizes for refrigerant loop

Pipe Function	Size / Equivalent Pipe Length
Liebert XDP supply line, from Liebert XDP supply to farthest Liebert XD cooling module	1-1/8" OD for lengths up to 60 feet
	1-3/8" OD for lengths over 60 but less than 175 feet
Liebert XDP return line, from farthest Liebert XD cooling module to Liebert XDP return	2-1/8" OD for lengths up to 60 feet
	2-5/8" OD for lengths over 60 but less than 175 feet
From any model Liebert XDO/Liebert XDH supply to supply line of Liebert XDP	1/2" OD for lengths up to 10 feet
	7/8" OD for lengths over 10 but less than 25 feet
From any model Liebert XDO/Liebert XDH return to return line of Liebert XDP	7/8" OD for lengths up to 10 feet
	1-1/8" OD for lengths over 10 but less than 25 feet
From any model Liebert XDV/Liebert XDCF supply to supply line of Liebert XDP	1/2" OD for lengths up to 10 feet
	5/8" OD for lengths over 10 but less than 35 feet
From any model Liebert XDV/Liebert XDCF return to return line of Liebert XDP	5/8" OD for lengths up to 10 feet
	7/8" OD for lengths over 10 but less than 35 feet

3.3 Liebert XDP Interconnection with Liebert XD Cooling Modules

All piping must be ASTM (American Society for Testing and Materials) Type ACR copper pipe. The Liebert XDP may be connected to Liebert XD cooling modules with either Liebert's XD prefabricated piping assembly or with rigid, off-the-shelf piping. In either setup, piping for the Liebert XD system is arranged in a manner similar to piping for a chilled water system. Liebert XD cooling modules are connected in parallel between main return and supply pipes going to and from the Liebert XDP/Liebert XDC. **Figure 19** represents a typical configuration. For piping details, refer to Liebert's XD System Design Manual, SL-16655, available at Liebert's Web site: www.liebert.com. **The guidelines provided for pipe size must be strictly followed. Failure to size the main lines and connection lines adequately may result in reduced cooling capacity.** The critical aspects of pipe sizing are related to refrigerant volume and pressure drop. Each must be minimized.

Figure 19 Liebert XD system diagram



3.4 Piping Installation Methods

The assembly and connection means used for piping in the Liebert XD system are similar to those used for conventional refrigeration systems. All piping should be installed with high-temperature brazed joints. Soft soldering is not recommended.

During brazing, the lines must be filled with flowing dry nitrogen to prevent excessive oxidation and scale formation inside the piping. Prevailing good refrigeration practices must be employed for piping supports, leak testing, dehydration and charging. Failure to use good system practices may result in damage to the system. Refer to the ASHRAE refrigeration handbook for general good-practice refrigeration piping.

Insulate all piping lines to prevent condensation in applications where the dew point approaches the R-134a refrigerant temperature.

Emerson recommends venting the pressure relief valve for the R-134a outside the conditioned space where it is open to the atmosphere. The R-134a side relief valve is inside the Liebert XDP unit at the top of the receiver.

3.4.1 Piping Installation—R-134a Pumped Circuit

Emerson recommends venting the relief pressure valve of the Liebert XDP (located at the top of the receiver) outside of the conditioned space where it is open to the atmosphere.

3.4.2 Piping Mains

All refrigeration piping mains connected to the Liebert XD cooling module, both supply and return, should be installed with a downward pitch toward the Liebert XDP of 1-2" for every 20 feet (25.4-51mm per 6m) of pipe run.

Install a 20-40 mesh strainer on the chilled water supply to the Liebert XDP. The strainer is required to prevent particles in the chilled water from entering the Liebert XDP's heat exchanger. The maximum distance from the strainer to the Liebert XDP is 10 feet (3m).

NOTICE

Risk of particles in chilled water. Can cause equipment damage and reduced cooling.

Failure to install a strainer in the supply line to the Liebert XDP can result in damage to the unit's heat exchanger.

3.4.3 Bypass Flow Controller

Three bypass flow controllers are required to ensure that the Liebert XDP pumps operate within the optimum range. These devices are added to the field piping and simulate the flow of additional cooling modules.

Each bypass flow controller must be installed with one shutoff valve to allow the controller to be disabled when cooling modules are added to a Liebert XD system.

Bypass flow controllers should be connected between the main supply and the main return lines of the field piping. The connection points to the main supply and return lines should be in a convenient and accessible location between the Liebert XDP/Liebert XDC and the first Liebert XD module in the circuit. See **Figures 20** and **21** for piping details of the bypass flow controller.

Refer to **Table 5** to determine the number of bypass flow controllers that must be open to provide proper refrigerant flow based on the total nominal cooling capacity of the cooling modules in each Liebert XD system.

Table 5 Bypass flow controllers for a Liebert XDP-based system

System Load kW Cumulative Module Model Size	Required Number of Open Bypass Flow Controllers
	Liebert XDP
48 to 63	3
64 to 95	2
96 to 127	1
128 to 160	0

Figure 20 Bypass flow controller details, dimensions

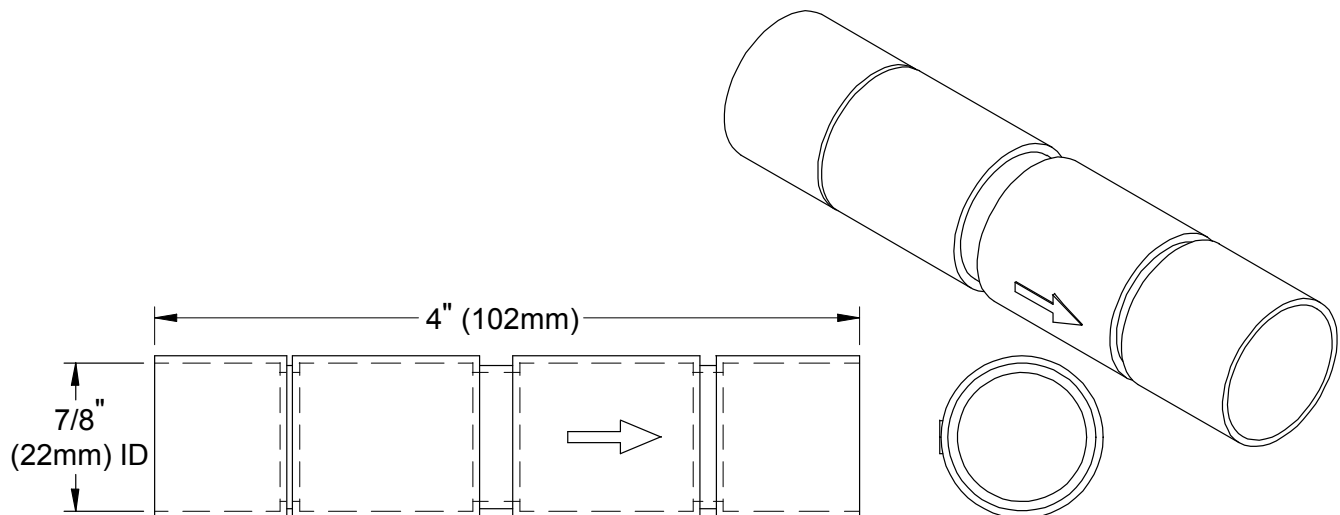


Figure 21 Bypass flow controller arrangement

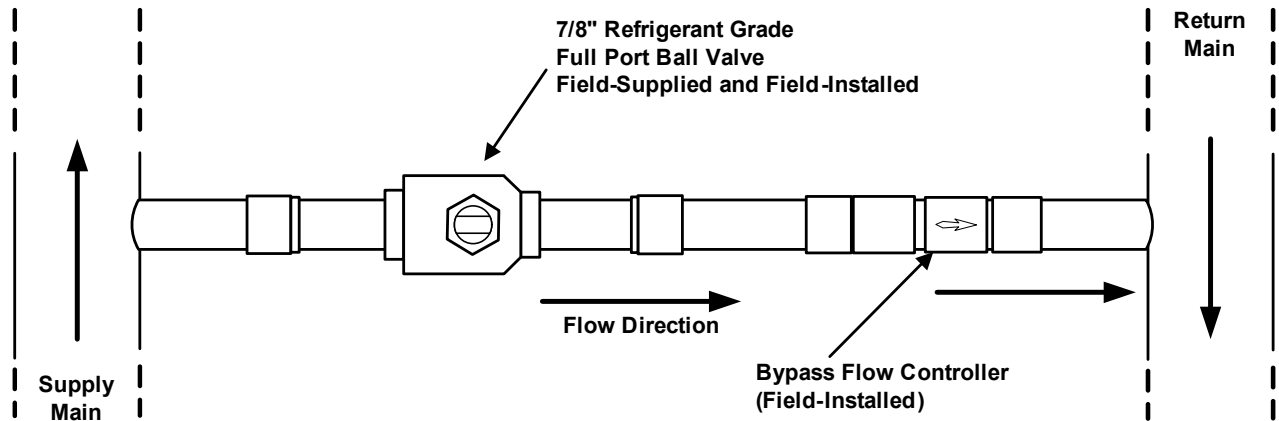
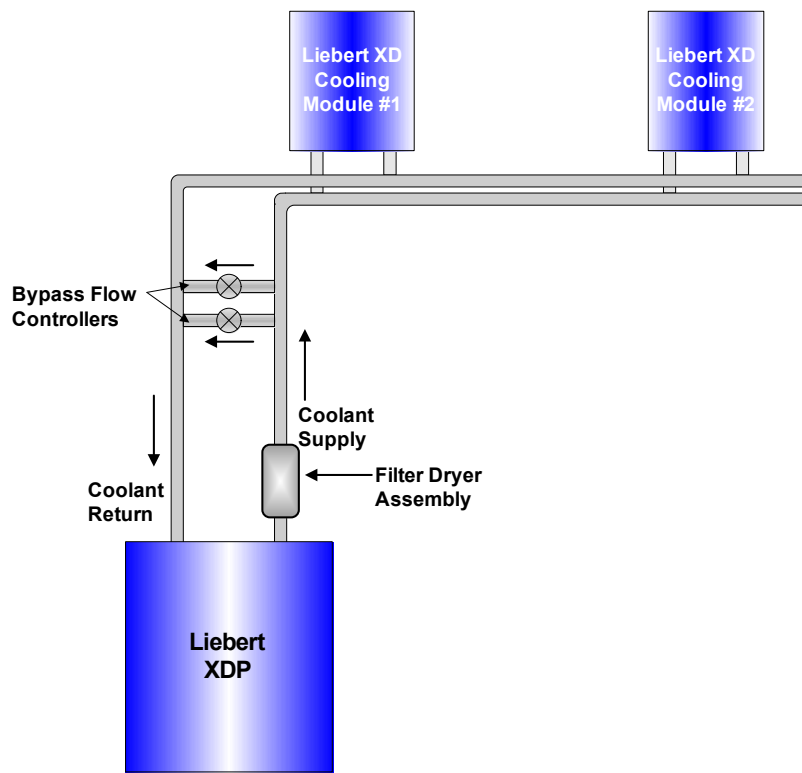


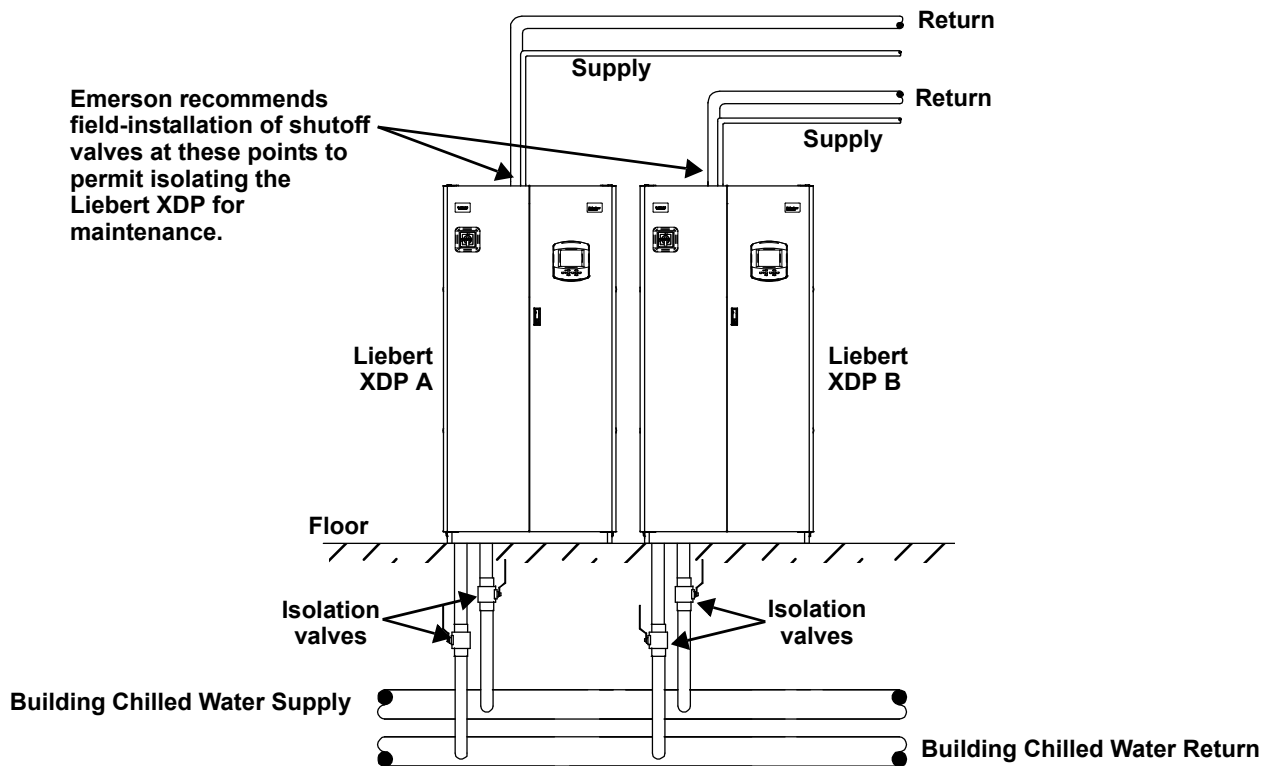
Figure 22 Bypass flow controller piping



3.5 Piping Details—Shutoff/Isolation Valves

Isolation valves must be installed on the Liebert XDP's refrigerant circuit to permit maintenance on the unit (see **Figure 23**).

Figure 23 General piping details



3.5.1 Evacuation and Leak Check—R-134a Pumped Circuit

1. Open all service valves, including those outside the Liebert XDP.
2. Attach a jumper hose from one of the Schrader valve fittings on a pump outlet before the check valve to a Schrader valve fittings after the check valve.
3. Place 150psig (1034kPa; 10.34 bars) of dry nitrogen with a tracer of R-134a in the system.

NOTICE

Risk of overpressurization. Can cause equipment damage.

Do not exceed 150 psig (1034 kPa; 10.34 bars) in the R-134a circuit.

4. Check the system for leaks with a suitable leak finder on the pumps' suction lines.
5. After completion of the leak testing, release the test pressure (per local code) and connect to vacuum pump(s) at the Schrader valves.
6. After pulling a deep vacuum for four hours, check the vacuum level and, if it has not changed, break the vacuum with dry nitrogen.
7. Pull a second vacuum to 250 microns or less. Recheck the vacuum level after 2 hours.

3.5.2 Insulation



NOTE

Do not insulate piping before checking it for leaks. Insulating pipes before checking them for leaks would prevent easy detection of leaks.

Insulate all piping between the Liebert XDP and its connected cooling modules to prevent condensation where the piping passes through non-conditioned areas.

3.6 Filling the Pumped Circuit—R-134a

Using a refrigerant pump or cylinder heater pads will speed the charging process.

1. Connect a charging manifold to the service port of the receiver outlet valve or to the suction and discharge side of the pump.
2. Purge the hoses.
3. Calculate the amount of R-134a refrigerant needed to charge the system, using the values in **Tables 6, 7, 8 and 9**; for assistance, refer to **3.6.1 - Calculating Refrigerant Charge—Example**. The section includes a worksheet to calculate system refrigerant charge requirements.
4. Weigh in the calculated charge.
5. After adding the calculated charge, allow the system to sit 15 to 30 minutes to reach equilibrium. Observe the refrigerant level through the sight glasses of the receiver. The level should be above the second sight glass at a minimum when the Liebert XDP is off.
6. If the refrigerant level is improper, the charge must be adjusted.
If the level is too high or too low, recalculate the required charge and reduce or increase the amount as needed to reach the proper level.



NOTE

All lengths in **Tables 6, 7 and 8** are actual pipe lengths, not equivalent pipe lengths.



NOTE

System refrigerant volume calculations derived from **Tables 6, 7, 8 and 9** are based on a fully loaded system. Additional charge may be required for lightly loaded systems.

Table 6 System R-134a charge for a Liebert XDP with any model Liebert XDH/Liebert XDO/Liebert XDV/Liebert XDCF/Liebert XDR

Refrigerant Charge, lb. (kg)	Per Liebert XD Unit (Excludes Connector Lines to and from Liebert XD Cooling Module)
1.41 lb. (0.64kg)	Liebert XDCF
5.32 lb. (2.41kg)	Liebert XDH
3.55 lb. (1.61kg)	Liebert XDO
157 lb. (71.2kg)	Liebert XDP
4 lb. (1.8kg)	Liebert XDR
2.32 lb. (1.05kg)	Liebert XDV

Table 7 System refrigerant charge for the supply and return mains

Refrigerant Charge, lb/foot (kg/m)	Supply/Return Main Length and Diameter
0.45 (0.67)	Main supply actual length per 1-1/8" OD copper tubing
0.68 (1.01)	Main supply actual length per 1-3/8" OD copper tubing
0.28 (0.42)	Main return actual length per 2-1/8" OD copper tubing
0.43 (0.64)	Main return actual length per 2-5/8" OD copper tubing

Before beginning, verify that the system is not equipped with pre-charged Liebert XD Flex Pipe.

Table 8 R-134a refrigerant charge for hard-piped connector lines to and from any model Liebert XDH/Liebert XDO/Liebert XDV/Liebert XDCF/Liebert XDR

Refrigerant Charge, lb/foot (kg/m)	Hard-Piped Connector Length and Diameter
0.08 (0.12)	1/2" OD Liebert XDO/Liebert XDH/Liebert XDV/Liebert XDCF/Liebert XDR supply connector actual length
0.13 (0.19)	5/8" OD copper tubing Liebert XDV/Liebert XDCF supply connector actual length
0.26 (0.39)	7/8" OD Liebert XDO/Liebert XDH/Liebert XDR supply connector actual length
0.02 (0.03)	5/8" OD copper tubing Liebert XDV/Liebert XDCF return connector actual length
0.04 (0.06)	7/8" OD copper tubing Liebert XDV/Liebert XDCF return connector actual length
0.04 (0.06)	7/8" OD copper tubing Liebert XDH/Liebert XDO/Liebert XDR return connector actual length
0.07 (0.1)	1-1/8" OD copper tubing Liebert XDH/Liebert XDO/Liebert XDR return connector actual length

Table 9 R-134a refrigerant charge for Flex Pipe connector lines to and from any model Liebert XDO/Liebert XDH/Liebert XDV/Liebert XDCF/Liebert XDR

Refrigerant Charge lb. (kg)	Metal Flex Pipe Connector Length
Supply Line Diameter 1/2"	
0.3 lb. (0.14)	4 ft. Flex Pipe Liebert XDH/Liebert XDO/Liebert XDV/Liebert XDCF/Liebert XDR supply
0.5 lb. (0.23)	6 ft. Flex Pipe Liebert XDH/Liebert XDO/Liebert XDV/Liebert XDCF/Liebert XDR supply
0.7 lb. (0.32)	8 ft. Flex Pipe Liebert XDH/Liebert XDO/Liebert XDV/Liebert XDCF/Liebert XDR supply
0.8 lb. (0.36)	10 ft. Flex Pipe Liebert XDH/Liebert XDO/Liebert XDV/Liebert XDCF supply/Liebert XDR
Return Line Diameter 5/8"	
0.01 lb. (0.01)	4 ft. Flex Pipe existing Liebert XDV systems
0.02 lb. (0.01)	6 ft. Flex Pipe existing Liebert XDV systems
0.03 lb. (0.01)	8 ft. Flex Pipe existing Liebert XDV systems
0.03 lb. (0.01)	10 ft. Flex Pipe existing Liebert XDV systems
Return Line Diameter 1"	
0.13 lb. (0.06)	4 ft. Flex Pipe Liebert XDH/Liebert XDO/Liebert XDV/Liebert XDCF/Liebert XDR supply
0.2 lb. (0.09)	6 ft. Flex Pipe Liebert XDH/Liebert XDO/Liebert XDV/Liebert XDCF/Liebert XDR supply
0.27 lb. (0.12)	8 ft. Flex Pipe Liebert XDH/Liebert XDO/Liebert XDV/Liebert XDCF/Liebert XDR supply
0.33 lb. (0.15)	10 ft. Flex Pipe Liebert XDH/Liebert XDO/Liebert XDV/Liebert XDCF/Liebert XDR supply

3.6.1 Calculating Refrigerant Charge—Example

Using **Tables 6, 7, 8 and 9**, calculate the refrigerant charge of the individual sections of your Liebert XD system. Add the calculated charge amounts to determine the amount of R-134a refrigerant required for one system combining a Liebert XDP with Liebert XD cooling modules (Liebert XDCF, Liebert XDH, Liebert XDO and Liebert XDV). The example below combines one Liebert XDP with 20 Liebert XDV8 cooling modules.

Table 10 Calculating refrigerant charge—example

Components	Number of Units or Piping Length, feet	Pounds Per Component	Total, lb.
Liebert XDP	1	157	157
Liebert XDV8 Cooling Modules	20	2.32	46.4
Supply Main, 1-1/8"	100	0.45	45
Return Main, 2-1/8"	100	0.28	28
Liebert XDV 1/2" supply Liebert XD Flex Pipes	20	0.8	16
Liebert XDV 5/8" return Liebert XD Flex Pipes	20	0.03	0.6
Total			293

Table 11 Worksheet to calculate refrigerant charge

Components	Number of Units or Piping Length	Pounds Per Component	Total
Total			

3.7 Checklist for Proper Installation

- 1. Unpack and check received material.
- 2. Position the Liebert XDP and secure it to the floor.
- 3. Wire high voltage connections.
- 4. Wire low voltage connections.
- 5. Connect the building chilled water piping to the Liebert XDP.⁴⁴ Connect the Liebert XD cooling module piping to the Liebert XDP with slope.
- 6. Check the system for leaks.
- 7. Hold a vacuum on the system.
- 8. Charge the system with refrigerant.
- 9. Make sure that all piping has proper insulation.

4.0 LIEBERT ICOM CONTROL—FIRMWARE VERSION XP1.00.010.STD

4.1 Liebert iCOM Components and Functions

The Liebert iCOM controller layout is shown in **Figure 24**; the keyboard functions are defined in **Table 12**.

Figure 24 Liebert iCOM display components

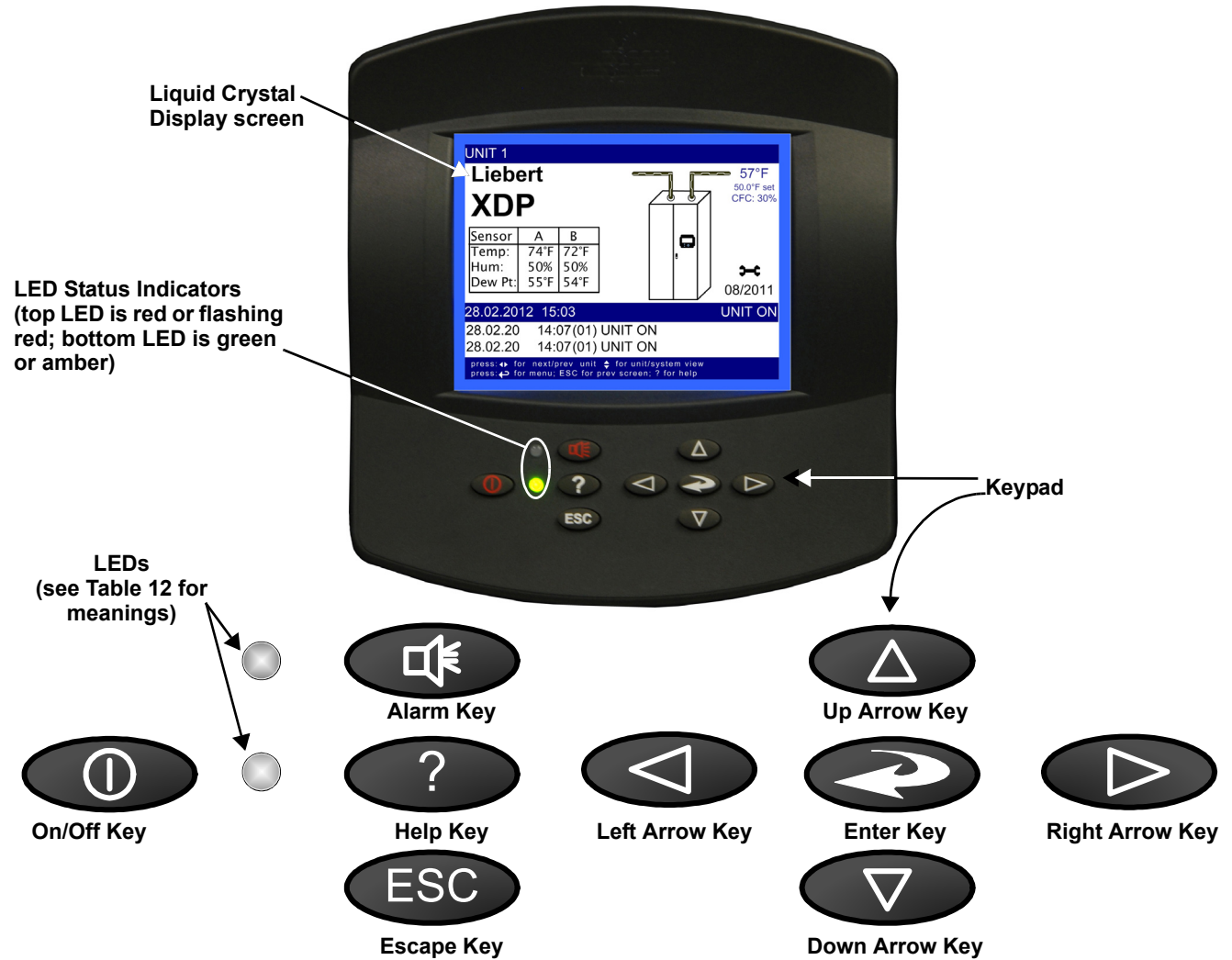







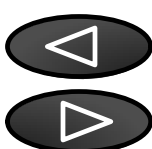
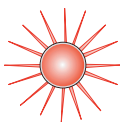





Table 12 Keyboard icons and functions

Icon	Key Name	Function
	On/Off Key	Controls the operational state of the cooling unit.
	Alarm Key	Silences an alarm.
	Help Key	Accesses integrated Help menus.
	ESCApe Key	Returns to the previous display view.
	Enter Key	Confirms all selections and selects icons or text.
	Increase Key (Up Arrow)	Moves upward in a menu or increases the value of a selected parameter.
	Decrease Key (Down Arrow)	Moves downward in a menu or reduces the value of a selected parameter.
	Left and Right Arrow Keys	Navigates through text and sections of the display.
	Upper LED	Blinking Red—Active, unacknowledged alarm exists
		Solid Red—Active, acknowledged alarm exists
	Lower LED	Amber—Power is available to the unit; unit is NOT operating
		Green—Unit is operating with no alarms

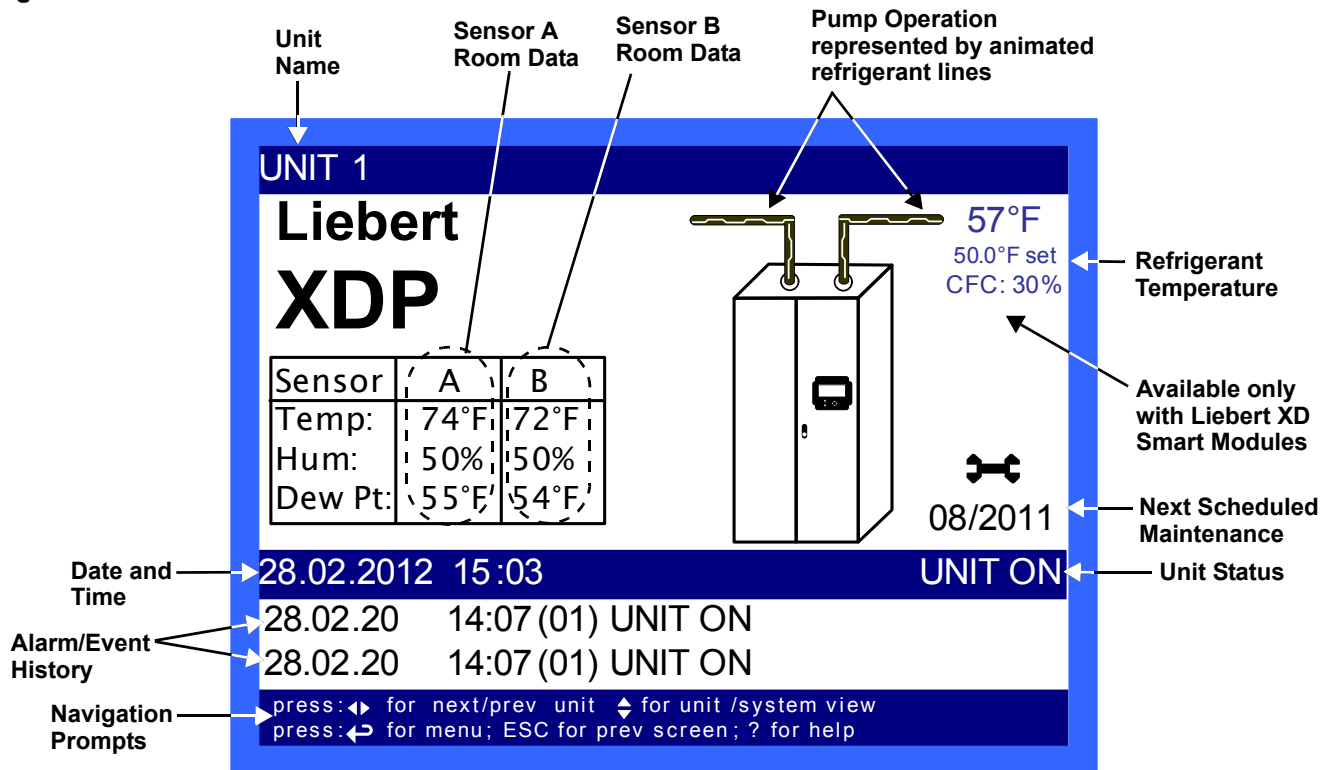
4.2 Display Lamp Indicators

- The Green lamp will be On only when the Liebert XDP is On and running with no alarms.
- The Red lamp will be On if the unit is On and running with an active alarm, or if the unit is shut down because of an alarm.
- The Red lamp will flash while an alarm is being annunciated. The Red lamp will stop flashing and the beeper in the display will stop beeping when the ALARM SILENCE / ? key is pressed.
- The Amber lamp will be On if the Liebert XDP has been shut down at the I/O switch or if the unit has been shut down by an alarm condition.

4.3 Navigating Through the Liebert iCOM Display

Liebert iCOM displays icons and text for monitoring and controlling your Liebert cooling unit. The Liebert iCOM's home screen is shown in **Figure 25**.

Figure 25 Liebert iCOM default home screen



4.3.1 Accessing Menus and Settings

Viewing Data

No password is required to view data or settings.

To view data:

1. From the home screen, press the **Enter** key to view the User Menu (see **Figure 29**).
2. Press **Enter** again to highlight the first icon.
3. Use the keyboard's arrow keys to move to the icon for the data you wish to view.
4. Once that icon is highlighted, press **Enter** again to open that menu.
 - If a password is required, see **4.3.3 - Entering the Password**.
 - If a menu has more than one screen, the Liebert iCOM display will have text at the top similar to this: (*page 1 of 2*).
5. Press **Enter** to select the first line of data.
6. Use the **Up** and **Down** arrow keys to scroll to the desired data point.
7. Press **ESC** to move back to higher level menus.

4.3.2 Cooling Module Overview

The Liebert iCOM will display an overview of all connected cooling modules. It does not display a system view, which would include units other than the cooling modules.



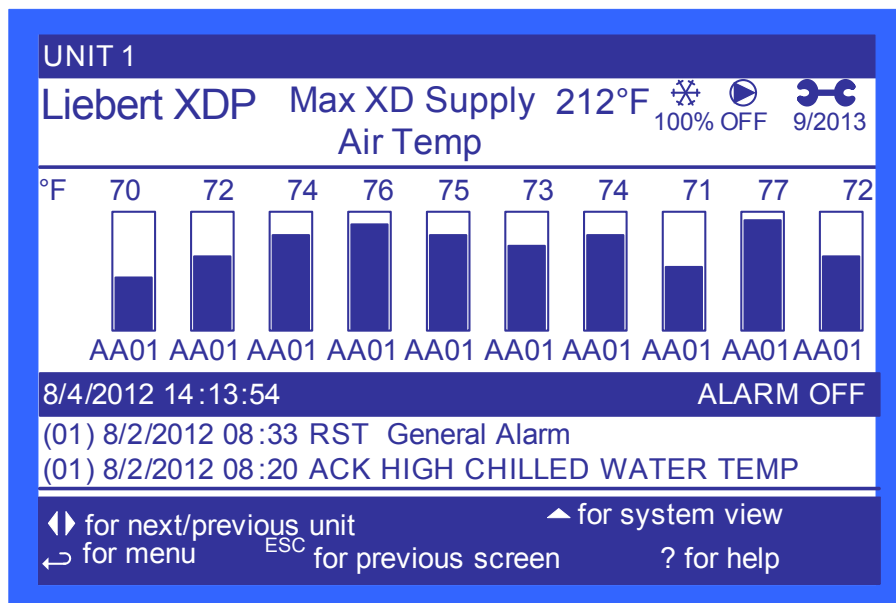
NOTE

The Liebert iCOM control screens display a setting to select a system view, but the Liebert XDP does not support a system view.

To display an overview of all connected cooling modules:

1. At the default home screen on the Liebert iCOM, press the down arrow. This will display the first 10 modules' outlet temperature and capacity levels. Press ESC to return to the unit view.

Figure 26 Cooling module overview, first 10 modules



2. Press the down arrow button again to display the next 10 modules' outlet temperature and capacity levels.
3. Press ESC to return to the default home screen.

4.3.3 Entering the Password

Most settings in the Liebert iCOM are protected by a factory-set password, 1490. To enter the password:

1. From the home screen, press the **Enter** key to view the User Menu (see **Figure 29**).
2. Press **Enter** again to highlight the first icon.
3. Use the keyboard's arrow keys to move to the icon for the data you wish to change.
4. Once that icon is highlighted, press **Enter** again to open that menu.
5. Press **Enter** to highlight the Password line.
6. With the Password line highlighted, press **Enter** to highlight the first digit in the password.
7. Enter the password, 1490.

Use the **Up** and **Down** arrow keys to select a numeral for the first digit of the password.

Move to the next digit of the password with the **Right** arrow key.

Select the numerals for all four digits with the same process.

8. After all four digits of the password have been entered, press the **Enter** key.



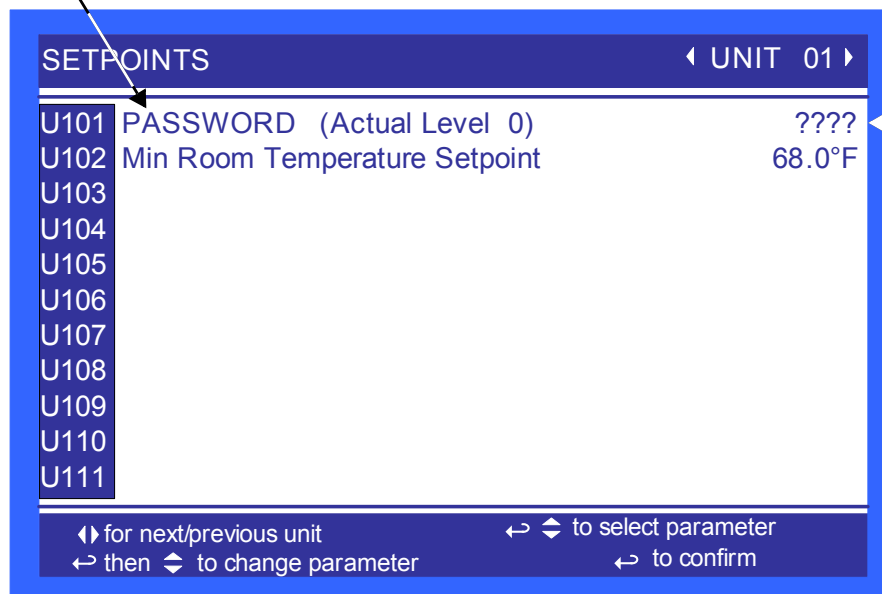
NOTE

Do not press the ESC key or the Liebert iCOM will move to the previous screen and the password must be re-entered before changes may be made.

Figure 27 Entering the password

Password command line—highlight by pressing **Enter**

After highlighting the Password command line, press **Enter** again to highlight the first digit. Use the **Up** and **Down** arrow keys to change the first digit. Move to the next digit in the Password with the right arrow.



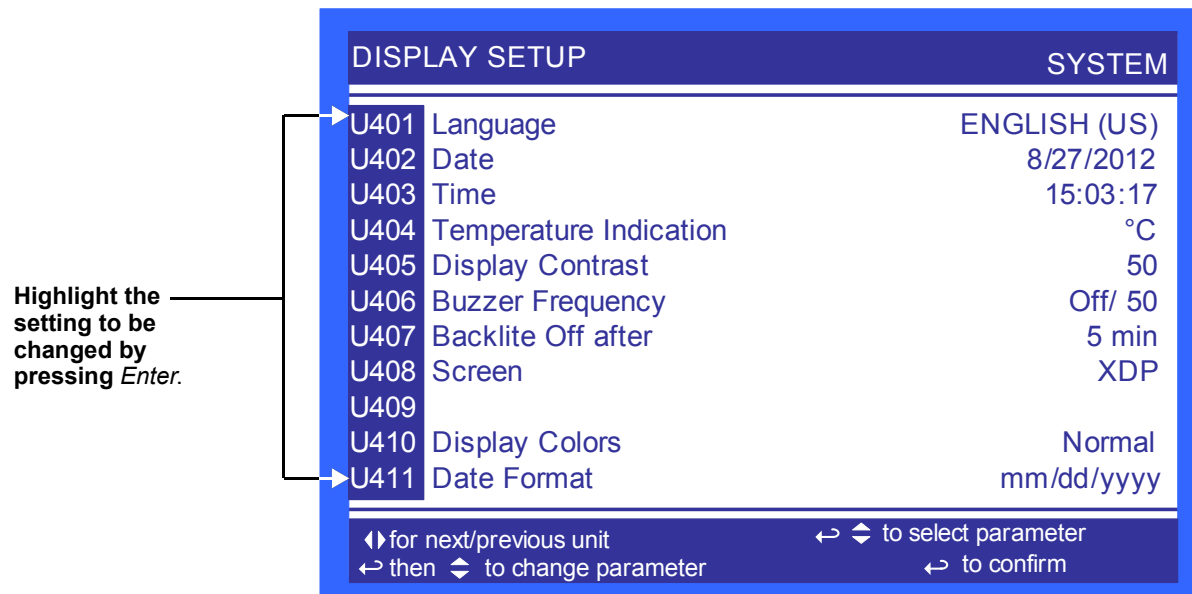
4.4 Changing Liebert iCOM's Display Settings

No password is required to change the way Liebert iCOM displays data. The Display Setup controls how the unit shows data, such as temperature, date and time.

To change the display settings:

1. From the home screen, press the **Enter** key to view the User Menu (see **Figure 29**).
2. Press **Enter** again to highlight the first icon.
3. Use the keyboard's arrow keys to move to the Display Setup icon.
4. Once that icon is highlighted, press **Enter** again to open that menu.
5. Press the **Enter** key to select the first setting.
Either change that setting or navigate to another setting with the **Up** and **Down** arrow keys.
6. Once the desired setting is highlighted, press the **Enter** key to access that parameter's display setting options.
7. Use the **Up** and **Down** arrow keys to make changes.
8. Press the **Enter** key to accept the changes.
9. Press the **ESC** key twice to return to Liebert iCOM's user menu.

Figure 28 Display setup screen



4.5 Changing Operational Settings

Changes to the Liebert XDP's operation settings in the **Set Alarms** and **Setpoints** menus require a password.

1. From the home screen, press the **Enter** key to view the User Menu (see **Figure 29**).
2. Press **Enter** again to highlight the first icon.
3. Use the keyboard's arrow keys to move to the icon for the data you wish to change.
4. Once that icon is highlighted, press **Enter** again to open that menu.
If a password is required, see **4.3.3 - Entering the Password**.
5. After entering the password, use the **Up** and **Down** arrow keys to scroll to and highlight the operational setting to be changed.
6. Press **Enter** to highlight the values for that setting.
7. Use the **Up** and **Down** arrow keys to change the value.
8. Press **Enter** to accept the change. (The value will no longer be highlighted.)
9. Press **ESC** to deselect the operational setting. (The setting will no longer be highlighted.)
10. Press **ESC** again to move to previous screens.

4.6 Graphical Data Record

The Graphical Data Record charts the average temperature from Sensors A and B and the supply refrigerant temperature.

The temperature scales can be changed to expand or compress the data.

The time scale also can be altered to any of several selectable values.



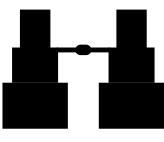
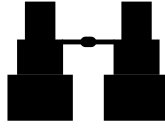

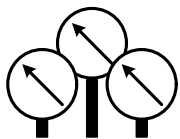





NOTE

Changing the time scale eliminates all previous graphical data and the unit will begin recording new data.

4.7 Liebert iCOM User Menu Icons and Legend

Figure 29 Liebert iCOM User Menu icons

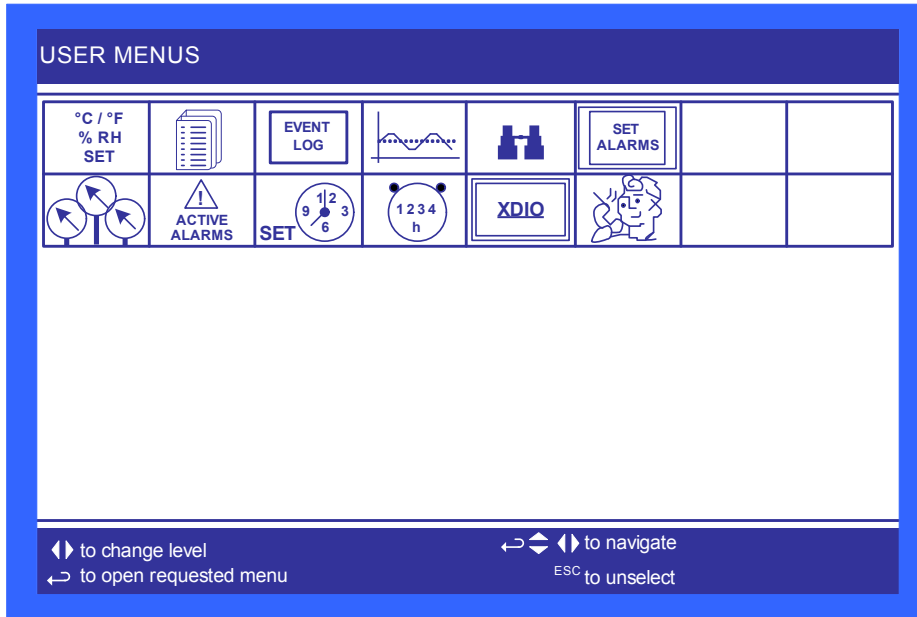
<p>°C / °F % RH SET</p> <p>Setpoints View and change operational setpoints</p>	 <p>Spare Parts List Contains spare parts available on site</p>	<p>EVENT LOG</p> <p>Event Log Lists last 400 events and alarms View Only</p>	 <p>Graphic Data Record Displays average temperature from Sensors A and B, the average dew point from Sensors A and B, the supply refrigerant temperature and the supply refrigerant control point graphs; Data is View Only; Display scale is adjustable</p>	 <p>View Network Shows status of all connected units; View Only</p>	<p>SET ALARMS</p> <p>Set Alarms Allows user to change settings for alarms</p>
 <p>Sensor Data Shows readings of sensors; View Only</p>	 <p>ACTIVE ALARMS</p> <p>Active Alarms Lists all current alarms; View Only</p>	 <p>Display Setup Change settings for display: language and time</p>	 <p>Total Run Hours Records the run time of all components and allows setting of limits on run time; View Only</p>	 <p>Smart Modules Displays readings for the individual smart modules; View Only</p>	 <p>Service Contacts Contains key contact information for service</p>



NOTE

Menu shows icons only; text is explanatory and does not appear on the Liebert iCOM display.

Figure 30 Liebert XDP User Menu screen

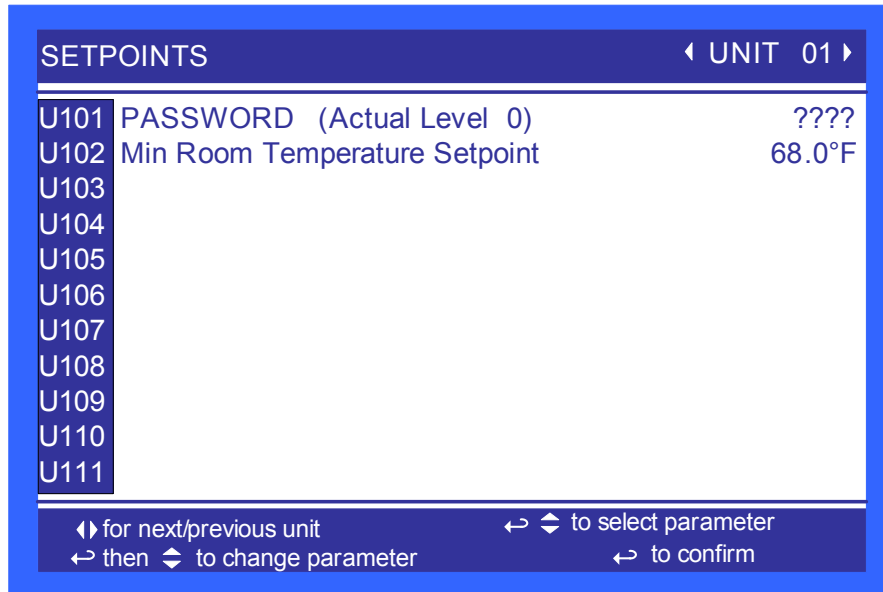


4.8 Liebert iCOM User Menu Screens

User menus report general cooling unit operations and status. User menu screens employ a coding that begins with “U” and is followed by parameters and information, such as settings. Gaining access to some User menu screens requires entering a password; the User Menu password is **1490**.

Check www.liebert.com for the latest Liebert iCOM user manual updates, SL-18835.

Figure 31 Setpoints screen



Min Room Temperature Setpoint—Sets the minimum room temperature the unit will attempt to maintain. If the temperature falls below this point, the unit will raise the refrigerant temperature to reduce the amount of cooling.

The setting is intended to keep the room temperature above the setpoint. Without a proper setpoint, the Liebert XDP can lower the room temperature too much, depending on the room dew point and load. This setpoint will reduce the cooling to keep the room temperature above this desired temperature.



NOTE

This is not a true room temperature setpoint. The Liebert XDP has no heaters; it will try to cool as much as possible. If the Liebert XDP is able to cool the room to this setpoint, it will reduce its cooling action to try to keep the room temperature at or above this setpoint.

The default setting is 60°F (15.6°C). The range is 50-80°F (10-27°C).

For optimal cooling performance, the minimum temperature setpoint should be 1-2° below the expected temperature at the remote sensors, which may affect placement of the remote sensors. If the minimum temperature setpoint is set above the typical remote temperature sensor reading, it will reduce the Liebert XD cooling output and, in extreme cases, cause erratic Liebert XD performance.

Spare Parts

Spare Parts—The spare parts lists contains a detailed description and part number that can be used to order parts for the unit. These part numbers are specific to each model and option installed on the unit.

Event Log

Event Log—The event log displays all events and actions that have been generated by the unit. When multiple units are networked you will see the event log of the whole system. Each event shows the unit that generated the alarm, time and date stamp, a description and the event type.

Figure 32 Set Alarms screen

SET ALARMS (page 1 of 1)		◀ UNIT 01 ▶
U201	PASSWORD (Actual Level 0)	????
U202	High Room Air Temperature	80.0°F
U203	Low Room Air Temperature	55.0°F
U204	High Room Dewpoint	65.0°F
U205	High Refrigerant Temperature	80.0°F
U206		
U207	High Chilled Water Temperature	60.0°F
U208		
U209		
U210		
U211		

◀▶ for next/previous unit ↵ ⇅ to select parameter
 ↵ then ⇅ to change parameter ↵ to confirm

High Room Air Temperature—Sets the threshold where a high room temperature alarm will occur, based on the actual reading from either remote Sensor A or B. The range for the high room air temperature alarm is 33.8-95°F (1-35°C); the default is 80.0°F (26.7°C).

Low Room Air Temperature—Sets the threshold where a low room temperature alarm will occur, based on the actual reading from either remote Sensor A or B. The range for the high room air temperature alarm is from 33.8 to 95°F (1 to 35°C); the default is 55.0°F (12.8°C).

High Room Dewpoint—Sets the threshold where a high room dew point alarm will occur, based on the calculated values from either remote Sensor A or remote Sensor B. The range for the high room dew point alarm is from 33.8 to 95°F (1 to 35°C); the default is 65°F (18.3°C).

High Refrigerant Temperature—Sets the threshold where a high refrigerant temperature alarm will occur based on the actual reading from the supply refrigerant sensor. The supply refrigerant temperature is from the Liebert XDP to the modules. The range for the high supply refrigerant temperature alarm is from 33.8 to 95°F (1 to 35°C); the default is 80°F (26.7°C).

High Chilled Water Temperature—Sets the threshold where a high chilled water temperature alarm will occur based on the actual reading from the supply chilled water sensor. The range for the high chilled water temperature is from 33.8 to 95°F (1 to 35°C); the default is 60°F (15.6°C).

Figure 33 Sensor Data screen, page 1 of 2

SENSOR DATA (page 1 of 2)		◀UNIT 01▶
U301	Sensor A Temperature	62.8°F
U302	Sensor A Humidity	42.20%
U303	Sensor A Dew Point	39.4°F
U304	Sensor B Temperature	71.2°F
U305	Sensor B Humidity	29.60%
U306	Sensor B Dew Point	37.8°F
U307	Supply Refrigerant Temperature	55.0°F
U308		
U309		
U310	Supply Chilled Water Temperature	55.0°F
U311		
U312		

This window is READ ONLY

Sensor A Temperature—Displays the temperature of the remote CAN Temp Humidity sensor designated as Sensor A.

Sensor A Humidity—Displays the humidity of the remote CAN Temp Humidity sensor designated as Sensor A.

Sensor A Dew Point—Displays the dew point of the remote CAN Temp Humidity sensor designated as Sensor A.

Sensor B Temperature—Displays the temperature of the remote CAN Temp Humidity sensor designated as Sensor B.

Sensor B Humidity—Displays the humidity of the remote CAN Temp Humidity sensor designated as Sensor B.

Sensor B Dew Point—Displays the dew point of the remote CAN Temp Humidity sensor designated as Sensor B.

Supply Refrigerant Temperature—Displays the actual supply refrigerant temperature from the Liebert XDP to the modules.

Supply Chilled Water Temperature—Displays the actual the Supply Chilled Water temperature to the Liebert XDP.

Figure 34 Sensor Data screen, page 2 of 2

SENSOR DATA (page 2 of 2)		◀UNIT 01▶	
U313	Daily High Temperature	07:49:57	72°F
U314	Daily Low Temperature	07:11:30	64°F
U315	Daily High Humidity	11:31:46	45%
U316	Daily Low Humidity	07:56:18	34%
U317	Daily High Dew Point	07:47:26	45°F
U318	Daily Low Dew Point	08:02:20	37°F
U319	Daily High Refrigerant Temp	13:01:25	69°F
U320	Daily Low Refrigerant Temp	13:01:11	69°F
U321	Daily High CW Temp	14:01:33	55°F
U322	Daily Low CW Temp	14:01:45	55°F
U323			
U324			

This window is READ ONLY

Daily High Temperature—Shows the highest temperature in a rolling 24 hour period for either remote Sensor A or remote Sensor B.

Daily Low Temperature—Shows the lowest temperature in a rolling 24 hour period for either remote Sensor A or remote Sensor B.

Daily High Humidity—Shows the highest humidity in a rolling 24 hour period for either remote Sensor A or remote Sensor B.

Daily Low Humidity—Shows the lowest humidity in a rolling 24 period for either remote Sensor A or remote Sensor B.

Daily High Dew Point—Shows the highest dew point in a rolling 24 hour period for either remote Sensor A or remote Sensor B.

Daily Low Dew Point—Shows the lowest dew point in a 24 hour period for either remote Sensor A or remote Sensor B.

Daily High Refrigerant Temperature—Shows the highest supply refrigerant temperature in a rolling 24 hour period from the Liebert XDP to the modules.

Daily Low Refrigerant Temperature—Shows the lowest supply refrigerant temperature in a rolling 24 hour period from the Liebert XDP to the modules.

Daily High Chilled Water Temperature—Shows the highest chilled water supply temperature being delivered to the Liebert XDP in a rolling 24 hour period.

Daily Low Chilled Water Temperature—Shows the lowest chilled water return temperature being delivered to the Liebert XDP in a rolling 24 hour period.

Figure 35 Display Setup screen

DISPLAY SETUP		SYSTEM
U401	Language	ENGLISH (US)
U402	Date	8/27/2012
U403	Time	15:03:17
U404	Temperature Indication	°F
U405	Display Contrast	30
U406	Buzzer Frequency	Off/ 50
U407	Backlite Off after	5 min
U408	Screen	Unit View
U409		
U410	Display Colors	Normal
U411	Date Format	mm/dd/yyyy

⏪ for next/previous unit ⏩ to select parameter
 ⏪ then ⏩ to change parameter ⏩ to confirm

Language—Sets the language on the display. Changing this setting changes all menu parameters to the selected language.

Date—Sets the internal date of the unit. If this unit is connected to other units with the unit-to-unit network connection, each unit will reflect the last date set.

Time—Sets the internal time of the unit. If this unit is connected to other units with the unit-to-unit network connection each unit will reflect the last time set.

Temperature Indication—Selects the actual and setpoint temperature scale. Selecting C will set the unit to display in Celsius and F will set the unit to display in Fahrenheit.

Display Contrast—Changes the contrast of the display to adjust for different viewing angles, low light and bright light conditions. As the display ages, the contrast may require adjustment for viewing.

Buzzer Frequency—Changes the audible noise frequency of the built-in buzzer. The buzzer will sound when its frequency is being adjusted, easing selection of a frequency easily detected when an alarm occurs.

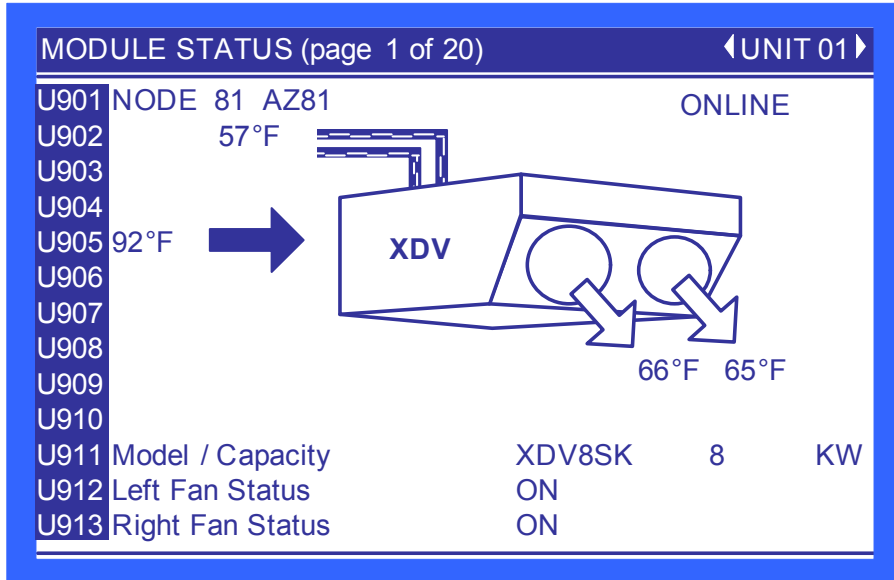
Backlite Off After—Controls how long the back-light remains active when the display is unused. When the buttons on the front display have not been pressed for the time selected in this parameter, the back-light will turn Off, extending the life of the display and saving energy.

Screen—Controls the screen layout. The Liebert XDP has one view, Unit View.

Display Colors—Selects the background color. Inverted sets the display to show white font with blue background and Normal sets a white background with blue font.

Date Format—Date format changes the month, day and year arrangement shown on the front display and on event time stamps.

Figure 36 Module Status screen, page 1 of 20

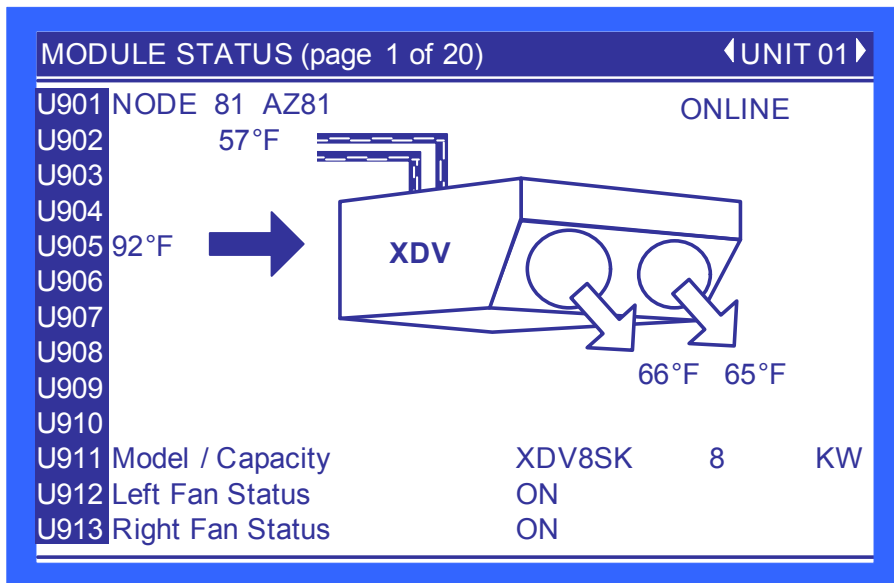


Module Node ID—The location within the CANbus. Each module’s ID is factory-set to 80 and is automatically changed during setup; requires no user action.

Module Labels—A four-character label consisting of two letters and two numerals. This is the standard nomenclature for Data Center Grid assignment of racks. Additionally, the module’s location can be denoted with 10 characters, either letters or non-alphanumeric characters from a built-in list. Either or both labels can be used and are entered using the Module Setup found in the Service menu (S910).

Module Status—Indicates whether the smart module is connected to the CANbus.

Figure 37 Liebert XDV Smart Module Status screen



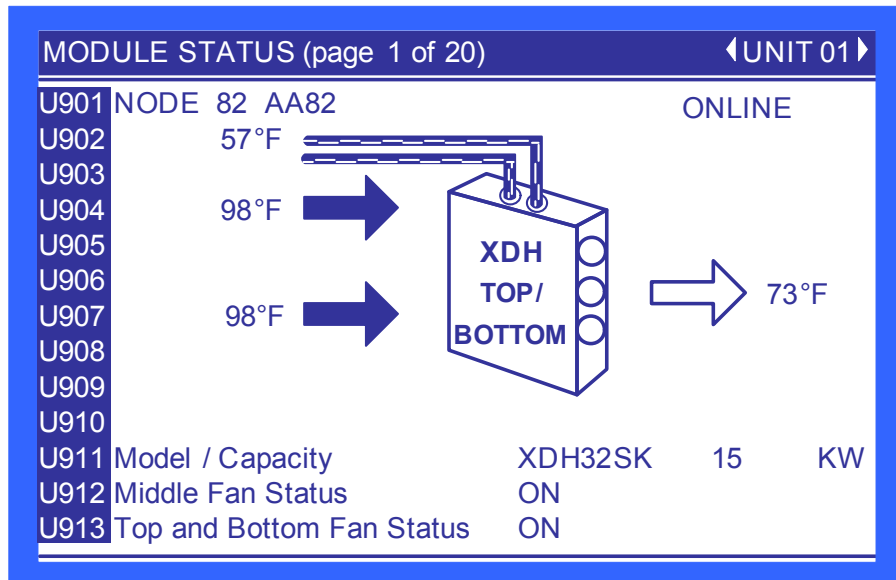
U905—Displays the temperature of the air entering the Liebert XDV.

U908—Displays the temperature of the air leaving the right and left fan of the Liebert XDV.

U911—Displays the module type and calculated local module capacity; possible module types are XDV8SK, XDV8SS, XDV8ST, XDV10SK, XDV10SS and XDV10ST.

U912—Displays the left fan status; possible values are ON and OFF.

U913—Displays the right fan status; possible values are ON, OFF and ON ECON. ON ECON indicates that only one fan is On.

Figure 38 Liebert XDH Smart Module Status screen—each bank shown separately

U904—Displays the temperature of the air entering the top of the bank of the Liebert XDH.

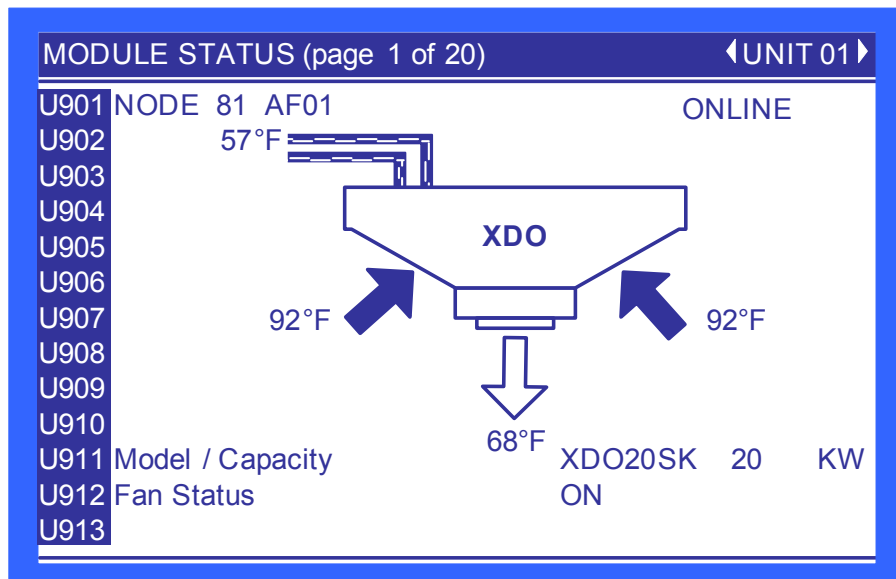
U905—Displays the temperature of the air leaving the Liebert XDH.

U907—Displays the temperature of the air entering the bottom of the bank of the Liebert XDH.

U911—Displays the module type and calculated local module capacity; possible module types are XDH20SK, XDH20SS, XDH32SK and XDH32SS.

U912—Displays the middle fan status; possible values are ON and OFF.

U913—Displays the top and bottom fans' status; possible values are ON, OFF and ON ECON. (ON ECON indicates that two fans have been turned On.)

Figure 39 Liebert XDO Smart Module Status screen

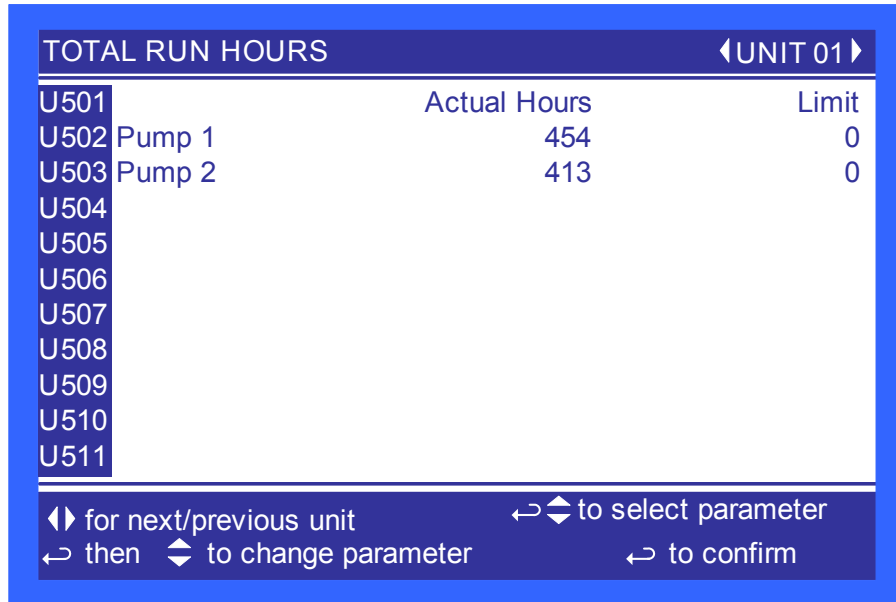
U907—Displays the temperature of the air entering from the right and left of the Liebert XDO.

U910—Displays the temperature of the air leaving the Liebert XDO.

U911—Displays the module type and calculated local module capacity; possible module types XDO16SK, XDO16SS and XDO20SS.

U912—Displays the fan status; possible values are ON and OFF.

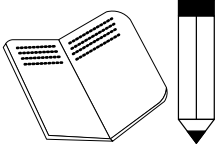
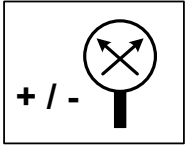

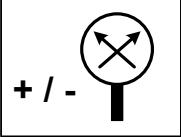

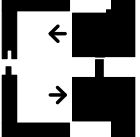

Figure 40 Total Run Hours screen



The parameter shows the actual hours Pump 1 and Pump 2 have operated and the maximum time Pump 1 can operate before the next maintenance.

4.9 Liebert iCOM Service Menu Icons and Legend

Figure 41 Liebert iCOM Service Menu icons

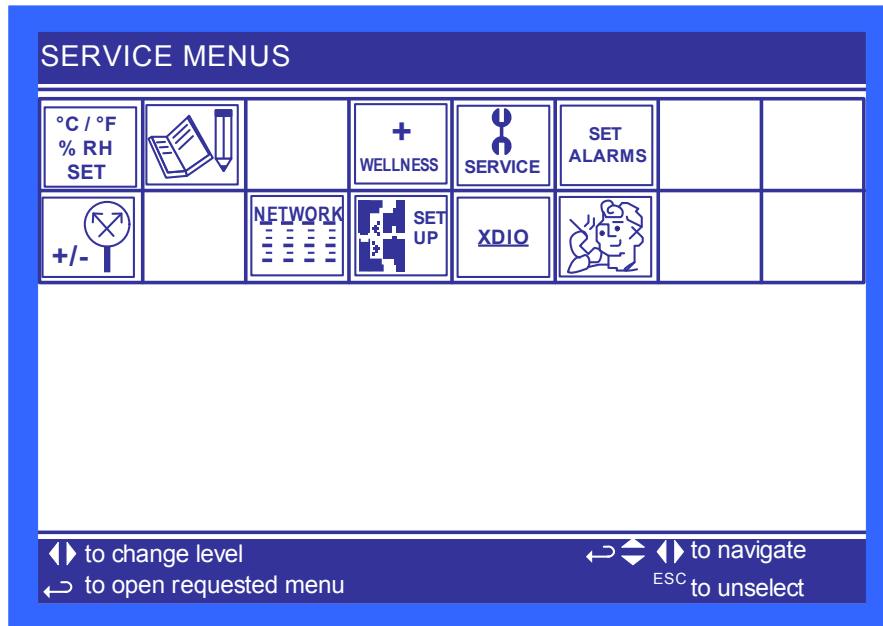
<p>°C / °F % RH SET</p> <p>Setpoints View and change operational setpoints</p>	 <p>Unit Diary Shows all program changes and maintenance performed,</p>		 <p>WELLNESS</p> <p>Maintenance/Wellness Settings Shows all maintenance records, calculates next maintenance date</p>	 <p>SERVICE</p> <p>Diagnostics/Service Mode Enter Diagnostics/Service Mode for troubleshooting and repair</p>	<p>SET ALARMS</p> <p>Set Alarms Change settings for alarms</p>
 <p>Sensor Calibration/Setup Setup and calibrate sensors for site</p>		<p>NETWORK</p>  <p>Network Setup or alter network setting.</p>	 <p>SET UP</p> <p>Options Setup Enter specific settings for various options</p>	<p>XDIO</p> <p>Smart Module Setup of alarms and events. Set temperature limits for supply and return sensors. Label smart modules, view firmware version</p>	 <p>Service Contacts Contains key contact information for service</p>



NOTE

Menu shows icons only; text is explanatory and does not appear on the Liebert iCOM display.

Figure 42 Liebert XDP Service Menu screen

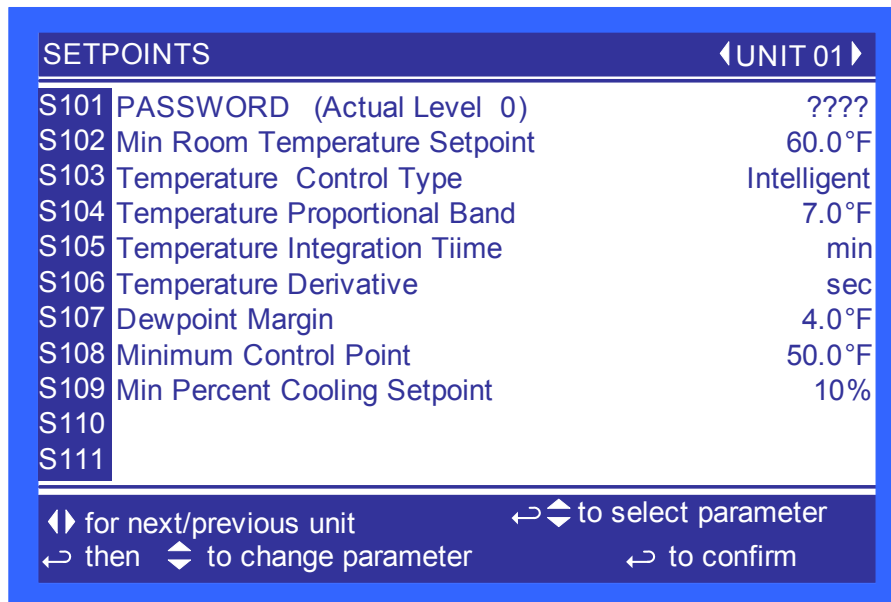


4.10 Liebert iCOM Service Menu Screens

Service menus allow customized settings for site operations. Service Menu screens employ a coding that begins with “S” and is followed by parameters and information, such as settings. Gaining access to most Service Menus requires entering a password; the Service Menu password is **5010**; see **4.3.3 - Entering the Password** for assistance.

The Liebert iCOM control firmware is being updated constantly. As a result, the Service Menu parameters in this manual may be slightly different from what is shown on a cooling unit’s display. Check www.liebert.com for the latest Liebert iCOM user manual updates.

Figure 43 Setpoints screen



Min Room Temperature Setpoint—Sets the minimum room temperature the unit will attempt to maintain. If the temperature falls below this point, unit will raise the refrigerant temperature to reduce the amount of cooling. Adjustable from 50 to 80°F (10.0 to 26.7°C), the factory default setting is 60°F (15.6°C).



NOTE

This is not a true room temperature setpoint. The Liebert XDP has no heaters; it will try to cool as much as possible. If the Liebert XDP is able to cool the room to this setpoint, it will reduce its cooling action to try to keep the room temperature at or above this setpoint.

Temperature Control Type—Selects the type of control the system will use to activate cooling. The Liebert iCOM control has three temperature control types: Proportional, PI and Intelligent. The factory default is Intelligent.

Proportional—If Proportional Control is selected, the percent cooling requirement is determined by the difference between the air temperature sensor reading and the temperature setpoint. As the air temperature rises above the temperature setpoint, the percent cooling required increases proportionally (from 0 to 100%) over half the programmable temperature proportional band. The percent heating requirement (0 to 100%) is determined the same way when the air temperature falls below the setpoint.

PI—If PI Control is selected, the percent cooling requirement is calculated by adding together two individual terms, proportional and integral. The proportional term is calculated in a manner similar to the previously described Proportional control. The integral term (sometimes called reset action) is calculated by measuring how much and for how long the air temperature has been above or below the setpoint. If the actual air temperature is above the setpoint, the percent requirement is slowly but continuously increased until the total is sufficient to bring the return room air back to the setpoint.

Intelligent—If Intelligent Control is selected, the air temperature is controlled at or near the setpoint. The percent temperature adjustment required is calculated based on logic that is programmed into the control. These rules simulate the actions that would be taken by a human operator manually controlling the system.

Temperature Proportional Band—Adjusts the activation points of compressors or rate of change based on the actual sensor values deviation from setpoint. The smaller this number the faster the compressors and valve(s) will increase capacity. Too small of a number may cause the unit to short cycle the compressors or excessively reposition the valve. This parameter is adjustable from 1.8 to 54.0°F (1.0 to 30.0°C). The factory default setting is 7.0°F (3.9°C).

Temperature Integration Time—Temperature integration takes into consideration the amount of time the actual temperature has deviated from the setpoint. The larger this deviation is the longer the unit will wait before corrective action is taken to achieve the setpoint. This parameter is adjustable from 0 to 15 minutes. The factory default is 0.

Temperature Derivative Time—Monitors the rate of change and will reduce or increase the amount of corrective action based on the actual temperature increasing or decreasing toward the temperature setpoint. This parameter is adjustable from 0-900 seconds. The factory default is 0.

Dewpoint Margin—Selects the difference between the room dew point and the refrigerant temperature control point. This parameter is adjustable from 4.0 to 10.0°F (2.2 to 6.0°C). The factory default setting is 4.0°F (2.2°C).

Minimum Control Point—Sets the minimum supply refrigerant temperature the Liebert XDP will maintain. This parameter is adjustable from 40 to 80°F (4.4 to 27.0°C). The factory default is 55°F (12.8°C).

Min Percent Cooling Setpoint—Selects the lowest percent call for cooling during normal operations. Whenever the unit is not in startup mode or OFF, the percent call for cooling cannot go below this value. The parameter is adjustable from 5 to 30%. The factory default is 15%.

Figure 44 Maintenance—Basic Settings screen, page 1 of 7

Basic Settings (page 1 of 7)		SYSTEM
S001	PASSWORD (Actual Level 0)	???
S002	Maintenance Frequency Per Year	1
S003	Max Bonus	0
S004	Max Penalty	0
S005	Last Maintenance	08/25/2011
S006	Service Engineer	NOBODY
S007	Confirm PM	No
S008	Calculated Next Maintenance	08/2014
S009		
S010		
S011		

⏪ for next/previous unit ⏩ to select parameter
 ⏪ then ⏩ to change parameter ⏩ to confirm

Maintenance Frequency Per Year—Sets the number of expected maintenance visits in a one year time span.

Max Bonus—Increases the time until the next required maintenance. Service personnel should assign a bonus when a service visit finds all components working optimally.

Max Penalty—Decreases the time until the next maintenance cycle. Service personnel should assign a penalty when a service visit finds excessive wear on components.

Last Maintenance—Date set during the service call. It also indicates to other service personnel the date of the last visit.

Service Engineer—Provides a label for the service representative to list either the company name or representative's name.

Confirm PM—Confirms that the service representative has completed the preventive maintenance and resets the next maintenance date.

Calculated Next Maintenance—Provides a date to for the next expected maintenance based on the last preventive maintenance performed (Confirm PM), component starts, run hours and the penalty or bonus set in the Liebert iCOM control.

Figure 45 Maintenance—Pump 1 Settings screen, page 2 of 7

Pump 1 Settings (page 2 of 7)		◀UNIT 1▶
S012	PASSWORD (Actual Level 0)	????
S013	Number of Starts	31
S014	Run Hours	453hrs
S015	Average Run Time	876min
S016	Starts per Day Best	1
S017	Starts per Day Worst	24
S018	Number of Alarms	1
S019	Actual Bonus	0
S020		
S021		
S022		

◀▶ for next/previous unit ↵◀▶ to select parameter
 ↵ then ▶ to change parameter ↵ to confirm

Number of Starts—Shows the number of starts for the unit's Pump 1.

Run Hours—Shows the number of run hours for the unit's Pump 1.

Average Run Time—Shows the average run time of the unit's Pump 1.

Starts per Day Best—Displays the lowest number of starts in a rolling 24 hour period for Pump 1.

Starts per Day Worst—Displays the highest number of starts in a rolling 24 hour period for Pump 1.

Number of Alarms—Displays the number of alarms that have occurred with the unit's Pump 1.

Actual Bonus—Displays the actual calculation of wellness for the unit's Pump 1. The unit will always take the value from the worst component for the next maintenance indication.

Figure 46 Maintenance—Pump 2 Settings screen, page 3 of 7

Pump 2 Settings (page 3 of 7)		◀UNIT 1▶
S023	PASSWORD (Actual Level 0)	????
S024	Number of Starts	2
S025	Run Hours	0hrs
S026	Average Run Time	0min
S027	Starts per Day Best	1
S028	Starts per Day Worst	24
S029	Number of Alarms	1
S030	Actual Bonus	0
S031		
S032		
S033		

◀▶ for next/previous unit	↔ to select parameter
↔ then ▶ to change parameter	↔ to confirm

Number of Starts—Shows the number of starts for the unit’s Pump 2.

Run Hours—Shows the number of run hours for the unit’s Pump 2.

Average Run Time—Shows the average run time of the unit’s Pump 2.

Starts per Day Best—Displays the lowest number of starts in a rolling 24 hour period for Pump 2.

Starts per Day Worst—Displays the highest number of starts in a rolling 24 hour period for Pump 2.

Number of Alarms—Displays the number of alarms that have occurred with the unit’s Pump 2

Actual Bonus—Displays the actual calculation of wellness for the unit’s Pump 2. The unit will always take the value from the worst component for the next maintenance indication.

Figure 47 Maintenance screens, pages 4 through 7

Compressor 1A Settings (page 4 of 7)		◀UNIT 1▶
S034	PASSWORD (Actual Level 0)	????
S035		
S036		
S037		
S038		
S039		
S040		
S041		
S042		
S043		
S044		

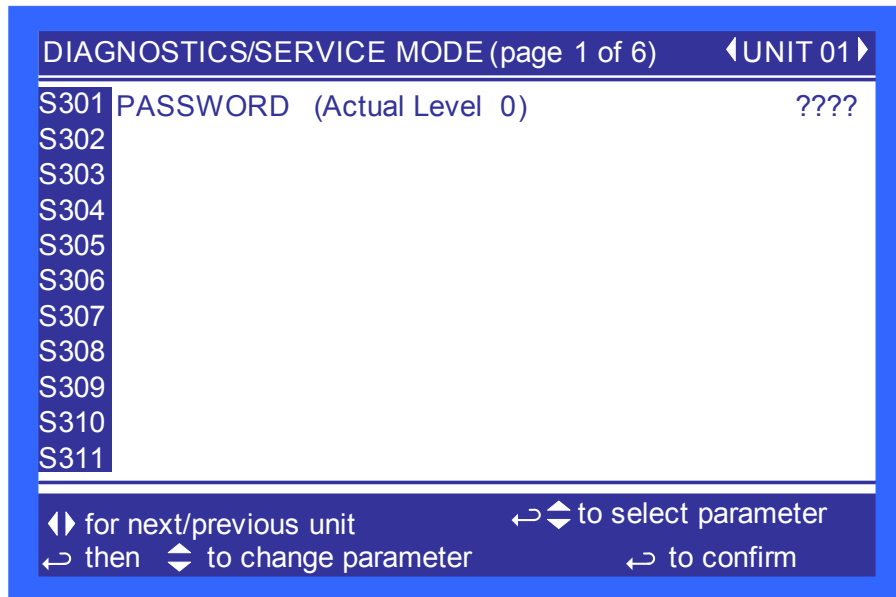
Compressor 1B Settings (page 5 of 7)		◀UNIT 1▶
S045	PASSWORD (Actual Level 0)	????
S046		
S047		
S048		
S049		
S050		
S051		
S052		
S053		
S054		
S055		

Compressor 2A Settings (page 6 of 7)		◀UNIT 1▶
S056	PASSWORD (Actual Level 0)	????
S057		
S058		
S059		
S060		
S061		
S062		
S063		
S064		
S065		
S066		

Compressor 2B Settings (page 7 of 7)		◀UNIT 1▶
S067	PASSWORD (Actual Level 0)	????
S068		
S069		
S070		
S071		
S072		
S073		
S074		
S075		
S076		
S077		

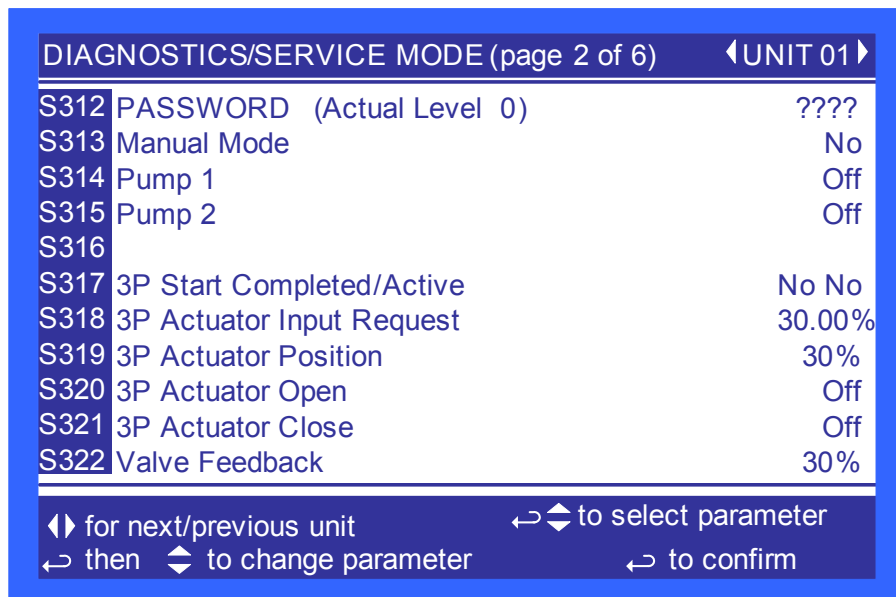
Pages 4 through 7 apply only to the Liebert XDC. No Liebert XDP parameters are present.

Figure 48 Diagnostics/Service Mode screen, page 1 of 6



Page 1 applies to the Liebert XDC only. No Liebert XDP parameters are present.

Figure 49 Diagnostics/Service Mode screen, page 2 of 6



Manual Mode—Used to place the Liebert iCOM control in manual mode. This is the initial setting necessary to activate any of the following items. When the Liebert iCOM is not in manual mode, each service menu item shows the current status of each parameter.

Pump 1—Starts the unit's Pump 1.

Pump 2—Starts the unit's Pump 2.

3P Start Active/Complete—Displays if the startup routine is active, and if it is completed.

3P Actuator Input Request—Shows the % call for cooling.

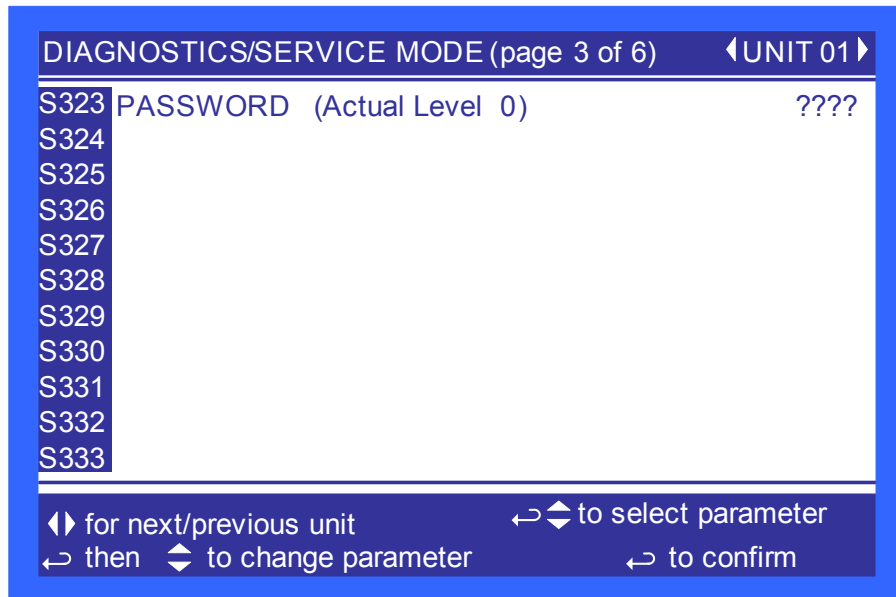
3P Actuator Position—Sets the position of the actuator 0-100% in manual mode.

3P Actuator Open—Opens the 3P actuator when set to ON in manual mode.

3P Actuator Close—Closes the 3P actuator when set to ON in manual mode

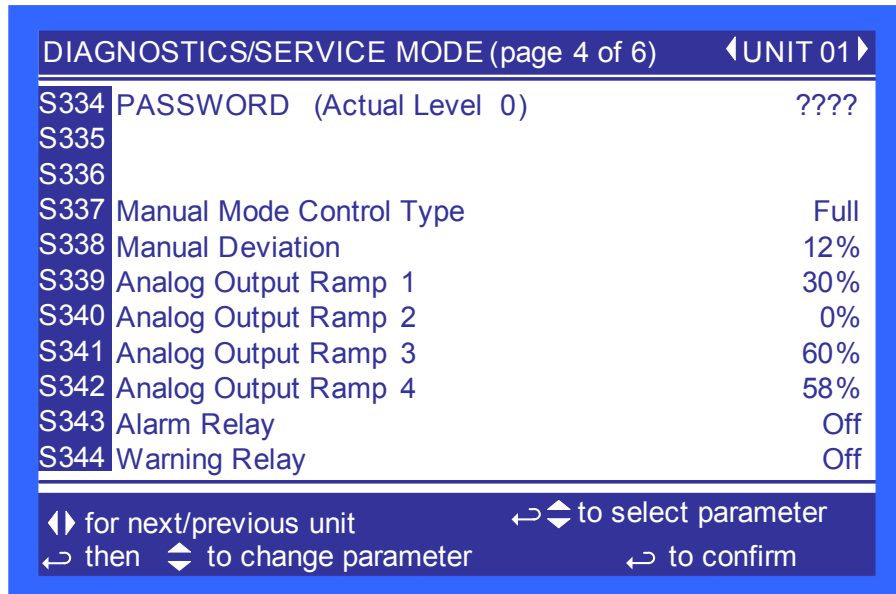
Valve Feedback—Opens the valve % in manual mode.

Figure 50 Diagnostics/Service Mode screen, page 3 of 6



Page 3 applies to the Liebert XDC only. No Liebert XDP parameters are present.

Figure 51 Diagnostics/Service Mode screen, page 4 of 6



Manual Mode Control Type—Not currently used.

Manual Deviation—Not currently used.

Analog Output Ramp 1—Sets the value of Analog Output 1 value as a percentage. The factory default for the Liebert XDP is the Valve % Open.

Analog Output Ramp 2—Sets the value of Analog Output 2 value as a percentage. The factory default for the Liebert XDP is the Call for Cooling.

Analog Output Ramp 3—Sets the value of Analog Output 3 value as a percentage. The factory default for the Liebert XDP is the CW Temp.

Analog Output Ramp 4—Sets the value of Analog Output 4 value as a percentage. The factory default for the Liebert XDP is the refrigerant temperature.

Alarm Relay—Used to activate the Liebert iCOM's common alarm relay output.

Warning Relay—Used to activate the Liebert iCOM's warning relay output.

Figure 52 Diagnostics/Service Mode screen, page 5 of 6

DIAGNOSTICS/SERVICE MODE (page 5 of 6)		◀UNIT 01▶	
S345	PASSWORD (Actual Level 0)		????
S346	Status Remote Shutdown	o-o	On
S347	Status Fan Failure	o/o	Ok
S348	Status Diff Press Switch1	o/o	Act
S349			
S350			
S351			
S352	Status Customer Input 1	o/o	Ok
S353	Status Condensation Detect	o/o	Ok
S354	Status Unit Ready	o-o	On
S355			

◀▶ for next/previous unit ↵ to select parameter
 ↵ then ◀▶ to change parameter ↵ to confirm

Status Remote Shutdown—Displays the status of the unit's remote shutdown input.

Status Fan Failure—Displays the status of the dry contact to communicate fan failure at a module. (The dry contacts are not used to communicate a fan failure alarm when using CANbus.)

Status Diff Press Switch 1—Displays the status of the differential pressure switch.

Status Customer Input 1—Displays the status of the customer input 1 alarm.

Status Condensation Detect—Displays the status of the dry contact to communicate condensate detection at a module.

Status Unit Ready—Shows unit status when a secondary device, such as a fire detection system, is employed.

Figure 53 Diagnostics/Service Mode screen, page 6 of 6

DIAGNOSTICS/SERVICE MODE (page 6 of 6)		◀UNIT 01▶	
S356	PASSWORD (Actual Level 0)		????
S357			
S358			
S359			
S360			
S361			
S362			
S363			
S364			
S365			
S366			

◀▶ for next/previous unit ↵ to select parameter
 ↵ then ◀▶ to change parameter ↵ to confirm

Page 6 applies to the Liebert XDC only. No Liebert XDP parameters are present.

Figure 54 Set Alarms screen, page 1 of 7

SET ALARMS (page 1 of 7)		◀UNIT 01▶
S201	PASSWORD (Actual Level 0)	????
S202	High Room Air Temperature	88.0°F
S203	Low Room Air Temperature	55.0°F
S204	High Room Dewpoint	65.0°F
S205	High Refrigerant Temperature	80.0°F
S206		
S207	High Chilled Water Temperature	60.0°F
S208		
S209		
S210		
S211		

◀▶ for next/previous unit ↵◀▶ to select parameter
 ↵ then ▶ to change parameter ↵ to confirm

High Room Air Temperature—Sets the threshold for a high room air temperature alarm. The range for the high room air temperature alarm is from 33.8 to 95°F (1 to 35°C); the default is 80°F (26.7°C).

Low Room Air Temperature—Sets the threshold for a low room air temperature alarm. The range for the low room air temperature alarm is from 33.8 to 95°F (1 to 35°C); the default is 55°F (12.8°C).

High Room Dewpoint—Sets the threshold for a return high dew point alarm. The range for the high room dew point alarm is from 33.8 to 95°F (1 to 35°C); the default is 65°F (18.3°C).

High Refrigerant Temperature—Sets the threshold for a high a refrigerant temperature alarm. The range for the high supply refrigerant temperature alarm is from 33.8 to 95°F (1 to 35°C); the default is 80°F (26.7°C).

High Chilled Water Temperature—Sets the threshold chilled water temperature for a supply high chilled water temperature alarm. The range for the high supply refrigerant temperature alarm is from 33.8 to 95°F (1 to 35°C); the default is 60°F (15.6°C).

Figure 55 Set Alarms screen, page 2 of 7

SET ALARMS (page 2 of 7)		◀UNIT 01▶
S212	PASSWORD (Actual Level 0)	????
S213	Customer Input 1	Water Alarm
S214	Customer Input 1 active when	Closed
S215		
S216		
S217		
S218		
S219		
S220		
S221	WARNING ACTIVATES ALARM RELAY	Yes
S222	Reset Disabled Alarms	No

◀▶ for next/previous unit ↵ to select parameter
 ↵ then ◀▶ to change parameter ↵ to confirm

Customer Input 1—Selects the device and operation of the customer input. Each event reflects a different alarm and possible action to the unit. Selectable options are:

- Call Service
- C-Input
- Water
- Smoke

Customer Input 1 active when—Selects whether the Customer Input 1 input is normally closed or normally open.

WARNING ACTIVATES ALARM RELAY—Sets the alarm relay (K3) to activate when a warning occurs.

Reset Disabled Alarms—Resets disabled events.

The Set Alarm Screens (**Figure 56** through **60**) permit setting the operation of an active alarm. Each event can be enabled or disabled and can be set to operate as an alarm, warning or message. The delay is the time the control waits before reporting the event.

Alarm: Annunciates the buzzer, triggers a monitoring event, triggers the alarm relay and flashes the red LED on the display.

Warning: Annunciates the buzzer, triggers a monitoring event, shows the event in the event viewer / front display and flashes the red LED on the display.

Message: Shows the event in the event viewer and on the front display.

Figure 56 Set Alarms screen, page 3 of 7

SET ALARMS (page 3 of 7)		◀UNIT 01▶		
S223	PASSWORD (Actual Level 0)			????
S224		DELAY	EN-DIS	TYPE
S225	HIGH TEMP SENSOR A	30	ENABLE	ALM
S226	LOW TEMP SENSOR A	30	ENABLE	ALM
S227	HIGH TEMP SENSOR B	30	ENABLE	ALM
S228	LOW TEMP SENSOR B	30	ENABLE	ALM
S229	HIGH DEWPOINT	30	ENABLE	ALM
S230	SENSOR A FAILURE		ENABLE	ALM
S231	SENSOR B FAILURE		ENABLE	ALM
S232	HIGH CHILLED WATER TEMP	30	ENABLE	ALM
S233	SUPPLY CW SENSOR FAILURE		ENABLE	ALM
S234				
S235				

◀▶ for next/previous unit ↵↻ to select parameter
 ↵ then ↻ to change parameter ↵ to confirm

HIGH TEMP SENSOR A—Enables or disables the High Temperature Sensor A event, which occurs when the reading from Sensor A is above the user-specified alarm setpoint. Sets how the event is reported: as an alarm, a warning or a message. Specifies how long the control waits before reporting the event.

LOW TEMP SENSOR A—Enables or disables the Low Temperature Sensor A event, which occurs when the reading from Sensor A is below the user-specified alarm setpoint. Sets how the event is reported: as an alarm, a warning or a message. Specifies how long the control waits before reporting the event.

HIGH TEMP SENSOR B—Enables or disables the High Temperature Sensor B event, which occurs when the reading from Sensor B is above the user-specified alarm setpoint. Sets how the event is reported as an alarm, a warning or a message. Specifies how long the control waits before reporting the event.

LOW TEMP SENSOR B—Enables or disables the Low Temperature Sensor B event, which occurs when the reading from Sensor B is below the user-specified alarm setpoint. Sets how the event is reported: as an alarm, a warning or a message. Specifies how long the control waits before reporting the event.

HIGH DEWPOINT—Enables or disables the High Dewpoint event, which occurs when the calculated dew point at Sensor A or Sensor B is above the user-specified alarm setpoint. Sets how the event is reported: as an alarm, a warning or a message. Specifies how long the control waits before reporting the event.

SENSOR A FAILURE—Enables or disables the Sensor A Failure event, which occurs when the control no longer senses a signal from Sensor A. Sets how the event is reported: as an alarm, a warning or a message. Specifies how long the control waits before reporting the event.

SENSOR B FAILURE—Enables or disables the Sensor B Failure event, which occurs when the control no longer senses a signal from Sensor B. Sets how the event is reported: as an alarm, a warning or a message. Specifies how long the control waits before reporting the event.

HIGH CHILLED WATER TEMP—Enables or disables the High Chilled Water Temp event, which occurs when the reading from Supply Chilled Water Sensor is above the user-specified alarm setpoint. Sets how the event is reported: as an alarm, a warning or a message. Specifies how long the control waits before reporting the event.

SUPPLY CW SENSOR FAILURE—Enables or disables the Supply CW Sensor Failure Failure event, which occurs when the control no longer senses a signal from Supply CW Sensor. Sets how the event is reported: as an alarm, a warning or a message. Specifies how long the control waits before reporting the event.

Figure 57 Set Alarms screen, page 4 of 7

SET ALARMS (page 4 of 7)		◀UNIT 01▶		
S236	PASSWORD (Actual Level 0)			????
S237		DELAY	EN-DIS	TYPE
S238	HIGH REFRIGERANT TEMP	30	ENABLE	ALM
S239	LOW REFRIGERANT TEMP	30	ENABLE	ALM
S240	SUPPLY REFRIGERANT SENSOR		ENABLE	ALM
S241	LOSS OF FLOW PUMP 1		ENABLE	ALM
S242	LOSS OF FLOW PUMP 2		ENABLE	ALM
S243	PUMP SHORT CYCLE		ENABLE	ALM
S244				
S245				
S246				
S247	CONTROL VALVE FAILURE		ENABLE	ALM
S248				

◀▶ for next/previous unit ↵↻ to select parameter
 ↵ then ↻ to change parameter ↵ to confirm

HIGH REFRIGERANT TEMP—Enables or disables the High Refrigerant Temp event, which occurs when the reading from supply refrigerant temperature sensor is above the user-specified alarm setpoint. Sets how the event is reported: as an alarm, a warning or a message. Specifies how long the control waits before reporting the event.

LOW REFRIGERANT TEMP—Enables or disables the Low Refrigerant Temp event, which occurs when the reading from supply refrigerant temperature sensor is below the user-specified alarm setpoint. Sets how the event is reported: as an alarm, a warning or a message. Specifies how long the control waits before reporting the event.

SUPPLY REFRIGERANT SENSOR—Enables or disables the Supply Refrigerant Sensor event, which occurs when the control no longer senses a signal from the Supply Refrigerant Sensor. Sets how the event is reported: as an alarm, a warning or a message. Specifies how long the control waits before reporting the event.

LOSS OF FLOW PUMP 1—Enables or disables the Loss of Flow Pump 1 event, which occurs when Pump 1 is commanded to run and the differential pressure switch does not sense differential pressure. Sets how the event is reported: as an alarm, a warning or a message. Specifies how long the control waits before reporting the event.

LOSS OF FLOW PUMP 2—Enables or disables the Loss of Flow Pump 2 event, which occurs when Pump 2 is commanded to run and the differential pressure switch does not sense differential pressure. Sets how the event is reported: as an alarm, a warning or a message. Specifies how long the control waits before reporting the event.

PUMP SHORT CYCLE—Enables or disables the Pump Short Cycle event, which occurs when flow is not established by either pump for 30 minutes. Sets how the event is reported: as an alarm, a warning or a message. Specifies how long the control waits before reporting the event.

CONTROL VALVE FAILURE—Enables or disables the Control Valve Failure event, which occurs when the chilled water control valve has been commanded by the control to open or close and no change is detected by the valve position signal. Sets how the event is reported: as an alarm, a warning or a message. Specifies how long the control waits before reporting the event.

Figure 58 Set Alarms screens, pages 5 and 6

Figure 58 displays two screenshots of the 'SET ALARMS' menu. The left screenshot shows page 5 of 7, and the right screenshot shows page 6 of 7. Both screens show the 'PASSWORD (Actual Level 0)' parameter with a '????' value and columns for 'DELAY', 'EN-DIS', and 'TYPE'. The left screenshot lists parameters S250 through S261, and the right screenshot lists parameters S262 through S274. Navigation instructions are provided at the bottom of each screen.

Pages 5 and 6 apply to the Liebert XDC only. No Liebert XDP parameters are present.

Figure 59 Set Alarms screen, page 7 of 7

Figure 59 displays the 'SET ALARMS' menu, page 7 of 7. The screen shows parameters S275 through S287. S275 is 'PASSWORD (Actual Level 0)' with a '????' value. S276 has columns for 'DELAY', 'EN-DIS', and 'TYPE'. S278-S286 show event names, delay values, and enable/disable/reporting options. S287 is empty. Navigation instructions are provided at the bottom of the screen.

Parameter	Event Name	Delay	Enable/Disable	Reporting Type
S275	PASSWORD (Actual Level 0)			????
S276				DELAY EN-DIS TYPE
S278	CONDENSATION DETECTED	3	ENABLE	ALM
S279	FAN FAILURE	3	ENABLE	ALM
S280	CUSTOMER INPUT 1	5	ENABLE	ALM
S281	SMOKE DETECTED	5	ENABLE	ALM
S282	WATER UNDER FLOOR	5	ENABLE	ALM
S283	UNIT X DISCONNECTED		ENABLE	WRN
S284	WORKING HRS EXCEEDED		ENABLE	WRN
S285	CALL SERVICE	5	ENABLE	ALM
S286	LOSS OF POWER		ENABLE	WRN
S287				

CONDENSATION DETECTED—Enables or disables the Condensation Detected event, which occurs when water is detected at a Liebert XD cooling module. Sets how the event is reported: as an alarm, a warning or a message. Specifies how long the control waits before reporting the event.

FAN FAILURE—Enables or disables the Fan Failure event, which occurs when a fan failure occurs at a Liebert XD cooling module. Sets how the event is reported: as an alarm, a warning or a message. Specifies how long the control waits before reporting the event.

CUSTOMER INPUT 1—Enables or disables the Customer Input 1 event, which occurs when 24VAC is applied to the input. Sets how the event is reported: as an alarm, a warning or a message. Specifies how long the control waits before reporting the event.

SMOKE DETECTED—Enables or disables the Smoke Detected event, which occurs when the Customer Input 1 is configured for “Smoke Detected” and 24VAC is applied to the input. Sets how the event is reported: as an alarm, a warning or a message. Specifies how long the control waits before reporting the event.



NOTE

This is not a room smoke detector and is not intended to replace external smoke detectors.

WATER UNDER FLOOR—Enables or disables the Water Under Floor event, which occurs when the Customer Input 1 is configured for “Water Under Floor” and 24VAC is applied to the input. Sets how the event is reported: as an alarm, a warning or a message. Specifies how long the control waits before reporting the event.

UNIT X DISCONNECTED—Not currently used.

WORKING HOURS EXCEEDED—Enables or disables the Working Hrs Exceeded event, which occurs when a component has exceeded the user-specified limit. Sets how the event is reported: as an alarm, a warning or a message. Specifies how long the control waits before reporting the event.

CALL SERVICE—Enables or disables the Call Service event, which occurs when the Customer Input 1 is configured for “Call Service” and 24VAC is applied to the input. Sets how the event is reported: as an alarm, a warning or a message. Specifies how long the control waits before reporting the event.

LOSS OF POWER—Enables or disables the Loss of Power event, which occurs when the unit is On and operational and the 24VAC power to the control is lost. Sets how the event is reported: as an alarm, a warning or a message. Specifies how long the control waits before reporting the event.

Figure 60 Sensor Calibration/Setup screen, page 1 of 3

SENSOR CALIBRATION/SETUP (page 1 of 3)		◀UNIT 01▶
S601	PASSWORD (Actual Level 0)	????
S602	Temperature Sensor A	+0.0°F
S603	Calibrated Temperature Sensor A	70.3°F
S604	Humidity Sensor A	+0.0°F
S605	Calibrated Humidity Sensor A	38.3%
S606	Temperature Sensor B	+0.0°F
S607	Calibrated Temperature Sensor B	72.3°F
S608	Humidity Sensor B	+0.0°F
S609	Calibrated Humidity Sensor B	35.6%
S610		
S611		

◀▶ for next/previous unit ↔ to select parameter
 ↔ then ◀▶ to change parameter ↵ to confirm

Temperature Sensor A—Adjusts the temperature reading from the actual remote CAN Temp Humidity sensor designated as Sensor A to compensate for any error of the sensor or to match other sensors in the room.

Calibrated Temperature Sensor A—Displays the adjusted temperature value of the remote CAN Temp Humidity sensor designated as Sensor A. This value is the actual sensor reading plus or minus the offset Temperature Sensor A.

Humidity Sensor A—Adjusts the humidity reading from the actual remote CAN Temp Humidity sensor designated as Sensor A to compensate for any error of the sensor or to match other sensors in the room.

Calibrated Humidity Sensor A—Displays the adjusted humidity value of the remote CAN Temp Humidity sensor designated as Sensor A. This value is the actual sensor reading plus or minus the offset Humidity Sensor A.

Temperature Sensor B—Adjusts the temperature reading from the actual remote CAN Temp Humidity sensor designated as Sensor B to compensate for any error of the sensor or to match other sensors in the room.

Calibrated Temperature Sensor B—Displays the adjusted temperature value of the remote CAN Temp Humidity sensor designated as Sensor B. This value is the actual sensor reading plus or minus the offset Temperature Sensor B.

Humidity Sensor B—Adjusts the humidity reading from the actual remote sensor designated as Sensor B to compensate for any error of the sensor or to match other sensors in the room.

Calibrated Humidity Sensor B—Displays the adjusted humidity value of the remote CAN Temp Humidity sensor designated as Sensor B. This value is the actual sensor reading plus or minus the offset Humidity Sensor B.

Figure 61 Sensor Calibration/Setup screen, page 2 of 3

SENSOR CALIBRATION/SETUP (page 2 of 3)		◀UNIT 01▶
S612	PASSWORD (Actual Level 0)	????
S613	Supply Refrigerant Sensor	+0.0°F
S614	Calibrated Supply Refrigerant Sensor	58.5°F
S615		
S616		
S617	Supply Chilled Water Sensor	+0.0°F
S618	Calibrated Supply Chilled Water Sensor	60.1°F
S619		
S620		
S621		
S622		

◀▶ for next/previous unit ↵◀▶ to select parameter
 ↵ then ▶ to change parameter ↵ to confirm

Supply Refrigerant Sensor—Adjusts the temperature reading from the actual supply refrigerant sensor to compensate for any error of the sensor.

Calibrated Supply Refrigerant Sensor—Displays the adjusted temperature value of the supply refrigerant sensor. This value is the actual sensor reading plus or minus the offset Supply Refrigerant Sensor.

Supply Chilled Water Sensor—Adjusts the temperature reading from the actual supply chilled water sensor to compensate for any error of the sensor.

Calibrated Chilled Water Sensor—Displays the adjusted temperature value of the supply chilled water sensor. This value is the actual sensor reading plus or minus the offset Supply Chilled Water Sensor.

Figure 62 Sensor Calibration/Setup screen, page 3 of 3

SENSOR CALIBRATION/SETUP (page 3 of 3)		◀UNIT 01▶
S623	PASSWORD (Actual Level 0)	????
S624	Supply Refrigerant Sensor 0%	30.0°F
S625	Supply Refrigerant Sensor 100%	90.0°F
S626		
S627		
S628		
S629		
S630		
S631		
S632		
S633		

◀▶ for next/previous unit ↵◀▶ to select parameter
 ↵ then ▶ to change parameter ↵ to confirm

Supply Refrigerant Sensor 0%—Allows the sensor reading to be calibrated at the lowest reading of the sensor. This calibration changes the start point of the sensor reading.

Supply Refrigerant Sensor 100%—Allows the sensor reading to be calibrated at the highest reading of the sensor. This calibration changes the end point of the sensor reading.

Figure 63 System/Network Setup screen—System, page 1 of 2

SYSTEM/NETWORK SETUP (page 1 of 2)		SYSTEM	
S801	PASSWORD (Actual Level 0)		????
S802	Number of Connected Units		1
S803			
S804			
S805			
S806			
S807			
S808			
S809	Configuration Safe	OK	No
S810	Network Safe	OK	No
S811	SW Version	XP1.00.010.STD	

⏪ for next/previous unit ⏩ to select parameter
 ⏪ then ⏩ to change parameter ⏩ to confirm

Number of Connected Units—Shows the number of displays connected. This is always 1.

Configuration Safe—Saves or loads configuration settings for the display that have been modified from the factory defaults to an internal file that can be downloaded/uploaded using the Liebert iCOM Service Tool. Selecting Save will write the settings to the internal storage file and selecting Load will write the settings from the internal storage file to the application software. The internal file is updated automatically every 12 hours.

Network Safe—Saves or loads network settings for the display that have been modified from the factory defaults to an internal file that can be downloaded/uploaded using the Liebert iCOM Service Tool. Selecting Save will write the settings to the internal storage file and selecting Load will write the settings from the internal storage file to the application software.

SW Version—Contains the application software version loaded onto the Liebert iCOM display.

Figure 64 System/Network Setup screen—System, page 2 of 2

SYSTEM/NETWORK SETUP (page 2 of 2)		SYSTEM
S812	PASSWORD (Actual Level 0)	????
S813	IP Address	192.168.254.003
S814	Netmask	255.255.255.000
S815	Gateway	0.000.000.000
S816	MAC	00:00:68:19:40:C7
S817	U2U Protocol	GBP
S818	U2U Address	33
S819	U2U Group	1
S820		
S821	Bootloader Variables	OK No
S822		

Attention: any changes done on these parameters must be followed by a 'Save+Reboot' command.

IP Address—Contains the network address of the display. This address must be unique on the network. The factory default is 192.168.254.003.

Netmask—Defines which part of the IP address is used for the network. The factory default is 255.255.255.000.

Gateway—A network point that acts as an entrance to another network. The factory default is 0.000.000.000.

MAC—A unique hardware identifier for the Ethernet device. The following parameters (U2U Protocol, U2U Address and U2U Group) are for displaying other networked Liebert XDPs. The Liebert XDP does not perform Teamwork Operations.

U2U Protocol—This is always set to GBP.

U2U Address—A unique identifier for each display on the network. Display addresses range from 33 to 64. Each display on the U2U network must have a different U2U address. Not currently used.

U2U Group—Used to create zones or groups within a U2U network. Once a group number is selected, the display will see only other devices with the same group number. The group number can be changed to view other devices in different groups. Not currently used.

Bootloader Variables—Indicates the bootloader has changed since it was last loaded. This parameter should only be activated by an authorized service person.

Figure 65 System/Network Setup screen—Unit, page 1 of 2

SYSTEM/NETWORK SETUP (page 1 of 2)		◀UNIT 01▶	
S823	PASSWORD (Actual Level 0)		????
S824	Monitoring Address		3
S825			
S826			
S827	Unit Name		UNIT
S828			
S829			
S830			
S831	Configuration Safe	OK	No
S832	Network Safe	OK	No
S833	SW Verson		XP1.00.008.STD

◀▶ for next/previous unit ↵ to select parameter
 ↵ then ◀▶ to change parameter ↵ to confirm

Monitoring Address—Sets the address used by the Liebert IntelliSlot[®] cards. This is set to 3 at the factory and should not be changed.

Unit Name—Identifies the unit from the local or remote display. This label will show at the top right of every screen that has monitoring or configuration of that unit

Configuration Safe—Saves or loads configuration settings for the control board that have been modified from the factory defaults to an internal file that can be downloaded / uploaded using the Liebert iCOM Service Tool. Selecting “Save” will write the settings to the internal storage file and selecting “Load” will write the settings from the internal storage file to the application software. The internal file is updated every 12 hours automatically.

Network Safe—Saves or loads network settings for the control board that have been modified from the factory defaults to an internal file that can be downloaded / uploaded using the Liebert iCOM Service Tool. Selecting “Save” will write the settings to the internal storage file and selecting “Load” will write the settings from the internal storage file to the application software.

SW Version—Contains the application software version loaded onto the Liebert iCOM.

Figure 66 System/Network Setup screen—Unit, page 2 of 2

SYSTEM/NETWORK SETUP (page 2 of 2)		◀UNIT 01▶	
S834	PASSWORD (Actual Level 0)		????
S835	Monitoring Protocol		Velocity V4
S836	IP Address		192.168.254.003
S837	Netmask		255.255.255.000
S838	Gateway		0.000.000.000
S839	MAC		00:00:68:19:9B:42
S840	U2U Protocol		GBP
S841	U2U Address		1
S842	U2U Group		1
S843	Bootloader Variables	OK	No
S844	Static RAM	OK	No

Attention: any changes done on these parameters must be followed by a 'Save+Reboot' command.

Monitoring Protocol—Selects the monitoring protocol. Velocity V4 is the factory default which will provide communications to the Liebert IntelliSlot housing. IGMnet will activate the 77/78 terminals for communication to the Liebert SiteLink(-E). Liebert Hironet is only used on Liebert HPM units.

IP Address—Contains the network address of the display. This address must be unique to every other device on the network. The factory default is 192.168.254.003.

Netmask—Defines which part of the IP address is used for the network. The factory default is 255.255.255.000.

Gateway—A gateway is a network point that acts as an entrance to another network. The factory default is 0.000.000.000.

MAC—The MAC address is a unique hardware identifier of the Ethernet device.

The following parameters (U2U Protocol, U2U Address and U2U Group) are for displaying other Liebert XDPs that are networked. The Liebert XDP does not perform Teamwork Operations.

U2U Protocol—Always set to GBP.

U2U Address—Unique identifier for each display on the network. Display addresses range from 1 to 32. Each display on the U2U network must have a different U2U address. Not currently used.

U2U Group—Creates zones or groups within a U2U network. Once a group number is selected the display will only see other devices with the same group number. The group number can be changed to view other devices in different groups. Not currently used.

Bootloader Variables—Indicates if there has been a change to the boot loader since it was last loaded. This parameter should only be activated by authorized service personnel.

Static RAM—Allows service personnel to clear and reboot the RAM of the control board. Only Emerson service personnel should perform this function.

Figure 67 Options Setup screen, page 1 of 2

OPTIONS SETUP (page 1 of 2)		◀UNIT 01▶
S401	PASSWORD (Actual Level 0)	????
S402	Autorestart Enabled	Yes
S403	Single Unit Auto Restart	5sec
S404	Unit Start Sequence Delay	1sec
S405	Control Delay Time	1sec
S406	Pump Start Time Delay	10sec
S407	Pump Wait Time Delay	10sec
S408	Pump Off Time Delay	5sec
S409		
S410	Pump Short Cycle Delay	30min
S411		

◀▶ for next/previous unit ↵ to select parameter
 ↵ then ◀▶ to change parameter ↵ to confirm

Autorestart Enabled—Restarts the unit after a power cycle when set to Yes. When this parameter is set to No, the unit will not restart after a power cycle.

Single Unit Auto Restart—Sets a time delay for the unit to restart when the Auto Restart Enabled is set to Yes. The delay begins once the boot process has completed. This parameter allows units to be staggered On to reduce the amount of simultaneous power consumption after a loss of power.

Unit Start Sequence Delay—Not currently used.

Control Delay Time—Not currently used.

Pump Start Time Delay—Sets a time delay to ensure that refrigerant begins flowing when the pump starts. If refrigerant does not begin flowing before the user-set delay expires, the pump will be turned Off.

Pump Wait Time Delay—Sets the pump wait time delay to prevent the pump from continuing to run when refrigerant is not flowing. If a pump is running normally and refrigerant flow is lost, the pump will stay On for the specified time trying to re-establish refrigerant flow. If refrigerant flow resumes during the specified interval, the pump will continue operating. If the wait time expires and refrigerant flow has not resumed, the pump will shut down.

Pump Off Time Delay—Sets the length of time a pump will remain off when refrigerant flow is interrupted or stops. After the time delay has expired, the control will try to restart the pump.

Lead Pump—Sets which pump is the active pump. It can be set to PUMP 1 or PUMP 2. The control will operate the respective pump unless a loss of flow condition occurs. On a LOSS OF FLOW condition, the control will switch to the standby pump after the LOSS OF FLOW alarm time delay has elapsed and the LOSS OF FLOW alarm has been annunciated. The default is PUMP 1.

Pump Short Cycle Delay—Sets the time to lock Off the unit if it is unable to establish refrigerant flow within this set amount of time.

Figure 68 Options Setup screen, page 2 of 2

OPTIONS SETUP (page 2 of 2)		◀UNIT 01▶
S412	PASSWORD (Actual Level 0)	????
S413	Valve Start Open	30%
S414	Valve Start TD	90sec
S415	3P Actuator Runtime	70sec
S416	3P Actuator Direction	Direct
S417	Unit Off Valve % Open	30%
S418		
S419		
S420		
S421		
S422		

◀▶ for next/previous unit ↵ to select parameter
 ↵ then ◀▶ to change parameter ↵ to confirm

Valve Start Open—Sets position of the valve when the unit starts.

Valve Start TD—Sets a time interval for the unit to complete startup and enter into normal operation.

3P Actuator Runtime—If Valve Control is selected for “Time” then this parameter sets the travel time of the valve to determine the full open and closed position of the valve. This parameter is set at the factory, based on the valve manufacturer’s specifications.

3P Actuator Direction—Sets if the valve is a “Direct” or “Reverse” acting valve.

Unit Off Valve % Open—Sets the valve position when the unit is Off.

Figure 69 Module Setup screen, page 1 of 20

MODULE SETUP (page 1 of 20)		◀UNIT 01▶
S901	PASSWORD (Actual Level 0)	????
S902	NODE ID 81	DELAY EN-DIS TYPE
S903	CONDENSATION DETECTED	15 ENABLE
S904	LOCAL MODULE SHUTDOWN	15 ENABLE ALM
S905	SENSOR FAILURE	30 ENABLE ALM
S906	FAN FAILURE	30 ENABLE ALM
S907	FAN CONTROL MODE	OFF
S908	DISABLE LOCAL BUTTON	NO
S909	FLASH LED AT MODULE	NO
S910	SET MODULE LABEL	A Z81
S911	SUPPLY AIR TEMP LIMITS	High 80 Low 50 °F
S912	RETURN AIR TEMP LIMITS	High 120 Low 60 °F
S913	FIRMWARE VERSION	XXX.XX.XXX

This screen selects the operation of an active alarm for each smart module. Each event can be enabled or disabled and can be set to operate as an alarm, a warning or a message. The delay is the time the control waits before reporting the event.

Alarm: Annunciates the buzzer, triggers a monitoring event, triggers the alarm relay and flashes the red LED on the display.

Warning: Annunciates the buzzer, triggers a monitoring event, shows the event in the event viewer/front display and flashes the red LED on the display.

Message: Shows the event in the event viewer and on the front display.

Fan Control Type—Sets the fan control mode. Values can be OFF, ON, ON ALL and TEMP CNTL.

Disable Local Button—Disables the push button on the front of the smart module. To disable the push button, set the parameter to YES. To re-enable the push button, set the parameter to NO.

Flash LED at Module—Flashes the LED on the smart module when set to Yes.

Set Module Label—A four-character label consisting of two letters and two numerals. This is the standard nomenclature for Data Center Grid assignment of racks. Additionally, the module's location can be denoted with 10 characters, either letters or non-alphanumeric characters from a built-in list. Either or both labels can be used and are entered using this screen.

Supply Air Temp Limit—Sets the high and low supply air temperature to from the module. An alarm will occur if the temperature falls outside the limits.

Return Air Temp Limit—Sets the high and low return air temperature to from the module. An alarm will occur if the temperature falls outside the limits.

Firmware Version—Displays the firmware version installed on the smart module.

Figure 70 Module Setup screen, page 1 of 20

MODULE SETUP (page 1 of 20)		◀UNIT 01▶	
S901	PASSWORD (Actual Level 0)		????
S902	NODE ID 81	DELAY	EN-DIS TYPE
S903	CONDENSATION DETECTED	15	ENABLE
S904	LOCAL MODULE SHUTDOWN	15	ENABLE ALM
S905	SENSOR FAILURE	30	ENABLE ALM
S906	FAN FAILURE	30	ENABLE ALM
S907	FAN CONTROL MODE		OFF
S908	DISABLE LOCAL BUTTON		NO
S909	FLASH LED AT MODULE		NO
S910	SET MODULE LABEL		A Z81
S911	SUPPLY AIR TEMP LIMITS	High 80	Low 50 °F
S912	RETURN AIR TEMP LIMITS	High 120	Low 60 °F
S913	FIRMWARE VERSION		XXX.XX.XXX

5.0 START THE LIEBERT XDP WITH LIEBERT ICOM

5.1 Checklist for Liebert XDP Startup



CAUTION

Risk of piping and component rupture. May cause equipment damage or injury.

Closing service valves may isolate liquid refrigerant, causing high pressure and rupture of piping. Do not close valves without following recommended procedures for repair, maintenance and replacement of components. Install pressure relief valves in field piping that may become isolated by service valves.



NOTE

*The Liebert XDP160 requires a minimum load of 48kW (163,800BTU/H) before the system can be commissioned. This load can be supplied by actual user load in racks, by independent load banks or by the “Load Bank Testing” service of Emerson Network Power Liebert Services. To achieve the minimum load requirements, the capacity of all connected modules must total at least 48kW (163,800BTU/H). See **Table 1**.*



NOTE

*Before any action that could cause a disturbance in the Liebert XD system’s cooling function is begun, the facility manager **MUST** be informed. In addition, after the action is taken and the work is finished, the facility manager **MUST** be informed*

1. Verify that bypass flow controllers were installed (if applicable), see **Table 5**.
2. Verify that the minimum load level of 48kW (163,800BTU/H) is present.
3. Check all isolation ball valves in the Liebert XDP and Liebert XD cooling module and verify that all are open.
4. Check rotation of the Liebert XDP’s pumps.

On 460V units only—Hold the rotation device provided against the pump housing at the inspection screw prior to energizing the pumps. Counterclockwise indicates proper rotation; clockwise indicates incorrect rotation.

On 208V and 400V units only, view the LED indicator on the pump. Green indicates proper rotation; Green and Red indicate incorrect rotation.

Table 13 Liebert XDP pump light indicator—208V and 400V units

Indicator Lights		Description
Green	Red	
Off	Off	The electricity supply has been switched Off or the pump has been cut out by the thermal switch.
On	Off	The electricity supply has been switched On. Normal operation.
On	On	The electricity supply has been switched On. The direction of rotation is wrong .

5. Check rotation of fans on Liebert XD cooling module units.
6. Verify that air is being discharged into the cold aisle.
7. Confirm that the total calculated refrigerant R-134a amount has been properly charged into the system (see **3.6 - Filling the Pumped Circuit—R-134a**).
8. Confirm that the remote temperature/humidity sensors provided have been installed in optimal locations (see **2.4 - Remote Sensor Installation—Proper Placement**)

The Liebert XDP system is now ready to be turned ON.

5.2 Starting the Liebert XDP with Liebert iCOM Controller

The Liebert XDP is started, stopped and controlled through the Liebert iCOM controller. **Figure 24** shows the Liebert iCOM keypad.

1. Turn the Liebert XDP On with the user interface (I/O button). The factory-setting defaults Liebert XD module fans to On. When the Liebert XDP is turned On, the Liebert XD modules' fans will turn On. Allow the system to attempt to start for at least 2 minutes.

If the Liebert XDP pump cannot maintain flow and continues to switch over due to starting difficulties, refer to **7.0 - Troubleshooting**. After remedying the problem, proceed to **Step 2**.

2. If constant flow is established, wait until the Liebert XDP has been operating for 10-15 minutes, then verify that the refrigerant level in the receiver sight glass is between the second and third level (see **Figure 71**). Add or remove charge, if necessary.

3. Check pressure differential functionality:

The Liebert XDP system should be On. If it is Off:

- a. Turn the Liebert XDP On via user interface (I/O button). The factory-setting defaults Liebert XD module fans to On. When the Liebert XDP is turned On, the Liebert XD modules' fans will turn On.

If no “Loss of Flow” alarm is present—This suggests that there is flow. Test the pressure differential by closing the ball valve on either the suction line or discharge line to stop the flow.

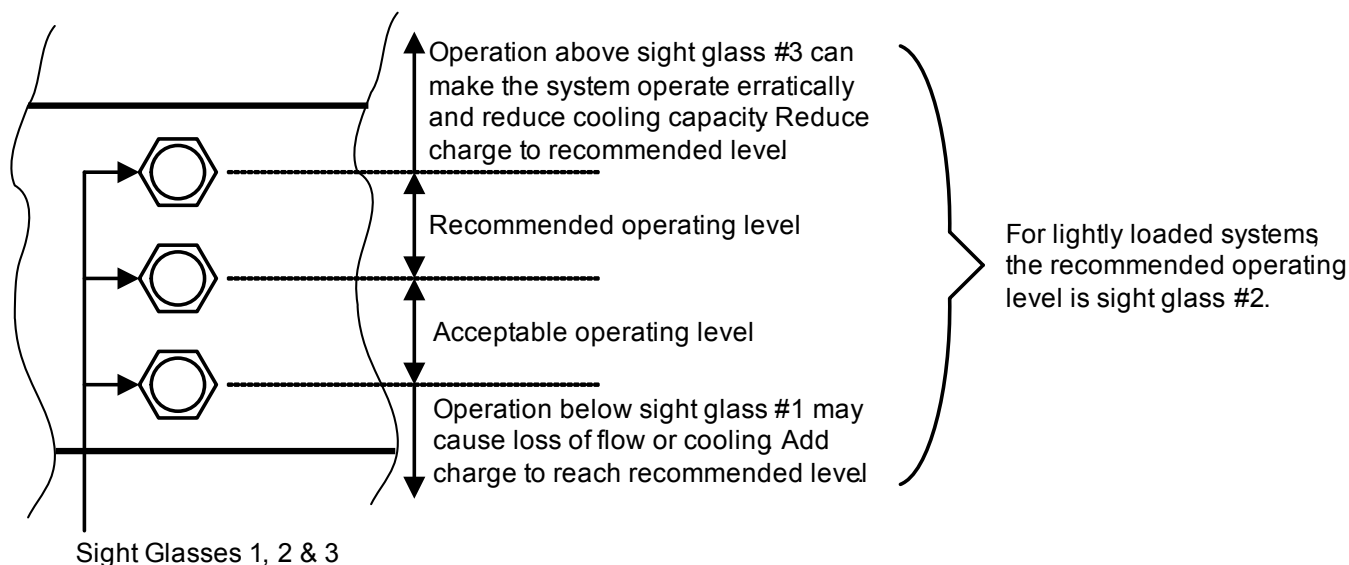
This should prompt an alarm for “loss of flow on P1.” This alarm confirms that the switch has opened on low pressure (below 6 psi; 41kPa; 0.41 bars).

If a “Loss of Flow” alarm is present—This suggests that there is no flow. Verify that this is correctly annunciated by looking at the sight glass in the receiver. If a true no-flow condition exists, the level will not move.

However, **if there is flow, but the differential reading is faulty**, the level will slowly drop, indicating flow, while the loss of flow alarm is annunciated.

Check the pressure differential physically by making sure that the electrical connections are properly connected. Then check the pressure differential electrically by making sure that the unit has 24VAC across it.

Figure 71 System R-134a liquid level at 160kW load



6.0 ALARM DESCRIPTIONS AND SOLUTIONS

6.1 Alarm Descriptions



NOTE

*Alarms **must be acknowledged** before they can be reset. To acknowledge or silence an alarm, press the ALARM key one time. This will silence the alarm; the red LED will remain illuminated until the alarm is reset.*

CALL SERVICE—Activated when Customer Input 1 is configured for “Call Service” and 24VAC is applied to the input. This alarm is reset when the 24VAC is removed.

CONDENSATION DETECTED (optional)—Activated when water is detected at a cooling module. A 24VAC signal is applied to the condensation input on the control board using a pair of twisted wires or the alarm is sent via CANbus communication. When this alarm is active, the control will raise its refrigerant control point by 4°F (2.2°C). This alarm will reset when the alarms is acknowledged and the signal stops being sent from CANbus or condensation input. The alarm can also be reset by cycling the power. The main power must be cycled to remove the 4°F (2.2°C) offset.

CONTROL VALVE FAILURE—Activated when the chilled water control valve has been commanded to open or close by the control and no change is detected by the valve position signal. The alarm is reset when the main power is cycled.

CUSTOMER INPUT 1—Activated when a 24VAC signal is applied to the customer alarm input on the control board. This alarm will reset when the 24VAC signal stops being sent from the customer alarm input. WATER UNDER FLOOR, SMOKE DETECTED, CALL SERVICE, and COMP LOCK PD are possible designations for this alarm; they are set with the Unit Code.

FAN FAILURE (optional)—Activated when a 24VAC signal is applied to the fan failure input on the control board using a twisted pair of wires or the alarm is sent via CANbus communication. This alarm will reset when the alarms is acknowledged and the signal stops being sent from CANbus or fan failure input. The alarm can also be reset by cycling the power.

HIGH CW TEMP—Activated when the Supply CW sensor reads the chilled water temperature above the user-specified alarm setpoint. This alarm will reset when the reading from the refrigerant temperature sensor drops 5°F (2.8°C) below the user-specified setpoint and the alarm has been acknowledged.

HIGH DEW POINT—Activates when the calculated dew point at either Sensor A or B exceeds the user-specified alarm setpoint. The alarm will reset when the calculated room dew point from both Sensor A and Sensor B is 2°F (1.1°C) below the setpoint and the alarm has been acknowledged.

HIGH REFRIGERANT TEMP—Activated when the refrigerant temperature sensor reads the refrigerant temperature above the user-specified alarm setpoint. This alarm will reset when the reading from the refrigerant temperature sensor drops 2°F (1.1°C) below the user-specified setpoint and the alarm has been acknowledged.

HIGH TEMP SENSOR A—Activated when the reading from Sensor A is above the user-specified alarm setpoint. The alarm will reset when the reading from Sensor A drops 2°F (1.1°C) below the setpoint and the alarm has been acknowledged.

HIGH TEMP SENSOR B—Activated when the reading from Sensor A is above the user-specified alarm setpoint. The alarm will reset when the reading from Sensor A drops 2°F (1.1°C) below the setpoint and the alarm has been acknowledged.

LOSS OF FLOW PUMP 1—Activated when Pump 1 is commanded to run and the differential pressure switch does not sense differential pressure (set at 6 psi; 41kPa; 0.41 bars). After attempting to start Pump 1 three times, the Liebert XDP will automatically switch to the other pump to establish flow. This alarm will reset when flow has been established on Pump 1 and the alarm has been acknowledged.

LOSS OF FLOW PUMP 2—Activated when Pump 2 is commanded to run and the differential pressure switch does not sense differential pressure (set at 6 psi; 41kPa; 0.41 bars). After attempting to start Pump 2 three times, the Liebert XDP will automatically switch to the other pump to establish flow. This alarm will reset when flow has been established on Pump 2 and the alarm has been acknowledged.

LOW MEMORY—Activated when the control board is low in memory resources. This alarm rests automatically as soon as memory consumption falls below the threshold.

LOW REFRIGERANT TEMP—Activated when the supply refrigerant temperature sensor temperature reading drops below the higher of the two calculated dew points, assuming that neither Sensor A or Sensor B has a sensor failure alarm. This alarm will reset when the refrigerant temperature sensor reads the refrigerant temperature above both of the two calculated dew points and the alarm has been acknowledged. This alarm can lock the unit Off. If this occurs, the main power must be cycled, or the Low Refrig Temp Alarm Code in the Service Diagnostics menu must be reset to 0.

LOW TEMP SENSOR A—Activated when the reading from Sensor A drops below the user-specified alarm setpoint. The alarm will reset when the reading from Sensor A rises 2°F (1.1°C) above the setpoint and the alarm has been acknowledged.

LOW TEMP SENSOR B—Activated when the reading from Sensor B drops below the user-specified alarm setpoint. The alarm will reset when the reading from Sensor B rises 2°F (1.1°C) above the setpoint and the alarm has been acknowledged.

NODEX CONDENSATION DETEC—Activated when condensation is detected on a smart module at CAN node ID X, where X is a value ranging from 81 to 100. This alarm resets when condensate is no longer detected. The main power must be cycled off to remove the 4°F (2.2°C) offset value.

NODEX FAN FAILURE—Activated when a fan failure occurs on a smart module at CAN node ID X, where X is a value ranging from 81 to 100. The alarm will rest when the fan returns to normal operation.

NODEX LOCAL SHUT DOWN—Activated when a smart module at CAN node ID X, where X is a value ranging from 81 to 100, has been shut down by an external signal. This alarm will reset when the remote shutdown input is deactivated.

NODEX RETURNAIR TEMPLIMIT—Activated when the return air temperature (entering air temperature to the module) exceeds the user-specified return air temperature range on a smart module at CAN node ID X, where X is a value ranging from 81 to 100. This alarm will reset when the return air temperature return to with the user-specified range.

NODEX SENSOR FAILURE—Activated when a smart module at CAN node ID X, where X is a value ranging from 81 to 100, stops receiving a signal from one or more of its supply air, return air, or refrigerant temperature sensors. This alarm will reset when signals are detected from the module's sensors.

NODEX SUPPLYAIR TEMPLIMIT—Activated when the supply air temperature (temperature of the air leaving the module) exceeds the user-specified supply air temperature range on a smart module at CAN node ID X, where X is a value ranging from 81 to 100. This alarm will reset when the return air temperature return to with the user-specified range.

PUMP SHORT CYCLE—Activated when the Liebert XDP is trying to establish flow (differential pressure) and is unable to do so. The Liebert XDP will attempt three times to establish flow on a pump before trying the other pump. The control will keep cycling three times on one pump, then three times on the other pump until it is able to establish flow (differential pressure). If this cycling occurs for 30 minutes and the Liebert XDP still does not establish flow, a PUMP SHORT CYCLE alarm will be present. This alarm will shut down the Liebert XDP. To reset this alarm, the main power must be cycled.

RAM/BATTERY FAIL—Activated when the RAM backup battery or the RAM itself has failed. This requires a hardware replacement.

SENSOR A FAILURE—Activated when the controls no longer senses a signal from Sensor A. This alarm will reset when the signal is returned and the alarms has been acknowledged.

SENSOR B FAILURE— Activated when the controls no longer senses a signal from Sensor B. This alarm will reset when the signal is returned and the alarm has been acknowledged.

SMOKE DETECTED—Activated when the Customer Input 1 is configured for “Smoke” and 24VAC is applied to the input. This alarm is reset when the 24VAC is removed.

**NOTE**

This is not a room smoke detector and is not intended to replace external smoke detectors.

SUPPLY CW SENSOR FAILURE—Activated when the control no longer senses a signal from the Supply CW sensor. This alarm will reset when the signal is returned.

SUPPLY REFRIGERANT SENSOR FAILURE—Activated when the control no longer senses a signal from the supply refrigerant sensor. This alarm will reset when the signal is returned.

UNIT CODE MISSING—Activated when a valid unit code has not been entered and saved. To reset, enter valid unit code, save and execute.

WATER UNDER FLOOR—Activated when Customer Input 1 is configured for “Water Alarm” and 24VAC is applied to the input. This alarm is reset when the 24VAC is removed.

6.2 Warning Descriptions

LOSS OF POWER—Activated when the unit is On and operational and 24VAC power to the control is lost. This alarm will be emitted when power is restored to the control. The Liebert XDP will restart at a user-defined time delay after power is restored. Once activated, the alarm will remain activated for 30 minutes.

PUMP 1 HRS EXCEED—Activated when the Pump 1 Actual Hours exceeds the user-specified limit. To reset, Actual Hours must be reset to 0.

PUMP 2 HRS EXCEED—Activated when the Pump 2 Actual Hours exceeds the user-specified limit. To reset, Actual Hours must be reset to 0.

6.3 System Shutdown Causes

Unit Is Off By Refrig Sens Fail

The control has lost its signal from the refrigerant temperature sensor. The control has no way of controlling the refrigerant temperature, so the unit is shut off. Main power (disconnect switch) must be turned Off, then back On to clear this alarm.

Unit Is Off By High CW Temp

The entering chilled water temperature is too high to keep the refrigerant pump(s) running normally. If a HIGH CW TEMP alarm occurs and the refrigerant pump loses flow (differential pressure), then the Liebert XDP will go into a pre-chill mode. The Liebert XDP can attempt to start again only if the entering chilled water temperature drops below the HIGH CW TEMP setpoint.

Unit Is Off By Pump Short Cycle

The control was unable to get a pump started upon startup or after a loss of differential pressure. The control looks at the SHORT CYCLE time delay. If it cannot establish differential pressure within that amount of time, the unit is shut down. Main power (disconnect switch) must be turned Off, then back On to clear this alarm.

Unit Is Off By Low Refrig Temp

The control was unable to raise the refrigerant temperature to the calculated refrigerant temperature control point. The unit is shut down because if the control cannot raise the refrigerant temperature to the calculated refrigerant temperature control point, water may condense on the refrigerant piping and receiving coils. Main power (disconnect switch) must be turned Off, then back On to clear this alarm.

7.0 TROUBLESHOOTING

Table 14 Troubleshooting the Liebert XDP

Symptom	Possible Cause	Check or Remedy
Pump Will Not Energize	No main power	Check L1, L2 and L3 for rated voltage.
	Loose electrical connections	Tighten connections.
	Overloads tripped	Allow pump to cool. Check amp draw.
	Tripped circuit breaker	Check circuit breaker to pump(s).
	Incorrect phase wiring	See Table 13 .
Pump Will Not Start or Run	No chilled water	Check and verify that there is supply chilled water to the Liebert XDP.
	Isolation valve(s) on pump suction and/or discharge is closed.	Open all isolation valves completely during normal operation.
	Supply chilled water is too high	Check and verify that the chilled water temperature setpoint is at 50°F (10°C) or lower and that there is flow on the chilled water side.
	Liebert XD cooling modules are Off	Check Liebert XD cooling modules to make sure that they are On prior to starting the Liebert XDP.
	Low Refrigerant Temperature (high dew point)	Check alarm(s) history on Liebert XDP. The Liebert XDP was operating below the dew point for a significant amount of time. Check humidity in conditioned space, lower humidity if necessary to allow Liebert XDP to operate at a lower temperature. (Disconnect must be switched to Off then back On to allow Liebert XDP to reset itself).
	Pressure switch not making contact	Check both differential pressure settings. If not within 6 psi, ±1 psi (41kPa, ±7kPa; 0.41 bars, ±0.07bars) then manually change accordingly.
	Not enough charge	See 5.1 - Checklist for Liebert XDP Startup .
Pump Will Not Start	Chilled water valve not closing completely.	Wait at least 10 minutes before calibrating. Access the Advanced Menu>Factory Settings>Calibrate Actuator. Contact Liebert Services for assistance, 1-800-543-2778.
Pump Noisy	Cavitation due to vapor in pump	Check for adequate charge in system, refer to the User's Manual. 5.1 - Checklist for Liebert XDP Startup
	Worn motor bearings	Replace pump
	Pump is rotating in reverse	See Table 13 .
Liebert XDP (Pump) Suddenly Stops	Low refrigerant temperature	1. Check humidity of the room along with the location of remote sensors. Make sure that the sensors are not in a cold area where there is insufficient air flow for accurate, representative readings. 2. Chilled Water temperature is too cold. 3. Load is too light.
	Loss of power	When power is restored, the Liebert XDP will automatically restart.
	Clogged filter dryer and/or impeller	Clean out debris
	Leak in system - loss of charge	Check the entire system for leaks with a refrigerant sniffer. Repair as necessary.
	Low chilled water temperature alarm and loss of flow Pump X alarm	Check supply chilled water temperature.
	Supply refrigerant sensor failure alarm	Check wiring. Call service.
Clogged Filter Dryer and/or Impeller	Debris or other contaminants in refrigerant	Replace.
Pipe Rattle	Loose pipe connections	Check pipe connections.
Chilled Water Valve Not Working	Motor operates but valve won't open	Check linkage for adjustment and be sure that it is tight on the valve.
	No 24 VAC power to motor	Check for 24 VAC between P52-1 and P52-4.
	No signal from control	Check 24 VAC at P22-1 (close) or P22-3 (open).
	Motor not operating	Unplug P22 from the board. Jumper P22-5 to P52-4 for grounding, then jumper P22-1 to P52-1 to drive close. Remove jumper to close and then jumper P22-3 to P52-1 to drive open. If motor fails to work, replace it.

Table 14 Troubleshooting the Liebert XDP (continued)

Symptom	Possible Cause	Check or Remedy
Motor Burnout	Check control panel for welded contactor contacts or welded overload contacts	Replace defective components.
Main 24VAC Fuse Trips	Shorts or loose connections	Check the wiring connections of the 24 VAC circuit.
	Faulty circuit board	Replace the circuit board.
Unstable Pump Operation	R-134a pump loop overcharged	While pump is running R-134a receiver level must be within recommended levels (see Figure 71).
	R-134a pump loop undercharged	
	Filter dryer clogged	See Clogged Filter Dryer and/or Impeller symptom and remedy.
Room Becomes Too Warm	Liebert XDP is Off	Check status of the Liebert XDP at the user interface. Turn system On at I/O button if system is Off.
	High dew point	Check temperature and relative humidity (RH) of room. Lower RH setpoint if necessary to lower dew point. At normal room temperature of 68°F (20°C), the RH should be set to 50% or lower.
	Liebert XD cooling modules are Off	Check Liebert XD cooling modules to make sure that they are On before starting the Liebert XDP.
	Minimum room temperature setpoint is too high	Check the setpoint in the User Setpoints menu (see Figure 43).
	Temperature/humidity sensors incorrectly placed	Place the sensor on the return air side of the primary air mover (eg., Liebert DS). Do not install the sensor near unsealed doors, windows or similar areas.
Reduced Chilled Water Flow Rate	Clogged strainer	Clean or replace strainer
	Fouled heat exchanger (no strainer installed)	Replace heat exchanger and install 20-40 mesh strainer
Increased Refrigerant Temperature	Clogged strainer	Clean or replace strainer
	Fouled heat exchanger (no strainer installed)	Replace heat exchanger and install 20-40 mesh strainer

8.0 MAINTENANCE

The Liebert XD system components require little maintenance when proper fluid levels are maintained and proper startup and operation procedures are followed. The following tasks should be performed at the intervals stated:

1. Clean or replace chilled water strainer annually. Adjust accordingly based on purity of chilled water.
2. Check sight glass level of receiver every 4-6 weeks. During normal operation, the level should be at or above the second sight glass.
3. Check system for leaks every 4-6 weeks.

8.1 Fluorinated Greenhouse Gas Requirements

Stationary air conditioning, refrigeration, heat pump equipment and stationary fire protection systems in the European Community market and operating with fluorinated greenhouse gases (f-gas), such as R407C, R134a, R410A, must comply with the F-Gas Regulation: (EC) No. 842/2006 (F-gas). The regulation prohibits, among other actions, venting fluorinated greenhouse gases to the atmosphere.

The F-Gas Regulation requires operators to use all measures that are technically feasible and do not entail disproportionate cost to prevent leakage of these gases, to test for leakage regularly and to recover f-gas during equipment service and maintenance and before disposing of equipment.

Refer to the full regulation for additional details.

9.0 SPECIFICATIONS

Table 15 Liebert XDP160 specifications

Models	XDP160RC--4	XDP160RA--4	XDP160RM--4
Cooling Capacity, Nominal	160kW / 46 Tons, 60Hz		140kW / 40 Tons, 50Hz
	Each capacity is based on 45°F (7°C) entering water temperature and 140gpm (530lpm) water flow rate. Capacity is reduced when glycol mixtures are used in place of 100% water.		
Minimum Load	30% of nominal system capacity or 48kW (163,800BTU/H)		
Electrical Requirements			
Input	208V/3ph/60Hz	460V/3/ph60Hz	380/415V/3ph/50Hz
Full Load Amps	4A	2.1A	2.3A
Dimensions, inches (mm)			
Height – Unit only	78 (1981)		
Height – As shipped	83 (2108)		
Width	38 (965)		
Depth	34 (864)		
Weight, lb (kg)			
Unit only	821 (372)		
Shipping weight	Domestic: 990 (449); Export: 1067 (484)		
Installed, with refrigerant and chilled water	1038 (471)		
Pipe Connections			
Refrigerant supply to Liebert XD cooling module	1-1/8" OD, Cu		
Refrigerant return from Liebert XD cooling module	2-1/8" OD, Cu		
Chilled water supply and return	2-5/8" OD, Cu		
Control valve	2-way, 2" nominal; 35 PSIG close-off pressure rating; 150 PSIG maximum allowable pressure		
Pressure Drop – Chilled Water Side	20 psig (137kPa, 1.38bar), with 140 gpm (530lpm) water flow rate, control valve fully open		
Temperature Rise – Chilled Water Side at rated flow, °F (°C)	8.0 (4.4)		6.9 (3.8)
Number of Liebert XD cooling units connected, maximum (minimum)			
Liebert XDCF10	16 (5)		
Liebert XDH20	8 (3)		
Liebert XDH32	5 (2)		
Liebert XDV8	20 (6)		
Liebert XDV10	16 (5)		
Liebert XDO16	10 (3)		
Liebert XDO20	8 (3)		
Liebert XDR20	8 (3)		
Cabinet Exterior Finish	Black, matte finish, heat-fused powder coat		
Operating Ambient Temperature, Maximum, °F (°C)	86 (30)		
Agency			
Approvals	CSA 60Hz		CE 50Hz

COMPLIANCE WITH EUROPEAN UNION DIRECTIVES



Fabbricante – Manufacturer – Hersteller – Fabricant – Fabricante
Fabricante – Tillverkare – Fabrikant – Valmistaja – Produsent
Fabrikant – Κατασκευαστής – Producent

Liebert Corporation
1050 Dearborn Drive
P.O. Box 29186
Columbus, OH 43229
USA

Il Produttore dichiara che, se munito di marchio CE, il prodotto è conforme alle direttive dell'Unione europea:

The Manufacturer hereby declares that this product, when bearing the CE mark, conforms to the European Union directives:

Der Hersteller erklärt hiermit, dass das vorliegende Produkt, sollte es die CE-Kennzeichnung tragen, den folgenden Richtlinien der Europäischen Union entspricht:

Le fabricant déclare par la présente que ce produit, portant la marque CE, est conforme aux directives de l'Union européenne :

El fabricante declara por la presente que si este producto lleva el marcado CE es conforme con las directivas de la Unión Europea:

O fabricante declara por este meio que este produto, quando ostenta a marca CE, está em conformidade com as directivas da União Europeia:

Tillverkaren tillkännager härmed att den här produkten, när den är CE-märkt, överensstämmer med EU:s direktiv:

De fabrikant verklaart hierbij dat dit product, indien het van de CE-markering is voorzien, conform de EU-richtlijnen is:

Valmistaja vakuuttaa täten, että mikäli tuotteessa on CE-merkintä, se täyttää seuraavien EU-direktiivien vaatimukset:

Produsenten erklærer herved at dette produktet, når det er CE-merket, er i samsvar med EU-direktiver:

Producenten erklærer hermed, at dette produkt overholder EU's direktiver, når det bærer CE-mærket:

Ο Κατασκευαστής δηλώνει ότι το προϊόν αυτό, το οποίο φέρει σήμανση CE, είναι σύμμορφο με τις οδηγίες της Ε.Ε.:

2006/42/EC; 2004/108/EC; 2006/95/EC; 97/23/EC

Ensuring The High Availability Of Mission-Critical Data And Applications.

Emerson Network Power, a business of Emerson (NYSE:EMR), is the global leader in enabling *Business-Critical Continuity™* from grid to chip for telecommunication networks, data centers, health care and industrial facilities. Emerson Network Power provides innovative solutions and expertise in areas including AC and DC power and precision cooling systems, embedded computing and power, integrated racks and enclosures, power switching and controls, infrastructure management, and connectivity. All solutions are supported globally by local Emerson Network Power service technicians. Liebert AC power, precision cooling and monitoring products and services from Emerson Network Power deliver Efficiency Without Compromise™ by helping customers optimize their data center infrastructure to reduce costs and deliver high availability.

While every precaution has been taken to ensure the accuracy and completeness of this literature, Liebert Corporation assumes no responsibility and disclaims all liability for damages resulting from use of this information or for any errors or omissions.

© 2008 Liebert Corporation

All rights reserved throughout the world. Specifications subject to change without notice.

® Liebert is a registered trademark of Liebert Corporation.

All names referred to are trademarks or registered trademarks of their respective owners.

SL-16644_REV04_01-12

Technical Support / Service

Web Site

www.liebert.com

Monitoring

liebert.monitoring@emerson.com

800-222-5877

Outside North America: +00800 1155 4499

Single-Phase UPS & Server Cabinets

liebert.upstech@emerson.com

800-222-5877

Outside North America: +00800 1155 4499

Three-Phase UPS & Power Systems

800-543-2378

Outside North America: 614-841-6598

Environmental Systems

800-543-2778

Outside the United States: 614-888-0246

Locations

United States

1050 Dearborn Drive

P.O. Box 29186

Columbus, OH 43229

Europe

Via Leonardo Da Vinci 8

Zona Industriale Tognana

35028 Piove Di Sacco (PD) Italy

+39 049 9719 111

Fax: +39 049 5841 257

Asia

29/F, The Orient Square Building

F. Ortigas Jr. Road, Ortigas Center

Pasig City 1605

Philippines

+63 2 687 6615

Fax: +63 2 730 9572

Emerson Network Power.

The global leader in enabling *Business-Critical Continuity™*

■ AC Power

■ Embedded Computing

■ Outside Plant

EmersonNetworkPower.com

■ Racks & Integrated Cabinets

■ Connectivity

■ Embedded Power

■ Power Switching & Controls

■ Services

■ DC Power

■ Infrastructure Management & Monitoring

■ **Precision Cooling**

■ Surge Protection