



OUTDOOR STORAGE

MODEL N° 60018

*OWNER'S MANUAL*

**COOPY**

Keep this Identification Number in case you must contact our Customer Service Department.

## **IMPORTANT! PLEASE READ BEFORE BEGINNING ASSEMBLY**

Dear Valued Customer,

We would like to congratulate you on your purchase of a Lifetime® Outdoor Storage Shed! We are confident that you have made the perfect choice and you will be very pleased with your new storage solution.

Lifetime® Outdoor Storage is part of the family of products created and manufactured by Lifetime® Products, Inc. Like all of our products, you can be assured that the quality of your Lifetime Outdoor Storage Shed is the best in the world! And, we back that quality up by offering the best warranty in the business – A 10-year warranty that fully covers the Shed!

All of our Sheds are built with the highest-quality steel and high-density polyethylene (HDPE) parts. The design and construction of our steel-reinforced double-Wall Panels is second to none. All of our exposed steel parts and gables are powder coated and we use high-density polyethylene plastic. What makes polyethylene so special? It has superior strength and durability, and, it won't crack or degrade outdoors.

So now that you know the quality you are getting in a Lifetime Outdoor Storage Shed, please take the time to READ THIS INSTRUCTION MANUAL!

We have taken great care in providing the best possible form of instructions to help you put your new Outdoor Storage Shed together. Before you get started, PLEASE read the following preparation tips to help you get started!

We can assure you, your construction experience will be a lot more enjoyable if you do!

### PREPARATION TIPS:

- The first step is simple... RELAX! You have made a great purchase, but Rome was not built in a day. Plan to spend a good part of your weekend putting together your fine Outdoor Storage Shed. Our philosophy is, if it comes together quickly and easily, it surely will come apart quickly and easily! Your Lifetime® Outdoor Storage Shed will surely last a long, long time, if you are patient, and take all the time necessary to put it together as we have instructed.
- Grab a friend to join in on the fun! This is not a one-person endeavor. We have found that not only will things go smoother if you have two or more people participating in the construction of the Shed, but it will go quicker as well. So, the more the merrier!
- Make sure you have all the tools necessary for constructing your new Shed. There is a "Tools Required For This Assembly" list on page five of this Owner's Manual.
- The plastic pieces of your Shed may become damaged by over tightening the screws. To avoid this damage, we strongly recommend the use of a low-powered power screwdriver or a drill that has an adjustable clutch that is set on a low-torque setting. If neither is available, use a hand screwdriver. If a hand screwdriver is all you have, take several breaks... your wrist will need it!
- You will also need two small ladders (when it comes time to do the roof!).

## **IMPORTANT! PLEASE READ BEFORE BEGINNING ASSEMBLY**

- Before beginning assembly, remove the Parts List from the center of this Owner's Manual and take an inventory of the parts included with your Outdoor Storage Shed. Also, read through the entire instruction manual. It's always a great practice to get a feel for the flow of the process and to familiarize yourself with the parts involved. But, try not to get ahead of yourself and start the process out of order.
- FOLLOW THE INSTRUCTIONS IN ORDER! Everything goes together in a certain order, and we have learned what that correct order should be. In our state-of-the-art research and testing facility, we have painstakingly created these instructions. The order of construction is there for a reason, and some parts simply will not fit if built out of order. Just follow along with the order in the instructions and everything will fit together and things will go very smooth.
- YOUR SHED MUST BE BUILT ON A LEVEL SURFACE! If the spot you have chosen to place your wonderful new Outdoor Storage Shed is not level, the Shed will not assemble correctly! We recommend a concrete patio, a wood platform or creating a pad with pea gravel. Your Shed is meant to last a lifetime, so provide the proper foundation for it before you start to build.
- Before you build it, make sure you are allowed to build it! Consult all building codes, as well as city and county ordinances, to ensure that you do not require a building permit to construct your Outdoor Storage Shed. Proper building permit documentation may be required in your neighborhood, and it would be quite unfortunate to learn this after your Outdoor Storage Shed is already built!

Now that you're ready to begin the construction of your wonderful new Outdoor Storage Shed, step back, take a deep breath, get yourself a large cold beverage and enjoy yourself. We guarantee that after spending the right amount of time in building your Shed, you will be able to enjoy it for years to come.

Thanks for choosing Lifetime®, and have fun!

## **ABOUT LIFETIME PRODUCTS, INC.**

Lifetime Products, Inc., has applied innovation and cutting-edge technology in plastics and metals to create a family of affordable lifestyle products that feature superior strength and durability. The world's leading manufacturer of folding tables and chairs, Lifetime was founded in 1986 as the maker of portable basketball systems that revolutionized the industry with patented technology. With diverse offerings such as outdoor storage sheds and steel utility trailers, Lifetime continues to develop innovative products that outfit the way you live.

Lifetime makes the things you need for the lifestyle you want. By innovating products in and around the home, Lifetime simplifies your everyday life and enables you to get the most out of your free time.



## REGISTER YOUR LIFETIME PRODUCT TODAY!

There are benefits to registering your Lifetime product. With our new online product registration form, it's fast and easy! Register with us at [www.lifetime.com](http://www.lifetime.com) and enjoy these great benefits:

- Receive exclusive money-saving offers from BuyLifetime.com, our online store, as well as NEW product notifications and special closeout promotions!
- In the unlikely event of a product recall or safety modification, we will notify you.
- Registering your product guarantees you warranty service. If you do not register your product, your warranty rights will not be diminished. But you will need to provide a sales receipt to verify your product purchase date before warranty service will be provided.

### LIFETIME'S PROMISE TO YOU:

*Maintaining your privacy is our long-standing policy at Lifetime. And you can rest assured that Lifetime will not sell or provide your personal data to other third parties, or allow them to use your personal data for their own purposes.*

We invite you to read our privacy policy at [www.lifetime.com](http://www.lifetime.com)

**REGISTER today!**

**\*\*U.S. and Canada customers ONLY\*\***

IF ASSISTANCE IS NEEDED,

**DO NOT CONTACT THE STORE!**

**CALL OUR CUSTOMER SERVICE DEPARTMENT at 1 (800) 225-3865**

HOURS: 7:00 a.m. to 5:00 p.m. Monday through Friday (Mountain Standard Time)

\*\*Call, or visit our Web site for Saturday hours\*\*

\*\*For customers outside the U.S. or Canada, please contact the store for assistance.\*\*



## SAFETY INSTRUCTIONS



### FAILURE TO FOLLOW THESE WARNINGS MAY RESULT IN SERIOUS INJURY OR PROPERTY DAMAGE AND WILL VOID WARRANTY.

To ensure safety, do not attempt to assemble this product without following the instructions carefully. Check entire box and inside all packing material for parts and/or additional instruction material. Before beginning assembly, read the instructions and identify parts using the hardware identifier and parts list in this document. Proper and complete assembly, use and supervision are essential to reduce the risk of accident or injury.

- Do not use or store hot objects such as grills, blowtorches, welding equipment, etc. near the product.
- If using a ladder during assembly, use extreme caution.
- Two capable adults are required for assembly. (It is also recommended that a third adult function as an instruction reader.)

*Most injuries are caused by misuse and/or not following instructions. Use caution when using this product.*



## BEFORE BEGINNING ASSEMBLY



Keep the hardware bags and their contents separate. If any parts are missing, call our Customer Service Department.

Read the “Congratulations” letter on page 2-3. Identify and inventory all parts and hardware using the parts and hardware lists and identifiers in this document.



***\*Two adults required to complete assembly\****

**Only adults should set up the product. Do not allow children in the set-up area until assembly is complete.**



## TOOLS REQUIRED FOR THIS ASSEMBLY

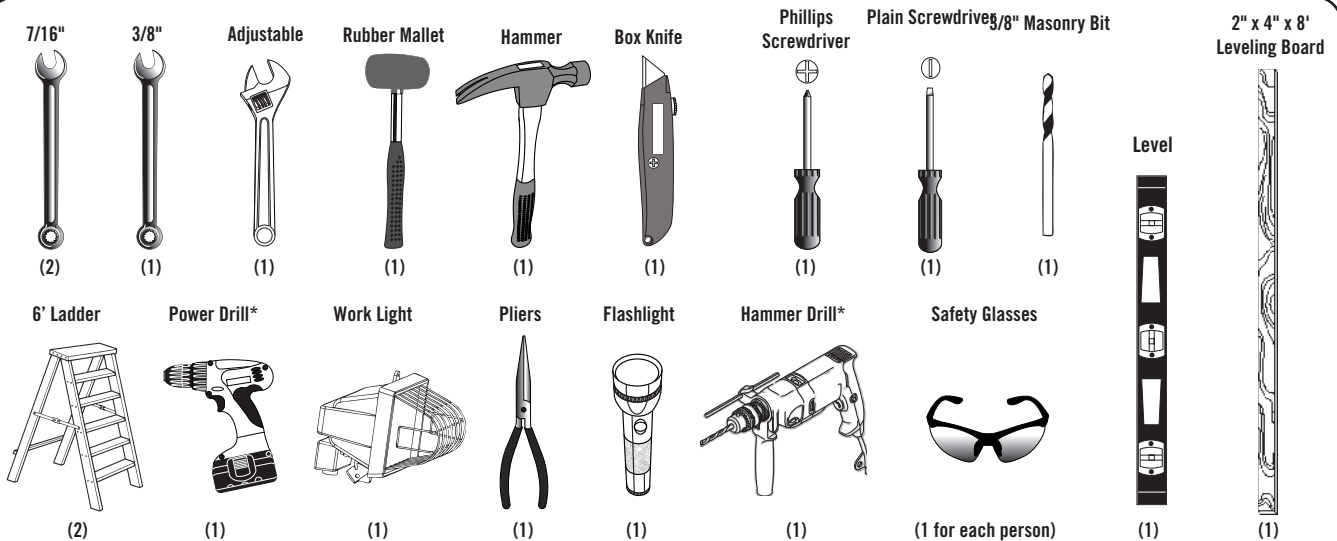

\*See “Screwdriver Notice” on page 7.

## ASSEMBLY GUIDES

*Refer to the following areas throughout the instructions to assist in the assembly process:*

This area is located at the top, left-hand corner of the page and indicates which tools and hardware are needed to complete the assembly steps on a page.



TOOLS AND HARDWARE REQUIRED FOR THIS PAGE

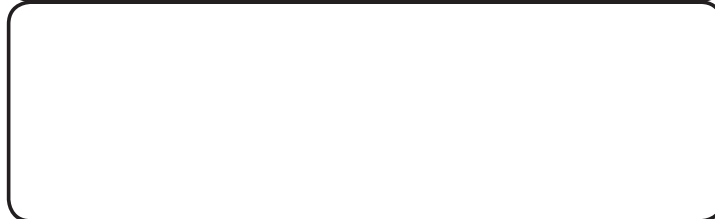

This area is located at the top, right-hand corner of the page and shows an image of the product with shaded parts indicating which section is being assembled.

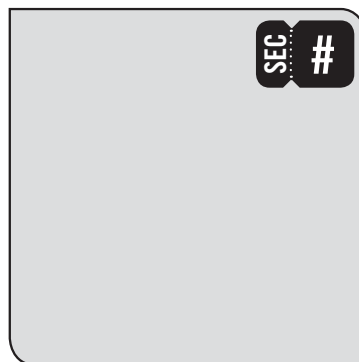

This area is usually located in the bottom, left-hand corner of a step and indicates that special attention is needed to perform a particular part of a step.



Note:

These areas are usually located in the bottom, right-hand corner of a step and indicate that damage to the product or serious injury may occur if the caution or warning is not heeded.



**CAUTION**



**WARNING**

Throughout the Parts & Hardware List, Part & Hardware Identifiers, and instructions are three-letter IDs. These IDs are below the images of the parts and hardware to help you locate and identify the parts and hardware during assembly. These IDs are not necessarily on the parts themselves.

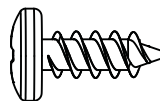

ADZ (x10)  
1/4" x 5/8" Pan-Head Screw

## IMPORTANT NOTICES

### Level Surface Notice:

Surface must be leveled before installation. We recommend building a level work space with a concrete or patio style surface. If the surface is not properly leveled, the Outdoor Shed will not assemble correctly. Proper surface leveling will save you time in the long run, so please do not ignore this step.

---

### Building Code Notice:

Consult all local building codes, as well as city and county ordinances, to ensure that the construction of the Outdoor Shed does not require a building permit. Proper building permit documentation may be required in your neighborhood, and it would be unfortunate to learn this after constructing the Shed.

---

### Screwdriver Notice:

You may use a #2 Phillips head screwdriver bit and a power screwdriver or drill, instead of a hand screwdriver. However, be aware that the plastic pieces of your Shed can be damaged by overtightening of screws. To avoid damage we strongly recommend the use of a low-powered power screwdriver or a drill that has an adjustable clutch that is set on a low torque setting. If neither is available, use a hand screwdriver. In any case use caution to avoid overtightening the screws.

---

### Floor Puncture Notice:

Sharp objects may damage your floor. If resting sharp, heavy objects on your Shed floor, place a block of wood between the sharp object and floor.



### CAUTION:

If more than six (6) inches of snow accumulate on the roof of the shed, carefully remove the snow to avoid possible roof collapse. While standing on the ground, remove the snow from the roof with a broom or snow shovel. Do not stand on the roof to remove snow.

# PARTS & HARDWARE LIST

## BOX 1

### SHED PARTS BOX

ID	Description	Qty
AGZ	Right Door	1
AGO	Left Door	1
AGF	Entry Gable	1
AGH	Rear Gable 1	1
AGI	Rear Gable 2	1
AGR	Outer Floor Panel	2
AFX	Center Floor Panel	2
AFV	90" Shelf	1
AGQ	Roof Panel	8

### CTI METAL PARTS KIT 1

AFH	Truss Gutter Channel	2
AFG	Roof Truss Brace	3
AFM	Wall/Shelf Support Channel	2
AFC	Door End Channel	2
AFE	Entry Header Bar	1
CRD	Door Hinge Tube	2

### CTF METAL PARTS KIT 2

AFH	Truss Gutter Channel	4
-----	----------------------	---

## BOX 2

### SHED PARTS BOX

AGY	Corner Wall Panel 104	1
AGN	Corner Wall Panel 105	1
AGW	Corner Wall Panel 106	1
AGL	Corner Wall Panel 107	1
AHD	Wall Panel	7
AHH	Window Wall Panel	1
AFY	Center Roof Cap	3

### BDX SMALL PARTS KIT

AFZ	Corner Shelf	6
AHC	Skylight	4
AFL	Roof Support Strip	8
AHE	Window	1
AGG	Front Roof Cap	1
AFW	Rear Roof Cap	1
AYJ	Battery-Powered Light	1

### BSI SMALL PARTS BOX

AIX	Wood Shim	4
AIW	Wood Block	1
AFU	Pegboard Strip	2
AYJ	Battery-Powered Light	1

### BQH FLOOR ASSEMBLY HARDWARE

BQC	#8 x 1/2" Pan-Head Screw	20
AHO	Door Hinge Bushing	2
ADC	#2 Phillips Bit	1

### BEA TRUSS FRAME ASSEMBLY HARDWARE (x3)

ADJ	1/4" Cap Nut	2
ADY	#10 x 3/8" Pan-Head Screw	6
ADK	#10 Cap Nut	6
AIP	Truss Connector	1
ADH	1/4" Threaded Rod	1

### BHY WALL INSTALLATION HARDWARE

ADZ	1/4" x 5/8" Pan-Head Screw	58
-----	----------------------------	----

### SHelf INSTALLATION HARDWARE

<b>BHI Corner Shelf Installation Hardware (x6)</b>		
ADZ	1/4" x 5/8" Pan-Head Screw	4
<b>BHH 90" Shelf Installation Hardware</b>		
ADZ	1/4" x 5/8" Pan-Head Screw	14
AIY	Shelf Support Bracket	2

ID	Description	Qty
<b>BHC PEGBOARD STRIP INSTALLATION HARDWARE</b>		
ADW	#10 x 3/4" Pan-Head Screw	10
<b>BHD Tool Clip Assortment</b>		
AIF	2" Double-Arm Hook	1
AIG	4" Double-Arm Hook	1
AIH	J-Hook	3
AIL	L-Hook	3
AIJ	Toolholder	2
<b>BHV GABLE ASSEMBLY HARDWARE (x2)</b>		
AGP	Louvered Vent	1
AIQ	Vent Screen	1
ADW	#10 x 3/4" Pan-Head Screw	5
AEE	#10 x 1/2" Flat Washer	5
ADZ	1/4" x 5/8" Pan-Head Screw	4
AHS	3/4" End Plug	2
ADV	1/4" x 1 1/8" Pan-Head Screw	6
ACB	#10 x 1 1/8" Pan-Head Screw (Not used)	1
<b>BEF LEFT DOOR ASSEMBLY HARDWARE</b>		
AHZ	Left Door Handle	1
AHM	Deadbolt Latch	2
ABU	1/4" x 1 1/2" Carriage Bolt	2
ADW	#10 x 3/4" Pan-Head Screw	3
AEE	#10 x 1/2 Flat Washer	3
ADJ	1/4" Cap Nut	2
AIA	Left Door Lock Bracket	1
AIB	Left Door Strike Plate	1
<b>BEG RIGHT DOOR ASSEMBLY HARDWARE</b>		
AIK	Right Door Handle	1
ABV	1/4" x 2" Carriage Bolt	2
ADB	3/8" x 1/2" Steel Spacer	2
AAB	1/4" Centerlock Nut	2
AHY	Latch Spring	1
AHW	Latch Block	1
AIO	Thumb Lever	1
ADW	#10 x 3/4" Pan-Head Screw	4
AHX	Latch Cover Plate	1
AHV	Latch, Door	1
AIL	Right Door Lock Bracket	1
AEB	1/4" Flat Washer	2
AEE	#10 x 1/2" Flat Washer	5
<b>BHZ DOOR &amp; ENTRY GABLE INSTALLATION HARDWARE</b>		
ADZ	1/4" x 5/8" Pan-Head Screw	6
AHP	Cotter Pin	2
AIC	Left Gap Flap	1
AIM	Right Gap Flap	1
ADX	#10 x 1/2" Pan-Head Screw	4
<b>BHX TRUSS, REAR GABLE, &amp; ROOF INSTALLATION HARDWARE</b>		
ADZ	1/4" x 5/8" Pan-Head Screw	126
AED	#10-1" Fender Washer	24
ADX	#10 x 1/2" Pan-Head Screw	24
AXX	Truss Hole Insert	2
<b>BEJ WINDOW INSTALLATION HARDWARE</b>		
ADZ	1/4" x 5/8" Pan-Head Screw	4
AIS	Window Latch Bracket	2
ADY	#10 x 3/8" Pan-Head Screw	1
<b>BHB BATTERY-POWERED LIGHT INSTALLATION HARDWARE (x2)</b>		
ADZ	1/4" X 5/8" Pan-Head Screw	3

# PARTS IDENTIFIER

## BOX 1

### SHED PARTS BOX

Parts shown at 4% of actual size

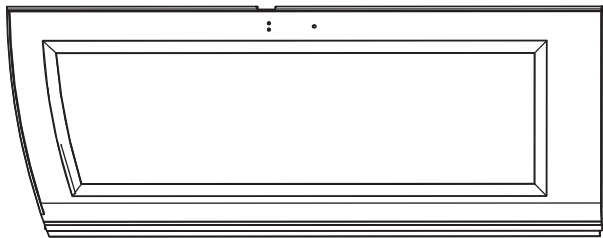

**AGO (x1)**  
Left Door

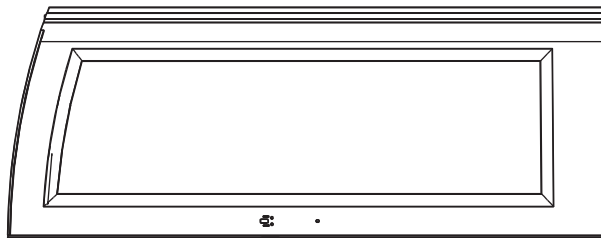

**AGZ (x1)**  
Right Door

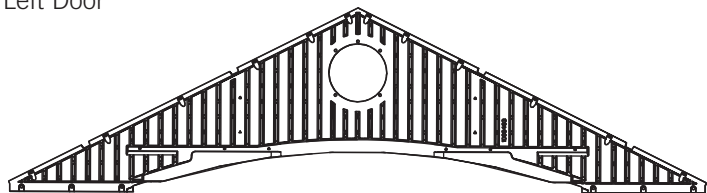

**AGF (x1)**  
Entry Gable

(Rear View)

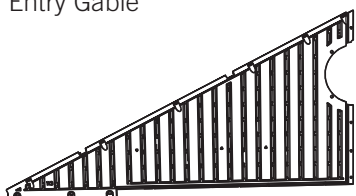

**AGH (x1)**  
Rear Gable 1

(Rear View)

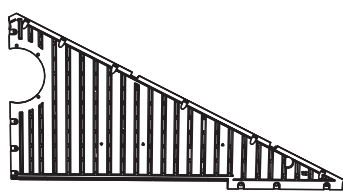

**AGI (x1)**  
Rear Gable 2

(Rear View)



**AFV (x1)**  
90" Shelf

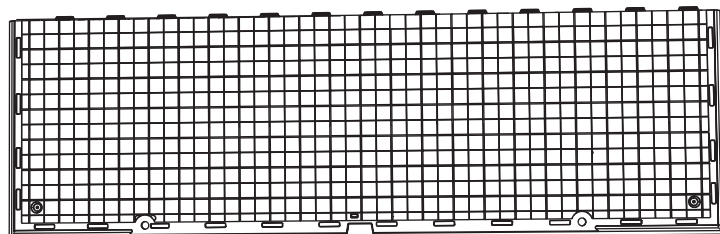

**AGR (x2)**  
Outer Floor Panel

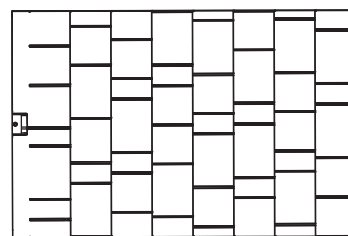

**AGQ (x8)**  
Roof Panel

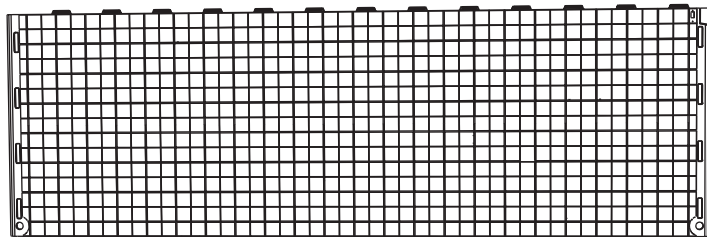

**AFX (x2)**  
Center Floor Panel



*Note: Throughout the Parts & Hardware List, Part & Hardware Identifiers, and instructions are three-letter IDs. These IDs are below the images of the parts and hardware to help you locate and identify the parts and hardware during assembly. These IDs are not necessarily on the parts themselves.*

# PARTS IDENTIFIER

## BOX 1

### METAL PARTS KIT [CTI]

Parts shown at 8% of actual size

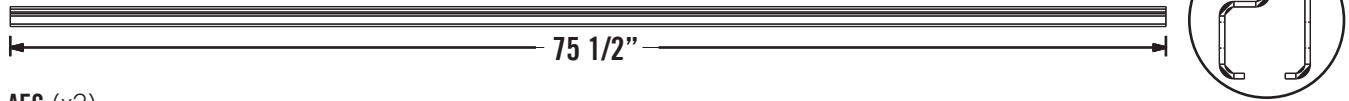

**AFC** (x2)  
Door End Channel

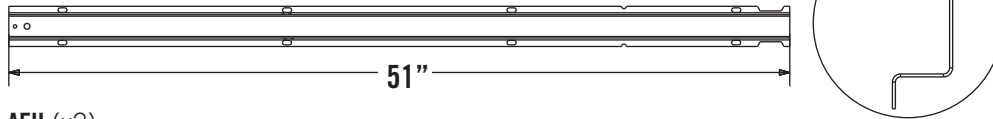

**AFH** (x2)  
Truss Gutter Channel

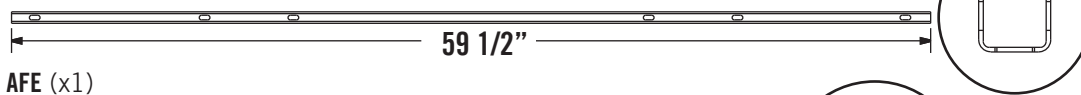

**AFE** (x1)  
Entry Header Bar

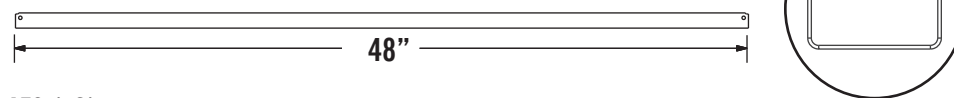

**AFG** (x3)  
Roof Truss Brace

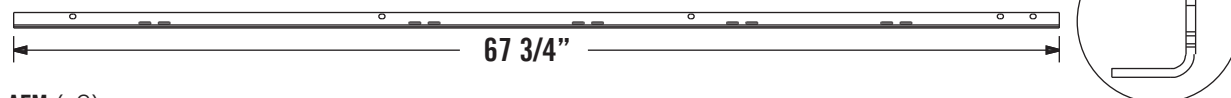

**AFM** (x2)  
Wall/Shelf Support Channel

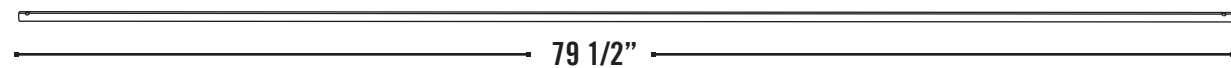

**CRD** (x2)  
Door Hinge Tube

### METAL PARTS KIT [CTF]

Parts shown at 8% of actual size

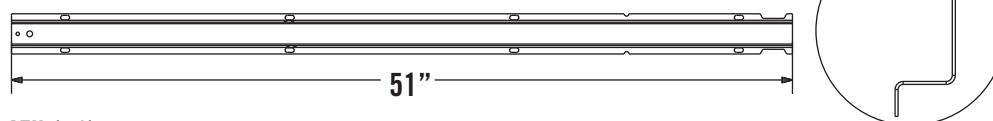

**AFH** (x4)  
Truss Gutter Channel

# PARTS IDENTIFIER

## BOX 2

### SHED PARTS BOX

Parts shown at 4% of actual size

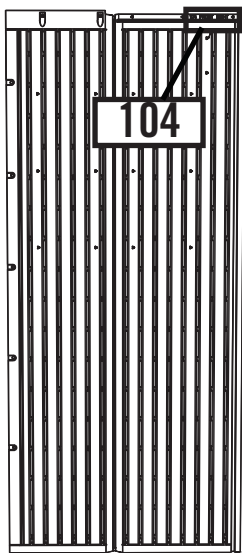

**AGY (x1)**  
Corner Wall Panel 104

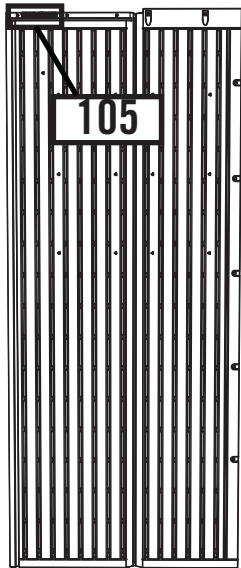

**AGN (x1)**  
Corner Wall Panel 105

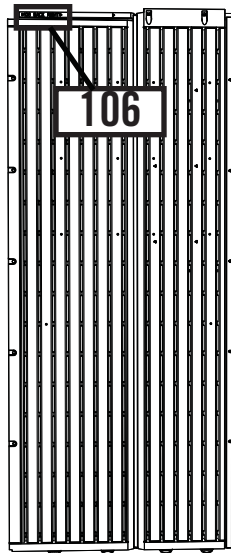

**AGW (x1)**  
Corner Wall Panel 106

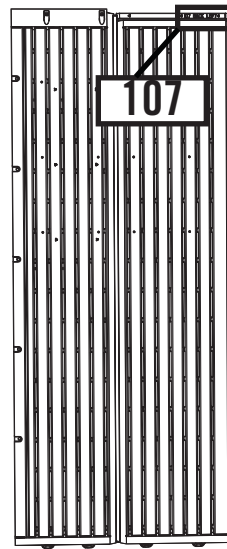

**AGL (x1)**  
Corner Wall Panel 107

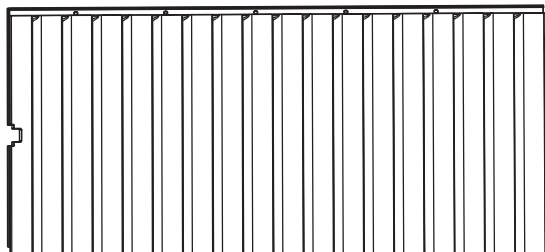

**AHD (x7)**  
Wall Panel

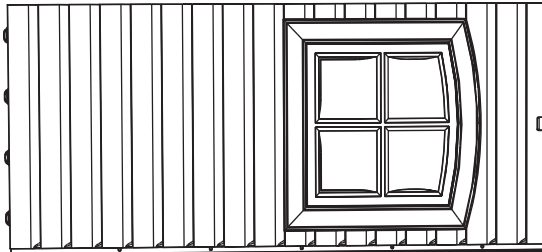

**AHH (x1)**  
Window Wall Panel

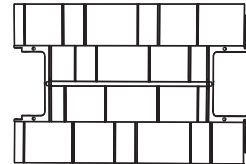

**AFY (x3)**  
Center Roof Cap

### SMALL PARTS KIT [BDX]

Parts shown at 8% of actual size

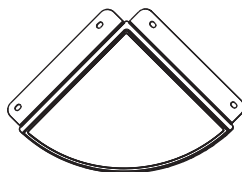

**AFZ (x6)**  
Corner Shelf

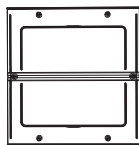

**AHC (x4)**  
Skylight

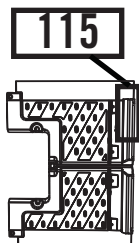

**AGG (x1)**  
Front Roof Cap

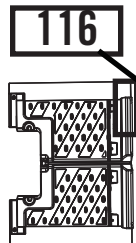

**AFW (x1)**  
Rear Roof Cap

### SMALL PARTS BOX [BIA]

Parts are not shown to scale



**AIW (x1)**  
Wood Block



**AIX (x4)**  
Wood Shim

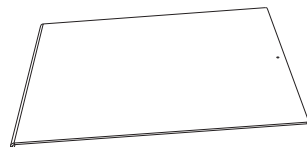

**AHE (x1)**  
Window



**AFL (x8)**  
Roof Support Strip



**AYJ (x1)**  
Battery-Powered Light

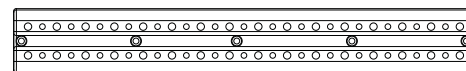

**AFU (x2)**  
Pegboard Strip



**AYJ (x1)**  
Battery-Powered Light



## PARTS & HARDWARE IDENTIFIER

### BOX 2 (CONT.)

#### FLOOR ASSEMBLY HARDWARE [BQH]

Hardware shown at actual size

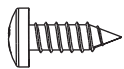

**BQC** (x20)  
#8 x 1/2" Pan-Head Screw  
(Only 12 used)

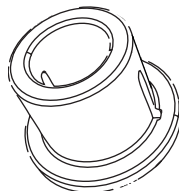

**AHO** (x2)  
Door Hinge Bushing



**ADC** (x1)  
#2 Phillips Bit

#### TRUSS FRAME ASSEMBLY HARDWARE [BEA] x3

Parts shown to scale (\*Unless otherwise noted)



**ADJ** (x2)  
1/4" Cap Nut



**ADK** (x6)  
#10 Cap Nut

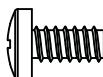

**ADY** (x6)  
#10 Pan-Head Screw



**\*AIP** (x1)  
Truss Connector

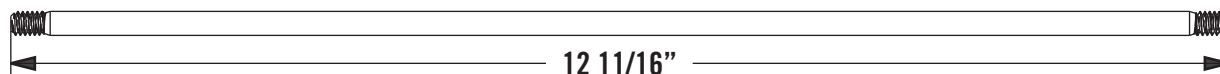

**\*ADH** (x1)  
1/4" Threaded Rod

#### WALL INSTALLATION HARDWARE [BHY]

Parts shown to scale (\*Unless otherwise noted)

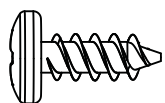

**ADZ** (x58)  
1/4" x 5/8" Pan-Head Screw

#### SHELF INSTALLATION HARDWARE

Parts shown to scale (\*Unless otherwise noted)

##### Corner Shelf Installation Hardware [BHI] x6

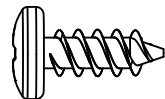

**ADZ** (x4)  
1/4" x 5/8" Pan-Head Screw

##### 90" Long Shelf Installation Hardware [BHH]

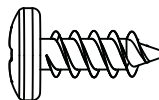

**ADZ** (x14)  
1/4" x 5/8" Pan-Head Screw



**\*AIY** (x2)  
Shelf Support Bracket

## PARTS & HARDWARE IDENTIFIER

### BOX 2 (CONT.)

#### GABLE ASSEMBLY HARDWARE [BHV] x2

Parts shown to scale (\*Unless otherwise noted)

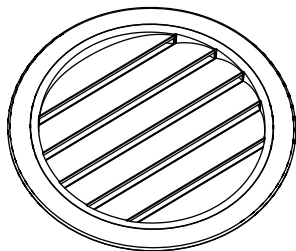

**\*AGP** (x1)  
Louvered Vent

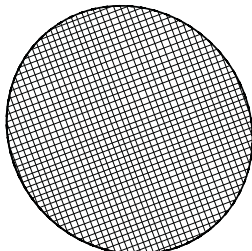

**\*AIQ** (x1)  
Vent Screen

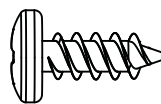

**ADZ** (x4)  
1/4" x 5/8" Pan-Head Screw  
(Only 4 used)

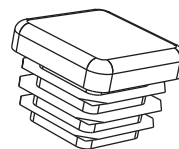

**AHS** (x2)  
3/4" End Plug  
(Only 2 used)

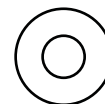

**AEE** (x5)  
#10 x 1/2"  
Flat Washer

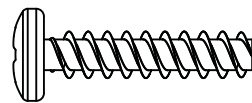

**ADV** (x6)  
1/4" x 1 1/8" Pan-Head Screw  
(Only 6 used)



**ADW** (x5)  
#10 x 3/4" Pan-Head Screw

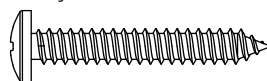

**ACB** (x1)  
#10 x 1 1/8" Pan-Head Screw  
(Not used in this model)

### LEFT DOOR ASSEMBLY HARDWARE [BEF]

Parts shown to scale (\*Unless otherwise noted)

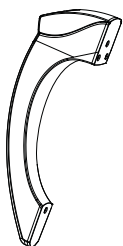

**\*AHZ** (x1)  
Left Door Handle

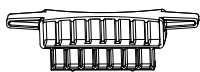

**\*AHM** (x2)  
Deadbolt Latch

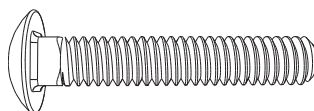

**ABU** (x2)  
1/4" x 1 1/2" Carriage Bolt

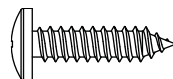

**ADW** (x3)  
#10 x 3/4" Pan-Head Screw

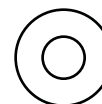

**AEE** (x3)  
#10 x 1/2" Flat Washer



**ADJ** (x2)  
1/4" Cap Nut



**\*AIA** (x1)  
Left Door Lock Bracket

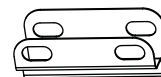

**\*AIB** (x1)  
Left Door Strike Plate

### RIGHT DOOR ASSEMBLY HARDWARE [BEG]

Parts shown to scale (\*Unless otherwise noted)

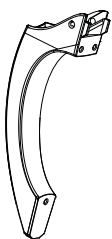

**\*AIK** (x1)  
Right Door Handle

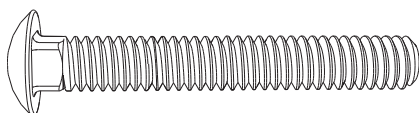

**ABV** (x2)  
1/4" x 2" Carriage Bolt

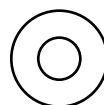

**AEE** (x5)  
#10 x 1/2" Flat Washer  
(Only 3 used)



**ADB** (x2)  
3/8" x 1/2" Steel Spacer

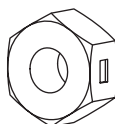

**AAB** (x2)  
1/4" Centerlock Nut

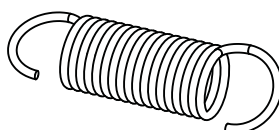

**AHY** (x1)  
Latch Spring

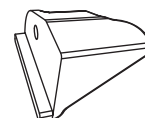

**\*AHW** (x1)  
Latch Block

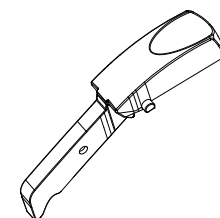

**\*AIO** (x1)  
Thumb Lever

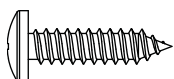

**ADW** (x4)  
#10 x 3/4" Pan-Head Screw

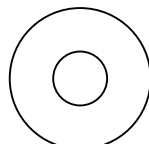

**AEB** (x2)  
1/4" Flat Washer



**\*AHX** (x1)  
Latch Cover Plate

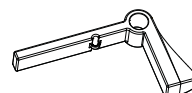

**\*AHV** (x1)  
Door Latch

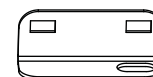

**\*AIL** (x1)  
Right Door Lock Bracket

## PARTS & HARDWARE IDENTIFIER

### BOX 2 (CONT.)

#### DOOR & FRONT GABLE INSTALLATION HARDWARE [BHZ]

Parts shown to scale (\*Unless otherwise noted)

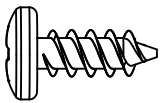

**ADZ** (x6)  
1/4" x 5/8" Pan-Head Screw

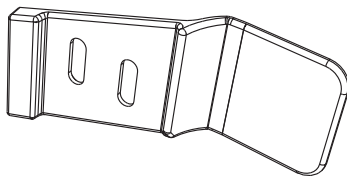

**\*AIC** (x1)  
Left Gap Flap

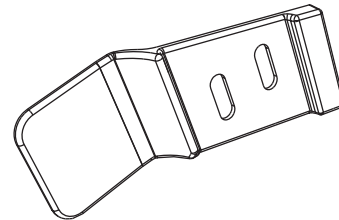

**\*AIM** (x1)  
Right Gap Flap



**AHP** (x2)  
Cotter Pin

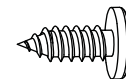

**ADX** (x4)  
#10 x 1/2" Pan-Head Screw

---

#### TRUSS, REAR GABLE, & ROOF INSTALLATION HARDWARE [BHX]

Parts shown to scale (\*Unless otherwise noted)

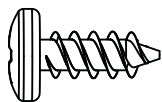

**ADZ** (x126)  
1/4" x 5/8" Pan-Head Screw

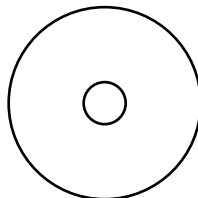

**AED** (x24)  
#10 x 1" Fender Washer

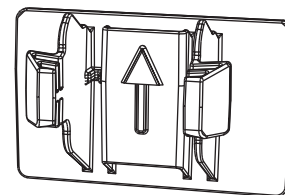

**\*AXX** (x2)  
Truss Hole Insert

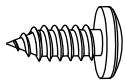

**ADX** (x24)  
#10 x 1/2" Pan-Head Screw

---

#### WINDOW INSTALLATION HARDWARE [BEJ]

Parts shown to scale (\*Unless otherwise noted)

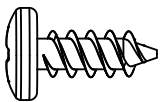

**ADZ** (x4)  
1/4" x 5/8" Pan-Head Screw

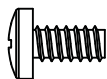

**ADY** (x1)  
#10 x 3/8" Pan-Head Screw

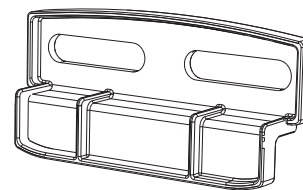

**\*AIS** (x2)  
Window Latch

---

#### BATTERY-POWERED LIGHT INSTALLATION HARDWARE [BHB] (x2)

Hardware shown at actual size

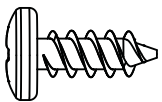

**ADZ** (x3)  
1/4" x 5/8" Pan-Head Screw  
(Only 2 screws are used)

# PARTS & HARDWARE IDENTIFIER

## BOX 2 (CONT.)

### PEGBOARD STRIP INSTALLATION HARDWARE [BHC]

Hardware shown at actual size

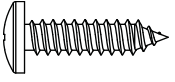

**ADW** (x10)  
#10" x 3/4" Pan-Head Screw

---

### Tool Clip Assortment [BHD]

Hardware shown at 50% of actual size

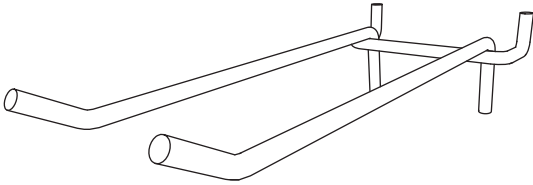

**AIG** (x1)  
4" Double-Arm Hook

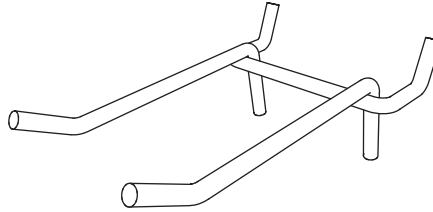

**AIF** (x1)  
2" Double-Arm Hook

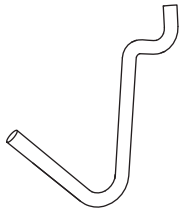

**AIH** (x3)  
J-Hook

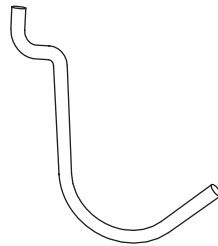

**AII** (x3)  
L-Hook

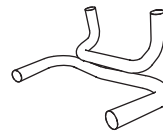

**AIJ** (x2)  
Toolholder



## TOOLS AND HARDWARE REQUIRED FOR THIS PAGE



Concrete (1 cu. yd.)

SEC 1

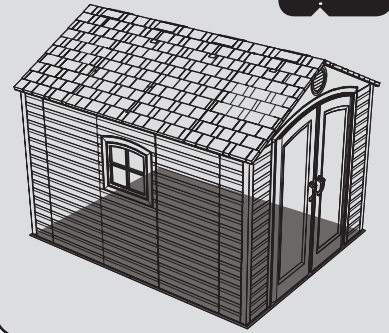

SEC

1.1

### SITE PREPARATION - CONCRETE PLATFORM PREPARATION

The actual dimensions of your shed (at its widest and longest points) are 8' x 10'. Ensure you select a site that will accommodate these measurements. The base of the shed is slightly smaller than this, so you will need to create a level surface that is at least 93 1/2" x 118 1/4". We recommend using a level cement or patio style surface. This will provide the best long-term performance for your shed.



*Note: Shed Extension Kits are available for this shed. Please consider possible shed expansion when planning the site for your shed. See back cover of this manual for information on ordering accessories.*

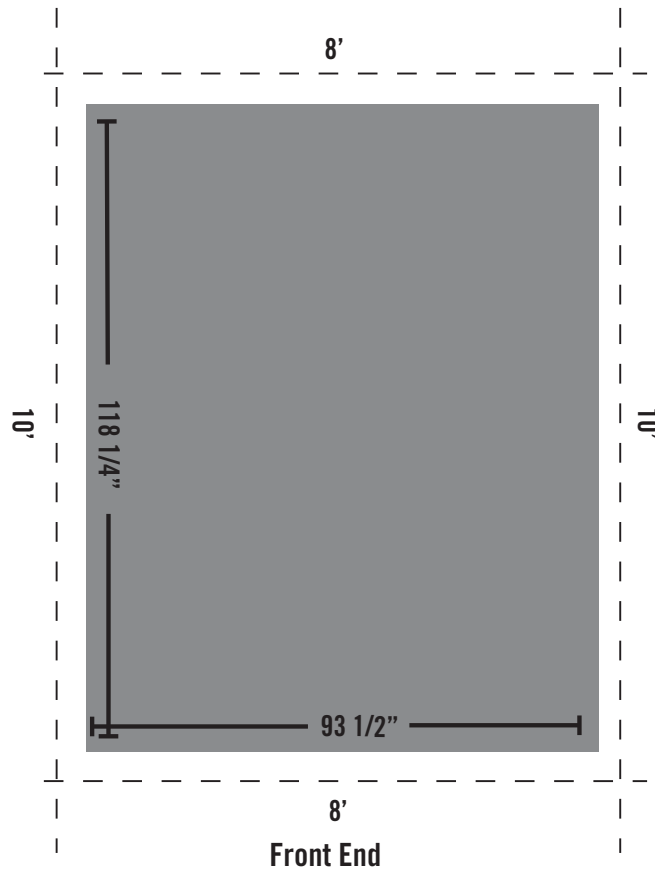

*Note: Surface must be leveled before installation. If the surface is not properly leveled, the Outdoor Shed will not assemble or function correctly. Proper surface leveling will save you time in the long run, so please do not ignore this step.*



*Note: Any platform or similar structure should be built above ground in order to avoid water pooling inside the Shed.*



## TOOLS AND HARDWARE REQUIRED FOR THIS PAGE



2" x 4" x 118 1/4" (x2) (Not included)

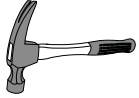

2" x 4" x 90 1/2" (x9) (Not included)

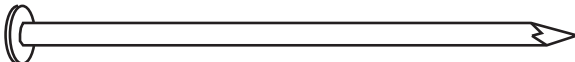

16d 3" Common Nail (x32) (Not included)

SEC 1

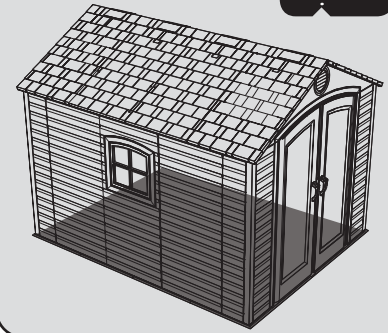

SEC

1.2

### ALTERNATIVE SITE PREPARATION: OPTION 1 - WOOD PLATFORM ASSEMBLY

Ensure all lumber used is treated and approved for outdoor use. Build outside frame to 93 1/2" x 118 1/4" outside dimensions:



*Note: Whenever possible, you should use the surfaces described on Page 7. When this is not possible, we recommend you use a wood platform or a filled wood frame.*

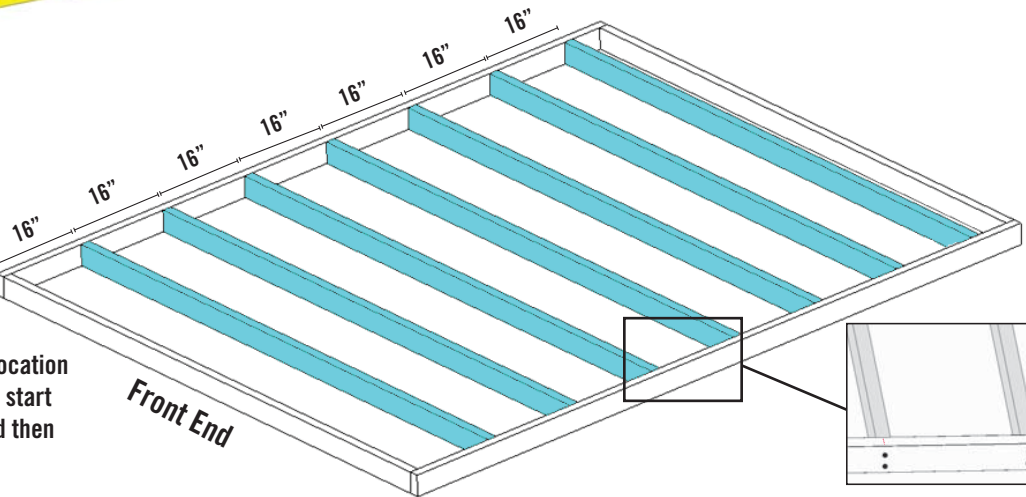
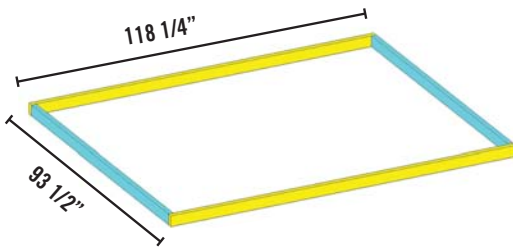

To ensure studs are in the correct location for nailing plywood in the next step, start measuring from the corner 16", and then measure from center to center.

Place the 2" x 4" x 90 1/2" boards on the inside of the frame. Nail each board in place with the 16d nails.



*Note: All lumber must be rated for outdoor use.*



*Note: Surface must be leveled before installation. If the surface is not properly leveled, the Outdoor Shed will not assemble or function correctly. Proper surface leveling will save you time in the long run, so please do not ignore this step.*



## TOOLS AND HARDWARE REQUIRED FOR THIS PAGE

SEC 1

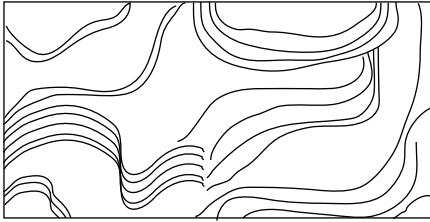

48" x 93 1/2" x 3/4" Treated Plywood (x2)  
(Not included)



22 1/4" x 93 1/2" x 3/4" Treated Plywood (x1)  
(Not included)

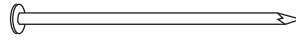

8d 1 1/2" Common Nail (x36)  
(Not included)

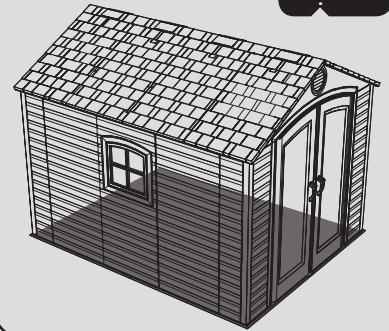

SEC

1.3

### ALTERNATIVE SITE PREPARATION: OPTION 1 - WOOD PLATFORM ASSEMBLY (CONT)

Square up the frame by measuring from corner to corner. Measurement A should equal Measurement B.

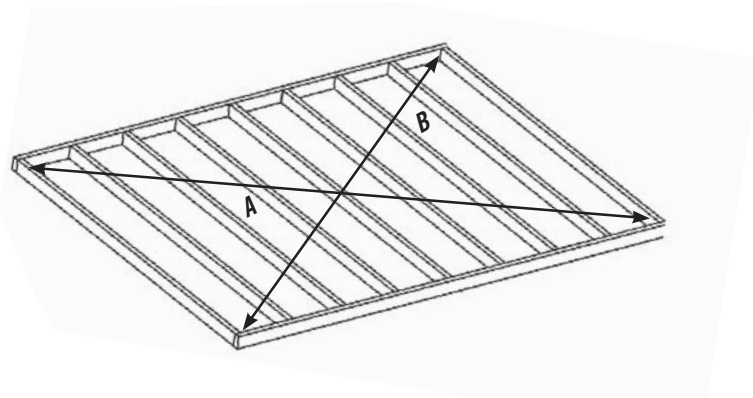

Note: All lumber must be rated for outdoor use.

SEC

1.4

Cut Plywood into sizes called for on previous page. Arrange the Plywood according to the diagram and nail into place with 8d x 1 1/2" nails. Place platform in the desired location. If platform does not rest level on the ground, build up low points with loose dirt until platform is stable. Drill three evenly spaced 1/2" drain holes in plywood between each 2" x 4" joist.

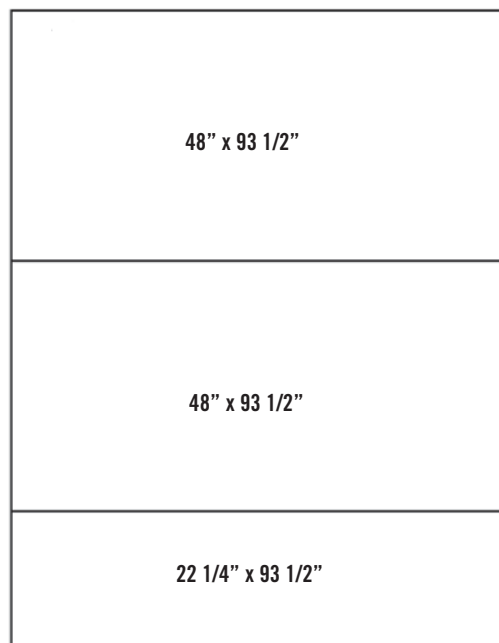

Front End





## TOOLS AND HARDWARE REQUIRED FOR THIS PAGE

SEC 1

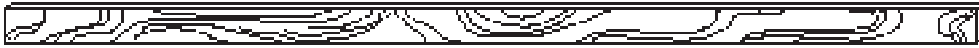

2" x 4" x 120" (x2) (Not included)

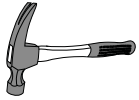

2" x 6" x 89" (x2) (Not included)



8d 1 1/2" Common Nail (x16)  
(Not included)



Pea Gravel (9.8 Cubic Feet)  
(Not included)

L-Bracket (x4)  
(Not included)

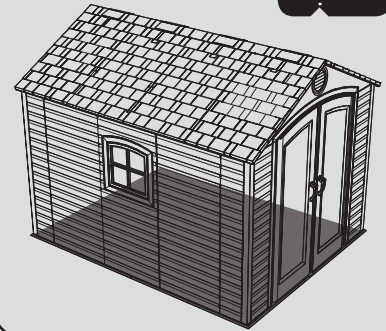

### ALTERNATIVE SITE PREPARATION: OPTION 2 - FILLED WOOD FRAME ASSEMBLY

SEC

1.5

Cut outside frame to 8' x 10' outside dimensions. Lay boards flat so widest parts face up. Ensure frame is level. Square up the frame by measuring from corner to corner. Measurement A should equal Measurement B. Nail an L-Bracket on each corner of the frame with 8d nails. Place platform in the desired location. If platform does not rest level on the ground, build up low points with loose dirt or "Pea" gravel, until platform is stable.



*Note: Whenever possible you should use the surfaces described on Page 7.*



*Note: All lumber must be rated for outdoor use.*

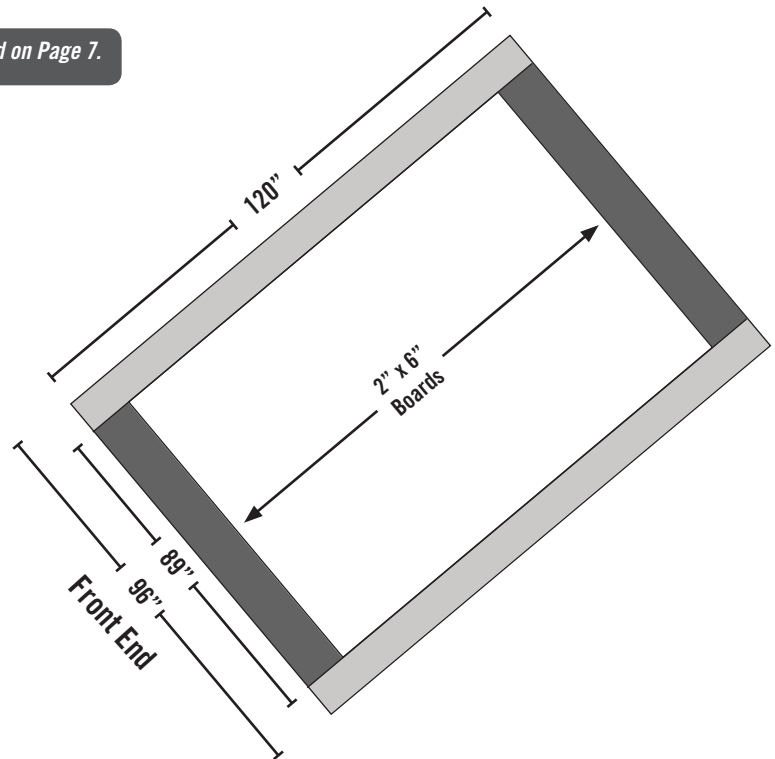
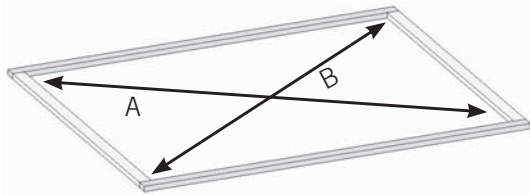

SEC

1.6

Once all boards are level and do not wobble, pack "Pea" gravel around the outside of the frame, and slope away from frame.

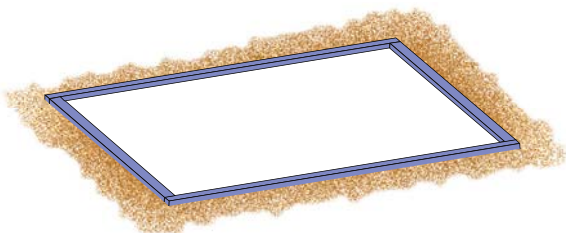

SEC

1.7

Now fill the inside of the frame with "Pea" gravel. Use a leveling board to scrape off extra fill material and to level the surface.

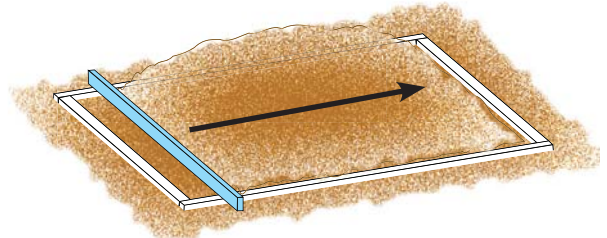

2" x 4" x 8' Leveling Board (x1)

## SEC 2 FLOOR ASSEMBLY

### HARDWARE REQUIRED

**HARDWARE BAG REQUIRED: BQH**

Hardware shown at actual size

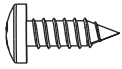

**BQC** (x20)  
#8 x 1/2" Pan-Head Screw  
(Only 12 used)

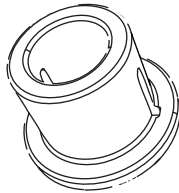

**AHO** (x2)  
Door Hinge Bushing



**ADC** (x1)  
#2 Phillips Bit

### PLASTIC PARTS REQUIRED

**LOCATED IN BOX 1**

Parts shown at 4% of actual size

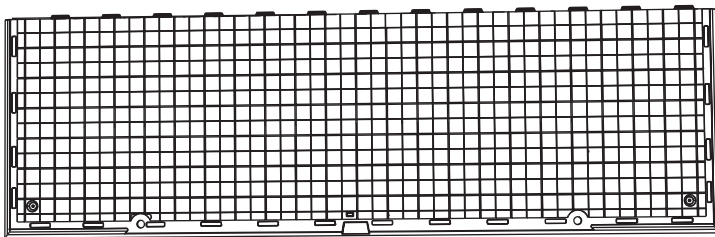

**AGR** (x2)  
Outer Floor Panel

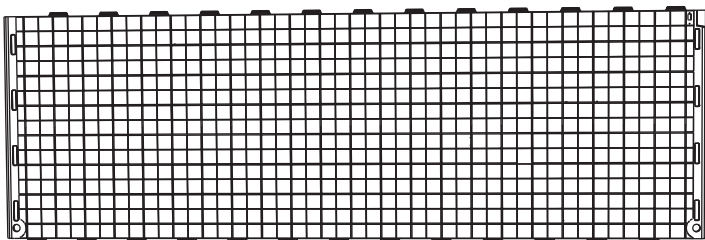

**AFX** (x2)  
Center Floor Panel

### TOOLS REQUIRED

**HARDWARE BAG REQUIRED: BQH**



**Phillips Screwdriver**



**Safety Glasses**



**ADC** (x1)  
#2 Phillips Bit



## TOOLS AND HARDWARE REQUIRED FOR THIS PAGE



NO HARDWARE REQUIRED FOR THIS STEP

SEC 2

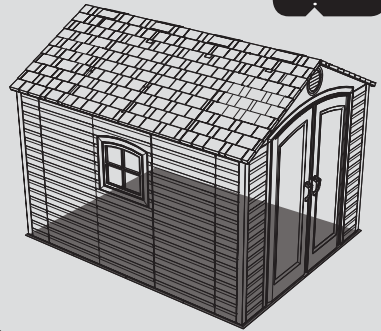

SEC

### FLOOR ASSEMBLY

2.1

Lay an **Outer Floor Panel (AGR)** flat on the ground. Hold a **Center Floor Panel (AFX)** at an angle as shown and fit tabs into slots. Lay Center Floor Panel flat.

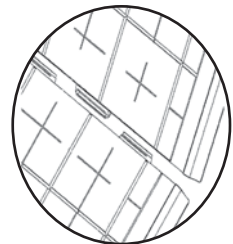
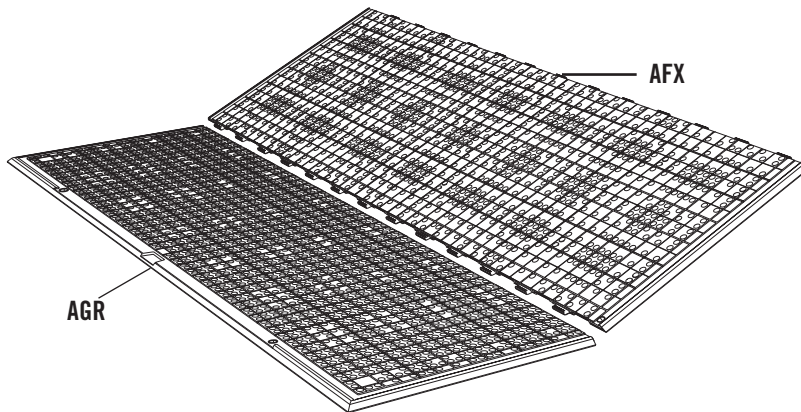

SEC

2.2

Hold the second **Center Floor Panel (AFX)** at an angle as shown and fit tabs into slots. Lay Center Floor Panel flat.

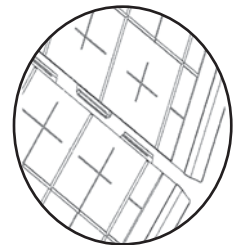
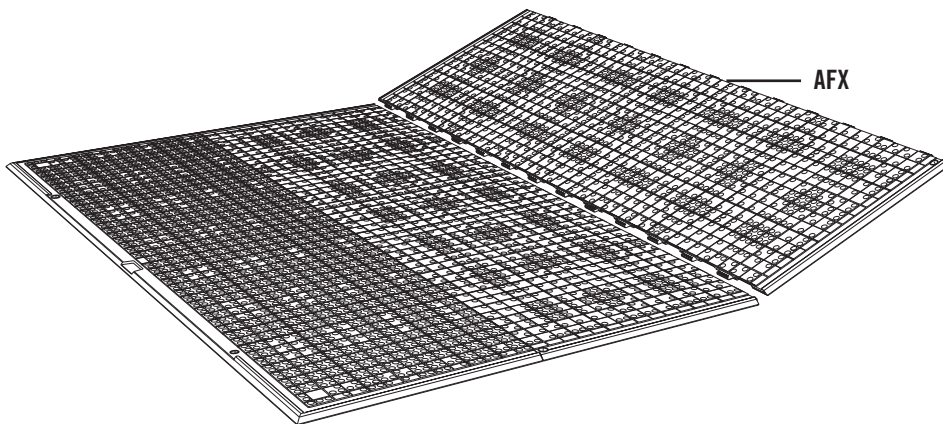

### CAUTION

Sharp objects may damage your floor. If resting sharp, heavy objects on your shed floor, place a block of wood between the sharp object and floor.





# TOOLS AND HARDWARE REQUIRED FOR THIS PAGE

SEC 2

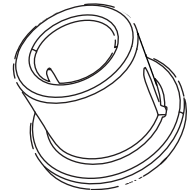

AHO (x2)

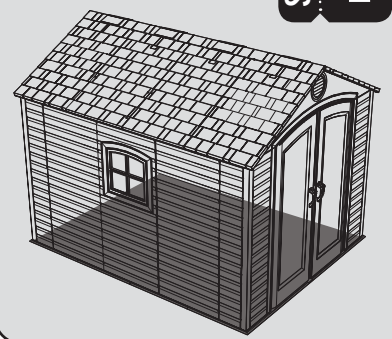

SEC

2.3

Finally, connect the last **Outer Floor Panel (AGR)** to the second Center Floor Panel and lay flat.

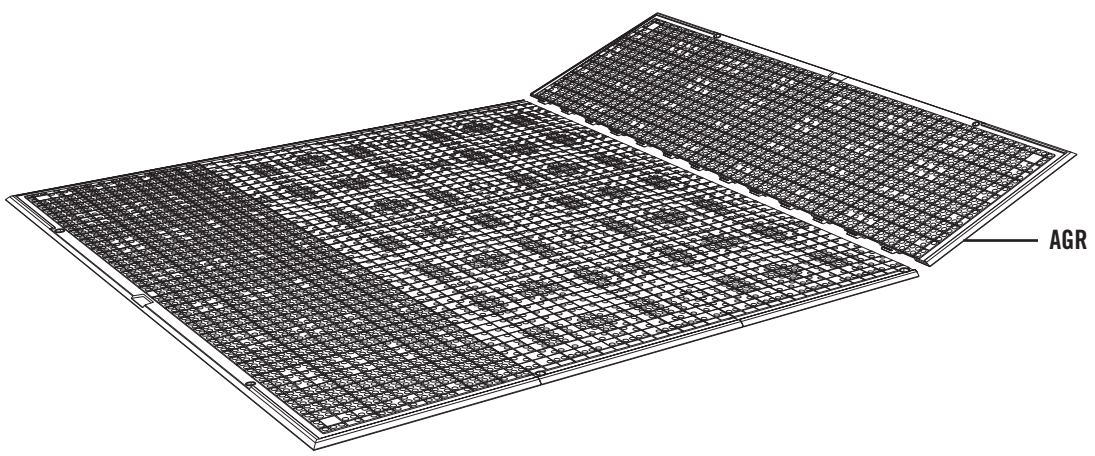

SEC

2.4

Decide which end will be the front of your shed. Lift the Floor Panels up enough to slide the two (2) **Door Hinge Bushings (AHO)** under and up through the holes in the Floor Panels as shown.

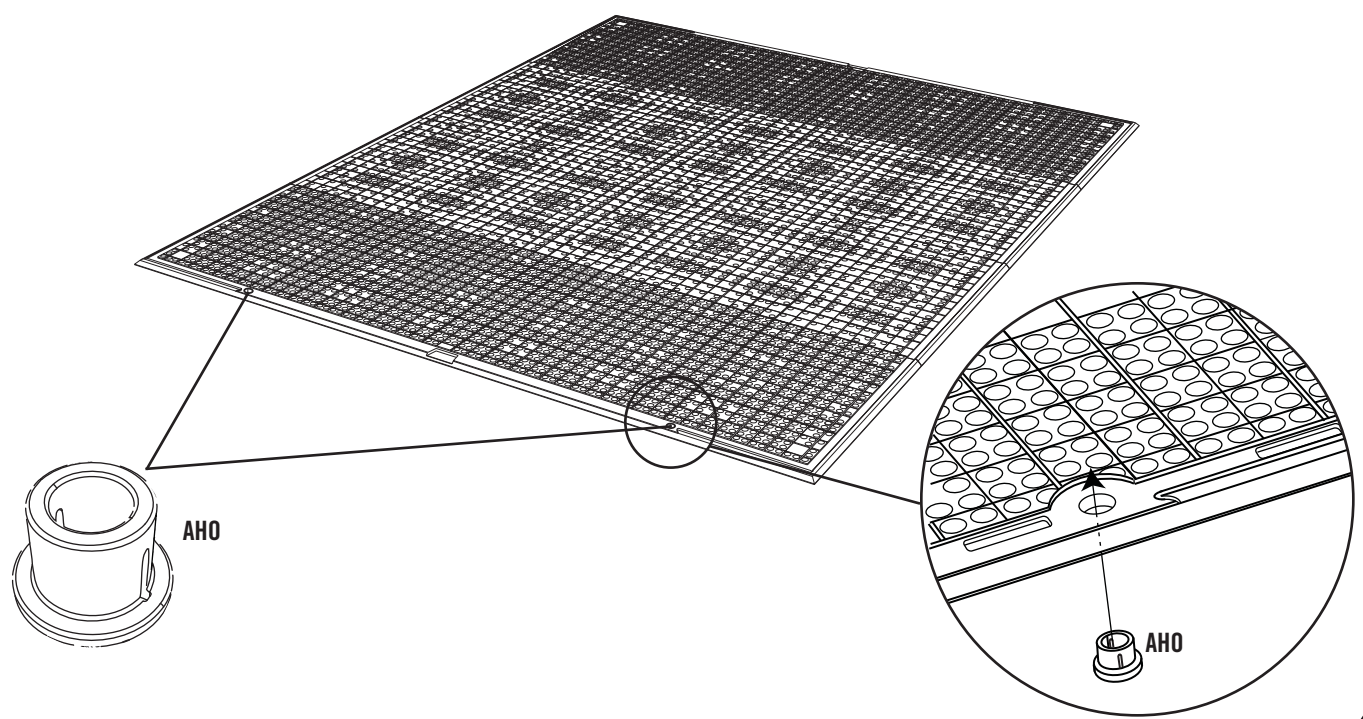



# TOOLS AND HARDWARE REQUIRED FOR THIS PAGE

SEC 2

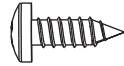

**BQC** (x20)  
(Only 12 used)

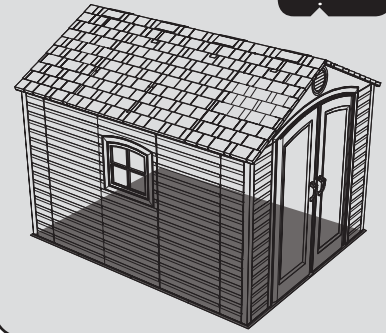

SEC

2.5

Face the seam of the two adjacent Floor Panels. Insert two (2) #8 x 1/2" Pan-Head Screws (BQC) near the seam of a Floor Panel and down into the tab of the adjacent Floor Panel at the locations shown. Repeat this step for both sides of each seam as shown.

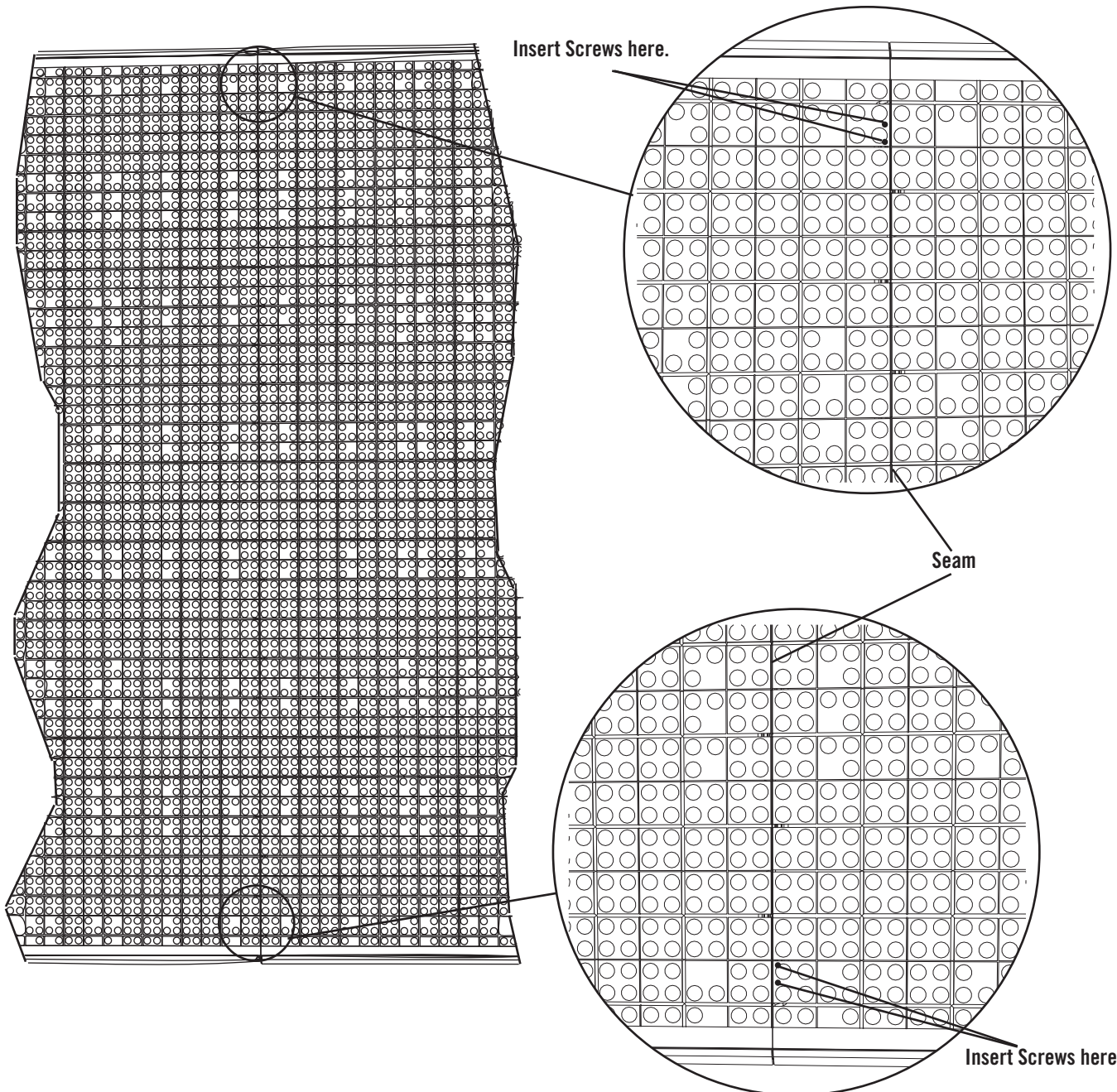



## TOOLS AND HARDWARE REQUIRED FOR THIS PAGE

SEC 2



**IF YOU PLAN ON ANCHORING YOUR SHED, CHECK WITH YOUR LOCAL HARDWARE STORE FOR SUITABLE HARDWARE.**

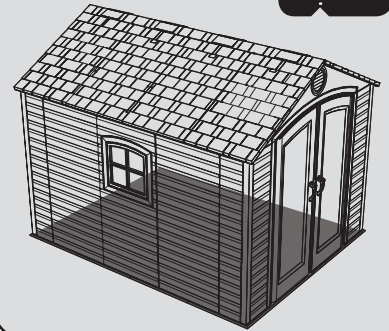

SEC

2.6

### ANCHORING THE SHED

If you plan on anchoring your shed, you can anchor it to your platform through the four indentations near the corners of the floor. The anchoring hardware used depends on the platform. If you have a concrete platform, we recommend using four (4) 3/8" Anchor Bolts and four (4) 3/8" x 1" Flat Washers. If you have a wood framed platform, we recommend using four (4) 3/8" Lag Bolts and four (4) 3/8" x 1" Flat Washers. Do not exceed a 3/8" diameter bolt. Refer to your local hardware store for this hardware. **Do not tighten anchoring hardware until instructed to do so at the end of these instructions.**

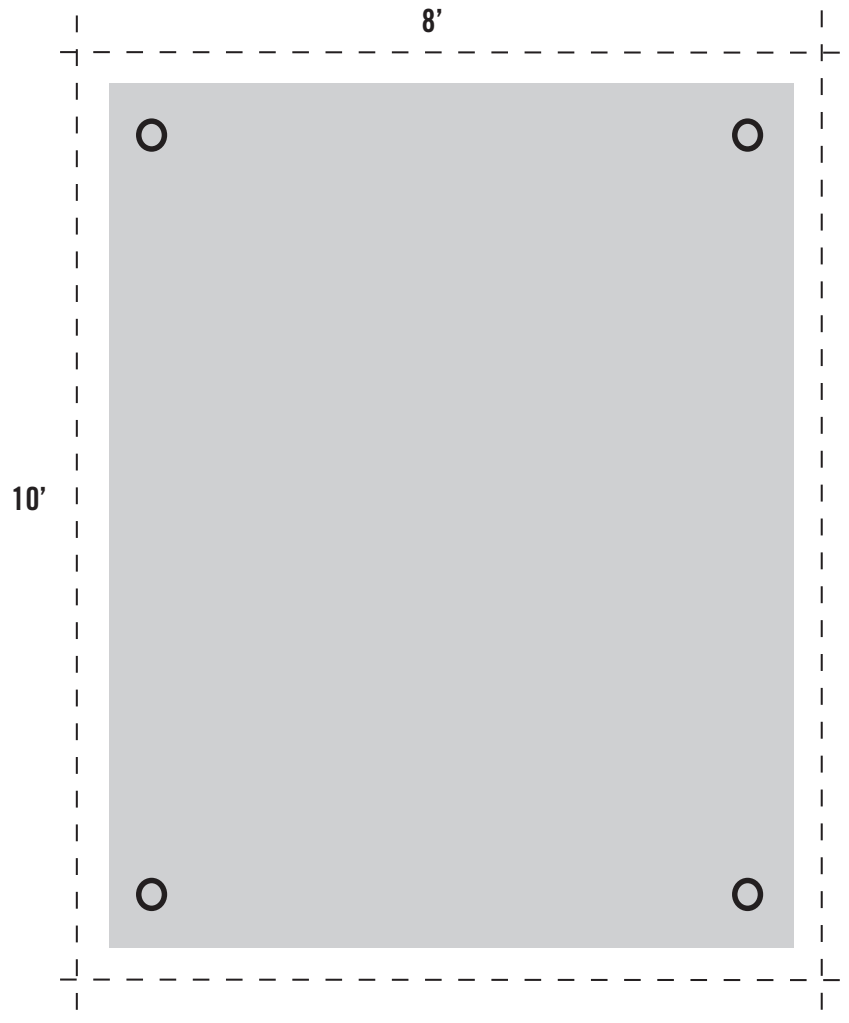

### WARNING

Failure to anchor the shed may result in property damage and/or personal injury.



# SEC 3 TRUSS ASSEMBLY

## HARDWARE REQUIRED

## HARDWARE BAG REQUIRED: BEA (x3)

Hardware shown at actual size (\*Unless noted otherwise)

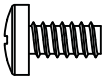

ADY (x18)  
#10 x 3/8" Screw



ADJ (x6)  
1/4" Cap Nut



ADK (x18)  
#10 Cap Nut

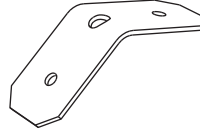

\*AIP (x3)  
Truss Connector

Part shown at 50% of actual size

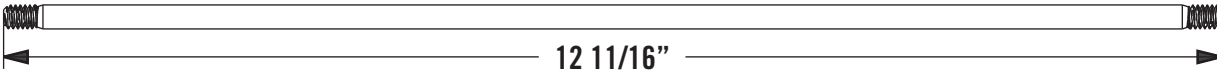

ADH (x3)  
1/4" Threaded Rod

## METAL PARTS REQUIRED

## METAL PARTS KITS REQUIRED: CTF, CTI

Parts shown at 8% of actual size (\*Unless indicated otherwise)

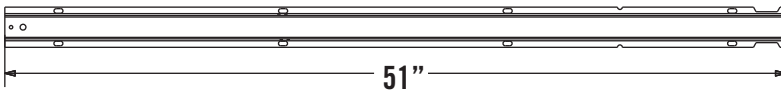

AFH (x6)  
Truss Gutter Channel

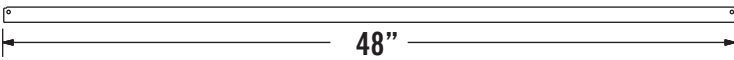
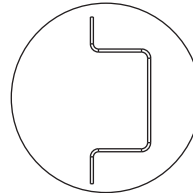

AFG (x3)  
Roof Truss Brace

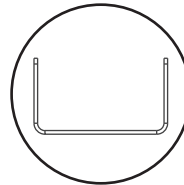

## TOOLS REQUIRED



Phillips Screwdriver



7/16" Wrench (x2)



3/8" Wrench



Safety Glasses





## TOOLS AND HARDWARE REQUIRED FOR THIS PAGE

SEC 3

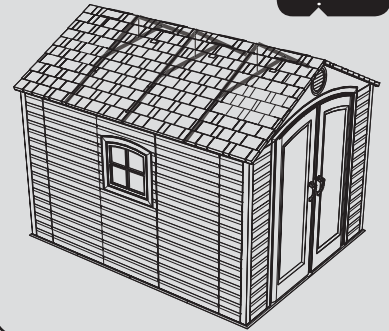
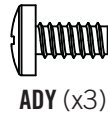

SEC

### TRUSS ASSEMBLY

3.1

Stand a **Truss Gutter Channel (AFH)** upright and set a **Truss Connector (AIP)** inside the end of the Channel as shown. Align the holes and secure with one (1) **#10 x 3/8" Pan-Head Screw (ADY)** and one (1) **#10 Cap Nut (ADK)**.

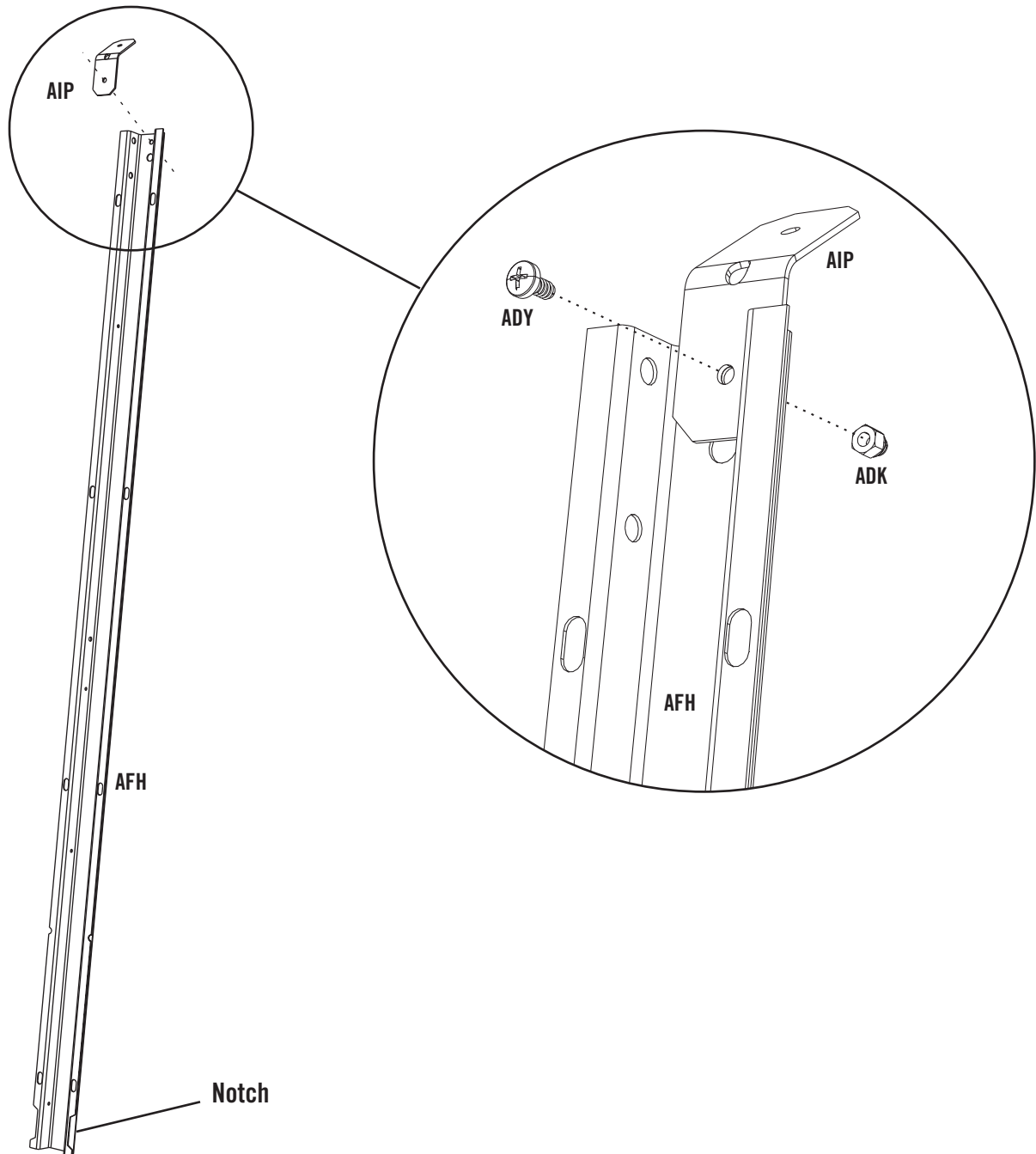



## TOOLS AND HARDWARE REQUIRED FOR THIS PAGE

SEC 3



3/8"

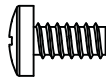

ADY (x3)



ADK (x3)

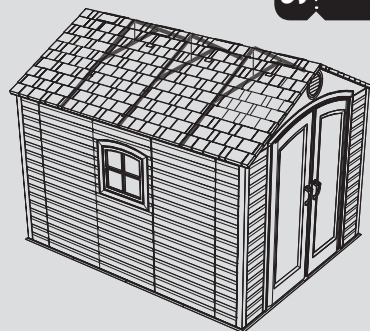

SEC

3.2

Connect another **Truss Gutter Channel (AFH)** to the Truss Connector using one (1) **#10 x 3/8" Pan-Head Screw (ADY)** and one (1) **#10 Cap Nut (ADK)**.

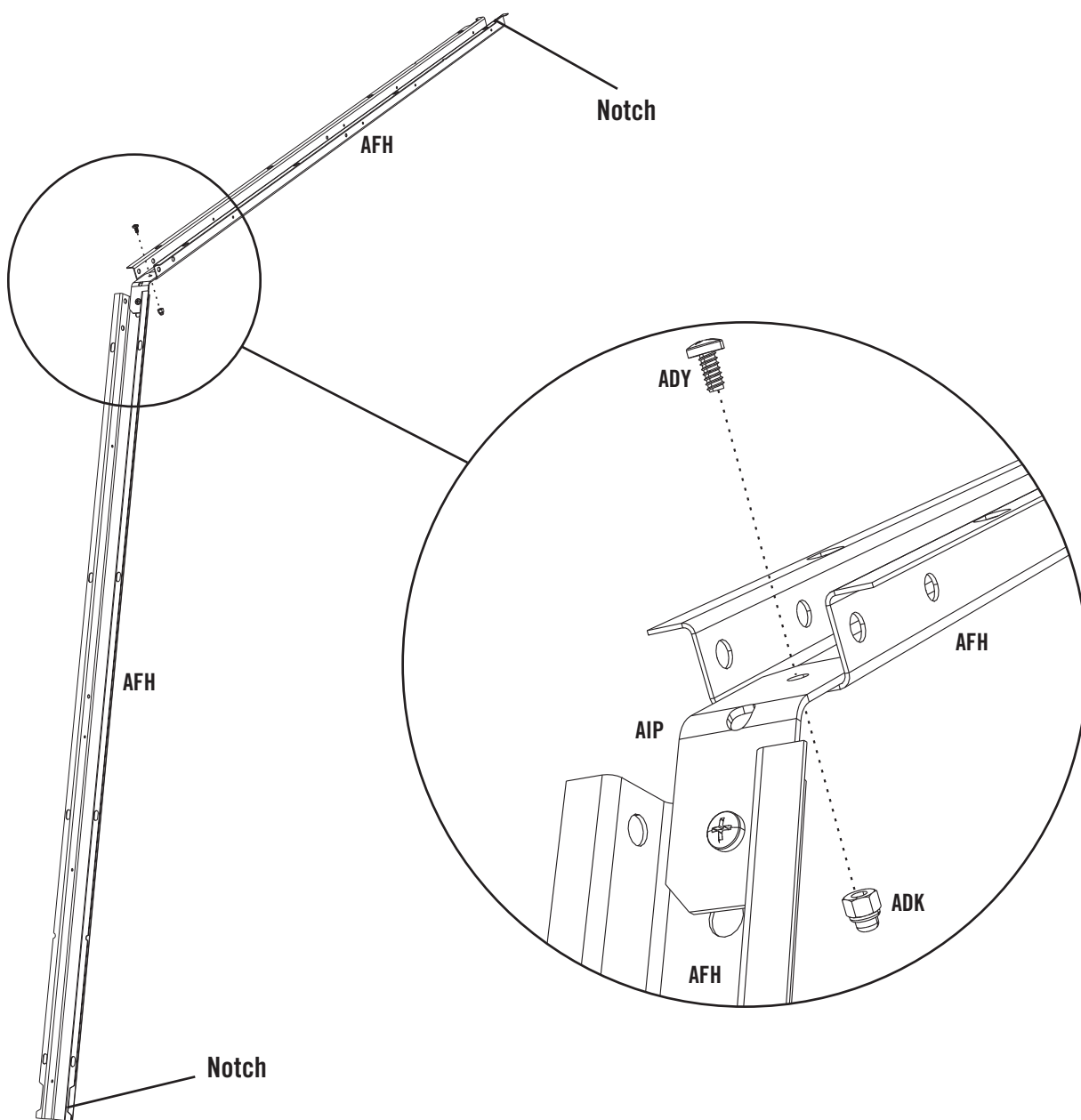



## TOOLS AND HARDWARE REQUIRED FOR THIS PAGE

SEC 3



3/8"

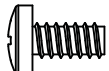

ADY (x12)



ADK (x12)

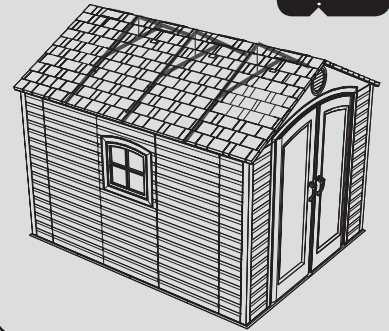

SEC

3.3

Lay the Truss Assembly on its side, and align the holes in a **Roof Truss Brace (AFG)** with those circled on the Truss Gutter Channels as shown.

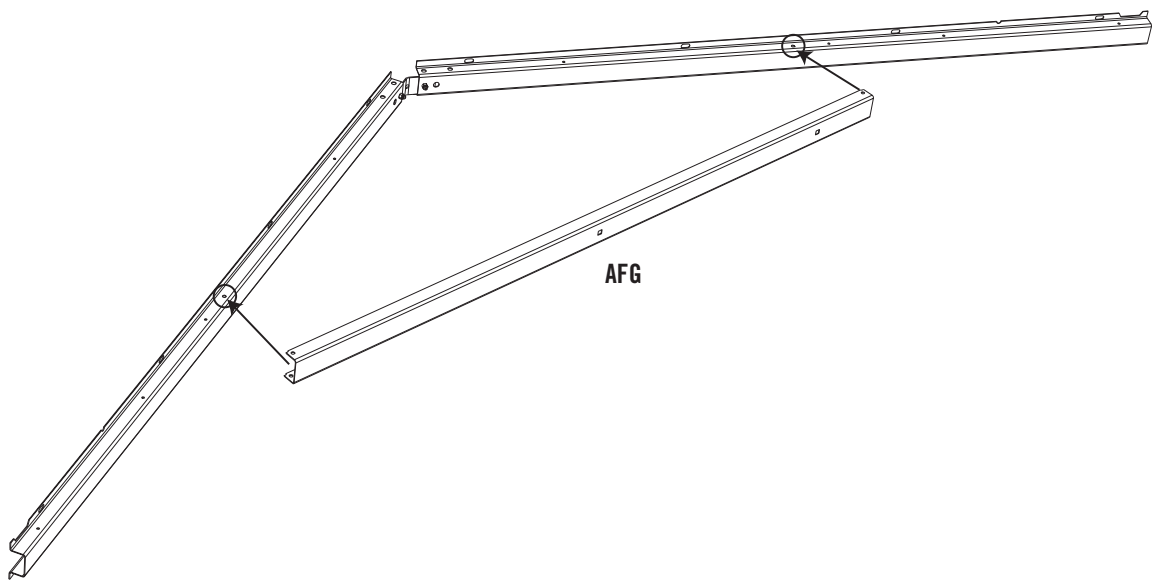

SEC

3.4

Secure the Roof Truss Brace to the Truss Gutter Channel using two (2) **#10 x 3/8" Pan-Head Screws (ADY)** and two (2) **#10 Cap Nuts (ADK)**. Repeat this step for the other end of the Roof Truss Brace.

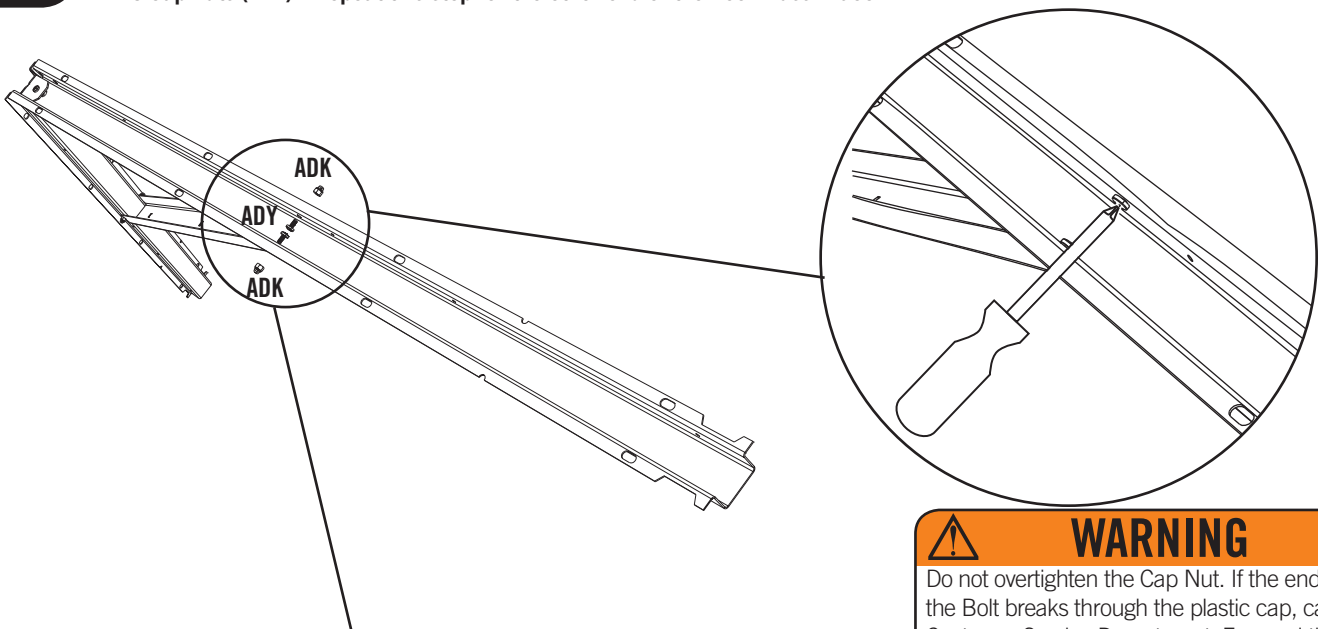

*Note: The Cap Nuts goes on the outside of the Truss.*



### WARNING

Do not overtighten the Cap Nut. If the end of the Bolt breaks through the plastic cap, call our Customer Service Department. Exposed threads on the end of the Bolt may cause serious injuries.



## TOOLS AND HARDWARE REQUIRED FOR THIS PAGE



7/16" (x2)



ADJ (x6)

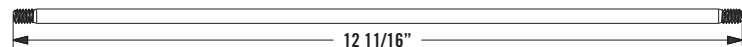

ADH (x3) (Not to scale)

SEC 3

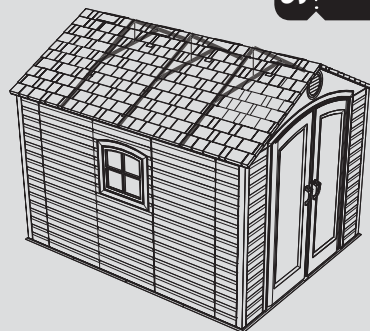

SEC

3.5

With the Truss Assembly on its side, slide a **1/4" Threaded Rod (ADH)** through the Roof Truss Brace and Truss Connector as shown. Secure the top and bottom of the 1/4" Threaded Rod with a **1/4" Cap Nut (ADJ)**. Tighten all hardware. The 1/4" Threaded Rod will still spin freely. **Repeat this section for the second and third Truss Assemblies.**

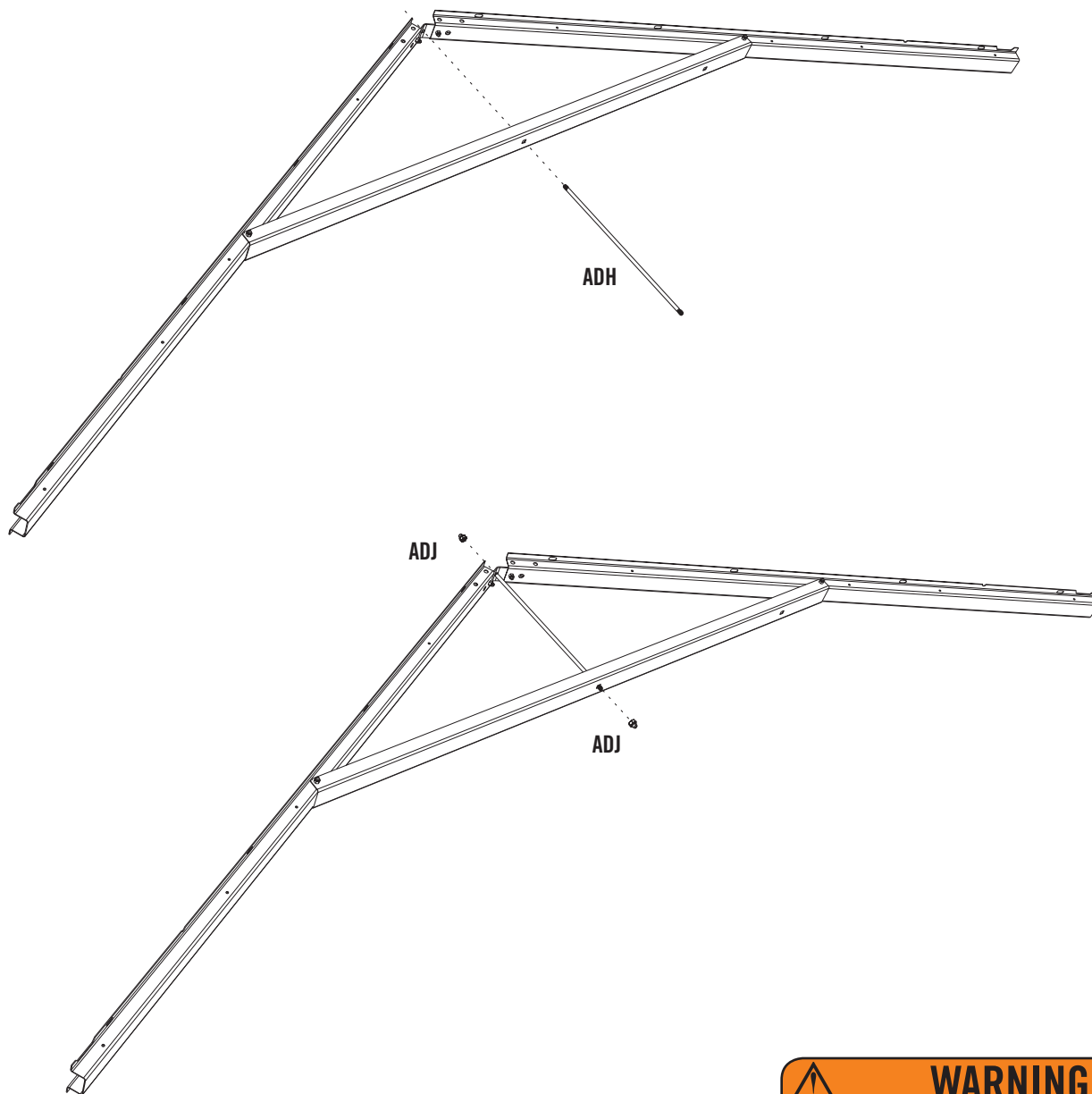

**WARNING**

Do not overtighten the Cap Nut.

## SEC 4 WALL PANEL INSTALLATION

### HARDWARE REQUIRED

**HARDWARE BAG REQUIRED: BHY**

Hardware shown at actual size

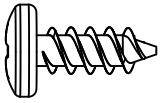

**ADZ** (x58)  
1/4" x 5/8" Pan-Head Screw  
(Not all screws will be used)

### PLASTIC PARTS REQUIRED

**LOCATED IN BOX 1**

Part shown at 4% of actual size

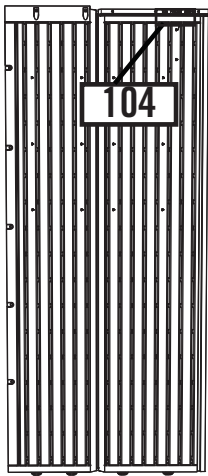

**AGY** (x1)  
Corner Wall Panel 104

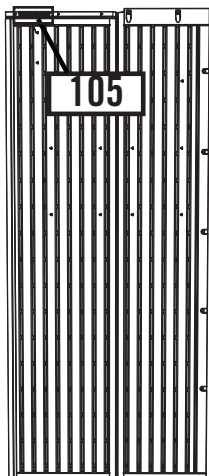

**AGN** (x1)  
Corner Wall Panel 105

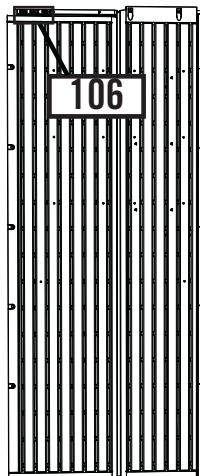

**AGW** (x1)  
Corner Wall Panel 106

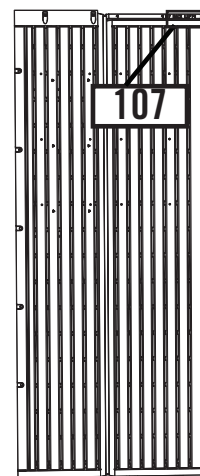

**AGL** (x1)  
Corner Wall Panel 107

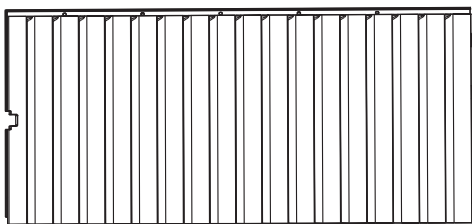

**AHD** (x7)  
Wall Panel

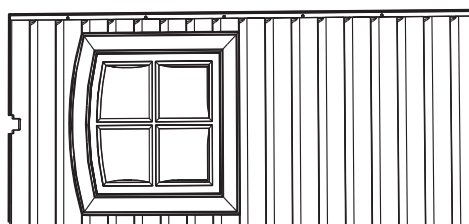

**AHH** (x1)  
Window Wall Panel

### TOOLS REQUIRED

**SMALL PARTS BOX REQUIRED: BSI**



**Phillips Screwdriver**



**Safety Glasses**



**AIW** (x1)  
Wood Block (Included)



## TOOLS AND HARDWARE REQUIRED FOR THIS PAGE

SEC 4



AIW (x1)

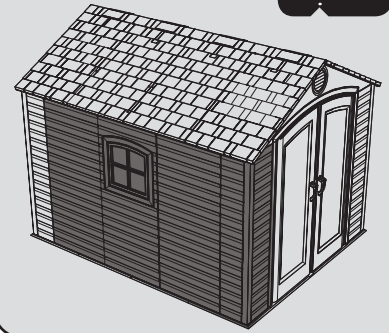
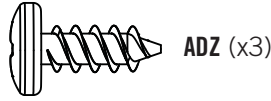

SEC

4.1

### WALL PANEL INSTALLATION

Fold **Corner Wall Panel 105 (AGN)**. Fit tabs of Panel into the front, left corner of your Floor (while facing shed). Place a **Wood Block (AIW)** under the floor panel, directly under the first tab, then pull down on the Corner Wall Panel until the tab snaps into place. Move the Wood Block under the next tab and repeat.

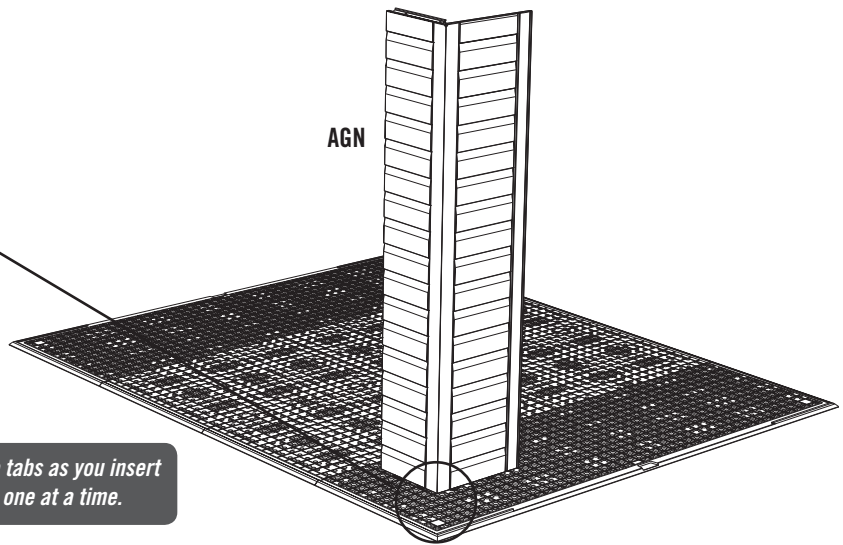
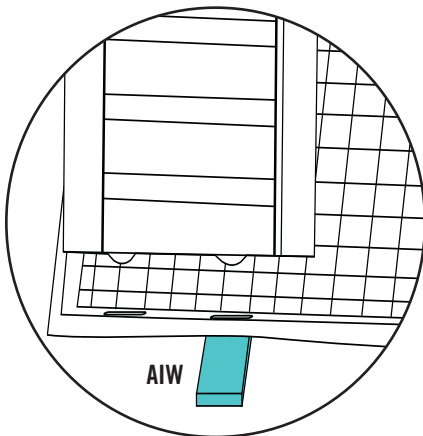

*Note: Place the Wood Block (AIW) directly under the tabs as you insert them throughout the assembly. Snap tabs into place one at a time.*

SEC

4.2

Snap two **Wall Panels (AHD)** and a **Window Wall Panel (AHH)** into place along the left side of the shed. **The Window Wall Panel may be inserted in any side Wall Panel position.** Ensure the tops of the Wall Panels are even and the holes align. Insert a **1/4" x 5/8" Pan-Head Screw (ADZ)** through the top hole of each set of Panels to fasten the Panels together as shown. You'll finish fastening the panels together towards the end of this section.

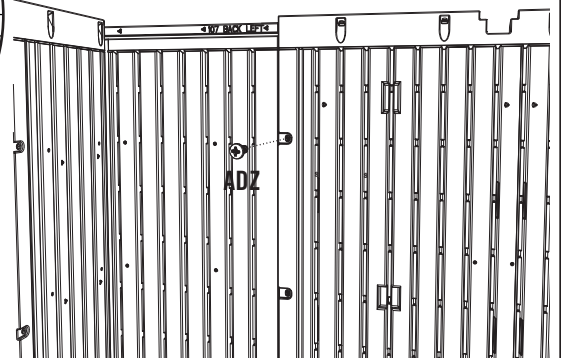
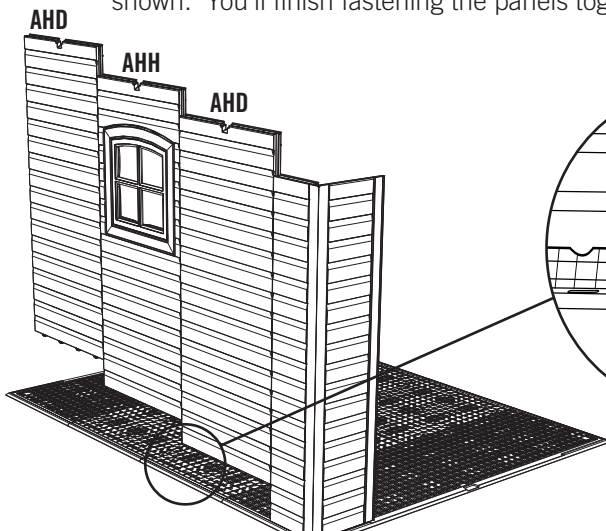

*Note: A second person should apply pressure on opposite side of the Wall Panels for easier insertion of the Screw. Do not overtighten Screw.*





## TOOLS AND HARDWARE REQUIRED FOR THIS PAGE

SEC 4



AIW (x1)

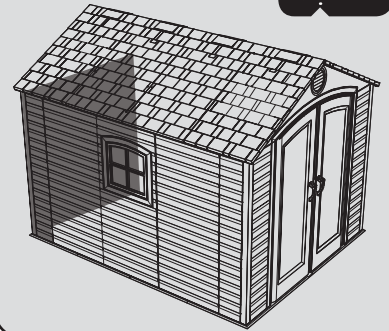

SEC

4.3

Fold **Corner Wall Panel 107 (AGL)**. Snap into place and fasten at the top hole with the required hardware.

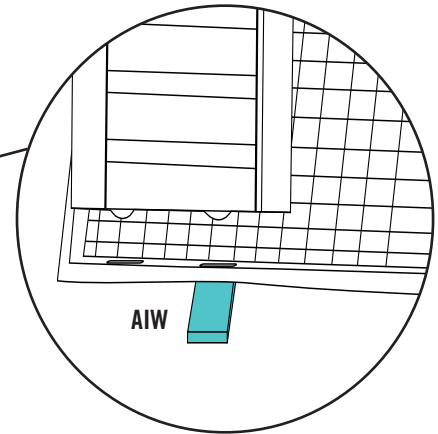
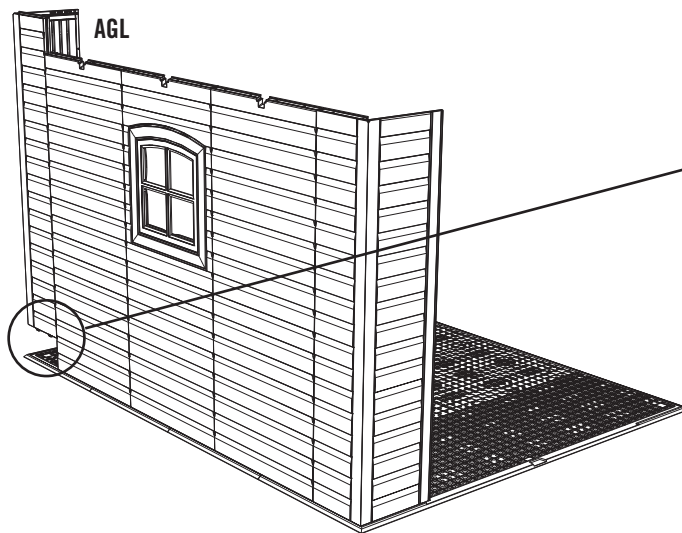

SEC

4.4

Insert two **Wall Panels (AHD)** along the back side of shed. Ensure the tops are level and the holes line up before fastening the Panels through the top holes using the required hardware.

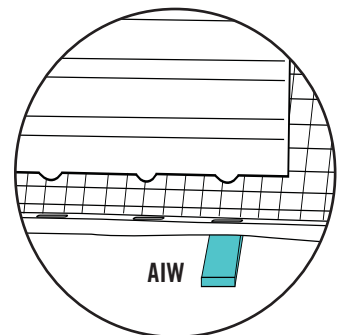
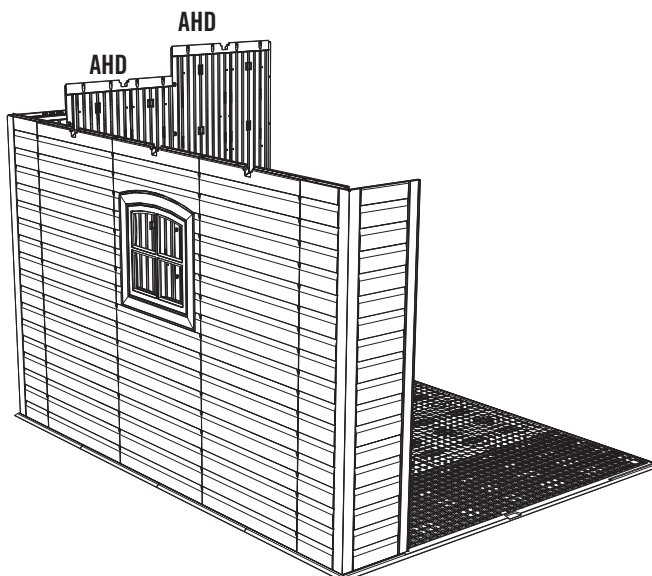



## TOOLS AND HARDWARE REQUIRED FOR THIS PAGE



AIW (x1)

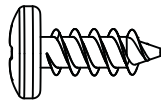

ADZ (x4)

SEC

4

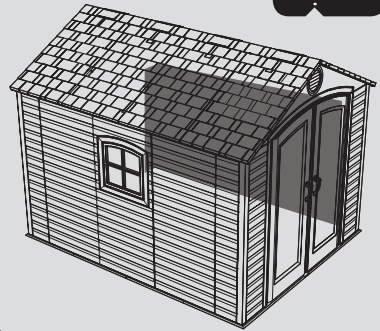

SEC

4.5

Fold **Corner Wall Panel 106 (AGW)** and fasten it to the rear Wall Panel through the top hole using the required hardware.

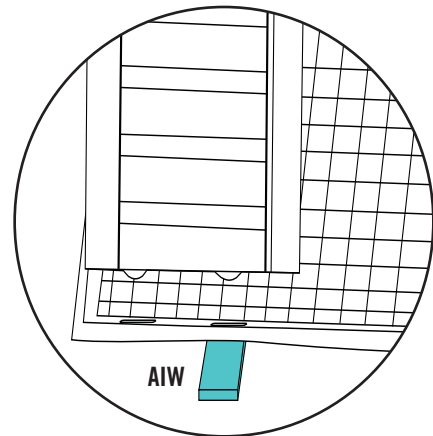
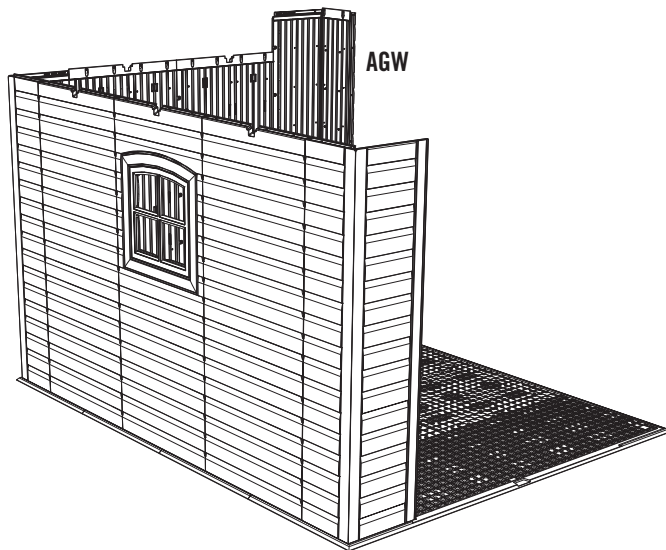

SEC

4.6

Snap three **Wall Panels (AHD)** into place along the right side of the shed. **The Window Wall Panel may be inserted in any side Wall Panel position.** Ensure the tops of the Wall Panels are even and the holes align. Insert a **1/4" x 5/8" Pan-Head Screw (ADZ)** through the top hole of each set of Panels to fasten the Panels together as shown. **AHD**

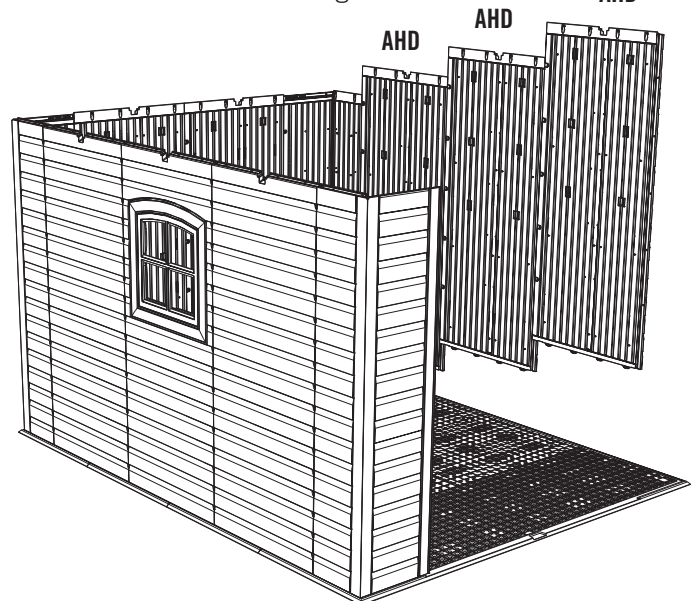





## TOOLS AND HARDWARE REQUIRED FOR THIS PAGE

SEC 4



AIW (x1)

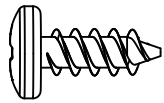

ADZ (x45)

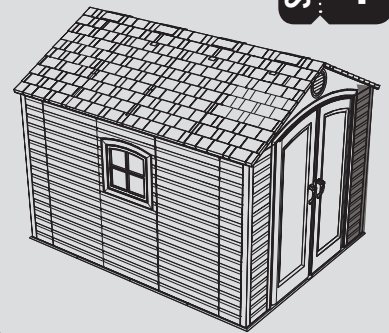

SEC

4.7

Fold **Corner Wall Panel 104 (AGY)** and snap it into place at the right, front corner of the Floor as shown. Fasten it to the Wall Panel through the top hole using the required hardware. Finish fastening all Panels together with the rest of the **1/4" x 5/8" Pan-Head Screws (ADZ)** for all holes.

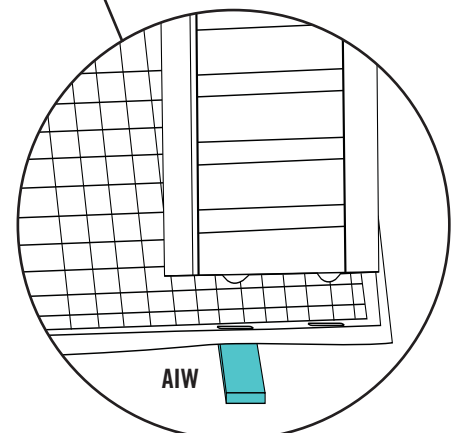
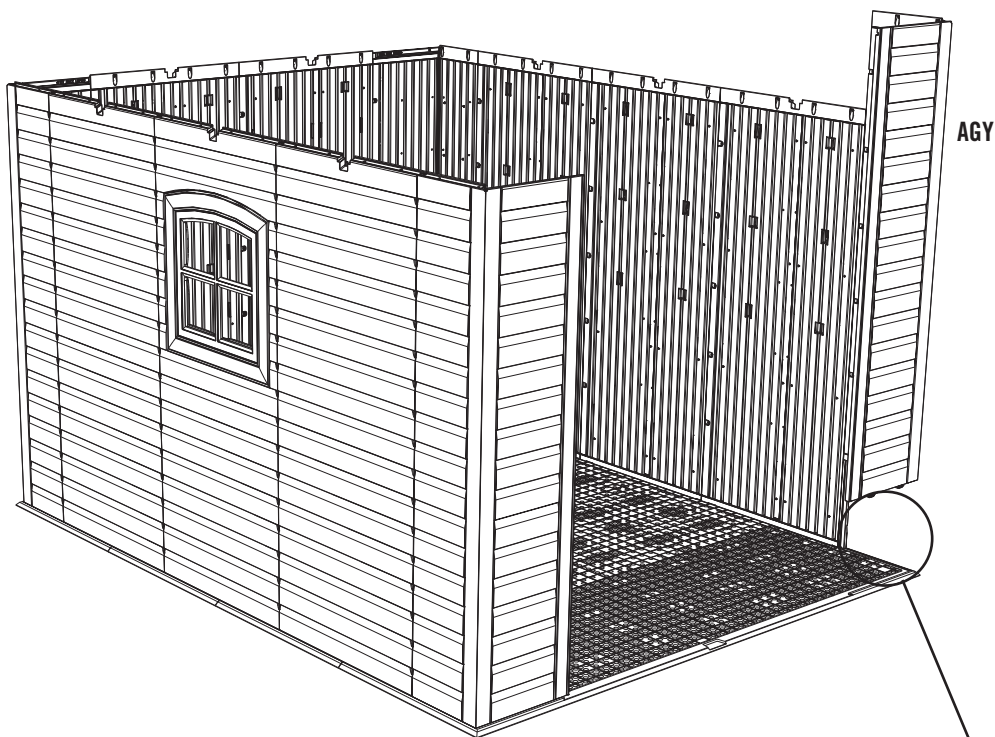

# SEC 5 LEFT DOOR ASSEMBLY

## HARDWARE REQUIRED

**HARDWARE BAG REQUIRED: BEF**

Hardware shown at actual size

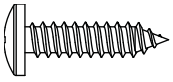

**ADW** (x3)  
#10 x 3/4" Pan-Head Screw

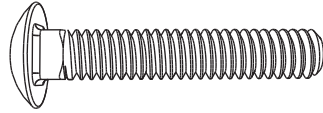

**ABU** (x2)  
1/4" x 1 1/2" Carriage Bolt



**ADJ** (x2)  
1/4" Cap Nut

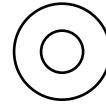

**AEE** (x3)  
#10 Flat Washer

Part shown at 25% of actual size

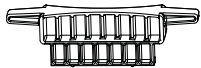

**AHM** (x2)  
Deadbolt Latch



**AIB** (x1)  
Left Door Strike Plate



**AIA** (x1)  
Left Door Lock Bracket

Part shown at 15% of actual size



**AHZ** (x1)  
Left Door Handle

## METAL PARTS REQUIRED

**METAL PARTS KITS REQUIRED: CTI**

Part shown at 8% of actual size

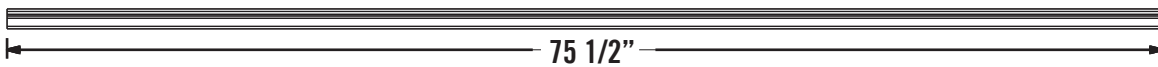

**AFC** (x1)  
Door End Channel

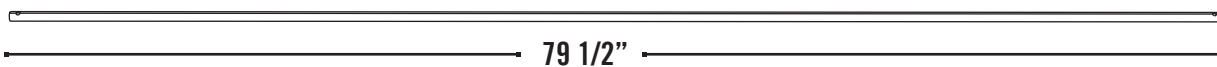
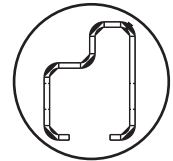

**CRD** (x1)  
Door Hinge Tube

## PLASTIC PARTS REQUIRED

**LOCATED IN BOX 1**

Part shown at 4% of actual size

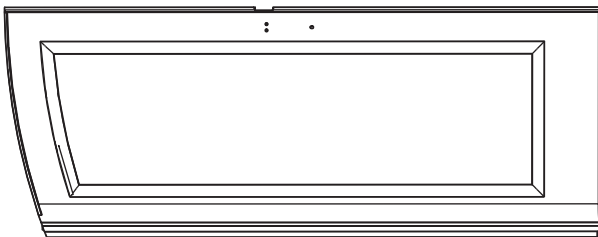

**AGO** (x1)  
Left Door

## TOOLS REQUIRED



Phillips Screwdriver



7/16" Wrench



Safety Glasses



## TOOLS AND HARDWARE REQUIRED FOR THIS PAGE

SEC 5

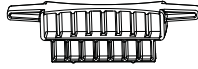

AHM (x2)

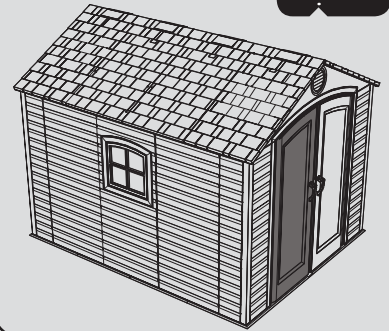

SEC

### LEFT DOOR ASSEMBLY

5.1

Rest the **Left Shed Door (AGO)** with front side down. Slide a **Door Hinge Tube (CRD)** through the hole in the Door as shown.

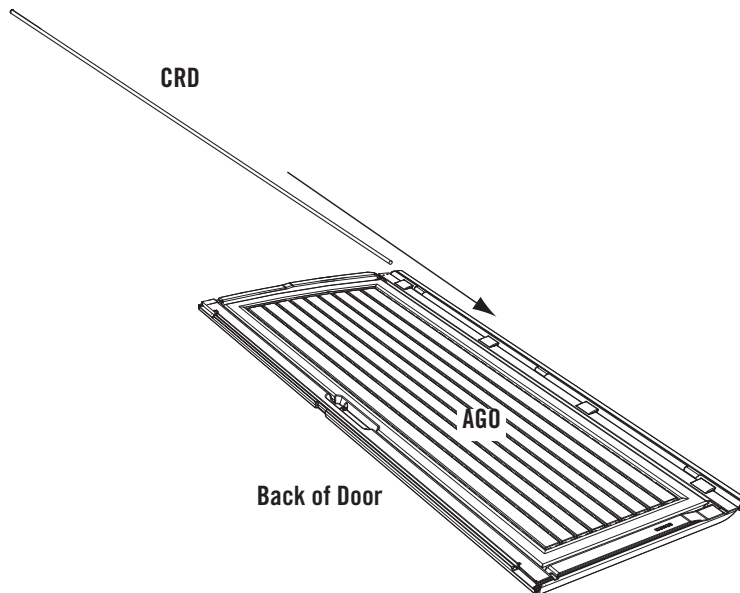

SEC

5.2

Position the **Deadbolt Latches (AHM)** in the slots at the top and bottom of the Door, then slide the **Door End Channel (AFC)** onto the Door as shown.

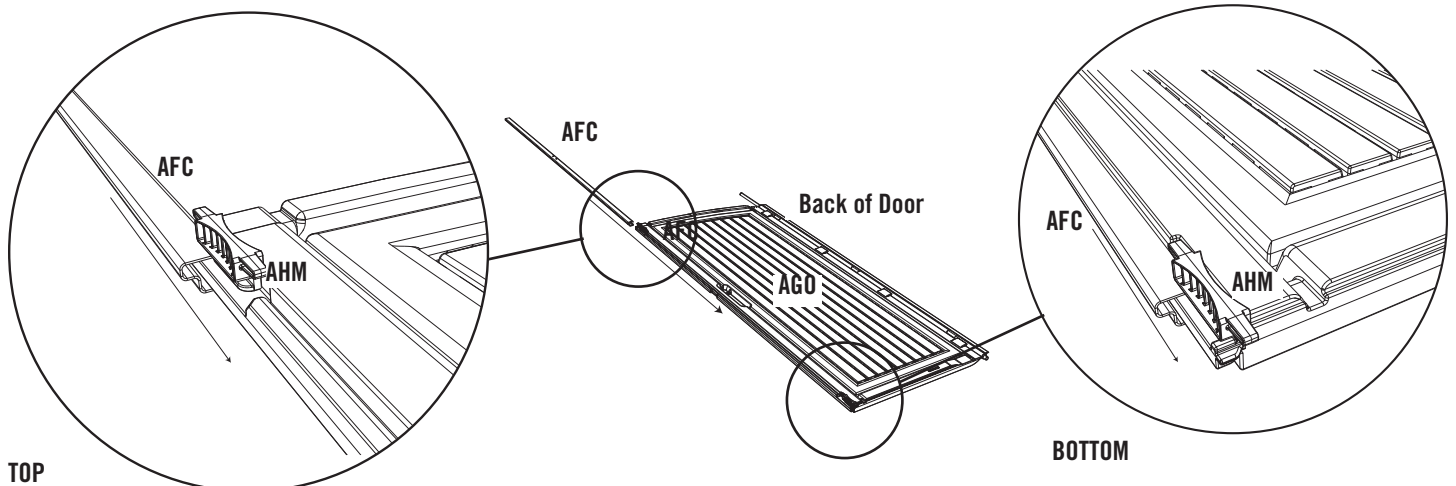

*Note: The Door End Channel fits onto Door with the flat side up (facing the Deadbolt Latches).*



## TOOLS AND HARDWARE REQUIRED FOR THIS PAGE

SEC 5

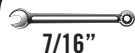

7/16"

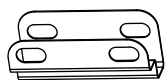

AIB (x1)

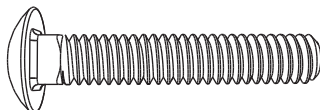

ABU (x2)



ADJ (x2)



AIA (x1)

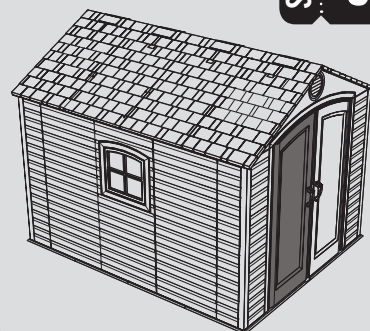

SEC

5.3

Slip the **Left Door Strike Plate (AIB)** over the Left Shed Door and align the holes.

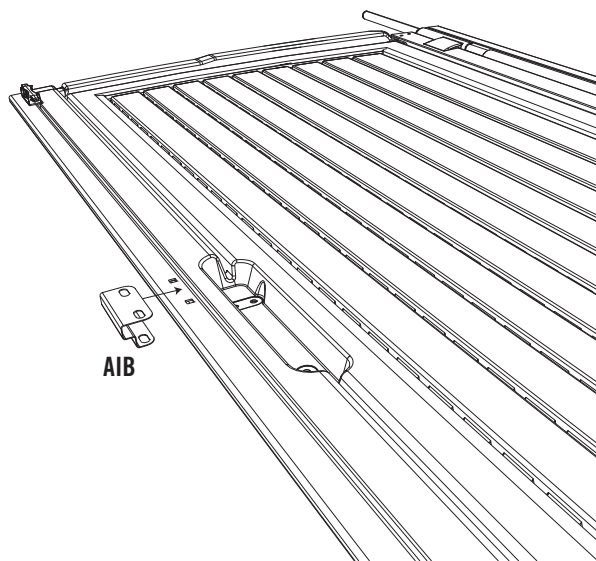

AIB

**!** Note: You may need to nudge the Door End Channel to make these holes line up with the gap in the Door.

SEC

5.4

Attach the **Left Door Lock Bracket (AIA)** to the Left Door Strike Plate with two **1/4" x 1 1/2" Carriage Bolts (ABU)** and two **1/4" Cap Nuts (ADJ)**.

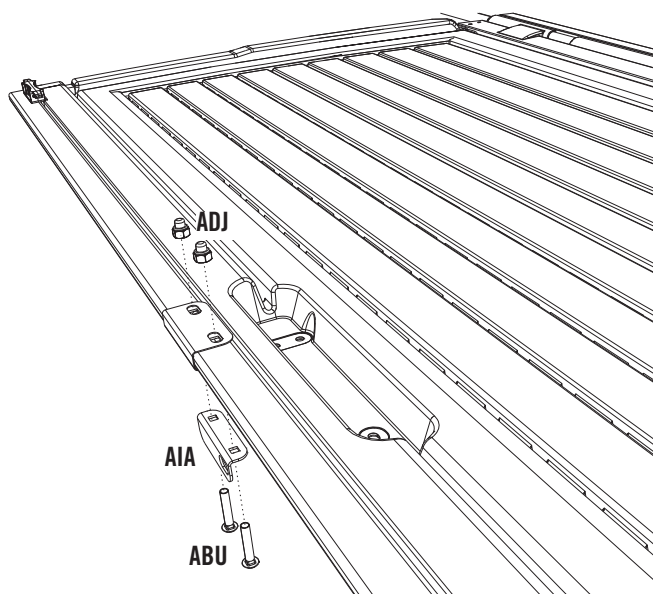

AIA

ABU



### WARNING

Do not overtighten the Cap Nut. If the end of the Bolt breaks through the plastic cap, call our Customer Service Department. Exposed threads on the end of the Bolt may cause serious injuries.



## TOOLS AND HARDWARE REQUIRED FOR THIS PAGE

SEC 5

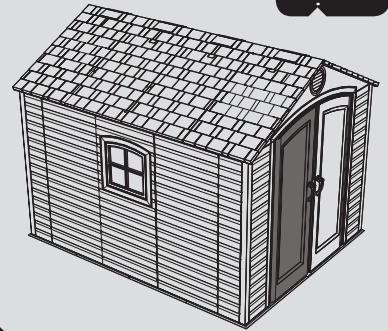
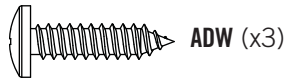

SEC

5.5

Attach the **Left Door Handle (AHZ)** using three (3) #10 Flat Washers (AEE) and three (3) #10 x 3/4" Pan-Head Screws (ADW).

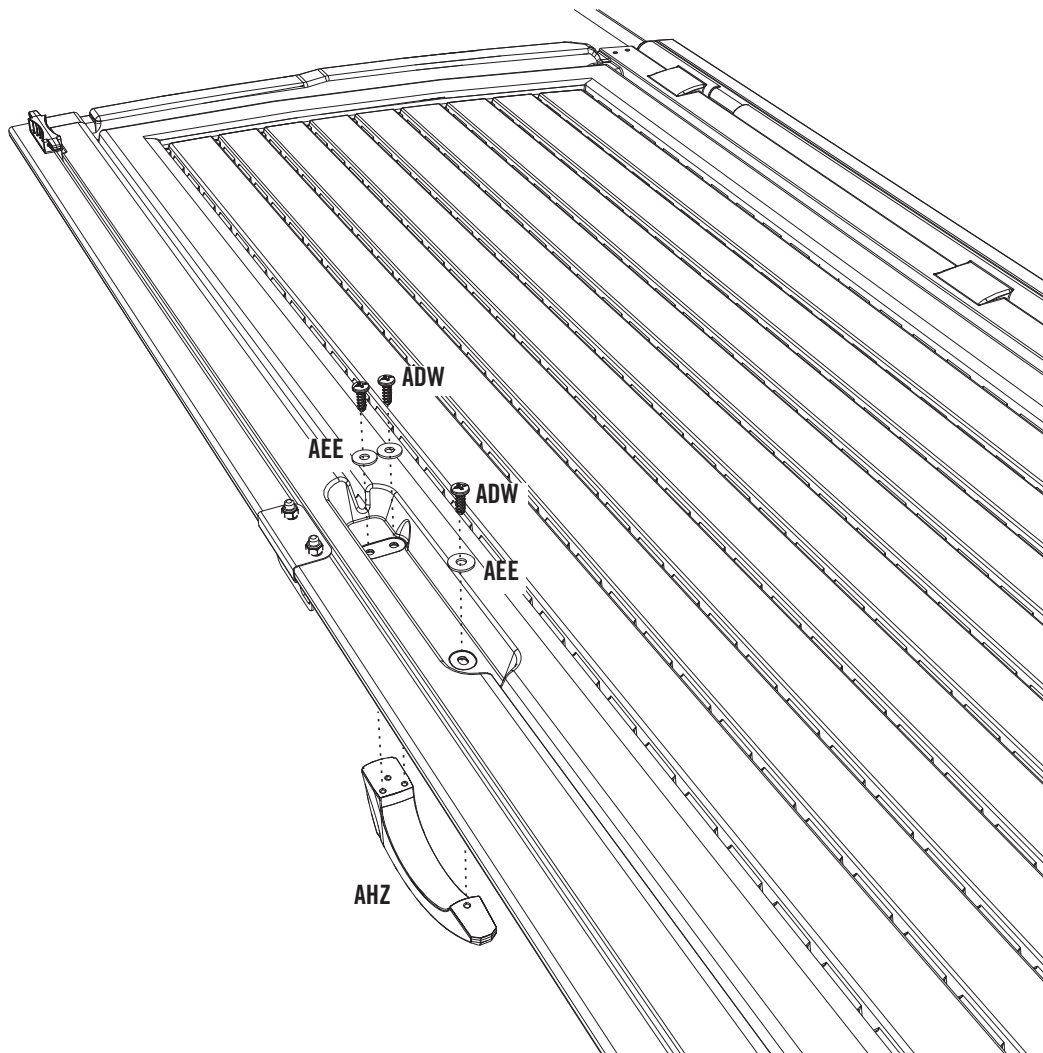

**SEC 6 RIGHT DOOR ASSEMBLY**

**HARDWARE REQUIRED**

**HARDWARE BAG REQUIRED: BEG**

Hardware shown at actual size

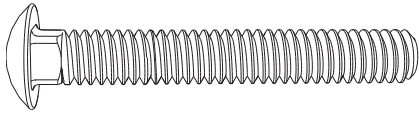

**ABV (x2)**  
1/4" x 2" Carriage Bolt

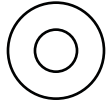

**AEE (x5)**  
#10 Flat Washer  
(Only 3 are used)



**ADB (x2)**  
3/8" x 1/2" Steel Spacer

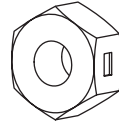

**AAB (x2)**  
1/4" Centerlock Nut

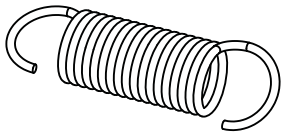

**AHY (x1)**  
Latch Spring

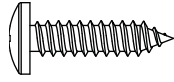

**ADW (x4)**  
#10 x 3/4" Pan-Head Screw

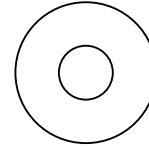

**AEB (x2)**  
1/4" Flat Washer

Part shown at 25% of actual size

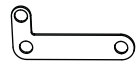

**AHX (x1)**  
Latch Cover Plate

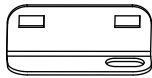

**AIL (x1)**  
Right Door Lock Bracket

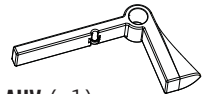

**AHV (x1)**  
Door Latch

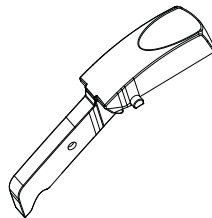

**AIO (x1)**  
Thumb Lever

Part shown at 15% of actual size

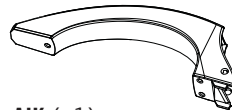

**AIK (x1)**  
Right Door Handle

Part shown at 50% of actual size

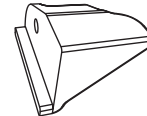

**AHW (x1)**  
Latch Block

**METAL PARTS REQUIRED**

**METAL PARTS KITS REQUIRED: CTI**

Part shown at 8% of actual size

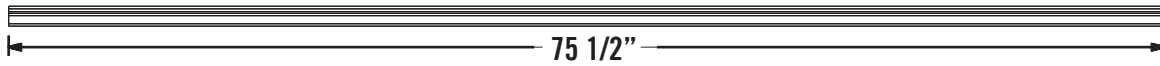

**AFC (x1)**  
Door End Channel

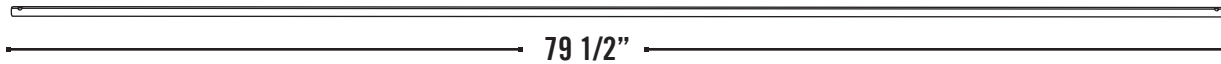
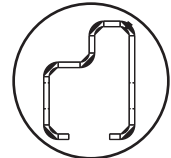

**CRD (x1)**  
Door Hinge Tube

**PLASTIC PARTS REQUIRED**

**LOCATED IN BOX 1**

Part shown at 4% of actual size

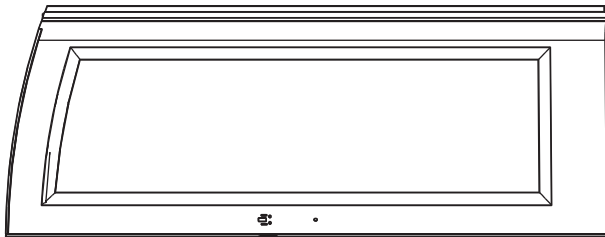

**AGZ (x1)**  
Right Door

**TOOLS REQUIRED**



Phillips Screwdriver



7/16" Wrench

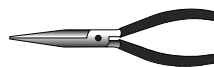

Pliers



Safety Glasses





## TOOLS AND HARDWARE REQUIRED FOR THIS PAGE

SEC 6



NO HARDWARE REQUIRED FOR THIS PAGE

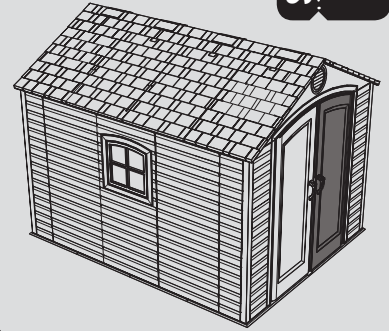

SEC

### RIGHT DOOR ASSEMBLY

6.1

Rest the **Right Shed Door (AGZ)** with front side down. Slide a **Door Hinge Tube (CRD)** through the hole in the Door as shown.

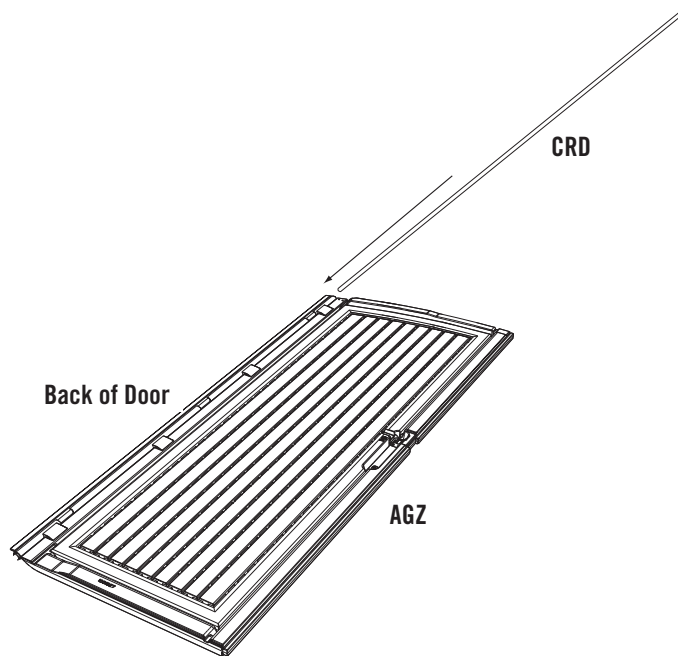

SEC

6.2

Slide the **Door End Channel (AFC)** onto the Door as shown.

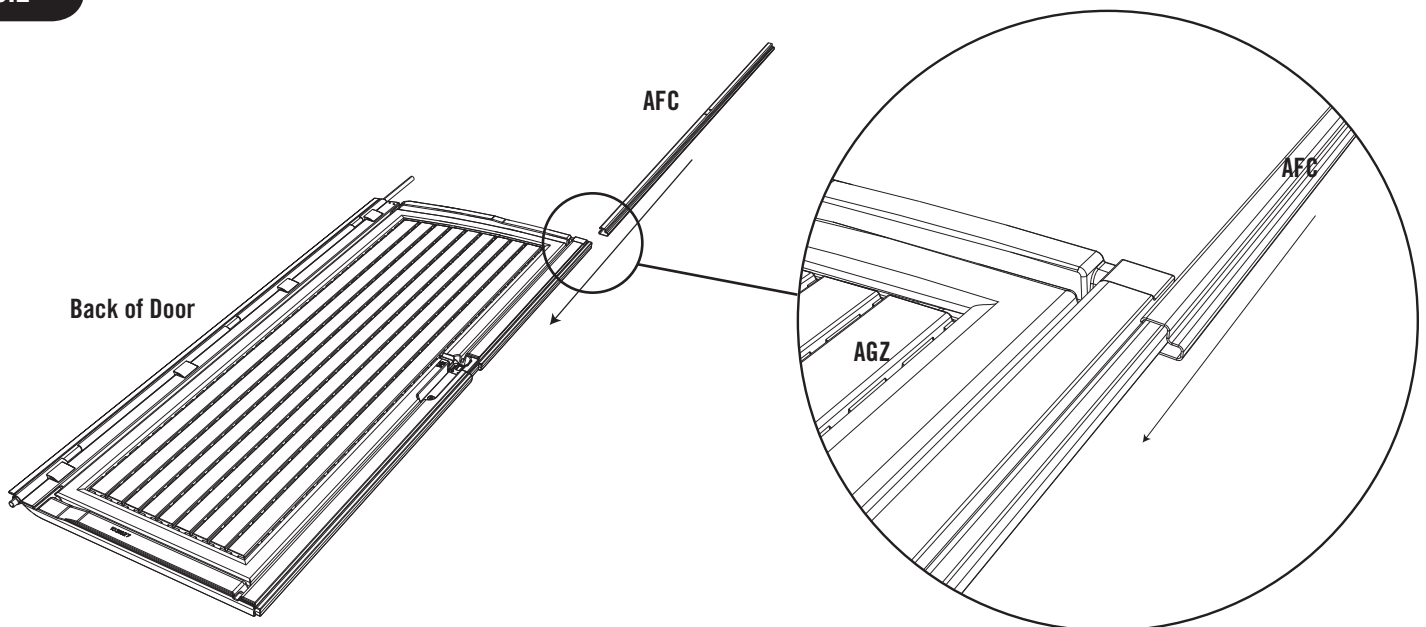



## TOOLS AND HARDWARE REQUIRED FOR THIS PAGE

SEC

6



NO HARDWARE REQUIRED FOR THIS PAGE

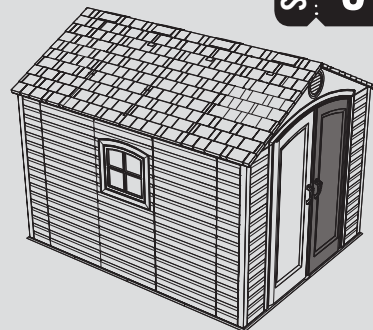

SEC

6.3

Fit knobs of **Thumb Lever (A10)** into the grooves of **Right Door Handle (A1K)**.

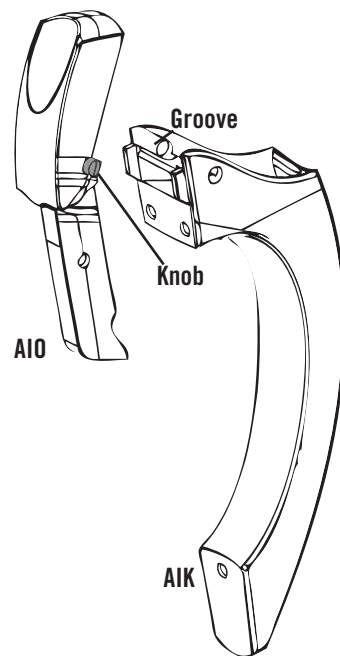

SEC

6.4

Rotate the Thumb Lever into the Right Door Handle. Slide forward until the knobs fit into the holes in the Handle.

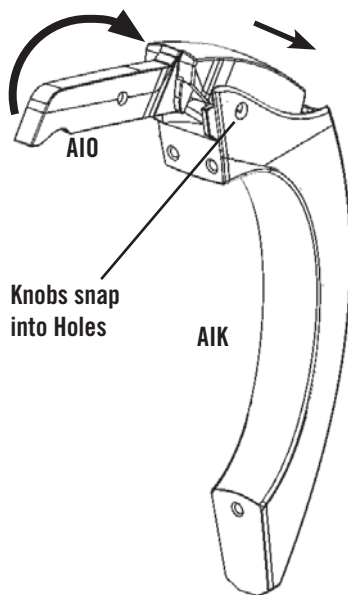



# TOOLS AND HARDWARE REQUIRED FOR THIS PAGE

SEC 6

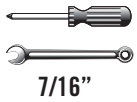

7/16"

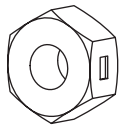

AAB (x2)

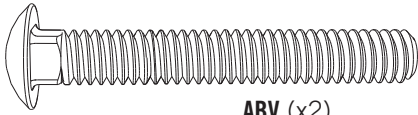

ABV (x2)

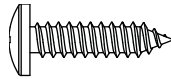

ADW (x3)

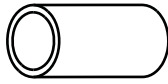

ADB (x2)

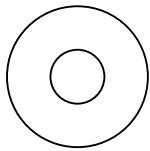

AEB (x2)

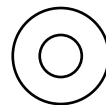

AEE (x3)

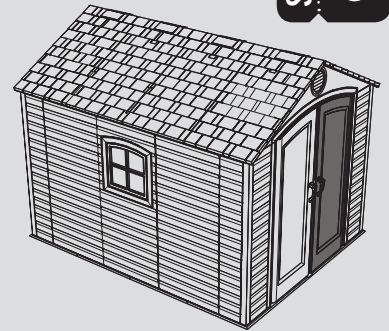

SEC

6.5

Attach the Right Handle Assembly to the Door using three (3) #10 Flat Washers (AEE) and three (3) #10 x 3/4" Pan-Head Screws (ADW).

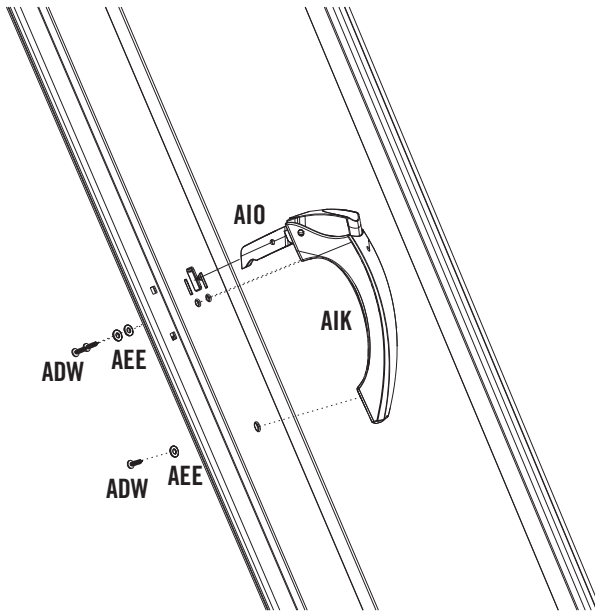

**CAUTION**

Do not overtighten. Overtightening may damage parts and void warranty.

SEC

6.6

Install Handle Latch assembly onto the Right Shed Door using the required hardware.

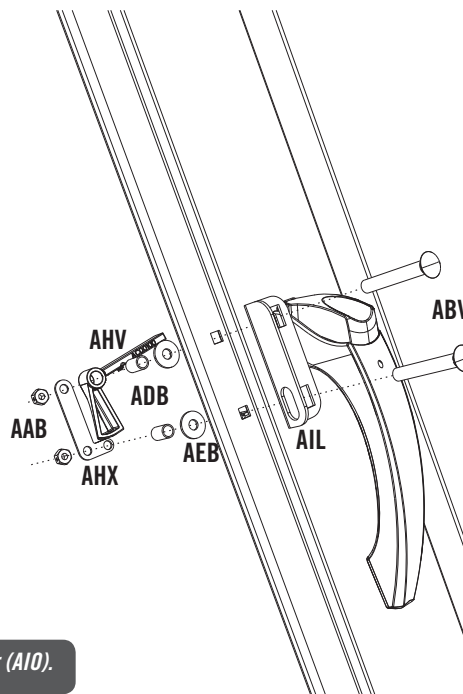
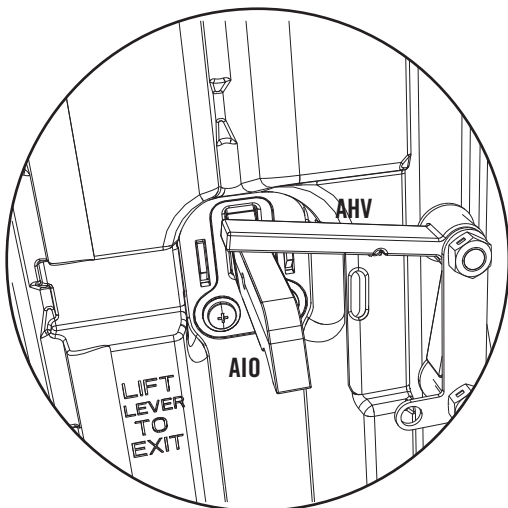

Note: The Door Latch (AHV) goes on top of the Thumb Lever (AIO).



## TOOLS AND HARDWARE REQUIRED FOR THIS PAGE

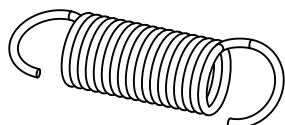

AHY (x1)

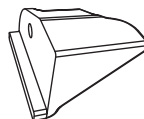

AHW (x1)



ADW (x1)

SEC 6

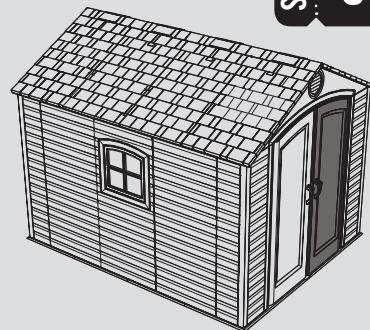

SEC

6.7

Line up the hole in the **Latch Block (AHW)** with the hole in the Thumb Lever and secure with one (1) **#10 X 3/4" Pan-Head Screw (ADW)**.

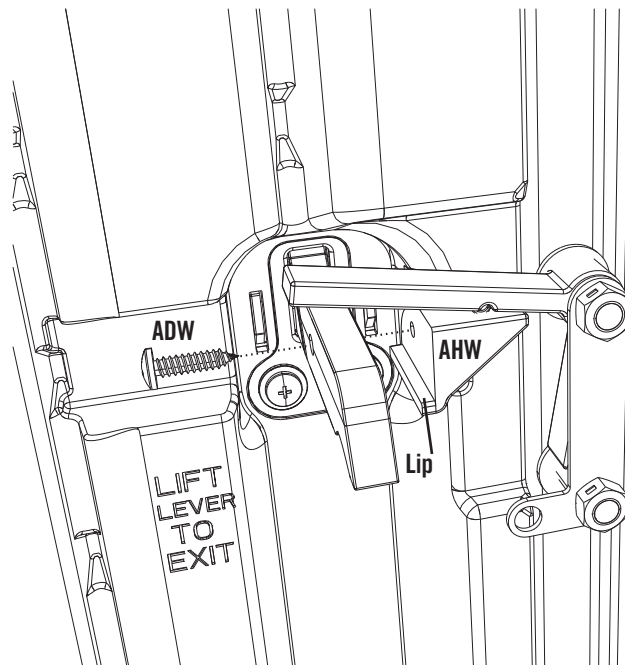

*Note: The lip of the Latch Block (AHW) fits under the Thumb Lever (A10).*

SEC

6.8

Attach **Latch Spring (AHY)** to the **Door Latch (AHV)** and the **Latch Cover Plate (AHX)**. Set the Door aside.

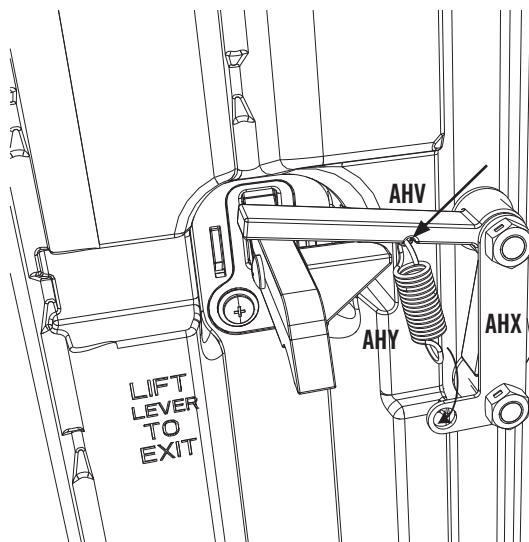

*Note: Use pliers to pull spring down and hook into bottom hole.*



### WARNING

While performing this step, each person should use protective eye glasses to help prevent serious eye injury.

# SEC 7 GABLE ASSEMBLY

## HARDWARE REQUIRED

## HARDWARE BAG REQUIRED: BHV (x2)

Hardware shown at actual size

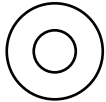

**AEE** (x10)  
#10 x 1/2" Flat Washer

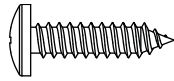

**ADW** (x10)  
#10 x 3/4" Pan-Head Screw

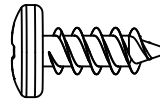

**ADZ** (x8)  
1/4" x 5/8" Pan-Head Screw  
(Only 4 used)

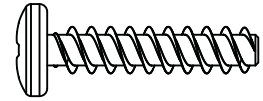

**ADV** (x12)  
1/4" x 1 1/8" Pan-Head Screw  
(Only 6 used)

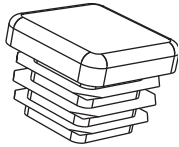

**AHS** (x4)  
End Plug  
(Only 2 used)

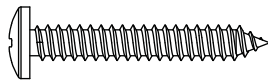

**ACB** (x2)  
#10 x 1 1/4" Pan-Head Screw  
(Not used in this model)

Parts shown at 8% of actual size

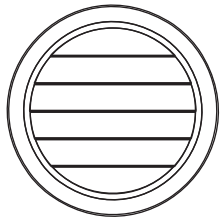

**AGP** (x2)  
Louvered Vent

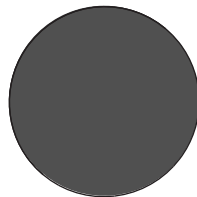

**AIQ** (x2)  
Vent Screen

## METAL PARTS REQUIRED

## METAL PARTS KITS REQUIRED: CTI

Part shown at 8% of actual size

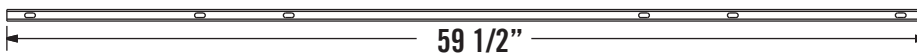

**AFE** (x1)  
Entry Header Bar

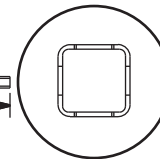

## PLASTIC PARTS REQUIRED

## LOCATED IN BOX 1

Parts shown at 4% of actual size

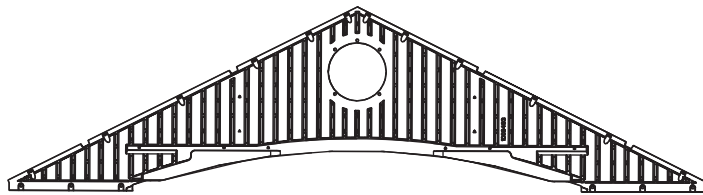

**AGF** (x1)  
Entry Gable

(Rear View)

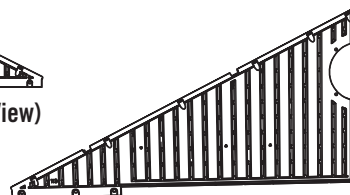

**AGH** (x1)  
Rear Gable 1

(Rear View)

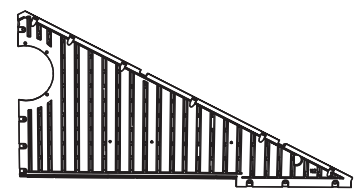

**AGI** (x1)  
Rear Gable 2

(Rear View)

## TOOLS REQUIRED



Phillips Screwdriver



Safety Glasses



## TOOLS AND HARDWARE REQUIRED FOR THIS PAGE

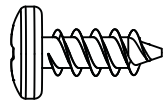

ADZ (x4)

SEC 7

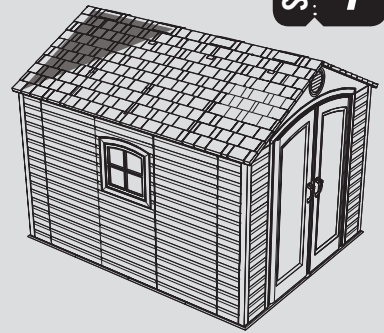

SEC

### REAR GABLE ASSEMBLY

7.1

Lay the edge of **Rear Gable 2 (AGI)** over **Rear Gable 1 (AGH)** as shown, and align the four holes.

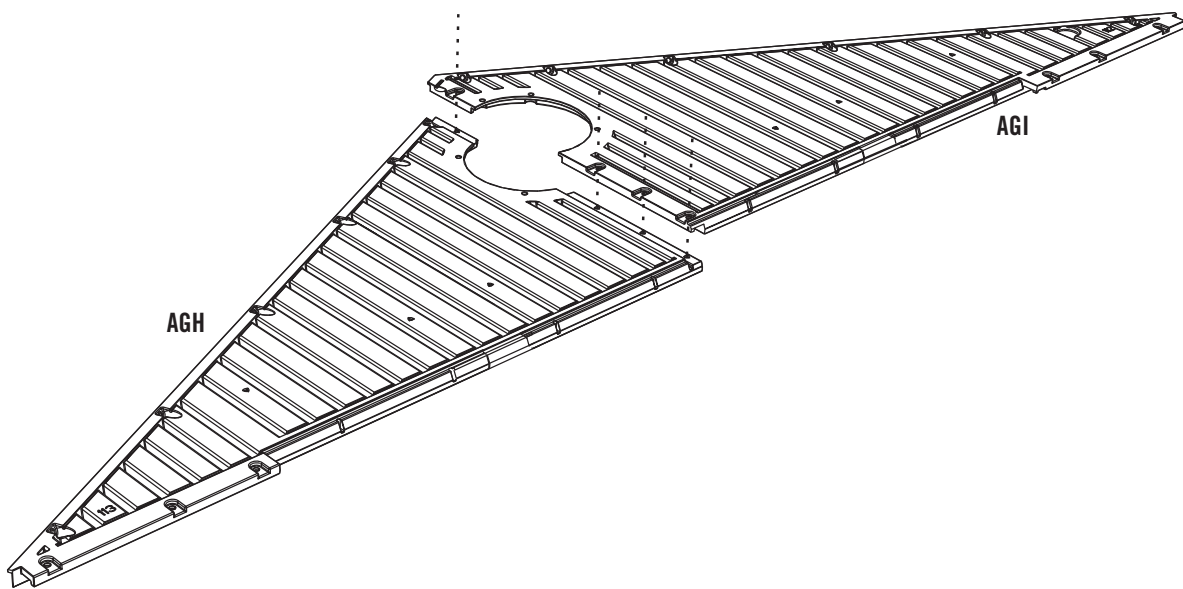

SEC

7.2

Connect Rear Gables 1 & 2 together using four (4) **1/4" x 5/8" Pan-Head Screws (ADZ)** as shown.

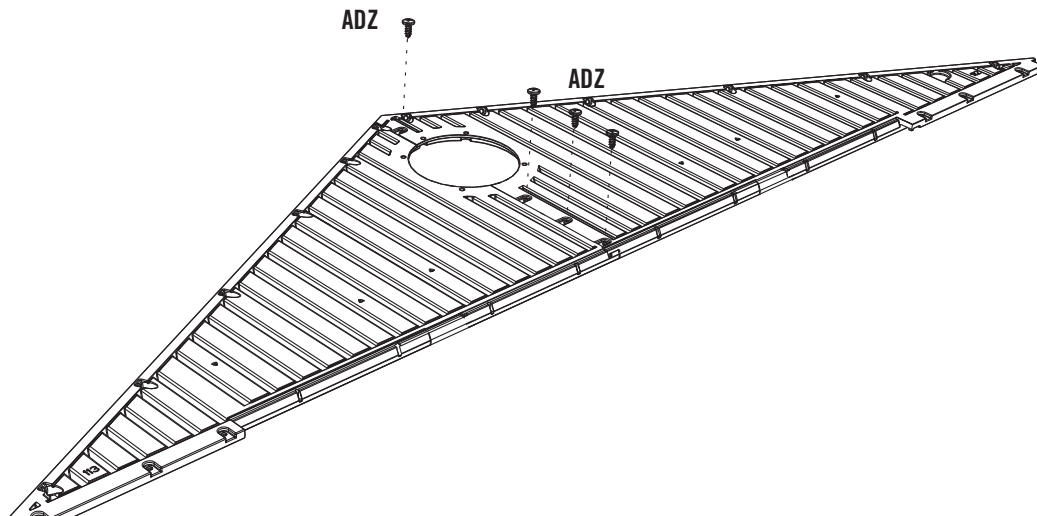

*Note: Only use a hand screwdriver in this step.*





## TOOLS AND HARDWARE REQUIRED FOR THIS PAGE

SEC 7

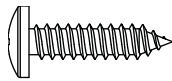

ADW (x5)

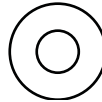

AEE (x5)

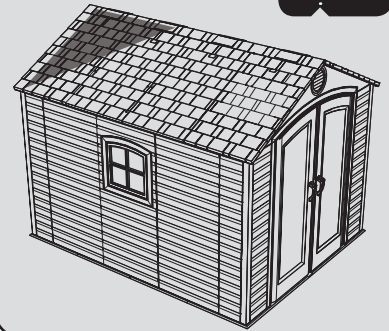

SEC

7.3

Lay Rear Gable Assembly flat on the ground over the **Vent Screen (AIQ)** and **Louvered Vent (AGP)**. Align the holes in the Louvered Vent with those in the Rear Gable Assembly.

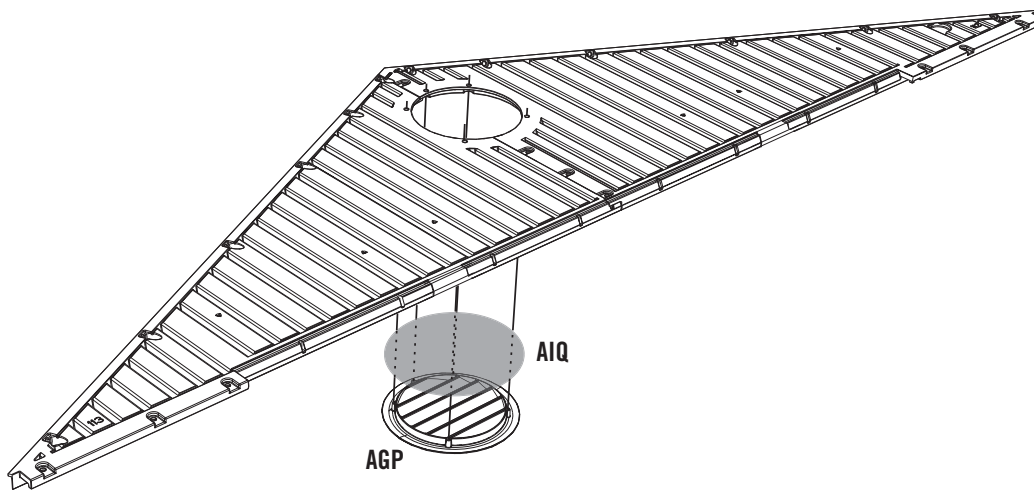

SEC

7.4

After aligning the holes, press down firmly on the Rear Gable Assembly while inserting the five (5) **#10 x 3/4" Pan-Head Screws (ADW)** and the five (5) **#10 x 1/2" Flat Washers (AEE)**. Pressing down firmly while inserting the Screws will help prevent the Vent Screen from twisting. Set aside.

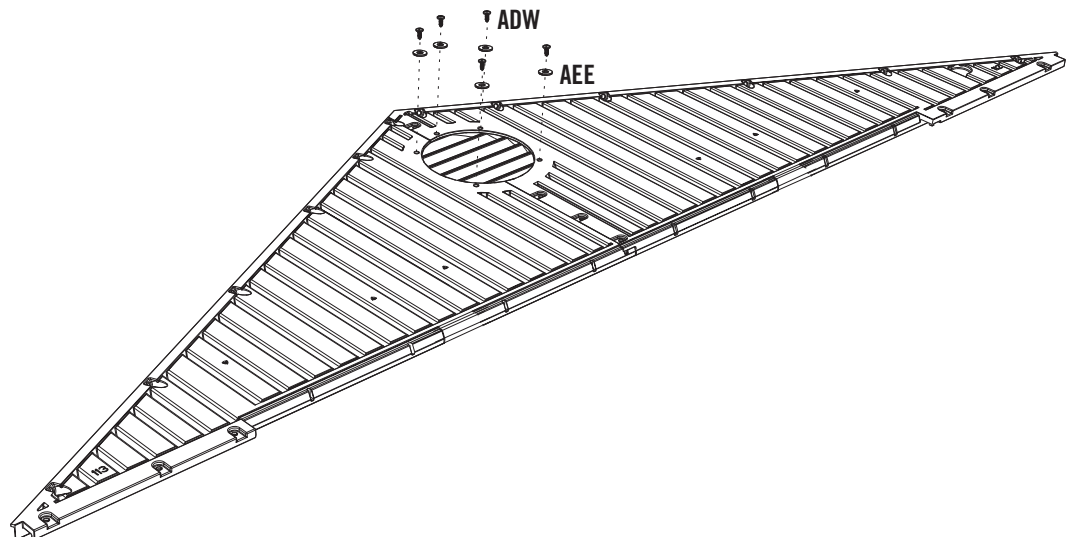

*Note: Only use a hand screwdriver in this step.*



## TOOLS AND HARDWARE REQUIRED FOR THIS PAGE

SEC 7



ADW (x5)

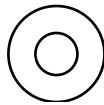

AEE (x5)

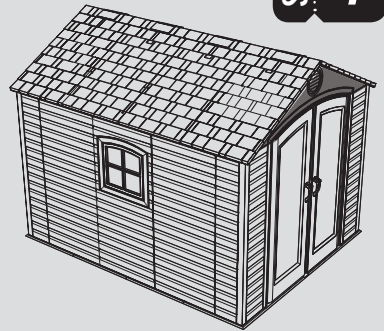

SEC

### ENTRY GABLE ASSEMBLY

7.5

Lay **Entry Gable (AGF)** flat on the ground over the **Vent Screen (AIQ)** and **Louvered Vent (AGP)** as shown. Align the holes in the Louvered Vent with those in the Entry Gable.

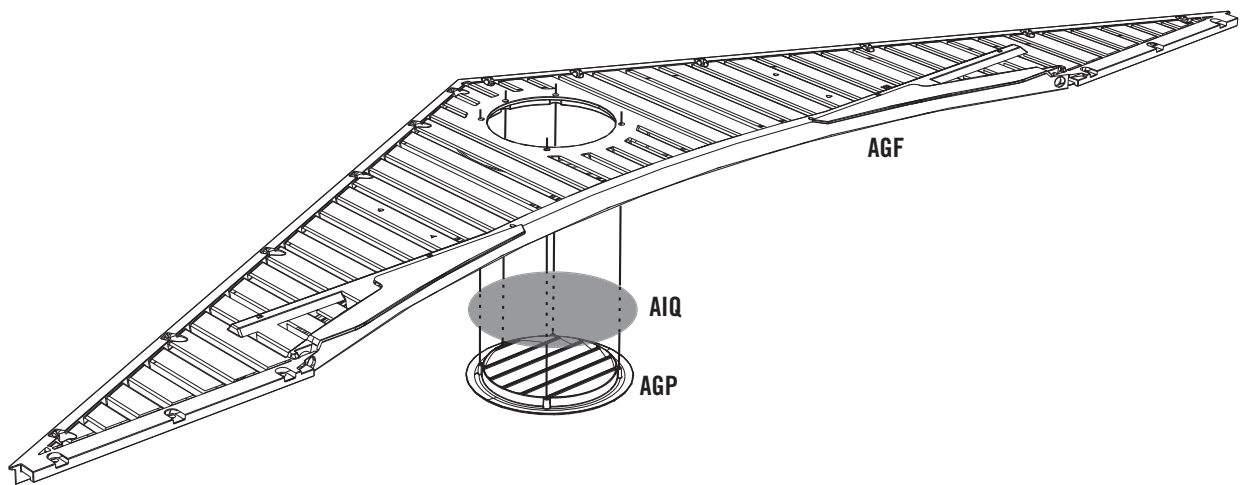

SEC

7.6

After aligning the holes, press down firmly on the Entry Gable when inserting the five (5) **#10 x 3/4" Pan-Head Screws (ADW)** and the five (5) **#10 x 1/2" Flat Washers (AEE)**. Pressing down firmly while inserting the Screws will help prevent the Vent Screen from twisting.

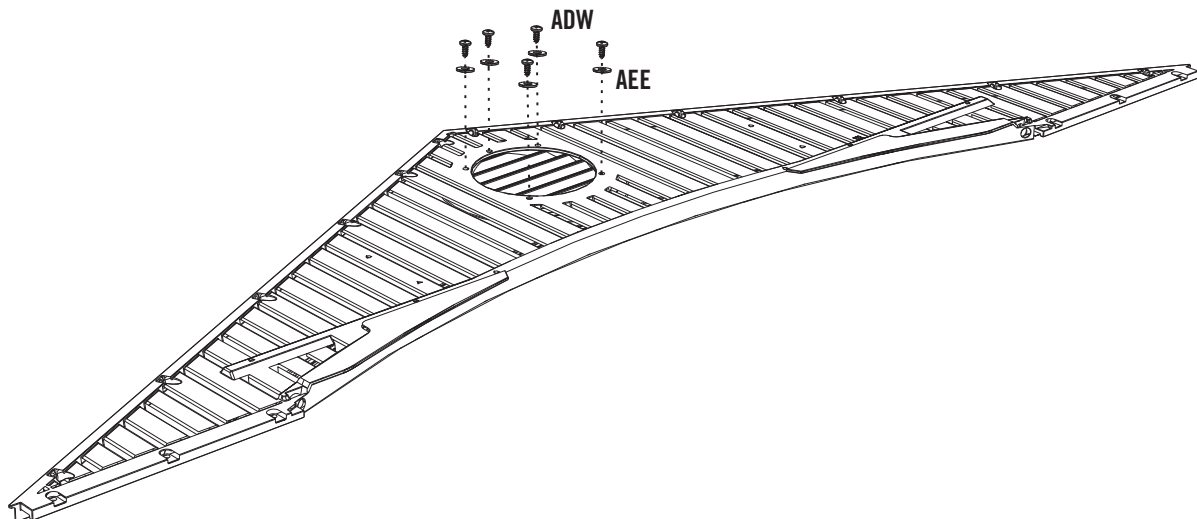

*Note: Only use a hand screwdriver in this step.*



# TOOLS AND HARDWARE REQUIRED FOR THIS PAGE

SEC 7

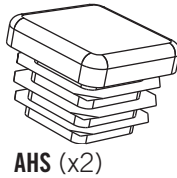

AHS (x2)

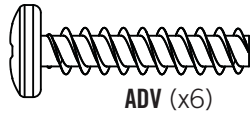

ADV (x6)

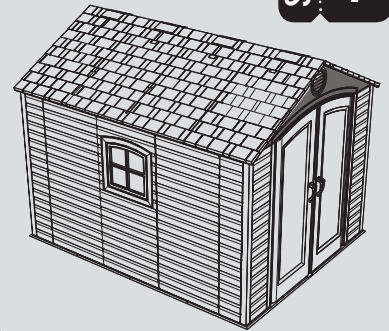

SEC

7.7

Insert an **End Plug (AHS)** into each end of **Entry Header Bar (AFE)**.

The flat screw holes should face away from the Entry Gable.

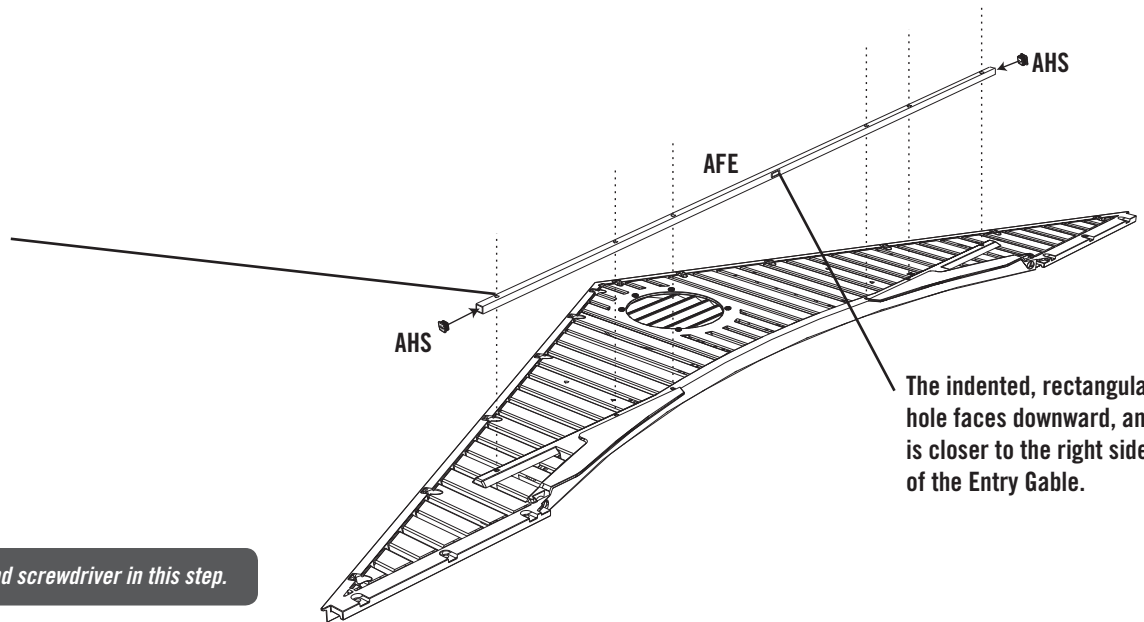

The indented, rectangular hole faces downward, and is closer to the right side of the Entry Gable.



*Note: Only use a hand screwdriver in this step.*

SEC

7.8

Attach the Entry Header Bar to the Entry Gable Assembly, and secure with six (6) 1/4" x 1 1/8" **Pan-Head Screws (ADV)**. Set aside.

The flat screw holes should face away from the Entry Gable.

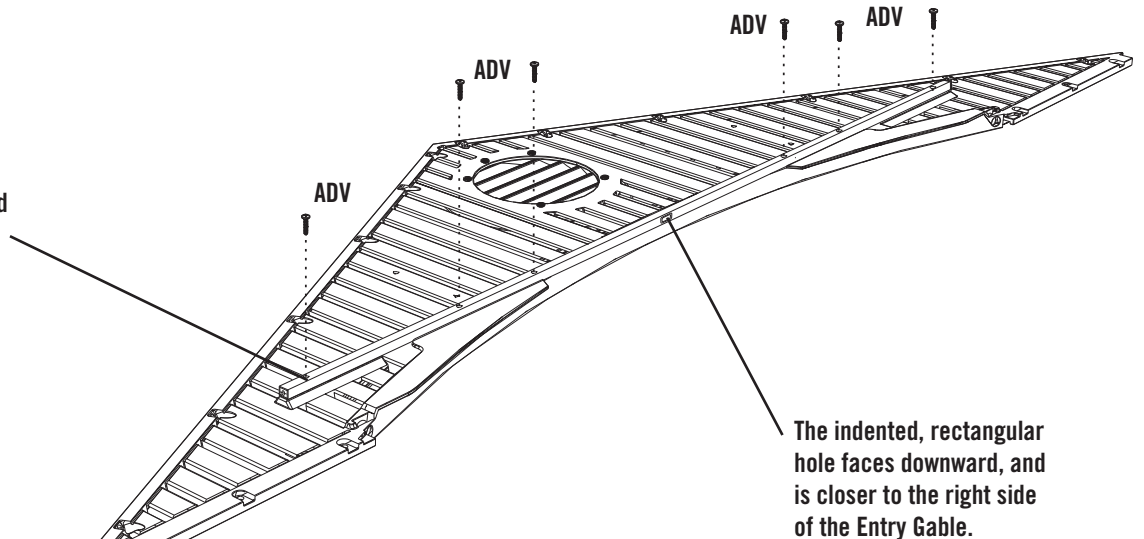

The indented, rectangular hole faces downward, and is closer to the right side of the Entry Gable.



*Note: Only use a hand screwdriver in this step.*

**SEC 8 DOOR & ENTRY GABLE INSTALLATION**

**HARDWARE REQUIRED**

Hardware shown at actual size (\*Unless noted otherwise)

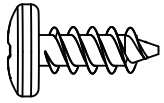

**ADZ (x6)**  
1/4" x 5/8" Pan-Head Screw

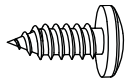

**ADX (x4)**  
#10 x 1/2" Pan-Head Screw

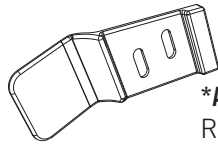

**\*AIM (x1)**  
Right Gap Flap



**AHP (x2)**  
Cotter Pin

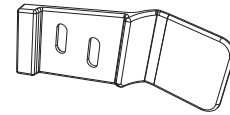

**\*AIC (x1)**  
Left Gap Flap

**HARDWARE BAG REQUIRED: BHZ**

**PLASTIC PARTS REQUIRED**

Parts shown at 4% of actual size

FROM SECTIONS 5, 6, 9, 7

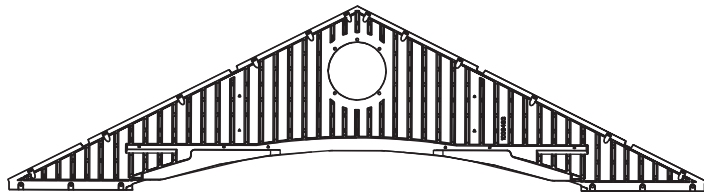

**Entry Gable Assembly** **Rear View**

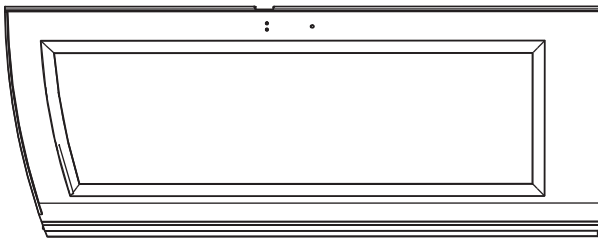

**Left Door Assembly**

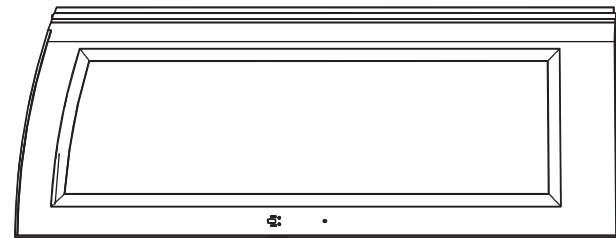

**Right Door Assembly**

**TOOLS REQUIRED**

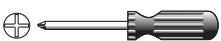

**Phillips Screwdriver**

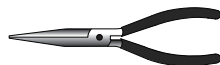

**Pliers**



**Safety Glasses**



## TOOLS AND HARDWARE REQUIRED FOR THIS PAGE

SEC 8



AHP (x2)

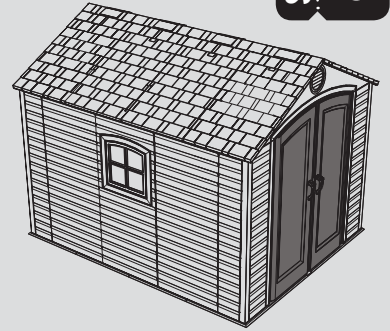

SEC

### DOOR INSTALLATION

8.1

Align the hole in the bottom of the Hinge of the **Left Door Assembly** with the hole in the Door Hinge Bushing on the Floor of your shed, and insert the Door Hinge Tube into the Door Hinge Bushing.

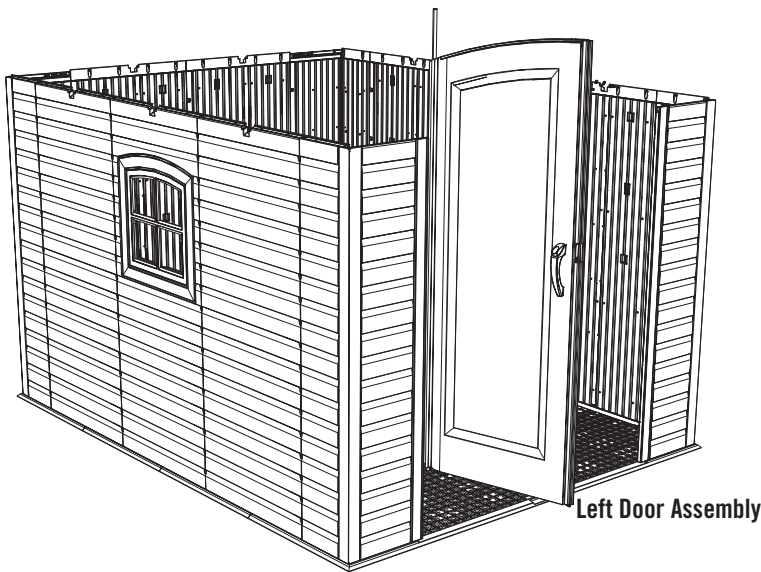

SEC

8.2

Insert a **Cotter Pin (AHP)** through the Bushing and Door Hinge. Use a pair of pliers to bend the ends of the Cotter Pins outward. **Repeat these steps for the Right Door Assembly.**

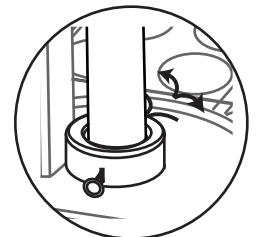
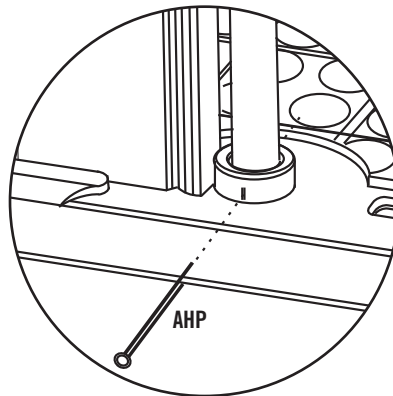
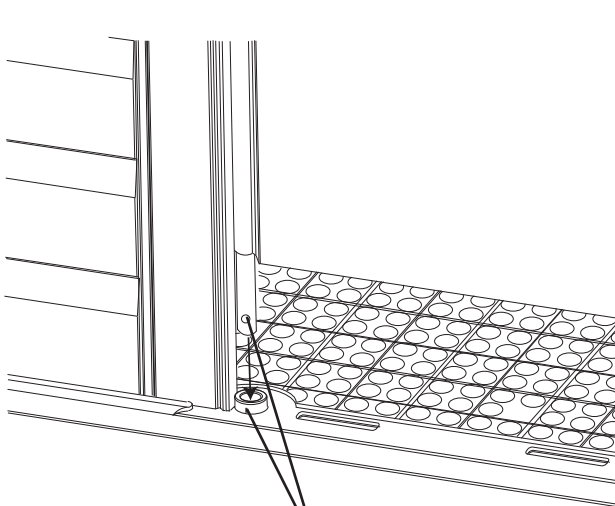

**!** Note: Use pliers to bend back the ends of the Cotter Pin (AHP).

**!** Note: Ensure that these two holes line up, so that the Cotter Pin (AHP) can be inserted.





## TOOLS AND HARDWARE REQUIRED FOR THIS PAGE

SEC 8

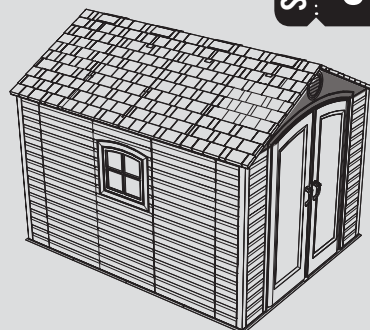
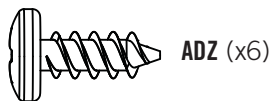

2 ADULTS REQUIRED FOR THE STEPS ON THIS PAGE

SEC

### ENTRY GABLE INSTALLATION

8.3

Slide the two holes in the **Entry Gable Assembly** down over the Door Hinge Tubes as shown.

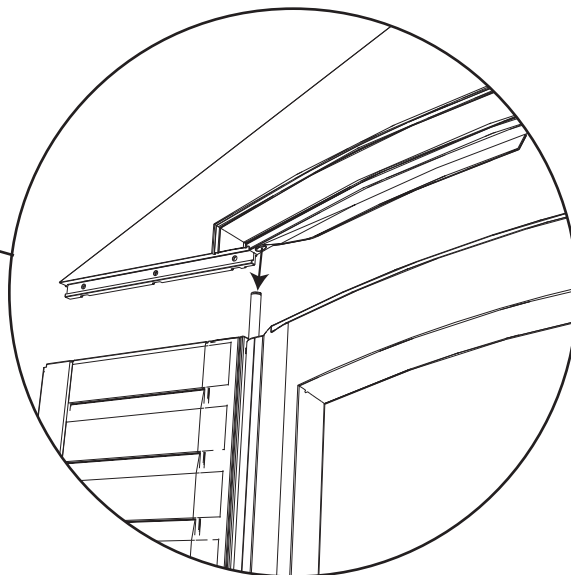
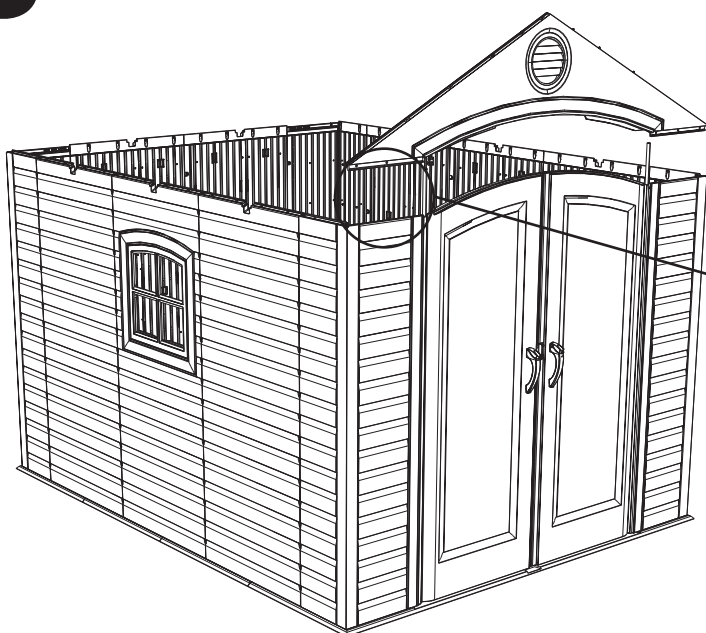

SEC

8.4

Align the holes in the sides of the Entry Gable Assembly with those in the tops of the Corner Wall Panels and secure with six (6) **1/4" x 5/8" Pan Head Screws (ADZ)** at the locations indicated.

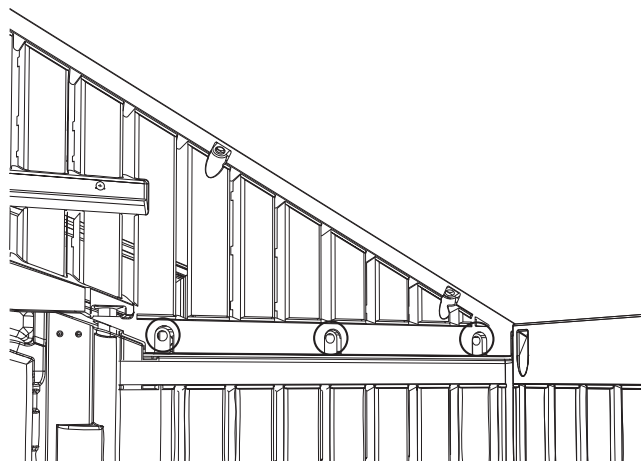
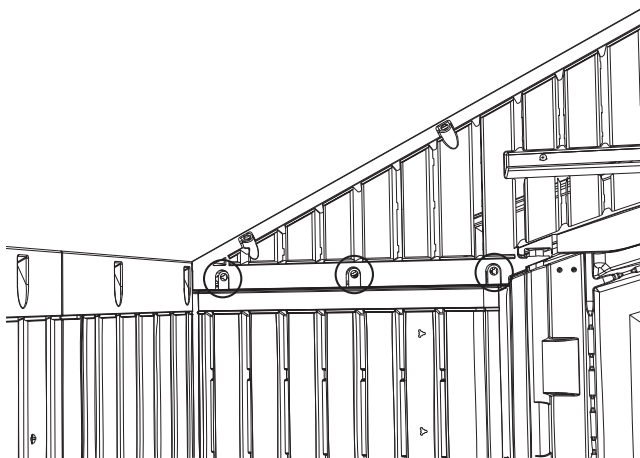





## TOOLS AND HARDWARE REQUIRED FOR THIS PAGE

SEC 8

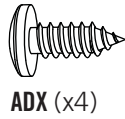

ADX (x4)

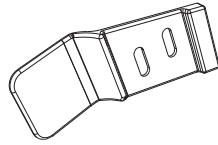

AIM (x1)  
(Not to scale)

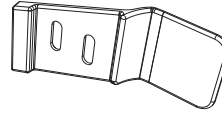

AIC (x1)  
(Not to scale)

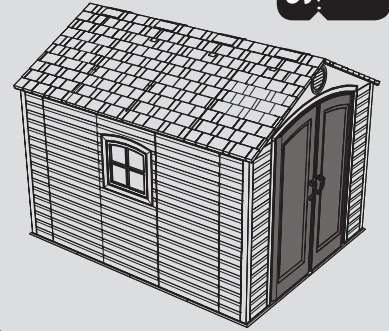

SEC

8.5

### GAP FLAP INSTALLATION

Attach the **Right & Left Gap Flaps (AIM & AIC)** to the top, right and left corners of the Doors as shown. Before completely tightening the **#10 x 1/2" Pan-Head Screws (ADX)**, slide the Gap Flaps up until they cover any gap between the tops of the Doors and the Gable.

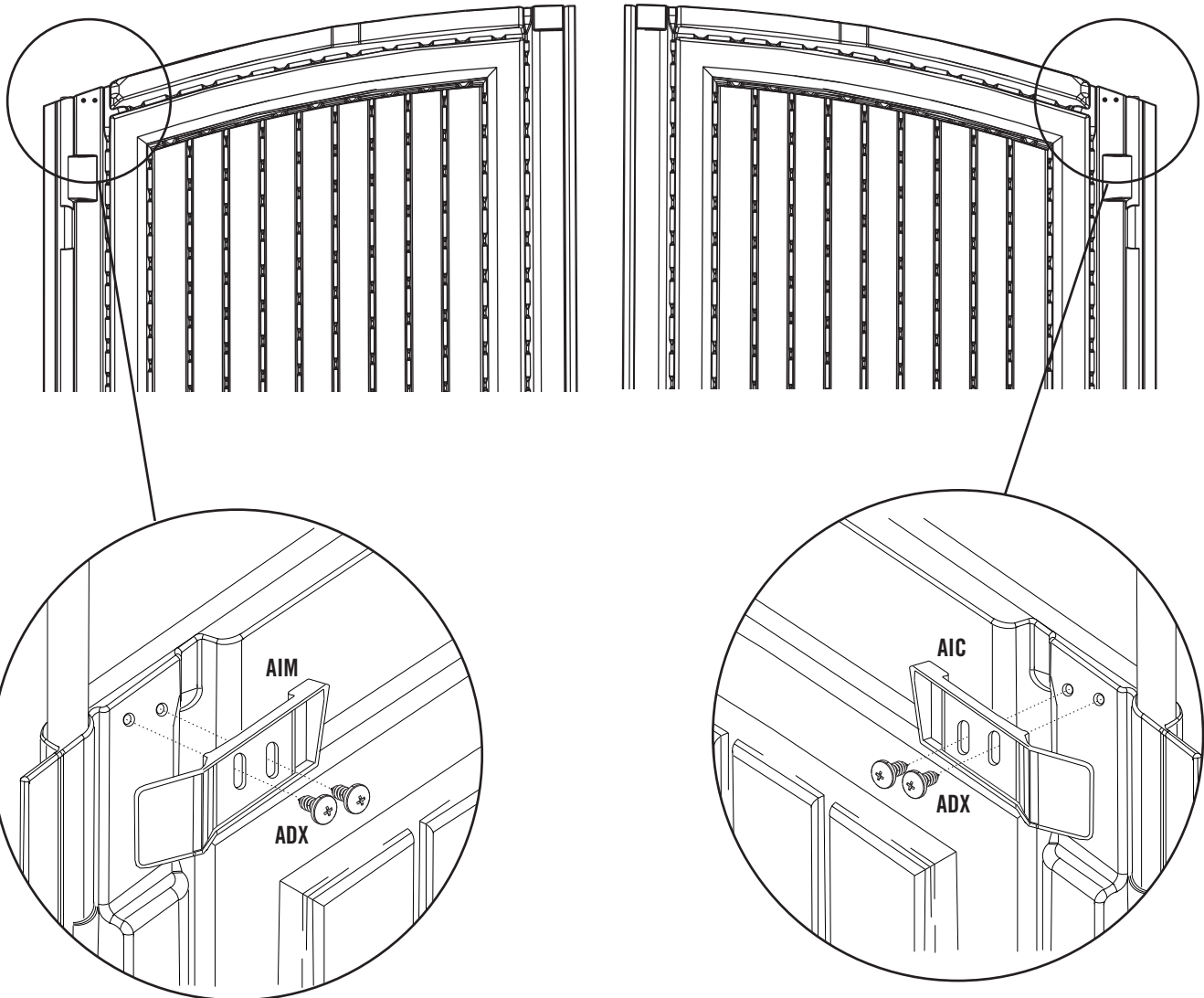

# SEC 9 TRUSS, REAR GABLE, & ROOF INSTALLATION

## HARDWARE REQUIRED

Hardware shown at actual size (\*Unless otherwise noted)

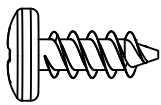

**ADZ** (x126)  
1/4" x 5/8" Pan-Head Screw  
(Not all screws will be used)

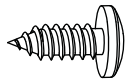

**ADX** (x24)  
#10 x 1/2" Pan-Head Screw

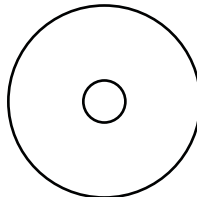

**AED** (x24)  
#10 x 1" Fender Washer

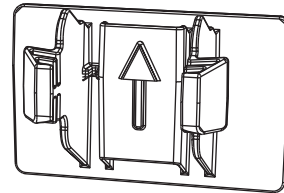

**AXX** (x2)  
Truss Hole Insert

## HARDWARE BAG REQUIRED: BHX

## METAL PARTS REQUIRED

Parts shown at 8% of actual size



**AFL** (x8)  
Roof Support Strip



*Note: The hole in the Roof Support Strip is for manufacturing purposes only.*

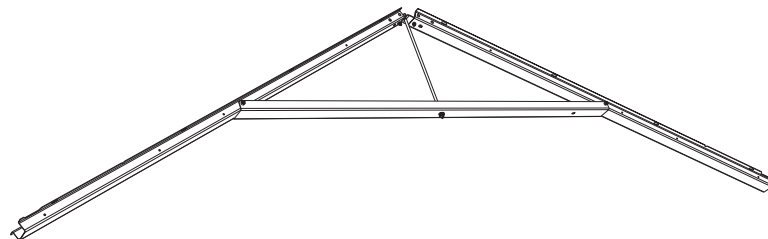

Truss Assembly (x3)

## SMALL PARTS KIT REQUIRED: BDX

## PLASTIC PARTS REQUIRED

Parts shown at 4% of actual size

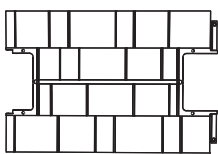

**AFY** (x3)  
Center Roof Cap

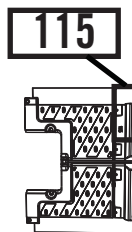

**AGG** (x1)  
Front Roof Cap

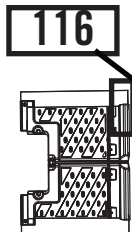

**AFW** (x1)  
Rear Roof Cap

Parts shown at 8% of actual size

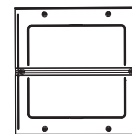

**AHC** (x4)  
Skylight

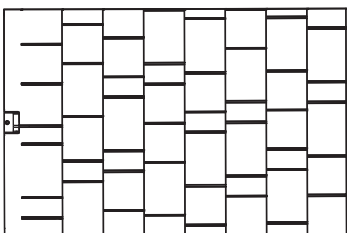

**\*AGQ** (x8)  
Roof Panel

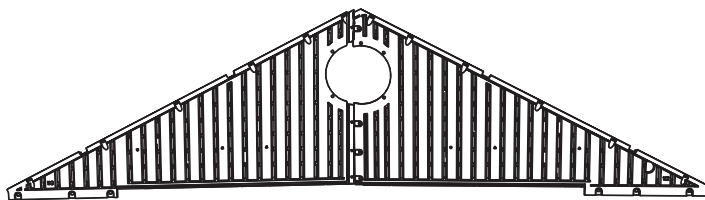

Rear Gable Assembly

## TOOLS REQUIRED



Phillips Screwdriver

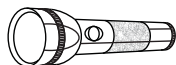

Flashlight



Safety Glasses



## TOOLS AND HARDWARE REQUIRED FOR THIS PAGE



NO HARDWARE REQUIRED FOR THIS STEP

SEC 9

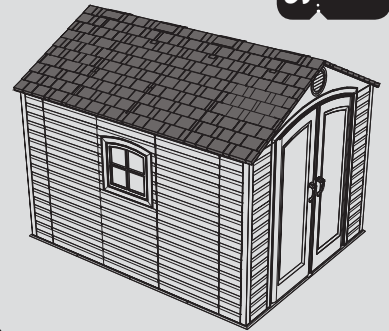

3 ADULTS REQUIRED FOR STEPS 10.1 - 10.8

SEC

### TRUSS & ROOF INSTALLATION

9.1

Place the ends of a **Truss Assembly** into the notches on the Wall Panels as shown. While one adult holds the Truss Assembly in place, set a **Roof Panel (AGQ)** onto the Truss Assembly and Front Gable. The edge of the Roof Panel fits down inside the Truss Channel.

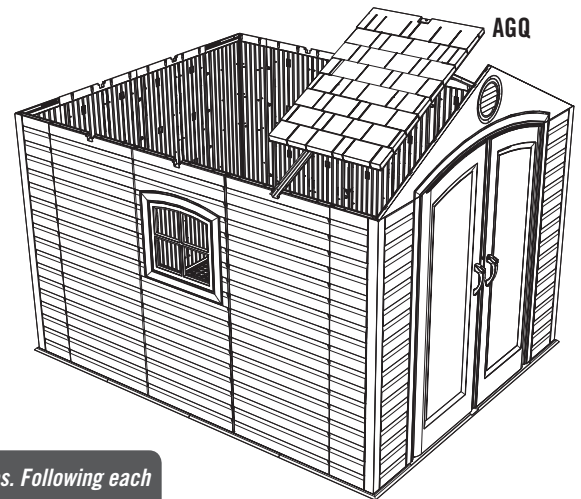
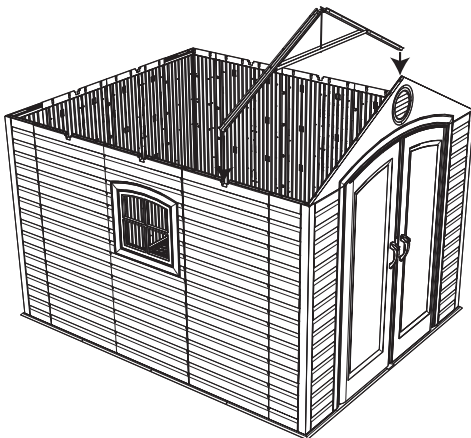

*Note: Ensure to carefully read and follow the roof installation instructions and notes. Following each step in the order listed will minimize potential complications during installation.*

SEC

9.2

Ensure the alignment nub in the Roof Panel fits into the notch on the Truss (this helps to align the holes in the Roof Panel with those in the Truss, the Wall Panel, and Gable).

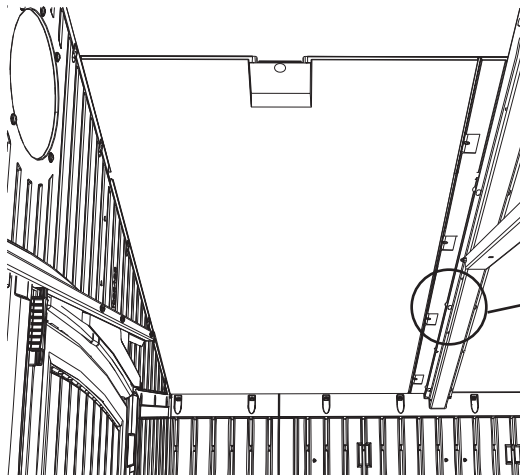

Interior Upward View

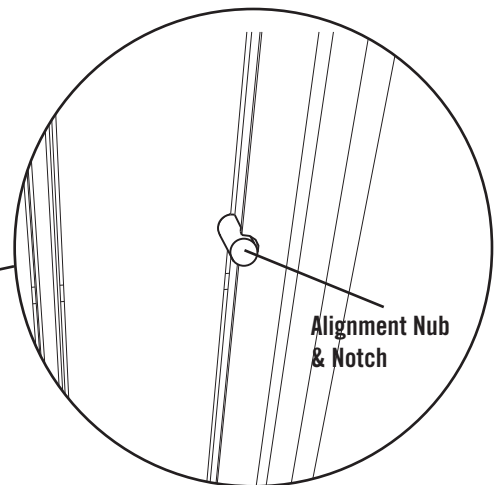

Alignment Nub & Notch



*Note: The edge of the Roof Panel fits into the Truss Assembly.*



## TOOLS AND HARDWARE REQUIRED FOR THIS PAGE



(Not actual size) **AFL** (x2)

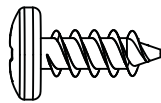

**ADZ** (x22)

SEC. 9

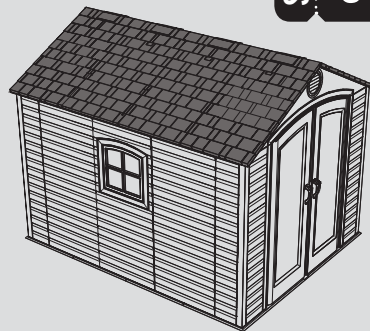

SEC

9.3

With the Roof Panel in position between the Gable and Truss, slide one (1) **Roof Support Strip (AFL)** into place within the notches of the Roof Panel. The bottom lip of the Roof Panel fits over the Wall Panel. The top of the Wall Panel fits into the groove near the bottom of the Roof Panel.

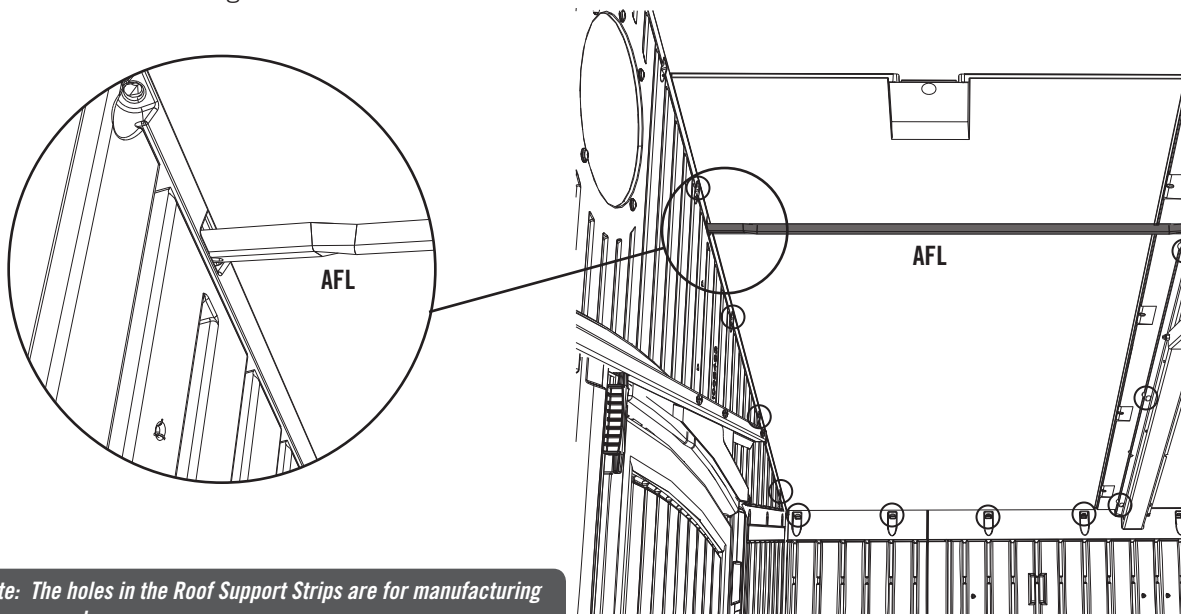

Interior Upward View



*Note: The holes in the Roof Support Strips are for manufacturing purposes only.*

SEC

9.4

After aligning the holes in the Roof Panel with those in the Wall Panels, Truss, and Gable, secure the Roof Panel to the shed using the required hardware. Then, secure a second **Roof Panel (AGQ)** and one (1) **Roof Support Strip (AFL)** to the right, front side of the shed.

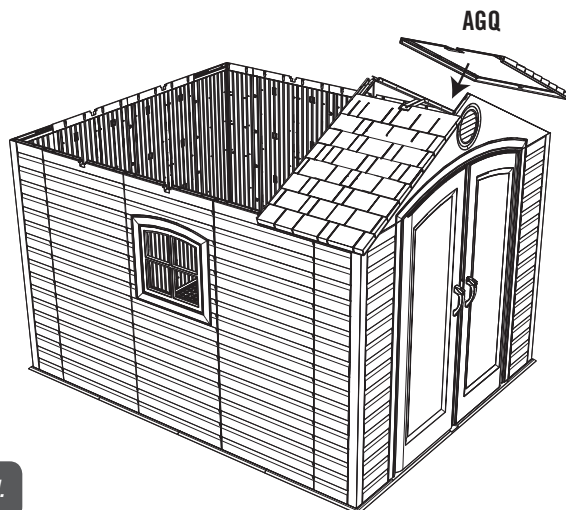

*Note: Ensure the ridge in the bottom of the Roof Panel fits into the top of the wall.*





## TOOLS AND HARDWARE REQUIRED FOR THIS PAGE



(Not actual size) **AFL** (x2)

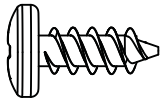

**ADZ** (x20)

**SEC 9**

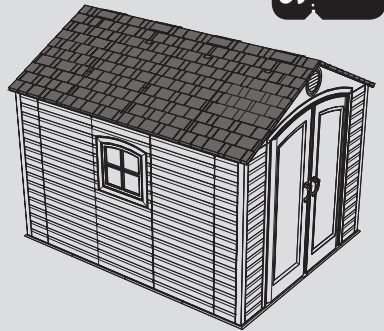

**SEC**

**9.5**

Place the ends of a second **Truss Assembly** into the notches on the next Wall Panel and Window Wall Panel as shown.

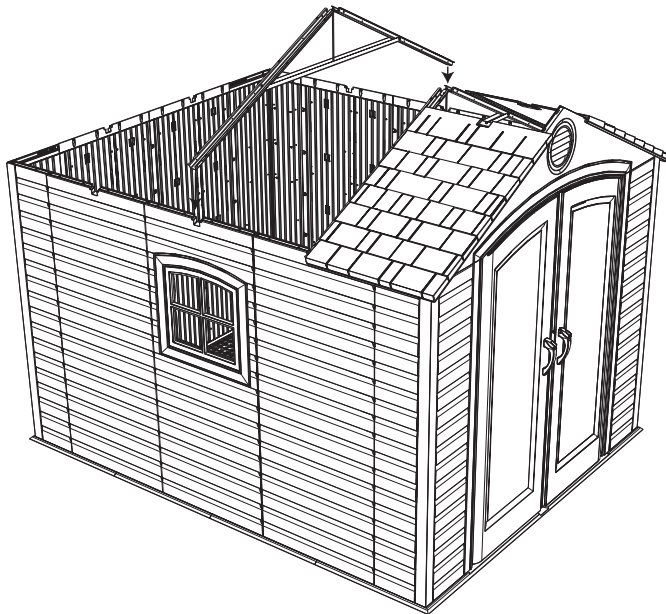

**SEC**

**9.6**

While one adult holds the Truss Assembly in place, attach two more **Roof Panels (AGQ)** and **Roof Support Strips (AFL)** into the Truss Assemblies as shown. The edge of the Roof Panels fit down inside the Truss Channels. Ensure the alignment nubs in the Roof Panels fit into the notches on the Trusses.

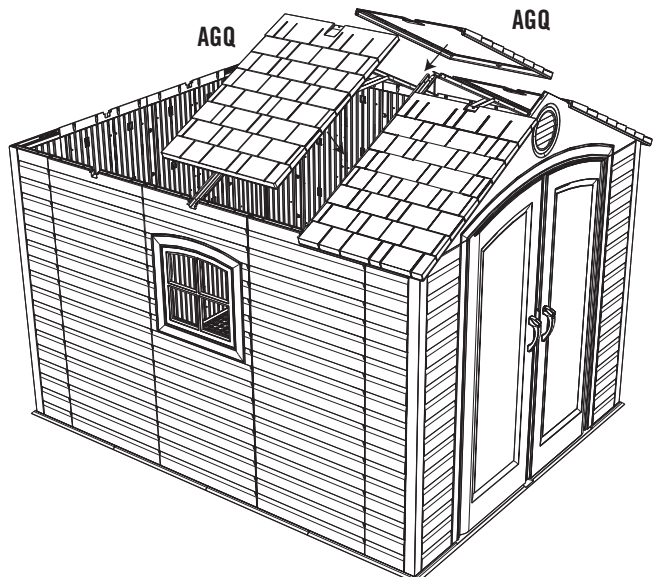



## TOOLS AND HARDWARE REQUIRED FOR THIS PAGE



(Not actual size) **AFL** (x2)



**ADZ** (x20)

SEC 9

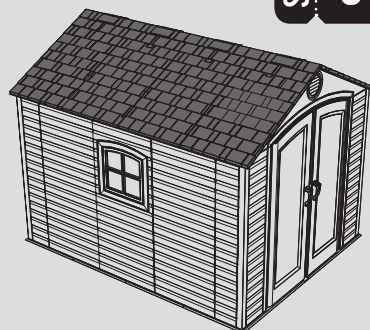

SEC 9.3

Place the ends of the last **Truss Assembly** into the notches on the next set of **Wall Panels** as shown.

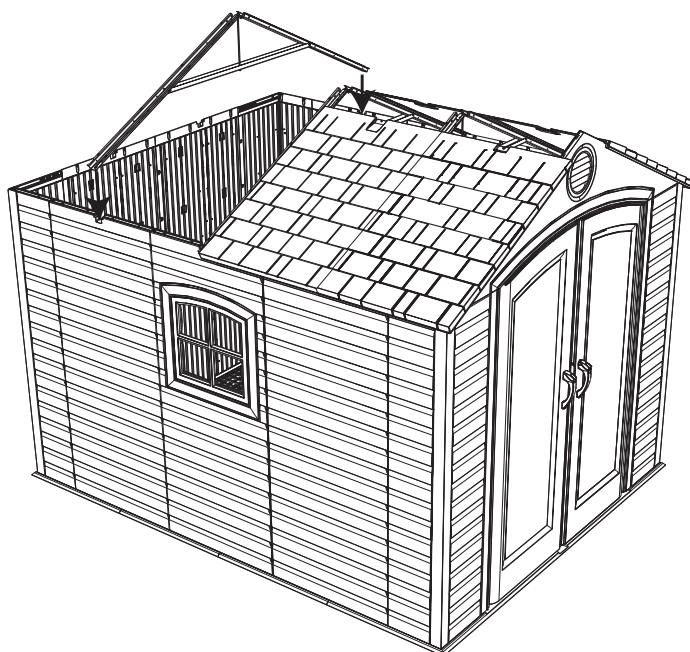

SEC 9.4

While one adult holds the **Truss Assembly** in place, attach two more **Roof Panels (AGQ)** and **Roof Support Strips (AFL)** into the **Truss Assembly** as shown. The edge of the **Roof Panels** fit down inside the **Truss Channels**. Ensure the alignment nubs in the **Roof Panels** fit into the notches on the **Trusses**.

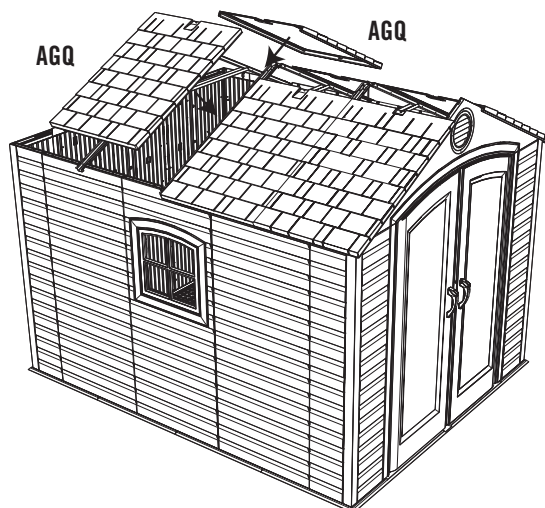





## TOOLS AND HARDWARE REQUIRED FOR THIS PAGE



(Not actual size) **AFL** (x2)

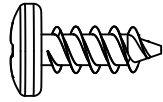

**ADZ** (x36)

**SEC 9**

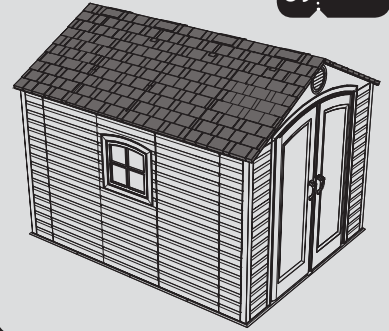

**SEC**

**9.7**

Attach the Rear Gable Assembly to the shed as shown and secure with fourteen (14) 1/4" x 5/8" Pan-Head Screws (ADZ).

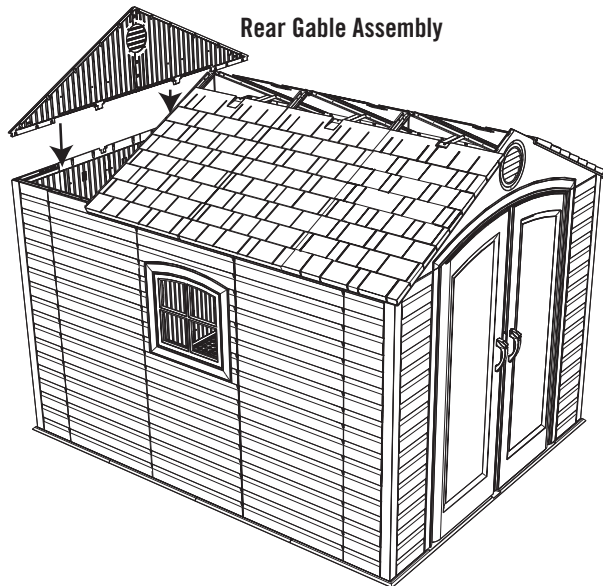

**SEC**

**9.8**

Secure the last two **Roof Panels (AGQ)** onto the Truss and Rear Gable Assemblies using the required hardware. The edge of the Roof Panels fit down inside the Truss Channels. Ensure the alignment nubs in the Roof Panels fit into notches on the Trusses.

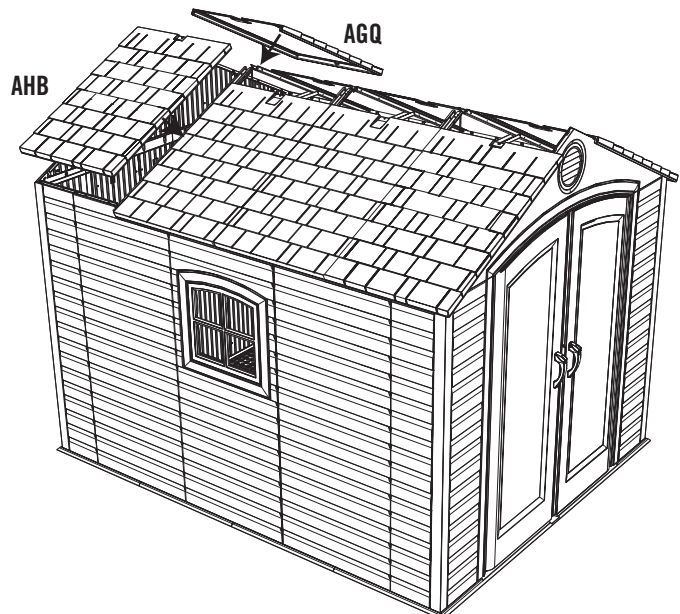



## TOOLS AND HARDWARE REQUIRED FOR THIS PAGE

SEC 9

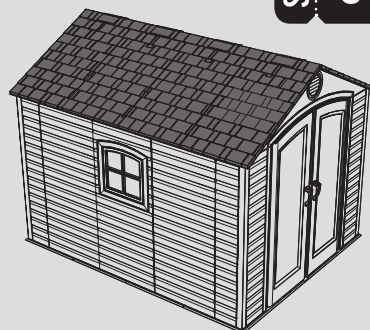

2 ADULTS REQUIRED FOR STEP 10.9 - 10.10

SEC

9.9

### ROOF CAP INSTALLATION

Starting at the front side of your shed, attach the **Front Roof Cap (AGG)** to the Roof Panels and Entry Gable. Continue moving to the rear attaching the **Center Roof Caps (AFY)**. Finally, attach the **Rear Roof Cap (AFW)** to the Roof Panels and Rear Gable.



*Note: Use only a hand screwdriver for this step.*

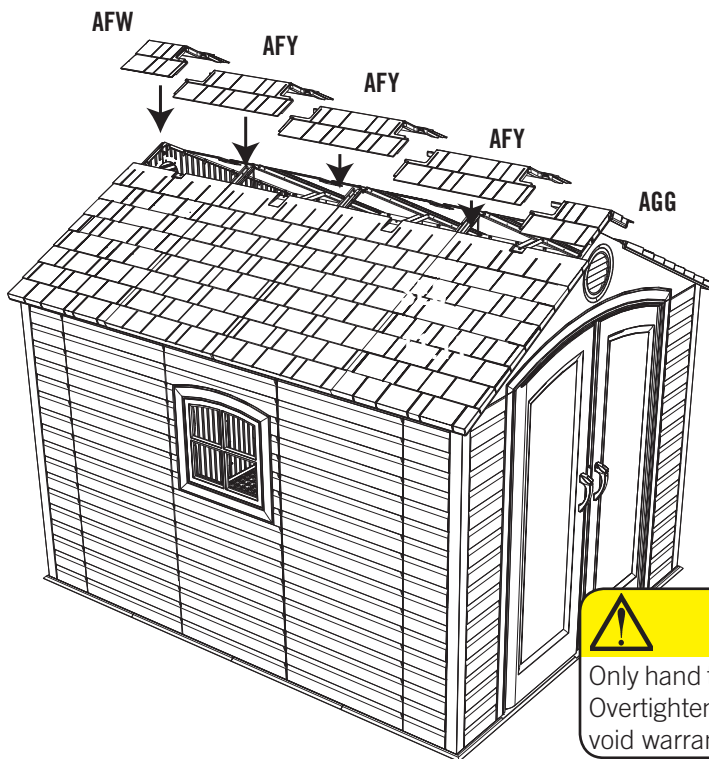

### CAUTION

Only hand tighten screws. Do not overtighten. Overtightening may damage plastic parts and void warranty.

SEC

9.10

Connect the Roof Caps to each other using two (2) 1/4" x 5/8" Pan-Head Screws (ADZ). Repeat this step for all Roof Caps.

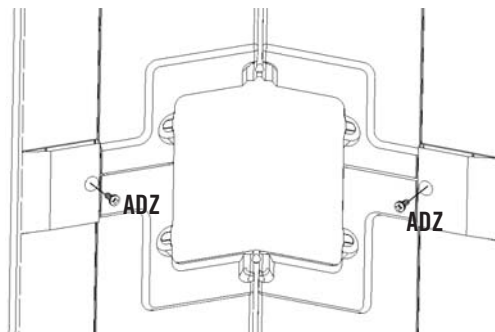



## TOOLS AND HARDWARE REQUIRED FOR THIS PAGE

SEC 9

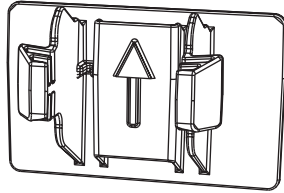

AXX (x2)  
(Not to scale)

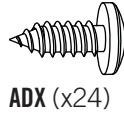

ADX (x24)

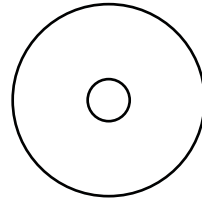

AED (x24)

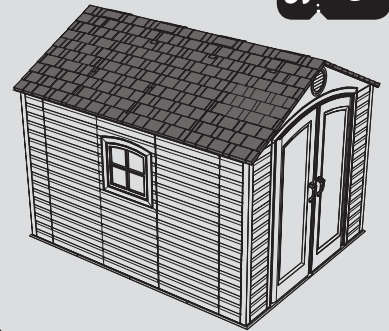

SEC

9.11

### SKYLIGHT INSTALLATION

Pre-fold **Skylight (AHC)** before installing. Push folded Skylight up through opening between Roof Caps; open Skylight; use tabs to pull Skylight down into place. Fasten Skylight in place with six (6) **#10 x 1" Fender Washers (AED)** and six (6) **#10 x 1/2" Pan-Head Screws (ADX)** (pull down on tabs while inserting screws to provide resistance). Repeat this step for each Skylight.

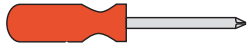

*Note: Use only a hand screwdriver for this step.*

AHC

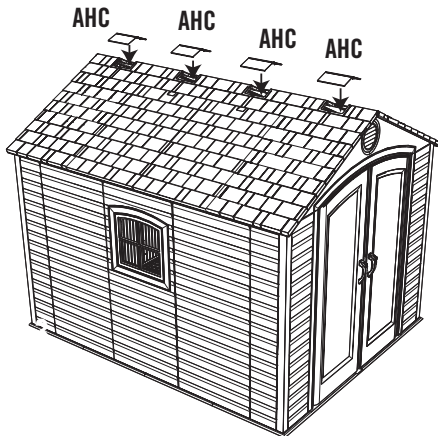
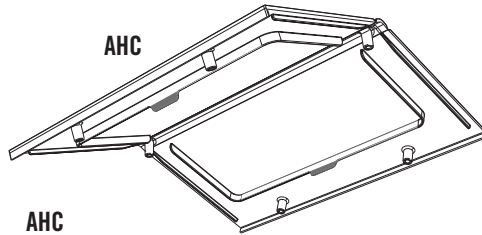

Pull down on tabs while inserting screws.

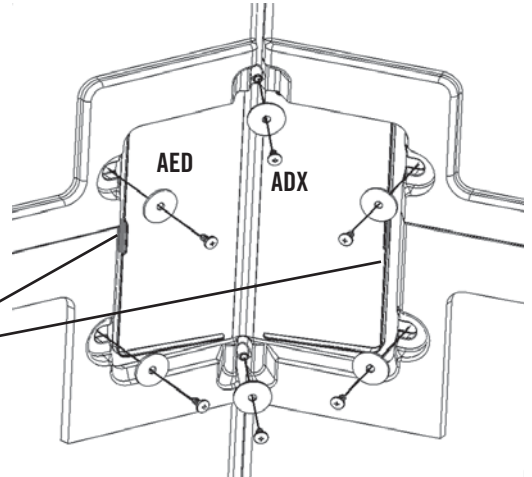

SEC

9.12

### GABLE CLIP INSERTION

Insert the **Truss Hole Inserts (AXX)** between the rear Gable and the rear Wall of the Shed as shown.

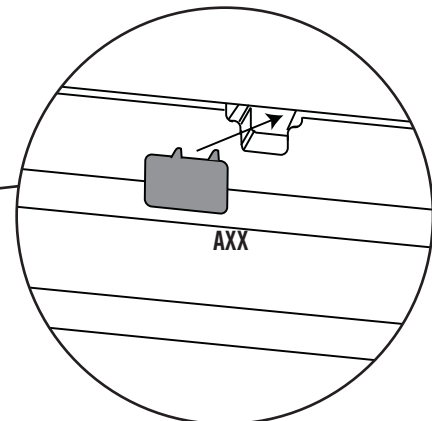
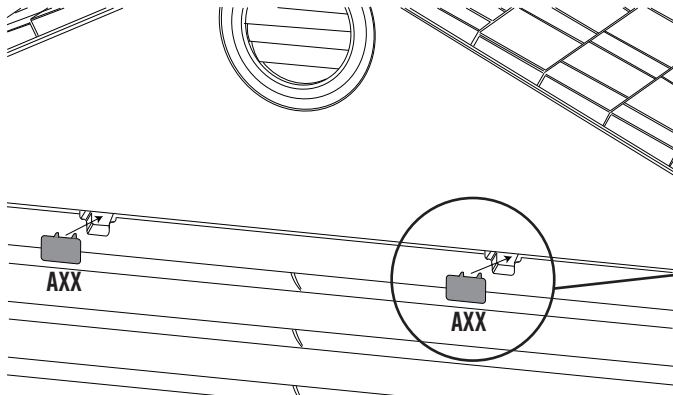

*Note: Gable Clip can only be inserted with the arrow pointing up.*

# SEC 10 SHELF INSTALLATION

## HARDWARE REQUIRED

## HARDWARE BAG REQUIRED: BHH, BHI (x6)

Hardware shown at actual size

Parts shown at 15% of actual size

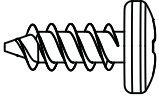

**ADZ** (x14)  
1/4" x 5/8" Pan-Head Screw



**AIY** (x2)  
Shelf Support Bracket

Hardware shown at actual size

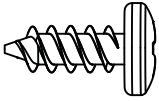

**ADZ** (x24)  
1/4" x 5/8" Pan-Head Screw

## METAL PARTS REQUIRED

## METAL PARTS KIT REQUIRED: CTI

Parts shown at 8% of actual size

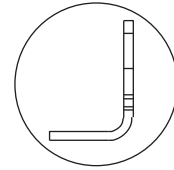
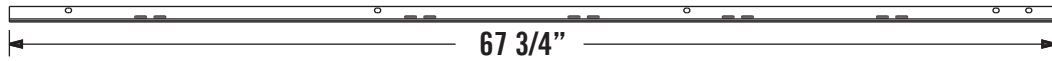

**AFM** (x2)  
Wall/Shelf Support Channel

## PLASTIC PARTS REQUIRED

## LOCATED IN BOX 1 & SMALL PARTS KIT: BDX

Part shown at 4% of actual size

Part shown at 8% of actual size



**AFV** (x1)  
90" Shelf

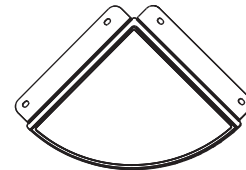

**AFZ** (x6)  
Corner Shelf

## TOOLS REQUIRED



Phillips Screwdriver



Safety Glasses





## TOOLS AND HARDWARE REQUIRED FOR THIS PAGE

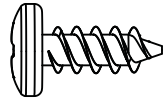

ADZ (x8)

SEC 10

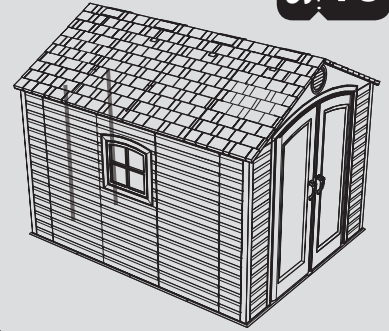

SEC

10.1

### WALL/SHELF SUPPORT CHANNEL INSTALLATION

Insert a **Shelf Support Channel (AFM)** into the slots in the Wall Panels directly below the Right Truss notch, and secure with four (4) **1/4" x 5/8" Pan-Head Screws (ADZ)**. Insert a second Shelf Support Channel in the slot directly to the right of the Left Truss Notch and secure with four (4) **1/4" x 5/8" Pan-Head Screws**.

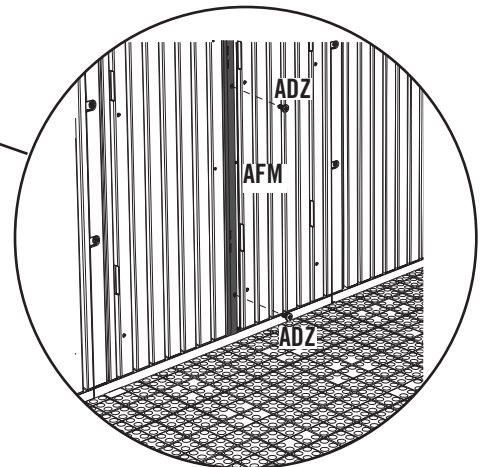
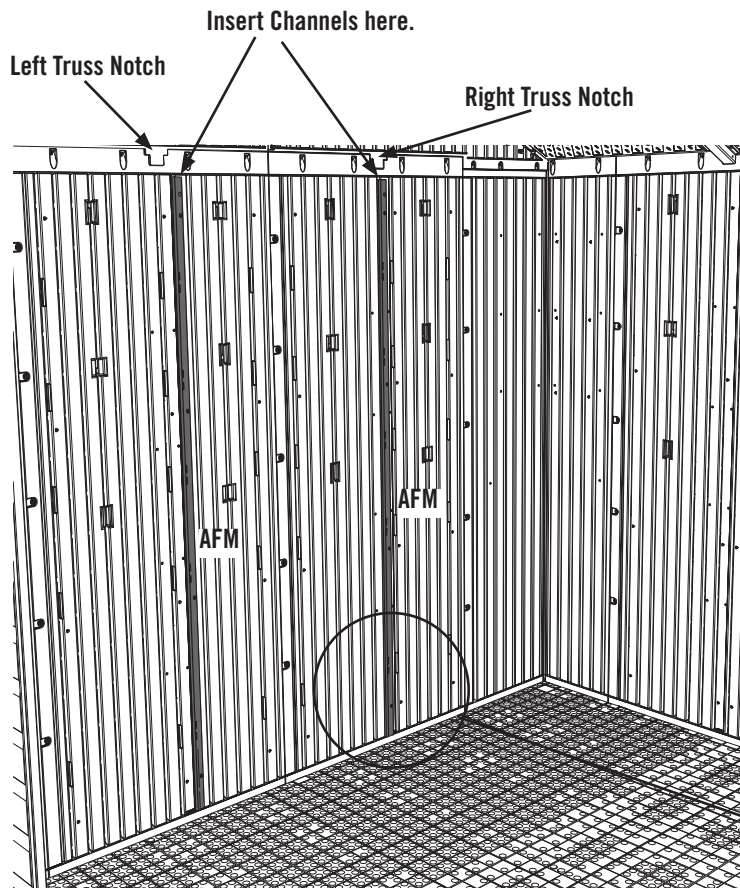



## TOOLS AND HARDWARE REQUIRED FOR THIS PAGE

SEC 10

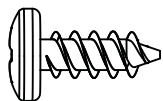

ADZ (x6)

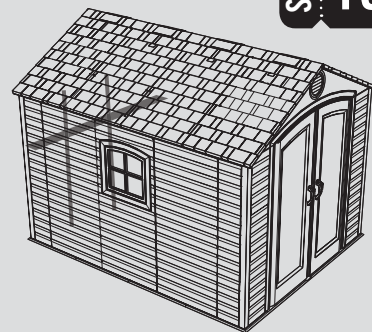

SEC

### 90" SHELF INSTALLATION

10.2

Set a **Shelf Support Bracket (AIY)** into the slots of each of the Shelf Support Channels. The slots must be at the same height.

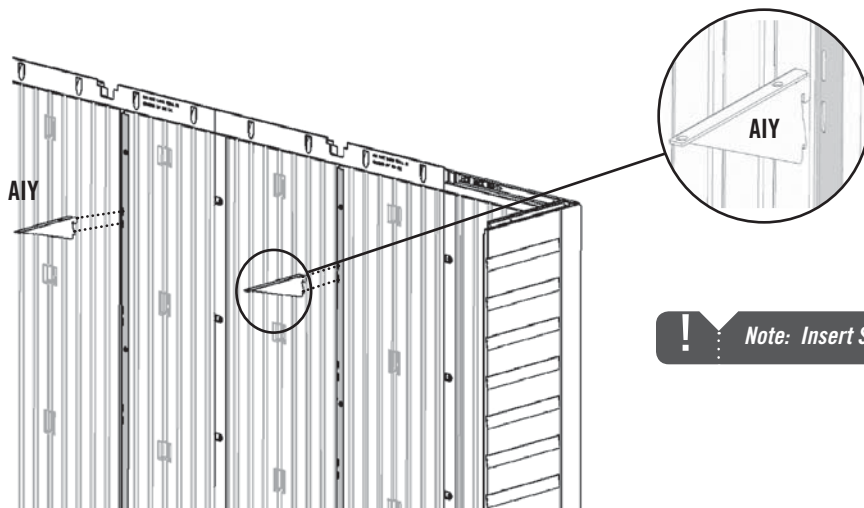

*Note: Insert Shelf Support Bracket at an angle.*

SEC

10.3

Fold up flaps on the end of **90" Shelf (AFV)**. Set Shelf on Brackets with indentations toward wall, and secure with six (6) **1/4" x 5/8" Phillips Pan-Head Screws (ADZ)**.

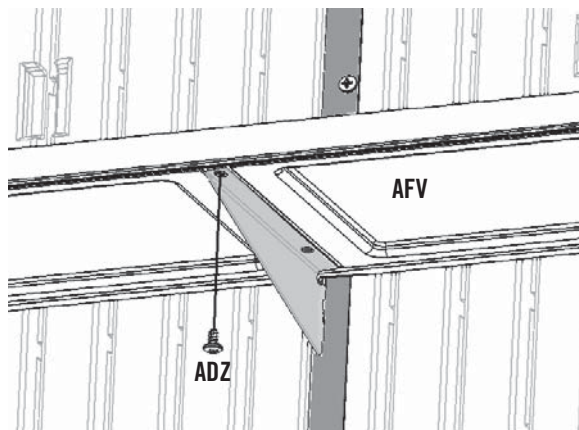

Upward view

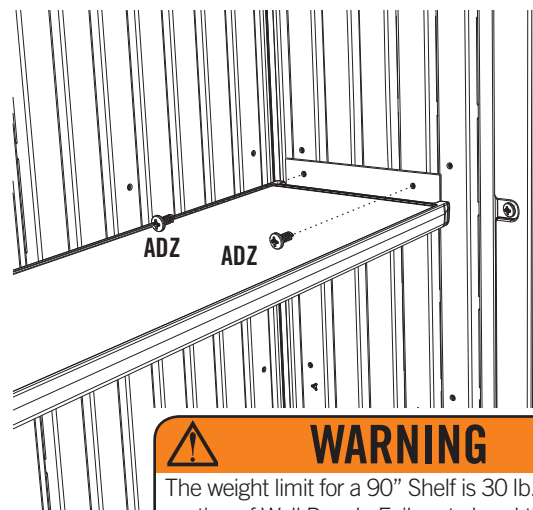

### WARNING

The weight limit for a 90" Shelf is 30 lb. per 30" section of Wall Panel. Failure to heed this warning could result in property damage and/or personal injury.



*Note: There are only holes for screws along front side of the Shelf (front is labeled "Front" on underside of Shelf).*





## TOOLS AND HARDWARE REQUIRED FOR THIS PAGE

SEC. 10

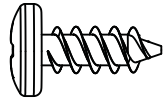

ADZ (x24)

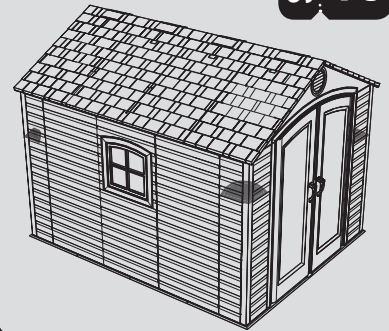

SEC

### CORNER SHELF INSTALLATION

10.4

Fold up edges of a **Corner Shelf (AFZ)**. Line-up holes in the Corner Shelf with a set of pre-made holes in any Corner Panel as shown. Secure with four (4) **1/4" x 5/8" Phillips Pan-Head Screws (ADZ)**. Repeat this step for the rest of the **Corner Shelves**.

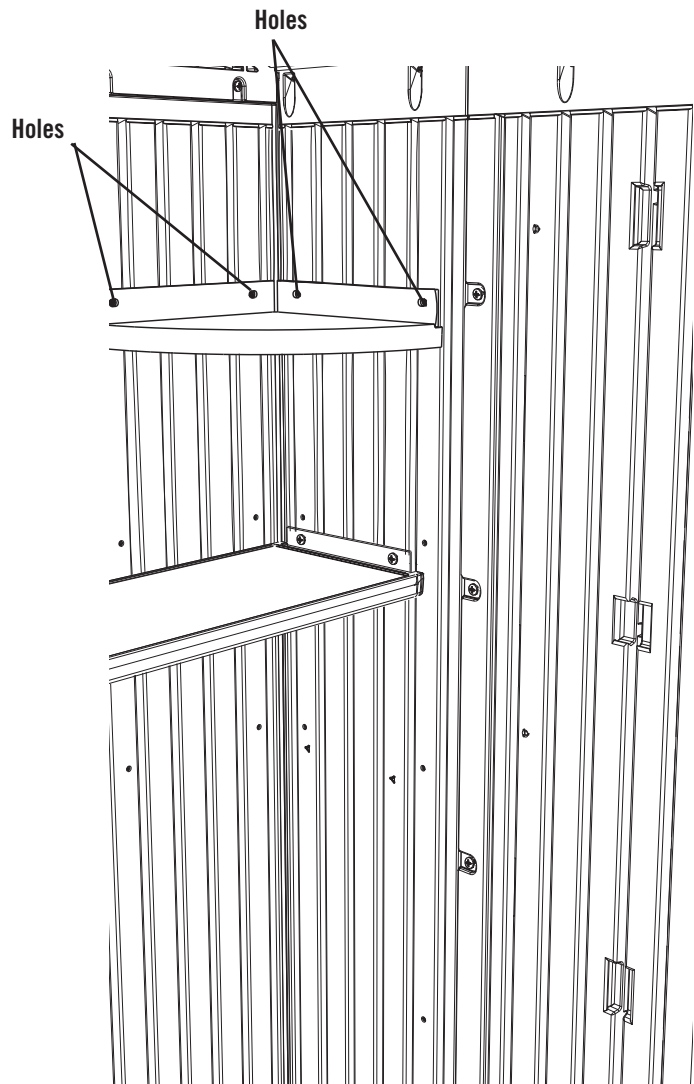
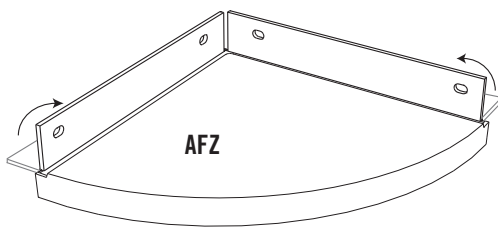

### WARNING

The total weight placed on a Corner Shelf cannot exceed 10 lb. (4.5 kg).

# SEC 11 WINDOW INSTALLATION

## **HARDWARE REQUIRED** **HARDWARE BAG REQUIRED: BEJ**

Hardware shown at actual size (\*Unless indicated otherwise)

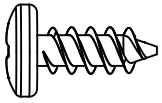

**ADZ** (x4)  
1/4" x 5/8" Pan-Head Screw

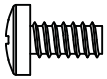

**ADY** (x1)  
#10 x 3/8" Pan-Head Screw

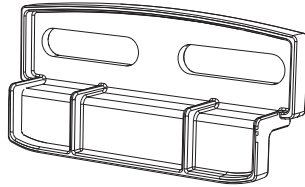

**\*AIS** (x2)  
Window Latch

## **PLASTIC PARTS REQUIRED** **SMALL PARTS KIT REQUIRED: BDX**

Part shown at 4% of actual size

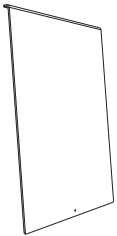

**AHE** (x1)  
Window

## **TOOLS REQUIRED**



Phillips Screwdriver



Safety Glasses



## TOOLS AND HARDWARE REQUIRED FOR THIS PAGE

SEC 11

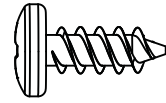

ADZ (x4)



ADY (x1)

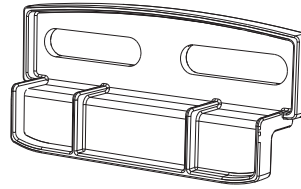

AIS (x2)  
(Not to scale)

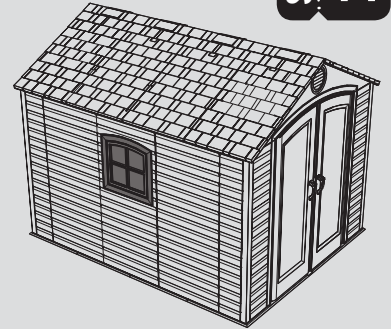

SEC

11.1

### WINDOW INSTALLATION

Remove the plastic protective film from **both sides** of the **Window (AHE)** and slide the Window into the grooves along the sides of the opening in the Window Wall Panel (Fig. 1). Insert the **#10 x 3/8" Pan-Head Screw (ADY)** into the hole at the bottom of the Window (Fig. 2) until flush. Attach a **Window Latch (AIS)** above each corner of the Window as shown. When tightening the four (4) **1/4" x 5/8" Pan-Head Screws (ADZ)**, ensure the Window Latches slide freely (Fig. 3). Do not overtighten.

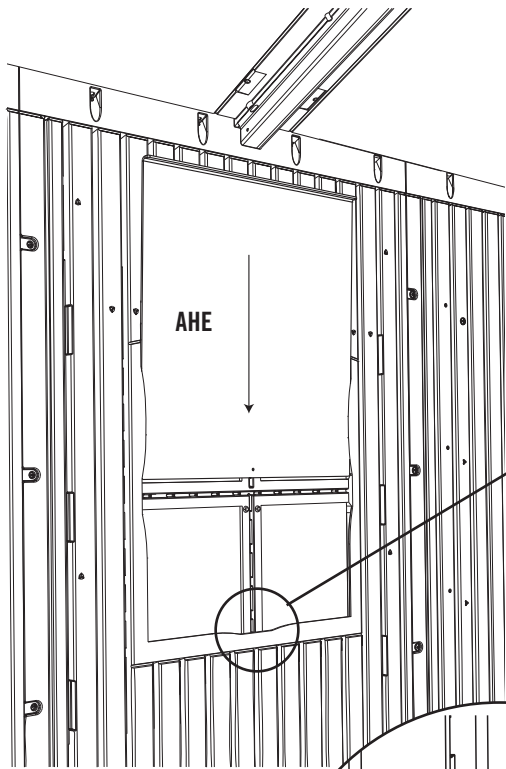

Fig. 1

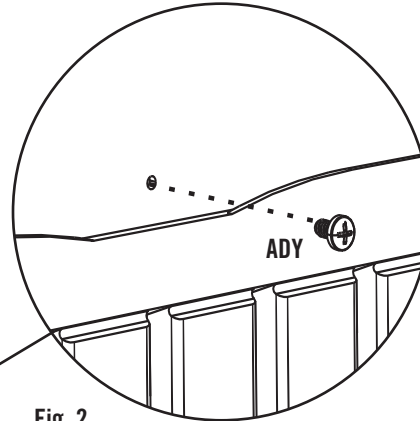

Fig. 2

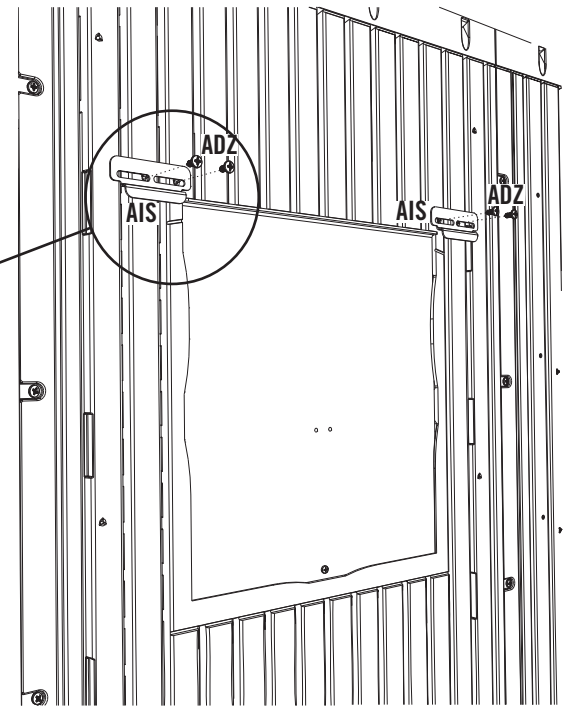
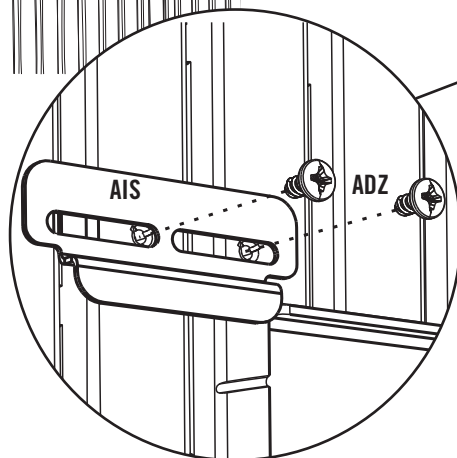

Fig. 3

**!** Note: Insert Window with bent edge at top and pointing away from the wall.

## SEC 12 PEGBOARD STRIP INSTALLATION

### HARDWARE REQUIRED

Hardware shown at actual size

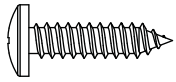

**ADW** (x10)  
#10" x 3/4" Pan-Head Screw

### HARDWARE BAGS REQUIRED: BHC, BHD

Hardware shown at 50% of actual size

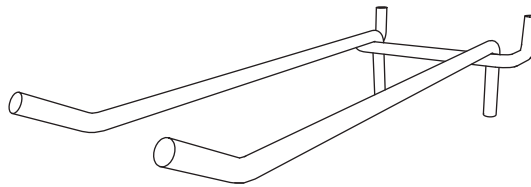

**AIG** (x1)  
4" Double-Arm Hook

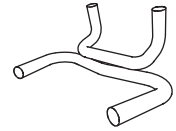

**AIJ** (x2)  
Toolholder

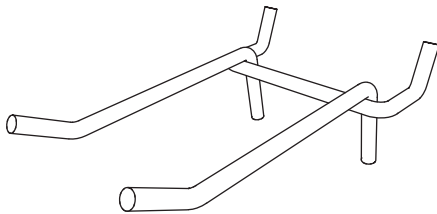

**AIF** (x1)  
2" Double-Arm Hook

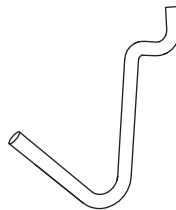

**AIH** (x3)  
J-Hook

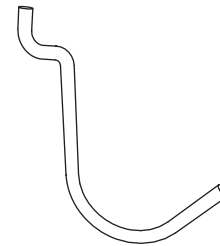

**AII** (x3)  
L-Hook

### PLASTIC PARTS REQUIRED

Parts shown at 15% of actual size

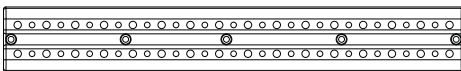

**AFU** (x2)  
Pegboard Strip

### SMALL PARTS BOX REQUIRED: BSI

### TOOLS REQUIRED



Phillips Screwdriver



Safety Glasses



Level



## TOOLS AND HARDWARE REQUIRED FOR THIS PAGE

SEC 12

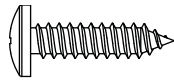

ADW (x10)

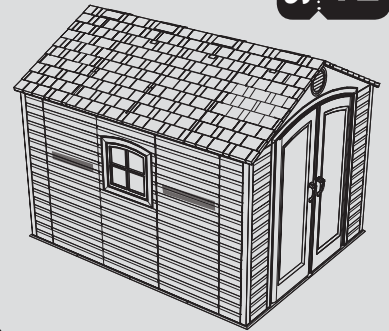

### SEC

#### PEGBOARD STRIP INSTALLATION

#### 12.1

Using a level, position the **Pegboard Strip (AFU)** in any desired location along a Wall Panel wall. Screw the Pegboard Strip to the Wall using five (5) **#10 x 3/4" Phillips Pan-Head Screws (ADW)**. See Note. Repeat this step for second Pegboard Strip.



*Note: The Pegboard Strip is screwed directly into the plastic. Line up the Strip anywhere on Wall so holes are over plastic (and not over a groove in the Wall).*

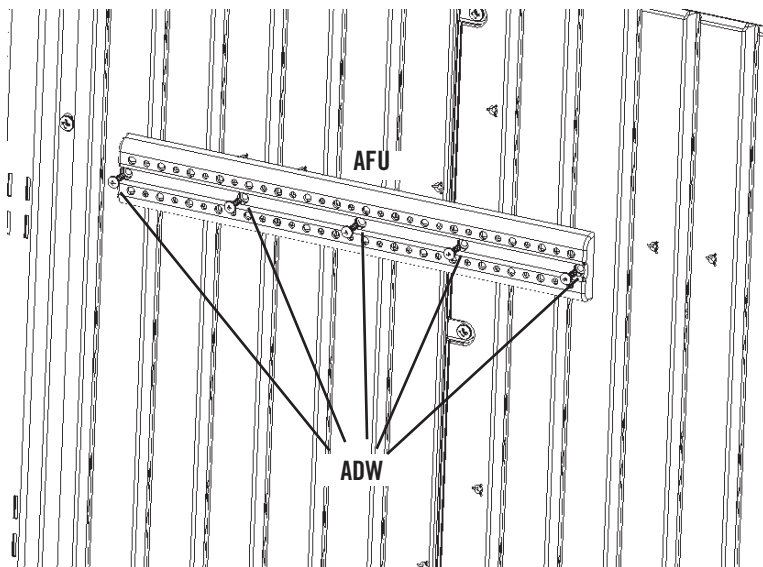

*Note: Ensure the Pegboard Strip is level before inserting Screws.*

### SEC

#### 12.2

Insert **Hooks (AIF, AIG, AIH, AII, and AIJ)**.

## SEC 13 FINAL STEPS

### **HARDWARE REQUIRED**

**HARDWARE BAG REQUIRED: BHB (x2)**

Hardware shown at actual size

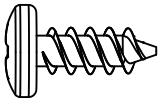

**ADZ (x6)**  
1/4" x 5/8" Pan-Head Screw  
(Not all Screws are used)

### **PLASTIC PARTS REQUIRED**

**SMALL PARTS BOX REQUIRED: BSI**

Part not shown on any particular scale

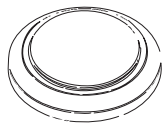

**AYJ (x2)**  
Battery-Powered Light

### **TOOLS REQUIRED**

**SMALL PARTS BOX REQUIRED: BSI**



**Phillips Screwdriver**

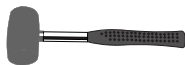

**Rubber Mallet**

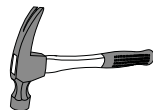

**Hammer**



**AIX (x4)**  
Wood Shim (Provided)



**Safety Glasses**





## TOOLS AND HARDWARE REQUIRED FOR THIS PAGE

SEC 13

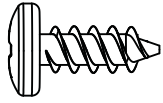

ADZ (x6)  
(Not all Screws are used)

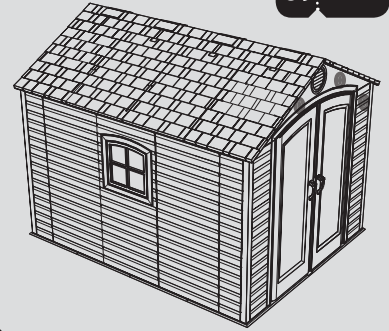

SEC

### BATTERY POWERED LIGHT INSTALLATION

13.1

Open the battery compartment and remove the plastic cap between the battery and the metal contact. The **Battery Powered Light (AYJ)** can be installed above the Right Corner Shelf (on 8' Sheds) or on the Front Gable. Insert two (2) **1/4" X 5/8" Pan-Head Screws (ADZ)** half-way into the pilot holes on the Corner Wall Panel or Front Gable. Hang Light on Screws. **Repeat this step for the second Light.** Gently tap the light to turn it on or off.

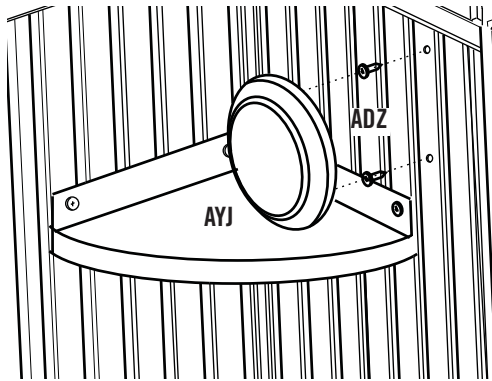

#### Battery Light Features:

- Adjustable Timer
- Auto shutoff
- Battery powered
- Easy on/off
- Easy mounting

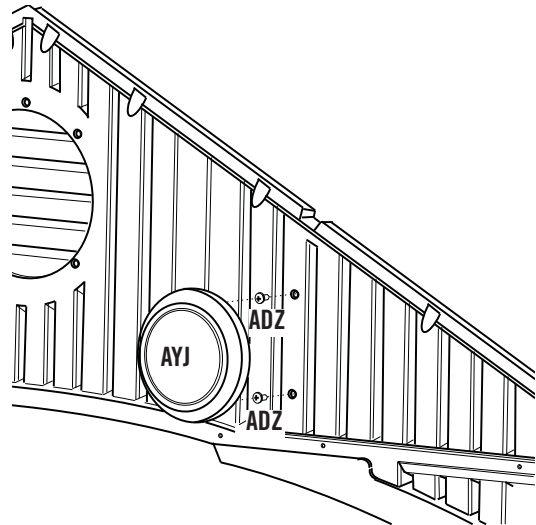
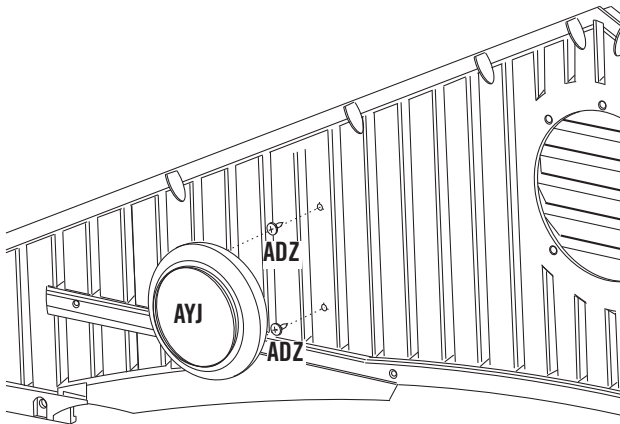



## TOOLS AND HARDWARE REQUIRED FOR THIS PAGE

SEC 13

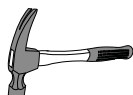

AIX (x4)

NO HARDWARE PROVIDED FOR THIS STEP

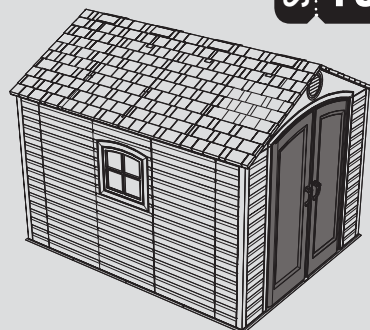

SEC

13.2

### DOOR ALIGNMENT

In some cases, the shed doors may not completely line up at the tops (fig. 1). When this happens, identify which side is higher and use a **Wooden Shim (AIX)** to slightly raise the back corner of the high side until doors line up (fig. 2). If doors need further adjustment, insert another shim under the front corner opposite of the first shim. If the doors still need further adjustment, stack additional shims (one at a time) alternating between the back and front shims. After doors are aligned, cut off any portion of wood shim that is still exposed. From inside the shed, drive a 1" nail through the floor into the shim to hold it in place. **Tighten all anchoring hardware now.**

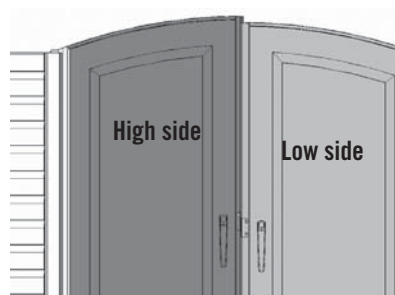

Fig. 1

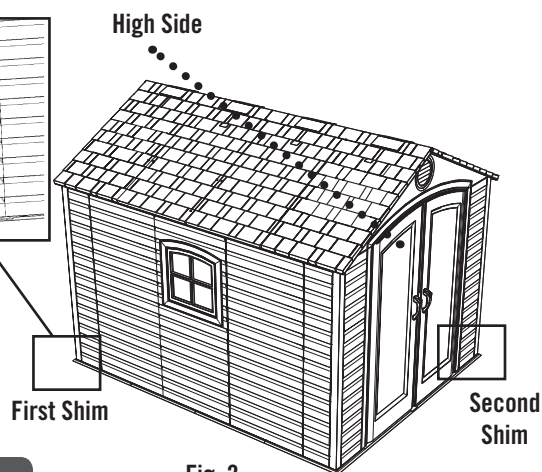
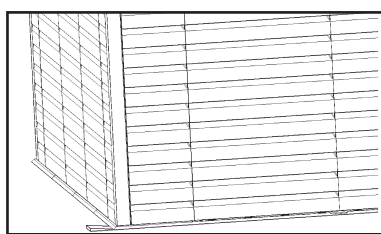

Fig. 2



*Note: Shim should be placed at the corner, running directly under one wall.*

## ***CLEANING & CARE***

Congratulations on your Lifetime® product purchase. By following the instructions below, your new Lifetime product should provide you with years of service and enjoyment.

### **Cleaning and Care**

The polyethylene panels are stain- and solvent-resistant. Most stains can be removed, using a mild soap and a soft-bristled brush. Abrasive cleaning materials may scratch the plastic and are not recommended. Repair scratches or rust spots on the metal by sanding the affected area lightly; using a rust preventative spray primer; and finally, spraying with a high-gloss spray enamel paint. Avoid placing a direct heat source on or near surfaces unless using a heat barrier.

## LIFETIME OUTDOOR SHED EQUIPMENT

### 10-YEAR LIMITED FACTORY WARRANTY

**THE MANUFACTURER RESERVES THE RIGHT TO MAKE SUBSTITUTIONS TO WARRANTY CLAIMS IF PARTS ARE UNAVAILABLE OR OBSOLETE.**

1. Lifetime outdoor sheds are warranted to the original purchaser to be free from defects in material or workmanship for a period of ten years from the date of original retail purchase. The word “defects” is defined as imperfections that impair the use of the product. Defects resulting from misuse, abuse or negligence will void this warranty. This warranty does not cover defects due to improper installation, alteration or accident. This warranty does not cover damage caused by vandalism, rusting, “acts of nature” or any other event beyond the control of the manufacturer.
2. This warranty is nontransferable and is expressly limited to the repair or replacement of defective product. If the product is defective within the terms of this warranty, Lifetime Products, Inc. will repair or replace defective parts at no cost to the purchaser. Shipping charges to and from the factory or distribution center are not covered and are the responsibility of the purchaser. Labor charges and related expenses for removal, installation or replacement of the shed or its components are not covered under this warranty.
3. This warranty does not cover scratching or scuffing of the product that may result from normal usage. In addition, defects resulting from intentional damage, negligence, unreasonable use or hanging from the truss will void this warranty.
4. Liability for incidental or consequential damages is excluded to the extent permitted by law. While every attempt is made to embody the highest degree of safety in all equipment, freedom from injury cannot be guaranteed. The user assumes all risk of injury resulting from the use of this product. All merchandise is sold on this condition, and no representative of the company may waive or change this policy.
5. This product is not intended for institutional or commercial use; Lifetime Products, Inc. does not assume any liability for such use. Institutional or commercial use will void the warranty.
6. This warranty is expressly in lieu of all other warranties, expressed or implied, including warranties of merchantability or fitness for use to extent permitted by Federal and state law. Neither Lifetime Products, Inc., nor any representative assumes any other liability in connection with this product. This warranty gives you specific legal rights, and you may also have other rights which vary from state to state.

#### **PLEASE INCLUDE YOUR DATED SALES RECEIPT AND PHOTOGRAPHS OF DAMAGED PARTS.**

REPORT PRODUCT DEFECTS IN WRITING TO:

Lifetime Products, Inc., PO Box 160010 Clearfield, UT 84016-0010  
or call 1-800-225-3865 M-F 7 a.m. to 5 p.m. MST.

#### **REGISTER YOUR PRODUCT FOR QUICKER CUSTOMER SERVICE.**

Visit [www.lifetime.com](http://www.lifetime.com) or call 1-800-225-3865 to register your product today.

#### **FOR INTERNATIONAL WARRANTY CLAIMS:**

All warranty claims must be accompanied by a sales receipt. Report all warranty claims in writing to your regional sales support representative. Please include your dated sales receipt and photographs of damaged parts.

To Identify the representative for your region — Please visit: [www.lifetime.com/international](http://www.lifetime.com/international)



[www.lifetime.com](http://www.lifetime.com)

**ENHANCE YOUR LIFETIME® PURCHASE BY ADDING ACCESSORIES OR OTHER GREAT PRODUCTS**

---

*To purchase accessories or other Lifetime Products, visit us at:*

***www.lifetime.com***

***Or call: 1-800-424-3865***

---

