



JDVD1500

CD / MP3 / WMA / DVD PLAYER / RECEIVER

Installation and Operation Manual



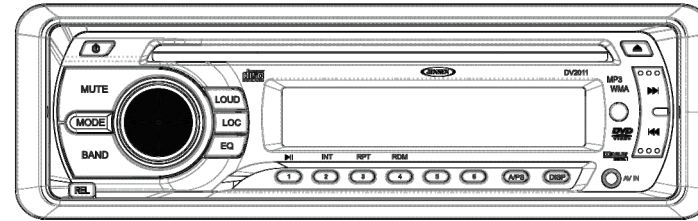

INTRODUCTION

System Features

Features of the Jensen JDVD1500 mobile audio system include:

- 3-Wire power (ACC, Batt, Gnd)
- Detachable faceplate
- 1-DIN (sleeve-mount) chassis design
- Segmented LCD Display
- Blue LED panel illumination
- Electronic AM/FM tuner (US)
- Station presets (18FM, 12AM)
- Auto-Store (AS)/ Preset Scan (PS)
- Single DVD / CD player (Plays DVD, CD-A, CD-R/RW Media)
- Plays MP3 and WMA Encoded Discs
- Electronic Skip Protection (ESP) CD (8 Sec) DVD (3 Sec)
- Front panel Aux Video / Stereo Audio input (3.5mm)
- Encoded rotary volume control
- Audio Mute / Loudness
- Preset EQ (Pop, Rock, Classic)
- Stereo Pre-amp Audio Output (Front and Rear RCA)
- 2 Composite Video Output (RCA)
- 1 Composite Video Input (RCA)
- 4x40W Maximum Audio Power Output
- Subwoofer Output (Pre-amp RCA)
- Wireless (Jensen IR Codes) Credit Card size remote control (included)
- Wired remote ready (MWR75 sold separately)

HARDWARE KIT CONTENTS

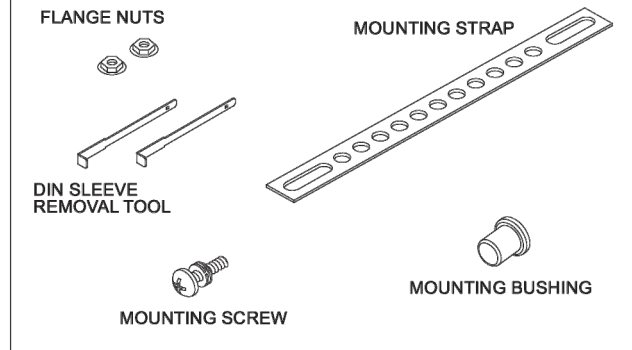



- IR repeater eye ready (IRPMRPT sold separately)
- Regulatory Certifications: FCC

Content List

- Jensen Heavy Duty Radio
- Hardware Kit
- Installation Manual
- Quick reference Guide

SAFETY INFORMATION

When Driving

Keep the volume level low enough to be aware of the road and traffic conditions.

When Washing your Vehicle

Do not expose the product to water or excessive moisture. Moisture can cause electrical shorts, fire or other damage.

When Parked

Parking in direct sunlight can produce very high temperatures inside your vehicle. Give the interior a chance to cool down before starting playback.

Use the Proper Power Supply

This product is designed to operate with a 12 volt DC negative ground battery system (the standard system in a North American vehicle).

Protect the Disc Mechanism

Avoid inserting any foreign objects into the disc slot. Misuse may cause malfunction or permanent damage due to the precise mechanism of this unit.

CAUTION:

THIS MOBILE DVD PLAYER IS A CLASS I LASER PRODUCT. THIS UNIT USES A VISIBLE/ INVISIBLE LASER BEAM WHICH COULD CAUSE HAZARDOUS RADIATION IF EXPOSED DIRECTLY. BE SURE TO OPERATE THE MOBILE DVD PLAYER AS INSTRUCTED.

USE OF CONTROLS OR ADJUSTMENTS OR PERFORMANCE OR PROCEDURES OTHER THAN THOSE SPECIFIED HEREIN MAY RESULT IN HAZARDOUS RADIATION EXPOSURE. DO NOT OPEN COVERS AND DO NOT REPAIR BY YOURSELF. PLEASE REFER SERVICING TO A QUALIFIED TECHNICIAN.

WARNING:

- TO REDUCE THE RISK OF FIRE OR ELECTRIC SHOCK, DO NOT EXPOSE THIS EQUIPMENT TO RAIN OR MOISTURE.
- TO REDUCE THE RISK OF FIRE OR ELECTRIC SHOCK AND ANNOYING INTERFERENCE, USE ONLY THE RECOMMENDED ACCESSORIES.
- THIS DEVICE IS INTENDED FOR CONTINUOUS OPERATION.

This product incorporates copyright protection technology that is protected by method claims of certain U.S. Patents and other intellectual property rights owned by Macrovision Corporation and other rights owners. Use of this copyright protection technology must be authorized by Macrovision Corporation, and is intended for home and other limited viewing uses only unless otherwise authorized by Macrovision Corporation. Reverse engineering or disassembly is prohibited.

Region Management Information

This Mobile DVD Player is designed and manufactured to respond to the Region Management Information recorded on individual DVD discs. If the Region number described on the DVD disc does not correspond to the Region number(s) supported by this Mobile DVD Player, the disc will not play in this unit.

DISC NOTES

Compatible Disc Types

DVD Video

DVDs contain excellent sound and video quality due to Dolby Digital and MPEG2 encoding. A DVD is 12 cm in diameter and can hold more than seven times the data of a CD-ROM. The maximum playing time can be up to 2 hours (a double-sided DVD is up to 4 hours). There are four types of DVD discs: single-layer single-sided (1), two-layer single-sided (2), single-layer double-sided (3), and two-layer double-sided (4).

CD-DA

CD-DA discs can play voice data. The playing time of the standard 12 cm CD-DA disc is 74 minutes.

DTS-CD

The DTS digital surround sound uses 6 digital sound tracks to replace the analog voice tracks in movies.

HDCD

HDCD, or "High Definition Compatible Digital," is a recording/playing technology that improves CD audio quality. Based on full compliance with CD specifications, it can enhance the quality and quantity of digital sounds in the highest scale. It encodes the required messages that were deserted by the CD format, and stores the related commands into the LSB. Without changing the CD format, it is output through the 24-bit D/A converter, which will ultimately enhance the quality of playback.

MP3/WMA/JPEG

This unit is compatible with CD-R, CD-RW, and CD-ROM discs containing MP3, WMA, and JPEG tracks.

CD-R/CD-RW

This unit is compatible with CD-R and CD-RW discs that support ISO9660 specifications. ".MP3", ".JPG", ".JPEG", ".AC3", ".PCM", ".MPG", ".MPE", and ".WAV" formats can be included on ISO9660-compatible discs.

DVD-R / DVD-RW

This unit is compatible with DVD-R and DVD-RW discs that support UDF specifications. ".MP3", ".JPG", ".JPEG", ".AC3", ".PCM", ".MPG", ".MPE", and ".WAV" formats can be included on UDF-compatible discs.

Incompatible Disc Types

- 8 cm disc
- CD ROM
- CDV, CDI, CDG

- LD
- DVD ROM
- DVD RAM

NOTE: DVD-R and DVD-RW discs will not play unless the recording session is closed and the DVD is finalized.

Table 1: General Disc Information

Disc Type	Logo	Diameter/ Playable Sides	Playback Time
DVD Video		12 cm single/double side (1 layer & 2 layer)	133 minutes (4.7 GB) 242 minutes (8.5 GB) 266 minutes (9.4 GB) 484 minutes (17 GB)
Audio CD		12 cm single side	74 minutes
MP3/WMA Disc	CD-Rs or CD-RWs recorded in MP3, MPEG1 or 2, 2.5 Audio Layer 3 and WMA Version 7 and 8. The recorded format must be compliant with ISO 9660 Level 1, ISO 9660 Level 2, Romeo, or Joliet.		

Disc Maintenance

Before playing, wipe the disc using a clean cloth, working from the center hole towards the outside edge.

Never use benzene, thinners, cleaning fluids, anti-static liquids or any other solvent.

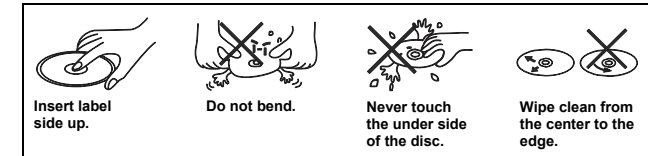

NOTE: A disc may become scratched (although not enough to make it unusable) depending on how you handle it and other conditions in the usage environment. These scratches are not an indication of a problem with the player.

INSTALLATION

This unit can be properly installed with either a "Front" (conventional DIN front mount) or "Rear" (DIN rear mount installation, utilizing threaded screw holes at the sides of the unit chassis) mount. For details, refer to installation methods A and B.

Before You Begin

1. **Disconnect Battery**
Before you begin, always disconnect the battery negative terminal.
2. **Remove Transport Screws**

Important Notes

- Before final installation, test the wiring connections to make sure the unit is connected properly and the system works.
- Use only the parts included with the unit to ensure proper installation. The use of unauthorized parts can cause malfunctions.
- Consult with your nearest dealer if installation requires the drilling of holes or other modifications to your vehicle.
- Install the unit where it does not interfere with driving and cannot injure passengers if there is a sudden or emergency stop.
- If the installation angle exceeds 30° from horizontal, the unit might not give optimum performance.
- Avoid installing the unit where it will be subject to high temperatures from direct sunlight, hot air, or from a heater, or where it would be subject to excessive dust, dirt or vibration.
- Be sure to remove the control panel before installing the unit.

DIN Front Mount (Method A)

1. Slide the mounting sleeve off of the chassis if

Dashboard it has not already been removed. If it is locked into position, use the removal keys (supplied) to disengage it. The removal keys are depicted in "DIN Rear Mount (Method B)" on page 5.

2. Check the dashboard opening size by sliding the mounting sleeve into it. If the opening is not large enough, carefully cut or file as necessary until the sleeve easily slides into the opening. Do not force the sleeve into the opening or cause it to bend or bow. Check that there will be sufficient space behind the dashboard for the radio chassis.
3. Locate the series of bend tabs along the top, bottom and sides of the mounting sleeve. With the sleeve fully inserted into the dashboard opening, bend as many of the tabs outward as necessary to firmly secure the sleeve to the dashboard.
4. Place the radio in front of the dashboard opening so the wiring can be brought through the mounting sleeve.
5. Follow the wiring diagram carefully and make certain all connections are secure and insulated with crimp connectors or electrical tape to ensure proper operation.

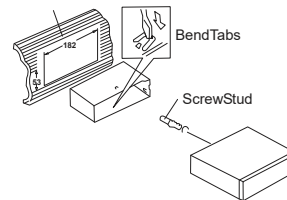

6. After completing the wiring connections, turn the unit on to confirm operation (vehicle accessory switch must be on). If the unit does not operate, recheck all wiring until the problem is corrected. Once proper operation is achieved, turn the accessory switch off and proceed with final mounting of the chassis.
7. Carefully slide the radio into the mounting sleeve making sure it is right-side-up until it is fully seated and the spring clips lock it into place.
8. Attach one end of the perforated support strap (supplied) to the screw stud on the rear of the chassis using the hex nut provided. Fasten the other end of the perforated strap to a secure Screw (5 x 25mm) part of the dashboard either

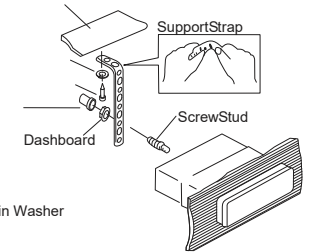

using the screw and plain washer provided. Bend the strap, as necessary, to position it. Some vehicle installations provide cavity for rear support. In these applications, place the rubber bushing over the screw stud and insert the radio.

CAUTION: The perforated rear support strap or rear rubber mounting bushing must be used in the installation of the radio. Installation without either may result in damage to the radio or the mounting surface and void the manufacturer's warranty.

9. Test radio operation by referring to the operating instructions for the unit.
10. When wiring is complete, reconnect the battery negative terminal.
11. Push the trim plate against the chassis until it is fitted. **You must do this before you install the control panel, otherwise it can't be attached.**

DIN Rear Mount (Method B)

This unit has threaded holes in the chassis side panels which may be used with the original factory mounting brackets of some vehicles to mount the radio to the dashboard. Please consult with your local mobile stereo shop for assistance on this type of installation.

1. Remove the existing factory radio from the dashboard or center console mounting. Save all hardware and brackets as they will be used to mount the new radio.
2. Carefully unsnap the plastic trim ring from the front of the new radio chassis. Remove and discard the trim ring.
3. Remove the factory mounting brackets and hardware from the existing radio and attach them to the new radio. Select a position where the screw holes of the bracket and the screw holes of the main unit are aligned (are fitted). Tighten the screws at 2 places on each side. Do not exceed M5 x 9 MM

- factory maximum screw size. Longer mounting screws may damage bracket components inside the chassis.
4. Wire the new radio to the vehicle as outlined in the Universal Installation instructions.
 5. When wiring is complete, reconnect the battery negative terminal.
 6. Mount the new radio assembly to the dashboard or center console using the reverse procedure of step 1.

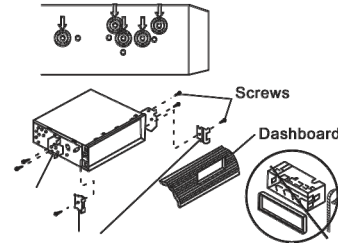

NOTE: The mounting box, outer trim ring, and half-sleeve are not used for method B installation.

Removing the Unit (Method A Installation)

To remove the radio after installation:

1. Insert fingers into the groove in the front of frame and pull out to remove the frame. (When re-attaching the frame, point the side with a groove downwards and re-attach.)
2. Insert the removal keys straight back until they click, and then pull the radio out. If removal keys are inserted at an angle, they will not lock properly to release the unit.

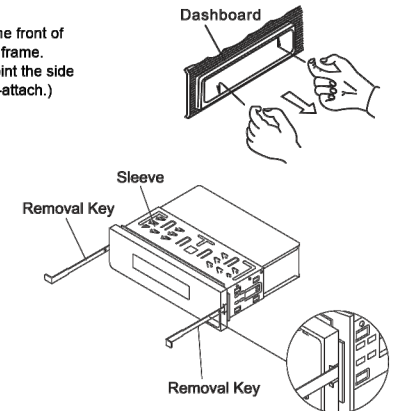

CAUTION:

- DO NOT insert the DCP from the left side. Doing so may damage it.
- The DCP can easily be damaged if dropped or subjected to a strong shock. When the release button is pressed and the DCP is unlocked, the vehicle's vibrations may cause it to fall. To prevent damage to the DCP, always store it in a protective case after detaching it.
- The rear connector that connects the main unit and the DCP is an extremely important part. Be careful not to damage it by pressing on it with fingernails, pens, screwdrivers, etc.
- If the DCP is dirty, remove debris with a soft, dry cloth only. You can use a cotton swab soaked in isopropyl alcohol to clean the socket on the back of the DCP.

JDVD1500

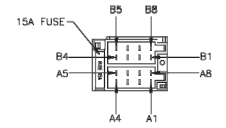
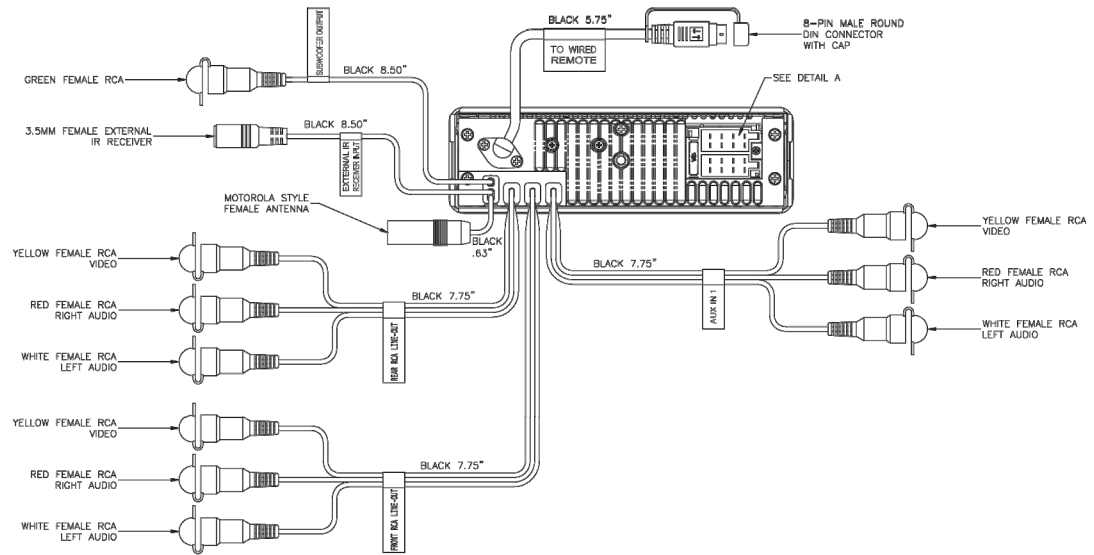

DETAIL A
SHOWN FROM PIN VIEW

PIN NO.	DESCRIPTION
A1	RIGHT REAR SPEAKER (+)
A2	RIGHT FRONT SPEAKER (+)
A3	LEFT FRONT SPEAKER (+)
A4	LEFT REAR SPEAKER (+)
A5	LEFT REAR SPEAKER (-)
A6	LEFT FRONT SPEAKER (-)
A7	RIGHT FRONT SPEAKER (-)
A8	RIGHT REAR SPEAKER (-)
B1	NO CONNECTION
B2	NO CONNECTION
B3	POWER ANTENNA REMOTE
B4	+12V SWITCHED
B5	GROUND
B6	NO CONNECTION
B7	+12V BATT UNSWITCHED
B8	NO CONNECTION

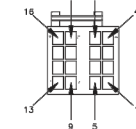
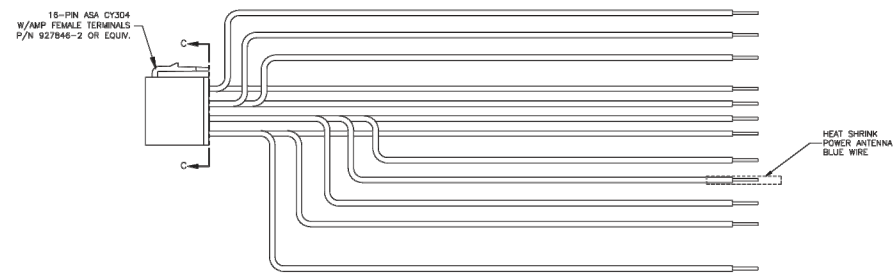

VIEW C-C
WIRE INSERTION VIEW

PIN NO.	WIRE COLOR	FUNCTION
1	GREEN	LEFT REAR SPEAKER (+)
2	WHITE	LEFT FRONT SPEAKER (+)
3	GRAY	RIGHT FRONT SPEAKER (+)
4	VIOLET	RIGHT REAR SPEAKER (+)
5	GREEN/BLACK	LEFT REAR SPEAKER (-)
6	WHITE/BLACK	LEFT FRONT SPEAKER (-)
7	GRAY/BLACK	RIGHT FRONT SPEAKER (-)
8	VIOLET/BLACK	RIGHT REAR SPEAKER (-)
9	RED	+12V SWITCHED
10	BLUE	POWER ANTENNA REMOTE
11	EMPTY	NO CONNECTION
12	EMPTY	NO CONNECTION
13	BLACK	GROUND
14	EMPTY	NO CONNECTION
15	YELLOW	+12V BATT UNSWITCHED
16	EMPTY	NO CONNECTION

CONTROLS AND INDICATORS

The buttons located on the unit and the remote control that perform the same function are assigned the same number for reference on the diagrams and in the text.

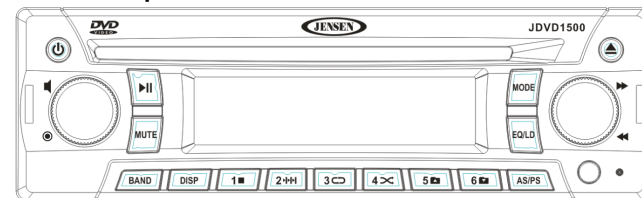
Front Panel Operation

1. Power
2. Eject
3. Audio Control Button
4. Volume Control Knob
5. Play/Pause
6. Mute
7. Band Select
8. Clock Display
9. Preset 1, Stop Disc Playback
10. Preset 2, Intro Scan
11. Preset 3, Repeat Play
12. Preset 4, Random Play
13. Preset 5, Folder Down
14. Preset 6, Folder Up
15. Auto Store/Presets Scan
16. Mode/Source Select
17. Preset Equalizer/Loudness Boost Setting
18. Confirm Button
19. Fast Forward/Rewind and Advance Chapter/Previous Chapter knob
20. Infrared sensor
21. Reset
22. Disc slot

Remote Control Operation
Using the Remote Control

Point the remote control towards the player front face remote sensor IR (2). The operation angle is approximately 30 degrees in each direction of the front of the remote sensor.



JDVD1500



Ref #	Button	Function
1	/POWER	Turn the unit ON or OFF
2	/EJECT	Eject the disc
3	/TRACK	Skip to the next track/chapter
4		Stop disc playback
5		Play/pause the disc (for disc play mode)
6	/TRACK	Go to previous track/chapter
7	VOL \wedge	Increase the volume level
8	VOL \vee	Decrease the volume level
9	AUDIO	Select the desired adjustment mode (BASS, TREBLE, BALANCE, FADE).
10	SOURCE	Change between tuner, disc (DVD/VCD/CD/MP3) play mode, AUX IN and BT mode
11		Display statistical disc information during playback
12	PROG	Display programmed playback screen, allowing you to enter tracks to play in programmed order.
13	TUNE+	Tune up one step
14	RPT	Repeat current track/chapter
15	AS/PS	<i>Press and hold to save the 18 strongest station in your are Press once to automatically scan through the stored channel</i>
16		Change the SUBTITLE language on multi-subtitle language DVD discs
17	ANGLE	Change the viewing angle on multi-angle DVD discs
18	MENU (PBC)	Display the root menu stored on DVD discs/Switch between PBC ON and PBC OFF on VCD discs

Ref #	Button	Function
26	TITLE	Display the TITLE menu stored on DVD disc
27	TUNE-	Tune down one step
28	/TRACK	Search in reverse rapidly
29	/TRACK	Search forward rapidly
30	0-9	Enter track/chapter number directly. Use GOTO to search.
31	GOTO	Used with numeric buttons to search disc
32		Press to mute/resume audio.



19		Display the SETUP menu
20	ZOOM	Increase the picture size
21	10+	Feature not used on this model
22	10/0	
23	<, > A, V	Select items left/right and ahead/back in menu mode
24	ENTER	Confirm selection of track/chapter
25	LANG	Change the audio sound track on multi-audio sound track DVD discs. Change the sound mode of VCD discs

Remote Control Functions

BASIC OPERATION

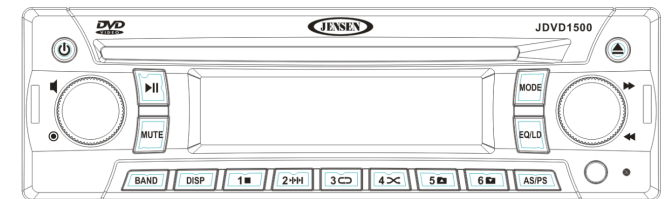

Power On/Off ()

Press the  button (1) on the front of the unit ON or OFF.

Volume Control

To increase the volume, rotate the audio control knob (3) clockwise.

To decrease the volume, rotate the audio control knob counter clockwise. When the volume is adjusted, the volume level is shown on the display panel as a number ranging from "0" (lowest) to "40" (highest).

Mute

Press the **MUTE** button (6) to mute the audio output. "MUTE" will appear on the display. Press **MUTE** again to restore the audio output to the previous level.

Mode

Press the **MODE** button (16) to select a different mode of operation, as indicated on the display panel. Available modes include Tuner, DVD, AUX IN and BT.

Equalizer (EQ) And Loudness(LOUD)

The preset equalizer applies preset sound effects to the unit's audio output signal. To adjust the preset equalizer, press the **EQ/LD** button (17). Press repeatedly to choose between the following modes: FLAT, POP, CLAS, ROCK.

When listening to music at low volume levels, this feature will boost the bass and treble ranges to compensate for the characteristics of human hearing. Press and hold the **EQ/LD** button (17) to activate this feature. "LOUD ON" appears on the display panel. Press and hold the **EQ/LD** button(17) again to turn the LOUD function off.

Display Selector (DISP)

This unit can display either the clock time or radio frequency/CD player functions. Press the **DISP** button (8) to display the time. The correct time of day can be set by pressing and holding the **DISP** button.

Setting the Clock (DISP)

To set the clock, perform the following steps:

1. Press the **DISP** button (8) to display the clock.
2. Press and hold the **DISP** button (8) until the time display flashes.
3. Within 5 seconds, turn the audio control knob (6) to adjust the hour to the desired setting.
4. Press and hold the **DISP** button (8) to move to the minutes field.
5. Turn the audio control knob to adjust the minutes to the desired setting.
6. Press the **DISP** button again to return to radio frequency or disc play and normal operation will resume automatically.

Auxiliary Input Operation

You can connect another audio system to the unit through the AUX IN terminals on the back (AUX IN) of the unit. Once the device is connected, press the **MODE** button (16) on the front panel or the **SOURCE** button on the remote control to select "AUX " mode.

PA

PA function is available if user already install the microphone.

Reset

Use a pencil or any non-metallic object to *press and hold* the **RESET** button(21) for five seconds to reset the main unit. The unit will return to the factory default settings.

AUDIO MENU

Press the volume control button (3) to access the Audio Menu. You can navigate through the Audio Menu items by pressing the volume control button repeatedly. Once the desired menu item appears on the display, adjust that option by turning the audio control knob within 10 seconds. The unit will automatically exit the Audio Menu after six seconds of inactivity. The following menu items can be adjusted.

Bass Level (BAL)

Use the Volume Control knob(4) to adjust the Bass level range from "-7" to "+7".

Treble Level (TRE)

Use the Volume Control knob(4) to adjust the Treble level range from "-7" to "+7".

Balance (BAL)

Use the Volume Control knob(4) to adjust the Balance between the right and left speakers from "R 7" (full right) to "L 7" (full left). "0" represents an equal balance between the right and left speakers.



Fader (FAD)

Use Volume Control knob(4) to adjust the Fader between the front and rear speakers from "R 7" (full rear) to "F 7" (full front). "0" represents an equal balance between the front and rear speakers.

SYSTEM MENU

Press and hold the audio control button(3) to access the System Menu. And then you can navigate through the System Menu items by pressing the volume control button repeatedly. Once the desired menu item appears on the display, adjust that option by turning the audio control knob(3) within 10 seconds. The unit will automatically exit the System Menu after six seconds of inactivity. The following menu items can be adjusted.

RCA out

Use the Volume Control knob(4) to adjust RCA out: FIXED or VARI

Radio area

Use the Volume Control knob(4) to adjust radio area to be USA or EUR.

BT

Use the Volume Control knob(4) to open or close Bluetooth.

PRE-VOLUME

Use the Volume Control knob(4) to set volume

RESET

Press the Confirm Button(18),The Unit will return to the factory default settings.

TUNER OPERATION

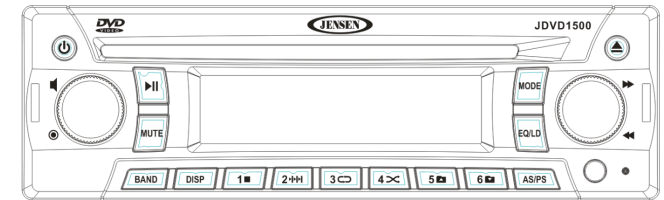

Select a Band

Press the **BAND** button (7) on the control panel (or the **SOURCE** button on the remote control) to change between three FM bands and two AM bands. Each band stores up to six preset stations.

Tuning

Manual Tuning

Rotate the volume knob forward or backward(19)to change the radio frequency number up or down one step.

If using the remote control, press the **TUNE +** or **TUNE -** buttons to change the radio frequency number up or down one step.

Auto Seek Tuning

顺时针或逆时针旋转不放 for more than three seconds to move to the next station automatically.

Preset Stations

Six numbered preset buttons store and recall stations for each band.

Store a Station

Select a band (if needed), then select a station. *Press and hold* a preset button (9-14) for three seconds. The preset number will appear in the display.

Recall a Station

Select a band (if needed). Press a preset button (9-14) to select the corresponding stored station.

Automatically Store / Preset Scan

Automatically Store

Select a band (if needed). Press **AS/PS** (15) for more than three seconds to automatically select six strong stations and store them in the current band. The new stations replace any stations already stored in that band.

Preset Scan

Select a band (if needed). Press **AS/PS** (15) to scan stations stored in the current band. The unit will pause for ten seconds at each preset station. Press **AS/PS** again to stop scanning when the desired station is reached.

Stereo

The unit will automatically pick up a stereo signal, when available. When in stereo mode, the "ST" icon appears in the display. When no stereo signal is available, the unit will automatically revert to mono operation, and no icon will be displayed.



AUDIO CD OPERATION

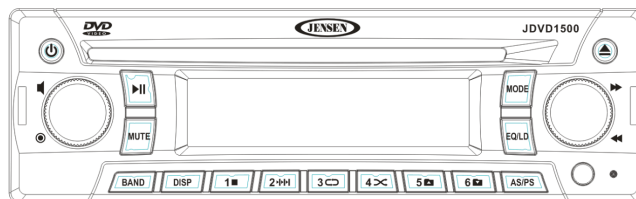

Random Play (4/RDM)

Press the **4/RDM** button (12) during disc play to play all tracks on a CD in random, shuffled order. Press **4/RDM** again to stop random play.

Insert and Eject Disc

Insert a disc into the disc slot (22), label-side up, with the unit turned on. The unit will play the first track on the disc. Press the eject button (2) to stop disc play and eject the disc. The unit does not have to be turned on to eject the disc.

Controlling Disc Playback

Track Select

Rotate the volume knob forward or backward (19) for less than one second to advance to the next track on the CD. The selected track number will appear on the display. Long rotate the volume knob forward or backward (19) to fast forward or fast reverse through the disc.

NOTE: When the last track finishes playing, the unit will automatically play the CD again.

Play/Pause Disc Playback (>||)

Press the >|| button (5) on the control panel (or >|| on the remote control) to suspend disc play. Press the >|| button again to resume disc Play.

Intro Scan (2 INT)

Press the 2/INT button (9) on the control panel to play the first 10 seconds of each track sequentially. Press 2/INT again to stop Intro Scan and resume normal play at the current track.

Repeat Play (3/RPT)

Press the 3/RPT button (11) on the control panel (or the RPT button on the remote control) during disc play repeatedly to activate Repeat Mode:

- Press 3/RPT once to turn repeat off.
- Press 3/RPT twice to repeat play the current track.
- Press 3/RPT three times to repeat play the whole disc.

MP3/WMA OPERATION

MP3 and WMA (Windows Media Audio) music files are digital audio files that are compressed to allow more files on a single CD. This unit can play MP3/WMA directly from files contained on a CD-R/RW using the buttons on the receiver (or optional remote) as described below. Many types of software are available for converting audio files into MP3/WMA formats. Jensen recommends *Nero, MusicMatch Jukebox* or *Roxio Easy CD Creator*. Depending on the media type and recording method, some CD-R/RW's may be incompatible with this unit. The unit supports playback of MP3/WMA and CDDA (CDA), Mixed-Mode CDs and CD-Extra (including multisession discs), but **discs on which the session has not been closed will not play.**

Notes on MP3/WMA Play

This unit can play MP3 (MPEG1, 2, 2.5 Audio Layer 3) and WMA ver. 7 and 8. However, the MP3 recording media and accepted formats are limited. When writing MP3/WMA, pay attention to the following restrictions.

Acceptable Media

The MP3/WMA recording media acceptable to this unit are CD-ROM, CD-R and CD-RW. When using CD-RW, use full format rather than quick format to prevent malfunction.

Acceptable Medium Formats

The following formats are available for the media used in this unit. The maximum number of characters used for file name including the delimiter (".") and three-character extension are indicated in parentheses.

- ISO 9660 Level 1 (11 characters)
- ISO 9660 Level 2 (31 characters)
- Joliet (31 characters)

Up to 200 characters can be displayed in the long file name format. For a list of available characters, see the instruction manual of the writing software. The media reproducible on this unit has the following limitations:

- Maximum number of nested folders: 15
- Maximum number of files per disc: 796 (199 MP3+199 WMA+199 MP3+199 JPG)
- Maximum number of folders per disc: 199
- Maximum number of sessions per disc: 5

MP3/WMA written in formats other than those listed above will not play successfully and their file names or folder names will not be displayed properly.

MP3/WMA Encoder and CD Writer Settings

Use the following settings when compressing audio data in MP3 data with the MP3 encoder:

- Transfer bit rate: 32 - 320 kbps
- Sampling frequency: 32,44,1,48 kHz (WMA) 16,22,05,24,32,44,1,48kHz (Mp3) When using a CD writer to record MP3/WMA up to the maximum disc capacity, disable additional writing. To record an empty disc up to the maximum capacity at once, select the "disc at once" option.

Entering ID3 Tag

This unit supports ID3 tag versions 1.0 and 1.1.

Controlling Disc Playback

When a video monitor is installed, a screen similar to the following will appear when an MP3 disc is played.

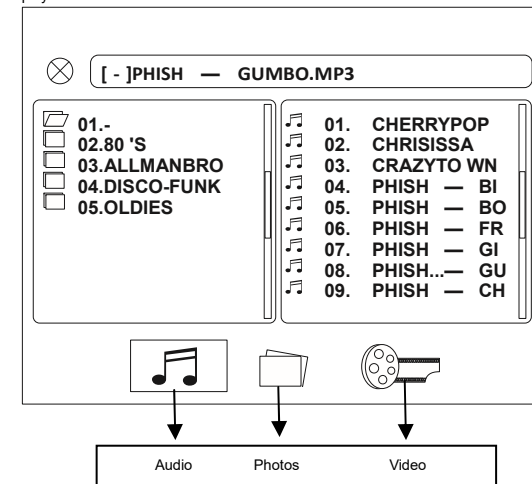

Select one of these icons to access the corresponding media on your disc. If the media type is not present, the icon will not be selectable.

Play/Pause Disc Playback (>||)

Press the >|| button (5) on the control panel (or >|| on the remote control) to suspend disc play. Press the >|| button(5) again to resume disc Play.

Repeat Play (3/RPT)

Press the 3/RPT button (11 on the control panel (or the RPT button on the remote control) during disc play repeatedly to activate Repeat Mode:

- Press 3/RPT once to turn repeat off.
- Press 3/RPT twice to repeat play the current track.
- Press 3/RPT three times to repeat play the current folder.



- Press **3/RPT** four times to repeat play the whole disc.

Random Play (4/RDM)

Press the **4/RDM** button (12) during disc play to play all files on a disc in random, shuffled order.
Press **4/RDM** again to turn random play off.

Track Select

Rotate the volume knob forward or backward (19) for less than one second to advance to the next track on the CD. The selected track number will appear on the display. **Long rotate the volume knob forward or backward** or fast reverse through the disc.

File Select

Press the 5 button (13) to access a lower folder level (FOLDER DN).
Press and hold the 6 button (14) to access a higher folder level (FOLDER UP).

DVD/DISC OPERATION

JDVD1500



Once a DVD disc is inserted into the unit, the unit will automatically start playback from the beginning of the disc. Once the preview tracks have been played, the DVD MENU, ROOT or TITLE of the DVD disc will appear on the TFT monitor and "ROOT" will be displayed on the LCD panel.

DVD Menu Button Functions

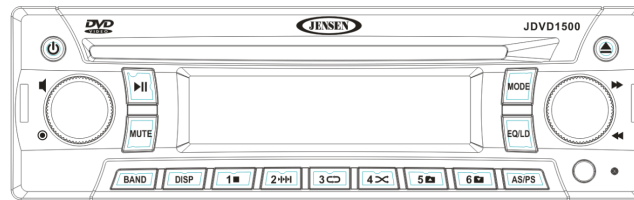

During DVD playback, you can use the following buttons to navigate the DVD, Root, or Title menu of the disc.

Control Panel

- Rotate the volume knob forward (19) to move through introductory chapters and access the DVD menu.
- Press the >|| button (5) to choose the highlighted item on the menu.

Remote Control (see "Remote Control Operation" on page 8)

- Use the directional buttons (◀, ▶, ▲, and ▼) on the remote control to navigate the menu.
- Press the ENTER button to confirm the selected item.

Controlling Disc Playback

When viewing the DVD or Root Menu, press the >|| button (5) to choose the highlighted item on the menu. Once playback begins, the LCD will display the *Chapter: Playback Time* in the following format: "001 00:03".

Play/Pause Disc Playback (1>||)

Press the 1>|| button (5) on the control panel (or the >|| button on the remote control) to suspend disc play.

Stop Disc Playback (■)

Press the ■ button(9) on the remote control to enter "RESUME STOP MODE." Press the >|| button to resume playback from the previous location.

Press the ■ button(9) twice consecutively to clear stop mode. With stop mode cleared, if the >|| button is pressed, the disc will resume playback from the beginning of the disc.

Chapter Select

Rotate the volume knob forward or backward one step on the control panel or remote control to advance to the next or previous chapter on the disc.

Fast Forward/Reverse

Press the ►► or ◀◀ button on the remote control to fast forward or fast reverse through the disc. Keep pressing and releasing the button to increase the rate from 2X to 4X, 8X, 16X and 32X. Press >|| on the remote control or >|| (5) on the control panel to resume normal playback.

Repeat Play (3/RPT)

Press the 3/RPT button (11) on the control panel (or the RPT button on the remote control) to select the repeat mode as follows:

DVD: RPT OFF > RPT CHAPTER > RPT TITLE > RPT ALL

VCD/CD: RPT OFF > RPT ONE > RPT ALL

- Select CHAPTER to continuously repeat the current chapter.
- Select TITLE to continuously repeat the current title.
- Select TRACK to continuously repeat the current track.
- Select ALL to continuously repeat all chapters/tracks on the current disc. After playing the last chapter/track, the unit will stop and display the elapsed time.

NOTE: The REPEAT feature does not support VCD 2.0 (with PBC ON).

Title Menu Function (DVD Only)

If the DVD has multiple titles recorded on the disc, you can select a specific title from the title menu from which to start playback.

1. Press the TITLE button on the remote control during playback to display the title menu.
2. Select the preferred title using the remote control arrow keys (24) and confirm by pressing the ENTER button.

PBC (Play Back Control) (VCD Only)

For VCDs with play back functionality, play back control (PBC) provides additional controls for VCD playback.

Press the MENU button on remote control to toggle the PBC function "On"/"Off". Once PBC is on, playback starts from track one of the play list.

NOTE: During VCD playback you can press the LANG button on the remote control during playback to switch the sound between mono and stereo sound in the following order: MONO LEFT > MONO RIGHT > MIX MONO > STEREO.

Remote Control Direct Track Entry

To select a track directly, use the number pad on the remote control. For single digit entries, press "0" followed by the single digit track number (for example, track 5 is entered as "05").

Goto Search

Perform the following steps to use the GOTO feature to access a specific location on a disc:

DVD Title/Chapter Search

To play a specific title/chapter:

1. Press the **GOTO** button. The on-screen display information will appear with the CHAPTER number highlighted (CHAPTER 00/00).
2. Use the arrow (<, >, ▲, ▼) buttons to move the cursor between the TITLE and CHAPTER fields.
3. Use the numeric buttons on the remote control to enter the desired title/chapter number.
4. Press the **ENTER** button. **DVD Time Search**

To enter an exact playback starting point:

1. Press the **GOTO** button twice for TITLE time or three times for CHAPTER time.
2. Use the arrow (<, >, ▲, ▼) buttons to move the cursor through the TIME field (00:00:00).
3. Use the numeric buttons on the remote control to enter the playback starting point.
4. Press the **ENTER** button.

CD/VCD Disc/Track Search

Press the **GOTO** button once for DISC GO TO, twice for TRACK GO TO or three times for SELECT TRACK.

- Choose DISC GO TO to select an exact playback starting point relative to the total playing time.
- Choose TRACK GO TO to select an exact playback starting time within the current track.
- Choose SELECT TRACK to enter a specific track number for playback.

Use the arrow (<, >, ▲, ▼) buttons to move the cursor through the time field (00:00:00). Use the numeric buttons on the remote control to enter the playback starting point and then press the **ENTER** button.

Programmed Playback

1. Press the **PROG** button (8) on the remote control to access the programmed playback screen:

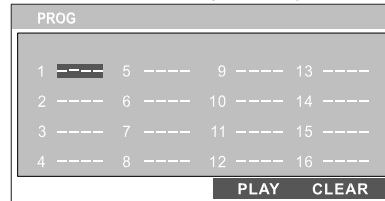

2. Use the , , ◀ ▶ ▲ or ▼ cursor buttons (16) on the remote control

the "PROG" screen.

3. Use the number buttons on the remote control to enter a track number in each field.
4. Press the >|| button (18) on the remote control or highlight "PLAY" on screen and then press the **ENTER** button (5) to begin playback in the numbered order indicated.

To delete the list, highlight "CLEAR" and then press **ENTER**. Press **PROG** to exit the programmed playback screen.

DVD Playback Features

The following remote control features, along with many others, are available during DVD playback (see "Remote Control Operation" on page 15 for complete functionality):

- LANG: Press to choose an alternate audio language, if available.
- SUBTITLE: Press to select an alternate subtitle language, if available.
- ANGLE: Press to select an alternate viewing angle, if available.
- ZOOM: Press to zoom the picture at ZOOM 2, ZOOM 3, ZOOM 4, ZOOM 1/2, ZOOM 1/3 or ZOOM 1/4, or select OFF to return to normal view.

NOTE: Feature availability is dependent upon DVD embedded information.

Playback Information

During DVD and VCD playback, press the button (28) on the remote control to display playback information on the screen, including the media playing and current playback time.



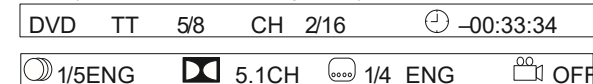

Continue pressing the button to display additional information, as indicated below. **DVD Playback Information**

The following information is displayed at the top of the screen during DVD playback:



- TT 5/8 – "5 / 8" indicates the fifth of 8 titles on the DVD is currently playing.
- CH 2/16 – "2 / 16" indicates that the second of 16 chapters on the DVD is currently playing.
- Press repeatedly to view the following information: for elapsed/remaining playing time:
 - 00:02:18 – total elapsed playing time for disc
 - C-00 :34 :37 – remaining playing time
 - T 00:02:18 – total elapsed playing time for current track





-  C -00 :34 :37 – remaining playing time for current track
-  1/5 ENG – English is the selected audio language out of 5 possible choices
-  5.1 CH – The current language is recorded in 5.1 surround sound
-  1/4 ENG – English is the selected subtitle language out of 4 possible choices
-  OFF – There are no alternate angles recorded for this scene

VCD Playback Information

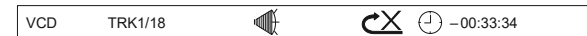
The following information is displayed at the top of the screen during VCD playback:



- TRK #### – “1/18” indicates the first of 18 tracks on the VCD is currently playing.
-  PBC: Indicates when PBC (Playback Control) is turned on.
- – “X” indicates repeat play is OFF, “1” indicates repeat track, “D” indicates repeat directory, and “A” indicates repeat disc.
- Press  repeatedly to view the following information for elapsed/remaining playing time:
- 00:02:18 – total elapsed playing time for disc



- C-00 :34 :37 – remaining playing time
- T 00:02:18 – total elapsed playing time for current track • C-00 :34 :37 – remaining playing time for current track

Remote Control Direct Track Entry

To select a track directly, use the number pad on the remote control (10). For single digit entries, press the corresponding number. For two digit entries, press the **10+** button followed by the last digit (i.e., for track 16, press **10+** and then **6**).

GOTO Direct Track/Chapter Access

Use the GOTO function to access a track (chapter) directly.

1. Press the **GOTO** button (26) on the remote control. The On Screen Display information will appear with the track number highlighted.
2. Use the number keys on the remote control to enter the 3-digit track number directly (i.e. for track 10, enter "010").
3. Press the **ENTER** button to confirm and begin playback.

BLUETOOTH OPERATION



Bluetooth Menu Options

NOTE: Please note that some Bluetooth menu options are only available while the unit is in Bluetooth Audio mode.

Press and hold the **Audio Control** button (3) to enter System adjustment mode. Repeatedly press the **Audio Control** button(3) to access the "BT ON/OFF" menu function. Rotate the volume control knob (4) to select BT ON. The following menu options are available when the unit is in BT mode.

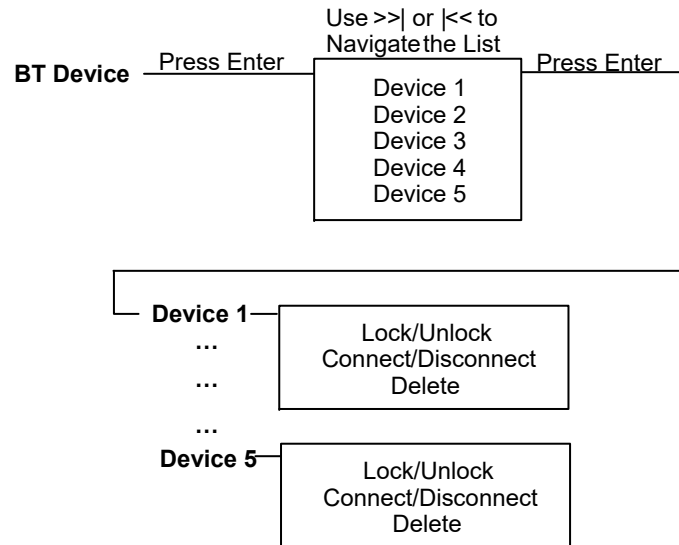

- **BT Pair:** Press the **Confirm** button(18) to start pairing with a Bluetooth enabled device.
- **BT Device:** Press the **Confirm** button(18) to view a list of previously paired mobile devices models. Rotate the **Fast forward/rewind and advance chapter/previous chapter knob**(19) to view devices from the list. You cannot

delete a device that is actively connected. Press the **Confirm** button(18) to select the device. Press the the **Fast forward/rewind and advance chapter/previous chapter knob** button(19) to choose Lock/Unlock, Disconnect/Cnnect or Delete for this device.

- **LOCK/UNLOCK:** The JDVD1500 can store up to 5 devices for Bluetooth connection. The devices are stored in FIFO (First In First Out) order. To prevent a device from being bumped from the list when more than 5 devices are used, you must lock the device. To Lock/Unlock a device, press the **Confirm** button(18) to change Lock or Unlocked.
- **DISCONNECT:** To disconnect a paired device, press the **Confirm** button(18) to temporarily remove the Bluetooth link. The link can be re-established through your phone menu by selecting the JDVD1500 for connection.

Press the  (setup) button on the remote control to access the SETUP menu. Use the arrow (<, >) buttons to choose between from the following menu categories:

- SYSTEM Setup
- LANGUAGE Setup
- AUDIO Setup
- Video Setup
- DIGITAL Setup

While in the setup menus, use the (<, >, \wedge , \vee) buttons to select options and change settings.

1. Use the \wedge (up) / \vee (down) buttons to select the setting to be changed.
2. Press **ENTER** to cycle through each possible option or display a list of the options. When a list of options appears, press the \wedge (up) / \vee (down) buttons to move among the displayed options.
3. Press **ENTER** again to choose the option and change the setting.

System Setup

The System Setup menu controls the following features:

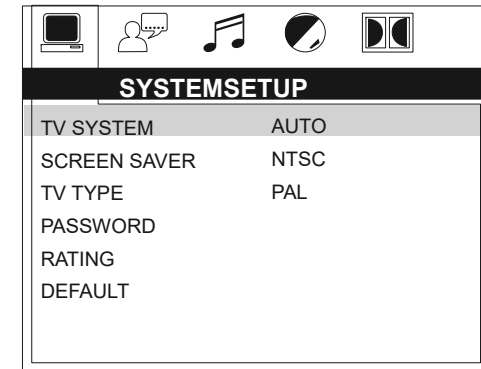

TV SYSTEM: This item is used to select a TV signal system to match your TV set. Select one of the following options: NTSC, PAL60, PAL or AUTO.

SCREEN SAVER: Turn Screen Saver feature On/Off.

TV TYPE: Select one of the following picture formats: 4:3PS, 4:3 LB or 16:9. 4:3 is a letterbox selection, and 16:9 is wide screen.

PASSWORD: This item allows the selection of a new four-digit code to use for security purposes.

SETUP MENU

RATING: Select the parental control level for all DVD play. The security password is required to make changes to this feature.

DEFAULT: Use this item to restore default settings at any time.

Language Setup

The Language Setup menu controls the following features:

LANGUAGESETUP	
OSD LANGUAGE	ENGLISH
AUDIO LANG	GERMAN
SUBTITLE LANG	SPANISH
MENU LANG	FRENCH

On-Screen Display (OSD) Language: Set the OSD language to one of the following: English, German, Spanish, French, or Portuguese.

Audio Language: Set the audio language to one of the following: English, Japan, French, Spanish, Portuguese, German or Latin.

Subtitle Language: Set the subtitle language to one of the following: English, Japan, French, Spanish, Portuguese, German or OFF.

Menu Language: Set the menu language to one of the following: English, Japan, French, Spanish, Portuguese, German or Latin.

Audio Setup

The Audio Setup menu controls the following features:

AUDIO SETUP	
AUDIO OUT	SPDIF/OFF
KEY	SPDIF/RAW
	SPDIF/PCM

Audio Out: This item defines the digital output format.

Key: This item changes the audio output key.

Video Setup

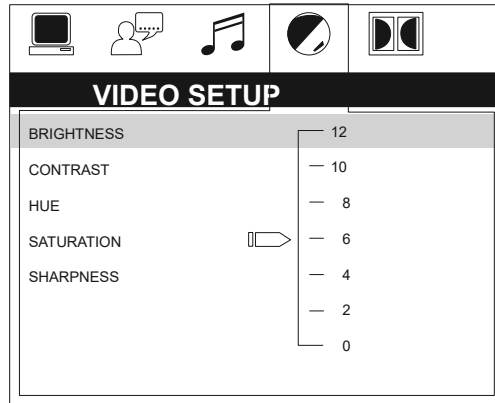

- Brightness: Adjust the brightness of the screen from the following levels: 12, 10, 8, 6, 4, 2 or 0.
- Contrast: Adjust the contrast of the screen from the following levels: 12, 10, 8, 6, 4, 2 or 0.
- Hue: Adjust the hue of the screen from the following levels: +6, +4, +2, 0, -2, -4 or -6.
- Saturation: Adjust the saturation of the screen from the following levels: 12, 10, 8, 6, 4, 2 or 0.
- Sharpness: Adjust the sharpness of the screen from the following levels: 8, 6, 4, 2 or 0.

Digital Setup

The Digital Setup menu controls the following features:

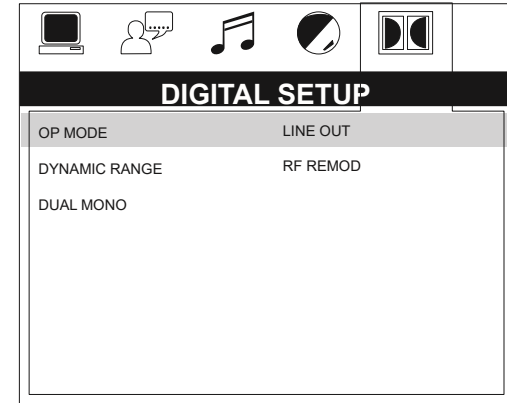

- OP Mode: Select LINE OUT or RF REMOD.
- Dynamic Range: Select FULL, 6/8, 4/8, 2/8 or OFF.
- Dual Mono: Select STEREO, MONO/L, MONO/R or MIX MONO.

TROUBLESHOOTING

Symptom	Cause	Solution
No power	The vehicle ignition is not on	If the power supply is properly connected to the vehicle accessory terminal, switch the ignition key to "ACC".
	The fuse is blown	Replace the fuse.
Disc cannot be loaded or ejected	Presence of CD disc inside the player	Remove the disc in the player and insert the new one.
	Inserting the disc in reverse direction	Insert the compact disc with the label facing upward.
	Compact disc is extremely dirty or disc is defective	Clean the disc or try to play a new one.
	Temperature inside the vehicle is too high	Wait until the ambient temperature returns to normal.
	Condensation	Leave the player off for an hour or so, then try again.

SPECIFICATIONS

DVD/CD



No sound	Volume is too low	Adjust volume to audible level.
	Wiring is not properly connected	Check wiring connections.
The operation keys do not work	Control panel not properly installed	Reinstall control panel.
	The built-in microcomputer is not operating properly due to noise	Press the RESET button.
Sound skips	The installation angle is more than 30 degrees	Adjust the installation angle to less than 30 degrees.
	The disc is dirty or defective	Clean the disc and try to play again or use new disc.
Cannot tune to radio station, auto-seek does not work	The antenna cable is not connected	Insert the antenna cable firmly.
	The signals are too weak	Select a station manually.
ERROR	Mechanism Error	Press the eject button to correct the problem. If the error code does not disappear, consult your nearest service dealer.
Disc Error	Disc is dirty/scratched/ upside down	Replace the disc.

Signal to Noise Ratio $\geq 90\text{dB}$
 Dynamic Range $\geq 90\text{dB}$ Frequency Response 20Hz to 20KHz +/- 3dB
 Channel Separation 2 Channel (Stereo) > 60dB @ 1KHz

Video

Color System NTSC/PAL Video
 Output Composite 1.0 Vp-p (+/- 0.2) 75 - ohm Video Input Vp-p (+/- 0.2) 75 - ohm

Audio

Max Output Power 40W x 4 channels Load Impedance (speakers) 4 ohms Line Out Level/Load 400mV/10k ohm load
 Line Out Impedance 200 ohm

Auxiliary Input

Frequency Response 20Hz to 20KHz $\pm 3\text{dB}$ Input Maximum Voltage 1200mV Input Impedance 4.7k ohm

FM Radio

Frequency Range 87.5-107.9 MHz (200 kHz Space) Usable Sensitivity $\leq 15\text{dB}$ at S/N 30 dBu Stereo Separation $\geq 25\text{ dB}$ at 1KHz S/N Ratio $\geq 50\text{dB}$

AM/MW

Frequency Range 530-1710 (10 kHz Space) Usable Sensitivity 20dBu

S/N Ratio $\geq 40\text{dB}$

General

Operating Voltage DC 11 -14.4V Grounding System Ground Fuse 15-Amp Mini ATM Type Operating Temperature 0°C to 50°C

Unit Mounting Angle $< 30^\circ$

STATEMENT

This device complies with Part 15 of the FCC rules. Operation is subject to the following two conditions: 1) this device may not cause harmful interference, and 2) this device must accept any interference received, including interference that may cause undesired operation.

changes or modifications not expressly approved by the party responsible for compliance could void the user's authority to operate the equipment.

This equipment has been tested and found to comply with the limits for a Class B digital device, pursuant to Part 15 of the FCC rules. These limits are designed to provide reasonable protection against harmful interference in a residential installation. This equipment generates, uses and can radiate radio frequency energy and if not installed and used in accordance with the instructions, may cause harmful interference to radio communications. However, there is no guarantee that interference will not occur in a particular installation. If this equipment does cause harmful interference to radio or television reception, which can be determined by turning the equipment off and on, the user is encouraged to try correct the interference by one or more of the following measures:

- Reorient the receiving antenna.
- Increase the separation between the equipment and receiver.
- Connect the equipment into and outlet on a circuit different from that to which the receiver is connected.
- Consult the dealer or an experienced radio/TV technician for help.

RF Exposure Statement

To maintain compliance with FCC's RF Exposure guidelines, This equipment should be installed and operated with minimum distance between 20cm the radiator your body: Use only the supplied antenna.

You are cautioned that changes or modifications not expressly approved by the party responsible for compliance could void your authority to operate the equipment.



ASA Electronics Corporation
www.asaelectronics.com www.jensenrvidirect.com

©2010 ASA Electronics Corporation

v.123010

24