

10.1-Inch LED Backlit LCD Roof-Mount
DVD Player With DVD/CD/MP3 SYSTEM



AVXMTG10UA

Audiovox **MTG**

OPERATION
MANUAL

TABLE OF CONTENTS

Important Notices.....	2
Congratulations.....	3
Features	3
Controls and Indicators Diagram.....	4
Remote Control Operation.....	6
DVD Basics	10
Loading and Playing Discs.....	12
Settings and Adjustments.....	12
Playing JPG Files	16
Playing MP3 Files	17
FM Modulator	17
Source Features	18
Troubleshooting.....	20
Specifications.....	22
Notes.....	23

IMPORTANT NOTICES

An LCD panel and/or video monitor may be installed in a motor vehicle and visible to the driver only if the LCD panel or video monitor is used for vehicle information, system control, rear or side observation or navigation. If the LCD panel or video monitor is used for television reception, video or DVD play, the LCD panel or video monitor must be installed so that these features will only function when the vehicle is in "park" or when the vehicle's parking brake is applied.

When connecting power and ground in a mobile video installation, insure that the ACC wire is fused at the point where it is connected to the vehicle's ACC wiring. Failure to do so can result in damage to the vehicle if a short circuit develops between the vehicle connection point and the mobile video product.

An LCD panel and/or video monitor used for television reception, video or DVD play that operates when the vehicle is in gear or when the parking brake is not applied must be installed to the rear of the driver seat where it will not be visible, directly or indirectly, to the operator of the motor vehicle.

WARNINGS

- Do not use any solvents or cleaning materials when cleaning the video monitor.
- Do not use any abrasive cleaners, they may scratch the screen.
- Use only lightly dampened lint free cloth to wipe the screen if it is dirty.
- Lock the LCD screen in fully closed position when not in use.
- Before putting on headphones, always adjust the volume setting to OFF or lowest position.
- Remember to leave the dome light switch in the off or auto position when the vehicle is unattended, as the dome lights, if left on, can drain the vehicle battery.
- Do not put pressure on the screen.
- Caution children to avoid touching or scratching the screen, as it may become dirty or damaged.

Safety Precautions

For safety reasons, when changing video media, it is recommended that the vehicle is not in motion, and that you do not allow children to unfasten seat-belts to change video media or make any adjustments to the system. System adjustments can be accomplished using the remote control, while seat-belts remain fastened. Enjoy your AUDIOVOX entertainment system but remember that the safety of all passengers remains the number one priority.

Licensed under one or more of the following patents, Patent Numbers 5,775,762, 5,927,784, and 6,678,892.

CONGRATULATIONS

Congratulations on your purchase of the AUDIOVOX AVXMTG10UA DVD player with Drop-Down Video/Monitor. The AVXMTG10UA player has been designed to give you and your family many years of video entertainment in the mobile environment. Please read the directions that follow in order to familiarize yourself with the product to ensure that you obtain the best results from your equipment.

FEATURES

- 10.1" TFT LCD monitor
- LED Backlight
- Built-in DVD Player
- Selectable (A and B) IR receive and transmit codes
- Multi-Lingual On Screen Display (OSD) for control of picture quality and functions
- Audio/Video source inputs
- Dome lights with built-in three way switch
- Last memory for DVD
- Built-in 16 channel frequency wireless FM modulator
- Headphone jack
- Screen mode selection (16:9, 4:3)
- Backlight controls
- Day/night picture modes
- A/V output
- USB/SD support

CONTROLS AND INDICATORS DIAGRAM

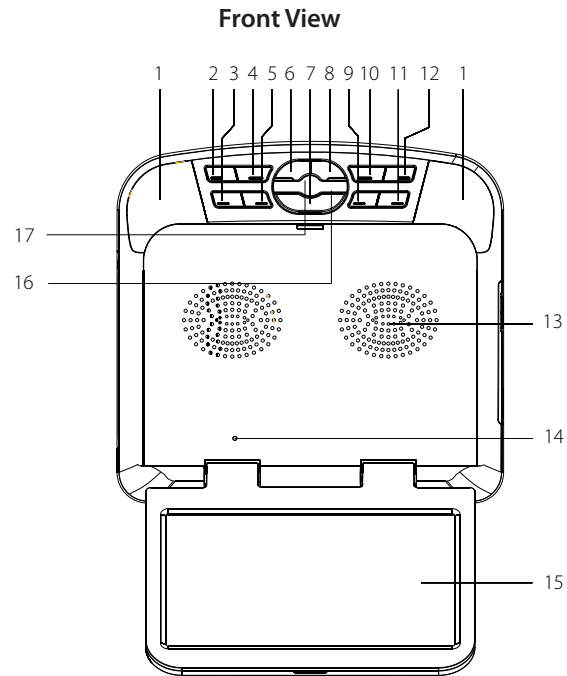

1. Dome Lights - Provides additional interior illumination.
2. SOURCE (S) Button - Press to select the source menu (DVD/AV IN/CARD/USB).
3. VOLUME (+) Button - Press this button to increase the volume or increase the level of selected picture controls.
4. PIC. Button - Press this button to enter the picture adjustment mode. Press to adjust in the following sequence: Brightness, Contrast, Color, Reset.
5. VOLUME (-) Button - Press this button to decrease the volume of wired headphones and decrease the level of selected picture controls.
6. PLAY/PAUSE (▶/⏸) Button - Press to start playback or to pause playing.
7. SCREEN RELEASE (PRESS) Button - Press this button to release the LCD screen. The screen will drop down slightly. Pivot the screen downward until a comfortable viewing angle is reached.
8. POWER (⏻) Button - Press this button to turn the system on or off. The button is lit blue when power is available.
9. FMM Button - Turns the wireless FM Modulator (FMM) on or off.
10. EJECT (▲) Button - Press this button to eject a disc from the disc compartment.
11. SCREEN MODE (◻) Button - Press this button to select Wide (16:9) or Normal (4:3) aspect ratios.
12. STOP (■) Button - Press this button to stop playback.
13. Ventilation Openings
14. LCD Cut Off Switch - Used to turn off the LCD screen when it is in the closed position.
15. 10" LCD Screen
16. Wireless Headphones Transmitter - Transmits audio to an optional wireless headphone.
17. Infrared Remote Sensor - Allows remote control to operate the unit.

Side Views

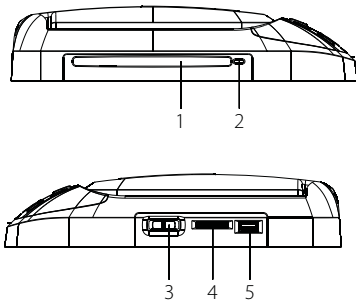

1. DVD Disc insertion Slot - For loading and removing disks. Turn the unit on before loading a disc. Insert a disc with the label facing up towards the headliner. The player will load a disc when a disc is inserted.
2. DISC Indicator light - Illuminates when a disc is inserted.
3. Three Position Dome Light Switch:
ON - Turn on the dome lights.
OFF - The dome Lights will not turn on in this position.
AUTO - Automatically switches on the dome lights in conjunction with the vehicle's interior illumination.
4. SD Card Slot - Insert SD card for playback of audio/video files.
5. USB 2.0 Port - Insert USB device for playback of audio/video files.

Back View

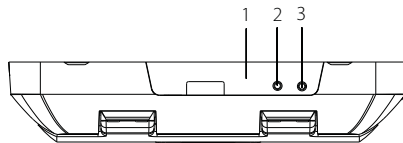

1. Infrared Remote Sensor - Allows the remote control to operate the unit.
2. A/V IN Jack - This jack is used for audio and video input.
3. Headphone Jack - Allows the use of wired headphones with a 1/8" (3.5 mm) plug for listening to audio output.

REMOTE CONTROL OPERATION

Battery Installation

Before attempting to operate your remote control, install the battery as described below:

1. Using your finger, press the tab (1) down in the direction of the arrow.
2. Slide the battery holder (2) out in the direction of the arrow.
3. Install one CR2025 battery. Make sure that the proper polarity (+ or -) is observed.
4. Slide the battery holder into the remote control until it locks.

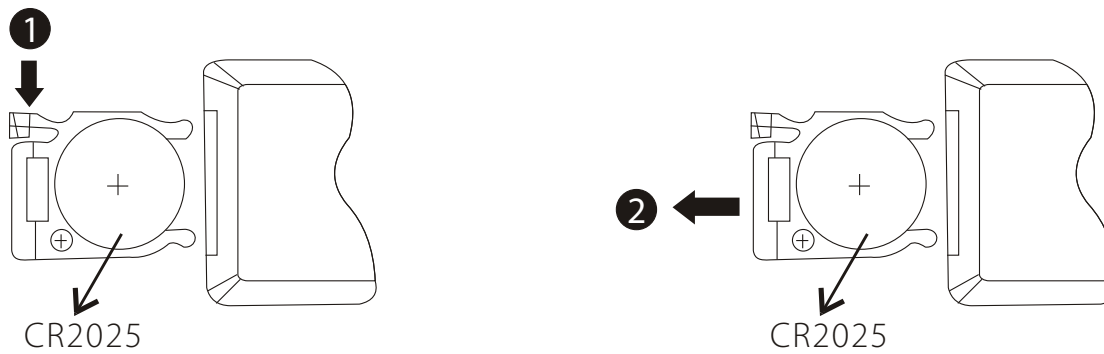

Back View

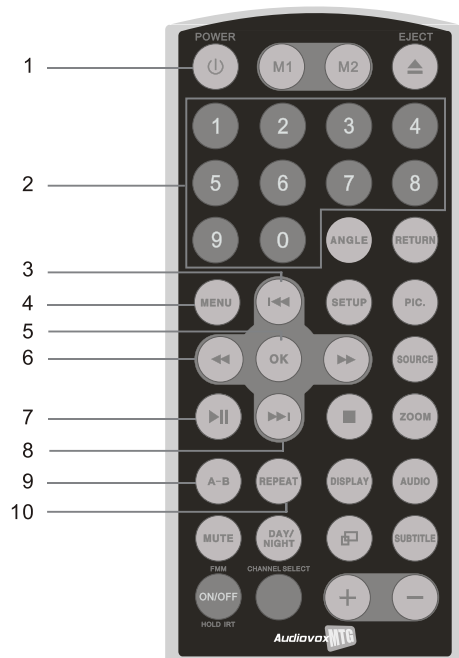

Remote Control Functional Description

1. POWER (⏻) Button - Press this button to turn the unit ON and OFF.
2. NUMBER Buttons - Press to enter the numbers 0 to 9 for selection of CD tracks, DVD chapters or password setting.
3. PREVIOUS/UP CURSOR (⏮) Button - Go to the previous chapter or track. The cursor is used to select menus on the screen.
4. MENU Button - Press this button to access the DVD root menu (DVD MODE).
5. OK Button - Used to implement a selected setting or menu option.
6. SCAN BACKWARD/LEFT CURSOR (⏪) Button - Scans backward at 2, 4, 8, 16, and 32 times speed. The cursor is used to select menus on the screen.
7. PLAY/PAUSE (⏮) Button - Used to start playback or pause playing.
8. NEXT/DOWN CURSOR (⏩) Button - Go to the next chapter or track. The cursor is used to select menus on the screen.
9. A-B Button - Allows the user to repeat the playback from point A to point B.
 Press DVD Player
 Once Repeat A - Marks the beginning of the section to repeat (set point A).
 Twice Repeat AB - Marks the end of the section to repeat (set point B).
 3 times Repeat Off - Cancels the A-B repeat function.
10. REPEAT Button - Allows the user to repeat a selected title, chapter or track. For MP3 disc, press "REPEAT" to repeat playing present file; press it again to repeat playing the folder.

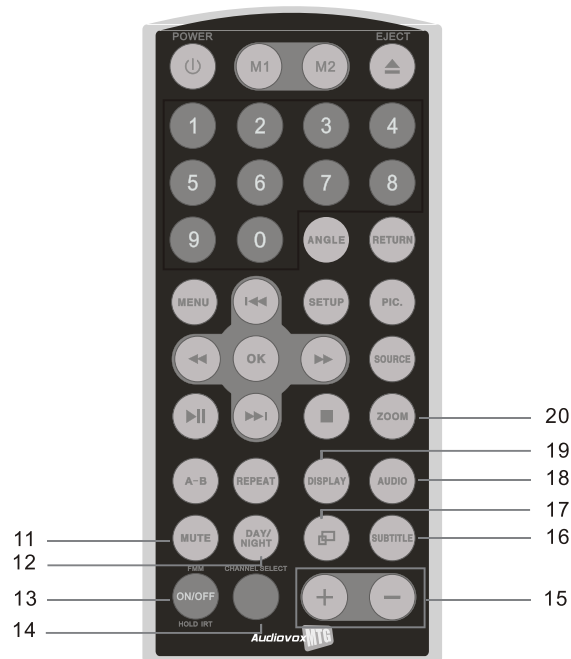

Remote Control Functional Description

11. MUTE Button - Press this button to mute the audio.
12. DAY/NIGHT Button- This control toggles the unit between "DAY" and "NIGHT" LCD illumination modes. In the "DAY" mode, the LCD backlight intensity is at maximum. In the "NIGHT" mode, the LCD backlight is dimmed to a preset level that is more suitable for low light operation.
13. FMM ON/OFF Button - Turns the wireless FM Modulator ON or OFF. Press and hold to turn the IR Modulator ON or Off.
14. CHANNEL SELECT Button - Selects the wireless FM Modulator Frequency.

Ch 1	88.1 MHz,	Ch 2	88.3 MHz,	Ch 3	88.5 MHz,
Ch 4	88.7 MHz,	Ch 5	88.9 MHz,	Ch 6	89.1 MHz,
Ch 7	89.3 MHz,	Ch 8	89.5 MHz,	Ch 9	89.7 MHz,
Ch 10	89.9 MHz,	Ch 11	90.1 MHz,	Ch 12	90.3 MHz,
Ch 13	90.5 MHz,	Ch 14	90.7 MHz,	Ch 15	90.9 MHz,
Ch 16	91.1 MHz				
15. VOLUME (+ / -) Button - Press to increase or decrease the volume level, or increase or decrease the level of the selected the picture adjustment.
16. SUBTITLE Button - Press to display and select an available subtitle language in DVD mode.
17. SCREEN MODE SELECTION (■) Button - Press this button to switch between Wide (16:9) or Normal (4:3) aspect ratios.
18. AUDIO Button - Press this button to display and select an available audio language in DVD mode.
19. DISPLAY Button - Press this button to display current disc information while the disc is playing.
20. ZOOM Button - Press this button to change picture size when playing a DVD disc.

Press: DVD player performs:

Once	Enlarges the picture to 2 times the original size.
Twice	Enlarges the picture to 3 times the original size.
3 times	Enlarges the picture to 4 times the original size.
4 times	Reduces the picture to 1/2 times the original size.
5 times	Reduces the picture to 1/3 times the original size.
6 times	Reduces the picture to 1/4 times the original size.
7 times	Picture returns to the original size.

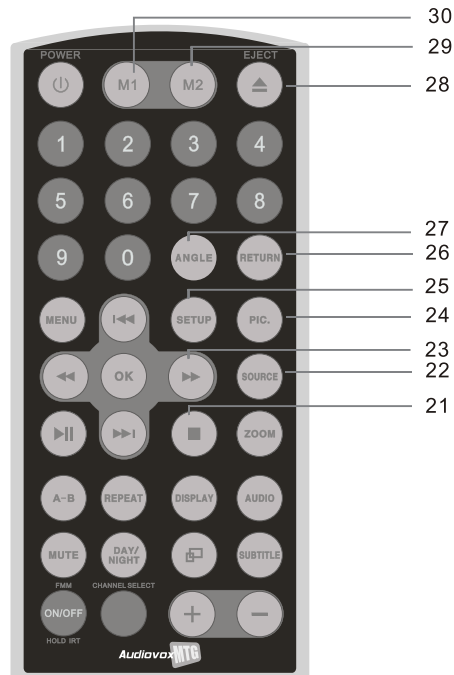

Remote Control Functional Description

21. STOP (■) Button - Press this button to stop playback.
22. SOURCE Button - Press to select the source menu (DVD/AV IN/CARD/USB).
23. SCAN FORWARD/RIGHT CURSOR (▶▶) Button - Scan forward at 2, 4, 8, 16, and 32 times speed. The cursor is used to select menus on the screen.
24. PIC. Button - Press this button to enter the picture adjustment mode Press repeatedly to adjust in the following sequence: Brightness, Contrast, Color, Reset. Once the desired adjustment bar is displayed, use the VOLUME (+)/VOLUME (-) button to adjust the setting. The display will automatically turn off in 6 seconds, or if any other button is pressed.
25. SETUP Button - Press this button to display the setup menu. The setup menu allows the user to change DVD player options such as OSD LANGUAGE, PARENTAL CONTROL, etc.
26. RETURN Button:
Press Return once: Go to disc menu.
Press Return twice: Go to movie playback.
27. ANGLE Button - Press this button to display and select different camera angles in DVD mode. Not all discs contain this option.
28. EJECT (▲) Button - Press this button to eject the disc.
29. M2 Button- Press and hold this button to select the infrared transmitter (IRT) band M2.
30. M1 Button- Press and hold this button to select the infrared transmitter (IRT) band M1.

DVD BASICS

To get the optimum use out of the DVD player, please read this section.

DVD Region Code

The DVD player is preset to a region code at the factory depending on where the unit is sold. DVDs are also coded by region. These region codes must match in order for the disc to play. If the region codes do not match, the disc will not play. This system is set to Region 1 (USA) and will not play discs that have a region code different from Region 1. The system will display "WRONG REGION."

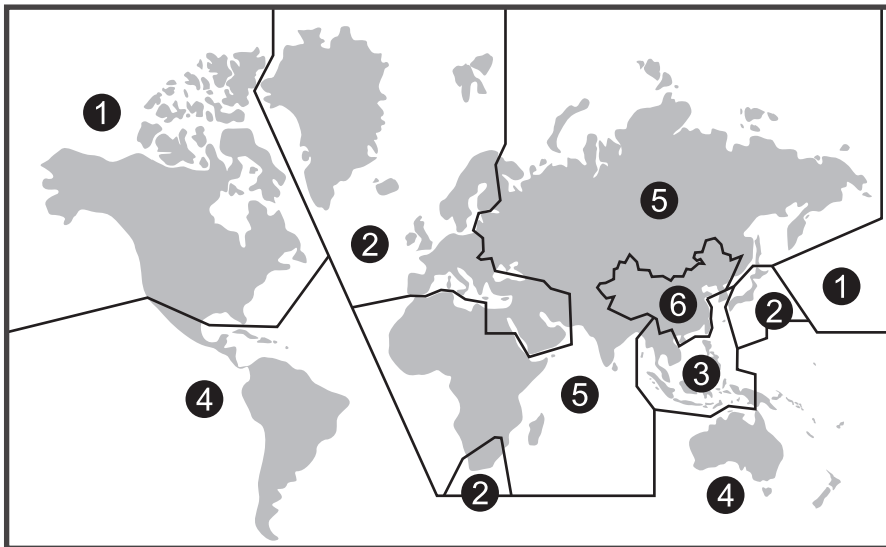

- Region 1 - USA, Canada
- Region 2 - Japan, Europe, South Africa, Middle East, Greenland
- Region 3 - South Korea, Taiwan, Hong Kong, Parts of South East Asia
- Region 4 - Australia, New Zealand, Latin America (including Mexico)
- Region 5 - Eastern Europe, Russia, India, Africa
- Region 6 - China

Types of Discs Your System Will Play

Your system will play the following types of discs:

- DVD disc - DVD discs that contain video.
- Audio discs - Audio CDs that contain musical or sound content only.
- MP3 discs - A disc that contains audio files (for example, a CD-R with downloaded MP3 files).

This unit is capable of playing most recordable DVD formats. However, due to the variety of disc manufacturers and software, playback can not be guaranteed for every disc.

Disc Compatibility

Before a disc is loaded, make sure that it is compatible with the player. The following discs can not be played with this player:

- MiniDisc
- Laserdisc
- CD-I, CD-ROM, DVD-ROM, Super Audio CD (SACD) or DVD Audio
- Blu-ray (BD) Disc™

LOADING AND PLAYING DISCS

1. Press the Screen Release (PRESS) button to unlock the LCD screen. The LCD screen will drop down slightly.
2. Pivot the screen downward until a comfortable viewing angle is reached. The hinge friction will hold the screen in position while the unit is in use.
3. Press the power (⏻) button on the unit or remote control to turn the unit on.
4. Insert a disc into the disc insertion slot with the label facing up towards the headliner.
5. After the unit has been turned on and is displaying a picture, adjust the viewing angle. Pivot the screen to optimize the picture quality.
6. Remember to turn the unit off and pivot the screen to the locked position when not in use.

SETTINGS AND ADJUSTMENTS

The General, Password or Preference Setup Page menus contains features and options that let you customize your DVD player. For example, you can choose a language for the On Screen Display (OSD) or control DVD playback content for children.

Main Menu

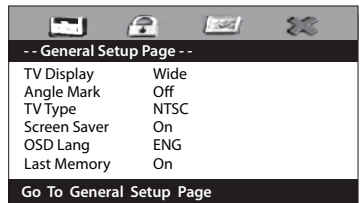
	<ol style="list-style-type: none">1. Press the "SETUP" button. The Main Menu will appear on the screen.2. Press the "◀◀" or "▶▶" button to select the General, Password or Preference Setup Pages.3. Press the "OK" button to access the selected setup page.4. Press the "◀◀" or "▶▶" cursor button to select a menu item. The item is highlighted in green.5. Press the "▶▶" cursor button to enter the option submenu.6. Press the "◀◀" or "▶▶" cursor button to select an option. The option is highlighted in green.7. Press the "OK" button to confirm your selection. The selection is highlighted in red.8. Press the "◀◀" cursor button to return to the setup page or press the "SETUP" button to exit.
--	--

General Setup Page Menu

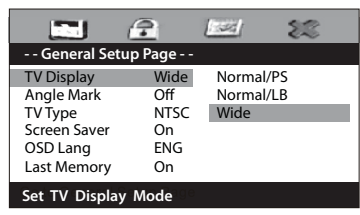
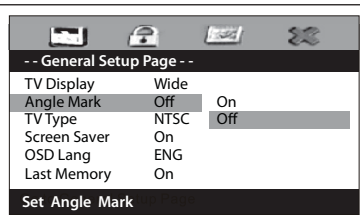
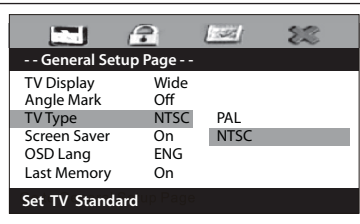
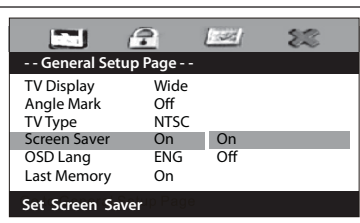
 <p>-- General Setup Page --</p> <table border="1"> <tr><td>TV Display</td><td>Wide</td><td>Normal/PS</td></tr> <tr><td>Angle Mark</td><td>Off</td><td>Normal/LB</td></tr> <tr><td>TV Type</td><td>NTSC</td><td>Wide</td></tr> <tr><td>Screen Saver</td><td>On</td><td></td></tr> <tr><td>OSD Lang</td><td>ENG</td><td></td></tr> <tr><td>Last Memory</td><td>On</td><td></td></tr> </table> <p>Set TV Display Mode</p>	TV Display	Wide	Normal/PS	Angle Mark	Off	Normal/LB	TV Type	NTSC	Wide	Screen Saver	On		OSD Lang	ENG		Last Memory	On		<p>TV Display</p> <p>This item allows you to set the screen display format. Optional Settings: Normal/PS, Normal/LB, Wide The default setting is Wide. Note: This function depends on the aspect ratio with which the DVD disc is recorded.</p>
TV Display	Wide	Normal/PS																	
Angle Mark	Off	Normal/LB																	
TV Type	NTSC	Wide																	
Screen Saver	On																		
OSD Lang	ENG																		
Last Memory	On																		
 <p>-- General Setup Page --</p> <table border="1"> <tr><td>TV Display</td><td>Wide</td><td></td></tr> <tr><td>Angle Mark</td><td>Off</td><td>On</td></tr> <tr><td>TV Type</td><td>NTSC</td><td>Off</td></tr> <tr><td>Screen Saver</td><td>On</td><td></td></tr> <tr><td>OSD Lang</td><td>ENG</td><td></td></tr> <tr><td>Last Memory</td><td>On</td><td></td></tr> </table> <p>Set Angle Mark</p>	TV Display	Wide		Angle Mark	Off	On	TV Type	NTSC	Off	Screen Saver	On		OSD Lang	ENG		Last Memory	On		<p>Angle Mark</p> <p>This item allows you to turn angle mode playback on or off. Angle mode allows you to select different camera angles in DVD playback. Optional settings: On, Off The default setting is Off. Note: The number of angles vary from disc to disc. Not all discs contain this option.</p>
TV Display	Wide																		
Angle Mark	Off	On																	
TV Type	NTSC	Off																	
Screen Saver	On																		
OSD Lang	ENG																		
Last Memory	On																		
 <p>-- General Setup Page --</p> <table border="1"> <tr><td>TV Display</td><td>Wide</td><td></td></tr> <tr><td>Angle Mark</td><td>Off</td><td></td></tr> <tr><td>TV Type</td><td>NTSC</td><td>PAL</td></tr> <tr><td>Screen Saver</td><td>On</td><td>NTSC</td></tr> <tr><td>OSD Lang</td><td>ENG</td><td></td></tr> <tr><td>Last Memory</td><td>On</td><td></td></tr> </table> <p>Set TV Standard</p>	TV Display	Wide		Angle Mark	Off		TV Type	NTSC	PAL	Screen Saver	On	NTSC	OSD Lang	ENG		Last Memory	On		<p>TV Type</p> <p>This item allows you to select a TV type. Optional Settings: PAL, NTSC The default setting is NTSC. Note: For best system performance, the selected setting should remain at NTSC.</p>
TV Display	Wide																		
Angle Mark	Off																		
TV Type	NTSC	PAL																	
Screen Saver	On	NTSC																	
OSD Lang	ENG																		
Last Memory	On																		
 <p>-- General Setup Page --</p> <table border="1"> <tr><td>TV Display</td><td>Wide</td><td></td></tr> <tr><td>Angle Mark</td><td>Off</td><td></td></tr> <tr><td>TV Type</td><td>NTSC</td><td></td></tr> <tr><td>Screen Saver</td><td>On</td><td>On</td></tr> <tr><td>OSD Lang</td><td>ENG</td><td>Off</td></tr> <tr><td>Last Memory</td><td>On</td><td></td></tr> </table> <p>Set Screen Saver</p>	TV Display	Wide		Angle Mark	Off		TV Type	NTSC		Screen Saver	On	On	OSD Lang	ENG	Off	Last Memory	On		<p>Screen Saver</p> <p>This item allows you to turn the screen saver on or off. Optional Settings: On, Off The default setting is On. Note: The DVD player will enter screen saver mode if the unit is inactive for approximately four minutes.</p>
TV Display	Wide																		
Angle Mark	Off																		
TV Type	NTSC																		
Screen Saver	On	On																	
OSD Lang	ENG	Off																	
Last Memory	On																		



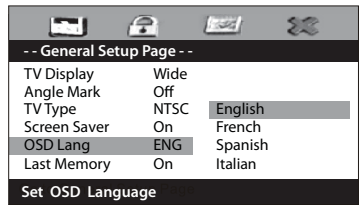
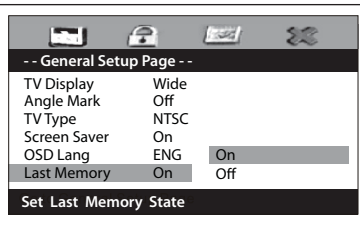

General Setup Page Menu (continued)

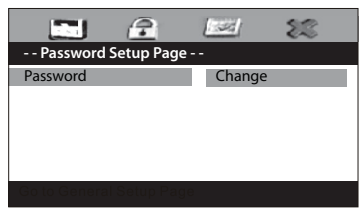
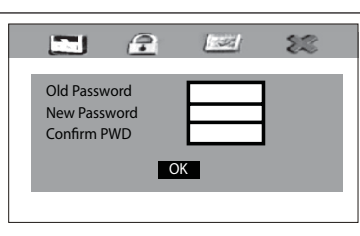
 <p>-- General Setup Page --</p> <table border="0"> <tr><td>TV Display</td><td>Wide</td></tr> <tr><td>Angle Mark</td><td>Off</td></tr> <tr><td>TV Type</td><td>NTSC English</td></tr> <tr><td>Screen Saver</td><td>On French</td></tr> <tr><td>OSD Lang</td><td>ENG Spanish</td></tr> <tr><td>Last Memory</td><td>On Italian</td></tr> </table> <p>Set OSD Language</p>	TV Display	Wide	Angle Mark	Off	TV Type	NTSC English	Screen Saver	On French	OSD Lang	ENG Spanish	Last Memory	On Italian	<p>OSD Language</p> <p>This item allows you to choose an On Screen Display menu language. Optional Settings: English, Spanish, French, Italian The default setting is English.</p>
TV Display	Wide												
Angle Mark	Off												
TV Type	NTSC English												
Screen Saver	On French												
OSD Lang	ENG Spanish												
Last Memory	On Italian												
 <p>-- General Setup Page --</p> <table border="0"> <tr><td>TV Display</td><td>Wide</td></tr> <tr><td>Angle Mark</td><td>Off</td></tr> <tr><td>TV Type</td><td>NTSC</td></tr> <tr><td>Screen Saver</td><td>On</td></tr> <tr><td>OSD Lang</td><td>ENG On</td></tr> <tr><td>Last Memory</td><td>On Off</td></tr> </table> <p>Set Last Memory State</p>	TV Display	Wide	Angle Mark	Off	TV Type	NTSC	Screen Saver	On	OSD Lang	ENG On	Last Memory	On Off	<p>Last Memory</p> <p>This item allows you to turn the Last Memory feature on or off. When the Last Memory feature is on, video will resume playback from its last location if power is interrupted and restored. Optional Settings: On, Off The default setting is On.</p>
TV Display	Wide												
Angle Mark	Off												
TV Type	NTSC												
Screen Saver	On												
OSD Lang	ENG On												
Last Memory	On Off												

Password Setup Page Menu

 <p>-- Password Setup Page --</p> <p>Password Change</p>	<p>Password</p> <p>This item allows you to set a four number password.</p> <ol style="list-style-type: none"> 1. Select the Change option. 2. Press the "OK" button. The Change Password screen appears. <p>Note: The default password is 3308. This password is always accepted even after a new password has been entered. To avoid the possibility of others using the default password to change passwords, record this default password in another area and delete it from this manual.</p>
 <p>Old Password <input type="text"/></p> <p>New Password <input type="text"/></p> <p>Confirm PWD <input type="text"/></p> <p>OK</p>	<p>Change Password</p> <ol style="list-style-type: none"> 1. Enter the default or old four number password. The "Please Enter New Password" prompt appears. 2. Enter a new four number password. The "Please Reenter Password" prompt appears. 3. Reenter the password again. The "Change" prompt appears. 4. Press the "OK" button.

Preference Page Menu

 <p>-- Preference Page --</p> <table border="0"> <tr><td>Audio</td><td>ENG</td><td>English</td></tr> <tr><td>Subtitle</td><td>OFF</td><td>French</td></tr> <tr><td>Disc Menu</td><td>ENG</td><td>Spanish</td></tr> <tr><td>Parental</td><td></td><td>Italian</td></tr> <tr><td>Default</td><td></td><td></td></tr> </table> <p>Preferred Audio Language</p>	Audio	ENG	English	Subtitle	OFF	French	Disc Menu	ENG	Spanish	Parental		Italian	Default			<p>Audio</p> <p>This item allows you to select an audio language for DVD playback. The audio language depends on the information available on each disc.</p> <p>Optional Settings: English, Spanish, French, Italian.</p> <p>The default setting is English.</p> <p>Note: You can also change the audio language during playback by pressing the Audio button.</p>																	
Audio	ENG	English																															
Subtitle	OFF	French																															
Disc Menu	ENG	Spanish																															
Parental		Italian																															
Default																																	
 <p>-- Preference Page --</p> <table border="0"> <tr><td>Audio</td><td>ENG</td><td></td></tr> <tr><td>Subtitle</td><td>OFF</td><td>English</td></tr> <tr><td>Disc Menu</td><td>ENG</td><td>French</td></tr> <tr><td>Parental</td><td></td><td>Spanish</td></tr> <tr><td>Default</td><td></td><td>Italian</td></tr> <tr><td></td><td></td><td>Off</td></tr> </table> <p>Preferred Subtitle Language</p>	Audio	ENG		Subtitle	OFF	English	Disc Menu	ENG	French	Parental		Spanish	Default		Italian			Off	<p>Subtitle</p> <p>This item allows you to select a subtitle language to be shown on the screen. The subtitle language depends on the information available on each disc.</p> <p>Optional Settings: English, Spanish, French, Italian, Off.</p> <p>The default setting is Off.</p> <p>Note: You can also change the subtitle language during playback by pressing the Subtitle button.</p>														
Audio	ENG																																
Subtitle	OFF	English																															
Disc Menu	ENG	French																															
Parental		Spanish																															
Default		Italian																															
		Off																															
 <p>-- Preference Page --</p> <table border="0"> <tr><td>Audio</td><td>ENG</td><td></td></tr> <tr><td>Subtitle</td><td>OFF</td><td></td></tr> <tr><td>Disc Menu</td><td>ENG</td><td>English</td></tr> <tr><td>Parental</td><td></td><td>French</td></tr> <tr><td>Default</td><td></td><td>Spanish</td></tr> <tr><td></td><td></td><td>Italian</td></tr> </table> <p>Preferred Menu Language</p>	Audio	ENG		Subtitle	OFF		Disc Menu	ENG	English	Parental		French	Default		Spanish			Italian	<p>Disc Menu</p> <p>This item allows you to choose the menu language stored on the disc.</p> <p>Optional Settings: English, Spanish, French, Italian</p> <p>The default setting is English.</p> <p>Note: This function is only available for DVD playback.</p>														
Audio	ENG																																
Subtitle	OFF																																
Disc Menu	ENG	English																															
Parental		French																															
Default		Spanish																															
		Italian																															
 <p>-- Preference Page --</p> <table border="0"> <tr><td>Audio</td><td>ENG</td><td>1</td><td>KID SAFE</td></tr> <tr><td>Subtitle</td><td>OFF</td><td>2</td><td>G</td></tr> <tr><td>Disc Menu</td><td>ENG</td><td>3</td><td>PG</td></tr> <tr><td>Parental</td><td></td><td>4</td><td>PG 13</td></tr> <tr><td>Default</td><td></td><td>5</td><td>PGR</td></tr> <tr><td></td><td></td><td>6</td><td>R</td></tr> <tr><td></td><td></td><td>7</td><td>NC 17</td></tr> <tr><td></td><td></td><td>8</td><td>ADULT</td></tr> </table> <p>Set Parental Control</p>	Audio	ENG	1	KID SAFE	Subtitle	OFF	2	G	Disc Menu	ENG	3	PG	Parental		4	PG 13	Default		5	PGR			6	R			7	NC 17			8	ADULT	<p>Parental</p> <p>This function prevents children from watching unsuitable DVD content. You can limit the content of movie playback from 1. Kid Safe to 8. Adult. The lower the value, the more strict the control. The restriction of viewing disc content by younger viewers may be available on some discs but not others.</p> <p>Optional Settings: 1. KID SAFE; 2. G; 3. PG; 4. PG 13; 5. PGR; 6. R; 7. NC 17; 8. ADULT.</p> <p>The default setting is 8. ADULT.</p> <p>Note: Parental Control features are password protected. The rating level can only be changed when the correct password is entered.</p>
Audio	ENG	1	KID SAFE																														
Subtitle	OFF	2	G																														
Disc Menu	ENG	3	PG																														
Parental		4	PG 13																														
Default		5	PGR																														
		6	R																														
		7	NC 17																														
		8	ADULT																														

Preference Page Menu (continued)

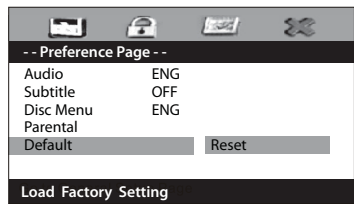
	Default <p>This item allows you to reset all settings to the original factory settings. Select this item and press the "OK" button. Note: This function does not reset the Parental level to the original factory setting.</p>
---	---

PLAYING JPG FILES

1. Place a JPG disc into the disc insertion slot, the unit will start reading the disc and play.
2. Press the "MENU" button to browse JPG files.
3. Press the "◀◀" or "▶▶" cursor button to select a JPG file and press the "OK" button to confirm.
4. Press the "◀◀" cursor button to rotate the picture counter-clockwise; press the "▶▶" cursor button to rotate the picture clockwise.
5. Press the "DISPLAY" button when viewing pictures. You can select different refresh modes as follows:
 - a. Wipe Top
 - b. Wipe Bottom
 - c. Wipe Left
 - d. Wipe Right
 - e. Diagonal Wipe Left Top
 - f. Diagonal Wipe Right Top
 - g. Diagonal Wipe Left Bottom
 - h. Diagonal Wipe Right Bottom
 - i. Extend From Center Horizontal
 - j. Extend From Center Vertical
 - k. Compress to Center Horizontal
 - l. Compress to Center Vertical
 - m. Window Horizontal
 - n. Window Vertical
 - o. Wipe From Edge to Center
 - p. Move In From Top
6. When viewing files, "Ø" may appear when pressing "Subtitle" or "Audio" etc. In this situation, these options are unavailable.
7. When viewing JPG files, press "■" Pictures will be displayed in thumbnail mode. Press "◀◀▶▶/◀◀/▶▶" or press the "OK" button to select one picture to view

PLAYING MP3 FILES

MP3 is a format for storing digital audio. An audio CD-quality song can be compressed into the MP3 format with very little loss of quality, while taking up much less space. CD-R discs that have been encoded in MP3 format can be played on a DVD player. The DVD player plays the songs in the order they were burned on to the disc. When playback is started, the elapsed time of the track that is playing will be displayed.

1. Place a MP3 disc into the disc insertion slot, insert a USB drive into the USB port, or insert a SD card into the SD card slot.
2. Press the "⏮/⏭" cursor button or the "OK" button to choose a MP3 file.
3. Press the "▶" button or the "OK" button to play the selected file.

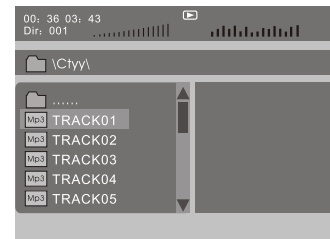

FM MODULATOR

The FM Modulator allows the user to listen to audio through the vehicle's radio. To choose a FM frequency for audio playback through the vehicle's radio:

1. On the remote control, press the FMM ON/OFF button until FM ON appears on the screen.
2. Press the CHANNEL SELECT button to select the FM Modulator frequency. Choose a frequency not used by a radio station in the area.

CH 1	88.1 MHz,	CH 2	88.3 MHz,	CH 3	88.5 MHz,
CH 4	88.7 MHz,	CH 5	88.9 MHz,	CH 6	89.1 MHz,
CH 7	89.3 MHz,	CH 8	89.5 MHz,	CH 9	89.7 MHz,
CH10	89.9 MHz,	CH 11	90.1 MHz,	CH 12	90.3 MHz,
CH 13	90.5 MHz,	CH 14	90.7 MHz,	CH 15	90.9 MHz,
CH 16	91.1 MHz				
3. Tune your vehicle's radio to the selected frequency.

SOURCE FEATURES

1. Press the "SOURCE" button on the unit or remote control. The following menu will appear on the screen:

DVD
AV IN
CARD
USB

2. Press the "◀◀" or "▶▶" cursor button to choose an item.
3. Press the "OK" button.

DVD

If a disc is loaded into the unit when the source is set to CARD or USB, the unit will automatically switch the source over to DVD.

Last Memory for the DVD mode: If the unit is turned off and then on, and the DVD disc is not removed, the unit will play the DVD from the point it stopped last time.

AV IN

The unit will accept an audio/video input through the AV In jack located on the rear of the unit. The audio/video device can be a video game system, video camera or other input device.

CARD

Insert a SD card (compatible with normal SD/MMC) and play the content.

Supported formats: MP3, JPEG, AVI, MPEG I, MPEG II etc.

USB

Insert a USB device and play the content.

Supported formats: MP3, JPEG, AVI, MPEG I, MPEG II etc.

Overhead Dome Lights

The Dome Lights integrated into the unit are controlled by a three position slide switch. Sliding the switch to the ON position will turn the light ON. The OFF position will prevent the lights from turning ON with the vehicle interior lighting. The AUTO position will allow the lights to turn ON and OFF with the vehicle interior lighting.

Refer to the installation guide for wire connections. Do not leave the vehicle unattended with the dome light switch in the ON position, as this could discharge the battery.

Infrared Remote Sensors

The unit incorporates two infrared remote sensors which relay signals from the remote control to allow the unit to be controlled simply by pointing its remote control at the remote sensor. The infrared sensor can relay signals from most manufacturer's remote control to its respective component connected to the AV input. In this case, you must use the remote control supplied with the component.

Optional IR Headphones

Optional IR (infrared) headphones are available. Part numbers:

- IR1C
- IR1CFF
- IR2CFF*

* Required if the unit is set to IRT-B setting.

TROUBLESHOOTING

Problem	Solution
IR remote is inoperative.	<ol style="list-style-type: none"> 1. Verify that the batteries in the remote are fresh. 2. Verify that the infrared remote sensor is not obstructed.
Disc will not play or wrong region is displayed.	<ol style="list-style-type: none"> 1. Insert a disc with the label side facing up towards the headliner. 2. Check the type of the disc you put into the disc tray. This DVD only plays DVD, audio CD, JPEG, and MP3. Blu-ray discs will not play in this player. 3. Both the unit and the disc are coded by region. If the regional code doesn't match, the disc can't be played.
No Disc error message appears.	<ol style="list-style-type: none"> 1. Insert a disc with the label side facing up towards the headliner.
Play starts, but then stops immediately.	<ol style="list-style-type: none"> 1. The disc is dirty. Clean it. 2. The disc is damaged. Try another disc. 3. Condensation has formed. Allow player to dry out.
No sound or distorted sound.	<ol style="list-style-type: none"> 1. Make sure your DVD is connected properly. Make sure all cables are securely inserted into the appropriate jacks. 2. If you are using 2-channel IR headphones, make sure you turn on the IR headphone power. Make sure the correct channel (A-B) is selected. 3. Make sure the modulator is ON and the proper frequency has been selected on the vehicle's radio. 4. Make sure the IR transmitter has been turned on.
Can't advance through a movie.	<ol style="list-style-type: none"> 1. You can't advance through the opening credits and warning information that appears at the beginning of a movie because the disc is programmed to prohibit that action.
The icon (Ⓢ) appears on screen.	<p>The feature or action cannot be completed at this time because:</p> <ol style="list-style-type: none"> 1. The disc's software restricts it. 2. The disc's software doesn't support the feature (for example, angles). 3. The feature is not available at the moment. 4. You have requested a title or chapter number that is out of the range.
No forward or reverse scan.	<ol style="list-style-type: none"> 1. Some discs have sections that prohibit rapid scanning or title and chapter skip. 2. If you try to skip through the warning information and credits at the beginning of a movie, you won't be able to. This part of the movie is often programmed to prohibit skipping through it.

Problem	Solution
Picture is distorted.	<ol style="list-style-type: none"><li data-bbox="795 426 1234 453">1. The disc might be damaged, try another disc.<li data-bbox="795 456 1480 483">2. It is normal for some distortion to appear during forward or reverse scan.

SPECIFICATIONS

Type:	TFT Active Matrix LCD
Screen Resolution:	1024 x 600 pixels (RGB)
Operation Temperature:	32 to 140 °F (0 to 60 °C)
Storage Temperature:	-4 to 158 °F(-20 to 70 °C)
Backlight:	LED
Power Source:	12 VDC
Video Display System:	NTSC/PAL
Headphone Audio Output:	5mw @ 32 ohms
Video Output:	1.0Vpp @ 75 ohms



12 MONTH LIMITED WARRANTY

Applies to Movies To Go Mobile Video Products

AUDIOVOX ELECTRONICS CORP. (the Company) warrants to the original retail purchaser of this product that should this product or any part thereof, under normal use and conditions, be proven defective in material or workmanship within 12 months from the date of original purchase, such defect(s) will be repaired or replaced with reconditioned product (at the Company's option) without charge for parts and repair labor. A game controller, if supplied, is similarly warranted for ninety (90) days.

To obtain repair or replacement within the terms of this Warranty, the product is to be delivered with proof of warranty coverage (e.g. dated bill of sale), specification of defect(s), transportation prepaid, to the Company at the address shown below.

This Warranty does not extend to the elimination of externally generated static or noise, to correction of antenna problems, to costs incurred for installation, removal or reinstallation of the product, or to damage to digital memory/media devices, gaming devices, discs, speakers, accessories, or vehicle electrical systems.

This Warranty does not apply to any product or part thereof which, in the opinion of the Company, has suffered or been damaged through alteration, improper installation, mishandling, misuse, neglect, accident, or by removal or defacement of the factory serial number/bar code label(s). THE EXTENT OF THE COMPANY'S LIABILITY UNDER THIS WARRANTY IS LIMITED TO THE REPAIR OR REPLACEMENT PROVIDED ABOVE AND, IN NO EVENT, SHALL THE COMPANY'S LIABILITY EXCEED THE PURCHASE PRICE PAID BY PURCHASER FOR THE PRODUCT.

This Warranty is in lieu of all other express warranties or liabilities. ANY IMPLIED WARRANTIES, INCLUDING ANY IMPLIED WARRANTY OF MERCHANTABILITY, SHALL BE LIMITED TO THE DURATION OF THIS WRITTEN WARRANTY. ANY ACTION FOR BREACH OF ANY WARRANTY HEREUNDER INCLUDING ANY IMPLIED WARRANTY OF MERCHANTABILITY MUST BE BROUGHT WITHIN A PERIOD OF 24 MONTHS FROM DATE OF ORIGINAL PURCHASE. IN NO CASE SHALL THE COMPANY BE LIABLE FOR ANY CONSEQUENTIAL OR INCIDENTAL DAMAGES FOR BREACH OF THIS OR ANY OTHER WARRANTY. No person or representative is authorized to assume for the Company any liability other than expressed herein in connection with the sale of this product.

Some states do not allow limitations on how long an implied warranty lasts or the exclusion or limitation of incidental or consequential damage so the above limitations or exclusions may not apply to you. This Warranty gives you specific legal rights and you may also have other rights which vary from state to state.

Audiovox Electronics Corporation, 150 Marcus Blvd., Hauppauge, New York 11788 | 1-800-645-4994

128-8895

FCC NOTE: U.S. ONLY

This device complies with Part 15 of the FCC Rules. Operation is subject to the following two conditions:

- 1) This device may not cause harmful interference.*
- 2) This device must accept any interference received including interference that may cause undesired operation.*

Warning: Changes or modifications to this unit not expressly approved by the party responsible for compliance could void the user's authority to operate the equipment. The manufacturer is not responsible for any radio or TV interference caused by unauthorized modifications to this equipment. Such modifications could void the user's authority to operate the equipment. Note: This equipment has been tested and found to comply with the limits for a class B digital device, pursuant to Part 15 of the FCC Rules. These Limits are designed to provide reasonable protection against harmful interference in a residential installation. This generates, uses and can radiate radio frequency energy and if not installed and used in accordance with the instructions, may cause harmful interference to radio communications. However, there is no guarantee that interference will not occur in a particular installation. If this equipment does cause harmful interference to radio or television reception, which can be determined by turn the equipment off and on, the user is encouraged to try and correct the interference by one or more of the following measures: •Reorient or relocate the receiving antenna • Increase the separation between the equipment and receiver • Connect the equipment to an outlet on a circuit different from that to which the receiver is connected • Consult the dealer or an experienced radio/TV technician for help.



For Customer Service
Visit Our Website At
www.audiovoxproducts.com
Product Information, Photos,
FAQ's Owner's Manuals