

DIGILAND

7 Inch Quad Core Tablet



USER'S MANUAL

Cautions

This user manual has been specially designed to guide you through the functions and features of your device.

- 1) Please read this manual carefully before using your device to ensure safe and correct use.
- 2) The descriptions in this manual are based on the default settings of your device.
- 3) Do not use this unit near water. Do not place over the unit any container with liquid inside.
- 4) Please do not put your device in high temperature, moisture or dust place. The tablet is not waterproof.
- 5) Avoid falling or violent collision. Do not violently shake the touch screen, otherwise, it could lead to damage or display abnormal.
- 6) If system shutdown automatically, it means the battery may used up, battery charging is required.
- 7) Please charge the tablet regularly if not in use for a long time to avoid the damage caused by the excessive consumption of battery.
- 8) Do not disassemble or use alcohol, thinner or benzene class to swab product surface.
- 9) Please do not use the tablet when driving or walking in the street, otherwise it may lead an accident.
- 10) Please choose the appropriate volume, if had tinnitus, please lower the volume or stop using.
- 11) Memory space available is nominal, as the android system itself takes up part of the memory space and the operation of the program will also take up space.
- 12) Storage capacity available is nominal, as the android system occupies about hundreds of MB storage capacity. And in order to install the software needs, the system must reserve certain storage capacity, so the actual usable space is less than nominal space.
- 13) When CPU operates in high speed, especially playing 3D games or High-definition video for a long time, the fuselage will have fever.
- 14) Please keep this manual for future reference.

Catalog

	Chapter One(overview)	
1.1	Appearance	1
1.2	Buttons	2
1.3	Power on and off	2
1.4	Open and close standby mode	2
1.5	Lock and unlock the screen	2
1.6	Homepage information bar	3
1.7	Text input	3
1.8	Reset	4
1.9	USB connection	4
1.10	Accessories	4
	Chapter Two (Internet)	4
2.1	Browser	4
	Chapter Three (Application)	5
3.1	File manager	5
3.2	Downloads	5
	Chapter Four (System setting)	6
4.1	Wireless networks setting	6
4.2	Sound setting	6
4.3	Display setting	6
4.4	Apps setting	6
4.5	Security setting	6
4.6	Language and input setting	6
4.7	Date & time setting	6
	Chapter Five (Specification)	7

Chapter One: Overview

1.1 Appearance

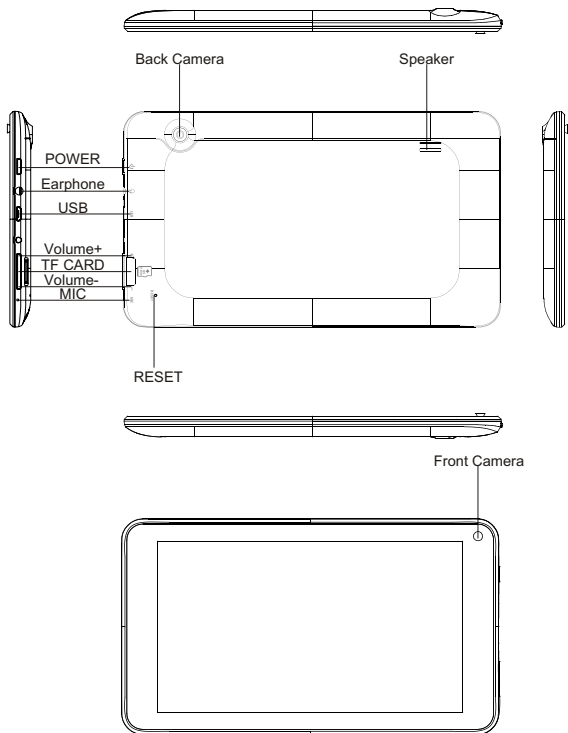

1.2 Buttons

Power button

Long press the power button 2-3 seconds to turn the unit on. When the tablet is in operation, short press power button to enter the off-screen state and short press it again to light up the screen.

Volume

Press Volume +/- to adjust the volume.

1.3 Power on and off

Power on

Long press the power button 2-3 seconds, pictures will show up until to the interface.

Power off

Long press the power button, choose "Power off" and press OK to shut down.

1.4 Open and close standby mode

Open the standby mode

When the tablet is in operation, you can press the power button to go to the standby mode which can save power.

Close the standby mode

When the tablet is in standby mode, you can press the power button to light up the screen and the unit will back to normal state.

1.5 Lock and unlock the screen

Lock

You can set the sleep time in the system of display.

The system will sleep automatically and lock the screen to the standby mode if without any activity when reaches the preset standby time.

Unlock

Drag  to unlock the screen and enter the application interface.

1.6 Homepage Information Bar

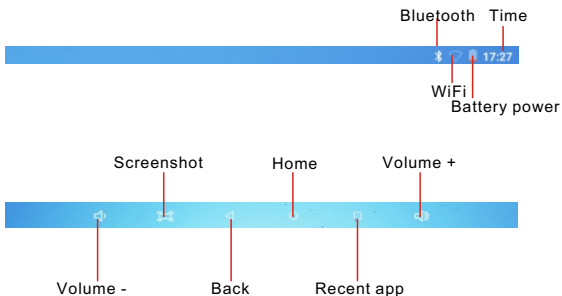

1.7 Text Input

When use the tablet, you can use the virtual keyboard to input text, number, symbols directly by touching screen. After selecting the Android input method, the default keyboard show as below:



To switch the numbers and letters, press 

To switch the capital and lowercase letter, press 

1.8 Reset

Use a thin object(like the end of a paper clip) to press the reset button in the hole , then your device will shut down ,you need to press the power button to turn on the unit.

1.9 USB connection

Use the USB cable to connect the tablet with PC, you will see  on your tablet, click this sign and **turn on USB storage** to connect your device. **Turn off USB storage** to disconnect your device with PC.

1.10 Accessories

Power Adapter	1
USB Cable	1
Warranty card	1
Quick Start Guide	1

Chapter two: Internet

2.1 Browser

Require network support before using a web browser, if there are network supporting problems, please contact your network operator or the service provider.

Tablet's web browser can connect to the Internet via WiFi to satisfy your business and individual network needs .

Please touch  (Settings) to set up the WiFi so that you can use the browser normally.

Touch  (Browser) in the application list to enter the browser pages.

Browser supports the following features.



Input URL: Touch the input area to get the soft keyboard, then input the URL.

Touch  to add a bookmark.

Touch  to read the favorite website that collected

Touch  to search the internet

Touch  to add new browser

Touch  to close the browser

Chapter Three (Application)

3.1 File Manager

Touch  (File manager), you can copy files among SD card, USB and internal memory.



3.2 Downloads

Touch , you can preview the downloading and downloaded documents. You can stop the downloading file or delete the downloaded file.

Chapter Four: System setting

Click  (Settings) to enter the system setting interface.

4.1 Wireless networks setting

Set WiFi ON, the system will scan the available wireless network automatically and display the wireless local area network in the list. If the local area network has the sign , it represents the network has been encrypted, it needs password for connection. While the sign  represents the network is unlocked and can be connected directly.

4.2 Sound setting

Set the system volume, the default notification sound, enable or disable the touch sound and screen lock sound.

4.3 Display setting

Set the brightness, wallpaper, sleep time and font size.

4.4 Apps setting

Display the applications. Choose one application, the relevant information will show up, then you can choose force stop or uninstall. You can also choose to clear the cache, unloaded program and default value.

4.5 Security setting

Set the system securities.

4.6 Language & input setting

Set the default language and input method.

4.7 Date & time setting

Set date and time manually or set automatic date and time by using network-provided time.

Chapter Five (Specification)

Dimension(mm*mm*mm)	191.7*109.7*10.6
Weight	Approx 275g
LCD	7 "1024 × 600, IPS
OS	Android 5.1
Processor	1.3GHz Quad-Core
Memory	1GB RAM, 8GB Storage
WI-FI	802.11a/b/g/n
Connections	Micro-USB, Micro-SD (up to 32GB), Headphone Jack
Battery	3.7V 2100mAh Li-Poly
Operating temperature	Between 0°C et 40°C



If at any time in the future you should need to dispose of this product please note that waste electrical products should not be disposed of with household waste. Please recycle where facilities exist. Check with your Local Authority or retailer for recycling advice. (Waste Electrical and Electronic equipment Directive)

✧ Owing to continuous improvement, no prior notice will be given regarding changes on above feature and spec.

Chapter Six (Attentions)

This device complies with Part 15 of the FCC Rules. Operation is subject to the following two conditions: (1) This device may not cause harmful interference, and (2) This device must accept any interference received, including interference that may cause undesired operation.

Warning: Changes or modifications to this unit not expressly approved by the party responsible for compliance could void the user's authority to operate the equipment.

NOTE: This equipment has been tested and found to comply with the limits for a Class B digital device, pursuant to Part 15 of the FCC Rules. These limits are designed to provide reasonable protection against harmful interference in a residential installation. This equipment generates, uses and can radiate radio frequency energy and, if not installed and used in accordance with the instructions, may cause harmful interference to radio communications.

However, there is no guarantee that interference will not occur in a particular installation. If this equipment does cause harmful interference to radio or television reception, which can be determined by turning the equipment off and on, the user is encouraged to try to correct the interference by one or more of the following measures:

- .. Reorient or relocate the receiving antenna.
- .. Increase the separation between the equipment and receiver.
- .. Connect the equipment into an outlet on a circuit different from that to which the receiver is connected.
- .. Consult the dealer or an experienced radio/TV technician for help.
- .. Android, Google, Google Play, and other marks are trademarks of Google Inc.