

60 GHz

AireLink™

Installation and User Manual

60 SX



60 MX



60 LX



LIGHTPOINTE™

COPYRIGHTS AND DISCLAIMER

© 2015, LightPointe. All Rights Reserved

Information in this document is provided in connection with LightPointe products. These materials are provided by LightPointe as a service to its customers and may be used for information purposes only. LightPointe assumes no responsibility for errors or omissions in these materials. LightPointe may make changes to specifications and product descriptions at any time, without notice. LightPointe makes no commitment to update the information and shall have no responsibility whatsoever for conflicts or incompatibilities arising from future changes to its specifications and product descriptions.

No license, express or implied, by estoppel or otherwise, to any intellectual property rights is granted by this document. Except as provided in LightPointe Terms and Conditions of Sale for such products, LightPointe assumes no liability whatsoever.

These materials are provided "as is" without warranty of any kind, either expressed or implied, relating to sale and/or use of LightPointe products including liability or warranties relating to fitness for a particular purpose, consequential or incidental damages, merchantability, or infringement of any patent copyright or other intellectual property right. LightPointe further does not warrant the accuracy or completeness of the information, text, graphics or other items contained within these materials. LightPointe shall not be liable for any special, indirect, incidental, or consequential damages, including without limitation, lost revenues or lost profits, which may result from the use of these materials.

The Bluetooth™ application provided with the system includes software code developed partially under an MIT open software license agreement.

LightPointe products are not intended for use in medical, lifesaving or life sustaining applications. LightPointe customers using or selling LightPointe products for use in such applications do so at their own risk and agree to fully indemnify LightPointe for any damages resulting from such improper use or sale.

The following are trademarks of LightPointe Product names or services listed in this publication are for identification purposes only, and may be trademarks of third parties. Third-party brands and names are the property of their respective owners.

FlightLite™, FlightStrata™, FlightManager™, AireLite™, AireLink™, AireStrata™, AireForce™, DualPath™, AireManager™ and Airelink™ are trademarks of LightPointe.

LightPointe believes the printed matter contained herein to be accurate from date of publication and reserves the right to make changes as necessary without notice.

Reader Response: LightPointe strives to produce quality documentation and welcomes your feedback. Please send comments and suggestions to LightPointe. For technical questions, contact your local LightPointe sales office or field applications engineer.

TABLE OF CONTENTS

| | | |
|----------|---|-----------|
| 1 | Introduction | 18 |
| 1.1 | Shipping Content | 18 |
| 1.1.1 | AireLink™ 60 with integrated antenna | 18 |
| 1.1.2 | AireLink™ 60 with external antenna: | 20 |
| 1.2 | Main Radio Components | 21 |
| 1.2.1 | AireLink™ 60 ODU with integrated antennas | 21 |
| 1.2.2 | AireLink™ 60 ODU with external antennas | 22 |
| 1.2.3 | External Antennas and Mounting Brackets | 23 |
| 1.2.4 | Power over Ethernet (PoE) Modules | 24 |
| 1.2.5 | Miscellaneous | 25 |
| 1.2.5.1 | RSSI Alignment Cables | 25 |
| 1.2.5.2 | Lightning/ Surge Protection | 25 |
| 1.2.5.3 | Optional: Ethernet Cable Extender | 26 |
| 1.2.5.4 | Optional: Antenna Alignment Tool | 26 |
| 1.2.5.5 | Optional: Weather shield for SX model | 27 |
| 2 | Surveying the Installation Site | 29 |
| 2.1 | Tools | 29 |
| 2.2 | Installation Site Review | 29 |
| 2.3 | Link Distance | 31 |
| 2.4 | Antenna Location | 32 |
| 2.5 | Atmospheric and Rain Attenuation of Millimeter Wave Beams | 32 |
| 3 | Networking, Power and Service Connections | 41 |
| 3.1 | AireLink™ 60 User Panel | 41 |
| 3.2 | Power Connection | 44 |
| 3.2.1 | Powering via PoE | 44 |
| 3.2.2 | Powering via Direct 48 Vdc | 45 |
| 3.3 | Grounding/ Lightning protection | 46 |
| 3.4 | Network Data Connection | 48 |
| 3.5 | Out-Of-Band Management Connection | 49 |
| 3.6 | Console Port | 49 |
| 3.7 | RSSI Voltage Connector | 49 |
| 3.8 | Bluetooth Antenna Connector | 50 |
| 4 | Recommended Software Pre-Configurations | 52 |
| 4.1 | Required Network Settings Info | 52 |
| 4.2 | Airelink Configuration via TELNET CLI INTERFACE | 52 |

| | | |
|----------|--|-----------|
| 5 | System Installation | 57 |
| 5.1 | Tools | 57 |
| 5.2 | Universal Mount Assembly | 58 |
| 5.3 | Pole Mount Installation of Airelink 60 with Integrated Antenna | 59 |
| 5.4 | Pole Mount Installation of Airelink 60 with External Antenna | 60 |
| 5.5 | ODU Installation (External Antenna System only) | 61 |
| 5.6 | System Alignment Basics | 62 |
| 5.7 | Antenna Radiation Pattern and Side Lobes | 63 |
| 5.8 | Installing Airelink™ 60 with Integrated 12 cm Antenna | 64 |
| 5.9 | Installing Airelink™ 60 with External Antennas | 70 |
| 5.10 | Installing the Optional Alignment Sight Tool for External Antennas | 70 |
| 5.11 | Airelink™ 60 with 1 Foot Antenna | 70 |
| 5.12 | Airelink™ 60 with 2 Foot Antenna | 72 |
| 5.13 | Configuration of the Alignment Sight Tool | 72 |
| 5.14 | Mounting Bracket Adjustment | 73 |
| 5.15 | Aligning the 60 Ghz Antennas | 75 |
| 6 | LinkManager™ – Network Management Platform | 82 |
| 6.1 | Management Application Views | 82 |
| 6.2 | System View | 84 |
| 6.3 | RF LINK VIEW | 85 |
| 6.4 | PORT STATUS View | 86 |
| 6.5 | Management View | 89 |
| 6.6 | PERFORMANCE View | 90 |
| 6.7 | STATISTICS View | 91 |
| 6.8 | SNMP View | 92 |
| 6.9 | SOFTWARE View | 93 |
| 6.10 | ADMINISTRATION | 94 |
| 7 | CLI -- Command Line Interface | 95 |
| 7.1 | User Mode Commands | 96 |
| 7.2 | CLI – SHOW Command | 96 |
| 7.2.1 | Command Show Flash | 97 |
| 7.2.2 | Command Show Interface | 97 |
| 7.2.3 | Command Show Performance | 98 |
| 7.2.4 | Command Show Radio | 98 |
| 7.2.5 | Command Show SNMP | 99 |
| 7.2.6 | Command Show System | 99 |

| | | |
|-----------|---|------------|
| 7.2.7 | Command Show Versions | 100 |
| 7.2.8 | Command Show VLAN | 100 |
| 7.3 | CLI --Configuration Commands | 100 |
| 7.3.1 | Interface Commands | 101 |
| 7.3.1.1 | Interface data commands | 101 |
| 7.3.1.2 | Interface management commands | 102 |
| 7.3.2 | Password Command | 104 |
| 7.3.3 | Performance Commands | 104 |
| 7.3.4 | Radio Commands | 105 |
| 7.3.5 | SNMP Commands | 107 |
| 7.3.6 | System Commands | 108 |
| 7.3.7 | Reboot Command | 109 |
| 7.3.8 | Exit Command | 109 |
| 7.4 | CLI -- Save Session Settings on Flash and sSOFTWARE Upgrade | 109 |
| 7.5 | CLI -- PING Command | 110 |
| 7.6 | CLI – Upgrade TFTP Command | 110 |
| 7.7 | CLI – LOG Command | 110 |
| 8 | Bluetooth AireLink Viewer | 113 |
| 9 | SNMP | 117 |
| 9.1 | Basics | 117 |
| 9.2 | LightPointe MIB Files | 117 |
| 9.3 | LightPointe MIB Tree | 118 |
| 9.4 | SNMP Trap Monitoring | 120 |
| 10 | Troubleshooting and Diagnostics | 122 |
| 10.1 | Failure Types | 122 |
| 11 | Advanced Troubleshooting Methods | 126 |
| 11.1 | Performing a PING Test | 126 |
| 11.2 | Equipment Connection and Network Settings | 126 |
| 11.3 | Step-by-Step Instructions to Perform a PING Test | 127 |
| 11.4 | BER Testing | 128 |
| 12 | Specifications | 130 |
| 13 | Technical Support | 131 |
| 13.1 | Return Material Authorization (RMA) Procedure | 132 |
| 13.2 | Contacting LightPointe | 132 |

LIST OF FIGURES

| | |
|--|----|
| Figure 1-1: AireLink™ 60 with integrated antenna (left) and accessories (next page) | 19 |
| Figure 1-2: Shipping Box 1 (AireLink™ 60 detachable ODU and accessories) | 20 |
| Figure 1-3: Shipping Boxes 2 and 3 (1 foot antennas) | 20 |
| Figure 1-4: Shipping Boxes 2 and 3 (2 foot antennas) | 21 |
| Figure 1-5: AireLink™ 60 with integrated antenna and view of access panel cover..... | 22 |
| Figure 1-6: AireLink™ 60 ODU | 22 |
| Figure 1-7: AireLink™60 with one foot (top) and two foot (bottom) antennas attached. | 23 |
| Figure 1-8: Alignment bracket and locations of alignment screws | 23 |
| Figure 1-9: Power over Ethernet modules..... | 24 |
| Figure 1-10: Optional dc power supply | 24 |
| Figure 1-11: RSSI alignment cables..... | 25 |
| Figure 1-12: Surge Protectors..... | 26 |
| Figure 1-13: Ethernet Cable Length Extender | 26 |
| Figure 1-14: Alignment Tool for integrated (left) and external Antenna (right) | 27 |
| Figure 1-15: Side and front view of AireLink 60-SX with optional weather shield installed..... | 27 |
| Figure 2-1: Fresnel Zone illustration. | 30 |
| Figure 2-2: Atmospheric attenuation of signals at different frequencies. | 32 |
| Figure 2-3: ITU rain zone chart of the earth | 33 |
| Figure 2-4: AireLink™ 60 Distance vs. Availability North America | 35 |
| Figure 2-5: AireLink™ 60 Distance vs. Availability Europe..... | 37 |
| Figure 2-6: AireLink™ 60 Distance vs. Availability Australia | 38 |
| Figure 2-4: Typical AireLink™ 60 RSSI vs. Distance chart..... | 39 |
| Figure 3-1: AireLink™ 60 User Panel with plastic cover removed | 42 |
| Figure 3-2: AireLink™ 60 User panel..... | 42 |
| Figure 3-3: Powering via PoE | 44 |
| Figure 3-4: Direct 48 Vdc Power Connection | 46 |
| Figure 3-5: Enclosure Ground Connection..... | 46 |
| Figure 3-7: Lightning Protection Zones | 47 |
| Figure 3-8: Data Network Connection | 48 |
| Figure 3-9: RSSI Voltage Port Connector Location | 49 |
| Figure 3-10: Bluetooth antenna connection | 50 |
| Figure 5-1: Assembled Universal Mount and Base Plate Hole Pattern | 58 |
| Figure 5-2: ODU Polarization Directions | 61 |
| Figure 5-3: AireLink™ 60 installed on LightPointe Universal Mount | 62 |
| Figure 5-4: Typical antenna Radiation Pattern Envelope (RPE) diagram..... | 63 |
| Figure 5-5: Alignment Sight Tool (Integrated Antenna System) | 65 |

| | |
|--|-----|
| Figure 5-6: Antenna alignment scan | 66 |
| Figure 5-7: Simple illustration of the alignment process | 67 |
| Figure 5-8: Typical AireLink 60-SX RSSI vs. Distance Charts for standard distance setting | 68 |
| Figure 5-9: Default User Panel status after successful alignment | 69 |
| Figure 5-10: Alignment Sight Tool (External Antenna System) | 70 |
| Figure 5-11: Attach Alignment Sight Tool to external 1 foot antenna | 71 |
| Figure 5-12: Attach Alignment Sight Tool to external 2 foot antenna | 72 |
| Figure 5-13: Re-configuring Alignment Sight Tool..... | 72 |
| Figure 5-14: Elevation Adjustment | 73 |
| Figure 5-15: Azimuth Adjustment..... | 74 |
| Figure 5-16: Antenna alignment scan | 77 |
| Figure 5-17: Simple illustration of the alignment process | 78 |
| Figure 5-18: Typical AireLink 60 MX/LX RSSI vs. Distance Charts for stand distance settings..... | 79 |
| Figure 5-19: Default User Panel status after successful alignment | 79 |
| Figure 6-1: LinkManager™ Login Window | 82 |
| Figure 6-2: LinkManager Registration Screen | 82 |
| Figure 6-3: LinkManager™ Main Screen | 83 |
| Figure 6-4: System View Screen | 84 |
| Figure 6-5: RF Link View Screen..... | 85 |
| Figure 6-6: Port Status View (RJ45 Data Port) | 86 |
| Figure 6-7: Port Status View (SFP Data Port) | 87 |
| Figure 6-8: Port Status View (RJ45 Management Port) | 88 |
| Figure 6-9: Management View Screen..... | 89 |
| Figure 6-10: Performance View Screen | 90 |
| Figure 6-11: Statistics View Screen | 91 |
| Figure 6-12: SNMP View Screen | 92 |
| Figure 6-13: Software View Screen | 93 |
| Figure 6-14: Administration View Screen..... | 94 |
| Figure 9-1: LightPointe MIB modules | 117 |
| Figure 9-2: MIB tree iso/org/dod/internet/private/enterprises/lpcomm | 118 |
| Figure 9-3: Detailed view of LPCOMM MIB tree | 119 |
| Figure 9-4: Performance Graph..... | 120 |
| Figure 9-5: SNMP Traps | 120 |

LIST OF TABLES

Table 2-1 Fresnel zone path clearan 30
Table 2-2: Rain rates, duration and 60 GHz signal attenuation 34
Table 3-1: User Panel Connections and Status LEDs..... 43
Table 9-1: Troubleshooting Chart I 123
Table 9-2: Troubleshooting Chart II 124

INFORMATION TO USER

NOTE: CHANGES OR MODIFICATIONS OF THE SYSTEM NOT EXPRESSLY APPROVED BY LIGHTPOINTE COULD VOID THE USER'S AUTHORITY TO OPERATE THE EQUIPMENT.

Cautions and Warnings

The following symbols are used in this manual to indicate that the installer should take particular caution to prevent injury or damage to the equipment.



Exercise caution when you see this symbol. It indicates actions that could be harmful to the installer or to the equipment.

Prenez garde lorsque vous voyez ce symbole, il s'agit d'un avertissement indiquant qu'il y a danger pour l'installateur ou l'équipement.



Exercise extreme caution when you see this symbol. It indicates potentially lethal voltages!

Soyez extrêmement prudent lorsque vous voyez ce symbole, il s'agit d'un avertissement denotant la presence de haut voltage pouvant causer la mort ou des blessures graves.

Note: There are no serviceable parts within the units and the system should not be opened in the field.

Observe Standard Precautions

All persons having access to this equipment must observe all standard precautions as defined in applicable national statutory health and safety legislation.

The outdoor equipment must be properly protected against voltage surges and prevent the built-up of static electric charges. We recommend following the IEC 61024/ IEC 62305 standards for proper lightning protection.

For installations in the U.S.A., for information with respect to proper grounding and applicable lightning protection for DC cables please refer to Articles 810830 of the National Electrical Code, ANSI/NFPA No. 70.

In case the system is installed in a country outside of the U.S.A., implement protection in accordance with local safety standards and regulatory requirements.

Do not install or operate this equipment in the presence of or close to flammable gases or fumes. Operation of any electrical equipment in such an environment constitutes a potential safety hazard.

Qualified Personnel

Qualified personnel who understand and are trained to work with the equipment must perform all repair, modification, reconfiguration, and upgrading operations.

Note: Always power the system down before moving or removing the system.

Service

There are no serviceable parts within the radio units. Only factory trained personnel can provide service on any internal components of the radio units.

Export Control

All LightPointe AireLink™ radio products are commodities that fall under ECCN 5A002 of the Department of Commerce. These products are "ENC restricted" under section 740.17(b)(1) of the Export Administration Regulations (EAR). This License Exception ENC does not authorize export or re-export to, or provision of any service in any country listed in Country Group E:1 in Supplement No. 1 to part 740 of the EAR. Diversion contrary to U.S. law is expressly prohibited.

Regulatory Information

North America:

These devices have been type approved by FCC in accordance with 47 CFR PART 15.255 of the Federal Communication Commission rules and Industry Canada RSS-210 Issue 8.

No license is required in the U.S. or Canada for millimeter wave radio transmission equipment operating in the 57-64 GHz frequency band. Customers in other countries are responsible for obtaining proper operator licenses in case they are required by law.

47 CFR Part 15.255

This device complies with Part 15.255 of the FCC Rules. Operation is subject to the following conditions:

This device may not cause harmful interference, and

This device must accept any interference received, including interference that may cause undesired operation.

Industry Canada RS210 Issue 8

This Class 1 digital apparatus complies with the Canadian RSS-210 regulation.

Cet appareil de la classe 1 est conforme à la norme RSS-210 du Canada.

European Union:

These devices are in compliance with the European Directive R&TTE 1999/5/EC on Radio Equipment and Telecommunications Terminal Equipment and have been assessed against the following Applicable Standards:

EN 302 217-3 V2.2.1 (2014-04)

R&TTE: EN 302 217-4-2 V1.5.1 (2010-01)

EN 301 489-1 V1.9.2 (2011-09)

EN 301-489-4 V2.2.0 (2015-01)

IEC/EN 60950-1:2005 (2nd Ed.), +A1: 2009, +A11:2009, +A12:2011



Environmental: This product is ROHS compliant

Other Recommendations and Selected National Standards

ECC/CEPT: ECC/REC/(09)01

Germany: SSB FE-OE 034 (Ausgabe 2/2012)
Notification number 2012/0245/D

Austria: FSB-RR072

Switzerland: RIR0302-47

Australia: Radcom LIPD LIC2000 Schedule 1, Item 51

UNDER THE EUROPEAN COMMISSION ONE-STOP-NOTIFICATION (OSN) PROCESS, NOTIFICATION #11474, THE NATIONAL REGULATORY AUTHORITIES OF THE FOLLOWING EUROPEAN MEMBER COUNTRIES HAVE BEEN NOTIFIED AND THE EQUIPMENT MAY BE OPERATED IN THE FOLLOWING COUNTRIES:

| | | | | | |
|--|-----------|-----------|-----------|-----------|-----------|
| | AT | BE | BG | CZ | DK |
| | EE | FI | FR | DE | GR |
| | IS | IE | LV | LT | LU |
| | MT | NL | NO | PT | RO |
| | SK | SI | SE | CH | UK |

RF Exposure evaluation

To ensure public safety requirements for installation of an RF system in an uncontrolled location, an RF exposure calculation was performed by an independent and accredited test lab (NEMKO USA). The results are presented below.

Safe distance according to FCC CFR 47 § 1.1307, §1.1310; and Industry Canada's (IC) RSS-102, Issue 5, Safety Code 6

For the safety distance calculation the power density limits and average exposure time according to the US FCC and Industry Canada IC regulation was taken into consideration. According to FCC § 1.1310 the limits for general population and uncontrolled exposure are as follows:

Limits for General Population/Uncontrolled Exposure

| Frequency Range (MHz) | Electric Field Strength (V/m) | Magnetic Field Strength (A/m) | Power Density (mW/cm ²) | Averaging Time (minutes) |
|-----------------------|-------------------------------|-------------------------------|-------------------------------------|--------------------------|
| 0.3-1.34 | 614 | 1.63 | *(100) | 30 |
| 1.34-30 | 824/f | 2.19/f | *(180/f ²) | 30 |
| 30-300 | 27.5 | 0.073 | 0.2 | 30 |
| 300-1500 | / | / | f/1500 | 30 |
| 1500-100,000 | / | / | 1.0 | 30 |

f = frequency in MHz

* = Plane-wave equivalent power density

Industry Canada's RSS-102 requirements are listed below and are slightly different from the FCC regulation.

| Frequency Range (MHz) | Electric Field (V/m rms) | Magnetic Field (A/m rms) | Power Density (W/m ²) | Time Averaging (min) |
|-----------------------|--------------------------|--|-----------------------------------|---------------------------|
| 0.003 - 1 | 280 | 2.19 | - | 6 |
| 1 - 10 | 280 / f | 2.19 / f | - | 6 |
| 10 - 30 | 28 | 2.19 / f | - | 6 |
| 30 - 300 | 28 | 0.073 | 2* | 6 |
| 300 - 1 500 | 1.585 f ^{0.5} | 0.0042 f ^{0.5} | f / 150 | 6 |
| 1 500 - 15 000 | 61.4 | 0.163 | 10 | 6 |
| 15 000 - 150 000 | 61.4 | 0.163 | 10 | 616000 / f ^{1.2} |
| 150 000 - 300 000 | 0.158 f ^{0.5} | 4.21 x 10 ⁻⁴ f ^{0.5} | 6.67 x 10 ⁻³ f | 616000 / f ^{1.2} |

Note: f is frequency in MHz. * Power density limit is applicable at frequencies greater than 100 MHz.

A calculation was performed to confirm the required safe distance for fixed service devices.

Limit for power density for general population/uncontrolled exposure was calculated for a power density of max. 1 mW/cm² and for the frequency range 1500 -100000 MHz.

The power density P (mW/cm²) = P_T / 4πr², where

P_T = the maximum equivalent isotropically radiated power (EIRP).

The minimum safe distance "r", where RF exposure does not exceed the permissible limit, is:

$$r = \sqrt{\{ P_T / (P \times 4\pi) \}}$$

1. AireLink™ 60 SX system with 12 cm lens antenna

The maximum rms output power is 9.1 dBm and max antenna gain is 36 dBi. This corresponds to the equivalent isotropically radiated power (EIRP) of 9.1 dBm + 36 dBi = 45.1 dBm, which is equal to 32359 mW.

$$r = \sqrt{\{ P_T / (P \times 4\pi) \}} = \sqrt{\{ 32359 / 12.56 \}} = \mathbf{50 \text{ cm or } 1.7 \text{ feet}}$$

2. AireLink™ 60 MX system with 30 cm parabolic antenna

The maximum rms output power is 9.1 dBm and max antenna gain is 42 dBi. This corresponds to the equivalent isotropically radiated power (EIRP) of 9.1 dBm + 42 dBi = 51.1 dBm, which is equal to 128825 mW.

$$r = \sqrt{\{ PT/ (Px4\pi) \}} = \sqrt{\{ 128825 / 12.56 \}} = \mathbf{100 \text{ cm or } 3.3 \text{ feet}}$$

3. AireLink™ 60 LX system with 60 cm parabolic antenna

The maximum rms output power is 9.1 dBm and max antenna gain is 47 dBi. This corresponds to the equivalent isotropically radiated power (EIRP) of 9.1 dBm + 47 dBi = 56.1 dBm, which is equal to 407380 mW.

$$r = \sqrt{\{ PT/ (Px4\pi) \}} = \sqrt{\{ 407380 / 12.56 \}} = \mathbf{180 \text{ cm or } 6.0 \text{ feet}}$$

RF Exposure Summary

To comply with the FCC/IC RF exposure limits the device must be installed so as to maintain the following minimum separation distance between the main lobe of the transmit antenna (front of the antenna) and nearby persons. At these distances the average exposure time should be limited to 30 minutes (FCC) and 10 minutes (IC)

Pour se conformer aux limites d'exposition aux RF de RS-102, Issue 5, la distance minimale de séparation entre la principale source d'émission (avant de l'antenne) et des personnes à proximité doit être limité à :

| Configuration | Antenna size | Antenna gain | Minimum separation |
|-----------------|--------------|--------------|--------------------|
| AireLink™ 60 SX | 12 cm | 36 dBi | 50 cm (1.7 feet)* |
| AireLink™ 60 MX | 30 cm | 42 dBi | 100 cm (3.3 feet)* |
| AireLink™ 60 LX | 60 cm | 47 dBi | 180 cm (6.0 feet)* |

*Average exposure time 30 minutes (FCC) or 10 minutes (IC).

CE Declaration of Conformity

Date of Issue: 2015-04-01

We, LightPointe Communications, Inc., with address 11696 Sorrento Valley Road, Suite 101, San Diego, CA 92121 **declares under our sole responsibility that:**

Product Description: Point-to-Point Millimeter Wave Transmission System

Model Number(s): AireLink™ 60-xx

To which this declaration relates is in conformity with the following standard(s) or other normative document(s) that this product has been assessed against the following Applicable Standards:

EN 302 217-3 v2.2.1 (2014-4)

EN 302 217-4-2 v1.5.1 (2010-01)

R&TTE: EN 301 489-1 V1.9.2 (2011-09)

EN 301 489-04 v2.2.0 (2015-01)

IEC/EN 60950-1:2005 (2nd Ed.), +A1: 2009, +A11:2009, +A12:2011

To which this declaration relates is in conformity with the provisions of the following Directives:

Directive R&TTE 1999/5/EC on Radio Equipment and Telecommunications Terminal Equipment

The CE Mark shall be affixed on the product as evidence of compliance to this declaration.

Declaration by:

Heinz Willebrand

Name

CEO & President

Title



Signature

2015-04-01

Date

Warranty Information

LightPointe warrants this product against faulty materials or workmanship under the terms of a Standard Warranty and Support Agreement provided that the product was purchased directly from LightPointe or from one of our authorized resellers. Please contact LightPointe Customer Service for additional information or to obtain a copy of the Warranty Agreement.

Contacting LightPointe

Corporate Office

11696 Sorrento Valley Road, #101

San Diego, California 92121

P: 858.834.4083

F: 858.430.3458

Website: www.LightPointe.com

Email: techsupport@LightPointe.com

1 INTRODUCTION

Before starting to cover details on how to install the system we will briefly review the system components included with the shipment and explain the basic principle of operation.

1.1 SHIPPING CONTENT

The AireLink™ 60 system is shipped with an integrated or an external antenna. Depending on the system ordered packaging / box contents will be different.

1.1.1 AireLink™ 60 with integrated antenna

The AireLink™ 60 SX ships in a single box. Please verify that the shipment contains the following items:

- Two 60 GHz radios with integrated 120 mm lens antenna
- Two mounting brackets
- Two RSSI Alignment cables for use with voltmeter
- Two ferrite beads
- One Micro USB cable
- Two Power over Ethernet (PoE) injectors (optionally: Two 48 Vdc outdoor rated power supplies)
- Two Bluetooth rubber antennas with SMA connector
- CD with Installation Manual



Figure 1-1: AireLink™ 60 with integrated antenna (top) and accessories (next page)

The AireLink™ 60 SX system ships with either of three alignment bracket options. Depending on which bracket was ordered, the content of the accessories box will slightly vary:

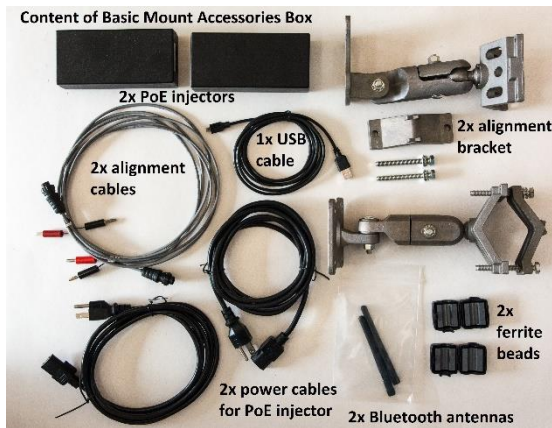

1. Basic alignment bracket accessories box



2. Stainless Steel alignment bracket accessories box



3. Heavy duty alignment bracket accessories box

1.1.2 AireLink™ 60 with external antenna:

The AireLink™ 60 MX/LX with external antenna ships in three separate boxes. Please verify that the shipment contains the following items:

- Two detachable AireLink™ 60 outdoor radio transmission units (ODU)
- Two Power over Ethernet (PoE) injectors (optionally: Two 48 Vdc outdoor rated power supplies)
- Two RSSI Alignment cables for use with voltmeter
- One Micro USB cable
- Two Bluetooth rubber antennas with SMA connector
- Two antennas (either 12" or 24") w/attached side pole mounting bracket
- CD with Installation Manual
- Optional: Site Alignment Tool

The pictures below show the content of each individual shipping box.



Figure 1-2: Shipping Box 1 (AireLink™ 60 detachable ODU and accessories)



Figure 1-3: Shipping Boxes 2 and 3 (1 foot antennas)

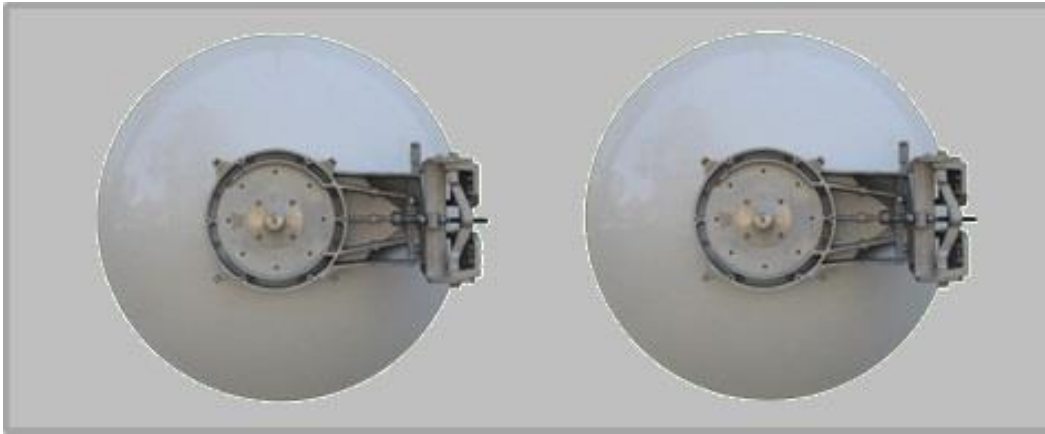

Figure 1-4: Shipping Boxes 2 and 3 (2 foot antennas)

1.2 MAIN RADIO COMPONENTS

The AireLink™ 60 comes either with an integrated 120 mm lens antenna or with external one or foot high gain parabolic Cassegrain antennas.

1.2.1 AireLink™ 60 ODU with integrated antennas

The AireLink™ 60 with integrated lens antenna shown in Fig. 1-5 is designed around an aluminum-based IP 66 rated outdoor housing to protect the electronics from rain, dust and other environmental conditions. The system can be used to easily create a shorter distance point to point wireless Network connection between remote locations. This highly integrated and outdoor rated system can be easily installed at walls, towers or other structure by using the pole mount alignment bracket that comes with the system. The stainless steel mounting bracket is designed to accommodate pole diameters ranging from 2.5...4.5 inches (65...115 mm). All network/management and power connectors located on the system user panel can be easily accessed via a clear and detachable access panel cover. Power and port status LEDs on the back panel are visible from the outside through the transparent cover. IP67 rated cable gland compression fittings for power/networking cables are integrated into the access panel cover.

The transmission equipment operates in full-duplex mode and in slightly different frequency bands. The lower band radio transmits in the 59 GHz frequency band and the upper band radio transmits in the 62 GHz frequency band. On the back panel is a **HIGH BAND** and **LOW BAND** sticker to distinguish between the radios. The AireLink™ 60 radios are equipped with a Bluetooth Low Energy (BLE) transceiver that allows for remotely monitoring the radio via smart phone or tablet via an encrypted

and password protected Bluetooth connection. Figure 1-5 shows the Bluetooth antenna attached to the radio enclosure.



Figure 1-5: AireLink™ 60 with integrated antenna and view of access panel cover

1.2.2 AireLink™ 60 ODU with external antennas

The longer distance version of the AireLink™ 60 comes with separate antennas and a detachable radio outdoor unit (ODU). The ODU is contained within an aluminum-based IP 66 rated outdoor housing to protect the electronics from rain, dust and other environmental conditions. Same as the integrated antenna solution, the radios operates in full-duplex mode. A sticker on the back panel shows the **HIGH BAND** and **LOW BAND** radio unit. The ODU is shown in Fig. 1-6. It can be easily detached from the antenna by releasing the 4 spring loads latches and simply pulling the ODU of the antenna waveguide flange. Same as the AireLink™ 60 radios with integrated antenna, the ODU is equipped with a Bluetooth Low Energy (BLE) transceiver that allows for remotely monitoring the radio via smart phone or tablet via an encrypted and password protected Bluetooth connection. The Bluetooth antenna that ships with the system is attached to a SMA connector located at the side of the enclosure.



Figure 1-6: AireLink™ 60 ODU

The ODU is fully IP 67 outdoor rated and all network/management and power connectors can be easily accessed via a clear and detachable access panel cover. The transparent cover also allows the see all network port status indicators. The ODU can be easily removed from the antenna waveguide by releasing 4 spring loaded latches. The ODU is the same for both, the 1 foot and the 2 foot antenna system. By rotating the ODU 90 degrees the polarization can be changed easily. Chapter 4 describes the ODU Networking, Service and Power Connections in more detail.

1.2.3 External Antennas and Mounting Brackets

Depending on the system ordered, the AireLink™ 60 is shipped either with a high performance high gain 12" or 24" parabolic Cassegrain antenna. The mounting and alignment bracket is the same for both antennas. Fig. 1-7 shows the 12" (top) and 24" (bottom) system. For illustrative purposes the systems are shown with and without the ODU attached.

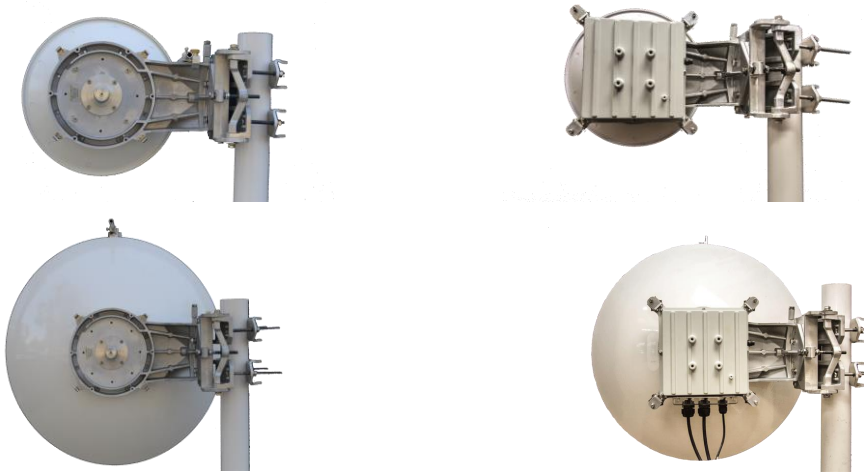

Figure 1-7: AireLink™60 with one foot (top) and two foot (bottom) antennas attached.

The antenna is equipped with a robust side pole mounting and alignment bracket. The bracket easily attaches to a vertical structure with pole diameters from 2.5..4.0 inches (65..110 mm). The pole mounted alignment bracket is shown in Fig. 1-8. Also shown are the locations of the horizontal and vertical alignment screws.

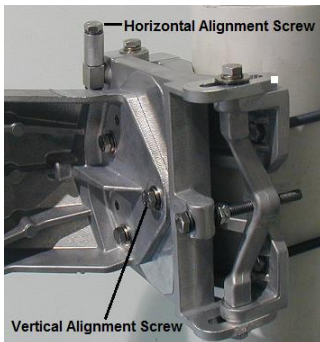

Figure 1-8: Alignment bracket and locations of alignment screws

1.2.4 Power over Ethernet (PoE) Modules

The AireLink™ 60 system ships standard with two Power over Ethernet (PoE) injectors for powering the transmission units. The power provided to the AireLink™ 60 unit travels over a separate CAT5E/CAT6 cable as the network data but shares a cable with the out-of-band management connection. The PoE modules accept universal 90-240 Vac input and provide 48Vdc to the AireLink™ 60 units. The port labeled Output on the PoE should be connected to the RJ-45 port labeled Management/PoE on the AireLink™ 60 unit. The port labeled Input on the PoE injector can be connected to your management network to enable out-of-band system management. The PoE injector is shown in Fig. 1.9 below.



Figure 1-9: Power over Ethernet modules

In case the customer orders the system with the dc power option rather than the standard PoE supplies, the PoE injectors will be replaced with a dc power supply (Figure 1-10 below).



Figure 1-10: Optional dc power supply

1.2.5 Miscellaneous

1.2.5.1 RSSI Alignment Cables

A digital voltmeter is used to measure the RSSI voltage changes of the receive signal level during alignment. Two cables, one for each AireLink™ 60 radio unit, are provided with the shipment. The cables are terminated on one side with a 2-pin female connector for attachment to the AireLink™ 60 waterproofed IP67 RSSI voltage connector located at the side of the radio enclosure. At the opposite side the cable has banana plug connectors for attachment to a digital voltmeter (see Fig. 1-11).



Figure 1-11: RSSI alignment cables

1.2.5.2 Lightning/ Surge Protection

When using the PoE powering/management option and/or the copper data port rather than the fiber data port option, we strongly recommend using a surge protector to protect networking equipment attached to the radio to suffer from potential lightning strikes. In case of the PoE/management port, a 10/100 Mbps solution with built in PoE power protection will be sufficient. To protect the 1000 Mbps copper data port connection, a GbE capable surge protector solution must be used. Figure 1-14 (left) below shows examples of Ethernet surge protector in an outdoor rated and weather resistant enclosure made by Enable-IT <http://www.ethernetextender.com/ethernet-extension-products/lightning-protection/265LP.php>.

The device in the left of Figure 1-12 is an outdoor rated GbE and PoE+ capable Ethernet lightning/surge protector (LightPointe part number LM-SURGE-1). LightPointe recommend to install a lightning/surge protector close to the AireLink radio head to prevent damage to the indoor networking equipment that is connected to the radio head via CAT5/6 copper cable.

In case the direct two wire 48 Vdc powering option is used, we also strongly recommend using a surge protector to prevent potential lightning strike surges to enter the in-building power plant. The device on the right in Figure 1-12 is a 48 Vdc surge protector made by Transtector (Transtector DCOD 48-2.5) <http://www.smithspower.com/brands/transtector/products/dc-surge-protection/1101-1025>



CAT5/6 Ethernet Cable Surge Protectors

48 Vdc Powerline Surge Protector

Figure 1-12: Surge Protectors

1.2.5.3 Optional: Ethernet Cable Extender

When using the PoE powering/management port, the CAT 5/6 Ethernet cable distance between the networking switch/PoE injector and radio link is limited to 300 feet. Although this is plenty for most installations there are cases where it is necessary to extend the cable length. This can be accomplished by using an Ethernet Extender. The device show in Figure 1-13 below can extend the cable run to distances up to 2000 feet. <http://www.ethernetextender.com/ethernet-extension-products/ethernet-extension-kits/828p.php> Please, ask LightPointe customer support for more detailed information.



Figure 1-13: Ethernet Cable Length Extender

1.2.5.4 Optional: Antenna Alignment Tool

To ease the alignment of the narrow beam external antennas, LightPointe can provide a simple alignment tool (see Figure 1-14) to correctly aim the antenna beam towards the remote antenna site. The tool works very similar but it is different for the integrated and the externals antennas. In particular when aligning the longer range 2 foot antenna and or when installing the antennas on a tower, this tool will reduce the time it takes to get the antennas aligned correctly. The alignment tool is attached to the ODU /antenna mount and can be easily removed after the alignment process is completed. It

can therefore be easily re-used when multiple antennas need to be aligned. The function, installation and use of the alignment tool will be explained in detail in Chapter 4.

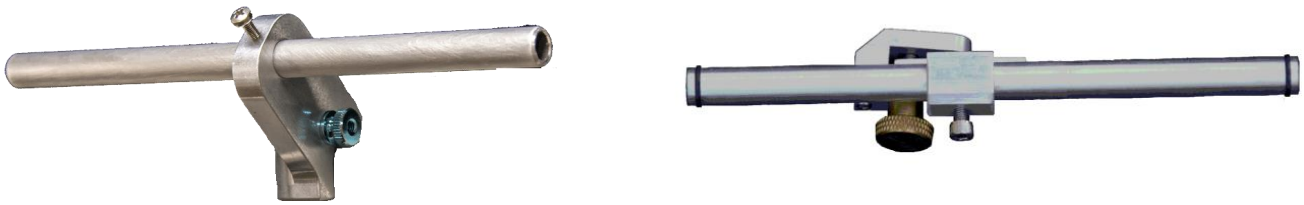

Figure 1-14: Alignment Tool for integrated (left) and external Antenna (right)

1.2.5.5 Optional: Weather shield for SX model

When systems are installed in environments that observe a lot of snowfall or in desert like climates that experience a lot of heat, we recommend installing a weather shield to cover the housing as well as the lens antenna. The kit includes all nuts and bolts to attach the weather shield to the enclosure and it can be reactively installed at a later point in time. The AireLink 60 SX with weather shield installed is shown in Figure 1-15.



Figure 1-15: Side and front view of AireLink 60-SX with optional weather shield installed.



2 SURVEYING THE INSTALLATION SITE

Chapter 2 educates the user on millimeter wave transmission technology and the site survey/review process used in successful deployment of LightPointe AireLink™ 60 systems. Please read this chapter before installing the system.

2.1 TOOLS

Please ensure that the following measures have been taken and that tools are available for surveying the installation site.

- Have permission of building owner to install the system
- Ensure that the installation meets any local requirements
- Use an accurately scaled map for locating sites and doing rough distance calculations
- Laser range finder or GPS for accurate distance measurement (optional)
- Binoculars to assist in locating opposite-end installation site
- Sketch or notepad to make rough drawings and notes
- Tape measure to determine approximate distance of fiber, power runs, etc.
- Camera to take pictures of the installation sites (optional)

2.2 INSTALLATION SITE REVIEW

When performing a site review certain measures must be taken to ensure the successful deployment of a millimeter wave transmission system.

Determine the appropriate system to meet the needs of each specific location:

- Measure point-to-point distance using a map, a laser range finder or GPS coordinates
- Refer to the ITU rain zone chart and locate the ITU rain zone where the system will be installed
- Determine what physical connections will be required (e.g. SM/MM fiber or CAT5E/6 copper cable, PoE or direct 48 Vdc)

Determine line-of-sight

Ensure that the antenna has sufficient path clearance. The **Fresnel Zone** is the area around the visual line-of-sight that radio waves spread out into after they leave the antenna (see Figure 2-1). To maintain good signal strength is important to maintain sufficient path clearance. Typically, a 20% **Fresnel Zone** blockage introduces little signal. However, nearing 40% blockage the signal loss will become significant.

- The Fresnel Zone formula shown below is based on a flat earth. In other words, it does not take the curvature of the earth into consideration. The effect of this is to budge the earth in the middle of the link. However, for relatively short distances, the effect of the earth’s curvature and the specific topography of the terrain are negligible.
- Table 2-1 shows the calculated minimum path clearance required for operation of a pt-to-pt millimeter wave operating in the 60 GHz band based on the Fresnel Zone formula shown below.

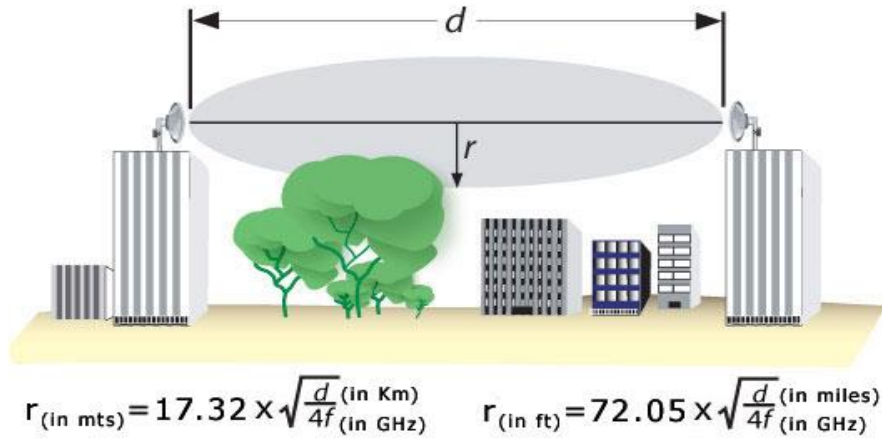

Figure 2-1: Fresnel Zone illustration.

| Path length in meters | Path clearance radius r in meters |
|-----------------------|-----------------------------------|
| 100 | 0.35 |
| 200 | 0.50 |
| 500 | 0.79 |
| 1000 | 1.12 |
| 1500 | 1.37 |
| 2000 | 1.58 |

Table 2-1 Fresnel zone path clearance

- Can emissions, blowing or swaying trees, or other obstacles in the line of sight interrupt the connection?
- Is there a possibility of work activity or people passing in front of the transmission that could interfere with the clear line of sight

Evaluate environmental mounting conditions

- Only mount the radio transmission equipment to a stable and vibration-free mounting platform – this is a critical factor to successful performance.

- Evaluate that the foundation at the mounting location is not susceptible to change due to humidity or temperature (avoid wooden mounting platforms)

Evaluate mounting locations for human access

- Safe access to the radio transmission unit
- Stable location/platform to stand upon
- Safety considerations for installers and maintainers of the system in all weather conditions

Evaluate mounting locations to avoid interruptions of transmission

- Near roof edge to avoid people walking in front of the transmission unit
- Non-penetrating roof mount and at least 7 foot high to avoid people walking in front of the transmission unit
- Mounting the antenna in the middle of the roof and close to the roof surface can cause the antenna to experience undesirable multi-path reflections
- At the side or corner of a building wall without people being able to walk in front of the transmission unit
- Weather-protected location if possible
- Safe location that will not be subject to damage from vandals

Evaluate mount stability

- Solid concrete or steel structural building member
- Directly on a flat roof surface if using a non-penetrating mount
- Securely fastened to the side or top of parapet wall

2.3 LINK DISTANCE

Measurement of the link distance is important in estimating the link availability and calculating the expected Receive Signal Level (RSL). When using a Global Positioning System (GPS) device this measurement can be performed using the Latitude and Longitude coordinate readings from the proposed locations of the antennas. When a GPS device is not available, online tools like Google Earth are also very helpful to determine the link distance. However, GPS reading will be required in order to comply with any required regulatory registration process.

To estimate maximum distances and availabilities for a given product and region please refer to the AireLink™ Fade Margin/Availability charts shown in Chapter 2.5.

2.4 ANTENNA LOCATION

For proper operation and easy maintenance the optimum location for the antennas must be determined. The ideal location should provide for ease of erecting and mounting the antenna, as well as providing unimpeded LOS to the remote location. The following factors should be taken into account:

- Type of mounting—fixed installation or non-penetrating roof pole mounting
- Access location of fiber/RJ-45 cables and power wiring of the building
- Length of cable runs
- Earth Grounding connection points
- Potential obstructions (also temporary), including allowances for tree growth
- Accessibility of the radio mounting location
- Accessibility of the site during and after working hours

2.5 ATMOSPHERIC AND RAIN ATTENUATION OF MILLIMETER WAVE BEAMS

Millimeter wave systems operating in the 60 GHz frequency ranges are able to transmit and receive high data rates such as 1250 Mbps (Gigabit Ethernet) over short to medium distances. The actual distance/availability performance of a specific system depends on parameters such as transmission power, antenna size, and receiver sensitivity. In general terms millimeter wave frequencies are attenuated by rain and additionally by oxygen absorption in the case of systems operating in the 60 GHz frequency range. Oxygen absorption plays a minor role in the higher 70/80/90 GHz millimeter wave frequency ranges and therefore these systems are typically better suited in establishing a connection over longer distances. Millimeter wave transmission does not suffer from attenuation in fog or during sand storms. Figure 2-2 shows the typical atmospheric attenuation of signals in different frequency bands.

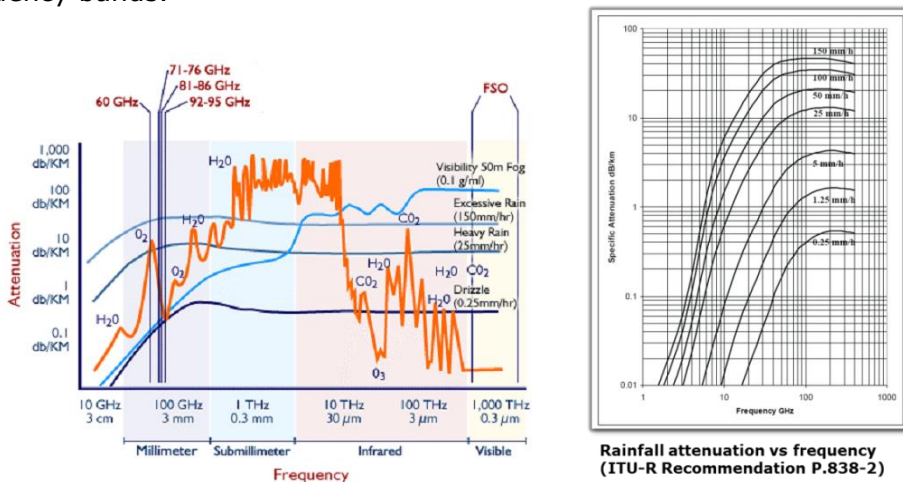

Figure 2-2: Atmospheric attenuation of signals at different frequencies.

Rain attenuation of millimeter wave signals has been studied extensively over several decades and models are available to reliably predict the availability of a millimeter wave transmission system in various rain zones around the world. Based on the actual rain rates collected in specific regions, the International Telecommunications Union (ITU) has published charts dividing the globe into separate rainfall regions. Similar charts with slightly different geographical breakdowns exist, based on the work of the researcher Crane. Both charts can be used to predict availability performance of millimeter wave transmission systems. Figure 2-3 shows the ITU chart of different rain rate regions of the world. The regions are divided by using an alphanumeric notation with region **A** having the least and region **Q** having the highest rain fall rates. Naturally the highest rain rates occur around the equator (rain zones N, P, Q) and in these regions rain rates up to 250 mm/h can be observed for very short periods of time. Very low rain rates (rain zone A) can be observed in the African, Middle Eastern and Asian desert regions as well as in the Northern Polar regions.



Figure 2-3: ITU rain zone chart of the earth

Using the ITU or Crane rain zone charts one can calculate the availability of a millimeter wave transmission system in a specific rain zone. When it comes to rain attenuation it is important to keep in mind that the rain fall rate and not the total amount of yearly rainfall determines the availability of a millimeter wave radio system. For example, it is well known that the number of rainy days in the North Western region of the United States and in cities like Seattle greatly exceeds the number of rainy days in the South Eastern areas like Florida. However, when looking at Table 2-2, representing the actual duration of peak rain fall rates in mm/hour in different rain zones, one finds that the rain fall rate (or rain intensity) in the North Western region of the United States is far less when compared to

the rain fall rate in the south. Consequently, and using the same system availability figure, a millimeter wave system installed in the North West (rain zone D) can operate over a longer distance compared to a system installed in Florida (rain zone N), for example.

| Availability | Downtime/year | A | | B | | C | | D | | E | | F | | G | | H | |
|--------------|---------------|-------|-------|-------|-------|-------|-------|-------|-------|-------|-------|-------|-------|-------|-------|-------|-------|
| | | mm/hr | dB/km | mm/hr | dB/km | mm/hr | dB/km | mm/hr | dB/km | mm/hr | dB/km | mm/hr | dB/km | mm/hr | dB/km | mm/hr | dB/km |
| 99.999% | 5 min | 22 | 9.06 | 32 | 12.35 | 42 | 15.46 | 42 | 15.46 | 70 | 23.59 | 78 | 25.8 | 65 | 22.18 | 83 | 27.15 |
| 99.99% | 1 hr | 8 | 3.93 | 12 | 5.49 | 15 | 6.6 | 19 | 8.03 | 22 | 9.06 | 28 | 11.6 | 30 | 11.7 | 32 | 12.35 |
| 99.9% | 9 hr | 2 | 1.25 | 3 | 1.75 | 5 | 2.66 | 8 | 3.93 | 6 | 3.1 | 8 | 3.93 | 12 | 5.49 | 10 | 4.72 |
| 99% | 88 hr | 0.1 | 0.1 | 0.5 | 0.4 | 0.7 | 0.52 | 2.1 | 1.3 | 0.6 | 0.46 | 1.7 | 1.09 | 3 | 1.75 | 2 | 1.25 |

| Availability | Downtime/year | J | | K | | L | | M | | N | | P | | Q | |
|--------------|---------------|-------|-------|-------|-------|-------|-------|-------|-------|-------|-------|-------|-------|-------|-------|
| | | mm/hr | dB/km | mm/hr | dB/km | mm/hr | dB/km | mm/hr | dB/km | mm/hr | dB/km | mm/hr | dB/km | mm/hr | dB/km |
| 99.999% | 5 min | 55 | 19.32 | 100 | 31.67 | 150 | 44.29 | 120 | 36.82 | 180 | 51.49 | 250 | 67.55 | 170 | 49.11 |
| 99.99% | 1 hr | 35 | 13.3 | 42 | 15.46 | 60 | 20.76 | 63 | 21.62 | 95 | 30.36 | 145 | 43.06 | 115 | 35.55 |
| 99.9% | 9 hr | 20 | 8.37 | 12 | 5.49 | 15 | 6.6 | 22 | 9.06 | 35 | 13.3 | 65 | 22.18 | 75 | 24.97 |
| 99% | 88 hr | 8 | 3.93 | 1.5 | 0.98 | 2 | 1.25 | 4 | 2.21 | 5 | 2.66 | 12 | 5.49 | 24 | 9.73 |

Table 2-2: Rain rates, duration and 60 GHz signal attenuation

LightPointe calculates the AireLink™ 60 availability vs. distance charts based on internal system parameters and ITU-R Recommendation P.838-3. These charts are shown below for North American (Figure 2-4), European (Figure 2-5) and Australian (Figure 2-6) rain zones and for the 12 cm, 30 cm and 60 cm antenna options. Other rain zone charts as well as a system fade margin calculator for the AireLink™ 60 products are available upon request. Please contact LightPointe Customer Support for more information.

GbE Throughput Distance versus Availability (Integrated 120 mm lens antenna)

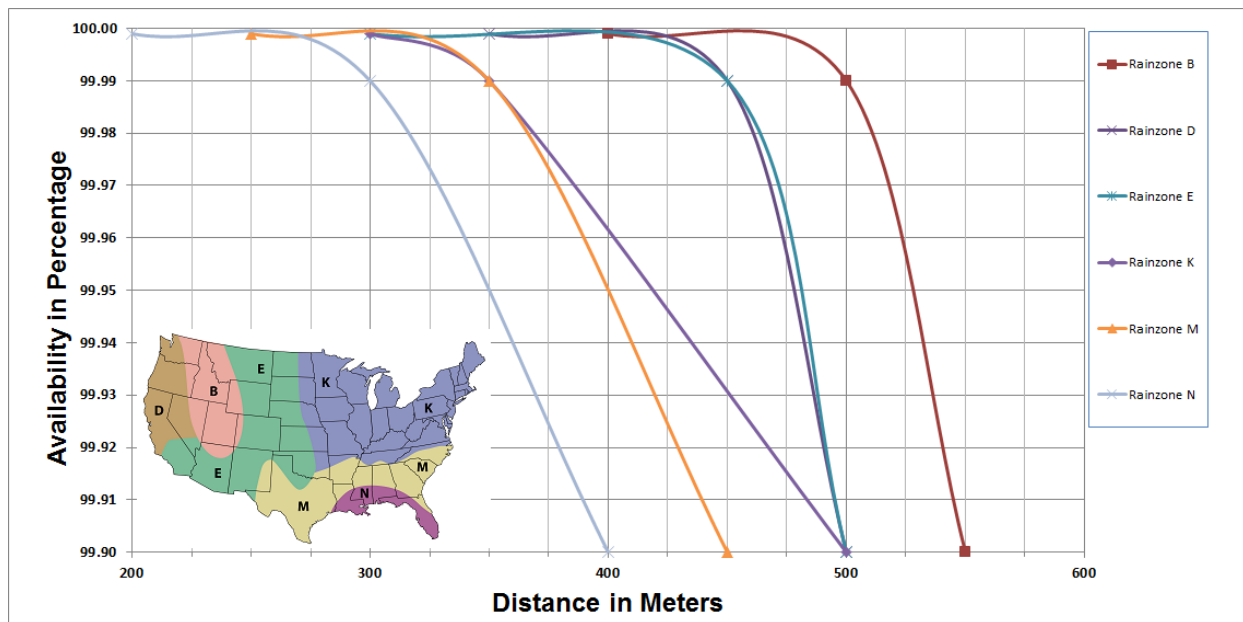

GbE Throughput Distance versus Availability (External 30 cm antenna)

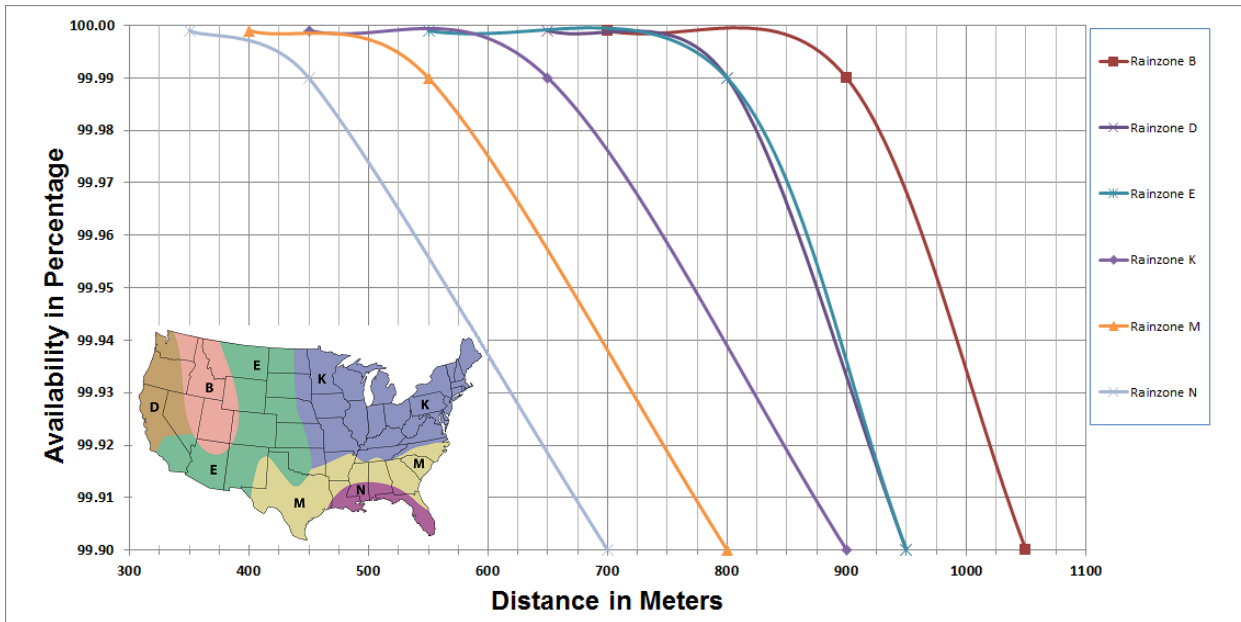

GbE Throughput Distance versus Availability (External 60 cm antenna)

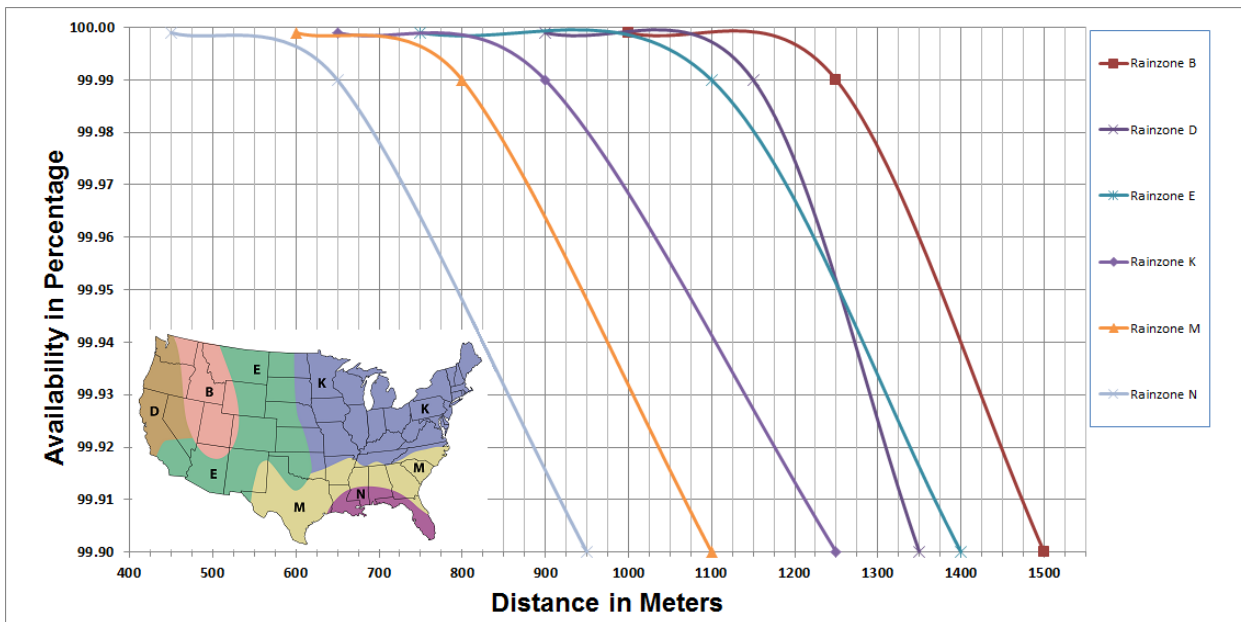
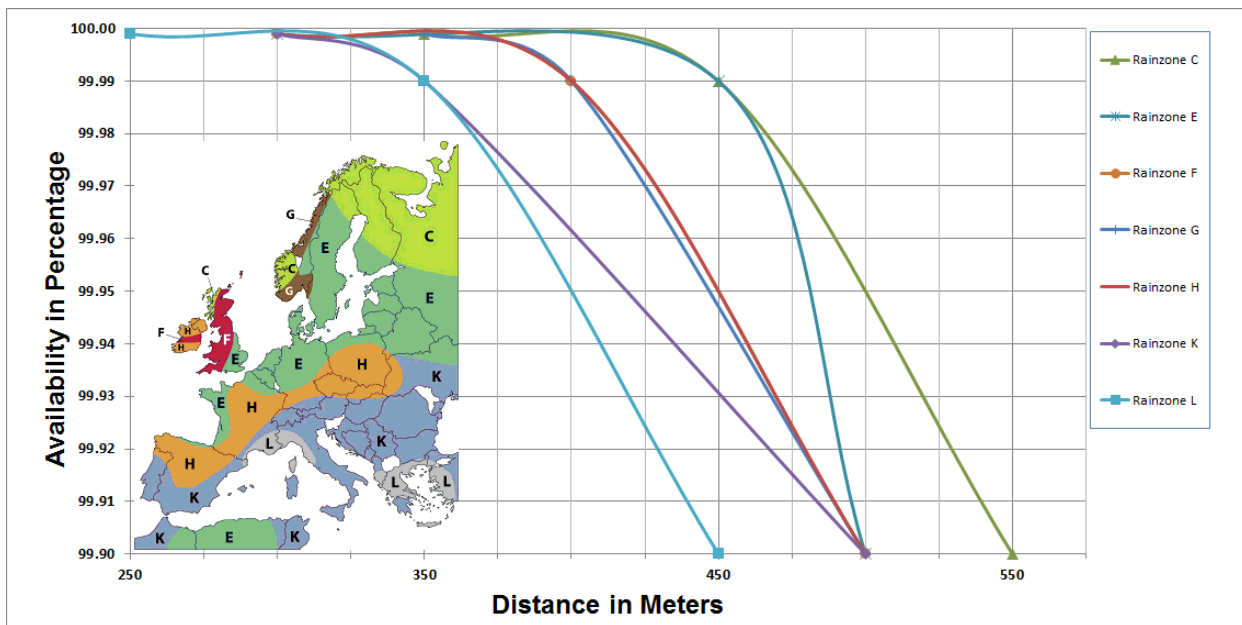
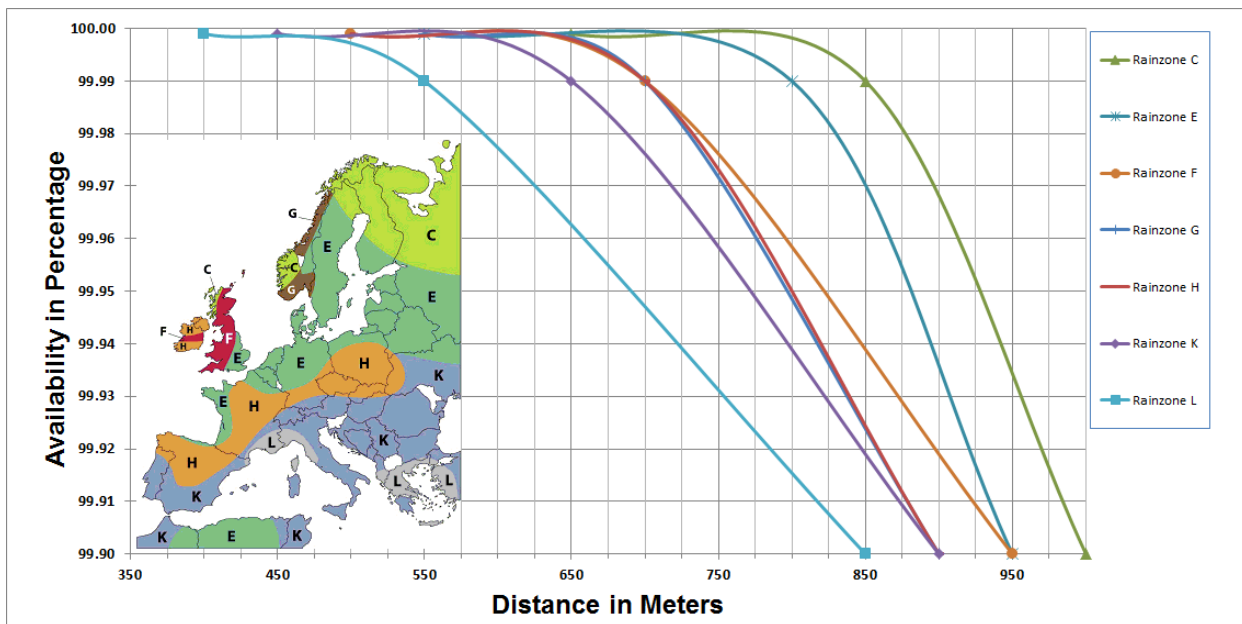

Figure 2-4: AireLink™ 60 Distance vs. Availability North America

GbE Throughput Distance versus Availability (Integrated 120 mm lens antenna)



GbE Throughput Distance versus Availability (External 30 cm antenna)



GbE Throughput Distance versus Availability (External 60 cm antenna)

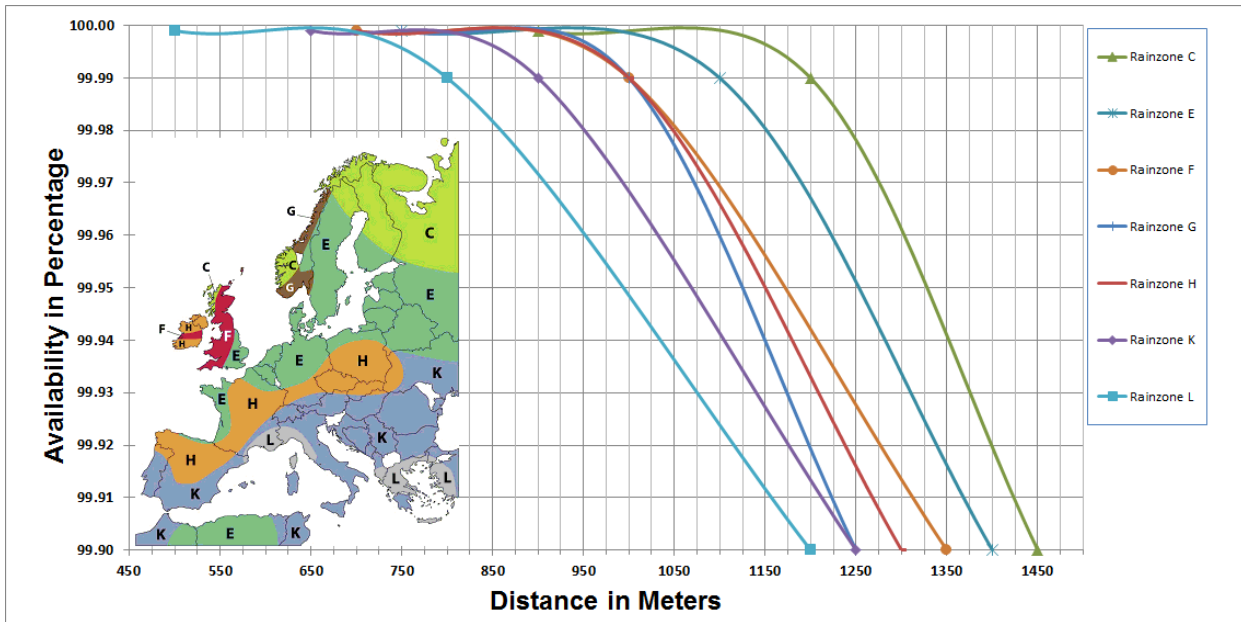
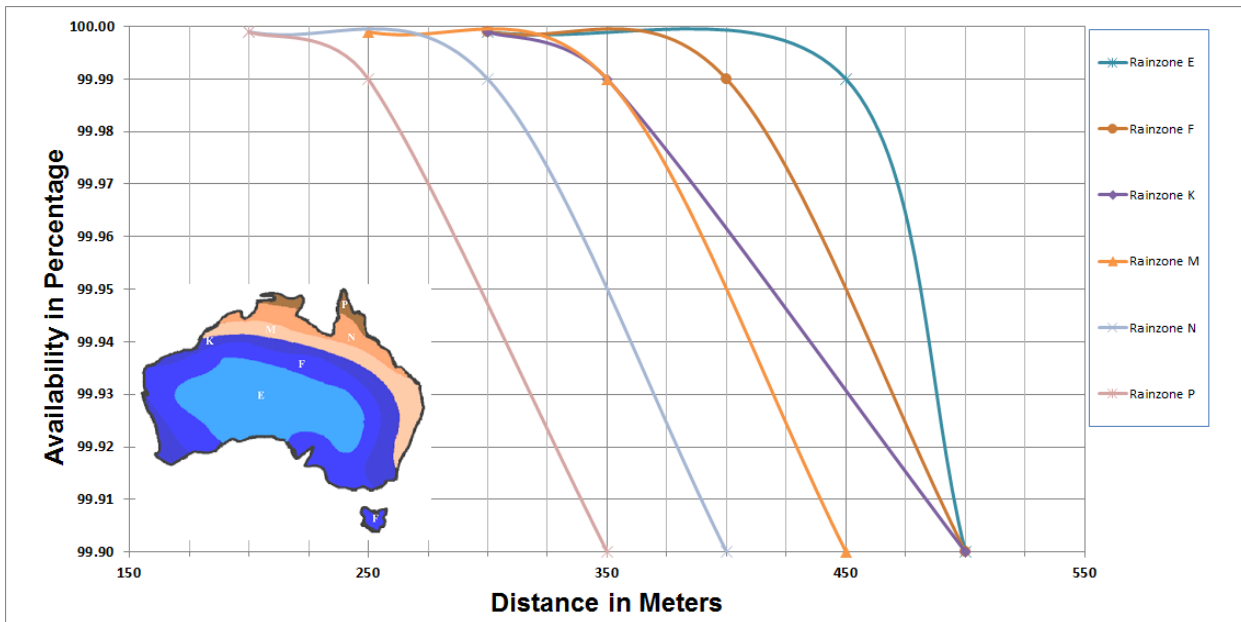
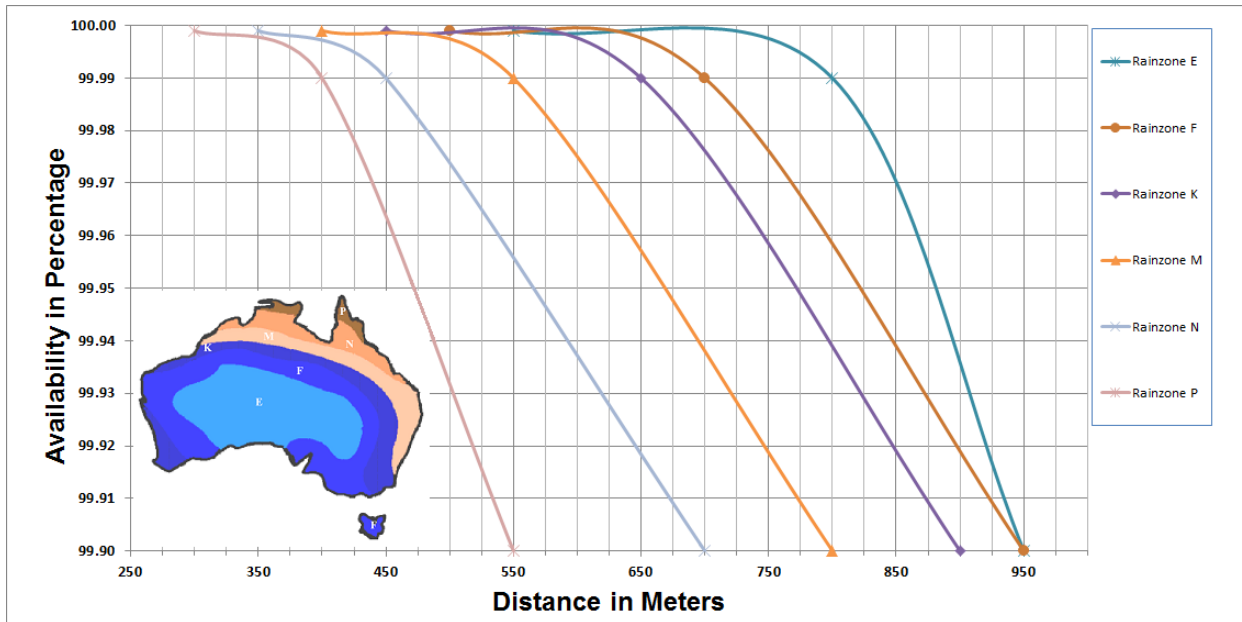

Figure 2-5: AireLink™ 60 Distance vs. Availability Europe

GbE Throughput Distance versus Availability (Integrated 120 mm lens antenna)



GbE Throughput Distance versus Availability (External 30 cm antenna)



GbE Throughput Distance versus Availability (External 60 cm antenna)

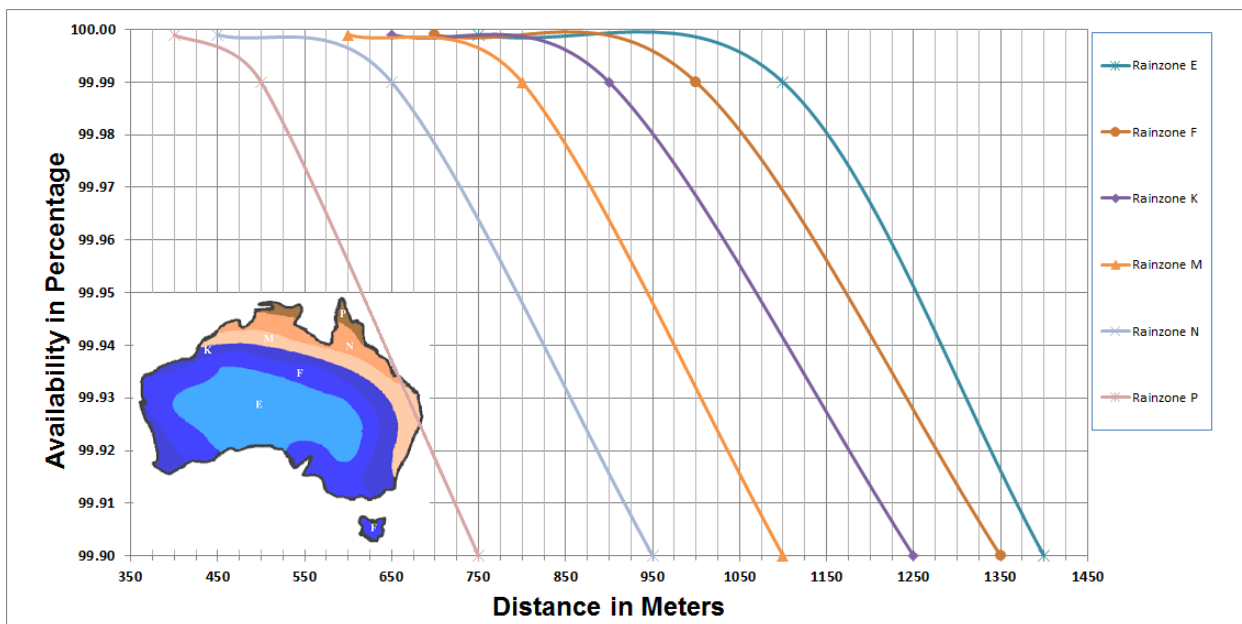

Figure 2-6: AireLink™ 60 Distance vs. Availability Australia

Typical RSSI vs. Distance charts for the AireLink™60 is shown in Figure 2-4 below. These RSSI vs. Distance readings can slightly vary from system to system. The actual values can be slightly different due to the installation locations of the antennas and of course weather conditions at the time of reading. However, the RSSI readings provide a very good guideline of the expected receive signal level for the specific installation distance. Please, contact LightPointe or your Reseller to obtain the chart for your specific system.

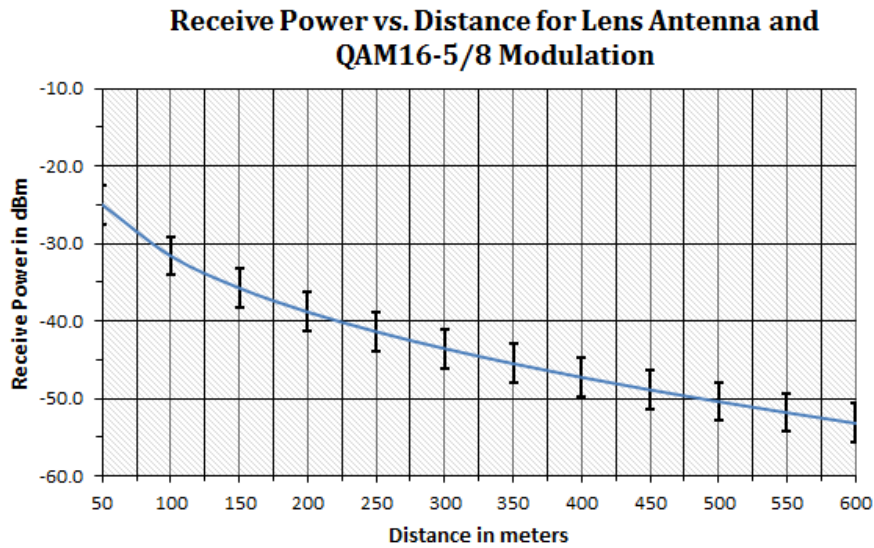

Figure 2-4: Typical AireLink™ 60 RSSI vs. Distance chart



3 NETWORKING, POWER AND SERVICE CONNECTIONS

The AireLink™ 60 with integrated 12 cm antenna and the systems with external 1 or 2 foot antennas have the same networking, power and service connections. In case of the external antenna solution the radio itself comes as a fully outdoor rated ODU that is attached to the antenna base using 4 spring loaded latches (see Figure 1-7). Please, review Chapter 1 in case there are questions regarding the general system/ODU design.

At this point, we recommend that the user/installer gets familiar with the user panel and connectors before installing the system on the roof/tower. The user panel can be easily accessed by using a Philips screwdriver and remove the 4 screws that attach the clear access panel cover the radio housing (see Figure 1-5). In case the system ordered is the external antenna version, we recommend removing the ODU from the antenna Base by releasing the 4 spring loaded ODU latches and pulling the ODU of the antenna waveguide flange. This allows the user taking a closer look at the ODU and start the process of preconfiguring the system before installing on the roof.

| | |
|-------------|--|
| Note | <p>We recommend pre-configuring the system before installing it on the roof. This relatively simple process requires powering up the system and being familiar with the use of a serial interface program such as Windows based HyperTerminal or PuTTY</p> <p>http://www.chiark.greenend.org.uk/~sgtatham/putty/download.html</p> <p>The connection to the serial port is done via the USB port and the customer needs to download and install the appropriate USB to UART Bridge Virtual COM Port (VCP) drivers from Silicon labs.</p> <p>http://wwwqa.silabs.com/products/mcu/Pages/usbtouartbridgevcpcdrivers.aspx</p> |
|-------------|--|

3.1 AIRELINK™ 60 USER PANEL

The AireLink™ 60 user panel is identical for the integrated and external radio solution where it is part of the ODU. The user panel is located at the side of the housing and a transparent hard plastic cover protects the user panel from being exposed to the environment. The plastic cover is fitted with a rubber seal to ensure a watertight connection with the radio enclosure, and also has 3 integrated and IP67 rated compression fitted cable glands for:

- +/- 48 Vdc Power Cable
- PoE & Management Cable
- Copper or Fiber Data Network Cable

The diameters of the glands are large enough to accept a wide variety of cable diameters and even pre-connectorized cable.

To get access to the user panel one needs to untighten the 4 screws that attaches the cover to the radio enclosure. Once removed, the user panel connections and status LEDs are clearly visible and easily accessible. Figure 3-1 shows the user panel with plastic cover removed.

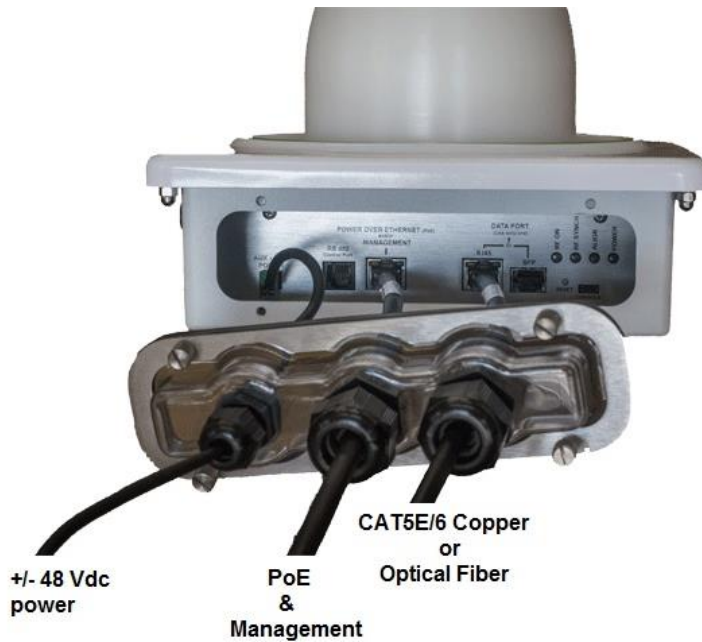

Figure 3-1: AireLink™ 60 User Panel with plastic cover removed

A detailed drawing of the user panel is shown in Figure 3-2. Besides the RSSI connector that is located at the outside of the enclosure, the user panel has all required networking, power and service connections to install the system. It incorporates also several status LEDs to visually monitor the system operational status. Table 3-1 has a listing of power/networking connectors and status LEDs.

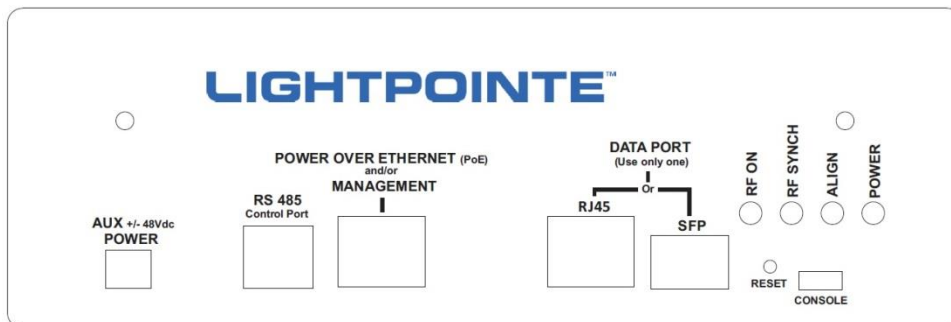

Figure 3-2: AireLink™ 60 User panel

| User Panel Connections | |
|-------------------------------------|---|
| AUX Power | Direct +/-48Vdc power connection (Polarity independent) |
| RS485 Control Port | NA |
| PoE and Management Port | 100/1000 Base-TX RJ-45 Ethernet Management connection for Out-of-Band radio management and 802.3at compliant 48 Vdc PoE power connection |
| Data Port | 100/1000 Base-TX RJ-45 copper/ SFP transceiver Combo port. SFP port support all industry standard GbE fiber and copper SFPs. |
| Console | USB based serial port connection (Customer Support / Technicians only) |
| Reset | When pressed for more than 5 seconds the system will revert to factory default settings. |
| User Panel Status Indicators | |
| RF ON | Indicates if the RF modules is operational |
| RF SYNCH | Indicates if local and remote radio units are synchronized |
| ALIGN | Indicates if system is in alignment mode.  Alignment mode is activated automatically when the system is shipped and aligned initially. In alignment mode no network connection is required to align the system. |
| POWER | Indicates if system is powered on. |

Table 3-1: User Panel Connections and Status LEDs

3.2 POWER CONNECTION

There are two options to power the radio:

1. Power over Ethernet (PoE) → Use 802.3at compatible PoE switch or Lightpointe high power passive PoE injector (see Fig. 1-4) and connect to PoE and Management Port.
2. Direct +/-48 Vdc → Use Lightpointe 48 Vdc power supply shown in Figure 1-5 and connect to the AUX power port.

| | |
|-------------|--|
| Note | <p>Power redundancy operation can be achieved by connecting a PoE and a 48 Vdc power supply in parallel. To ensure uninterrupted power in case of a power failure on either power line without system restart, please connect the PoE power first and wait until the system boot is completed before connecting the 48Vdc power line.</p> |
|-------------|--|

3.2.1 Powering via PoE

The PoE powering option is the LightPointe suggested standard way to power the system. The system ships with two indoor table top 48 Vdc PoE injector as shown in Fig. 1-4. Both the integrated antenna as well as the ODU solution requires 23 Watts of electrical power for operation and the PoE injector supplied with the system is rated at 48 Watts, leaving plenty of ample power. Input to the PoE injector is 90....240 Vac.

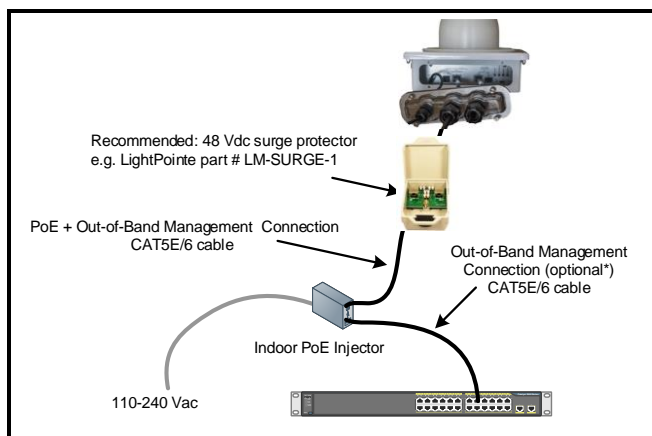





Figure 3-3: Powering via PoE

The PoE Injector is equipped with a powered and a non-powered 10/100 RJ-45 Port. Use the powered port (Output) to connect to the system **PoE and Management** port.

NOTE: For EMC compatibility reasons the system is shipped by two **ferrite beads**, one for each side of the link. Loop the Ethernet cable to be connected to the **PoE and Management** port and place the ferrite beat around the cable as shown in Fig. 3-3. The fully outdoor rated ferrite beat housing has a snap on lock mechanism to hold it in place. Distance between the entrance of the Ethernet cable into the radio housing and ferrite bead location should be around 3 inches (8 cm).

We also recommend placing a surge protector into the PoE line and preferably close to the radio head (see Fig. 3-3). The surge protector needs to be grounded and tied into the roof/tower grounding infrastructure. The PoE port also serves as Out-of-Band management port. To access the out-of-band management interface connect the non-powered port (Input) to an Ethernet switch or hub and the out-of-band management system. For more information on setting up the management system see the chapter "AireLink™ Manager - NMS Platform for AireLink™ Products".

| | |
|---|---|
|  | <p>The passive PoE Injector shipped with the system provides up to 48 Watts of electrical power @48 Vdc. Same as with the lower power 802.3at standard the injector provides power to pins 4,5 (+) and 7,8 (-). To comply with the Ethernet standard on maximum CAT5E/6 cable length, distance between the PoE output and the ODU input be not exceed 100 meters. For longer runs, please use a suitable repeater as shown in Chapter 1.2.4.3.</p> |
|  | |
|  | <p>Caution: The PoE Injector shipped with the AireLite system has a built-in short circuit and overvoltage protection. However, to prevent damage to the indoor networking equipment from potential lightning strikes we recommend using an external PoE surge protector as shown in Chapter 1.2.4.2</p> |
|  | |

3.2.2 Powering via Direct 48 Vdc

Alternatively, the AireLink™ 60 system can be powered by a direct 48 Vdc power connection connected to the AUX Power port on the radio user panel. When using the direct powering method, it is possible to extend a 16 gauge power cable length to more than 1000 feet (330 meters) using the LightPointe 48 Vdc power supply shown in Fig. 1-5. Same as for the PoE powering option, we recommend placing an external lightning/surge protector as shown in Chapter 1.2.4.2 into the power line and close to the radio head (see Fig. 3-4).

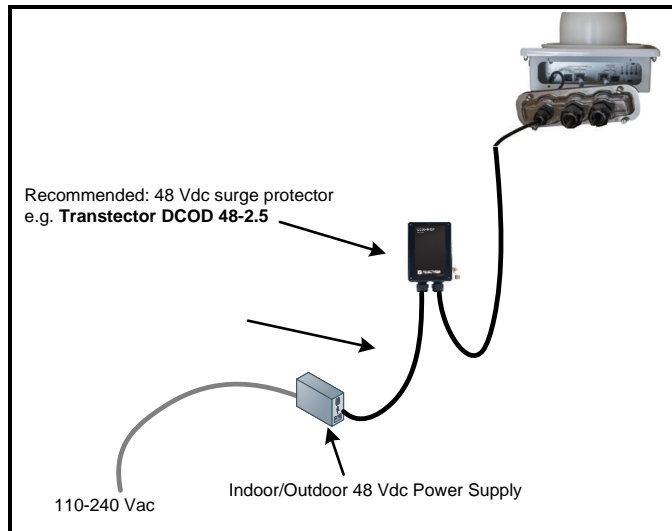

Figure 3-4: Direct 48 Vdc Power Connection



To prevent damage to the building power infrastructure from potential lightning strikes we recommend using an external 48Vdc Surge Protector as shown in Chapter 1.2.4.2.

3.3 GROUNDING/ LIGHTNING PROTECTION

Ground the radio housing by attaching an AWG 14 solid copper wire to the ground pillar on the back of the housing (see Fig. 3-5) and using the self-tapping screw and the wire lug provided with the system. Attach the opposite end of the wire to the mounting pole and make sure that there is a good and solid electrical contact. Most important, verify that the mounting pole is connected to the building/tower grounding infrastructure.



Figure 3-5: Enclosure Ground Connection

In addition, and where applicable, we recommend following the IEC 61024/ IEC 62305 standards for proper lightning protection and install the antennas within the lightning protection zone LPZ O_B where the equipment is not subject to direct lightning strikes (See Fig. 3-7).

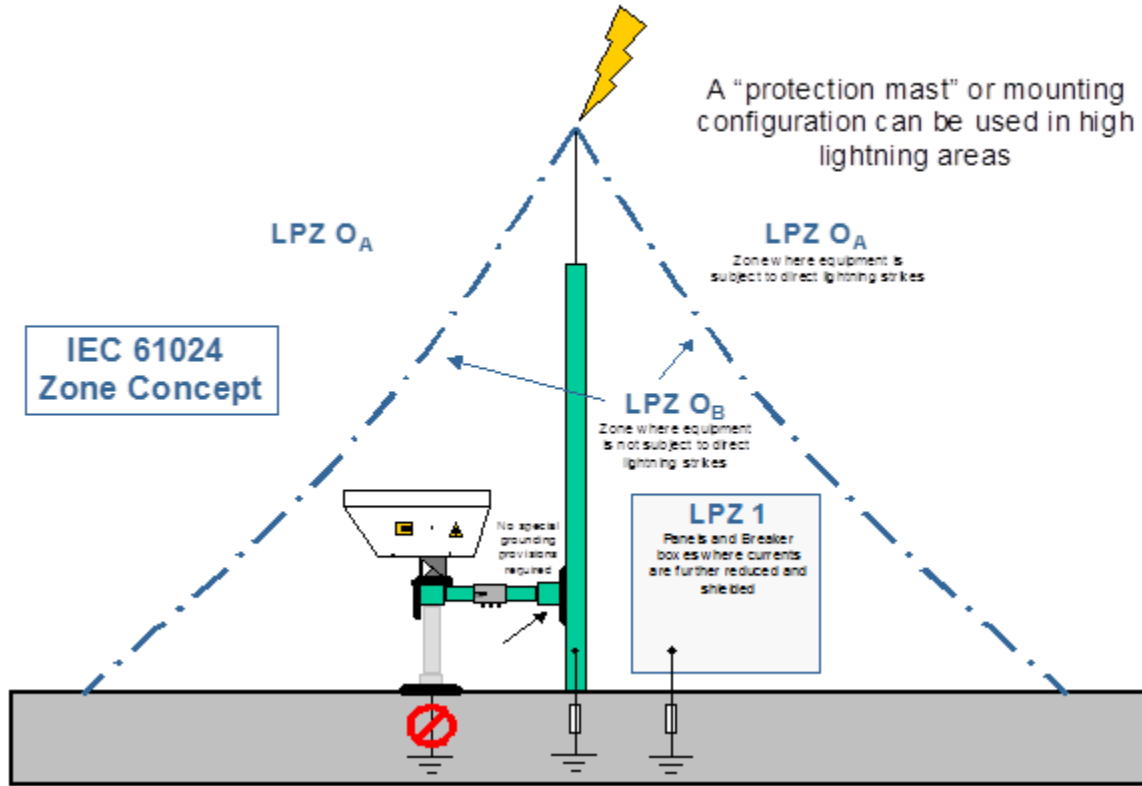

| | | |
|---|----------------------|---|
| 1 | IEC 61024 | <p>When the linkhead is located near another grounded/earthed object, such as a tower, lightning (Franklin) rod or any type of mast or pole, it may fall under the zone of protection provided by the tower or mast.</p> <p>Even if it is not under the Zone, if it is not a good path to ground/earth it is less likely to be destroyed by lightning.</p> |
| 2 | High Lightning zones | <p>It is possible to deliberately place a protective mast near the linkhead to provide this type of zone. In this case the linkhead is protected by the mast and is further protected by not being a good path to ground/earth for the lightning.</p> <p>The mast should have a sharp point at the top. This encourages the formation of the lightning strike where the electrons are concentrated at the tip of the rod and further protects the equipment</p> |
| 3 | Towers | <p>A linkhead mounted on a tower is almost always within the LPZ O_B zone and has some protection simply because of its location.</p> |

Figure 3-7: Lightning Protection Zones

3.4 NETWORK DATA CONNECTION

The AireLink™ 60 has a Combo networking data port located on the user panel (see Fig. 3-1). The system is shipped standard with a copper 100/1000 Base-TX RJ-45 connector. Auto-MDIX configuration automatically detects the required cable connection type and configures the connection appropriately, removing the potential need for crossover cables. If required by the specific setup, the port speed and simplex/duplex operation can also be fixed via the web browser/ management software.

Alternatively, the combo port can be equipped with a Gigabit Ethernet SFP fiber transceiver slot. Please, ask LightPointe sales/customer support for details and recommendations on suitable SFP fiber transceivers.

Fig. 3-8 below shows how the AireLink™ 60 is connected to the network.



The Combo data port acts as a single network connection. This means that EITHER the RJ-45 copper port OR the SFP port should be connected to the network at the same time. Connecting both ports in parallel can/will cause networking problems.

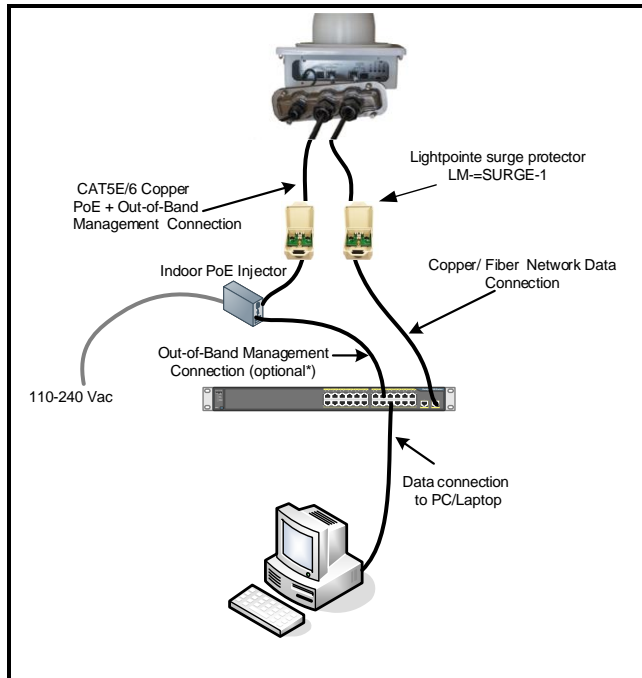

Figure 3-8: Data Network Connection

3.5 OUT-OF-BAND MANAGEMENT CONNECTION

The AireLink™60 Out-of-Band management connection shares the RJ45 100/1000Base-TX PoE powering port provided via a CAT5/6 twisted pair Ethernet cable. To get access to the AireLink™ management system the input port of the PoE module must be connected to your management network.

The Ethernet cable length of the management cable from the AireLink™ 60 radio to the switch or router should not exceed 100 meters due to Ethernet compliance issues. Otherwise a suitable Ethernet repeating device as shown in Chapter 1.2.4.3 must be used.

In Chapter 4 the AireLink™ Manager will be described in more detail.

3.6 CONSOLE PORT

The user panel micro USB based Console port is used to establish a serial port connection to a PC/laptop and the shipment contains a micro USB2.0 cable to establish the connection. The serial port is used by customer support personal / technicians for advanced troubleshooting purposes. It is therefore not necessary to pull cable for the serial port during installation. All setup and management functions can be performed over the AireLink™ Manager web-console, Telnet or SNMP. Before accessing the serial connection the user/installer needs to download and install the appropriate USB to UART Bridge Virtual COM Port (VCP) drivers from the Silicon Labs webpage at <http://www.qa.silabs.com/products/mcu/Pages/usbtouartbridgevcpcdrivers.aspx>. After installation of the driver the serial port is accessible via a serial port communications program such as HyperTerminal or PuTTY.

3.7 RSSI VOLTAGE CONNECTOR

The RSSI voltage level can be measured by connecting a digital voltmeter to the two pin and IP67 outdoor rated RSSI signal connector located on the outside of the radio enclosure (see Fig. 3-9). Two adapter cables to connect the RSSI signals to a standard voltmeter equipped with banana plug receptacles are included with the shipment (see Fig. 1-10). During the alignment process the RSSI voltage readings are taken to achieve optimum alignment of the AireLink™ system.

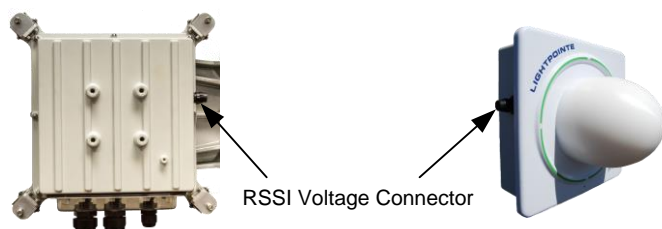

Figure 3-9: RSSI Voltage Port Connector Location

3.8 BLUETOOTH ANTENNA CONNECTOR

The Bluetooth antenna is attached to the radio enclosure via a SMA connector located at the side of the enclosure. The Bluetooth antenna is included with the shipment and must be connected to the SMA connector to enable proper Bluetooth communication with an Android based smart phone or tablet. The 2 dBi Bluetooth antenna allows for remote communication up to a distance of 100 meters under clear line-of-sight conditions between the radio link and the smart phone/tablet. In case there is no direct line-of-sight, the distance is shortened. If required, alternative higher gain antennas with SMA connectors can be used to extend the communication distance in particular in non-line-of-sight scenarios.



Figure 3-10: Bluetooth antenna connection



4 RECOMMENDED SOFTWARE PRE-CONFIGURATIONS

Before installing the radio on the roof, we recommend to perform a few simple software pre-configurations. These basic settings are important to access the management interface/web browser.

4.1 REQUIRED NETWORK SETTINGS INFO

Please, ask the Network Administrator to provide the following information:

1. IP Address for both 60 GHz radios(Pre-configured IP address is 192.168.1.10)
2. Subnet Mask (Pre-configured subnet mask is 255.255.255.0)
3. Default Gateway Address (Pre-configured gateway address is 192.168.1.1)
4. Password for CLI access (default password is **admin**)
5. Password for WEB BROWSER access (default password is **admin**)

Besides these basic settings, additional settings (e.g. SNMP community settings, VLAN settings, etc.) can be configured via the TELNET CLI interface (see Chapter 7.). Alternatively, configuration changes can be performed via the web browser interface (see Chapter 6.).

4.2 AIRELINK CONFIGURATION VIA TELNET CLI INTERFACE

Please perform the following steps to connect the ODU to the serial port:

Step 1

Connect the AireLink *Management and PoE Port* to the Output of the PoE Injector using a straight-through Cat5E cable. Plug the PoE Injector into a 110 or 240VAC outlet. The AireLink system will now power up and initialize. Depending on the software load this process can take up to 2 minutes.



The boot process is completed when the Power LED on the back panel (see Figure 3-2) stops blinking and is solid green.

Step 2

Connect a laptop/PC to the input port of the PoE injector. Ensure that the Laptop/PC is on a 192.168.1.xx subnet (default) with subnet mask 255.255.255.0 (default). Open a Windows command prompt and type >telnet 192.168.1.10.

When asked for Username type **admin** and password is **admin**

After successful login, the **Airelink 60>** command prompt will show.

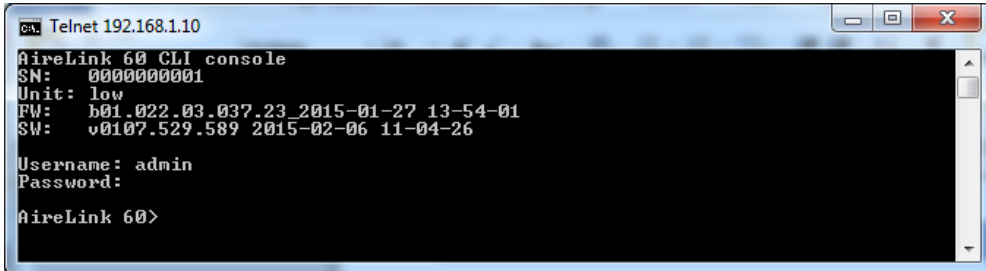

```
ca> Telnet 192.168.1.10
AireLink 60 CLI console
SN: 0000000001
Unit: low
FW: b01_022_03_037_23_2015-01-27_13-54-01
SW: v0107.529.589 2015-02-06 11-04-26

Username: admin
Password:

AireLink 60>
```

Step 3

Type >*configure* and a new command prompt **AireLink 60(config)#** Will appear.

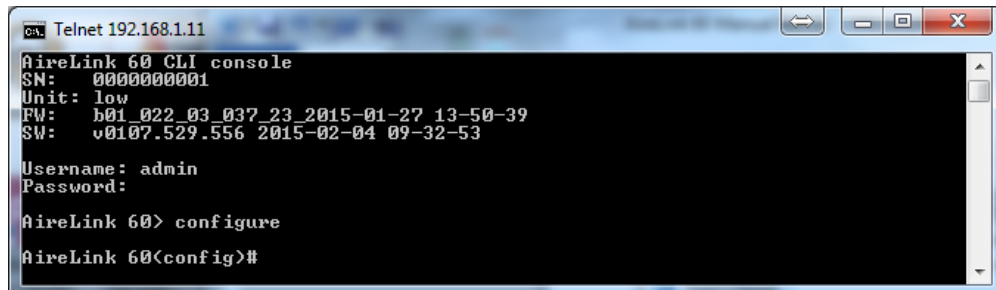

```
ca> Telnet 192.168.1.11
AireLink 60 CLI console
SN: 0000000001
Unit: low
FW: b01_022_03_037_23_2015-01-27_13-50-39
SW: v0107.529.556 2015-02-04 09-32-53

Username: admin
Password:

AireLink 60> configure
AireLink 60<config>#
```

| | |
|---------------|--|
| Step 4 | <p>To change/modify basic IP settings from the original default settings (IP:192.168.1.10, Subnet mask: 255.255.255.0, Gateway: 192.168.1.1), please use/type the following command following the AireLink 60(configure)# command prompt:</p> <p>Change/set new IP address:</p> <p>Command: airelink60(config)# interface management ip mynewIP</p> <p><i>Note: When management port IP address is changed, the new setting will occur immediately. At that point one will need to re-connect to the CLI via Telnet and using the new IP address setting.</i></p> <p>Change/set new Network Mask:</p> <p>Command: airelink60(config)# interface management netmask mynewmask</p> <p>Change/set new Default Gateway:</p> <p>Command: airelink60(config)# interface management gateway mynewgateway</p> |
| Step 5 | <p>At this point the user can/might want to also change the login password for the CLI interface and the web browser. These passwords can be different. It is important to write them down and store in a secure place to avoid problems in the future.</p> <p>Change/set new CLI password:</p> <p>Command: airelink60(config)# password cli mynewclipassword</p> <p>Change/set new WEB BROWSER password:</p> <p>Command: airelink60(config)# password web mynewwebpassword</p> |

Step 6

IMPORTANT: To save the changes in the system configuration, first exit the configuration mode by typing:

Exit configuration mode:

Command: airelink60(config)# exit

To save the changes in the system configuration the following CLI command must be executed:

Save changes to system configuration:

Example: airelink60> copy running-config startup-config

This will copy all changes to the startup configuration file located in the system flash memory. The flash preserves the new settings after system reboot.



5 SYSTEM INSTALLATION

This Chapter describes the installation processes involved with successfully deploying the LightPointe AireLink™ 60 system. Please read carefully and be certain to understand the necessary steps in deploying a high availability point-to-point wireless link. Contact LightPointe customer support if any clarification is needed.

5.1 TOOLS

Although the installation of the AireLink™ 60 system requires only a 13 mm wrench (open-end or combination wrench), a 5 Allen wrench and a simple digital voltmeter, please consider having the following tools and supplies handy when installing the LightPointe AireLink™ 60 system.

Standard electro-mechanical tool kit with pliers, screwdrivers, wire cutters, wire strippers, etc.

- Two-way radio or cell phones to communicate when aligning transmission units
- Optical fiber connector cleaning kit - if using fiber to the network
- Plastic tie wraps to secure flexible conduits, etc.
- 13 mm open-end or combination wrench (one for each mounting location)
- 13 mm socket/ratchet wrench (one for each mounting location)
- 6 mm Allen wrench – when using the optional LightPointe Universal Mount
- Whatever tools may be needed for securing the mount to surfaces/platforms
- Electrical tape for securing and fastening
- Optical light source and fiber power meter to ensure fiber performance from/to transmission unit
- Digital voltmeter to check electrical system connection and measure the receive signal level (RSSI)
- Step or extension ladder, in needed, for access to elevated locations
- High quality rope to use for hoisting materials and/or to be used in conjunction with a safety harness to ensure installer safety
- Exterior rated extension cord
- Fish tape for pulling cable

5.2 UNIVERSAL MOUNT ASSEMBLY

The antenna mounting bracket attaches to any solid vertical pole structure with a pole diameter between 2.5...4.0 inches (60...120 mm). If desired, and optionally, it is possible to use the LightPointe Universal Mount that was developed for FSO/radio solutions requiring a very stable operating platform. The fully assembled mount (without the radio link head attached) and the base plate hole mounting pattern are shown in Fig. 5-1. The 200 mm square Base Mounting Plate has four 15 mm screw holes with 160 mm center separation. During installation the Base Plate must be attached to a solid support structure (concrete parapet wall, concrete or brick wall, etc.) by using suitable heavy duty 3/8" or 1/2" masonry wall anchors (e.g. sleeve anchors).

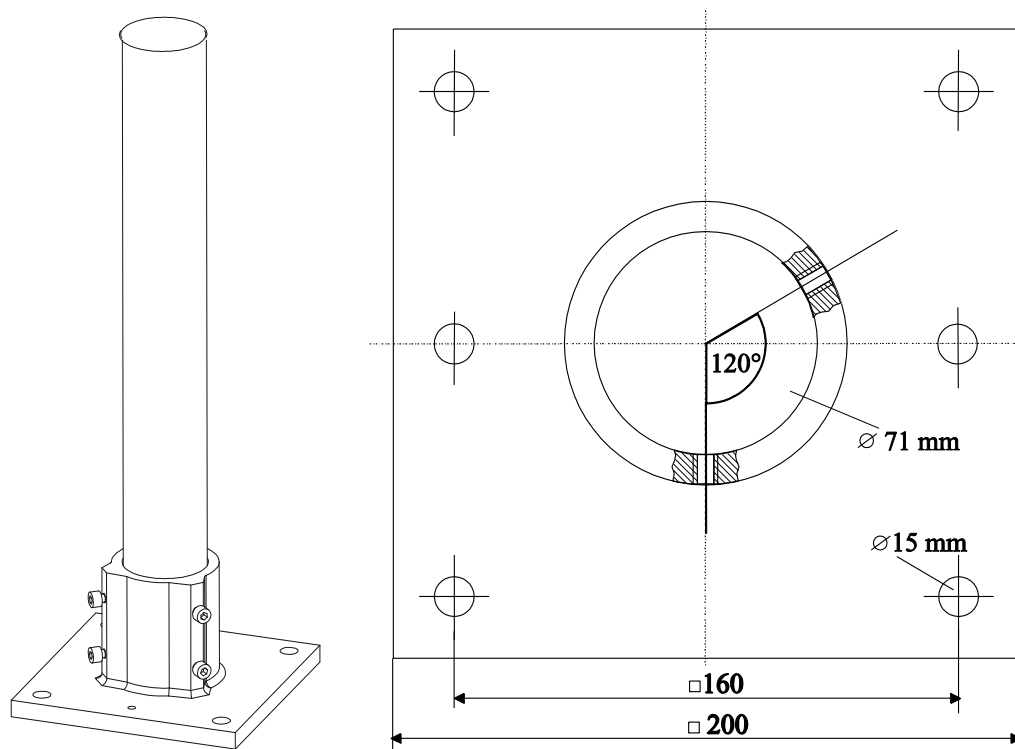
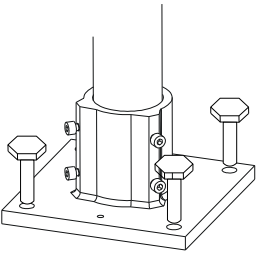
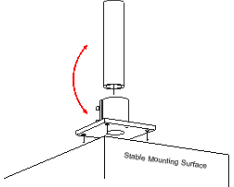
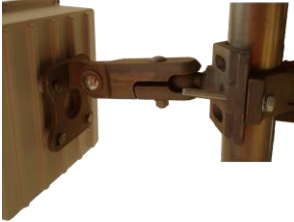

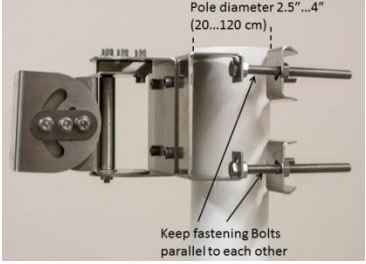

Figure 5-1: Assembled Universal Mount and Base Plate Hole Pattern

The pole can serve as the mounting pole for the AireLink™ 60 system with integrated 12 cm and external 1 or two foot antennas. If it is required for the specific installation, it is also possible to replace the standard 24" long pole of the Universal Mounting kit with a longer pole. However, it is **NOT** recommend that poles longer than 4 feet be used with the 12" and 24" antenna without stabilizing the mounting pole with guard wires.

5.3 POLE MOUNT INSTALLATION OF AIRELINK 60 WITH INTEGRATED ANTENNA

| | | |
|---|--------------------------------------|---|
|  | <p>Step 1</p> | <p>Install the mounting base plate to a solid platform using 12 mm (1/2") bolts.</p> <ul style="list-style-type: none"> ➤ Anchor the mount in wall or concrete (recommend M12-screws) ➤ Use bolts of hardness class not less than 6.6 <p>To ensure stability, keep the mounting post as short as possible. The maximum allowable mounting pole lengths are 4 feet (120 cm).</p> |
|  | <p>Step 2</p> | <p>Attach and fasten the mounting post assembly to the base plate using the supplied fastening 8mm screws with 6mm Allen heads. Do not over tighten the mounting screws.</p> |
|  | <p>Step 3-a basic bracket</p> | <p>Basic bracket- Attach the radio mounting/alignment bracket to the mounting pole. Roughly align the antenna towards the opposite radio location and tighten the bracket bolts using a 13 mm open-end or combination wrench. Ensure the bolts are EVENLY tightened.</p> |
|  | <p>Step 3-b</p> | <p>Stainless steel bracket- Attach the radio mounting/alignment bracket to the mounting pole. Roughly align the antenna towards the opposite radio location and tighten the bracket bolts using a 13 mm open-end or combination wrench. Ensure the bolts are EVENLY tightened.</p> |
|  | <p>Step 4</p> | <p>When tightening the bolts on stainless steel bracket ensure that</p> <ul style="list-style-type: none"> ➤ The antenna roughly points towards the opposite antenna location ➤ The bolts are parallel to each other ➤ Use flat washers, lock washers, and nuts provided with the lock bolts ➤ Tighten the lock nuts evenly |
| <p>Antenna pre-installation completed!</p> | | |

5.4 POLE MOUNT INSTALLATION OF AIRELINK 60 WITH EXTERNAL ANTENNA

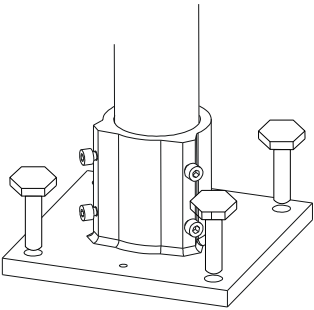
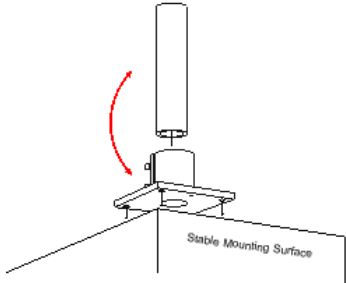
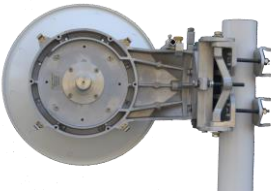
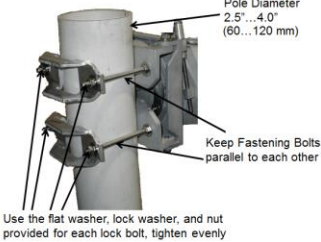
| | | |
|--|----------------------|---|
|  | <p>Step 1</p> | <p>Install the mounting base plate to a solid platform using 12 mm (1/2") bolts.</p> <ul style="list-style-type: none"> ➤ Anchor the mount in wall or concrete (recommend M12-screws) ➤ Use bolts of hardness class not less than 6.6 <p>To ensure stability, keep the mounting post as short as possible. The maximum allowable mounting pole lengths are 4 feet (120 cm).</p> |
|  | <p>Step 2</p> | <p>Attach and fasten the mounting post assembly to the base plate using the supplied fastening 8mm screws with 6mm Allen heads. Do not over tighten the mounting screws.</p> |
|  | <p>Step 3</p> | <p>Attach the radio mounting/alignment bracket to the mounting pole. Roughly align the antenna towards the opposite radio location and tighten the bracket bolts using a 13 mm open-end or combination wrench. Ensure the bolts are EVENLY tightened.</p> |
|  <p>Pole Diameter 2.5" ... 4.0" (60 ... 120 mm)</p> <p>Keep Fastening Bolts parallel to each other</p> <p>Use the flat washer, lock washer, and nut provided for each lock bolt, tighten evenly</p> | <p>Step 4</p> | <p>When tightening the bolts ensure that</p> <ul style="list-style-type: none"> ➤ The antenna roughly points towards the opposite antenna location ➤ The bolts are parallel to each other ➤ Use flat washers, lock washers, and nuts provided with the lock bolts ➤ Tighten the lock nuts evenly |
| <p>Antenna pre-installation completed!</p> | | |

5.5 ODU INSTALLATION (EXTERNAL ANTENNA SYSTEM ONLY)

After installing the antenna, please ensure that the radios on each side operate in the same polarization. In other words, the physical orientation of the radio enclosure (ODU) must be the same on both sides. There is an arrow symbol imprinted on the back of the ODU that must point in the same direction, either upwards (vertical polarization) or sideways (horizontal polarization), when looking at the back of ODU (see Figure 5-2). This ensures that both radio antennas operate in the same horizontal or vertical polarization plane. To attach the ODU to the antenna, simply guide the ODU onto the round metal flange on the back of the antenna. **Use a drop of silicone grease to lubricate the O-ring. This will ease the process of pushing the ODU onto the antenna waveguide flange.** Slightly rotate the ODU while pushing it towards the antenna base plate, and ensure to not destroy the rubber O-ring that serves as a seal/gasket between the antenna flange and the ODU housing.



Figure 5-2: ODU Polarization Directions

Once the ODU is pushed all the way down onto the antenna baseplate and aligned correctly in either horizontal or vertical position, fasten the 4 spring loaded latches to finalize the attachment of the ODU to the antenna base. Fig. 5.3 shows the AireLink™ 60 system with the ODU installed.



A transmission link that uses a different polarization on each side will not function properly.

It is also critically important that a high-band radio on one side is paired with a low band radio on the opposite side to ensure proper operation. Before installing the radio units check each radio to verify one is a high-band and the other is a low-band version. A sticker on the ODU user panel indicates the HIGH BAND and LOW BAND unit. When installing a 60 GHz radio link under a network license, ensure that the low-band and the high-band radios are installed at each side according to the assigned and approved frequency allocation plan.

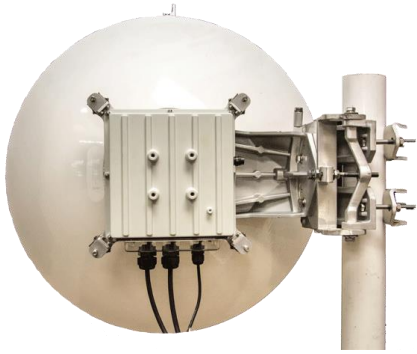

Figure 5-3: AireLink™ 60 installed on LightPointe Universal Mount

5.6 SYSTEM ALIGNMENT BASICS

After finishing the mounting of the antennas, and connecting the cabling as described in Chapter 3, the system is ready for alignment. During the alignment procedure it is only required to power on the radio, and active network traffic is not needed to align the system. The radio will automatically switch to the *alignment mode* when it is installed for the first time. To verify that the system is in *Alignment Mode*, observe the ALIGN LED the user panel. A lit LED indicates that the system is in active *alignment mode*. Regardless of the system being connected to the network via one of the data port, no traffic will pass across the radio link until the system is switch from *Alignment Mode* into *Data Mode*. See Chapter 6.3 on how to switch the system from the *Alignment Mode* into *Data Mode* using the web browser interface. After the alignment is completed it is important to save the system setting in using the Administrative sub menu in the web browser (see Chapter 6.9). Without saving the settings the system will come up in *Alignment Mode* rather than in *Data Mode* each time the power is recycled.



The radio will be in *Alignment Mode* when installed for the first time and the alignment LED on the backpanel will be lit. To enable data transmission the system must be switched into *Data Mode*. The new setting must be saved to avoid the system rebooting in *Alignment Mode* after power is recycled.

The alignment process itself will be eased if two people (one on each side) are involved in the alignment procedure. This is particularly true for the larger AireLink™ 60 with the 2 foot antenna option due to its narrower beam pattern when compared to the smaller AireLink™ 60 with the integrated 12 cm antenna or the external 1 foot antenna. Two-way radios or cell phones are extremely helpful in exchanging information between the two parties performing the alignment. While it is possible for a single individual to align the units, walking or driving back and forth between the two mounting locations can be a cumbersome and time consuming process. The correct alignment of the system is crucial for ensuring proper performance of the system and no rush should be in play when aligning the system. Depending on the experience of the installer(s) in aligning narrow beam radio transmission equipment and the actual antenna used, this process can take anywhere from 15 to 90 minutes.

5.7 ANTENNA RADIATION PATTERN AND SIDE LOBES

When aligning a 60 GHz radio with a narrow beam directional antenna pattern, it is important to understand that besides the “antenna main lobe” that contains most of the energy, there are also “antenna side lobes”. A “perfect” antenna would contain all energy in the main lobe but this is physically impossible. Although these side lobes contain far less energy - in the case of a good directional 60 GHz antenna the power of the 1st side lobe is typically more than 20 dB lower when compared to the main lobe’s peak power - one can “see” the 1st side lobe during the alignment process. This is mainly because in a 60 GHz antenna the main lobe and the 1st antenna side lobe are separated by an angle of just 2-3 degrees. This small value for the angular separation is actually close to the radiation angle of the main lobe itself. When installing a millimeter wave radio transmission system it is important to keep in mind that the antenna main lobe and the 1st antenna side lobe point in virtually the same direction. Aligning the system on a side lobe instead of aligning it on the main lobe will negatively impact performance of the system. For illustrative purposes Fig. 5-9 shows a typical antenna Radiation Pattern Envelope (RPE) diagram of a Cassegrain antenna.

Note:

During the alignment process it is important to find the main lobe and not to align the system on a side. To ensure that the main lobe is found, move the system about 10 degrees in horizontal and vertical direction and away from the perceived highest readout voltage. While “scanning” through the beam pattern from the left to the right (or from the top to the bottom) one can find the higher RSSI voltage readings before the signal drops significantly. These two “local” voltage maxima to the left and the right of the main lobe are the 1st side lobe.

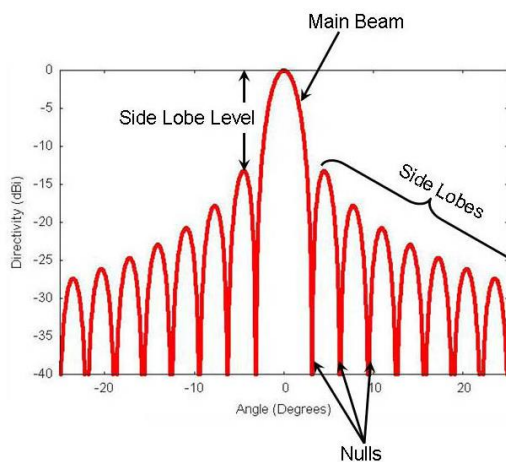

Figure 5-4: Typical antenna Radiation Pattern Envelope (RPE) diagram

5.8 INSTALLING AIRELINK™ 60 WITH INTEGRATED 12 CM ANTENNA

In preparation for the actual alignment process, carry out the following steps:

1. Power-on both radios on both sides using either the PoE or the direct 48 Vdc power connection. There is no ON/OFF switch and once connected to the power source, the radio will start the boot process. During the boot process the green Power LED on the back panel is blinking and solid green after the boot process is completed. This process will take about 90 seconds. Verify that the green **POWER LED** on the user panel inside the radio housings are lit at both radios.
2. After the boot process is completed, verify that the **RF ON LED** and the **ALIGNMENT LED** are lit. **In case the alignment LED is off, please switch the system into alignment mode using the web browser interface (see Chapter 6.3) or execute the appropriate command via the COMMAND LINE INTERFACE (see Chapter 7.)**
3. There are two options to connect to the radio and read the RSSI values:
 - a. **Via digital voltmeter** - Connect the digital voltmeter to the 2-pin connector located at the side of the radio housing using the RSSI Alignment Cables included with the system. Make sure that the digital voltmeter readout can be clearly seen during the installation process (e.g. Tape it to the installation pole).



- b. **Via Bluetooth connection** - Use an ANDROID (Version 4.4.2 or higher) and Bluetooth capable based smart phone or tablet and download the free *LightPointe BLE Tool* from the Goggle apps store <https://play.google.com/store> (see Chapter 8 for more details).



After installation of the software is completed, please reboot/restart your phone/tablet to ensure proper operation of the application.

- c. After starting the application, the software will automatically scan for AireLink systems. To find the system the line-of-sight distance between the phone/tablet and the AireLink system should not be more than 300 feet (100 meters). Distances will be shorter in case of an obstructed view. After successful discovery, click the AireLink system you would like to connect to. When asked, please enter the default passcode 0000 to finalize the connection. (**Note:** This code can be changed later using the web browser interface to preclude non authorized system access.) Open the application **RADIO** tab and observe the **RSSI** value.



- 4. Verify that the **RF ON LED** is lit (green) on both radio heads.
- 5. Most likely at this point there is no connectivity established between the radios and **RF SYNCH LED** will be off. Depending on the status and wiring of additional networking connections there might be other data port LEDs lit, too. However, these are not essential for the alignment process and the system can be aligned without an active network connection being present.

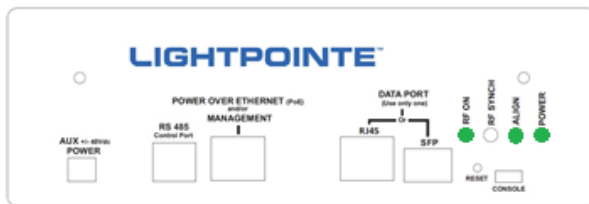

- 6. In case you bought the optional Alignment Sight Tool, please attach it to either side of the radio enclosure as shown in Fig. 5-5. The Alignment Sight Tool does not eliminate the need for precise adjustment of the antennas, but it shortens the time it takes to correctly point the antenna towards the remote antenna locations.



Figure 5-5: Alignment Sight Tool (Integrated Antenna System)

7. Look through the Alignment Sight Tool and turn the Elevation and Azimuth Adjustment Screws until the opposite antenna location shows in the middle of the Alignment Sight Tool. The inside of the tool is reflective and this helps to center the remote antenna site location. In case the opposite side is too far away to be clearly seen, please use binoculars to find an easy recognizable landmark close to the opposite antenna side. Perform the same procedure at both sides.
8. The alignment tool is meant to provide a rough alignment towards to opposite antenna location. It is however not an exact tool for finding the best alignment of the antennas. More precise alignment is done via the digital voltmeter or the *LightPointe BLE Tool* that measures the receive signal strength/RSSI voltage. Within several dB of accuracy the RSSI voltage reading in Volt corresponds to the RF RSSI signal reading in dBm. In other words, and with the correct polarity chosen, a system that is not aligned at all will show a negative voltage reading close to -0.80 Volt and this translates into -80 dBm. This signal level is far too low to establish a data connection. During the alignment process the voltage reading will increase, meaning “less negative” voltages or higher RF RSSI reading in dBm will be recorded. The goal is to align the system at its best possible and highest RSSI reading (e.g. increase the voltage reading from -0.8 V to -0.5 V). LightPointe provides a distance vs. voltage reading chart for the AireLink 60 system using either the integrated or the external antenna options (see Figure 5-8). When using the *Lightpointe BLE Tool*, the RSSI reading is given in dBm directly.
9. To align the system turn the Azimuth and Elevation Adjustment Screws at each antenna left/right for best azimuth alignment and up/down for best elevation alignment and observe the voltmeter or Android software reading. The goal is to find the maximum RSSI voltage reading (lowest negative voltage) on both sides of the link. Using a meander-like scan pattern has proven to be the most efficient way to align the antennas. This is illustrated in Fig. 5-6.

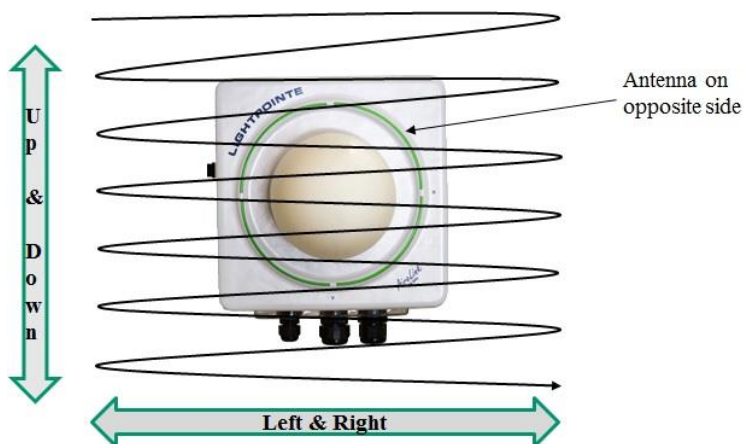



Figure 5-6: Antenna alignment scan

 **Do NOT move both radios at the same time. Try to optimize the RSSI signal level first at one side and then repeat this process at the opposite side. Communicate changes in signal levels during the adjustment process to the person at the opposite side via a two-way radio or cell phone.**

10. Ensure that the antennas are not aligned on a side-lobe. In particular when the system is installed over short distances the side-lobes can be easily seen. Rotate the antenna a few degrees to each side of the perceived alignment center and both side-lobes can be detected as "local RSSI voltage minima". The main lobe which is located right in the middle between the two side lobes will have a much higher voltage reading. Fig. 5-7 shows a simple illustration of the alignment process and the location of the antenna side lobes in relation to the main lobe.

Note: For longer distances between the antennas the side lobes might not be visible due to the much lower signal power contained in a side lobe when compared to the main lobe.

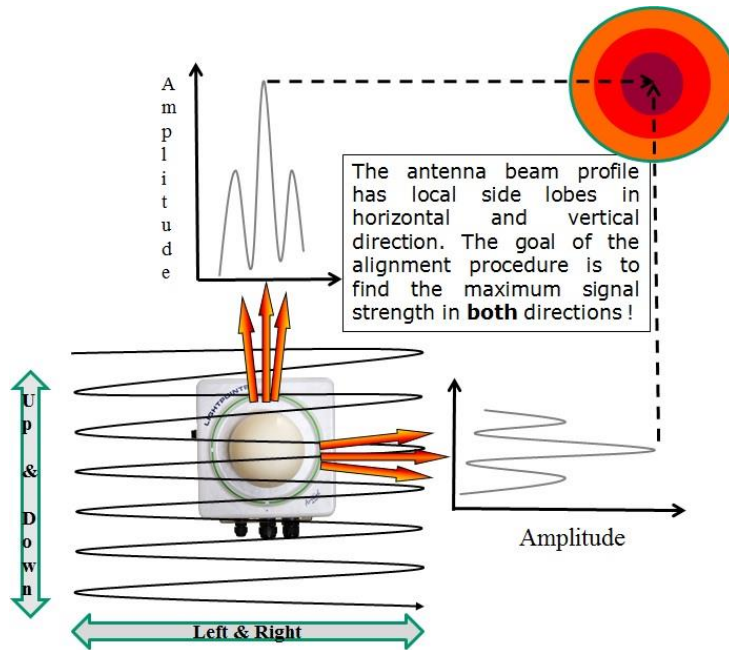

Figure 5-7: Simple illustration of the alignment process

11. When aligning the system it is important to take a look at the Receive Signal Strength chart shown in Fig. 5-8. The RSSI chart shows the RSSI signal voltage as a function of the deployment distance in clear weather conditions. Therefore, and when the system is installed under non-clear weather conditions, the values can be lower during the actual installation process. 60 GHz systems are also impacted by oxygen absorption (see Fig. 2-2) and these values can also vary several dB between sea level installations and installations at higher altitudes. The RSSI values are different for the low band and the high band radio and the values vary slightly and within a few percent from one radio system to another due to manufacturing tolerances. However, the chart provides a very good indication of expected RSSI values as a function of deployment distance. The overall goal of the alignment process is to align the system as close as possible to the RSSI value provided in the RSSI chart.

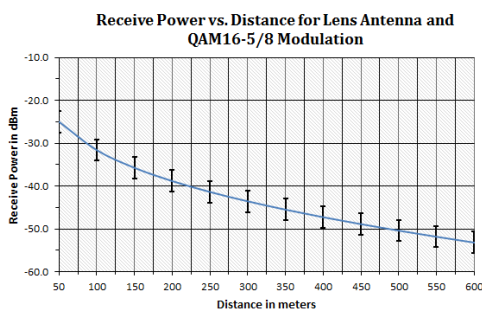

Figure 5-8: Typical AireLink 60-SX RSSI vs. Distance Charts for standard distance setting.

12. After maximizing the RSSI signal levels on both sides of the link, do not forget tightening the Elevation and Azimuth Locking Bolts (see Fig. 5-7 and Fig. 5-8).
13. Disconnect the voltmeter from the RSSI signal connector. **Use web browser to switch the system from ALIGNMENT MODE to DATA MODE operation. Failing to perform this step will result in the system rebooting in ALIGNMENT MODE when the system is power cycled. After performing this step, the ALIGN LED on the user panel should be off.**
14. When looking at the user panel (see Fig. 5-9) the following LEDs should be on:
- ✓ **POWER LED**
 - ✓ **RF ON**
 - ✓ **RF SYNCH**

Depending on the status of the networking connections additional port status LEDs might be lit, too.

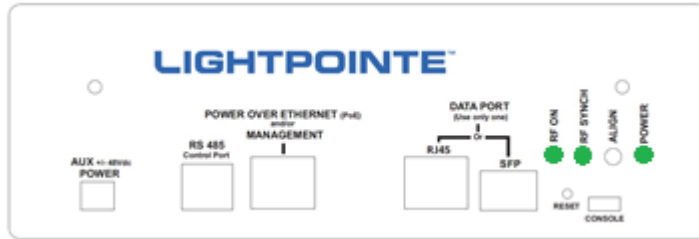

Figure 5-9: Default User Panel status after successful alignment

15. When using the integrated lens antenna the minimum distance between the antennas in **Standard** distance mode (see RF Link menu on page 74) is 100 meter. If the system is installed over a shorter distance, please change the distance setting to **Short** or **Very Short** distance to avoid receiver saturation which occurs around -31 dBm. The table below shows the distance ranges for **Standard**, **Short** and **Very Short** distance settings.

| Antenna Type | Standard Distance | Short Distance | Very Short Distance |
|----------------------|-------------------|------------------|---------------------|
| Integrated Lens (SX) | >100 meters | 100....50 meters | 50...25 meters |

The Installation is now completed and the radio link operational!

5.9 INSTALLING AIRELINK™ 60 WITH EXTERNAL ANTENNAS

In general terms, the alignment of the AireLink™ 60 with an external 1 or 2 foot antenna is very similar to the alignment of the system with the integrated 12 cm antenna. However, the larger antenna systems, and in particular the 2 foot antenna system, have a narrower antenna transmission/receive angle. Consequently the installation can take a little bit longer.

5.10 INSTALLING THE OPTIONAL ALIGNMENT SIGHT TOOL FOR EXTERNAL ANTENNAS

To ease the alignment process using narrow angle 1 and 2 foot external antennas LightPointe provides an optional **Alignment Sight Tool** (see Fig. 5-10) that attaches to either the 1 foot or 2 foot antenna system. The Alignment Sight Tool does not eliminate the need for precise adjustment of the antennas but it shortens the time it takes to correctly point the antenna towards the remote antenna locations.



Figure 5-10: Alignment Sight Tool (External Antenna System)

5.11 AIRELINK™ 60 WITH 1 FOOT ANTENNA

In case of the AireLink™ 60 with the external 1 foot antenna the Alignment Sight Tool attaches to the mounting/alignment bracket. The following procedure to install the Alignment Sight Tool should be followed:

1. Determine the location to install the Alignment Sight Tool. The Alignment Sight Tool can be positioned on the top or bottom of the antenna mount (see Fig. 5-11, upper left). It is best to attach sight beside the azimuth adjustment screw to ensure adequate room for use of wrenches during alignment procedure. Note that antenna mount can be used in different orientations; therefore the azimuth adjustment screw may be on the top or bottom.
2. Slide sight onto the mount. It is very important to make sure that the ridge on the mount is engaged with the groove on the underside of the sight clamp. If the clamp does not fit as shown Fig. 5-11 (upper right), see Sight Setup instructions further.
3. Once the sight is in position on the mount tighten the knob to hold it in place.

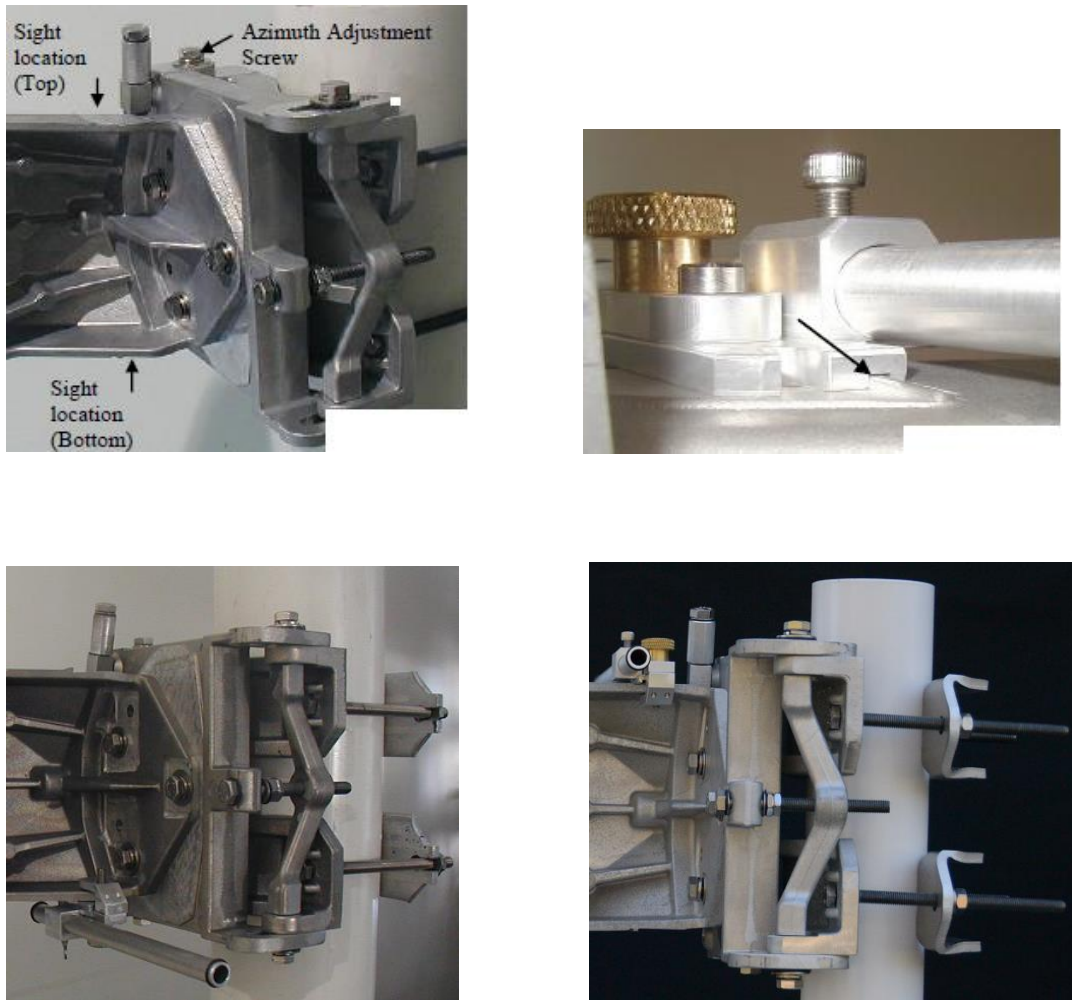

Figure 5-11: Attach Alignment Sight Tool to external 1 foot antenna

5.12 AIRELINK™ 60 WITH 2 FOOT ANTENNA

1. The sight clamp for the Alignment Sight Tool is on the top (bottom) of the 2 foot antenna.
2. Slide the Sight onto the mounting bracket as shown in Fig. 5-12 (right). It is very important to make sure that the ridge on the bracket is engaged with the groove on the sight clamp.



Figure 5-12: Attach Alignment Sight Tool to external 2 foot antenna

5.13 CONFIGURATION OF THE ALIGNMENT SIGHT TOOL

The alignment sight clamp may need to be reconfigured for proper fit. Fig. 5-13 shows how to change the configurations. To re-configure, remove the brass knob, move to clamp the desired position and replace the knob.



Figure 5-13: Re-configuring Alignment Sight Tool

5.14 MOUNTING BRACKET ADJUSTMENT

At this point during the installation process the antennas should be attached to the mounting pole in such a way that they roughly point towards each other. The alignment brackets fine adjust mechanisms are used to precisely tune the antenna elevation and azimuth. The procedure described below is the same for the 1 foot and 2 foot antenna.

Elevation Adjustment

To adjust the elevation settings of the antenna see Fig. 5-7 and perform the following steps:

1. Slightly loosen the 3 Elevation locking bolts.
2. Determine if elevation adjustment must be performed in upwards or downward direction.
3. In case the elevation must be adjusted upwards, ensure that the two Elevation Locking Bolts marked **I/II** in Fig. 5-14 are both in position **I**. If not, keep the Pivot Bolt in place and unscrew these two locking bolts. Support the antenna when removing the last/second bolt to avoid the antenna sliding down. On the back of the alignment bracket is the lock bolt holder (see Fig. 5-7) and it needs to be put in place again before re-inserting the bolts in position **I**. Do not completely tighten the bolts to allow the antenna to move when turning the Elevation Adjustment Screw.

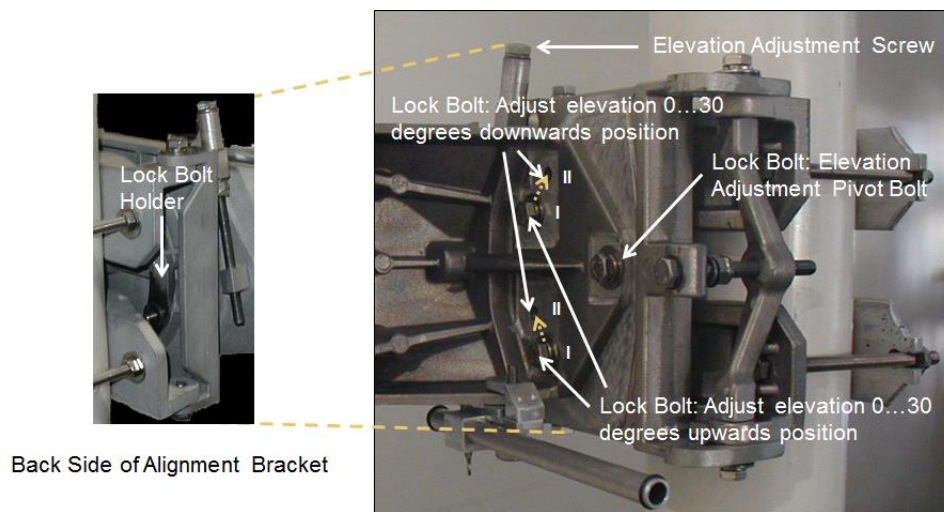

Figure 5-14: Elevation Adjustment

4. In case the antenna elevation needs to be adjusted downwards, take sure that the two Elevation Locking Bolts are both in position **II**. If not, perform steps as described under 3.

| | |
|-------------|---|
| Note | When re-arranging the antenna bracket for upwards/downwards elevation adjustment, it is helpful to have a second person assisting the process. |
|-------------|---|

5. To adjust the antenna elevation use a 13 mm combination or ratchet wrench and turn the Elevation Adjustment Screw either clock- or counter clock wise.

Azimuth Adjustment

1. To adjust the azimuth settings of the antenna see Fig. 5-15 and perform the following steps:
2. Slightly loosen the 4 Azimuth Adjustment Locking Bolts.
3. To adjust the antenna azimuth direction use a 13 mm combination or ratchet wrench and turn the Azimuth Adjustment Screw either clock- or counter clock wise.

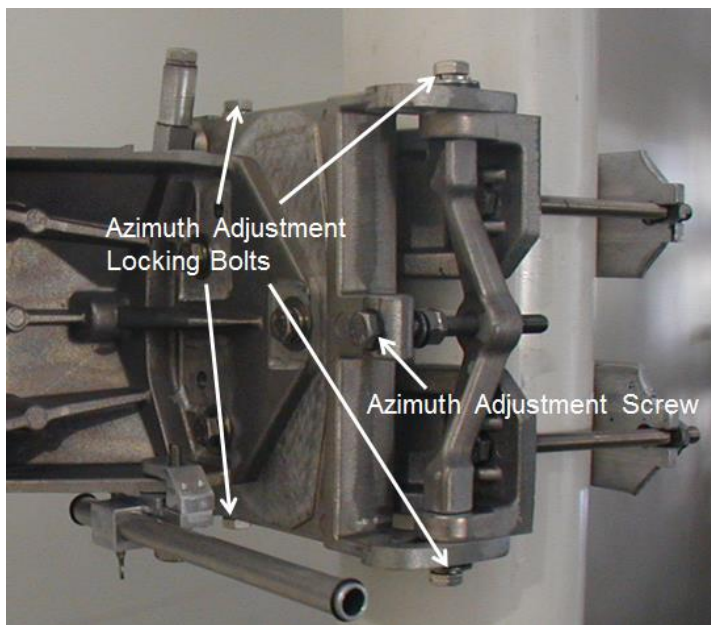
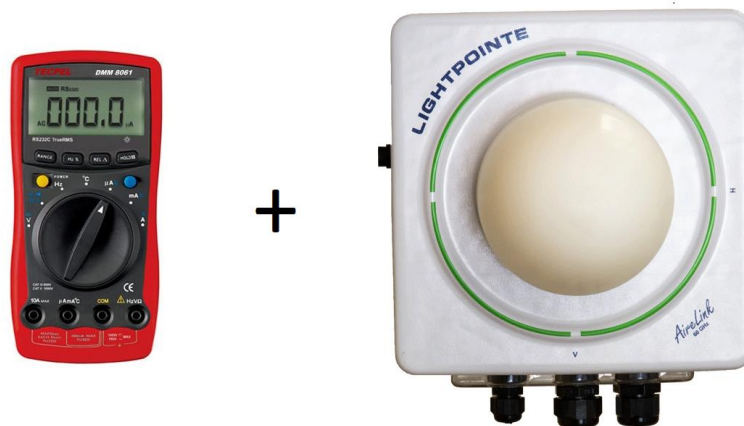

Figure 5-15: Azimuth Adjustment

5.15 ALIGNING THE 60 GHZ ANTENNAS

In preparation for the actual alignment process, carry out the following steps:

1. Power-on both radios on both sides using either the PoE or the direct 48 Vdc power connection. There is no ON/OFF switch and once connected to the power source, the radio will start the boot process. During the boot process the green Power LED on the back panel is blinking and solid green after the boot process is completed. This process will take about 90 seconds. Verify that the green **POWER LED** on the user panel inside the radio housings are lit at both radios.
2. After the boot process is completed, verify that the **RF ON LED** and the **ALIGNMENT LED** are lit. **In case the alignment LED is off, please switch the system into alignment mode using the web browser interface (see Chapter 6.3) or execute the appropriate command via the COMMAND LINE INTERFACE (see Chapter 7.)**
3. There are two options to connect to the radio and read the RSSI values:
 - a. **Via digital voltmeter** - Connect the digital voltmeter to the 2-pin connector located at the side of the radio housing using the RSSI Alignment Cables included with the system. Make sure that the digital voltmeter readout can be clearly seen during the installation process (e.g. Tape it to the installation pole).



- b. **Via Bluetooth connection** - Use an ANDROID (Version 4.4.2 or higher) and Bluetooth capable based smart phone or tablet and download the free *LightPointe BLE Tool* from the Goggle apps store <https://play.google.com/store>. Installing the software will require to grant access to the phone's Bluetooth connection (see Chapter 8 for more details).



After installation of the software is completed, please reboot/restart your phone/tablet to ensure proper operation of the application.

- c. After starting the application, the software will automatically scan for AireLink systems. To find the system the line-of-sight distance between the phone/tablet and the AireLink system should not be more than 300 feet (100 meters). Distances will be shorter in case of an obstructed view. After successful discovery, click the AireLink system you would like to connect to. When asked, please enter the default passcode 0000 to finalize the connection. (**Note:** This code can be changed later using the web browser interface to preclude non authorized system access.) Open the application **RADIO** tab and observe the **RSSI** value.



- 4. Verify that the **RF ON LED** is lit (green) on both radio heads.
- 5. Most likely at this point there is no connectivity established between the radios and **RF SYNCH LED** will be off. Depending on the status and wiring of additional networking connections there might be other data port LEDs lit, too. However, these are not essential for the alignment process and the system can be aligned without an active network connection being present.

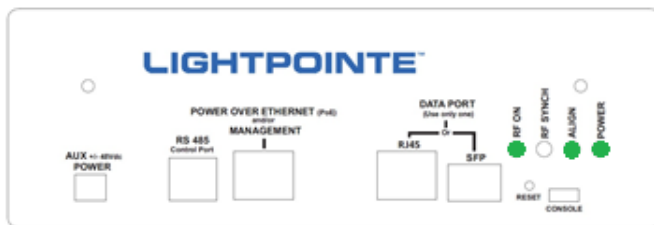

- 6. Look through the Alignment Sight Tool and turn the Elevation and Azimuth Adjustment Screws until the opposite antenna location shows in the middle of the Alignment Sight Tool. The inside of the tool is reflective and this helps to center the remote antenna site location. In case the opposite side is too far away to be clearly seen, please use binoculars to find an easy recognizable landmark close to the opposite antenna side. Perform the same procedure at both sides.



- The alignment tool is meant to provide a rough alignment towards to opposite antenna location. It is however not an exact tool for finding the best alignment of the antennas. This is done via the digital voltmeter.
- Turn the Azimuth and Elevation Adjustment Screws at each antenna left/right for best azimuth alignment and up/down for best elevation alignment and observe the voltmeter reading. The goal is to find the maximum RSSI voltage reading on both sides of the link. Using a meander-like scan pattern has proven to be the most efficient way to align the antennas. This is illustrated in Fig. 5-16.

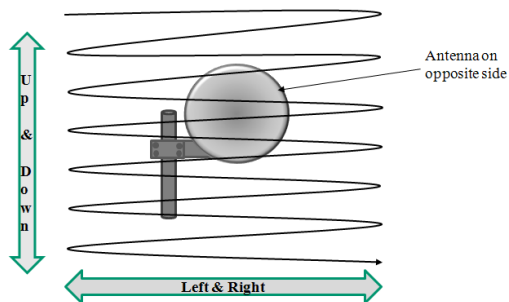

Figure 5-16: Antenna alignment scan



Do NOT move both radios at the same time. Try to optimize the RSSI signal level first at one side and then repeat this process at the opposite side. Communicate changes in signal levels during the adjustment process to the person at the opposite side via a two-way radio or cell phone.

Ensure that the antennas are not aligned on a side-lobe. In particular when the system is installed over short distances the side-lobes can be easily seen. Rotate the antenna a few degrees to each side of the perceived alignment center and both side-lobes can be detected as “local RSSI voltage minima”. The main lobe which is located right in the middle between the two side lobes will have a much higher voltage reading. Fig. 5-17 shows a simple illustration of the alignment process and the location of the antenna side lobes in relation to the main lobe.

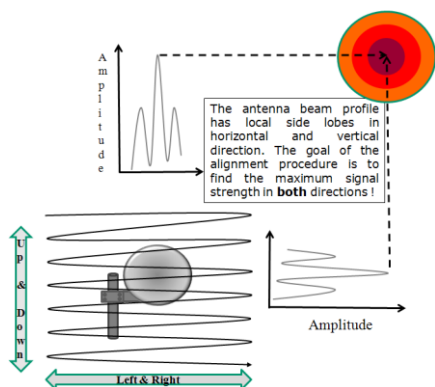

Figure 5-17: Simple illustration of the alignment process

Note:

For longer distances between the antennas the side lobes might not be visible due to the much lower signal power contained in a side lobe when compared to the main lobe.

16. When aligning the system it is important to take a look at the Receive Signal Strength using either a voltmeter attached to the alignment voltage connector located at the side of the radio housing, or using the LightPointe BLE Tool and Observe the RSSI value shown in the radio submenu. The RSSI chart in Fig. 5-18 shows the RSSI signal voltage as a function of the deployment distance under ideal and clear weather conditions. Therefore, and when the system is installed under non-clear weather conditions, the values can be lower during the actual installation process. 60 GHz systems are also impacted by oxygen absorption (see Fig. 2-2) and these values can vary several dB between sea level installations and installations at higher altitudes. The RSSI values are different for the low band and the high band radio and the values vary slightly and within a few percent from one radio system to another due to manufacturing tolerances. However, the chart provides a very good indication of expected RSSI values as a function of deployment distance. The overall goal of the alignment process is to align the system as close as possible to the RSSI value provided in the RSSI chart. The RSSI voltage reading in Volt corresponds to the RF RSSI signal reading in dBm. In other words, and with the correct polarity chosen, a system that is not aligned at all will show a negative voltage reading close to -0.80 Volt and this translates into a -80 dBm power reading. This signal level is far too low to establish a data connection. During the alignment process the voltage reading will increase, meaning “less negative” voltages or higher RF RSSI reading in dBm will be recorded. The goal is to align the system at its best possible and highest RSSI reading (e.g. increase the voltage reading. When using the *Lightpointe BLE Tool*, the RSSI reading is given in dBm directly.

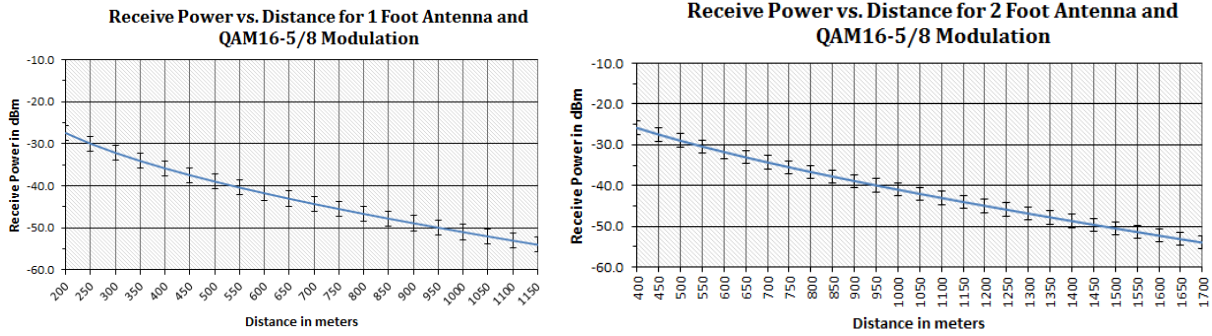

Figure 5-18: Typical AireLink 60 MX/LX RSSI vs. Distance Charts for stand distance settings

9. After maximizing the RSSI signal levels on both sides of the link, do not forget tightening the Elevation and Azimuth Locking Bolts (see Fig. 5-14 and Fig. 5-15).
10. Disconnect the voltmeter from the RSSI signal connector. **Use web browser to switch the system from ALIGNMENT MODE to DATA MODE operation. Failing to perform this step will result in the system rebooting in ALIGNMENT MODE when the system is power cycled. After performing this step, the ALIGN LED on the user panel should be off.**
11. When looking at the user panel (see Fig. 5-19) the following LEDs should be on:
 - ✓ **POWER LED**
 - ✓ **RF ON**
 - ✓ **RF SYNCH**

Depending on the status of the networking connections additional port status LEDs might be lit, too.

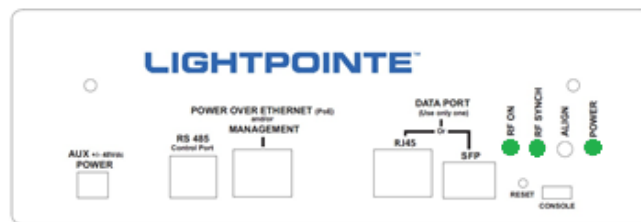

Figure 5-19: Default User Panel status after successful alignment

12. When using the external 1 foot or 2 foot dish antennas, the minimum distance between the antennas in **Standard** distance mode (see RF Link menu on page 74) is 325 and 550 meters, respectively. If the system is installed over a shorter distance, please change the distance setting to **Short** or **Very Short** to avoid receiver saturation which occurs around -31 dBm. The table below shows the distance ranges for **Standard**, **Short** and **Very Short** distance settings.

| Antenna Type | Standard Distance | Short Distance | Very Short Distance |
|------------------|-------------------|-------------------|---------------------|
| 1 Foot Dish (MX) | >325 meters | 325....200 meters | 200...120 meters |
| 2 Foot Dish (LX) | >550 meters | 550....400 meters | 400...250 meters |

The Installation is now completed and the radio link operational!



6 LINKMANAGER™ – NETWORK MANAGEMENT PLATFORM

The AireLink™ system can be monitored/managed via a web browser based interface, a TELNET based CLI Interface, via or SNMP. The web browser interface can be easily accessed via the http protocol using a standard INTERNET EXPLORER, CHROME or FIREFOX web browser. SNMP operation requires the installation of a SNMP Management System at the customer side.

6.1 MANAGEMENT APPLICATION VIEWS

To connect to the LinkManager™ browser-based management application, connect an Ethernet cable to the *Power-over-Ethernet and Management Port* located on the radio back panel (see Fig. 5-19) and open a web-browser on the same subnet as the Aire unit and enter the IP address of the AireLink unit in the address/URL field.

Note **The default IP address of the AireLink radio is 192.168.1.10.
The default user name is admin and the default password is admin**



Figure 6-1: LinkManager™ Login Window

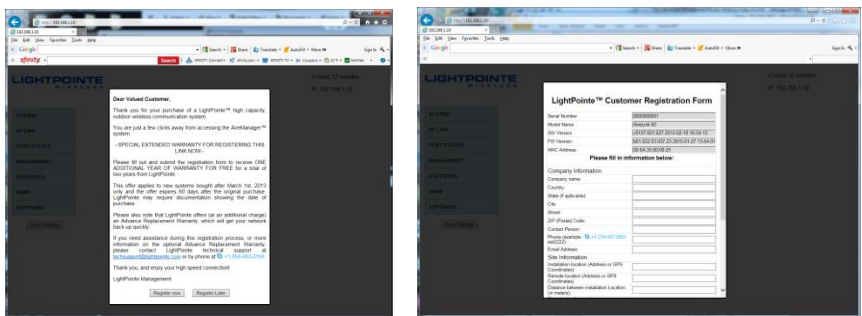

Figure 6-2: LinkManager Registration Screen

When first time logging into the LinkManager™ management application you are presented with the registration screen (see Fig. 6-2). This screen will appear every time you log into the application, until the registration process has been completed. Please complete the registration process because it will help customer support troubleshoot the system in case of an installation problem.

Next the LinkManager™ main screen will appear. On the upper right of the window the local time, system uptime and the IP address are displayed. Below the time and IP settings, there are “**Save Settings**” and a “**Log out**” buttons.

On the left side of the main window several sub menus are displayed. Specific changes to some of the system settings can be made within each of the sub menus. Settings that can be changed will be listed in red in the tables below. To change a system setting, first press the **Edit** button. Next the background color of the specific entries that can be changed will turn white. After performing the desired changes please press the “**Apply**” button, or the “**Cancel**” button to keep the original settings. To make the changes permanent do not forget to save them to the system flash memory by clicking the “**Save settings**” button on the upper right of the main page.

Clicking on a specific submenu will open a window displaying its content. In the following the functionality provided by each submenu will be explained in detail.

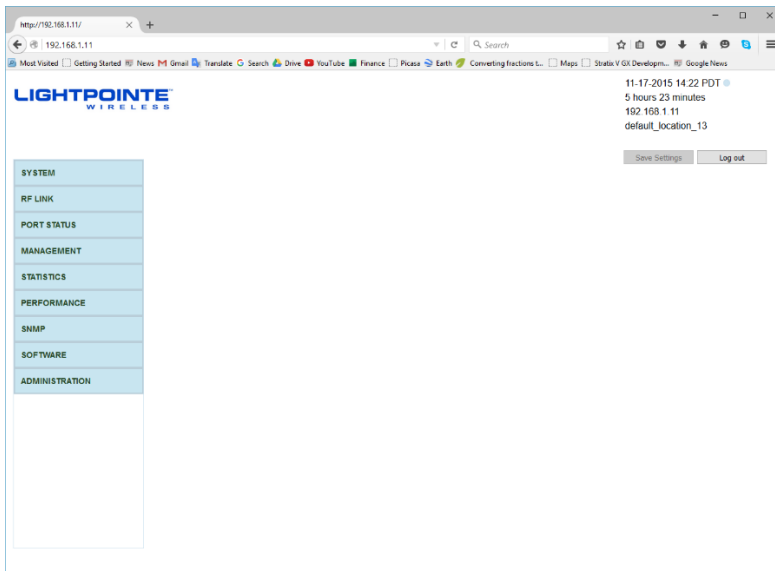

Upper right:

- System Time
- System Uptime
- System IP address
- System Installation Location
- Save Settings Log out

Figure 6-3: LinkManager™ Main Screen

| | |
|-----------------------|--|
| SYSTEM | Shows general system information |
| RF LINK | Allows monitoring and changing RF radio parameters |
| PORT STATUS | Allows monitoring and changing physical network port specific settings |
| MANAGEMENT | Allows monitoring and changing management port specific settings |
| STATISTICS | Allows monitoring RMON counters |
| PERFORMANCE | Allows for recording and storing RSSI and MCS values |
| SNMP | Allows settings SNMP specific parameters |
| SOFTWARE | Allows download/upload of software/firmware |
| ADMINISTRATION | Allows settings/execution of administrative parameters |

6.2 SYSTEM VIEW

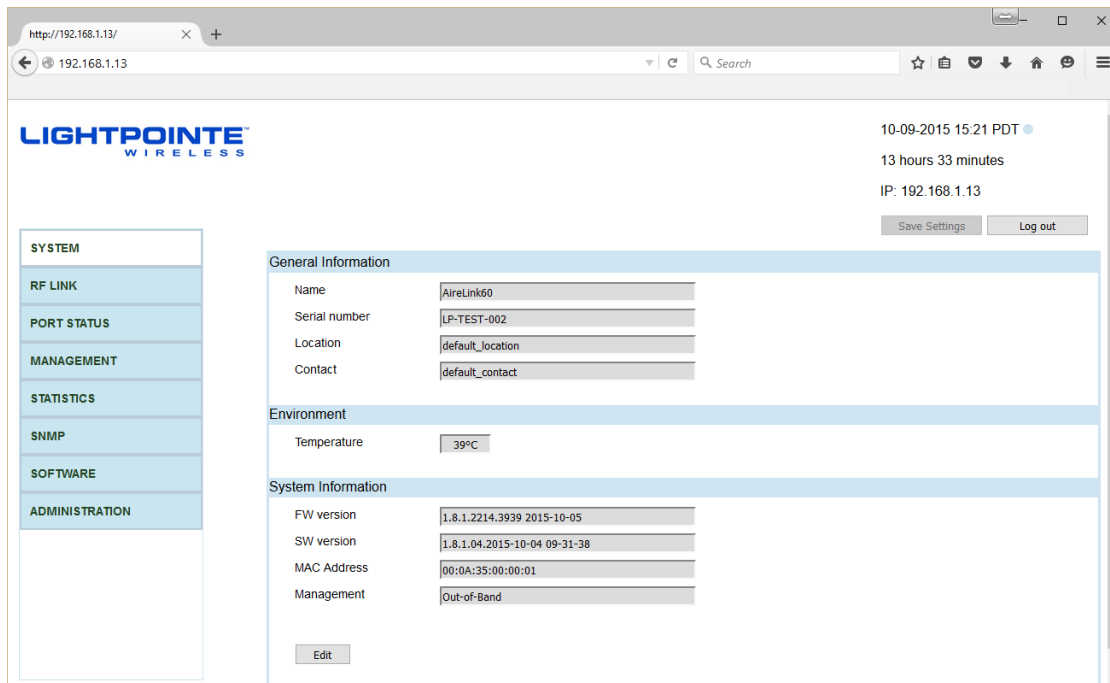

Figure 6-4: System View Screen

GENERAL INFORMATION

- Name** Name of System Model
- Serial Number** System Serial Number
- Location** Installation Location
- Contact** Contact Info

ENVIRONMENT

- Temperature** Internal Temperature

SYSTEM INFORMATION

- FW Version** Installed Firmware Version
- SW Version** Installed Software Version
- MAC Address** System MAC Address
- Management** Out-of_Band (default)

6.3 RF LINK VIEW

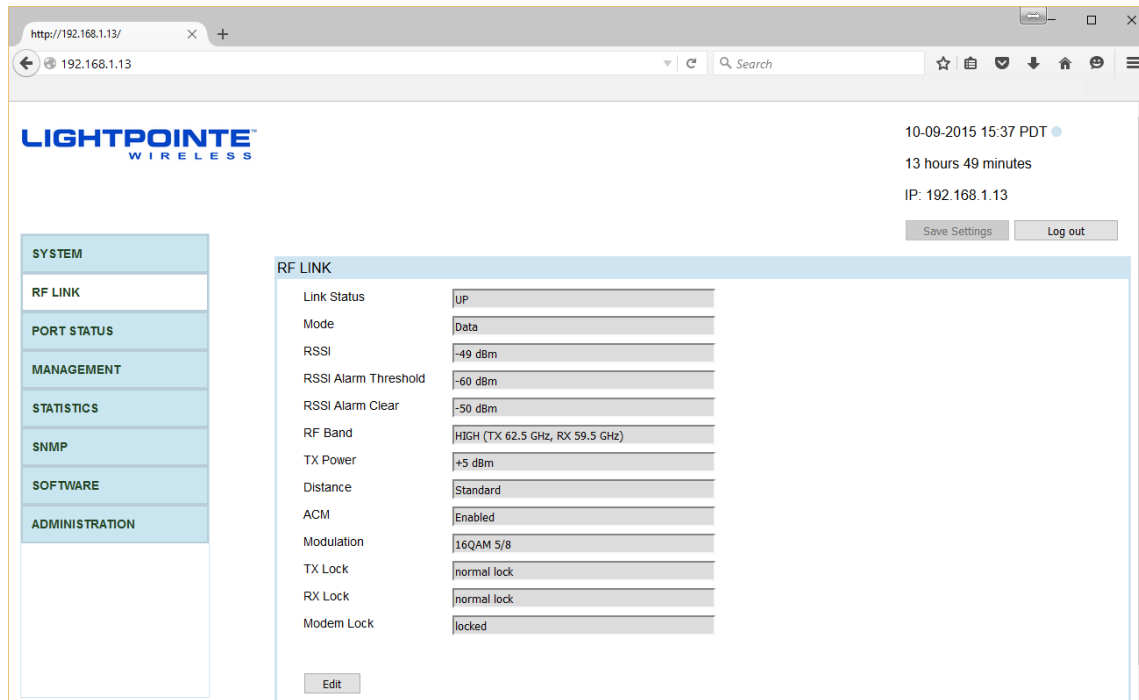

Figure 6-5: RF Link View Screen

RF LINK**Link Status**

Displays Link Status → UP/DOWN

Mode

Operational Mode → Alignment Mode / Data Transmission Mode

RSSI

Displays System RSSI Reading

RSSI Alarm Threshold

RSSI Alarm Threshold Value

RSSI Alarm Clear

RSSI Alarm Clear Value

RF BandShows and allows changing radio TX transmission and RX receive frequencies
Options: 59.0, 59.5 and 60 GHz (low band) ; 62.0, 62.5 and 63 GHz (high band)**TX Power**

Shows System Transmit Power Level

Distance

TX power reduction when systems are deployed over shorter distances

ACM

Automatic Coding and Modulation Setting → ENABLED/DISABLED

Modulation Status

Displays System Modulation Level

Set Modulation

System Modulation (Only when ACM is DISABLED)

TX Lock

Displays Transmitter Lock Status

RX Lock

Displays Receiver Lock Status

Modem Lock

Displays Modem Lock Status

6.4 PORT STATUS VIEW

The AireLink 60 system has three networking ports:

1. 100/1000 RJ45 copper port
2. GbE Fiber SFP port for SM/MM fiber transceiver
3. 100/1000 RJ45 copper management port (802.3at poE compatible)

Each port can be configured separately via the LinkManager™ application.

RJ45 Data Port:

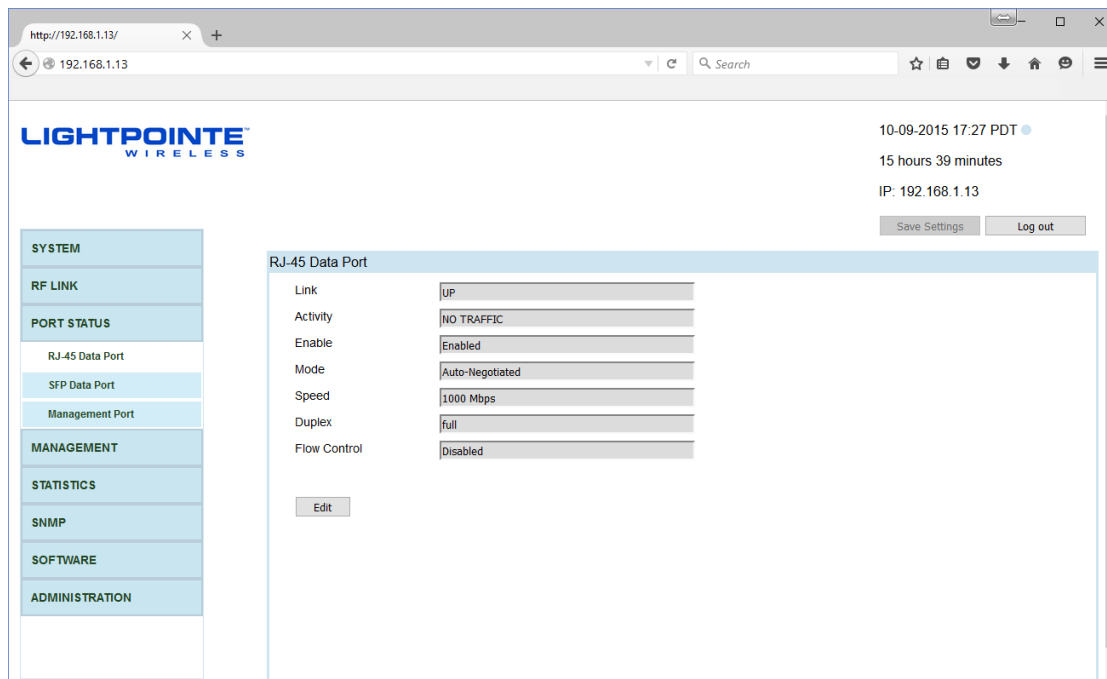

Figure 6-6: Port Status View (RJ45 Data Port)

RJ45 DATA PORT

| | |
|---------------------|---|
| Link | Displays Link Status → UP/DOWN |
| Activity | Displays Link Activity → Traffic / No Traffic |
| Enable | Port Status → ENABLED / DISABLED |
| Mode | Negotiation → MANUAL / AUTO-NEGOTIATED |
| Speed | Throughput Configuration → 100 Mbps / 1000 Mbps |
| Duplex | Duple Mode → HALF / FULL |
| Flow Control | Control Flow → ENABLED / DISABLED |

SFP Data Port:

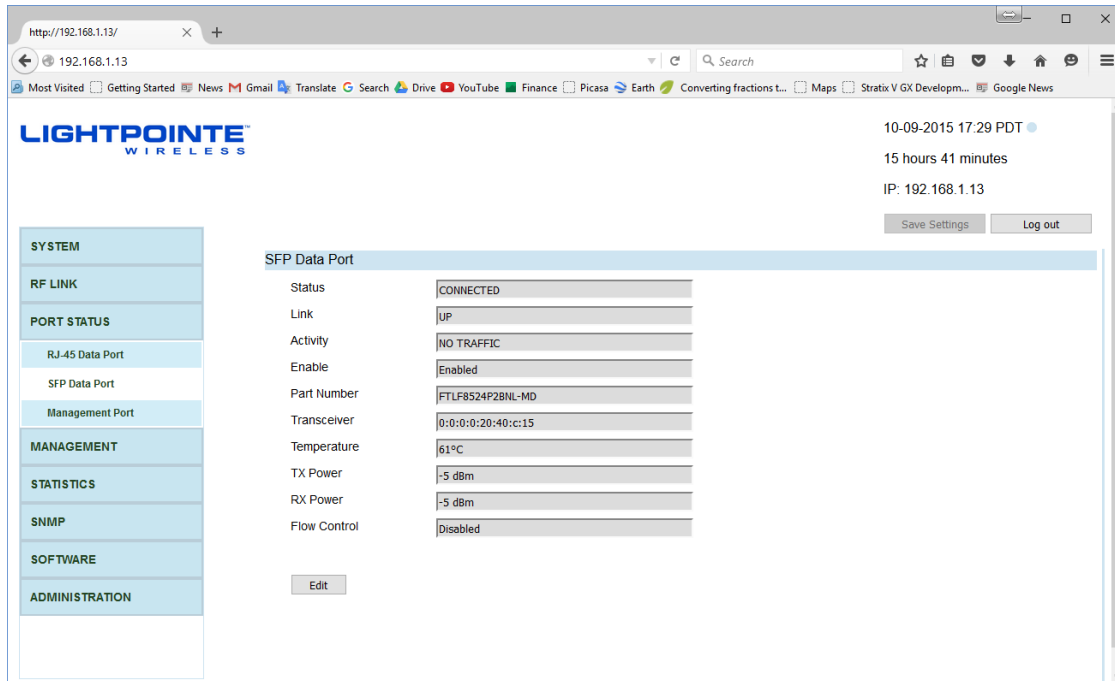

Figure 6-7: Port Status View (SFP Data Port)

SFP DATA PORT

- Status** Displays Link Status → Connected / Disconnected
- Link** Displays Link Status → UP/DOWN
- Activity** Displays Link Activity → Traffic / No Traffic
- Enable** Port Status → ENABLED / DISABLED
- Part Number** Displays SFP Part Number
- Transceiver** Displays SFP Transceiver Information
- Temperature** Shows SFP Temperature
- TX Power** Displays SFP TX Transmission Power
- RX Power** Displays SFP RX Receive Power Level
- Flow Control** Control Flow → ENABLED/DISABLED

Management Port:

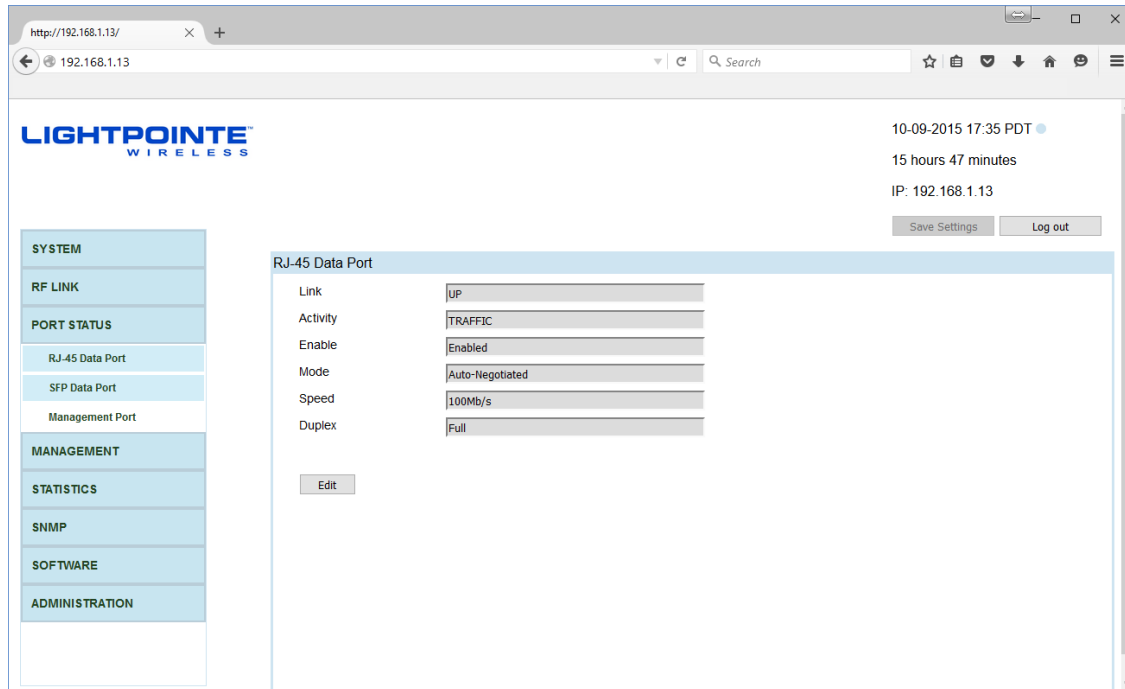

Figure 6-8: Port Status View (RJ45 Management Port)

RJ45 MANAGEMENT PORT

- Link** Displays Link Status → UP/DOWN
- Activity** Displays Link Activity → Traffic / No Traffic
- Enable** Port Status → ENABLED / DISABLED
- Mode** Negotiation → MANUAL / AUTO-NEGOTIATED
- Speed** Throughput Configuration → 100 Mbps / 1000 Mbps
- Duplex** Duple Mode → HALF / FULL

6.5 MANAGEMENT VIEW

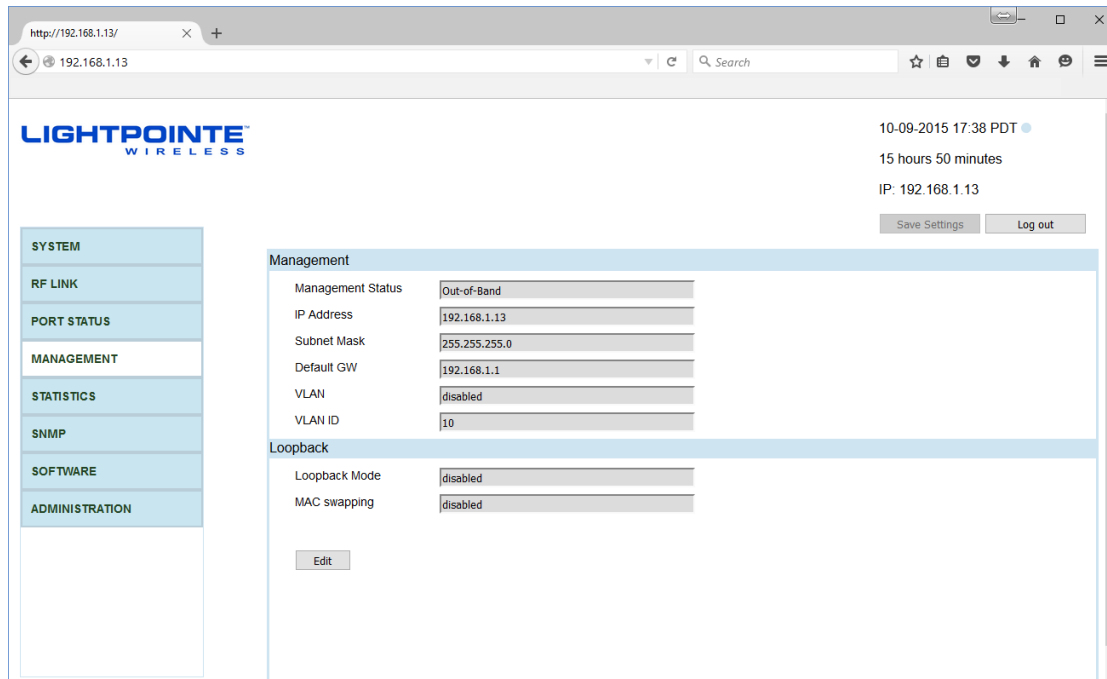

Figure 6-9: Management View Screen

MANAGEMENT

Management Status

Displays Management Status

IP Address

System IP Address

Subnet Mask

System SUBNET Mask

Default GW

Default GW Address

VLAN

VLAN Setting → ENABLED / DISABLED

VLAN ID

VLAN ID Setting

LOOPBACK

Loopback Mode

Loopback Mode → Disabled (default), Local Loopback, Remote Loopback

MAC Swapping

Swap packet source and destination address → Disabled (default), Enabled

6.6 PERFORMANCE VIEW

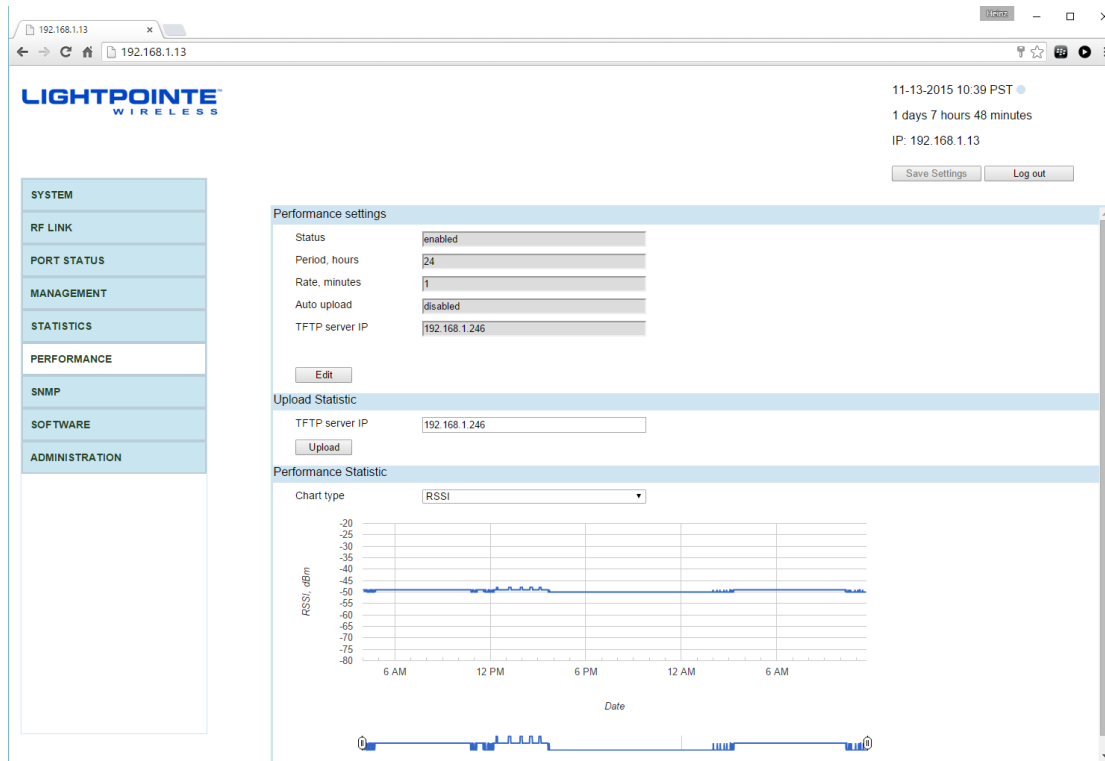

Figure 6-10: Performance View Screen

PERFORMANCE

Displays Performance settings parameters

Performance Settings

Status

Enable/disable performance parameter recording

Period, hours

Recording Interval length in hours (max. 72 hours when set to 1 minute rate, or max. 4320 recordings/file)

Rate, minutes

Recording rate in minutes (minimum 1 minute)

Auto Upload

Enable/disable automatic upload of recorded values to network storage via TFTP server

TFTP Server IP

IP address of TFTP server assigned to receive uploaded performance records

Upload

TFTP server IP

IP address of TFTP server assigned to receive uploaded performance records

Upload

Manually upload recorded parameters (automatic overwrite after 4320 records have been taken)

Performance Statistic

Chart Type

Display options None, RSSI, MCS (Scaling via slider, left/right mouse button, and mouse track wheel (if available))

6.7 STATISTICS VIEW

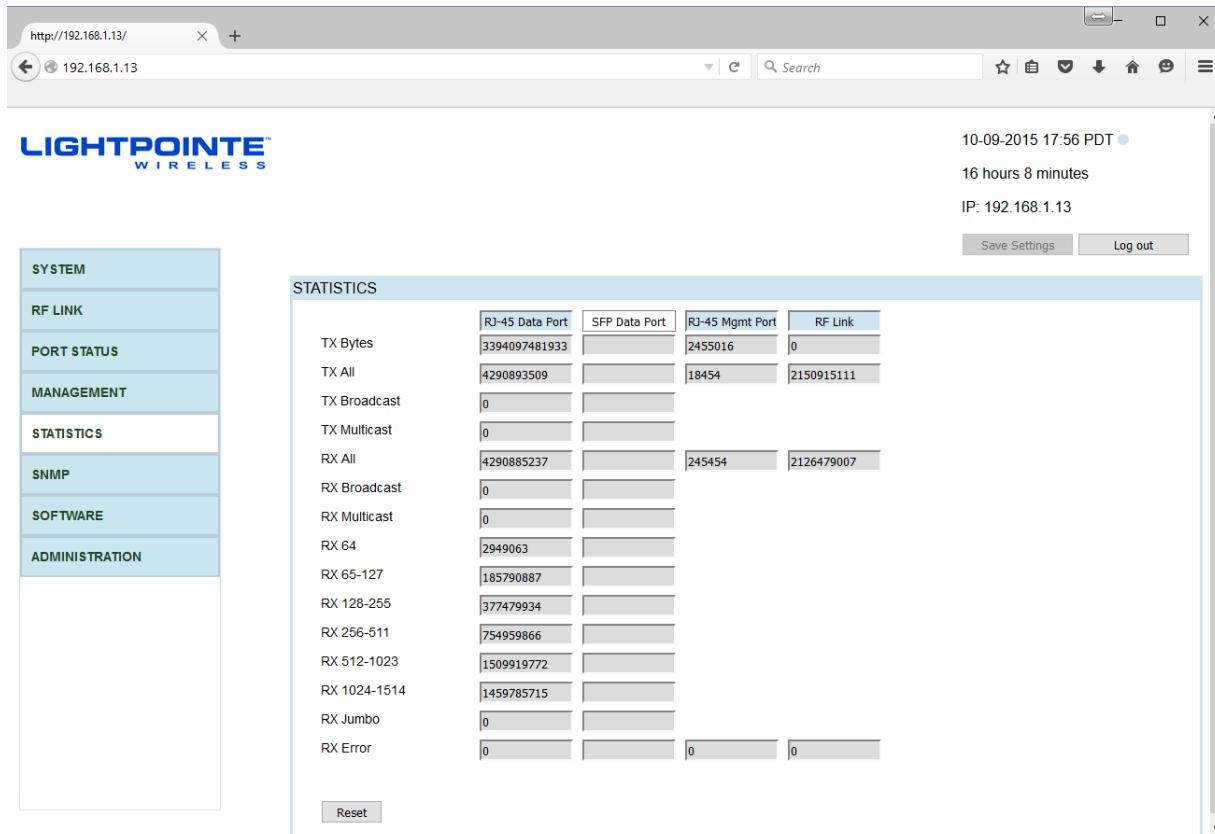

Figure 6-11: Statistics View Screen

STATISTICS

RMON COUNTER

RJ-45 Data Port / SFP Data Port / RJ-45 Mgmt Port / RF Link

Use "RESET" button to clear RMON counters

6.8 SNMP VIEW

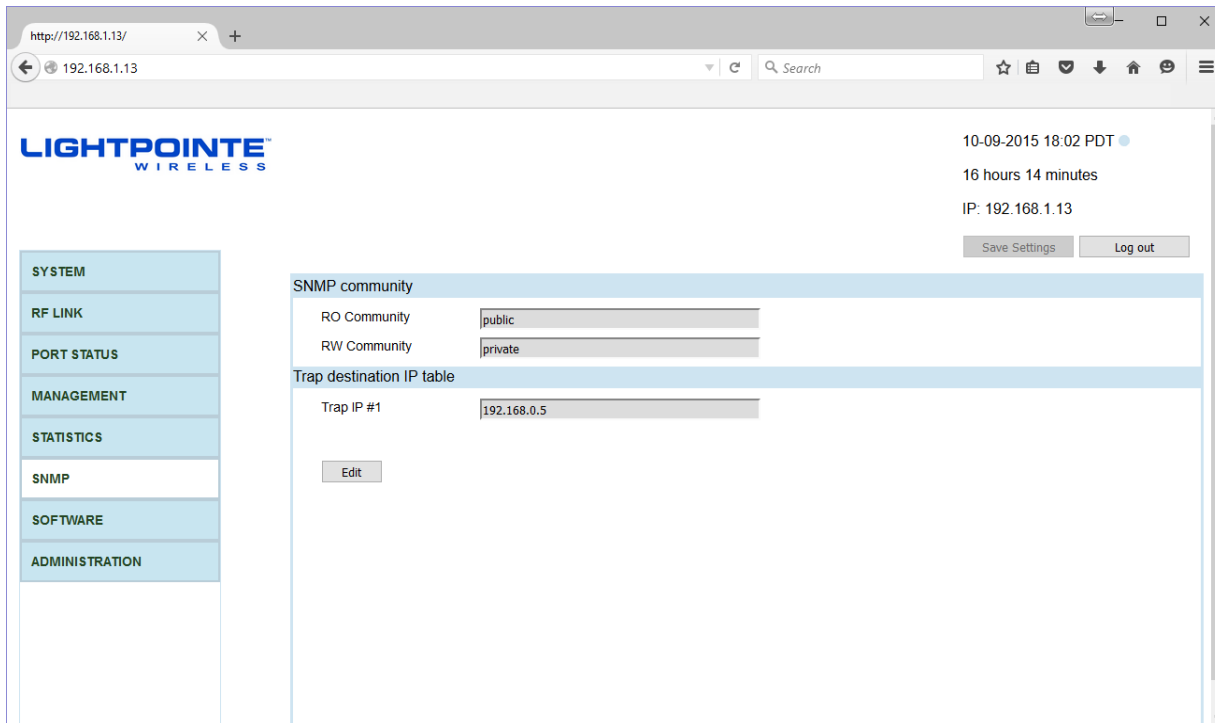

Figure 6-12: SNMP View Screen

SNMP COMMUNITY

RO Community

Displays and allows setting the **GET COMMUNITY** String

RW Community

Displays and allows setting the **SET COMMUNITY** String

TRAP DESTINATION IP TABLE

Displays and allows setting/deleting **IP TRAP** Addresses

6.9 SOFTWARE VIEW

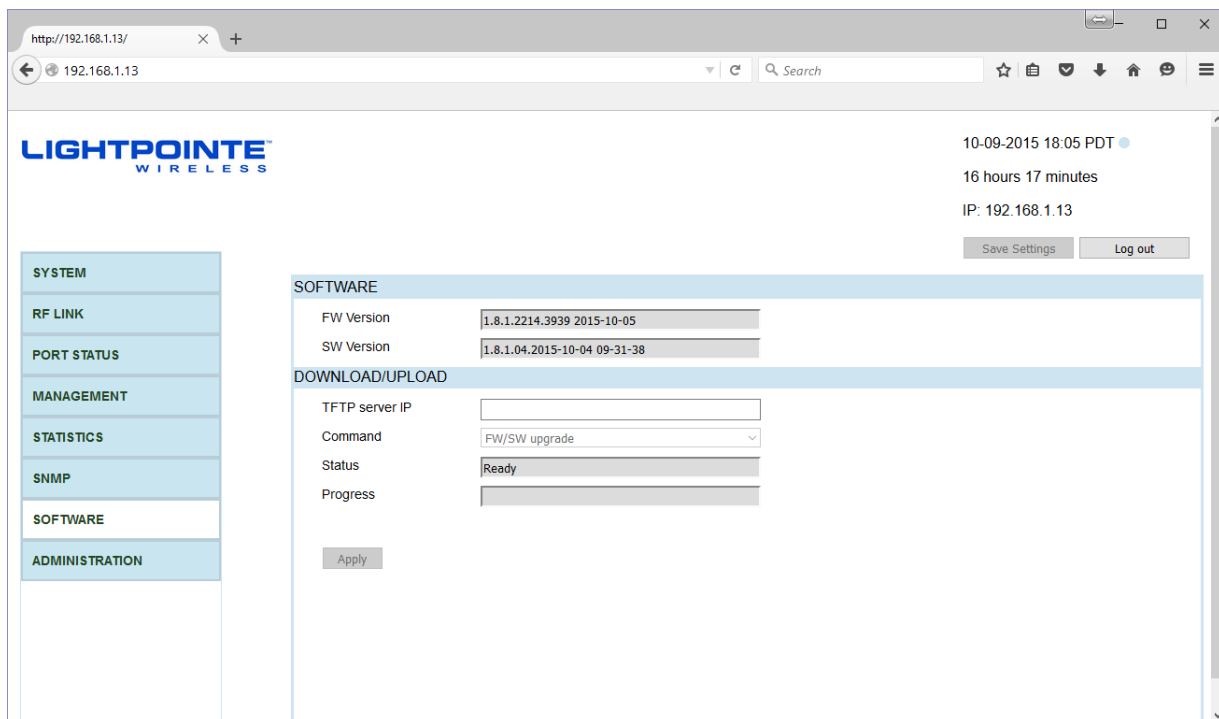

Figure 6-13: Software View Screen

SOFTWARE

FW Version

Displays Installed Firmware Version

SW Version

Displays Installed Software Version

DOWNLOAD/UPLOAD

TFTP server IP

Displays and Allows to Set the TFTP Server Address

Command

Allows to upgrade either FW or SW (currently combined upgrade only)

Status

Reports status of upgrade process

Progress

Reports progress on upgrade process

6.10 ADMINISTRATION

Figure 6-14: Administration View Screen

SYSTEM REBOOT

Reboot Reboots system

SYSTEM DATE AND TIME

NTP Server Enter NTP server IP address

NTP synchronization Enable/disable NTP synchronization

Time zone Select your local time zone

CHANGE PASSWORD

User Name Shows user name (currently *admin* access only)

New Password Allows to enter new password

Confirm New Password New password confirmation

AES ENCRYPTION **ONLY available when encryption module is installed**

AES Encryption Enable/disable encryption

New Encryption Key Enter encryption key (256 bit key, enter 64 hex characters 0...9, a...f)

Bluetooth

Bluetooth Enable/disable Bluetooth operation

New Password Change/enter new Bluetooth password (default: 0000)

Confirm New Password Confirm new password

7 CLI -- COMMAND LINE INTERFACE

The CLI interface has a Cisco-like command line interface with two modes of access levels:

- User configuration → **show** command
- Global configuration → **configure** command

In addition there are there are misc. command line instructions like **ping**, **copy**, and **upgrade tftp**.

To access the AireLink™ CLI interface please open the Windows command prompt and type >telnet IP_address, e.g. telnet 192.168.1.10 (default setting)

The AireLink™ CLI access is protected from unauthorized access by login/password protection.

Default login/password is "admin".

After successful login the **AireLink 60>** command prompt is displayed (see below).

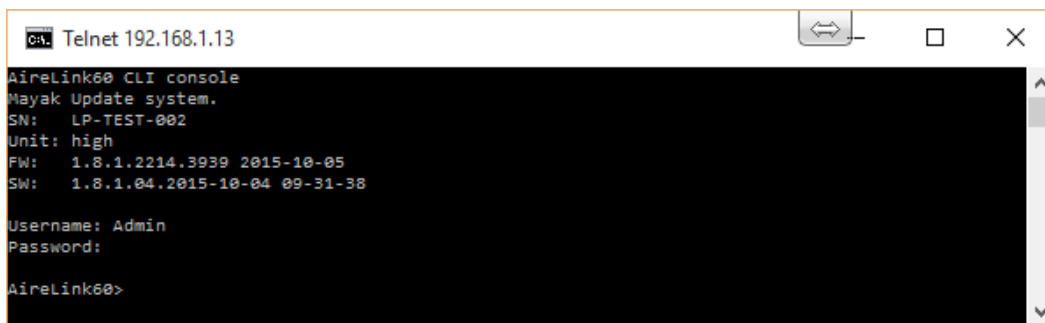

```

CA. Telnet 192.168.1.13
AireLink60 CLI console
Mayak Update system.
SN: LP-TEST-002
Unit: high
FW: 1.8.1.2214.3939 2015-10-05
SW: 1.8.1.04.2015-10-04 09-31-38

Username: Admin
Password:

AireLink60>

```

The user mode contains a limited number of basic commands to display the device status. To view the available commands, please type **?** (See below).

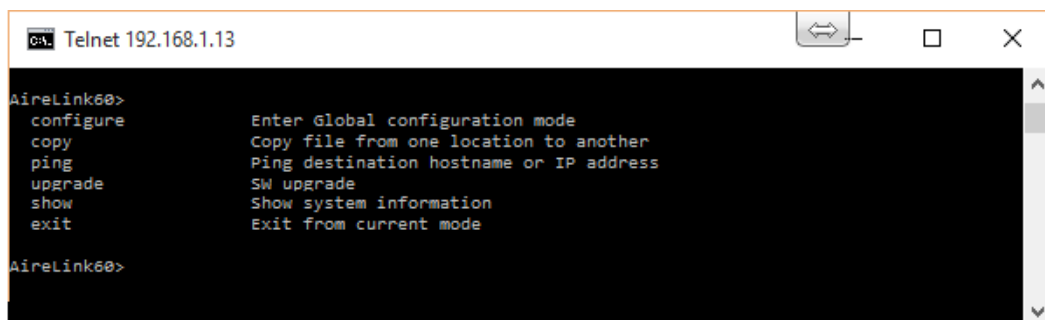

```

CA. Telnet 192.168.1.13
AireLink60>
configure      Enter Global configuration mode
copy           Copy file from one location to another
ping           Ping destination hostname or IP address
upgrade        SW upgrade
show           Show system information
exit           Exit from current mode

AireLink60>

```

While the user mode displays system parameters, the configure mode is used to change system settings. After typing **configure** the command prompt will change to **AireLink 60(config)#** (see below). To return to the previous mode, please type **exit**. Typing the **exit** command from the user mode command prompt will terminate the CLI session.

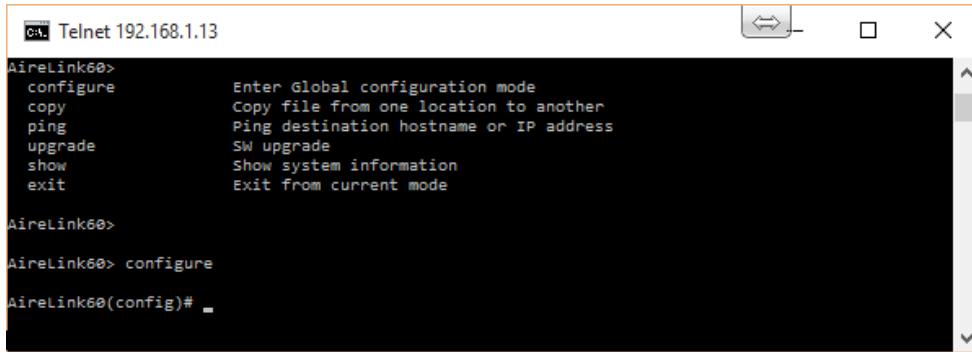

```

c:\ Telnet 192.168.1.13
AireLink60>
configure      Enter Global configuration mode
copy           Copy file from one location to another
ping          Ping destination hostname or IP address
upgrade       SW upgrade
show          Show system information
exit          Exit from current mode

AireLink60>
AireLink60> configure
AireLink60(config)#

```

7.1 USER MODE COMMANDS

Command: ?

Description: Show all commands available in the user mode in alphabetical order

Example: airelink60>?

User mode commands:

show Show system information

configure Enter global configuration mode

Notes: See each command for the description message

7.2 CLI - SHOW COMMAND

Command: airelink60>show {?|flash|interface|performance|radio|snmp|system|versions|vlan}

```

?                Show available command options
flash
interface
performance
radio
snmp
system
versions
vlan

```

Description: Show system relevant parameters

7.2.1 Command Show Flash

Command: airelink60(config)#show flash

Description: Show hardware and software versions of system flash partitions

Example:

Flash Partition: Golden

FW version: 1.8.1.2213.3936 2015-09-17

SW version: 1.8.1.1710.2135 2015-09-17

Flash Partition: Update

FW version: 2.0.aes.2214.3939 2015-10-20

SW version: 2.0.aes.1710.2472 2015-11-17

7.2.2 Command Show Interface

Command: airelink60(config)#show interface

Description: Show status of networking interfaces

Example: airelink60(config)#show interface

data interface

flow control: enabled

type of connection: SerDes (Fiber) media

Data interface eth0:

power: up

link status: up

SFP module part number: FTLF8524P2BNL-MD

SFP module part number (hex): 46 54 4c 46 38 35 32 34 50 32 42 4e 4c 2d 4d 44 0

module status: connected

SFP module transceiver ID: 0:0:0:0:20:40:c:15

SFP module temperature: 60 C

SFP module TX power: -5 dBm

SFP module RX power: -5 dBm

management interface

Speed: 100Mb/s

Duplex: Full

Auto-negotiation: on

Link detected: yes

MAC address: 00:0A:35:00:00:02

IP address: 192.168.1.11

Mask: 255.255.255.0

Gateway: 192.168.1.1

7.2.3 Command Show Performance

Command: airelink60>show performance {?|log|settings}

Description: Copy file from one location to another. First field in the command is the “copy from” option. Second field in the command is the “copy to” option.

| | |
|----------|--------------------------------|
| ? | Show available command options |
| log | Show performance data log |
| settings | Show performance data settings |

Example: airelink60> show performance settings

7.2.4 Command Show Radio

Command: airelink60(config)#show radio {?}

Description: Show detailed radio settings

Example: airelink60(config)#show radio

```
Running system partition: Update
FW version: 2.0.aes.2214.3939 2015-10-20
SW version: 2.0.aes.1710.2472 2015-11-17
Modem Board Serial Number: mayak_b_01-03-modem
Radio Board Serial Number: mayak_b_01_03-radio
```

```
Unit: low
TX band: 59.5 GHz
RX band: 62.5 GHz
Radio TX power: +8 dBm
Rfic pll status:
  TX: locked
  RX: locked
Alignment mode status: off
Modulation: 16QAM 5/8 (9)
Radio acm status: on
Rssi: -53 dBm
Distance: standard
RF is synced
Radio loopback mode: off
Radio loopback mac-swap: off
```

7.2.5 Command Show SNMP

Command: airelink60(config)#show snmp {?}

Description: Show SNMP settings

Example: airelink60(config)#show snmp

Read-only community string: public
Read-write community string: private
trap table:
1: 192.168.1.5

7.2.6 Command Show System

Command: airelink60(config)#show system {?}

Description: Show SNMP settings

Example: airelink60(config)#show system

Name: AireLink60
Unit: low
Contact: default_contact
Location: default_location_11

Unit Serial Number: 0000000001
Modem Board Serial Number: mayak_b_01-03-modem
Radio Board Serial Number: mayak_b_01_03-radio

Running system partition: Update
FW version: 2.0.aes.2214.3939 2015-10-20
SW version: 2.0.aes.1710.2472 2015-11-17

Temperature: 52 C

NTP server IP: 132.163.4.101
NTP synchronization: enabled

AES encryption:
system status: enabled and ready

7.2.7 Command Show Versions

Command: airelink60(config)#show versions {?}

Description: Show hardware and software version settings

Example: airelink60(config)#show version

Unit Serial Number: 0000000001

Modem Board Serial Number: mayak_b_01-03-modem

Radio Board Serial Number: mayak_b_01_03-radio

Running system partition: Update

FW version: 2.0.aes.2214.3939 2015-10-20

SW version: 2.0.aes.1710.2472 2015-11-17

7.2.8 Command Show VLAN

Command: airelink60(config)#show vlan {?}

Description: Show management VLAN settings

Example: airelink60(config)#show vlan

VLAN Settings eth0:

VLAN TX/RX: disabled

VLAN ID: 10

7.3 CLI --CONFIGURATION COMMANDS

Command: airelink60>configure {N/A}

Description: Enters Global configuration mode

Notes: After entering to the Global configuration mode the command prompt will change from airelink60> to airelink60 (config)#

Command:?

Description: Show all commands available in the global mode

Example: airelink60(config)#?

```

CA Telnet 192.168.1.11
AireLink60> configure
AireLink60(config)#
  interface      Enter specific network interface configuration mode
  password       Set CLI and WebUI passwords
  performance    Performance statistic
  radio          Set radio parameters
  snmp           Set SNMP parameters
  system         Set system information
  reboot         Reboot the system
  exit           Exit from current mode
AireLink60(config)#

```

Note: See each command for the description message

7.3.1 Interface Commands

Command: airelink60(config)# interface {data|management}

Description: Configure data and management ports

| | |
|------------|--|
| ? | Show available command options |
| management | Enter Management port configuration mode |
| data | Enter Data port configuration mode |

Example: airelink60(config)# interface data ?

7.3.1.1 Interface data commands

Command: airelink60(config)# interface data shutdown {?|enable|disable}

Description: Set network data interface operational status

| | |
|---------|--------------------------------|
| ? | Show available command options |
| enable | Enable interface shutdown |
| disable | Disable interface shutdown |

Example: airelink60(config)# interface data shutdown enable

Command: airelink60(config)# interface data autonegotiation {?|enable|disable}

Description: Set network data interface auto-negotiation status

| | |
|---------|--------------------------------|
| ? | Show available command options |
| enable | Enable autonegotiation |
| disable | Disable autonegotiation |

Example: airelink60(config)# interface data autonegotiation enable

Command: airelink60(config)# interface data speed {?|10|100|1000}

Description: Set network data interface Ethernet speed

| | |
|------|--------------------------------|
| ? | Show available command options |
| 10 | Set speed to 10 Mbit/s |
| 100 | Set speed to 100 Mbit/s |
| 1000 | Set speed to 1000 Mbit/s |

Example: airelink60(config)# interface data speed 1000

Command: airelink60(config)# interface data duplex {?|full|half}

Description: Set data network interface duplex status

| | |
|------|--------------------------------|
| ? | Show available command options |
| full | Set full duplex |
| half | Set half duplex |

Example: airelink60(config)# interface data duplex full

Command: airelink60(config)# interface data flowcontrol {?|enable|disable}

Description: Set network data interface control flow status

| | |
|---------|--------------------------------|
| ? | Show available command options |
| enable | Enable flow control |
| disable | Disable flow control |

Example: airelink60(config)# interface data flowcontrol enable

7.3.1.2 Interface management commands

Command: airelink60(config)# interface management duplex {?|full|half}

Description: Set network management interface duplex mode

| | |
|------|--------------------------------|
| ? | Show available command options |
| full | Set full duplex |
| half | Set half duplex |

Example: airelink60 (config)# interface management duplex full

Command: airelink60(config)# interface management speed {?|10|100|1000}

Description: Set network management interface Ethernet speed

| | |
|------|--------------------------------|
| ? | Show available command options |
| 100 | Set speed to 100 Mbit/s |
| 1000 | Set speed to 1000 Mbit/s |

Example: airelink60(config)# interface management speed 1000

Command: airelink60(config)# interface management shutdown {?|enable|disable}

Description: Set network management interface port status

| | |
|---------|--------------------------------|
| ? | Show available command options |
| enable | Enable interface shutdown |
| disable | Disable interface shutdown |

Example: airelink60(config)# interface management shutdown enable

Command: airelink60(config)# interface management vlan {?|enable|disable|id vlan_id}

Description: Set network management interface VLAN

| | |
|------------|--------------------------------|
| ? | Show available command options |
| enable | Enable VLAN |
| disable | Disable VLAN |
| id vlan_id | Set port VLAN ID |

Example: airelink60(config)# interface management vlan enable

Command: airelink60(config)# interface management ip {?|IP ip_address}

Description: Set management interface IP address

| | |
|----|--------------------------------|
| ? | Show available command options |
| ip | Set management IP address |

Example: airelink60(config)# interface management ip 192.168.1.11

Command: airelink60(config)# interface management netmask {?|netmask *netmask*}

Description: Set management interface netmask

| | |
|---------|--------------------------------|
| ? | Show available command options |
| netmask | Set management port IP netmask |

Example: airelink60(config)# interface management netmask 255.255.255.0

Command: airelink60(config)# interface management gateway {?|gateway *ip_address*}

Description: Set management interface gateway IP address

| | |
|---------|--------------------------------|
| ? | Show available command options |
| gateway | Set gateway IP address |

Example: airelink60(config)# interface management gateway 192.1168.1.1

7.3.2 Password Command

Command: airelink60(config)# password {?|cli/web}

Description: Set cli/web password

| | |
|---------|--------------------------------|
| ? | Show available command options |
| cli/web | Set CLI/web password |

Example: airelink60(config)# password cli → enter password at command prompt)

7.3.3 Performance Commands

Command: airelink60(config)# performance {?|enable|disable|frequency|period|server_ip|tftp|upload}

Description: Set performance data recording parameters.

| | |
|-----------|--|
| enable | Enable performance data collection |
| disable | Disable performance data collection |
| frequency | Set frequency of performance data collection (minutes) |
| period | Set period of performance data collection (hours) |
| server_ip | Set TFTP server IP address for uploading performance data |
| tftp | Automatic upload performance data to specified TFTP server |
| upload | Manually upload performance data to specified TFTP server |

Examples: airelink60(config)# performance enable

airelink60(config)# performance frequency 1

7.3.4 Radio Commands

Command:

```
airelink60(config)#radio {?|acm [enable|disable]|modulation modulation_idx|statistics reset|align [enable|disable]|
tx_band tx_band_freqrx_band rx_band_freqtx_power tx_power_value}
```

Description: Set radio parameters

| | |
|-------------------------|--|
| <i>N/A</i> | Show radio status information |
| <i>?</i> | Show available command options |
| <i>acm</i> | Configure ACM radio settings |
| <i>align</i> | Configure radio alignment mode |
| <i>distance</i> | Set power settings for different distances |
| <i>loopback</i> | Configure modem loopback settings |
| <i>modulation</i> | Set modulation scheme |
| <i>rssi_alarm_thr</i> | Set RSSI alarm threshold |
| <i>rssi_alarm_clear</i> | Set RSSI alarm clear threshold |
| <i>rx_band</i> | Show available command options |
| <i>statistics reset</i> | Reset radio packet counters |
| <i>tx_band</i> | Show available command options |

Command: airelink60(config)# radio acm {?|enable|disable}

Description: Set Automatic Coding and Modulation (MCS) Mode

| | |
|----------------|--|
| <i>?</i> | Show available command options |
| enable | Enable Automatic Coding and Modulation (MCS) Mode |
| disable | Disable Automatic Coding and Modulation (MCS) Mode |

Example: airelink60(config)# radio acm enable

Command: airelink60(config)# radio align {?|enable|disable}

Description: Set radio alignment mode status

| | |
|----------------|--------------------------------|
| <i>?</i> | Show available command options |
| enable | Enable radio alignment mode |
| disable | Disable radio alignment mode |

Example: airelink60(config)# radio align enable

Command: airelink60(config)# radio distance {?|standard|short|veryshort}

Description: Set radio deployment distance

| | |
|------------------|---|
| ? | Show available command options |
| standard | Set power setting for standard distance (default) |
| short | Set power setting for short distance |
| veryshort | Set power setting for very short distance |

Example: airelink60(config)# radio distance short

Command: airelink60(config)# radio loopback {?|mode|mac-swap|timeout}

Description: Sets radio loopback mode

| | |
|-----------------|--|
| ? | Show available command options |
| mode | Set modem loopback mode |
| mac-swap | Set modem loopback mode and swap the MAC address |
| timeout | Set modem loopback timeout/reset in x seconds |

Example: airelink60(config)# radio loopback mac-swap

Command: airelink60(config)# radio modulation {?|0|1|...|9}

Description: Sets radio modulation scheme according to MCS values

| | |
|----------|--|
| ? | Show available command options |
| # | 0 - BPSK 1/2 ; 1 - BPSK 5/8 ; 2 - BPSK 3/4 3 - BPSK 13/16 ; 4 - QPSK 1/2 ; 5 - QPSK 5/8 6 - QPSK 3/4 ; 7 - QPSK 13/16 ; 8 - 16QAM 1/2 9 - 16QAM 5/8 |

Example: airelink60(config)# radio modulation 9

Command: airelink60(config)# radio rssi_alarm_thr {?|value in dBm}

Description: Sets radio RSSI alarm threshold in dBm

Example: airelink60(config)# radio rssi_alarm_thr -60

Command: airelink60(config)# radio rssi_alarm_clear {?|value in dBm}

Description: Sets radio RSSI alarm clear threshold in dBm

Example: airelink60(config)# radio rssi_alarm_thr -50

Command: airelink60(config)# radio rx_band {?|59.0|59.5|60|62.0|62.5|63.0}

Description: Sets radio receive band for low band unit {**59.0|59.5|60**} and high band unit {**62.0|62.5|63.0**}

Example: airelink60(config)# radio rx_band 59.0

Command: airelink60(config)# radio tx_band {?|59.0|59.5|60|62.0|62.5|63.0}

Description: Sets radio transmission band for low band unit {**59.0|59.5|60**} and high band unit {**62.0|62.5|63.0**}

Example: airelink60(config)# radio tx_band 62.0

Command: airelink60(config)# radio statistics reset {?}

Description: Resets the RMON counters

Example: airelink60(config)# radio statistics reset

7.3.5 SNMP Commands

Command:

```
airelink60(config)#snmp {?|community ro get_community_string |community rw
set_community_string|trap-table [add ip_address|delete ip_address]}
```

Description: Show system status information

| | |
|-------------------|---|
| ? | Show available command options |
| Community ro | Set SNMP get community |
| Community rw | Set SNMP set community |
| trap-table add | Add SNMP trap destination IP address |
| trap-table delete | Delete SNMP trap destination IP address |

Example: airelink60(config)# snmp get-community public

7.3.6 System Commands

Command: airelink60(config)#system{?|aes}

Description: Enable/disable encryption and set encryption key

| | |
|---------|--|
| ? | Show available command options |
| enable | Enable AES encryption settings |
| disable | Disable AES encryption settings |
| key | Set AES 256 encryption key (64 hex characters 0...9,a...f) |

Example: airelink60(config)# system aes enable

Command: airelink60(config)#system{?|location system_location}

Description: Set system installation location

Example: airelink60(config)# system location *MyStreet*

Command: airelink60(config)#system{?|contact system_contact}

Description: Set system administrator contact information

Example: airelink60(config)# system contact *MyName*

Command: airelink60(config)#system{?|ntp}

Description: Enable/disable Internet Time Protocol and set Internet Time Server IP address

| | |
|---------|-------------------------------------|
| ? | Show available command options |
| enable | Enable Internet Time protocol |
| disable | Disable Internet Time protocol |
| server | Set Internet Time Server IP address |

Example: airelink60(config)# system ntp server 132.163.4.102

7.3.7 Reboot Command

Command: airelink60(config)# reboot

Description: Executing this command will reboot the system

Example: airelink60(config)# reboot

7.3.8 Exit Command

Command: airelink60(config)# exit

Description: Exit Configuration mode

7.4 CLI -- SAVE SESSION SETTINGS ON FLASH AND SOFTWARE UPGRADE

Command: airelink60>copy {?|running-config|startup-config|flash|tftp}

Description: Copy file from one location to another. First field in the command is the "copy from" option. Second field in the command is the "copy to" option.

| | |
|-----------------------|--|
| ? | Show available command options |
| | ? before the first field shows "Copy from" options |
| | ? after the first field shows "Copy to" options |
| | "Copy to/from" options are the same as shown below |
| <i>running-config</i> | Current system configuration |
| <i>startup-config</i> | Startup system configuration |

To save the changes in the system configuration that was done during the CLI session the following CLI command should be executed:

Example: airelink60> copy running-config startup-config

This will copy all the changes to the flash to preserve new settings after the reboot.

7.5 CLI -- PING COMMAND

Command: airelink60>ping {hostname|ip_address}

Description: Ping destination hostname or IP address

| | |
|------------|--------------------------------|
| ? | Show available command options |
| hostname | Ping destination hostname |
| ip_address | Ping destination IP address |

Example: airelink60> ping 192.168.1.115

7.6 CLI - Upgrade TFTP Command

Command: airelink60>upgrade {?|tftp IPserver address|status}

Description: Copy file from one location to another. First field in the command is the "copy from" option. Second field in the command is the "copy to" option.

| | |
|-----------------|--------------------------------|
| ? | Show available command options |
| tftp IP address | Upgrade TFTP server IP address |
| status | Upgrade status |

Example: airelink60> upgrade tftp 192.168.1.1

7.7 CLI - LOG COMMAND

Command: airelink60>log {?|tftp IPserver address}

Description:

| | |
|-----------------|---|
| ? | Show available command options |
| tftp IP address | Get LOG files from specifiedTFTP server |

Example: airelink60> log tftp 192.168.1.246Basic Management Port Network Setup

The following commands should be used to set management port network parameters. You should be in the Configuration Mode to set these settings.

Set IP address:**Example:** airelink60(config)# interface management ip 192.168.1.10

Note: When management port IP address is changed, the new setting will occur immediately. At that point one will need to connect to the CLI again using new IP address setting.

Set Network Mask address:**Example:** airelink60(config)# interface management netmask 255.255.255.0**Set Default Gateway:****Example:** airelink60(config)# interface management gateway 192.168.1.1



8 BLUETOOTH AIRELINK VIEWER

The AireLink 60 system is equipped with a Bluetooth transceiver fully compatible with latest low power BLUETOOTH SMART specification. When the system ships the Bluetooth connection is enabled by default and the over the air Bluetooth connection is encrypted and password protected to ensure the highest level of security. Initially use **default passcode 0000** to access the radio Bluetooth connection. Please, change the password after the initial installation is completed using the Bluetooth setting in the web browser *Administration* tab (see Chapter 6.10) The user can also enable/disable access to Bluetooth in the web browser *Administration* tab (see Chapter 6.10)

LightPointe provides an ANDROID app called *LightPointe BLE* to access the radio Bluetooth connection. The app can be downloaded for free from the Goggle Play store <https://play.google.com/store>. Running the application requires a Bluetooth capable based smart phone or tablet with Android KitKat (version 4.4) or higher installed. Installing the software will require to grant access to the smart phone/tablet Bluetooth connection.



After installation of the software is completed, please reboot/restart your Android phone/tablet to ensure proper operation of the application.

After installing and launching the application, a scan for an AireLink systems will start automatically. To establish a connection the line-of-sight distance between the phone and the AireLink system should not be more than 300 feet (100 meters). The distance will be less in case they is an obstruction (roof, tree, etc.) between the smart phone/tablet and the radio link head. After successful discovery, click the AireLink system you would like to connect to. When asked, please enter the default passcode 0000 to establish the connection.

The following pages show step-by-step instructions on how to install, launch and interact with the software.

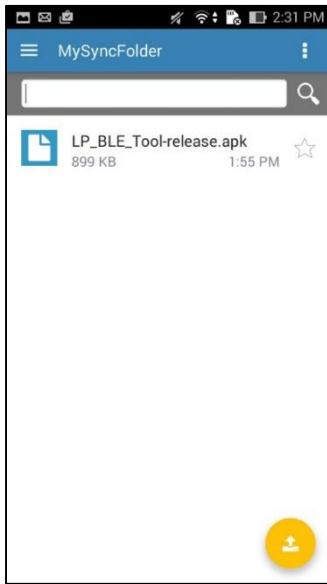

1. Download the application

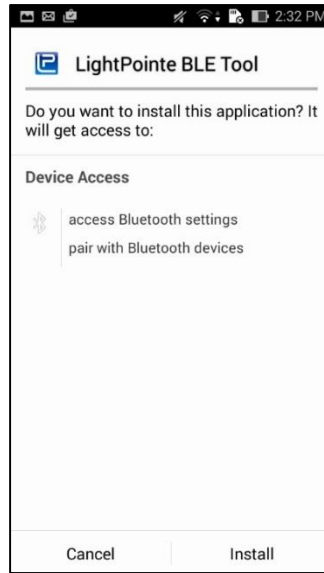

2. Click on *Install* button.

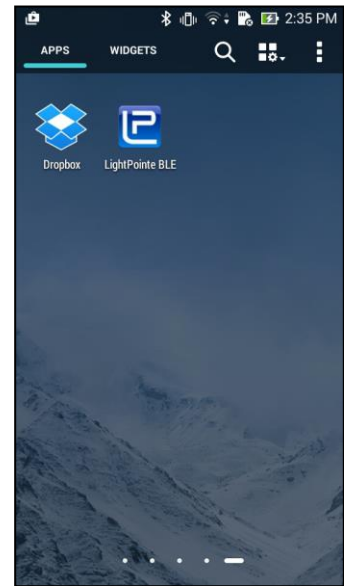

3. Open the BLE application



4. The application will scan for AireLink radios. Wait until the scanning finishes.

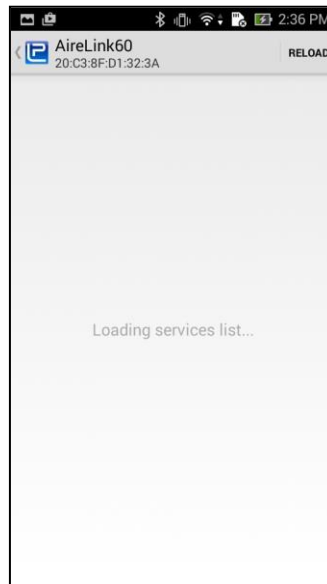

5. Click on the AireLink radio you would like to monitor. The Application will load services from the radio link.

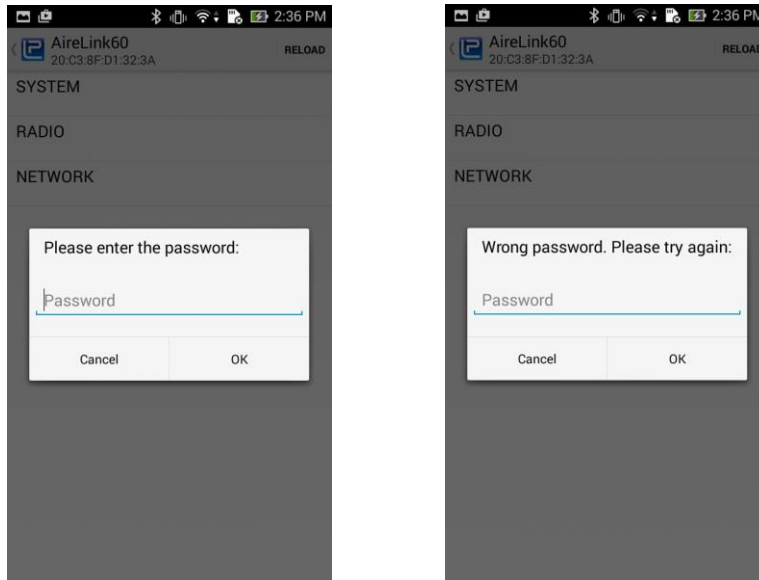

- After loading of services is completed, please enter default password **0000**. Re-enter the password in case of a typo. The password can be changed using the web browser Administrative tab.

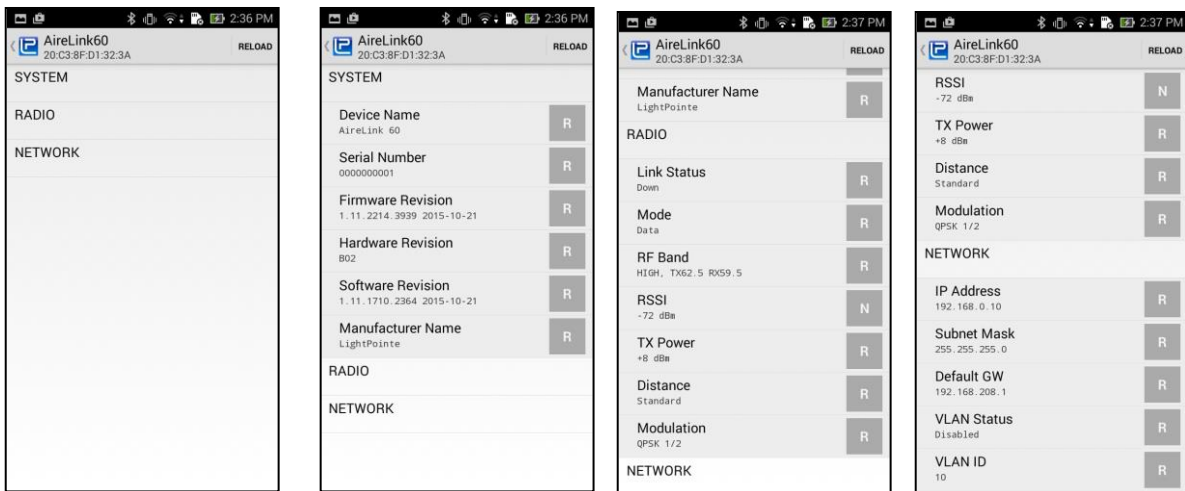

- After successful loading of the services the AireLink monitoring menu is displayed. There are three tabs:

- **SYSTEM**
- **RADIO**
- **NETWORK**

Click/tapping on one of the tabs will open the display of the radio parameters. Parameters listed with the designation **R** are read once during application launch. The RSSI values are read and updated continuously.



9 SNMP

9.1 BASICS

The AireLink™ system supports the Simple Network Management Protocol (SNMP), an Internet-standard protocol for managing devices on IP networks. The system supports SNMP v.1 & SNMP v.2c versions. In typical SNMP implementations, one or more administrative computers, called managers, have the task of monitoring or managing a group of hosts or devices such as the AireLink™ system on a computer network. Each managed system executes, at all times, a software component called an agent which reports information via SNMP to the manager. An agent is a network-management software module that resides on a managed device such as the AireLink™ system. The agent has local knowledge of management information and translates that information to or from an SNMP specific form. SNMP itself does not define which information/variables a managed system should offer. Rather, SNMP uses an extensible design, where the available information is defined by management information bases (MIBs). MIBs describe the structure of the management data of a device subsystem; they use a hierarchical namespace containing object identifiers (OID). Each OID identifies a variable that can be read or set via SNMP. For the SNMP system to function properly, the MIBs of monitored components must be compiled into an SNMP Management System such as NET-SNMP, HP OPENVIEW, SNMPC or similar commercially available programs. For illustrative purposes we are using the MG-SOFT Software

9.2 LightPointe MIB Files

LightPointe provides a MIB named **LPCOMM-MIB** to monitor the AireLink™ wireless point to point communication systems. The MIB must be compiled into the management system using the appropriate compiler function. After the MIB is compiled correctly, it must both show as part of the loaded MIB modules. See the example in Figure 9-1 below.

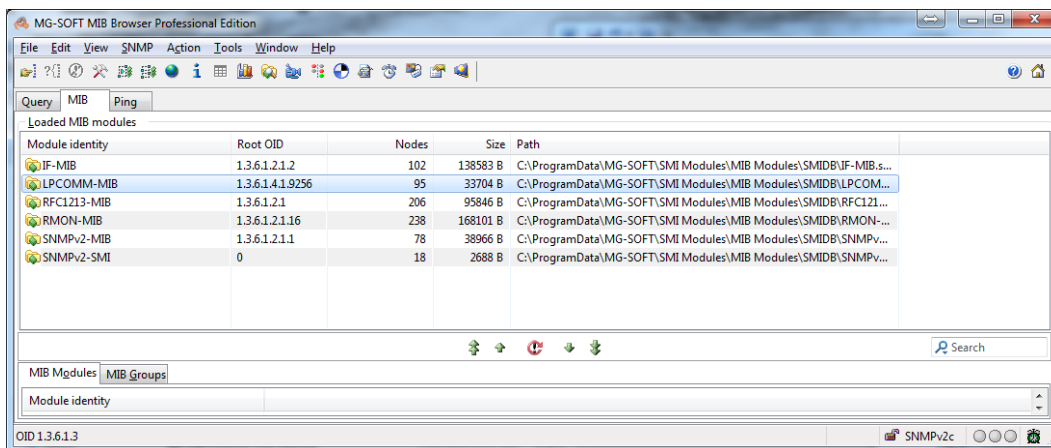

Figure 9-1: LightPointe MIB modules

9.3 LIGHTPOINTE MIB TREE

After successful compilation of the LightPointe Airelink™ MIB file the corresponding variables are shown under the following MIB tree structure:

iso/org/dod/internet/private/enterprises/lpcomm (see Figure 9-2)

The variables with a *i* in front of the variable name can be polled via SNMP command. Some variables are READ ONLY and others have a READ/WRITE status. Most SNMP programs allow highlighting a specific variable and open a property description window similar to the one shown in Figure 9-2 below. The MIB file is actually a readable ASCII Text file and the meaning of a specific variable is documented in the MIB file.

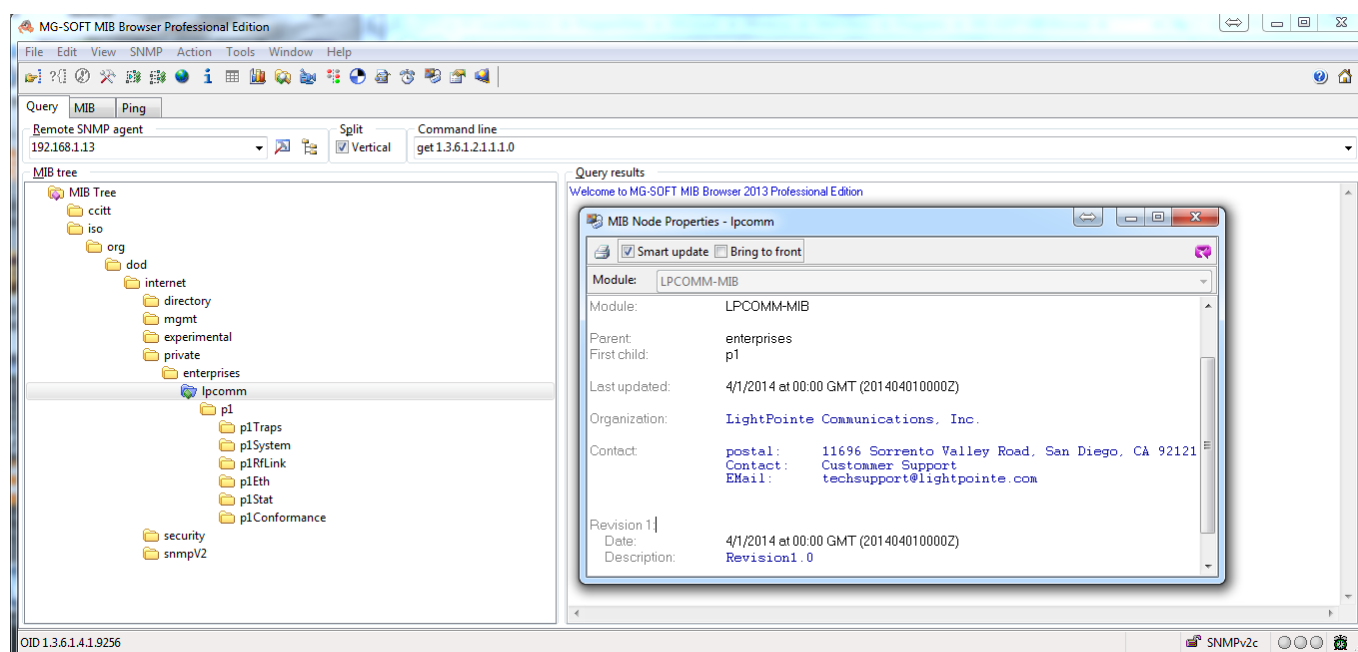

Figure 9-2: MIB tree iso/org/dod/internet/private/enterprises/lpcomm

A more detailed view of the MIB tree itself is shown in Figure 9-3. The variables are grouped according to functionality such as traps, RfLink, Ethernet interfaces, and statistics.

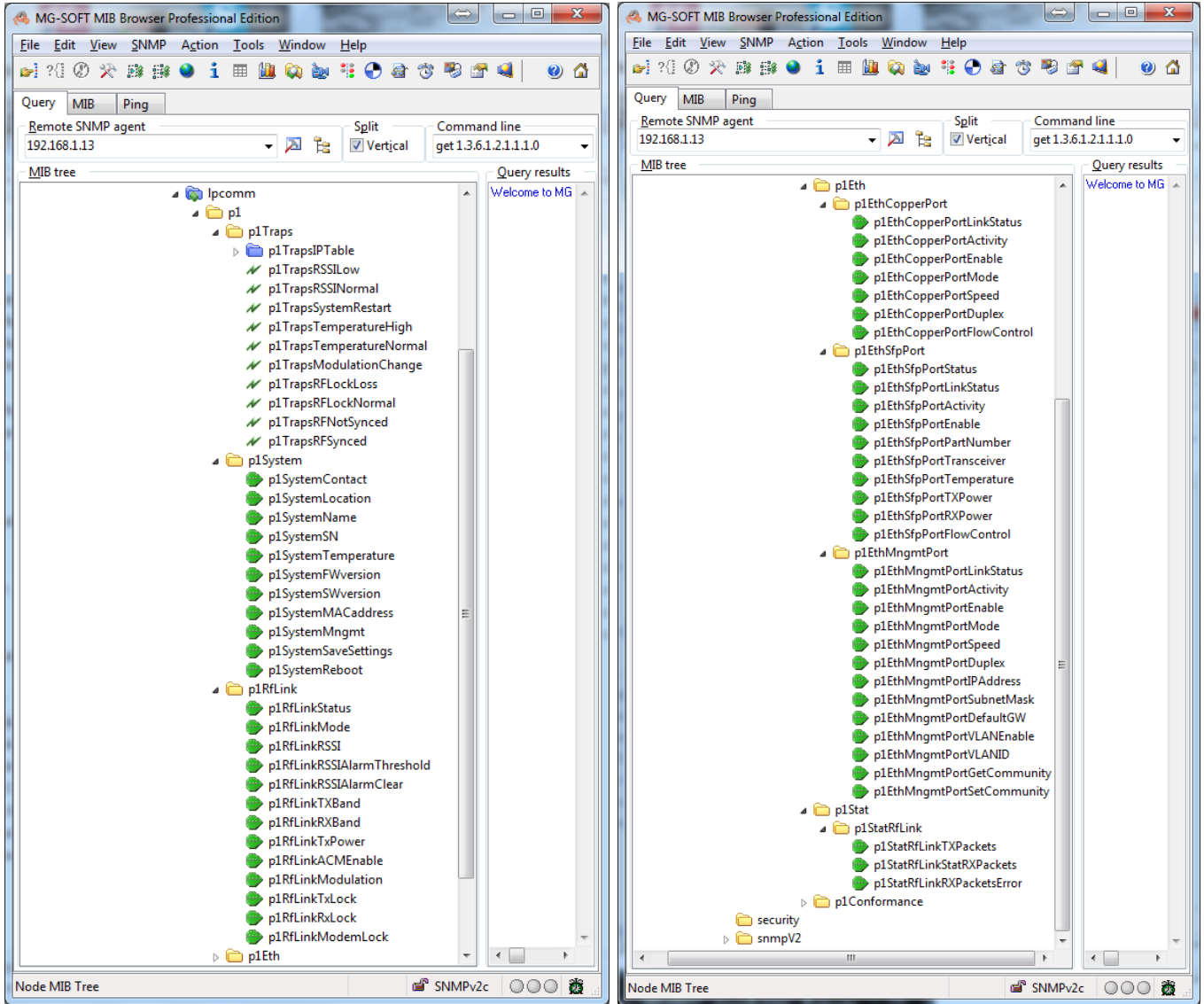

Figure 9-3: Detailed view of LPCOMM MIB tree

Most SNMP programs allow monitoring/polling specific variables over time and display the values graphically or write the values to a file. Such a performance graph can be very useful during troubleshooting. Figure 9-4 shows an illustration of RSSI values polled as a function of time.

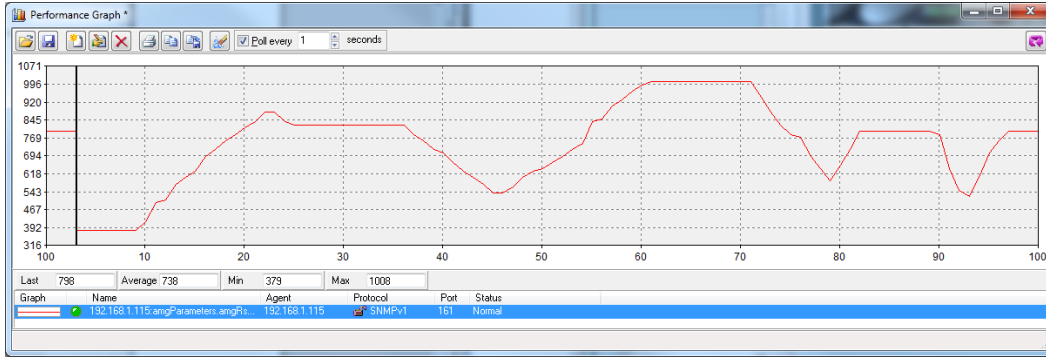

Figure 9-4: Performance Graph

9.4 SNMP TRAP MONITORING

An SNMP trap allows an element, such as the AireLink™ system, to contact network management when there is a significant event. This is done via unsolicited SNMP messages. For example, if the AireLink unit reaches a critical RSSILow threshold value, an SNMP trap will be sent to the computer with the message that the unit has reached the RSSILow value. When the RSSILow conditions resolves the monitoring computer will receive an RSSINormal message via a different trap message.

The system can send out 10 different traps and they are listed in the p1Traps folder under the Ipcomm MIB tree. Figure 9-5 below shows the location in the MIB tree. The meaning of then traps can easily be derived from the trap name like RSSILow or TemperatureHigh tap. The MIB file list more details regarding the traps.

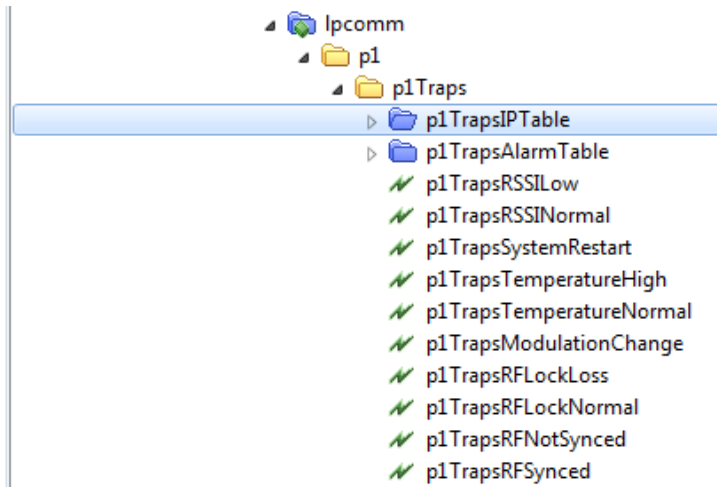

Figure 9-5: SNMP Traps



10 Troubleshooting and Diagnostics

This chapter provides helpful tips on troubleshooting the equipment and covers the following topics:

- **Types of Failure**
- **Fault isolation troubleshooting charts**
- **Additional troubleshooting methods**

The radio units provide a Layer 2 Ethernet connection between remote locations. If the radio units are correctly aligned and data is transmitted, the problem is usually outside the system.

10.1 FAILURE TYPES

Three different kinds of failures can affect system performance:

- **Failures caused by attached network components**
- **Failures caused by the environment**
- **System failure of one of the radio units**

The use of the AireLink™ Manager program is highly recommended during the troubleshooting process. Although the AireLink™ Manager is not needed to transmit information through the system, the program is an essential component in monitoring and managing the AireLink™ 60 system. For details please refer to Chapter 6 of this manual "LinkManager™ - Network Management Platform"

Troubleshooting Charts

The following troubleshooting charts are meant to guide the user through some simple failure analysis procedures. Following these procedures will greatly help to ease the troubleshooting process and many problems can be solved on short notice by the user of the equipment and consequently minimize the downtime of the system in case of a malfunction. Please use the following charts to locate the problem before contacting LightPointe or your Reseller.

Observation: Network connection cannot be established with the opposite radio or throughput is low. Received RSSI signal reading is "low" or RF signal status is "off"

| Problem | Cause | Action |
|---------------------|--|---|
| Power Source | The equipment power supply at the opposite side is switched off. | Turn power supply on. Check that the green Power LED on radio user panel is lit. |
| | Broken power supply | Replace power supply. Call LightPointe or reseller in case the power supply was part of the shipment. |
| System Setup | RF ON LED is off | Restart the system and call LightPointe or reseller in case the Led does not turn ON. |
| | RF SYNCH LED is off | In case the RF ON LED is ON/GREEN at both radios, realign system. See chapter 5 in this manual. |
| | System is misaligned. | Realign system. Use chart in Fig. 5-8 or Fig. 5-18 to find correct RSSI voltage reading. See chapter 5 in this manual. |
| | Distance between locations exceeds specific system distance specification. | System can still be used but throughput will be lower. |
| | Antenna is mounted incorrectly and the polarization is crossed. | Re-install the antenna and ensure that both antennas transmit at the same polarization. See chapter 5.3 in this manual. |
| Environment | High signal attenuation due to heavy rain | Wait until the rain stops and observe if this resolves the problem. |
| | Antenna covered with snow. | Remove snow from antenna. |

Table 10-1: Troubleshooting Chart I

Observation: 'SFP Port Status' reports "Link DOWN"

| Problem | Cause | Action |
|---|--|--|
| Optic Cables or Transceiver | TX and RX terminal connection error | Check fiber cables and ensure that transceivers are connected correctly. Check SFP Port status in LinkManager™. |
| | Optical transceiver standards do not match | Use the LinkManager™ and verify that the correct transceiver is installed. |
| | Dirt or dust or breakage of optical fiber | Clean fiber output or replace the cable with a new one. Use LinkManager™ software to verify correct optical receive power at ODU fiber port. |
| | Broken transceiver at the network premise equipment side | Replace transceiver |
| | Broken transceiver at the radio side | Call LightPointe or Reseller. |
| Premise Equipment Connection | The network premise equipment at the opposite side is turned off | Under SFP Port status in LinkManager™, check RX power entry. Check Power on premise equipment |
| | Network port of premise equipment is de-activated | Under SFP Port status in LinkManager™, check RX power entry. Activate network port |

Table 10-2: Troubleshooting Chart II



11 Advanced Troubleshooting Methods

11.1 Performing a PING Test

A ping test is not a particularly sophisticated networking test but it does provide the user with an easy method to check the connectivity of IP based network equipment. When performing a ping test between two laptops and without other network equipment in the circuit, the ping test provides valuable information about the performance of the radio transmission link itself. Other tests may involve additional network equipment and therefore complicate the issue, making it difficult to find the root cause of a potential problem. The following equipment and software are needed to perform a ping test:

- **Two laptops or PCs with Ethernet cards**
- **Two Ethernet cables with RJ45 connectors**

Additionally, if performing the test over radio fiber connection:

- **Two media converters**
 - Depending on SFP transceiver installed in radio units use either multimode 1000Base-SX (850 nm) or 1000Base-LX (1300 nm) media converter. In case of using an older laptop that does not have a 1250 Mbps RJ45 (Gigabit Ethernet) connection, a 100/1000 switched media converter will be required.
 - Four simplex (or two duplex) optical fiber patch cords with correct termination. The radio transceiver has a LC type connector and the other termination will depend on the termination of the media converter.

11.2 EQUIPMENT CONNECTION AND NETWORK SETTINGS

To perform a ping test directly connect the two laptops/PCs to the radio link heads using either Cat5E/6 cables or additionally with a media converter on each side, if connecting via fiber. It is important to know which port of the radio unit is active. For details please refer to the "LinkManager™ - Network Management Platform" in Chapter 6.. Ensure that the radio units are aligned and that all status indicators show that the system is physically connected.

Note

This ping test is based on using two computers. It is possible to do a ping test with just one laptop if the remote radio side is connected to network equipment (switch/router) with a known IP. However, by doing so it might be difficult to isolate a potential networking problem and draw a definitive conclusion.

11.3 STEP-BY-STEP INSTRUCTIONS TO PERFORM A PING TEST

| | |
|----------------|---|
| Step 1 | Locate the required equipment listed above. |
| Step 2 | On each side, attach an RJ-45 cable or optical fiber cables via SFP transceiver to the radio port labeled DATA PORT. Connect the opposite ends of the RJ-45 cable to a laptop or fiber cables to the TX/RX ports of the media converters. |
| Step 3 | Connect an Ethernet cable between the PC RJ45 network port and the media converter RJ45 port on each laptop/PC and complete the following setup instructions on each laptop. The exact procedure will depend on the actual Windows operating system installed but the procedure is basically the same for any Windows operating system. |
| Step 4 | From Windows click the Start button. |
| Step 5 | Click on Settings . |
| Step 6 | Click on Control Panel. |
| Step 7 | Click on the Network And Dial-Up Connector icon. |
| Step 8 | Click on Incoming Connection. |
| Step 9 | Click on the Network tab. |
| Step 10 | Double click on Internet Protocol TCP/IP . |
| Step 11 | Select the Specify TCP/IP Address radio button. |
| Step 12 | The local side should type 192.168.1.1 in the IP Address Box. The remote side should type 192.168.1.10 in the IP address box. The Subnet address will automatically generate. |
| Step 13 | Click the Okay button. |
| Step 14 | Exit all dialog boxes. |
| Step 15 | Click on the Start button. |
| Step 16 | Select Programs . |

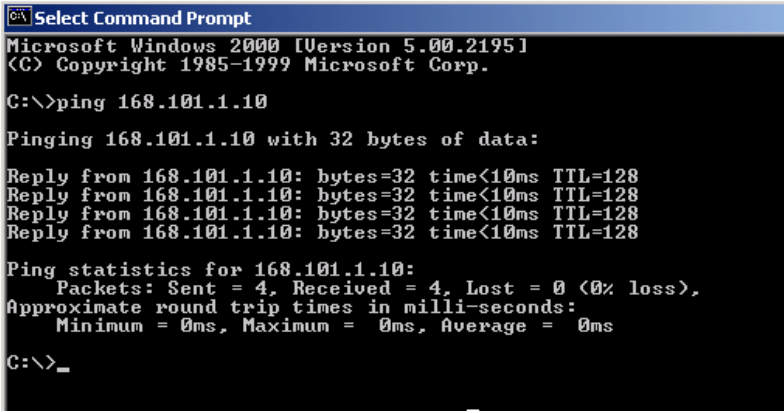
| | |
|----------------|---|
| Step 17 | Select the MS-DOS Prompt. |
| Step 18 | Type the word ping and the different ping command options will be displayed. |
| Step 19 | <p>To perform the ping test, the local laptop has to ping the IP address of the laptop and the other way around. From C:\> Type: ping -t 192.168.1.1 on the local laptop. The remote side laptop can ping by typing: ping -t 192.168.1.10.</p> <p>To stop the ping tests, type <Ctrl> C.</p> |
| Step 20 | <p>A successful ping will display the following information on the PC screen.</p>  <pre> Select Command Prompt Microsoft Windows 2000 [Version 5.00.2195] (C) Copyright 1985-1999 Microsoft Corp. C:\>ping 168.101.1.10 Pinging 168.101.1.10 with 32 bytes of data: Reply from 168.101.1.10: bytes=32 time<10ms TTL=128 Reply from 168.101.1.10: bytes=32 time<10ms TTL=128 Reply from 168.101.1.10: bytes=32 time<10ms TTL=128 Reply from 168.101.1.10: bytes=32 time<10ms TTL=128 Ping statistics for 168.101.1.10: Packets: Sent = 4, Received = 4, Lost = 0 (0% loss), Approximate round trip times in milli-seconds: Minimum = 0ms, Maximum = 0ms, Average = 0ms C:\>_ </pre> |
| Step 21 | Let the ping program run for several minutes and then type <Ctrl> C to stop the program. Take a look at the lost ping counter to verify that the system operates correctly. We using two laptops, no packet should be lost during the transmission. |

11.4 BER TESTING

Bit Error Rate (BER) testing is the most advanced way to check on the performance of a communication link. The radio transmission link operates as a transparent layer 2 Ethernet connection. The radio operates in full-duplex mode at real network throughput speed and extremely low latency of typically < 50 microseconds. Higher protocol layer performance is not determined by the radio but by the attached networking equipment. There are several vendors in the market that provide BER testing equipment. In case you are interested in performing a BER test and do not have a BER tester, please contact LightPointe for information on test equipment companies that lease a BER Tester



12 SPECIFICATIONS

| Parameter | AireLink™ 60 SX/MX/LX | | |
|---------------------------------|--|---------------------|---|
| Frequency of Operation | 59-63 GHz (Low Band: (59.0, 59.5, 60) GHz High Band: (62.0, 62.5, 63.0) GHz) | | |
| High/Low Channel Separation | > 60 dB | | |
| Transmission Power | +8 dBm (max.) | | |
| Throughput | 1000 Mbps, Full duplex | | |
| Modulation | BPSK/QPSK/16QAM, 9 Level Hitless Automatic Coding and Modulation (ACM) | | |
| Power Control | Adjustable Power settings for short distance deployments (minimum distance 25 m) | | |
| Supply Voltage | Power over Ethernet (802.3at) or Direct 48Vdc, Reverse Polarization Protection, Back-to-Back Power Redundancy | | |
| Power Consumption | 25 Watts max. | | |
| Network Interface | RJ-45 (100/1000 Base Tx) or MM/SM Fiber SFP (1000Base-SX/LX) | | |
| QoS/Protocol support | 802.3z (Gigabit Ethernet), Flow Control, Transparent Bridging(802.1d), VLAN support (802.1q), VLAN Stacking (802.1ad) | | |
| Frame size | Jumbo frames (up to 10K) | | |
| Encryption | Optional: Full duplex, line speed and real time AES 256 encryption | | |
| Terminal Latency | < 40 μ s + (distance in meters/300) μ s | | |
| Management & OS | AireLink web based Management Platform, Telnet Command Line Interface (CLI), SNMP v1/2c, RS232 Console port (micro USB connection), Loopback operation, On board Performance Data Collection with user selectable TFTP upload, NTP | | |
| Bluetooth | Secure Bluetooth SMART support for remote management via smart phone (Android) | | |
| Status Indicators | Networking port Status/Activity, RF ON, RF SYNC., ALIGN MODE, POWER | | |
| Signal Level Meter | External RSSI Voltage Connector | | |
| Operating Temperature | -30°C ... +60°C | | |
| Environmental / IP Rating | IP66 | | |
| Standard Compliance | USA: FCC Part 15; ETSI/CEPT: EN302-217-3 V1.3.1; EN302-217-4-2 V1.5.1; EN301-489, EN60950-1; EN61000-3; EN61000-4; ECC/REC(09)01 | | |
| Size (LxWxD) | (220x220x70)mm (enclosure w/o antenna and mounting bracket) | | |
| Model | SX | MX | LX |
| Weight (incl. mounting bracket) | 4 kg | 6.35 kg | 9.07 Kg |
| Antenna | Type | Lens (integrated) | Cassegrain (external) |
| | Size | 12 cm | 30 cm 60 cm |
| | Gain | 36dBi | 42 dBi 47 dBi |
| | Polarization | Horizontal/Vertical | Horizontal/vertical Horizontal/vertical |
| | Polarization Crosstalk | >35 dB | >35 dB >35 dB |
| | HPBW | 2.5° | 1.1° 0.6° |

13 TECHNICAL SUPPORT

Be sure to fill out the following checklist before calling your reseller or contacting LightPointe Technical Support.

| General Information | Your Installation |
|--|--|
| <input type="checkbox"/> Application (Fast Ethernet or GbE)? | |
| <input type="checkbox"/> Distance? | |
| <input type="checkbox"/> How long has system been in operation? | |
| How does the error show up? | |
| <input type="checkbox"/> Temporary/permanent error? | |
| <input type="checkbox"/> Is error observed for the first time? | |
| How was the weather when error showed up? | |
| <input type="checkbox"/> Weather conditions (rain, fog, snowfall) | |
| <input type="checkbox"/> Outside temperature | |
| Status of LEDs (on radio unit user panel) | |
| <input type="checkbox"/> Is the power LED on (green)? | Yes/No |
| <input type="checkbox"/> Is the RF ON LED on (green)? | Yes/No |
| <input type="checkbox"/> Is the RF SYNCH. LED on (green)? | Yes/no |
| <input type="checkbox"/> Do you see the network link/activity LED ON? | Yes/No |
| Status in AireLink™ Manager | |
| <input type="checkbox"/> AireLink™ Manager connection ok? | Yes/No |
| <input type="checkbox"/> What is the Link Status of the RF link? | Up/down |
| <input type="checkbox"/> Is RSSI power value displayed? | Yes/No If yes, what is the reading in dBm? |
| <input type="checkbox"/> What is the TX, RX and modem lock status? | |
| <input type="checkbox"/> Is temperature value displayed? | Yes/No If yes, what is the reading in °C? |
| <input type="checkbox"/> Can you see the RMON counter status? | Yes/No If yes, do you see any CRC errors? |
| What type of system is installed? | |
| <input type="checkbox"/> Integrated antenna or 1 or 2 foot ext. antenna? | |
| <input type="checkbox"/> Model number | |
| <input type="checkbox"/> Serial number | |

13.1 RETURN MATERIAL AUTHORIZATION (RMA) PROCEDURE

Please contact LightPointe before returning any system components for repair or replacement.

RMA products include:

- **Link head**
- **Standard power supply**

13.2 CONTACTING LIGHTPOINTE

Corporate Office

11696 Sorrento Valley Road, Suite #101
San Diego, CA 92121

Phone: +1 (858) 834-4083, Fax: +1 (858) 430-3458

Website: www.lightpointe.com

Email: techsupport@lightpointe.com

