

CLASSIC[®] 300D KUBOTA

For Machines with Code Numbers 11112, 11113, 11243, 11244, 11413, 11414, 11474, 11475

Safety Depends on You

Lincoln arc welding equipment is designed and built with safety in mind. However, your overall safety can be increased by proper installation ... and thoughtful operation on your part. **DO NOT INSTALL, OPERATE OR REPAIR THIS EQUIPMENT WITHOUT READING THIS MANUAL AND THE SAFETY PRECAUTIONS CONTAINED THROUGHOUT.** And, most importantly, think before you act and be careful.



OPERATOR'S MANUAL



Copyright © Lincoln Global Inc.

- World's Leader in Welding and Cutting Products •
- Sales and Service through Subsidiaries and Distributors Worldwide •

Cleveland, Ohio 44117-1199 U.S.A. TEL: 216.481.8100 FAX: 216.486.1751 WEB SITE: www.lincolnelectric.com

⚠ WARNING

⚠ CALIFORNIA PROPOSITION 65 WARNINGS ⚠

Diesel engine exhaust and some of its constituents are known to the State of California to cause cancer, birth defects, and other reproductive harm.

The Above For Diesel Engines

The engine exhaust from this product contains chemicals known to the State of California to cause cancer, birth defects, or other reproductive harm.

The Above For Gasoline Engines

ARC WELDING CAN BE HAZARDOUS. PROTECT YOURSELF AND OTHERS FROM POSSIBLE SERIOUS INJURY OR DEATH. KEEP CHILDREN AWAY. PACEMAKER WEARERS SHOULD CONSULT WITH THEIR DOCTOR BEFORE OPERATING.

Read and understand the following safety highlights. For additional safety information, it is strongly recommended that you purchase a copy of "Safety in Welding & Cutting - ANSI Standard Z49.1" from the American Welding Society, P.O. Box 351040, Miami, Florida 33135 or CSA Standard W117.2-1974. A Free copy of "Arc Welding Safety" booklet E205 is available from the Lincoln Electric Company, 22801 St. Clair Avenue, Cleveland, Ohio 44117-1199.

BE SURE THAT ALL INSTALLATION, OPERATION, MAINTENANCE AND REPAIR PROCEDURES ARE PERFORMED ONLY BY QUALIFIED INDIVIDUALS.



FOR ENGINE powered equipment.

1.a. Turn the engine off before troubleshooting and maintenance work unless the maintenance work requires it to be running.



1.b. Operate engines in open, well-ventilated areas or vent the engine exhaust fumes outdoors.



1.c. Do not add the fuel near an open flame welding arc or when the engine is running. Stop the engine and allow it to cool before refueling to prevent spilled fuel from vaporizing on contact with hot engine parts and igniting. Do not spill fuel when filling tank. If fuel is spilled, wipe it up and do not start engine until fumes have been eliminated.

1.d. Keep all equipment safety guards, covers and devices in position and in good repair. Keep hands, hair, clothing and tools away from V-belts, gears, fans and all other moving parts when starting, operating or repairing equipment.

1.e. In some cases it may be necessary to remove safety guards to perform required maintenance. Remove guards only when necessary and replace them when the maintenance requiring their removal is complete. Always use the greatest care when working near moving parts.



1.f. Do not put your hands near the engine fan. Do not attempt to override the governor or idler by pushing on the throttle control rods while the engine is running.

1.g. To prevent accidentally starting gasoline engines while turning the engine or welding generator during maintenance work, disconnect the spark plug wires, distributor cap or magneto wire as appropriate.



1.h. To avoid scalding, do not remove the radiator pressure cap when the engine is hot.



ELECTRIC AND MAGNETIC FIELDS may be dangerous

2.a. Electric current flowing through any conductor causes localized Electric and Magnetic Fields (EMF). Welding current creates EMF fields around welding cables and welding machines

2.b. EMF fields may interfere with some pacemakers, and welders having a pacemaker should consult their physician before welding.

2.c. Exposure to EMF fields in welding may have other health effects which are now not known.

2.d. All welders should use the following procedures in order to minimize exposure to EMF fields from the welding circuit:

2.d.1. Route the electrode and work cables together - Secure them with tape when possible.

2.d.2. Never coil the electrode lead around your body.

2.d.3. Do not place your body between the electrode and work cables. If the electrode cable is on your right side, the work cable should also be on your right side.

2.d.4. Connect the work cable to the workpiece as close as possible to the area being welded.

2.d.5. Do not work next to welding power source.

Mar '95



ELECTRIC SHOCK can kill.

- 3.a. The electrode and work (or ground) circuits are electrically “hot” when the welder is on. Do not touch these “hot” parts with your bare skin or wet clothing. Wear dry, hole-free gloves to insulate hands.
- 3.b. Insulate yourself from work and ground using dry insulation. Make certain the insulation is large enough to cover your full area of physical contact with work and ground.
- In addition to the normal safety precautions, if welding must be performed under electrically hazardous conditions (in damp locations or while wearing wet clothing; on metal structures such as floors, gratings or scaffolds; when in cramped positions such as sitting, kneeling or lying, if there is a high risk of unavoidable or accidental contact with the workpiece or ground) use the following equipment:**
- **Semiautomatic DC Constant Voltage (Wire) Welder.**
 - **DC Manual (Stick) Welder.**
 - **AC Welder with Reduced Voltage Control.**
- 3.c. In semiautomatic or automatic wire welding, the electrode, electrode reel, welding head, nozzle or semiautomatic welding gun are also electrically “hot”.
- 3.d. Always be sure the work cable makes a good electrical connection with the metal being welded. The connection should be as close as possible to the area being welded.
- 3.e. Ground the work or metal to be welded to a good electrical (earth) ground.
- 3.f. Maintain the electrode holder, work clamp, welding cable and welding machine in good, safe operating condition. Replace damaged insulation.
- 3.g. Never dip the electrode in water for cooling.
- 3.h. Never simultaneously touch electrically “hot” parts of electrode holders connected to two welders because voltage between the two can be the total of the open circuit voltage of both welders.
- 3.i. When working above floor level, use a safety belt to protect yourself from a fall should you get a shock.
- 3.j. Also see Items 6.c. and 8.



ARC RAYS can burn.

- 4.a. Use a shield with the proper filter and cover plates to protect your eyes from sparks and the rays of the arc when welding or observing open arc welding. Headshield and filter lens should conform to ANSI Z87.1 standards.
- 4.b. Use suitable clothing made from durable flame-resistant material to protect your skin and that of your helpers from the arc rays.
- 4.c. Protect other nearby personnel with suitable, non-flammable screening and/or warn them not to watch the arc nor expose themselves to the arc rays or to hot spatter or metal.



FUMES AND GASES can be dangerous.

- 5.a. Welding may produce fumes and gases hazardous to health. Avoid breathing these fumes and gases. When welding, keep your head out of the fume. Use enough ventilation and/or exhaust at the arc to keep fumes and gases away from the breathing zone. **When welding with electrodes which require special ventilation such as stainless or hard facing (see instructions on container or MSDS) or on lead or cadmium plated steel and other metals or coatings which produce highly toxic fumes, keep exposure as low as possible and below Threshold Limit Values (TLV) using local exhaust or mechanical ventilation. In confined spaces or in some circumstances, outdoors, a respirator may be required. Additional precautions are also required when welding on galvanized steel.**
5. b. The operation of welding fume control equipment is affected by various factors including proper use and positioning of the equipment, maintenance of the equipment and the specific welding procedure and application involved. Worker exposure level should be checked upon installation and periodically thereafter to be certain it is within applicable OSHA PEL and ACGIH TLV limits.
- 5.c. Do not weld in locations near chlorinated hydrocarbon vapors coming from degreasing, cleaning or spraying operations. The heat and rays of the arc can react with solvent vapors to form phosgene, a highly toxic gas, and other irritating products.
- 5.d. Shielding gases used for arc welding can displace air and cause injury or death. Always use enough ventilation, especially in confined areas, to insure breathing air is safe.
- 5.e. Read and understand the manufacturer’s instructions for this equipment and the consumables to be used, including the material safety data sheet (MSDS) and follow your employer’s safety practices. MSDS forms are available from your welding distributor or from the manufacturer.
- 5.f. Also see item 1.b.

AUG 06

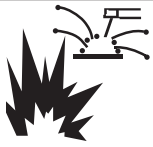

WELDING and CUTTING SPARKS can cause fire or explosion.

6.a. Remove fire hazards from the welding area. If this is not possible, cover them to prevent the welding sparks from starting a fire.

Remember that welding sparks and hot materials from welding can easily go through small cracks and openings to adjacent areas. Avoid welding near hydraulic lines. Have a fire extinguisher readily available.

- 6.b. Where compressed gases are to be used at the job site, special precautions should be used to prevent hazardous situations. Refer to "Safety in Welding and Cutting" (ANSI Standard Z49.1) and the operating information for the equipment being used.
- 6.c. When not welding, make certain no part of the electrode circuit is touching the work or ground. Accidental contact can cause overheating and create a fire hazard.
- 6.d. Do not heat, cut or weld tanks, drums or containers until the proper steps have been taken to insure that such procedures will not cause flammable or toxic vapors from substances inside. They can cause an explosion even though they have been "cleaned". For information, purchase "Recommended Safe Practices for the Preparation for Welding and Cutting of Containers and Piping That Have Held Hazardous Substances", AWS F4.1 from the American Welding Society (see address above).
- 6.e. Vent hollow castings or containers before heating, cutting or welding. They may explode.
- 6.f. Sparks and spatter are thrown from the welding arc. Wear oil free protective garments such as leather gloves, heavy shirt, cuffless trousers, high shoes and a cap over your hair. Wear ear plugs when welding out of position or in confined places. Always wear safety glasses with side shields when in a welding area.
- 6.g. Connect the work cable to the work as close to the welding area as practical. Work cables connected to the building framework or other locations away from the welding area increase the possibility of the welding current passing through lifting chains, crane cables or other alternate circuits. This can create fire hazards or overheat lifting chains or cables until they fail.
- 6.h. Also see item 1.c.
- 6.i. Read and follow NFPA 51B "Standard for Fire Prevention During Welding, Cutting and Other Hot Work", available from NFPA, 1 Batterymarch Park, PO box 9101, Quincy, Ma 022690-9101.
- 6.j. Do not use a welding power source for pipe thawing.



CYLINDER may explode if damaged.

- 7.a. Use only compressed gas cylinders containing the correct shielding gas for the process used and properly operating regulators designed for the gas and pressure used. All hoses, fittings, etc. should be suitable for the application and maintained in good condition.
- 7.b. Always keep cylinders in an upright position securely chained to an undercarriage or fixed support.
- 7.c. Cylinders should be located:
 - Away from areas where they may be struck or subjected to physical damage.
 - A safe distance from arc welding or cutting operations and any other source of heat, sparks, or flame.
- 7.d. Never allow the electrode, electrode holder or any other electrically "hot" parts to touch a cylinder.
- 7.e. Keep your head and face away from the cylinder valve outlet when opening the cylinder valve.
- 7.f. Valve protection caps should always be in place and hand tight except when the cylinder is in use or connected for use.
- 7.g. Read and follow the instructions on compressed gas cylinders, associated equipment, and CGA publication P-1, "Precautions for Safe Handling of Compressed Gases in Cylinders," available from the Compressed Gas Association 1235 Jefferson Davis Highway, Arlington, VA 22202.



FOR ELECTRICALLY powered equipment.

- 8.a. Turn off input power using the disconnect switch at the fuse box before working on the equipment.
- 8.b. Install equipment in accordance with the U.S. National Electrical Code, all local codes and the manufacturer's recommendations.
- 8.c. Ground the equipment in accordance with the U.S. National Electrical Code and the manufacturer's recommendations.

Jan, 07

PRÉCAUTIONS DE SÛRETÉ

Pour votre propre protection lire et observer toutes les instructions et les précautions de sûreté spécifiques qui paraissent dans ce manuel aussi bien que les précautions de sûreté générales suivantes:

Sûreté Pour Soudage A L'Arc

1. Protégez-vous contre la secousse électrique:
 - a. Les circuits à l'électrode et à la pièce sont sous tension quand la machine à souder est en marche. Eviter toujours tout contact entre les parties sous tension et la peau nue ou les vêtements mouillés. Porter des gants secs et sans trous pour isoler les mains.
 - b. Faire très attention de bien s'isoler de la masse quand on soude dans des endroits humides, ou sur un plancher métallique ou des grilles métalliques, principalement dans les positions assis ou couché pour lesquelles une grande partie du corps peut être en contact avec la masse.
 - c. Maintenir le porte-électrode, la pince de masse, le câble de soudage et la machine à souder en bon et sûr état de fonctionnement.
 - d. Ne jamais plonger le porte-électrode dans l'eau pour le refroidir.
 - e. Ne jamais toucher simultanément les parties sous tension des porte-électrodes connectés à deux machines à souder parce que la tension entre les deux pinces peut être le total de la tension à vide des deux machines.
 - f. Si on utilise la machine à souder comme une source de courant pour soudage semi-automatique, ces précautions pour le porte-électrode s'appliquent aussi au pistolet de soudage.
2. Dans le cas de travail au dessus du niveau du sol, se protéger contre les chutes dans le cas où on reçoit un choc. Ne jamais enrouler le câble-électrode autour de n'importe quelle partie du corps.
3. Un coup d'arc peut être plus sévère qu'un coup de soleil, donc:
 - a. Utiliser un bon masque avec un verre filtrant approprié ainsi qu'un verre blanc afin de se protéger les yeux du rayonnement de l'arc et des projections quand on soude ou quand on regarde l'arc.
 - b. Porter des vêtements convenables afin de protéger la peau de soudeur et des aides contre le rayonnement de l'arc.
 - c. Protéger l'autre personnel travaillant à proximité au soudage à l'aide d'écrans appropriés et non-inflammables.
4. Des gouttes de laitier en fusion sont émises de l'arc de soudage. Se protéger avec des vêtements de protection libres de l'huile, tels que les gants en cuir, chemise épaisse, pantalons sans revers, et chaussures montantes.

5. Toujours porter des lunettes de sécurité dans la zone de soudage. Utiliser des lunettes avec écrans latéraux dans les zones où l'on pique le laitier.
6. Eloigner les matériaux inflammables ou les recouvrir afin de prévenir tout risque d'incendie dû aux étincelles.
7. Quand on ne soude pas, poser la pince à un endroit isolé de la masse. Un court-circuit accidentel peut provoquer un échauffement et un risque d'incendie.
8. S'assurer que la masse est connectée le plus près possible de la zone de travail qu'il est pratique de le faire. Si on place la masse sur la charpente de la construction ou d'autres endroits éloignés de la zone de travail, on augmente le risque de voir passer le courant de soudage par les chaînes de levage, câbles de grue, ou autres circuits. Cela peut provoquer des risques d'incendie ou d'échauffement des chaînes et des câbles jusqu'à ce qu'ils se rompent.
9. Assurer une ventilation suffisante dans la zone de soudage. Ceci est particulièrement important pour le soudage de tôles galvanisées plombées, ou cadmiées ou tout autre métal qui produit des fumées toxiques.
10. Ne pas souder en présence de vapeurs de chlore provenant d'opérations de dégraissage, nettoyage ou pistolage. La chaleur ou les rayons de l'arc peuvent réagir avec les vapeurs du solvant pour produire du phosgène (gas fortement toxique) ou autres produits irritants.
11. Pour obtenir de plus amples renseignements sur la sûreté, voir le code "Code for safety in welding and cutting" CSA Standard W 117.2-1974.

PRÉCAUTIONS DE SÛRETÉ POUR LES MACHINES À SOUDER À TRANSFORMATEUR ET À REDRESSEUR

1. Relier à la terre le chassis du poste conformément au code de l'électricité et aux recommandations du fabricant. Le dispositif de montage ou la pièce à souder doit être branché à une bonne mise à la terre.
2. Autant que possible, l'installation et l'entretien du poste seront effectués par un électricien qualifié.
3. Avant de faire des travaux à l'intérieur de poste, la débrancher à l'interrupteur à la boîte de fusibles.
4. Garder tous les couvercles et dispositifs de sûreté à leur place.

Thank You

for selecting a **QUALITY** product by Lincoln Electric. We want you to take pride in operating this Lincoln Electric Company product ... as much pride as we have in bringing this product to you!

CUSTOMER ASSISTANCE POLICY

The business of The Lincoln Electric Company is manufacturing and selling high quality welding equipment, consumables, and cutting equipment. Our challenge is to meet the needs of our customers and to exceed their expectations. On occasion, purchasers may ask Lincoln Electric for advice or information about their use of our products. We respond to our customers based on the best information in our possession at that time. Lincoln Electric is not in a position to warrant or guarantee such advice, and assumes no liability, with respect to such information or advice. We expressly disclaim any warranty of any kind, including any warranty of fitness for any customer's particular purpose, with respect to such information or advice. As a matter of practical consideration, we also cannot assume any responsibility for updating or correcting any such information or advice once it has been given, nor does the provision of information or advice create, expand or alter any warranty with respect to the sale of our products.

Lincoln Electric is a responsive manufacturer, but the selection and use of specific products sold by Lincoln Electric is solely within the control of, and remains the sole responsibility of the customer. Many variables beyond the control of Lincoln Electric affect the results obtained in applying these types of fabrication methods and service requirements.

Subject to Change – This information is accurate to the best of our knowledge at the time of printing. Please refer to www.lincolnelectric.com for any updated information.

Please Examine Carton and Equipment For Damage Immediately

When this equipment is shipped, title passes to the purchaser upon receipt by the carrier. Consequently, Claims for material damaged in shipment must be made by the purchaser against the transportation company at the time the shipment is received.

Please record your equipment identification information below for future reference. This information can be found on your machine nameplate.

Product _____

Model Number _____

Code Number or Date Code _____

Serial Number _____

Date Purchased _____

Where Purchased _____

Whenever you request replacement parts or information on this equipment, always supply the information you have recorded above. The code number is especially important when identifying the correct replacement parts.

On-Line Product Registration

- Register your machine with Lincoln Electric either via fax or over the Internet.
 - For faxing: Complete the form on the back of the warranty statement included in the literature packet accompanying this machine and fax the form per the instructions printed on it.
 - For On-Line Registration: Go to our **WEB SITE at www.lincolnelectric.com**. Choose "Quick Links" and then "Product Registration". Please complete the form and submit your registration.

Read this Operators Manual completely before attempting to use this equipment. Save this manual and keep it handy for quick reference. Pay particular attention to the safety instructions we have provided for your protection. The level of seriousness to be applied to each is explained below:

WARNING

This statement appears where the information **must** be followed **exactly** to avoid **serious personal injury** or **loss of life**.

CAUTION

This statement appears where the information **must** be followed to avoid **minor personal injury** or **damage to this equipment**.

	Page
Installation	Section A
Technical Specifications	A-1
General Description	A-2
Design Features	A-2
Pre-Operation Installation	A-3
Safety Precautions	A-3
Exhaust Spark Arrester	A-3
Location/Ventilation	A-3
Machine Grounding	A-3
Lift Bail	A-3
Trailers	A-4
Polarity Control and Cable Sizes	A-4
Pre-Operation Service	A-4
Oil	A-4
Fuel	A-4
Cooling System	A-4
Battery Charging	A-5
Operation	Section B
Engine Operation	B-1
Starting The Kubota V2203M Engine	B-1
Cold Weather Starting	B-1
High Altitude Operation	B-1
Stopping the engine	B-1
Break-In	B-1
Welder Operation	B-2
Duty Cycle	B-2
Control of Welding Current	B-2
Idle Operation	B-3
Auxiliary Power	B-3
Fuel Consumption Data	B-3
Accessories	Section C
Optional Features (Field Installed)	C-1
Wire Feed Options	C-2
Maintenance	Section D
Safety Precautions	D-1
General Instructions	D-1
Cooling System	D-1
Bearings	D-1
Commutator and Brushes	D-1
Idle Maintenance	D-2
Nameplates	D-2
Purging Air from Fuel System	D-2
Engine Service Chart	D-3
GFCI Receptacle Testing and Resting Procedure	D-4
Troubleshooting	Section E
Safety Precautions	E-1
Welder Troubleshooting	E-2
Electronic Idler Troubleshooting Guide	E-3, E-4
Engine Troubleshooting Guide	E-5, E-6, E-7
Diagrams	Section F
Wiring Diagrams	F-1 thru F-5
Dimension Print	F-6
Parts List	P-498 Series

TECHNICAL SPECIFICATIONS - CLASSIC 300D KUBOTA

INPUT - DIESEL ENGINE					
Make/Model	Description	Speed (RPM)	Displacement	Starting System	Capacities
Kubota V2203M	4 Cylinder 4 Cycle Naturally Aspirated Water-Cooled Diesel Engine Cast Iron Cylinder, Block/Crankcase	High Idle 1800 Low Idle 1400 Full Load 1800	134.1 cu. in (2.2 ltrs)	12VDC battery (Group 24, 650 cold crank amps) 1.4 KW Starter 40 A. Alternator w/ built in reg.	Fuel: 15 gal. 57 L Oil: 8.0 Qts. 7.6 L Coolant: 9.5 Qts. 9.0 L
			Bore x Stroke 3.43" x 3.64" 32.5HP @1800 RPM		
RATED OUTPUT @ 104°F(40°C) - WELDER					
DESCRIPTION	RATED DC OUTPUT* VOLTS @ RATED AMPS		Duty CYCLE	DC CURRENT RANGE Fine Adjustments in each Range	
300 Amp DC Welder All Copper Windings Pure DC Power Generator	30V @ 250A 32V @ 300A 99V DC Max. OCV @ 1800RPM		100% 60%	40-350 Amps 220-Max. 160-240 120-190 80-130 Min.-90	
RATED OUTPUT @ 104°F(40°C) - GENERATOR					
Auxiliary Power ⁽¹⁾					
3,000 Watts Continuous, 60 Hz AC 26 Amps @ 115V 13 Amps @ 230V					
PHYSICAL DIMENSIONS ⁽²⁾					
MODEL	HEIGHT	WIDTH	DEPTH	WEIGHT	
K1643-5 CSA@ With Out Wire Feed Module	45.5 in. (1156 mm)	24.00 in. (610 mm)	66.36 in. (1686 mm)	1320 lbs. (599 kg)	
K1643-6 CSA @ With Wire Feed Module				1355 lbs. (615 kg)	

* Based on a 10 min. period.

(1) Output rating in watts is equivalent to volt-amperes at unity power factor. Output voltage is within $\pm 10\%$ at all loads up to rated capacity. When welding, available auxiliary power will be reduced.

(2) Height to top of exhaust elbow.

CLASSIC 300D KUBOTA



GENERAL DESCRIPTION

The CLASSIC® 300D KUBOTA is a heavy duty, engine driven, DC arc welding power source, capable of providing constant current output for stick welding or DC TIG welding. This welder is wound with all copper coils, rated at 300 amps/32 Volts, and provides other Classic features such as improved door latches and stainless hinges. With the addition of the optional K623-1 Wire Feed Module™, the CLASSIC 300D KUBOTA will provide constant voltage output for running the LN-7, LN-23P, or LN-25 wire feeders. (The Wire Feed Module is factory installed on the K1643-6). The optional K924-5 Remote Control Kit, provides a remote control rheostat for remote fine current and open circuit voltage adjustment. See Section C for description.

The CLASSIC 300D KUBOTA has an Electronic Engine Protection System. In the event of sudden low oil pressure or high coolant temperature, the engine immediately shuts down. The CLASSIC 300D KUBOTA has a current range of 40-350 DC amps with output ratings as follows:

RATED OUTPUT	DUTY CYCLE
250A @ 30V	100%
300A @ 32V	60%

These units are also capable of providing 3 kVA of 115/230 volts of 60 cycle AC auxiliary power.

The CLASSIC 300D KUBOTA uses the Kubota V2203M industrial water-cooled diesel engine.

DESIGN FEATURES

Control Panel

Both the engine and the welder controls are located on one recessed panel at the exciter end of the machine. The welder controls consist of a five step "Current Range Selector" switch and a "Fine Current Adjustment" rheostat. The welder is equipped with a "Start" button, an "Ignition" switch, an "Idler" control switch, and a "Glow Plug" button for easier cold weather starting.

The control panel also contains an engine temperature gauge, a battery charging ammeter, an oil pressure gauge, two three prong grounding type receptacles and circuit breakers for auxiliary power.

All Copper Windings - For long life and dependable operation.

Engine Idler - The Classic 300D is equipped with an electronic automatic engine idler. It automatically increases and decreases engine speed **when starting and stopping welding or using auxiliary power**. A built-in time delay permits changing electrodes before the engine slows to its low idle speed. The "Idler" control switch on the panel locks the idler in high idle position when desired.

Auxiliary Power - 3.0 kVA of nominal 115/230V, 60Hz, AC. Output voltage is maintained within $\pm 10\%$ at all loads up to rated capacity. (See Optional Features for Power Plug Kit.)

Welder Enclosure - The complete welder is rubber mounted on a rugged steel "C" channel base.

The output terminals are placed at the side of the machines so that they are protected by the door. The output terminals are labeled (+) and (-).

Cranking System - A 12 volt electric starter is standard.

Air Cleaner - Heavy duty two stage dry type.

Muffler - A muffler and stainless steel exhaust outlet elbow are standard.

Engine Hour Meter - A meter to record hours of operation.

Engine Protection - The system shuts the engine down in the event of sudden low oil pressure or high coolant temperature. A warning light on the control panel will indicate such a fault. To reset the engine for restarting, turn the ignition switch off then on. Refer to Troubleshooting section for all warning light fault codes.

High Idle RPM (OCV) Adjustment - A Potentiometer is mounted on the Control Panel that allows the operator to adjust the high idle engine speed between 1650 and 1800 RPM'S. This is to allow further adjustment of the OCV. Total OCV adjustment range is about 15 volts.

Oil Drain Valve - A ball valve, hose and clamp are standard.

Remote Control - The Remote/Local switch and Receptacle are standard.

GFCI Receptacle - One UL approved 115V ground fault circuit interrupter duplex type receptacle is standard on codes 11243 and above. See MAINTENANCE section for detailed information on testing and resetting the GFCI receptacle.

CLASSIC 300D KUBOTA



PRE-OPERATION INSTALLATION

WARNING

Do not attempt to use this equipment until you have thoroughly read the engine manufacturer's manual supplied with your welder. It includes important safety precautions, detailed engine starting, operating and maintenance instructions, and parts lists.



ELECTRIC SHOCK can kill.

- Do not touch electrically live parts or electrode with skin or wet clothing.
- Insulate yourself from work and ground
- Always wear dry insulating gloves.



ENGINE EXHAUST can kill.

- Use in open, well ventilated areas or vent exhaust outside.



MOVING PARTS can injure.

- Do not operate with doors open or guards off.
- Stop engine before servicing.
- Keep away from moving parts.

See additional warning information at the front of this operator's manual.

EXHAUST SPARK ARRESTER

Some federal, state or local laws may require that engines be equipped with exhaust spark arresters when they are operated in certain locations where unarrested sparks may present a fire hazard. The standard muffler included with this welder does not qualify as a spark arrester. When required by local regulations, a suitable spark arrester must be installed and properly maintained.

CAUTION

Use of an incorrect arrester may lead to engine damage or performance loss. Contact the engine manufacturer for specific recommendations.

LOCATION/VENTILATION

Always operate the welder with the doors closed. Leaving the doors open changes the designed air flow and may cause overheating.

The welder should be located to provide an unrestricted flow of clean, cool air. Also, locate the welder so that engine exhaust fumes are properly vented to an outside area.

ANGLE OF OPERATION

Engines are designed to run in the level condition which is where the optimum performance is achieved. The maximum angle of continuous operation is 20 degrees in all directions, 30 degrees Intermittent (less than 10 minutes continuous) in all directions.

CAUTION

DO NOT MOUNT OVER COMBUSTIBLE SURFACES.

Where there is a combustible surface directly under stationary or fixed electrical equipment, the surface shall be covered with a steel plate at least .06" (1.6mm) thick, which shall extend not more than 5.90" (150mm) beyond the equipment on all side.

If the engine is to be operated at an angle, provisions must be made for checking and maintaining the oil level at the normal (FULL) oil capacity in the crankcase.

When operating the welder at an angle, the effective fuel capacity will be slightly less than the amount specified.

MACHINE GROUNDING

According to the United States National Electrical Code, the frame of this portable generator is not required to be grounded and is permitted to serve as the grounding means for cord connected equipment plugged into its receptacle.

Some state, local, or other codes or unusual operating circumstances may require the machine frame to be grounded. It is recommended that you determine the extent to which such requirements may apply to your particular situation and follow them explicitly. A machine grounding stud marked with the symbol  is provided on the welding generator frame foot. In general, if the machine is to be grounded, it should be connected with a #8 or larger copper wire to a solid earth ground such as a metal water pipe going into the ground for at least ten feet and having no insulated joints, or to the metal framework of a building which has been effectively grounded. The U.S. National Code lists a number of alternate means of grounding electrical equipment.

LIFT BAIL

A lift bail is provided for lifting with a hoist.

WARNING

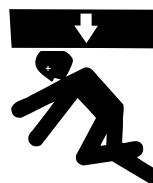

FALLING EQUIPMENT can cause injury.

- Lift only with equipment of adequate lifting capacity.
- Be sure machine is stable when lifting.
- Do not lift this machine using lift bale if it is equipped with a heavy accessory such as trailer or gas cylinder.
- Do not lift machine if lift bale is damaged.
- Do not operate machine while suspended from lift bale.

CLASSIC 300D KUBOTA



TRAILER (See Optional Features)

If the user adapts a non-Lincoln trailer, the user must assume responsibility that the method of attachment and usage does not result in a safety hazard nor damage the welding equipment. Some of the factors to be considered are as follows:

1. Design capacity of trailer vs. weight of Lincoln equipment and likely additional attachments.
2. Proper support of, and attachment to, the base of the welding equipment so there will be no undue stress to the framework.
3. Proper placement of the equipment on the trailer to ensure stability side to side and front to back when being moved and when standing by itself while being operated or serviced.
4. Typical conditions of use, i.e., travel speed, roughness of surface on which the trailer will be operated; environmental conditions, likely maintenance.
5. Conformance with federal, state and local laws. ⁽¹⁾

⁽¹⁾ Consult your federal, state and local laws regarding specific requirements for use on public highways.

VEHICLE MOUNTING

WARNING

Improperly mounted concentrated loads may cause unstable vehicle handling and tires or other components to fail.

- Only transport this Equipment on serviceable vehicles which are rated and designed for such loads.
- Distribute, balance and secure loads so vehicle is stable under conditions of use.
- Do not exceed maximum rated loads for components such as suspension, axles and tires.
- Mount equipment base to metal bed or frame of vehicle.
- Follow vehicle manufacture's instructions.

POLARITY CONTROL AND CABLE SIZES

With the engine off, route the electrode and work cables through the strain relief bracket on the base and connect to the studs located below the fuel tank mounting rail. (See size recommendations below.) For **positive** polarity, connect the electrode cable to the terminal marked "+". For **Negative** polarity, connect the electrode cable to the "-" stud. These connections should be checked periodically and tightened if necessary.

When welding at a considerable distance from the welder, be sure you use ample sized welding cables.

RECOMMENDED COPPER CABLE SIZES			
Amps	Duty Cycle	Cables Sizes for Combined Length of Electrode Plus Work Cable	
		Up to 200ft.(61m)	200 to 250ft. (61 to 76m)
250	100%	1	1/0
300	60%	1/0	2/0

PRE-OPERATION SERVICE

CAUTION

READ the engine operating and maintenance instructions supplied with this machine.

WARNING



DIESEL FUEL
can
cause fire

- Stop engine while fueling.
- Do not smoke when fueling.
- Keep sparks and flame away from tank.
- Do not leave unattended while fueling.
- Wipe up spilled fuel and allow fumes to clear before starting engine.
- Do not overfill tank, fuel expansion may cause overflow.

DIESEL FUEL ONLY

OIL



This unit is supplied from the factory with the engine crankcase filled with a high quality SAE 10W/30 oil. This oil should be acceptable for most typical ambient temperatures. Consult the engine operation manual for specific engine manufacturer's recommendations. Upon receipt of the welder, check the engine dipstick to be sure the oil is at the "full" mark. DO NOT overfill.

FUEL

Fill the fuel tank with the grade of fuel recommended in the Engine Operator's manual. Make sure the valve on the water separator is in the open position.

COOLING SYSTEM

The radiator has been filled at the factory with a 50-50 mixture of ethylene glycol antifreeze and water. Check the radiator level and add a 50-50 solution as needed (see engine manual or antifreeze container for alternate antifreeze recommendations).

CLASSIC 300D KUBOTA



Battery Charging

WARNING



GASES FROM BATTERY can explode.

- Keep sparks, flame and cigarettes away.



BATTERY ACID can burn eyes and skin.

- Wear gloves and eye protection and be careful when boosting, charging or working near battery.

To prevent **EXPLOSION** when:

- Installing a new battery - disconnect the negative cable from the old battery first and connect the negative cable to the new battery last.
- Connecting a battery charger - remove the battery from the welder by disconnecting the negative cable first, then the positive cable and battery clamp. When reinstalling, connect the negative cable last.
- Using a booster - connect the positive lead to the battery first, then connect the negative lead to the ground lead on the base.

To prevent **ELECTRICAL DAMAGE** when:

- Installing a new battery.
- Using a booster.

Use correct polarity - **Negative Ground**.

To prevent **BATTERY DISCHARGE**, if you have an ignition switch, turn it off when engine is not running.

- To prevent **BATTERY BUCKLING**, tighten nuts on battery clamp until snug.

The CLASSIC 300D KUBOTA is equipped with a wet charged battery. The charging current is automatically regulated when the battery is low (after starting the engine) to a trickle current when the battery is fully charged.

When replacing, jumping or otherwise connecting the battery to the battery cables, the proper polarity must be observed. This system is **NEGATIVE GROUND**.

ENGINE OPERATION

WARNING

Do not attempt to use this equipment until you have thoroughly read the engine manufacturer's manual supplied with your welder. It includes important safety precautions, detailed engine starting, operating and maintenance instructions, and parts lists.



ELECTRIC SHOCK can kill.

- Do not touch electrically live parts or electrode with skin or wet clothing.
- Insulate yourself from work and ground
- Always wear dry insulating gloves.



ENGINE EXHAUST can kill.

- Use in open, well ventilated areas or vent exhaust outside.



MOVING PARTS can injure.

- Do not operate with doors open or guards off.
- Stop engine before servicing.
- Keep away from moving parts.

See additional warning information at the front of this operator's manual.

Operate the welder with the doors closed. Leaving the doors open changes the designed air flow and can cause overheating.

STARTING THE CLASSIC 300D KUBOTA V2203M DIESEL ENGINE

1. Turn the "IDLER" switch to "HIGH".
2. Turn the "IGNITION" switch to "ON".
3. Press the Glow Plug button for 20 to 30 seconds. (maximum 60 seconds).
4. Press the Glow Plug button and the Start button at the same time. When the engine starts running, release both buttons. If the engine fails to start in 20 seconds, wait 30 seconds and repeat the above procedure.
5. Observe the oil pressure. If no pressure shows within 30 seconds, stop the engine and consult the engine operating manual. To stop the engine, turn the "IGNITION" switch to "OFF".
6. If the engine protection warning light comes on during cranking or after start up, the "IGNITION" switch must be turned "OFF" to reset the engine protection system.
7. Allow the engine to run at high idle speed for several minutes to warm the engine. Stop the engine and recheck the oil level, after allowing sufficient time for the oil to drain into the pan. If the level is down, fill it to the full mark again. The engine controls were properly set at the factory and should require no adjusting when received.

COLD WEATHER STARTING:

With a fully charged battery and the proper weight oil, the engine should start satisfactorily even down to about -5°F (-20°C), it maybe desirable to install cold-starting aides.

Note: Extreme cold weather staring may require longer glow plug operation.

WARNING

Under **NO** conditions should ether or other starting fluids be used!

HIGH ALTITUDE OPERATION:

At higher altitudes, output derating may be necessary. For maximum rating, derate the welder 4% for every 300 meters (984 ft.) above 1500 meters (4920 ft.).

Contact a Kubota Service Representative for any engine adjustments that may be required.

STOPPING THE ENGINE

1. Turn the "IGNITION" switch to "OFF"

At the end of each day's welding, check the crankcase oil level, drain accumulated dirt and water from the water separator and refill the fuel tank to minimize moisture condensation in the tank. Also, running out of fuel tends to draw dirt into the fuel system.

When hauling the welder between job sites, close the valve on the water separator.

If the fuel supply is cut off or runs out while the fuel pump is operating, air may be entrapped in the fuel distribution system. If this happens, bleeding of the fuel system may be necessary. Use qualified personnel to do this per the instructions in the MAINTENANCE section of this manual.

ENGINE BREAK-IN

Lincoln Electric selects high quality, heavy-duty industrial engines for the portable welding machines we offer. While it is normal to see a small amount of crankcase oil consumption during initial operation, excessive oil use, wet stacking (oil or tar like substance at the exhaust port), or excessive smoke is not normal.

CLASSIC 300D KUBOTA



Larger machines with a capacity of 350 amperes and higher, which are operated at low or no-load conditions for extended periods of time are especially susceptible to the conditions described above. To accomplish successful engine break-in, most diesel-powered equipment needs only to be run at a reasonably heavy load within the rating of the welder for some period of time during the engine's early life. However, if the welder is subjected to extensive light loading, occasional moderate to heavy loading of the engine may sometimes be necessary. Caution must be observed in correctly loading a diesel/generator unit.

1. Connect the welder output studs to a suitable resistive load bank. Note that any attempt to short the output studs by connecting the welding leads together, direct shorting of the output studs, or connecting the output leads to a length of steel will result in catastrophic damage to the generator and voids the warranty.
2. Set the welder controls for an output current and voltage within the welder rating and duty cycle. Note that any attempt to exceed the welder rating or duty cycle for any period of time will result in catastrophic damage to the generator and voids the warranty.
3. Periodically shut off the engine and check the crankcase oil level.

WELDER OPERATION

⚠ WARNING



ELECTRIC SHOCK can kill.

- Do not touch electrically live parts or electrode with skin or wet clothing.
- Insulate yourself from work and ground.



FUMES & GASES can be dangerous.

- Keep your head out of the fumes.
- Use ventilation or exhaust to remove fumes from breathing zone.



WELDING SPARKS can cause fire or explosion.

- Keep flammable material away.



ARC RAYS can burn.

- Wear eye, ear, and body protection.

DUTY CYCLE

The NEMA output rating of the CLASSIC 300D KUBOTA is 300 amperes at 32 arc volts on a 60% duty cycle (consult Specifications in this manual for alternate ratings). Duty cycle is based on a ten minute period; thus, the welder can be loaded at rated output for six minutes out of every ten minute period.

CONTROL OF WELDING CURRENT

⚠ CAUTION

DO NOT TURN THE "CURRENT RANGE SELECTOR" WHILE WELDING because the current may arc between the contacts and damage the switch.

The "Current Range Selector" provides five overlapping current ranges. The "Fine Current Adjustment" adjusts the current from minimum to maximum within each range. Open circuit voltage is also controlled by the "Fine Current Adjustment" permitting control of the arc characteristics.

A high open circuit voltage setting provides the soft "buttering" arc with best resistance to pop-outs preferred for most welding. To get this characteristic, set the "Current Range Selector" to the lowest setting that still provides the current you need and set the "Fine Current Adjustment" near maximum. For example: to obtain 175 amps and a soft arc, set the "Current Range Selector" to the 190-120 position and then adjust the "Fine Current Adjustment" for 175 amps.

When a forceful "digging" arc is required, usually for vertical and overhead welding, use a higher "Current Range Selector" setting and lower open circuit voltage. For example: to obtain 175 amps and a forceful arc, set the "Current Range Selector" to the 240-160 position and the "Fine Current Adjustment" setting to get 175 amps.

Some arc instability may be experienced with EXX10 electrodes when trying to operate with long arc techniques at settings at the lower end of the open circuit voltage range.

⚠ CAUTION



DO NOT attempt to set the "Current Range Selector" between the five points designated on the nameplate.

These switches have a spring loaded cam which almost eliminates the possibility of setting this switch between the designated points.

IDLER OPERATION

Start the engine with the “Idler” switch in the “High” position. Allow it to run at high idle speed for several minutes to warm the engine. See Specifications for operating speeds.

The idler is controlled by the “Idler” toggle switch on the welder control panel. The switch has two positions as follows:

1. In the “High”  position, the engine control unit increases the engine to high idle speed.
2. In the “Auto”  /  position, the idler operates as follows:
 - a. When welding or drawing power for lights or tools (approximately 100 watts minimum) from the receptacles, the engine operates at high idle speed.
 - b. When welding ceases or the power load is turned off, a preset time delay of about 15 seconds starts. This time delay cannot be adjusted.
 - c. If the welding or power load is not re-started before the end of the time delay, the engine control unit reduces the engine to low idle speed.

AUXILIARY POWER

Start the engine and set the “IDLER” control switch to the “High Idle” mode. Voltage is now correct at the receptacles for auxiliary power. This must be done before a tripped GFCI receptacle can be reset properly. See the MAINTENANCE section for detailed information on testing and resetting the GFCI receptacle.

The AC auxiliary power, supplied as a standard, has a rating of 3.0 kVA of 115/230 VAC (60 hertz).

With the 3.0 kVA, 115/230 VAC auxiliary power, one 115V duplex and one 230V duplex, grounding type receptacle are provided. The circuit is protected with circuit breakers.

The rating of 3.0 kVA permits a maximum continuous current of 13 amps to be drawn from the 230 volt duplex receptacle. Or a total of 26 amps can be drawn from the 115 volt duplex receptacle. The 115 volt duplex receptacle has a configuration which permits 20 amps to be drawn from either half. The total combined load of all receptacles is not to exceed 3.0 kVA.

An optional power plug kit is available. When this kit is specified, the customer is supplied with a plug for each receptacle.

When the High Speed Adjustment knob is in the MIN position, the frequency of the AC auxiliary output may be reduced to approximately 55 Hertz. It is recommended that the High Idle Speed Adjustment knob should be in the MAX position when using the AC auxiliary output.

**CLASSIC 300D WITH KUBOTA V2203M DIESEL ENGINE
TYPICAL FUEL CONSUMPTION DATA**

Low Idle (1400 RPM)-No Load	0.30 gal/hr (1.14 ltrs/hr)
High Idle (1800 RPM)-No Load	0.46 gal/hr (1.74 ltrs/hr)
3,000 Watts	0.61 gal/hr (2.31 ltrs/hr)
250 Amps @ 30 Volts	1.01 gal/hr (3.82 ltrs/hr)
300 Amps @ 32 Volts	1.32 gal/hr (5.00 ltrs/hr)

OPTIONAL FEATURES (Field Installed)**GENERAL OPTIONS****⚠ WARNING**

Pipe Thawing with an arc welder can cause fire, explosion, damage to electric wiring or to the arc welder if done improperly. The use of an arc welder for pipe thawing is not approved by the CSA, nor is it recommended or supported by Lincoln Electric.

Power Plug Kit (K802D) - A power plug kit for the auxiliary power receptacles is available. (Provides a plug for each receptacle.)

GFCI Receptacle Kit (K1690-1) - Includes one UL approved 115V ground fault circuit interrupter duplex type receptacle with cover and installation instructions. Replaces the factory installed 115V duplex receptacle. Each receptacle of the GFCI duplex is rated at 20 amps. Maximum total current from the GFCI duplex is limited to 20 amps. (For Codes 11112, 11113). See MAINTENANCE section for detailed information on testing and resetting the GFCI receptacle.

Spark Arrestor Kit (K903-1) - Includes a heavy gage steel, approved spark arrestor, clamp and adapter for mounting to the muffler exhaust pipe.

TRAILER (K953-1) - Two-wheeled trailer with optional fender and light package. For highway use, consult applicable federal, state, and local laws regarding possible additional requirements. There is a choice of 2 hitches, a fender & a light package.

K953-1 Trailer

K958-1 Ball Hitch

K958-2 Lunette Eye Hitch

K959-1 Fender & Light Kit

K965-1 Cable Rack

Service Indicator Kit K1858-1 - Provides a GO / NO-GO visual indication of air cleaner element useful service life. Filter service based on restriction readings allows the longest life possible from the filter and best engine protection.

STICK OPTIONS

K704 ACCESSORY SET - Includes 35 feet (10 m) of electrode cable and 30 feet (9 m) of work cable, headshield, work clamp and electrode holder. Cable is rated at 500 amps, 60% duty cycle.

Remote Control Kit (K924-5) - Contains remote control rheostat and 100 ft. (30.5 m) cable for adjusting the OCV at the welding site. (For Codes 10911 and above.)

Remote Control Kit (K2464-1) - Contains remote control rheostat (for adjusting the CC "STICK" OCV), and 100ft.(30.5m) cable. (See Wiring/Connection Diagram Section F)

TIG OPTIONS

TIG Module (K930-2) - Provides high frequency and shielding gas control for AC and DC GTAW (TIG) welding applications. Its compact case is designed for easy carrying, complete with a handle. High frequency bypass is built in. The K936-4 control cable is required.

PTA-26V TIG Torch (K1783-9) - Air cooled 200 amp-torch equipped with valve for gas flow control. 25Ft. length.

Magnum Parts Kit For PTA-26V TIG Torch KP509

Control Cable (K936-4) (required for TIG Module) - Control Cable for connecting the K930-2 TIG Module.

Arc Start Switch (K814) (required for TIG Module) - Comes with a 25ft.(7.6m) cable. Attaches to the TIG torch for convenient finger control.

Contact Kit (K938-1) (required for TIG Module) - Provide "Cold" tungsten Tip when welding with the TIG Module.

Control Cable Extension (K937-45) - Allows the TIG Module to be operated at distances up to 200 ft. from the power source. Available in 45 ft. (13.7m).

Water Valve Kit (K844-1)- For use with a water-cooled TIG torch. Installs inside TIG Module.

WIRE FEED OPTIONS

Wire Feed Module (K623-1) - Provides constant voltage (CV) output with improved arc stability for Innershield welding. Excellent for MIG welding. Recommended wire feeders are the LN-7, LN-23P and LN-25. (Factory installed on the K1643-6).

LN-25 Wire Feeder (K449)-Portable CC/CV unit for flux-cored and MIG welding. Includes Gas Solenoid & Internal Contactor. Requires Wire Feed Module.

Remote Voltage Control Kit for LN-25 (K444-2) Provides 25 ft. (7.5m) of remote output voltage control and output jumper (2 and 4) for machines having 14 pin MS-type connector.

Magnum® 350 Innershield Gun (for LN-25)(K126-2)- For self-shielded wire with 15 ft. (4.5m) cable. For .062-3/32" (1.6-2.8mm) wire.

Magnum® 300 MIG Gun for LN-25 K1802-1 - With 15 ft. (4.5m) cable. For .035"-.045" (0.9-1.2mm) gas shielded (Includes Connector Kit).

LN-23P Wire Feeder (K316L-1)-Portable CV unit for Innershield pipe welding. Control cable operates contactor inside Wire Feed Module for "cold" electrode. Requires LN-23P Adapter Kit (K350-1) and Gun and Cable Assembly.

LN-23P Adapter Kit (K350-1)-Required to adapt LN-23P to any Lincoln power source. Makes 14 pin connection at power source.

Magnum® 250 Innershield Gun (for LN-23P) (K355-10)- For lighter weight and easier handling. Rated 250 amps, 60% duty cycle. For .068 through 5/64" (1.7 through 2.0 mm) Innershield wire and includes reduced speed switch. For pipewelding, an M11476 62° gun tube is recommended.

62° gun tube for PipeWelding (KP1909-1)- Recommended modification for K355-X or K345-X guns with 90° gun tubes. Compatible with K126-1,-2 K264-8 and K355-10.

Magnum Spool Gun (K487-25)-Hand held semiautomatic wire feeder requires SG Control Module. 25 ft. (7.6m)length.

SG Control Module (K488) (For Magnum Spool Gun) -The interface between the power source and the spool gun. Provides control of wire speed and gas flow.

Input Cable (K691-10) (For SG Control Module) - For Lincoln engine drives with 14-pin MS-type connection provides separate 115V NEMA receptacle and output stud connections. 10 ft. (3.1m)length.

MAINTENANCE

WARNING

Have qualified personnel do the maintenance work. Turn the engine off before working inside the machine. In some cases, it may be necessary to remove safety guards to perform required maintenance. Remove guards only when necessary and replace them when the maintenance requiring their removal is complete. Always use the greatest care when working near moving parts.

Do not put your hands near the engine cooling blower fan. If a problem cannot be corrected by following the instructions, take the machine to the nearest Lincoln Field Service Shop.



ELECTRIC SHOCK can kill.

- Do not touch electrically live parts or electrode with skin or wet clothing.
- Insulate yourself from work and ground
- Always wear dry insulating gloves.



ENGINE EXHAUST can kill.

- Use in open, well ventilated areas or vent exhaust outside.



MOVING PARTS can injure.

- Do not operate with doors open or guards off.
- Stop engine before servicing.
- Keep away from moving parts.

See additional warning information at front of this operator's manual.

GENERAL INSTRUCTIONS

1. Blow out the welder and controls with an air hose at least once every two months. In particularly dirty locations, this cleaning may be necessary once a week. Use low pressure air to avoid driving dirt into the insulation.
2. "Current Range Selector" contacts should not be greased. To keep the contacts clean, rotate the current control through its entire range frequently. Good practice is to turn the handle from maximum to minimum setting twice each morning before starting to weld.
3. Put a drop of oil on the "Current Range Selector" shaft at least once every month.

4. Follow the engine service schedule in this manual and the detailed maintenance and troubleshooting in the engine manufacturer's manual.

COOLING SYSTEM

The CLASSIC 300D KUBOTA is equipped with a pressure radiator. Keep the radiator cap tight to prevent loss of coolant. Clean and flush the cooling system periodically to prevent clogging the passage and overheating the engine. When antifreeze is needed, always use the permanent type.

BEARINGS

This welder is equipped with a double-shielded ball bearing having sufficient grease to last indefinitely under normal service. Where the welder is used constantly or in excessively dirty locations, it may be necessary to add one half ounce of grease per year. A pad of grease one inch wide, one inch long, and one inch high weighs approximately one half ounce. Overgreasing is far worse than insufficient greasing.

When greasing the bearings, keep all dirt out of the area. Wipe the fittings completely clean and use clean equipment. More bearing failures are caused by dirt introduced during greasing than from insufficient grease.

COMMUTATOR AND BRUSHES

WARNING

Uncovered rotating equipment can be dangerous. Use care so your hands, hair, clothing or tools do not catch in the rotating parts. Protect yourself from particles that may be thrown out by the rotating armature when stoning the commutator.

Shifting of the commutator brushes may result in:

- Change in machine output
- Commutator damage
- Excessive brush wear

Periodically inspect the commutator, slip rings, and brushes by removing the covers. DO NOT remove or replace these covers while the machine is running. Commutators and slip rings require little attention. However, if they are black or appear uneven, have them cleaned by an experienced maintenance man using fine sandpaper or a commutator stone. Never use emery cloth or paper for this purpose.

CLASSIC 300D KUBOTA



Replace brushes when they wear within 1/4" (3.5mm) of the pigtail. A complete set of replacement brushes should be kept on hand. Lincoln brushes have a curved face to fit the commutator. Have an experienced maintenance man seat these brushes by lightly stoning the commutator as the armature rotates at full speed until contact is made across the full face of the brushes. After stoning, blow out the dust with low pressure air.

To seat slip ring brushes, position the brushes in place. Then slide one end of a piece of fine sandpaper between slip rings and brushes with the coarse side against the brushes. With slight additional finger pressure on top of the brushes, pull the sandpaper around the circumference of the rings - in direction of rotation only - until brushes seat properly. In addition, stone slip ring with a fine stone. Brushes must be seated 100%.

Arcing or excessive exciter brush wear indicates a possible misaligned shaft. Have an authorized Field Service Shop check and realign the shaft.

⚠ CAUTION

IDLER MAINTENANCE

Before doing electrical work, disconnect the battery.

When installing a new battery or using a jumper battery to start the engine, be sure the battery polarity is connected properly. The correct polarity is **negative** ground. Damage to the engine alternator and the Engine Control Unit can result from incorrect connection.

1. Proper operation of the idler requires good grounding of the Engine Control Unit, current sensing printed circuit board and battery.
2. If desired, the welder can be used without automatic idling by setting the "Idler" switch to the "High" position.

NAMEPLATES

Whenever routine maintenance is performed on this machine - or at least yearly - inspect all nameplates and labels for legibility. Replace those which are no longer clear. Refer to the parts list for the replacement item number.

PURGING AIR FROM FUEL SYSTEM (KUBOTA V2203M ENGINE)

⚠ WARNING

Keep fuel clear of open flames or arcs, allow engine to cool before working on the fuel system. Wipe up any spilled fuel and do not start engine until fumes clear.

If the engine is running rough and you suspect air has been trapped in the fuel system, (e.g. the engine was allowed to run out of fuel) perform the following steps using qualified personnel:

1. Fully open the air bleeding valve by turning it counter clockwise, it is located on top of the fuel injection pump next to the oil filler. (see figure D.1)

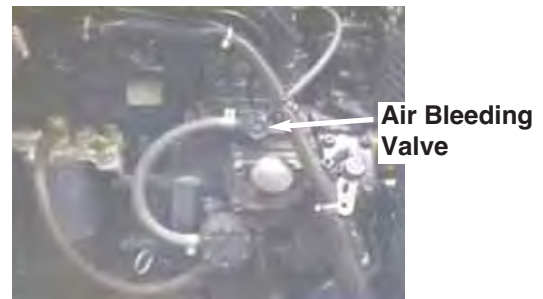

FIGURE D.1

2. Turn the engine by pressing the start button until the engine runs smoothly (this should take approximately 10 seconds).
3. Fully close the air bleeding valve by turning it clockwise.

Contact your Kubota Engine repair facility if problems persist.

ENGINE SERVICE

EVERY DAY OR EVERY 8 HOURS								
FIRST SERVICE (50 HOURS)								
EVERY 100 HOURS OR 3 MONTHS								
EVERY 150 HOURS OR 4 MONTHS								
EVERY 300 HOURS OR 9 MONTHS								
EVERY 400 HOURS OR 12 MONTHS								
EVERY 500 HOURS OR 15 MONTHS								
EVERY 600 HOURS OR 18 MONTHS								
ENGINE SERVICE (NOTE 2)								
							MAINTENANCE ITEM	TYPE OR QUANTITY
I							Coolant level	
				I			Concentration of antifreeze	50/50 Water/Ethylene Glycol
					R		Coolant (NOTE 3)	9.5 qrts., 9.0L
I							Engine oil level (NOTE 1)	
	R	R					Engine oil (NOTE 1 & 3)	8.0 qrts., 7.6L (including filter)
	R		R				Engine oil filter	Kubota #16414-32430
		C					Drain water separator & fuel strainer	
				R			Fuel filter canister	Kubota #16631-43560
		C					Fuel pre-filter element	Kubota #15831-43380
		I					Tension of alternator drive belt	
		I					Alternator drive belt wear	
					R		Alternator drive belt	Kubota # 17480-97010
		C					Air filter (earlier check may be req'd)	
				R			Air filter element	Donaldson # P821575
					I		Valve clearances	Intake .0071"-.0086", Exhaust .0071"-.0086"
					I		Electrical systems	
					I		All nuts and bolts for tightness	
I							Leaks or engine damage	
		I					Battery	

I = Inspect C = Clean R = Replace

Notes:

- (1) Consult Engine Operators Manual for oil recommendations.
- (2) Consult Engine Operators Manual for additional maintenance schedule information.
- (3) Fill slowly! Ensure correct quantity is used.

Above operations to be carried out by trained personnel with reference to the workshop manual where necessary. These preventive maintenance periods apply to average conditions of operation. If necessary use shorter periods.

S25833

GFCI RECEPTACLE TESTING AND RESET- TING PROCEDURE

The GFCI receptacle should be properly tested at least once every month or whenever it is tripped. To properly test and reset the GFCI receptacle:

- If the receptacle has tripped, first carefully remove any load and check it for damage.
- If the equipment has been shut down, it must be restarted.
- The equipment needs to be operating at high idle speed and any necessary adjustments made on the control panel so that the equipment is providing at least 80 volts to the receptacle input terminals.
- The circuit breaker for this receptacle must not be tripped. Reset if necessary.
- Push the "Reset" button located on the GFCI receptacle. This will assure normal GFCI operation.
- Plug a night-light (with an "ON/OFF" switch) or other product (such as a lamp) into the GFCI receptacle and turn the product "ON".
- Push the "Test" button located on the GFCI receptacle. The night-light or other product should go "OFF".
- Push the "Reset" button, again. The light or other product should go "ON" again.

If the light or other product remains "ON" when the "Test" button is pushed, the GFCI is not working properly or has been incorrectly installed (miswired). If your GFCI is not working properly, contact a qualified, certified electrician who can assess the situation, rewire the GFCI if necessary or replace the device.

HOW TO USE TROUBLESHOOTING GUIDE

WARNING

Service and Repair should only be performed by Lincoln Electric Factory Trained Personnel. Unauthorized repairs performed on this equipment may result in danger to the technician and machine operator and will invalidate your factory warranty. For your safety and to avoid Electrical Shock, please observe all safety notes and precautions detailed throughout this manual.

This Troubleshooting Guide is provided to help you locate and repair possible machine malfunctions. Simply follow the three-step procedure listed below.

Step 1. LOCATE PROBLEM (SYMPTOM).

Look under the column labeled "PROBLEM (SYMPTOMS)". This column describes possible symptoms that the machine may exhibit. Find the listing that best describes the symptom that the machine is exhibiting.

Step 2. POSSIBLE CAUSE.

The second column labeled "POSSIBLE CAUSE" lists the obvious external possibilities that may contribute to the machine symptom.

Step 3. RECOMMENDED COURSE OF ACTION

This column provides a course of action for the Possible Cause, generally it states to contact your local Lincoln Authorized Field Service Facility.

If you do not understand or are unable to perform the Recommended Course of Action safely, contact your local Lincoln Authorized Field Service Facility.

CAUTION

If for any reason you do not understand the test procedures or are unable to perform the tests/repairs safely, contact your **Local Lincoln Authorized Field Service Facility** for technical troubleshooting assistance before you proceed.

Observe all Safety Guidelines detailed throughout this manual

PROBLEMS (SYMPTOMS)	POSSIBLE CAUSE	RECOMMENDED COURSE OF ACTION
Machine fails to hold the output (heat) consistently.	<ol style="list-style-type: none"> 1. Rough or dirty commutator. 2. Brushes may be worn down to Limit. 3. Field circuit may have variable resistance connection or intermittent open circuit due to loose connection or broken wire. 4. Electrode lead or work lead connection may be poor. 5. Wrong grade of brushes may have been installed on generator. 6. Field rheostat may be making poor contact and overheating. 	<p>If all recommended possible areas of misadjustment have been checked and the problem persists, Contact your local Lincoln Authorized Field Service Facility.</p>
Welder starts but fails to generate current.	<ol style="list-style-type: none"> 1. Generator or exciter brushes may be loose or missing. 2. Exciter may not be operating. 3. Field circuit of generator or exciter may be open 4. Exciter may have lost excitation. 5. Series field and armature circuit may be open-circuited. 	
Welding arc is loud and spatters excessively.	<ol style="list-style-type: none"> 1. Current setting may be too high. 2. Polarity may be wrong. 	
Welding current too great or too small compared to indication on the dial.	<ol style="list-style-type: none"> 1. Exciter output low causing low output compared to dial indication. 2. Operating speed too low or too high. 	
Arc continuously pops out.	<ol style="list-style-type: none"> 1. "Current Range Selector" switch may be set at an intermediate position. 	

 **CAUTION**

If for any reason you do not understand the test procedures or are unable to perform the tests/repairs safely, contact your **Local Lincoln Authorized Field Service Facility** for technical troubleshooting assistance before you proceed.

CLASSIC 300D KUBOTA



ELECTRONIC IDLER CONTROL TROUBLESHOOTING GUIDE

With Idler Control Switch in the AUTO Position, Engine Will Not Pick Up Speed When:

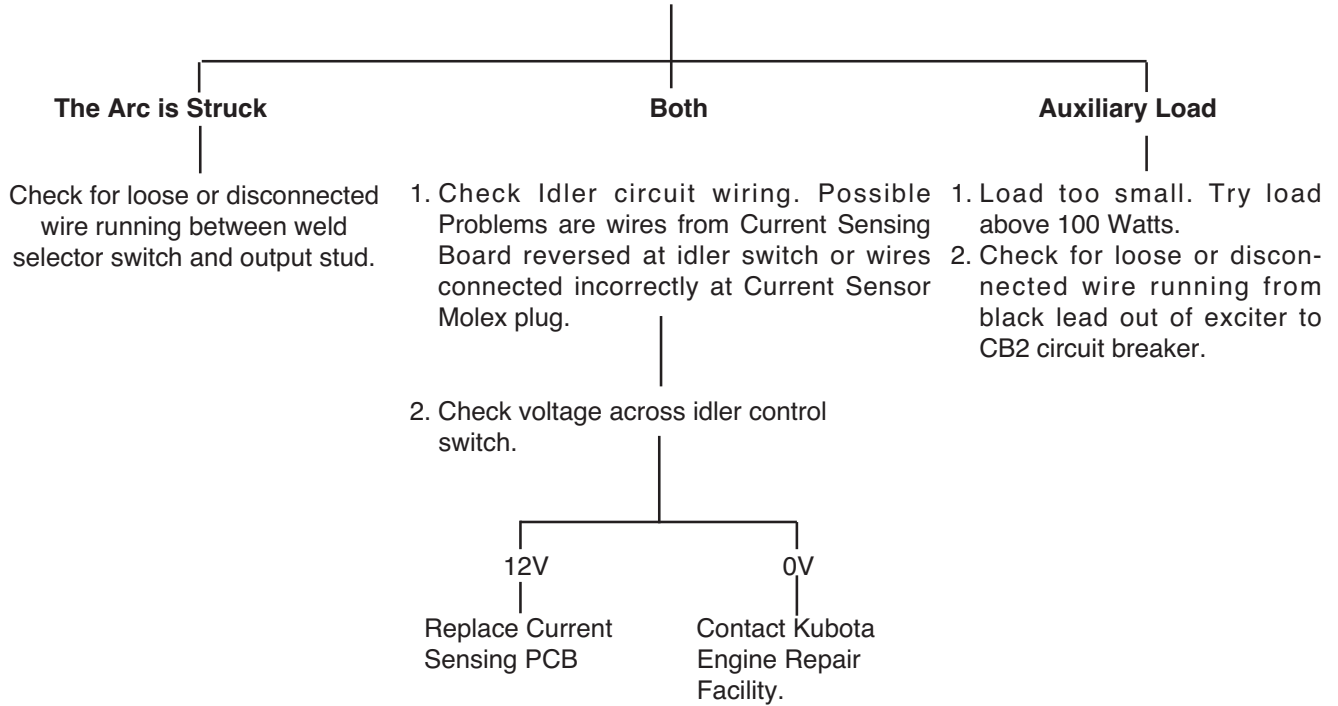

⚠ CAUTION

If for any reason you do not understand the test procedures or are unable to perform the tests/repairs safely, contact your **Local Lincoln Authorized Field Service Facility** for technical troubleshooting assistance before you proceed.

CLASSIC 300D KUBOTA



Observe all Safety Guidelines detailed throughout this manual

PROBLEMS (SYMPTOMS)	POSSIBLE CAUSE	RECOMMENDED COURSE OF ACTION
Engine does not start.	<ol style="list-style-type: none"> 1. Lack of fuel. 2. Air mixed in the fuel system. 3. Clogged fuel filter. 4. Irregular and faulty fuel supply (Injector pump trouble). 5. Glow plug not heated. 6. Clogged air cleaner. 7. No compression. 8. Engine protection light is ON. 	<p>If all recommended possible areas of misadjustment have been checked and the problem persists, Contact your local Lincoln Authorized Field Service Facility.</p>
Engine does not turn over.	<ol style="list-style-type: none"> 1. Faulty Ignition switch and or Injector pump solenoid. 2. Insufficient charging or complete discharge of the battery. 3. Improper viscosity of the lubricating oil. 	
Irregular running of the engine.	<ol style="list-style-type: none"> 1. Air mixed in the fuel system. 2. Uneven fuel injection (Faulty fuel injector pump). 3. Clogged fuel filter. 4. Defective governor. 5. Engine itself defective. 	
Engine stops during operation and the Engine Protection light does not turn on.	<ol style="list-style-type: none"> 1. Lack of fuel in the fuel tank. 2. Clogged fuel filter. 3. Air mixed in the fuel system. 4. Faulty function of the engine. 	
Engine stops during operation and the Engine Protection light does turn on.	See Light Code Diagnoses Attached.	

 **CAUTION**

If for any reason you do not understand the test procedures or are unable to perform the tests/repairs safely, contact your **Local Lincoln Authorized Field Service Facility** for technical troubleshooting assistance before you proceed.

CLASSIC 300D KUBOTA



Observe all Safety Guidelines detailed throughout this manual

LIGHT CODE	FAILURE DETECTED	POSSIBLE CAUSE - CORRECTIVE MEASURE
LONG 1, SHORT 1	RPM IS OVER 115% OF RATED RPM (2070 RPM)	ACTUATOR IS STUCK - REMOVE ACTUATOR AND VERIFY PLUNGER PULLS IN WHEN ENERGIZED
LONG 1, SHORT 2	LOW OIL PRESSURE DETECTED FOR 1 SECOND	LOW OIL - CHECK OIL LEVEL ON DIPSTICK FAULTY OIL PRESSURE SWITCH - CHECK THAT "WK" STUD IS OPEN WHEN ENGINE IS RUNNING LEAD TO OIL PRESSURE SWITCH "WK" STUD MAY BE GROUNDED - CHECK
LONG 1, SHORT 3	"L" TERMINAL IS GROUNDED ON ALTERNATOR FOR 1 SECOND	BROKEN OR LOOSE BELT LEAD TO "L" TERMINAL ON ALTERNATOR MAYBE SHORTED TO GROUND- CHECK FAULTY ALTERNATOR - CHECK
LONG 1, SHORT 4	HIGH WATER TEMPERATURE DETECTED FOR 1 SECOND	AMOUNT OR QUALITY OF COOLANT INCORRECT - CHECK FAULTY WATER TEMPERATURE SWITCH - CHECK THAT "WK" STUD IS OPEN WHEN ENGINE IS NOT RUNNING LEAD TO WATER TEMPERATURE SWITCH MAY BE GROUNDED - CHECK
LONG 1, SHORT 5	NOT ENABLED FOR LINCOLN PRODUCTS	
LONG 2, SHORT 1	0 RPM IS DETECTED AND 12V IS DETECTED FROM "L" TERMINAL ON ALTERNATOR	FAULTY RPM SENSOR-CHECK FOR GOOD CONNECTION FAULTY ECU - CHECK FOR 12 VOLTS ON SUPPLY LEAD TO RPM SENSOR FROM ECU
LONG 2, SHORT 2	CURRENT TO ACTUATOR IS OUT OF LIMIT	FAULTY ACTUATOR - CHECK FOR PROPER COIL RESISTANCE LEADS TO ACTUATOR MAY BE OPEN OR GROUNDED - CHECK
LONG 2, SHORT 3	NOT ENABLED FOR LINCOLN PRODUCTS	
LONG 2, SHORT 4	-50C WATER TEMPERATURE DETECTED	FAULTY WATER TEMPERATURE SENSOR - CHECK FOR PROPER RESISTANCE LEAD TO WATER TEMPERATURE SENSOR MAY BE OPEN - CHECK FOR CONTINUITY
LONG 2, SHORT 5	150C WATER TEMPERATURE DETECTED	FAULTY WATER TEMPERATURE SENSOR - CHECK FOR PROPER RESISTANCE LEAD TO WATER TEMPERATURE SENSOR MAY BE GROUNDED - CHECK
LONG 2, SHORT 6	0 VOLTS DETECTED FROM "L" TERMINAL ON ALTERNATOR FOR 1 SECOND	LEAD TO "L" TERMINAL ON ALTERNATOR MAY BE OPEN - CHECK FOR CONTINUITY BROKEN OR LOOSE BELT - INSPECT FAULTY ALTERNATOR - CHECK
LONG 2, SHORT 7	OVER 18 VOLTS DETECTED FROM ALTERNATOR	INCORRECT BATTERY - INSPECT FAULTY ALTERNATOR - CHECK
LONG 2, SHORT 8	LESS THAN 4 VOLTS TO RPM SENSOR AND/OR ACTUATOR SENSED BY ECU	FAULTY ECU -CHECK FOR 12 VOLTS ON LEADS TO RPM SENSOR AND ACTUATOR FROM ECU

 **CAUTION**

If for any reason you do not understand the test procedures or are unable to perform the tests/repairs safely, contact your **Local Lincoln Authorized Field Service Facility** for technical troubleshooting assistance before you proceed.

CLASSIC 300D KUBOTA



Observe all Safety Guidelines detailed throughout this manual

PROBLEMS (SYMPTOMS)	POSSIBLE CAUSE	RECOMMENDED COURSE OF ACTION
White or Blue Smoke.	<ol style="list-style-type: none"> 1. Excess engine oil. 2. Too low viscosity of the engine oil. 3. Faulty injection timing. 	<p>If all recommended possible areas of misadjustment have been checked and the problem persists, Contact your local Lincoln Authorized Field Service Facility.</p>
Dark Grey Smoke.	<ol style="list-style-type: none"> 1. Unsuitable fuel. 2. Excess injection. 3. Faulty function of the engine. 4. Overloading. 5. Clogged air cleaner. 	
Faulty Charging.	<ol style="list-style-type: none"> 1. Loose fan belt. 2. Faulty wiring. 3. Faulty battery. 4. Worn out alternator brush. 	
Starter Motor does not run.	<ol style="list-style-type: none"> 1. Loose or damaged wiring. 2. Drained voltage from battery. 3. Damaged starter motor (including solenoid). 	
Engine Protection Light not coming on.	<ol style="list-style-type: none"> 1. Broken Light Bulb. 2. Faulty light wiring. 3. Faulty Engine Control Unit. 	
No auxiliary power.	<ol style="list-style-type: none"> 1. GFCI Receptacle may have tripped. Follow "GFCI Receptacle Testing and Resetting Procedure" in the MAINTENANCE section of this manual. 2. Open breakers may need to be reset. 3. Faulty receptacle. 4. Faulty auxiliary circuit wiring. 	

 **CAUTION**

If for any reason you do not understand the test procedures or are unable to perform the tests/repairs safely, contact your **Local Lincoln Authorized Field Service Facility** for technical troubleshooting assistance before you proceed.

CLASSIC 300D KUBOTA



CLASSIC 300D KUBOTA WIRING DIAGRAM FOR CODES 11112, 11113

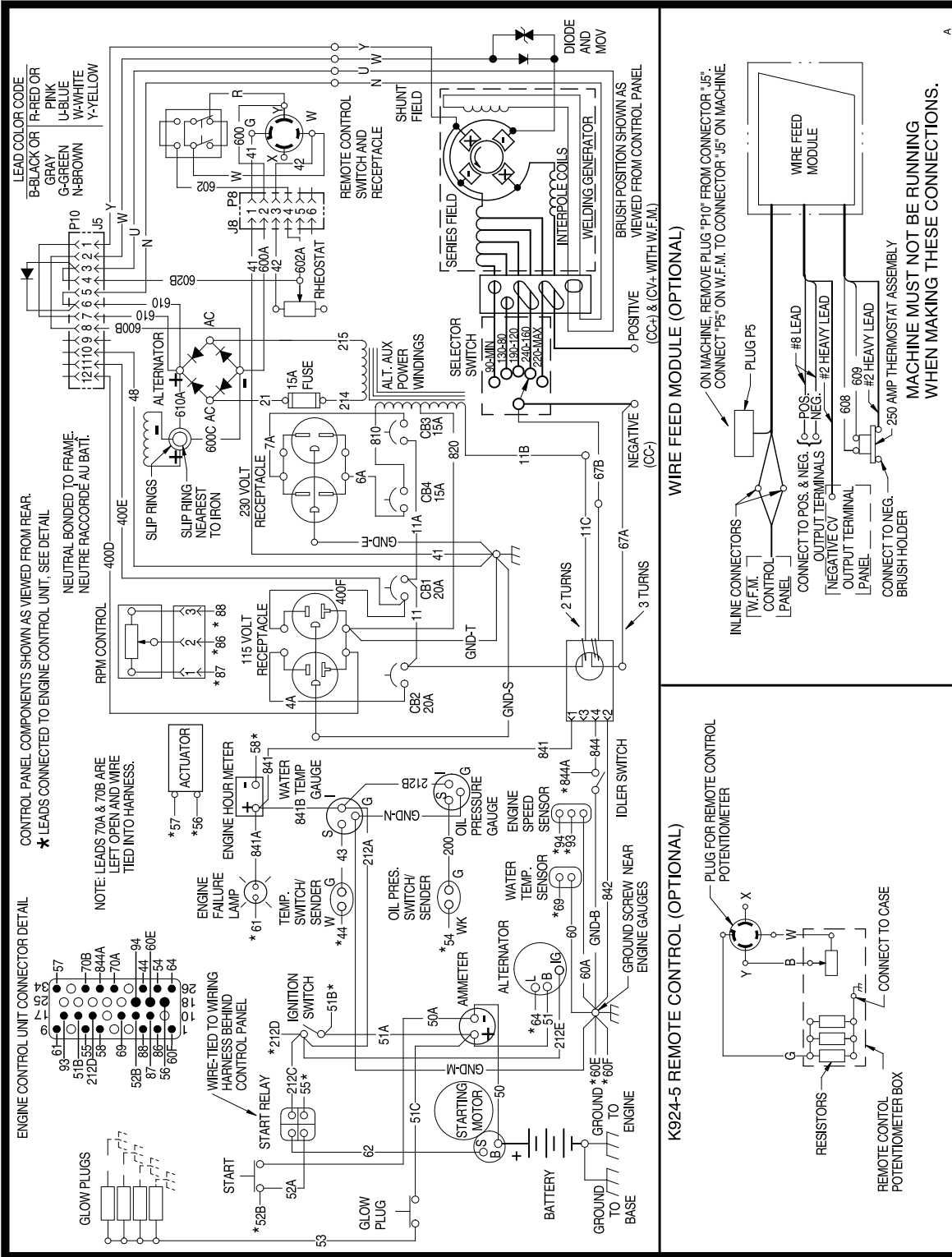

NOTE: This diagram is for reference only. It may not be accurate for all machines covered by this manual. The specific diagram for a particular code is pasted inside the machine on one of the enclosure panels. If the diagram is illegible, write to the Service Department for a replacement. Give the equipment code number.

CLASSIC 300D KUBOTA WIRING DIAGRAM FOR CODES 11243, 11244

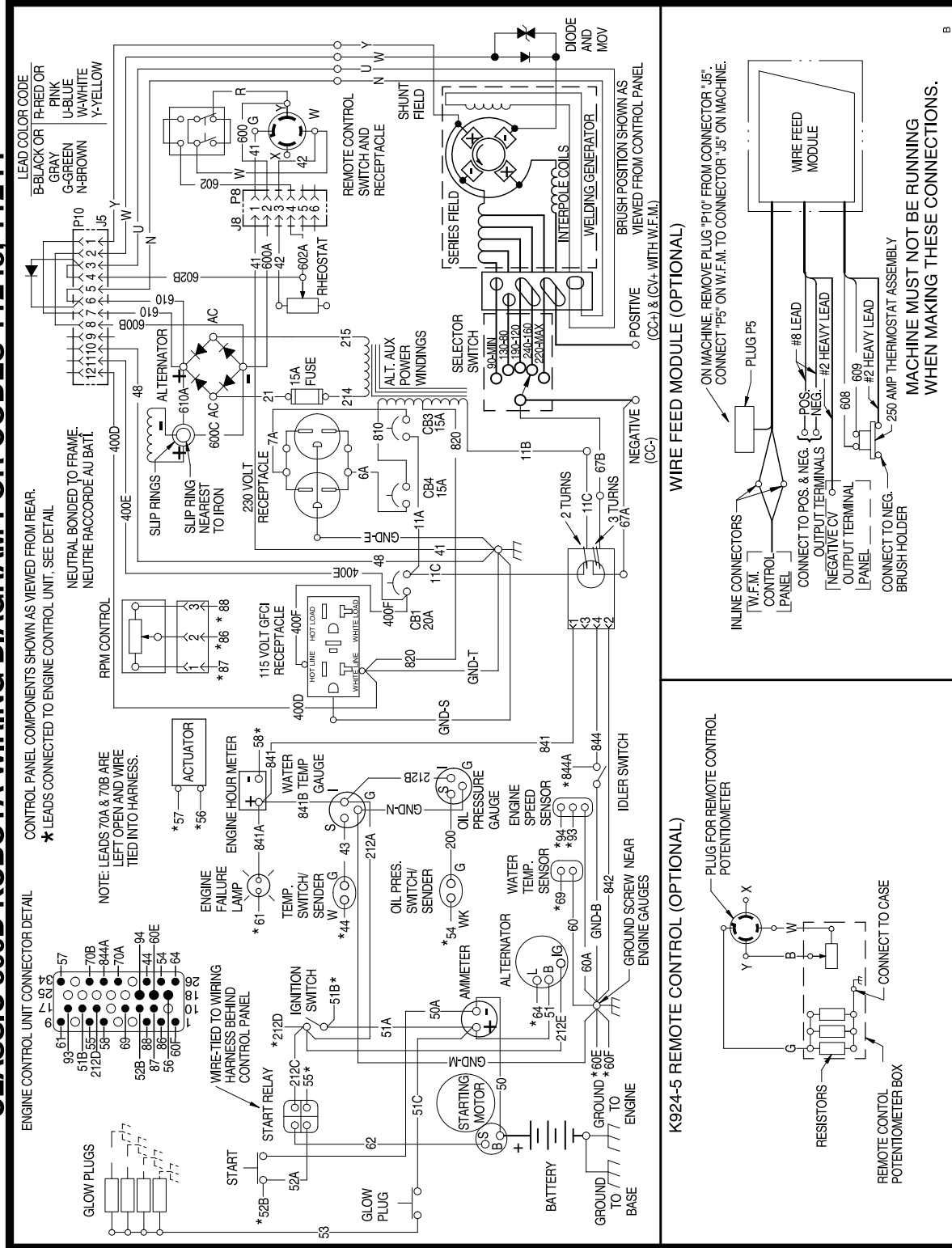

M20432-1

NOTE: This diagram is for reference only. It may not be accurate for all machines covered by this manual. The specific diagram for a particular code is pasted inside the machine on one of the enclosure panels. If the diagram is illegible, write to the Service Department for a replacement. Give the equipment code number.

K2464-1 REMOTE CONTROL WIRING / CONNECTION DIAGRAM

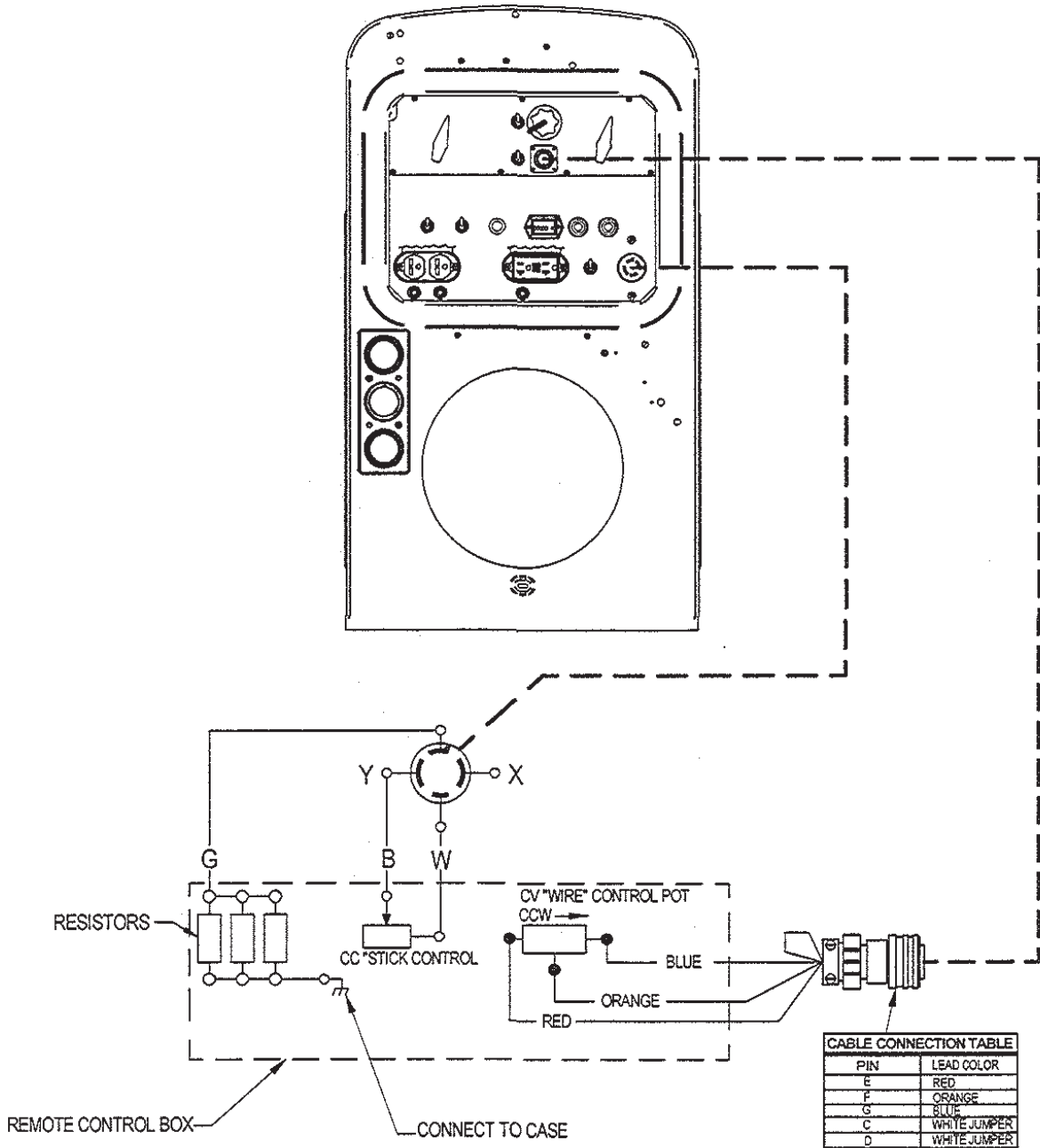

A
S26097

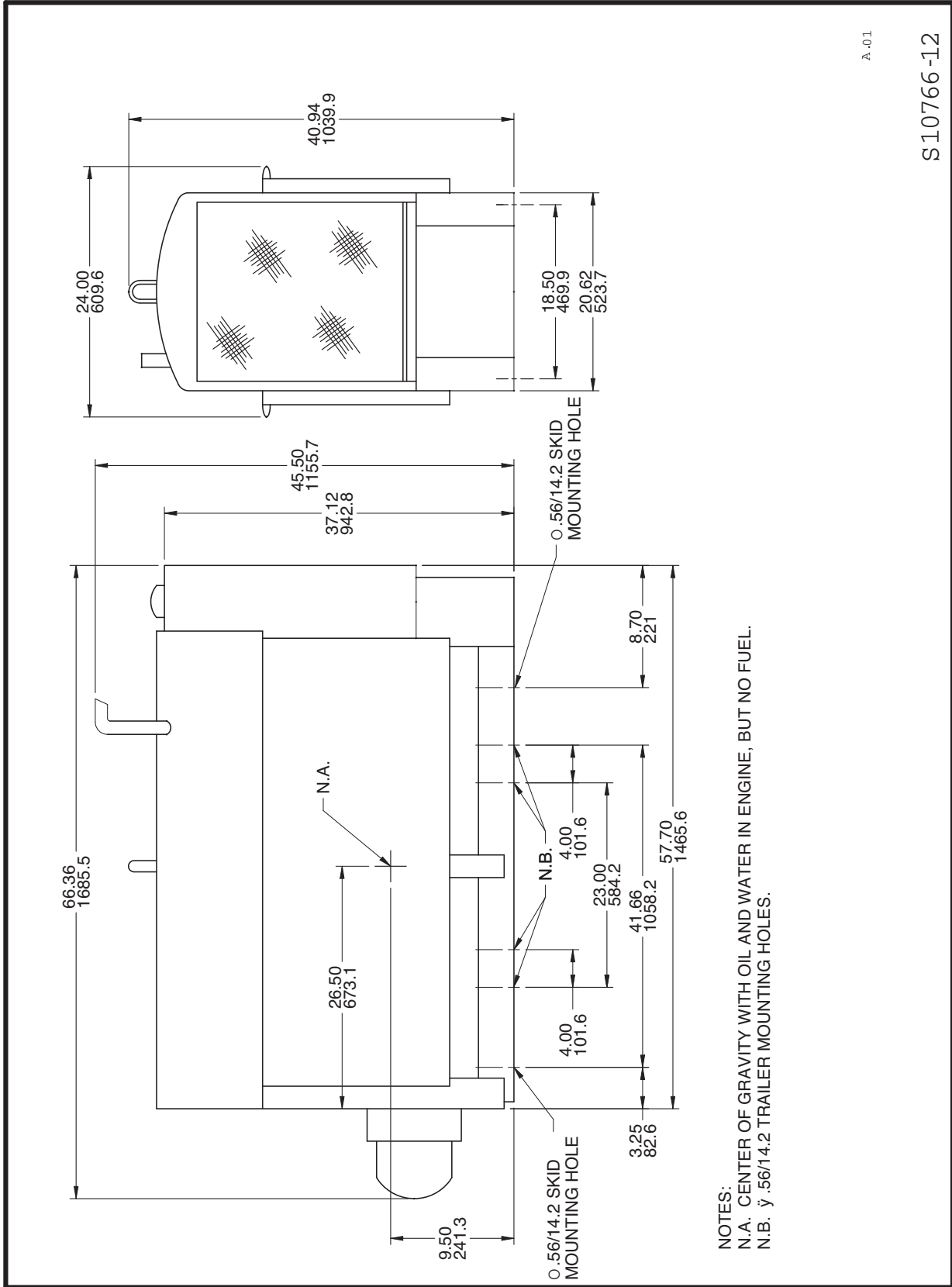

NOTE: This diagram is for reference only. It may not be accurate for all machines covered by this manual. The specific diagram for a particular code is pasted inside the machine on one of the enclosure panels. If the diagram is illegible, write to the Service Department for a replacement. Give the equipment code number.

			
WARNING	<ul style="list-style-type: none"> Do not touch electrically live parts or electrode with skin or wet clothing. Insulate yourself from work and ground. 	<ul style="list-style-type: none"> Keep flammable materials away. 	<ul style="list-style-type: none"> Wear eye, ear and body protection.
Spanish AVISO DE PRECAUCION	<ul style="list-style-type: none"> No toque las partes o los electrodos bajo carga con la piel o ropa mojada. Aislese del trabajo y de la tierra. 	<ul style="list-style-type: none"> Mantenga el material combustible fuera del área de trabajo. 	<ul style="list-style-type: none"> Protégase los ojos, los oídos y el cuerpo.
French ATTENTION	<ul style="list-style-type: none"> Ne laissez ni la peau ni des vêtements mouillés entrer en contact avec des pièces sous tension. Isolez-vous du travail et de la terre. 	<ul style="list-style-type: none"> Gardez à l'écart de tout matériel inflammable. 	<ul style="list-style-type: none"> Protégez vos yeux, vos oreilles et votre corps.
German WARNUNG	<ul style="list-style-type: none"> Berühren Sie keine stromführenden Teile oder Elektroden mit Ihrem Körper oder feuchter Kleidung! Isolieren Sie sich von den Elektroden und dem Erdboden! 	<ul style="list-style-type: none"> Entfernen Sie brennbares Material! 	<ul style="list-style-type: none"> Tragen Sie Augen-, Ohren- und Körperschutz!
Portuguese ATENÇÃO	<ul style="list-style-type: none"> Não toque partes elétricas e electrodos com a pele ou roupa molhada. Isole-se da peça e terra. 	<ul style="list-style-type: none"> Mantenha inflamáveis bem guardados. 	<ul style="list-style-type: none"> Use proteção para a vista, ouvido e corpo.
Japanese 注意事項	<ul style="list-style-type: none"> 通電中の電気部品、又は溶材にヒフやぬれた布で触れないこと。 施工物やアースから身体が絶縁されている様にして下さい。 	<ul style="list-style-type: none"> 燃えやすいものの側での溶接作業は絶対にしてはなりません。 	<ul style="list-style-type: none"> 目、耳及び身体に保護具をして下さい。
Chinese 警告	<ul style="list-style-type: none"> 皮肤或湿衣物切勿接触带电部件及焊缝。 使你自已与地面和工件绝缘。 	<ul style="list-style-type: none"> 把一切易燃物品移离工作场所。 	<ul style="list-style-type: none"> 佩戴眼、耳及身体劳动保护用具。
Korean 위험	<ul style="list-style-type: none"> 전도체나 용접봉을 젖은 헝겍 또는 피부로 절대 접촉처 마십시오. 모재와 접지를 접촉처 마십시오. 	<ul style="list-style-type: none"> 인화성 물질을 접근 시키지 마십시오. 	<ul style="list-style-type: none"> 눈, 귀와 몸에 보호장구를 착용하십시오.
Arabic تحذير	<ul style="list-style-type: none"> لا تلمس الأجزاء التي يسري فيها التيار الكهربائي أو الإلكترود بجلد الجسم أو بالملايس المبللة بالماء. ضع عازلا على جسمك خلال العمل. 	<ul style="list-style-type: none"> ضع المواد القابلة للاشتعال في مكان بعيد. 	<ul style="list-style-type: none"> ضع أدوات وملابس واقية على عينيك وأذنيك وجسمك.

READ AND UNDERSTAND THE MANUFACTURER'S INSTRUCTION FOR THIS EQUIPMENT AND THE CONSUMABLES TO BE USED AND FOLLOW YOUR EMPLOYER'S SAFETY PRACTICES.

SE RECOMIENDA LEER Y ENTENDER LAS INSTRUCCIONES DEL FABRICANTE PARA EL USO DE ESTE EQUIPO Y LOS CONSUMIBLES QUE VA A UTILIZAR, SIGA LAS MEDIDAS DE SEGURIDAD DE SU SUPERVISOR.

LISEZ ET COMPRENEZ LES INSTRUCTIONS DU FABRICANT EN CE QUI REGARDE CET EQUIPMENT ET LES PRODUITS A ETRE EMPLOYES ET SUIVEZ LES PROCEDURES DE SECURITE DE VOTRE EMPLOYEUR.

LESEN SIE UND BEFOLGEN SIE DIE BETRIEBSANLEITUNG DER ANLAGE UND DEN ELEKTRODENEINSATZ DES HERSTELLERS. DIE UNFALLVERHÜTUNGSVORSCHRIFTEN DES ARBEITGEBERS SIND EBENFALLS ZU BEACHTEN.

			
<ul style="list-style-type: none"> ● Keep your head out of fumes. ● Use ventilation or exhaust to remove fumes from breathing zone. 	<ul style="list-style-type: none"> ● Turn power off before servicing. 	<ul style="list-style-type: none"> ● Do not operate with panel open or guards off. 	WARNING
<ul style="list-style-type: none"> ● Los humos fuera de la zona de respiración. ● Mantenga la cabeza fuera de los humos. Utilice ventilación o aspiración para gases. 	<ul style="list-style-type: none"> ● Desconectar el cable de alimentación de poder de la máquina antes de iniciar cualquier servicio. 	<ul style="list-style-type: none"> ● No operar con panel abierto o guardas quitadas. 	Spanish AVISO DE PRECAUCION
<ul style="list-style-type: none"> ● Gardez la tête à l'écart des fumées. ● Utilisez un ventilateur ou un aspirateur pour ôter les fumées des zones de travail. 	<ul style="list-style-type: none"> ● Débranchez le courant avant l'entretien. 	<ul style="list-style-type: none"> ● N'opérez pas avec les panneaux ouverts ou avec les dispositifs de protection enlevés. 	French ATTENTION
<ul style="list-style-type: none"> ● Vermeiden Sie das Einatmen von Schweißrauch! ● Sorgen Sie für gute Be- und Entlüftung des Arbeitsplatzes! 	<ul style="list-style-type: none"> ● Strom vor Wartungsarbeiten abschalten! (Netzstrom völlig öffnen; Maschine anhalten!) 	<ul style="list-style-type: none"> ● Anlage nie ohne Schutzgehäuse oder Innenschutzverkleidung in Betrieb setzen! 	German WARNUNG
<ul style="list-style-type: none"> ● Mantenha seu rosto da fumaça. ● Use ventilação e exaustão para remover fumo da zona respiratória. 	<ul style="list-style-type: none"> ● Não opere com as tampas removidas. ● Desligue a corrente antes de fazer serviço. ● Não toque as partes elétricas nuas. 	<ul style="list-style-type: none"> ● Mantenha-se afastado das partes moventes. ● Não opere com os painéis abertos ou guardas removidas. 	Portuguese ATENÇÃO
<ul style="list-style-type: none"> ● ヒュームから頭を離すようにして下さい。 ● 換気や排煙に十分留意して下さい。 	<ul style="list-style-type: none"> ● メンテナンス・サービスに取りかかる際には、まず電源スイッチを必ず切って下さい。 	<ul style="list-style-type: none"> ● パネルやカバーを取り外したまま機械操作をしないで下さい。 	Japanese 注意事項
<ul style="list-style-type: none"> ● 頭部遠離煙霧。 ● 在呼吸區使用通風或排風器除煙。 	<ul style="list-style-type: none"> ● 維修前切斷電源。 	<ul style="list-style-type: none"> ● 儀表板打開或沒有安全罩時不準作業。 	Chinese 警告
<ul style="list-style-type: none"> ● 얼굴로부터 용접가스를 멀리하십시오. ● 호흡지역으로부터 용접가스를 제거하기 위해 가스제거기나 통풍기를 사용하십시오. 	<ul style="list-style-type: none"> ● 보수전에 전원을 차단하십시오. 	<ul style="list-style-type: none"> ● 패널이 열린 상태로 작동치 마십시오. 	Korean 위험
<ul style="list-style-type: none"> ● ابعء رأسك بعيداً عن الدخان. ● استعمل التهوية أو جهاز ضغط الدخان للخارج لكي تبعد الدخان عن المنطقة التي تتنفس فيها. 	<ul style="list-style-type: none"> ● أقطع التيار الكهربائي قبل القيام بأية صيانة. 	<ul style="list-style-type: none"> ● لا تشغيل هذا الجهاز إذا كانت الإغطية الحديدية الواقية ليست عليه. 	Arabic تحذير

LEIA E COMPREENDA AS INSTRUÇÕES DO FABRICANTE PARA ESTE EQUIPAMENTO E AS PARTES DE USO, E SIGA AS PRÁTICAS DE SEGURANÇA DO EMPREGADOR.

使う機械や溶材のメーカーの指示書をよく読み、まず理解して下さい。そして貴社の安全規定に従って下さい。

請詳細閱讀並理解製造廠提供的說明以及應該使用的銀焊材料，並請遵守貴方的有關勞動保護規定。

이 제품에 동봉된 작업지침서를 숙지하시고 귀사의 작업자 안전수칙을 준수하시기 바랍니다.

اقرأ بتمعن وافهم تعليمات المصنع المنتج لهذه المعدات والمواد قبل استعمالها واتبع تعليمات الوقاية لصاحب العمل.



• World's Leader in Welding and Cutting Products •

• Sales and Service through Subsidiaries and Distributors Worldwide •

Cleveland, Ohio 44117-1199 U.S.A. TEL: 216.481.8100 FAX: 216.486.1751 WEB SITE: www.lincolnelectric.com