

For use with machines Code 10256 and 10257.

### Safety Depends on You

Lincoln arc welding and cutting equipment is designed and built with safety in mind. However, your overall safety can be increased by proper installation ... and thoughtful operation on your part. **DO NOT INSTALL, OPERATE OR REPAIR THIS EQUIPMENT WITHOUT READING THIS MANUAL AND THE SAFETY PRECAUTIONS CONTAINED THROUGHOUT.** And, most importantly, think before you act and be careful.

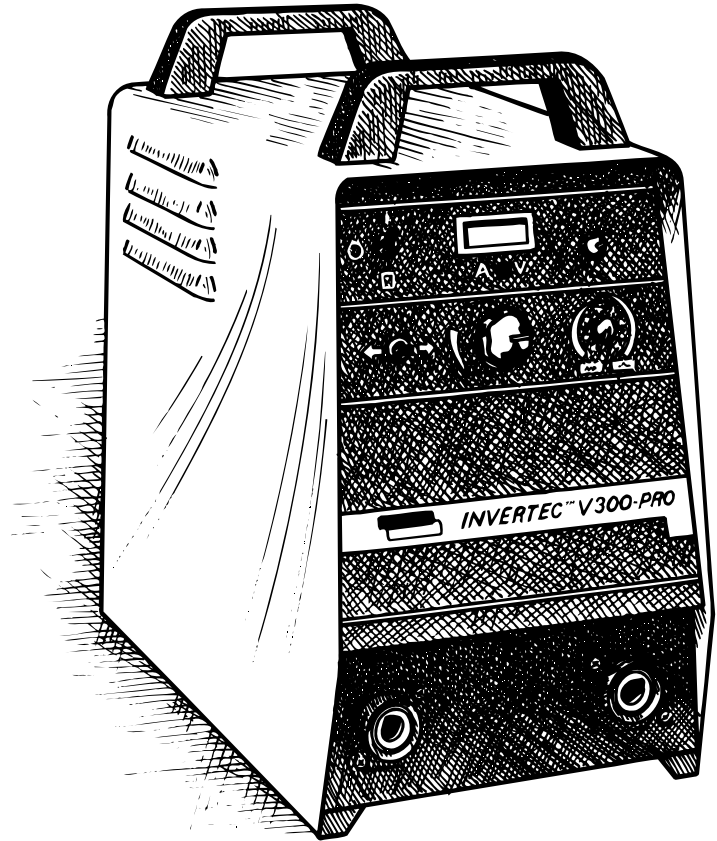

Date of Purchase: \_\_\_\_\_

Serial Number: \_\_\_\_\_

Code Number: \_\_\_\_\_

Model: \_\_\_\_\_

Where Purchased: \_\_\_\_\_

## OPERATOR'S MANUAL



• World's Leader in Welding and Cutting Products •

• Sales and Service through Subsidiaries and Distributors Worldwide •

Cleveland, Ohio 44117-1199 U.S.A. TEL: 216.481.8100 FAX: 216.486.1751 WEB SITE: [www.lincolnelectric.com](http://www.lincolnelectric.com)



## WARNING

**ARC WELDING can be hazardous.**

**PROTECT YOURSELF AND OTHERS FROM POSSIBLE SERIOUS INJURY OR DEATH. KEEP CHILDREN AWAY. PACEMAKER WEARERS SHOULD CONSULT WITH THEIR DOCTOR BEFORE OPERATING.**

Read and understand the following safety highlights. For additional safety information it is strongly recommended that you purchase a copy of "Safety in Welding & Cutting - ANSI Standard Z49.1" from the American Welding Society, P.O. Box 351040, Miami, Florida 33135 or CSA Standard W117.2-1974. A **Free** copy of "Arc Welding Safety" booklet E205 is available from the Lincoln Electric Company, 22801 St. Clair Avenue, Cleveland, Ohio 44117-1199.

**BE SURE THAT ALL INSTALLATION, OPERATION, MAINTENANCE, AND REPAIR PROCEDURES ARE PERFORMED ONLY BY QUALIFIED INDIVIDUALS.**



### **ELECTRIC SHOCK can kill.**

- 1.a. The electrode and work (or ground) circuits are electrically "hot" when the welder is on. Do not touch these "hot" parts with your bare skin or wet clothing. Wear dry, hole-free gloves to insulate hands.
- 1.b. Insulate yourself from work and ground using dry insulation. Make certain the insulation is large enough to cover your full area of physical contact with work and ground.
 

**In addition to the normal safety precautions, if welding must be performed under electrically hazardous conditions (in damp locations or while wearing wet clothing; on metal structures such as floors, gratings or scaffolds; when in cramped positions such as sitting, kneeling or lying, if there is a high risk of unavoidable or accidental contact with the workpiece or ground) use the following equipment:**

  - **Semiautomatic DC Constant Voltage (Wire) Welder.**
  - **DC Manual (Stick) Welder.**
  - **AC Welder with Reduced Voltage Control.**
- 1.c. In semiautomatic or automatic wire welding, the electrode, electrode reel, welding head, nozzle or semiautomatic welding gun are also electrically "hot".
- 1.d. Always be sure the work cable makes a good electrical connection with the metal being welded. The connection should be as close as possible to the area being welded.
- 1.e. Ground the work or metal to be welded to a good electrical (earth) ground.
- 1.f. Maintain the electrode holder, work clamp, welding cable and welding machine in good, safe operating condition. Replace damaged insulation.
- 1.g. Never dip the electrode in water for cooling.
- 1.h. Never simultaneously touch electrically "hot" parts of electrode holders connected to two welders because voltage between the two can be the total of the open circuit voltage of both welders.
- 1.i. When working above floor level, use a safety belt to protect yourself from a fall should you get a shock.
- 1.j. Also see Items 4.c. and 6.

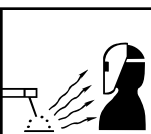

### **ARC RAYS can burn.**

- 2.a. Use a shield with the proper filter and cover plates to protect your eyes from sparks and the rays of the arc when welding or observing open arc welding. Headshield and filter lens should conform to ANSI Z87.1 standards.
- 2.b. Use suitable clothing made from durable flame-resistant material to protect your skin and that of your helpers from the arc rays.
- 2.c. Protect other nearby personnel with suitable non-flammable screening and/or warn them not to watch the arc nor expose themselves to the arc rays or to hot spatter or metal.



### **FUMES AND GASES can be dangerous.**

- 3.a. Welding may produce fumes and gases hazardous to health. Avoid breathing these fumes and gases. When welding, keep your head out of the fume. Use enough ventilation and/or exhaust at the arc to keep fumes and gases away from the breathing zone. **When welding with electrodes which require special ventilation such as stainless or hard facing (see instructions on container or MSDS) or on lead or cadmium plated steel and other metals or coatings which produce highly toxic fumes, keep exposure as low as possible and below Threshold Limit Values (TLV) using local exhaust or mechanical ventilation. In confined spaces or in some circumstances, outdoors, a respirator may be required. Additional precautions are also required when welding on galvanized steel.**
  - 3.b. Do not weld in locations near chlorinated hydrocarbon vapors coming from degreasing, cleaning or spraying operations. The heat and rays of the arc can react with solvent vapors to form phosgene, a highly toxic gas, and other irritating products.
  - 3.c. Shielding gases used for arc welding can displace air and cause injury or death. Always use enough ventilation, especially in confined areas, to insure breathing air is safe.
  - 3.d. Read and understand the manufacturer's instructions for this equipment and the consumables to be used, including the material safety data sheet (MSDS) and follow your employer's safety practices. MSDS forms are available from your welding distributor or from the manufacturer.
  - 3.e. Also see item 7b.

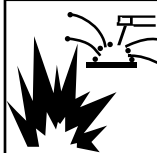

### **WELDING SPARKS can cause fire or explosion.**

- 4.a. Remove fire hazards from the welding area. If this is not possible, cover them to prevent the welding sparks from starting a fire. Remember that welding sparks and hot materials from welding can easily go through small cracks and openings to adjacent areas. Avoid welding near hydraulic lines. Have a fire extinguisher readily available.
- 4.b. Where compressed gases are to be used at the job site, special precautions should be used to prevent hazardous situations. Refer to "Safety in Welding and Cutting" (ANSI Standard Z49.1) and the operating information for the equipment being used.
- 4.c. When not welding, make certain no part of the electrode circuit is touching the work or ground. Accidental contact can cause overheating and create a fire hazard.
- 4.d. Do not heat, cut or weld tanks, drums or containers until the proper steps have been taken to insure that such procedures will not cause flammable or toxic vapors from substances inside. They can cause an explosion even though they have been "cleaned." For information purchase "Recommended Safe Practices for the Preparation for Welding and Cutting of Containers and Piping That Have Held Hazardous Substances", AWS F4.1 from the American Welding Society (see address above).
- 4.e. Vent hollow castings or containers before heating, cutting or welding. They may explode.

4.f. Sparks and spatter are thrown from the welding arc. Wear oil free protective garments such as leather gloves, heavy shirt, cuffless trousers, high shoes and a cap over your hair. Wear ear plugs when welding out of position or in confined places. Always wear safety glasses with side shields when in a welding area.

4.g. Connect the work cable to the work as close to the welding area as practical. Work cables connected to the building framework or other locations away from the welding area increase the possibility of the welding current passing through lifting chains, crane cables or other alternate circuits. This can create fire hazards or overheat lifting chains or cables until they fail.

4.h. Also see item 7c.

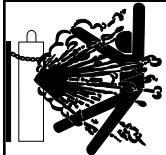

### **CYLINDER may explode if damaged.**

5.a. Use only compressed gas cylinders containing the correct shielding gas for the process used and properly operating regulators designed for the gas and pressure used. All hoses, fittings, etc. should be suitable for the application and maintained in good condition.

5.b. Always keep cylinders in an upright position securely chained to an undercarriage or fixed support.

5.c. Cylinders should be located:

- Away from areas where they may be struck or subjected to physical damage.
- A safe distance from arc welding or cutting operations and any other source of heat, sparks, or flame.

5.d. Never allow the electrode, electrode holder or any other electrically "hot" parts to touch a cylinder.

5.e. Keep your head and face away from the cylinder valve outlet when opening the cylinder valve.

5.f. Valve protection caps should always be in place and hand tight except when the cylinder is in use or connected for use.

5.g. Read and follow the instructions on compressed gas cylinders, associated equipment, and CGA publication P-1, "Precautions for Safe Handling of Compressed Gases in Cylinders," available from the Compressed Gas Association 1235 Jefferson Davis Highway, Arlington, VA 22202.



### **FOR ELECTRICALLY powered equipment.**

6.a. Turn off input power using the disconnect switch at the fuse box before working on the equipment.

6.b. Install equipment in accordance with the U.S. National Electrical Code, all local codes and the manufacturer's recommendations.

6.c. Ground the equipment in accordance with the U.S. National Electrical Code and the manufacturer's recommendations.



### **FOR ENGINE powered equipment.**

7.a. Turn the engine off before troubleshooting and maintenance work unless the maintenance work requires it to be running.



7.b. Operate engines in open, well-ventilated areas or vent the engine exhaust fumes outdoors.



7.c. Do not add the fuel near an open flame welding arc or when the engine is running. Stop the engine and allow it to cool before refueling to prevent spilled fuel from vaporizing on contact with hot engine parts and igniting. Do not spill fuel when filling tank. If fuel is spilled, wipe it up and do not start engine until fumes have been eliminated.



7.d. Keep all equipment safety guards, covers and devices in position and in good repair. Keep hands, hair, clothing and tools away from V-belts, gears, fans and all other moving parts when starting, operating or repairing equipment.

7.e. In some cases it may be necessary to remove safety guards to perform required maintenance. Remove guards only when necessary and replace them when the maintenance requiring their removal is complete. Always use the greatest care when working near moving parts.

7.f. Do not put your hands near the engine fan. Do not attempt to override the governor or idler by pushing on the throttle control rods while the engine is running.

7.g. To prevent accidentally starting gasoline engines while turning the engine or welding generator during maintenance work, disconnect the spark plug wires, distributor cap or magneto wire as appropriate.

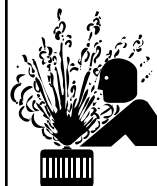

7.h. To avoid scalding, do not remove the radiator pressure cap when the engine is hot.



### **ELECTRIC AND MAGNETIC FIELDS may be dangerous**

8.a. Electric current flowing through any conductor causes localized Electric and Magnetic Fields (EMF). Welding current creates EMF fields around welding cables and welding machines.

8.b. EMF fields may interfere with some pacemakers, and welders having a pacemaker should consult their physician before welding.

8.c. Exposure to EMF fields in welding may have other health effects which are now not known.

8.d. All welders should use the following procedures in order to minimize exposure to EMF fields from the welding circuit:

8.d.1. Route the electrode and work cables together - Secure them with tape when possible.

8.d.2. Never coil the electrode lead around your body.

8.d.3. Do not place your body between the electrode and work cables. If the electrode cable is on your right side, the work cable should also be on your right side.

8.d.4. Connect the work cable to the workpiece as close as possible to the area being welded.

8.d.5. Do not work next to welding power source.

## PRÉCAUTIONS DE SÛRETÉ

Pour votre propre protection lire et observer toutes les instructions et les précautions de sûreté spécifiques qui paraissent dans ce manuel aussi bien que les précautions de sûreté générales suivantes:

### Sûreté Pour Soudage A L'Arc

1. Protégez-vous contre la secousse électrique:
  - a. Les circuits à l'électrode et à la pièce sont sous tension quand la machine à souder est en marche. Éviter toujours tout contact entre les parties sous tension et la peau nue ou les vêtements mouillés. Porter des gants secs et sans trous pour isoler les mains.
  - b. Faire très attention de bien s'isoler de la masse quand on soude dans des endroits humides, ou sur un plancher métallique ou des grilles métalliques, principalement dans les positions assis ou couché pour lesquelles une grande partie du corps peut être en contact avec la masse.
  - c. Maintenir le porte-électrode, la pince de masse, le câble de soudage et la machine à souder en bon et sûr état de fonctionnement.
  - d. Ne jamais plonger le porte-électrode dans l'eau pour le refroidir.
  - e. Ne jamais toucher simultanément les parties sous tension des porte-électrodes connectés à deux machines à souder parce que la tension entre les deux pinces peut être le total de la tension à vide des deux machines.
  - f. Si on utilise la machine à souder comme une source de courant pour soudage semi-automatique, ces précautions pour le porte-électrode s'appliquent aussi au pistolet de soudage.
2. Dans le cas de travail au dessus du niveau du sol, se protéger contre les chutes dans le cas où on recoit un choc. Ne jamais enrouler le câble-électrode autour de n'importe quelle partie du corps.
3. Un coup d'arc peut être plus sévère qu'un coup de soleil, donc:
  - a. Utiliser un bon masque avec un verre filtrant approprié ainsi qu'un verre blanc afin de se protéger les yeux du rayonnement de l'arc et des projections quand on soude ou quand on regarde l'arc.
  - b. Porter des vêtements convenables afin de protéger la peau de soudeur et des aides contre le rayonnement de l'arc.
  - c. Protéger l'autre personnel travaillant à proximité au soudage à l'aide d'écrans appropriés et non-inflammables.
4. Des gouttes de laitier en fusion sont émises de l'arc de soudage. Se protéger avec des vêtements de protection libres de l'huile, tels que les gants en cuir, chemise épaisse, pantalons sans revers, et chaussures montantes.
5. Toujours porter des lunettes de sécurité dans la zone de soudage. Utiliser des lunettes avec écrans latéraux dans les

zones où l'on pique le laitier.

6. Eloigner les matériaux inflammables ou les recouvrir afin de prévenir tout risque d'incendie dû aux étincelles.
7. Quand on ne soude pas, poser la pince à un endroit isolé de la masse. Un court-circuit accidentel peut provoquer un échauffement et un risque d'incendie.
8. S'assurer que la masse est connectée le plus près possible de la zone de travail qu'il est pratique de le faire. Si on place la masse sur la charpente de la construction ou d'autres endroits éloignés de la zone de travail, on augmente le risque de voir passer le courant de soudage par les chaînes de levage, câbles de grue, ou autres circuits. Cela peut provoquer des risques d'incendie ou d'échauffement des chaînes et des câbles jusqu'à ce qu'ils se rompent.
9. Assurer une ventilation suffisante dans la zone de soudage. Ceci est particulièrement important pour le soudage de tôles galvanisées plombées, ou cadmiées ou tout autre métal qui produit des fumées toxiques.
10. Ne pas souder en présence de vapeurs de chlore provenant d'opérations de dégraissage, nettoyage ou pistolage. La chaleur ou les rayons de l'arc peuvent réagir avec les vapeurs du solvant pour produire du phosgène (gas fortement toxique) ou autres produits irritants.
11. Pour obtenir de plus amples renseignements sur la sûreté, voir le code "Code for safety in welding and cutting" CSA Standard W 117.2-1974.

## PRÉCAUTIONS DE SÛRETÉ POUR LES MACHINES À SOUDER À TRANSFORMATEUR ET À REDRESSEUR

1. Relier à la terre le chassis du poste conformément au code de l'électricité et aux recommandations du fabricant. Le dispositif de montage ou la pièce à souder doit être branché à une bonne mise à la terre.
2. Autant que possible, l'installation et l'entretien du poste seront effectués par un électricien qualifié.
3. Avant de faire des travaux à l'intérieur de poste, la débrancher à l'interrupteur à la boîte de fusibles.
4. Garder tous les couvercles et dispositifs de sûreté à leur place.

# TABLE OF CONTENTS

	Page
Safety Precautions .....	2-4
Introductory Information .....	6
Product Description.....	7
Specifications .....	7
Installation .....	7-10
Safety Precautions .....	7
Location .....	7
Electrical Installation.....	7
Input Voltage Setup.....	8
Power Cord Connection .....	8
Connection of Wire Feeders to Invertec .....	8-10
Output Cables & Plugs .....	10
Operating Instructions .....	11-13
Safety Precautions .....	11
Controls Description and Function.....	11-13
Maintenance .....	13-14
Capacitor Discharge Procedure .....	13
Routine Maintenance.....	13
Periodic Maintenance .....	14
Troubleshooting Guide .....	14-20
Matched Parts .....	20
Switch P.C. Board Replacement Procedure .....	20
Replacement of Power Modules and Output Diodes .....	20-21
Connection Diagrams .....	22-31
Wiring Diagrams .....	32-33
Parts Lists .....	appendix

# Thank You

for selecting a **QUALITY** product by Lincoln Electric. We want you to take pride in operating this Lincoln Electric Company product  
••• as much pride as we have in bringing this product to you!

### **Please Examine Carton and Equipment For Damage Immediately**

When this equipment is shipped, title passes to the purchaser upon receipt by the carrier. Consequently, Claims for material damaged in shipment must be made by the purchaser against the transportation company at the time the shipment is received.

Please record your equipment identification information below for future reference. This information can be found on your machine nameplate.

Model Name & Number \_\_\_\_\_

Code & Serial Number \_\_\_\_\_

Date of Purchase \_\_\_\_\_

Whenever you request replacement parts for or information on this equipment always supply the information you have recorded above.

**Read this Operators Manual completely** before attempting to use this equipment. Save this manual and keep it handy for quick reference. Pay particular attention to the safety instructions we have provided for your protection. The level of seriousness to be applied to each is explained below:

### **⚠ WARNING**

This statement appears where the information **must** be followed **exactly** to avoid **serious personal injury** or **loss of life**.

### **⚠ CAUTION**

This statement appears where the information **must** be followed to avoid **minor personal injury** or **damage to this equipment**.

## PRODUCT DESCRIPTION

The Invertec V300-PRO is a 300 amp arc welding power source that utilizes single or three phase input power to produce either constant voltage or constant current outputs. The V300-PRO is designed for 60 Hz supply systems. The welding response of the Invertec has been optimized for GMAW, SMAW, TIG and FCAW processes. It is designed to be used with the LN-25 and LN-7 semiautomatic wire feeders.

## SPECIFICATIONS

Product Name	Ordering Information	Input AC Voltage	Rated DC Output Amps/Volts/Duty Cycle	Input Amps at Rated DC Output				Output Range (continuous)	Weight with Gun (net)	Dimensions HxWxD
				208	230	460	575			
Invertec V300-PRO	K1349-3	208/230/460 3 Phase 60 Hz	300A / 32V / 60% <sup>(1)</sup> 250A / 30V / 100% <sup>(1)</sup> 300A / 35/39/41V / 60% <sup>(2)</sup>	48 37 49	43 33 48	24 19 28		AMPS 5-350	64 lbs. (29 kg)	18.7"x10.8x 22.2" (475x274x 564 mm)  * Includes handle
		208/230/460 1 Phase 60 Hz	250A / 30V / 60% <sup>(1)</sup> 160A / 28V / 100% <sup>(1)</sup> 250A / 37/41/43V / 60% <sup>(2)</sup>	69 53 75	62 47 67	38 29 42				
	K1349-4	575 3 Phase 60 Hz	300A / 32V / 60% <sup>(1)</sup> 250A / 30V / 100% <sup>(1)</sup> 300A / 36V / 60% <sup>(2)</sup>				20 16 22			

<sup>(1)</sup>NEMA Class I Rated Output / Based on a 10 min. Period .

<sup>(2)</sup>Lincoln plus rating.

\* Overall Height Including Handle, (16.4" (417mm without handle).

## INSTALLATION

### ⚠ WARNING



**ELECTRIC SHOCK** can kill.

- Have an electrician install and service this equipment.
- Turn the input power off at the fuse box before working on equipment.
- Do not touch electrically hot parts.

## LOCATION

The Invertec has been designed with many features to protect it from harsh environments. Even so, it is important that simple preventative measures are followed in order to assure long life and reliable operation.

- The machine must be located where there is free circulation of clean air such that air movement into the sides and out the bottom and front will not be restricted. Dirt and dust that can be drawn into the machine should be kept to a minimum. Failure to observe these precautions can result in excessive operating temperatures and nuisance shutdown of the Invertec.
- Keep machine dry. Shelter from rain and snow. Do not place on wet ground or in puddles.

## ELECTRICAL INSTALLATION

1. The Invertec should be connected only by a qualified electrician. Installation should be made in accordance with the U.S. National Electrical Code, all local codes and the information detailed below.
2. Single voltage, 575 VAC machines, can only be connected to 575 VAC. No internal reconnection for other input voltages is possible.
3. Initial 208 VAC and 230 VAC operation will require a voltage panel setup, as will later reconnection back to 460 VAC:
  - a. Open the access panel on the right side of the machine.
  - b. For 208 or 230: Position the large switch to 200-230.  
For 460: Position the large switch to 380-460.
  - c. Move the "A" lead to the appropriate terminal.

## INPUT VOLTAGE SETUP

### **CAUTION**

**DO NOT ATTEMPT TO POWER THIS UNIT FROM THE AUXILIARY POWER SUPPLY OF AN ENGINE WELDER.**

- Special protection circuits may operate, causing loss of output.
- The supply from engine welders often has excessive voltage peaks because the voltage waveform is usually triangular shaped instead of sinusoidal.
- If voltage peaks from the engine welder exceed 380V, the input circuits of this machine protecting the filter capacitors, FETS and other components from damage will not be energized .

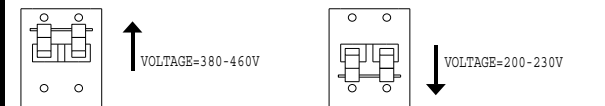
RECONNECT PROCEDURE	<b>WARNING</b>
<p>1. BE SURE POWER SWITCH IS OFF.</p> <p>2. CONNECT LEAD 'A' TO DESIRED INPUT VOLTAGE RANGE.</p> <p>440-460V</p> <p>380-415V</p> <p>220-230V</p> <p>200-208V</p> 	<p><b>ELECTRIC SHOCK CAN KILL</b></p> <ul style="list-style-type: none"> <li>• Disconnect input power before inspecting or servicing machine.</li> <li>• Do not operate with wraparound removed.</li> <li>• Do not touch electrically live parts.</li> <li>• Only qualified persons should install, use or service this equipment.</li> </ul> <p>IF MACHINE CRASHES TO OPERATE (NO METER, NO FAN) AND THERE IS NO OTHER KNOWN FAILURE: CHECK FUSE; REPLACE WITH A 3 AMP SLOW BLOW ONLY.</p>
<p>3. POSITION SWITCH TO DESIRED INPUT VOLTAGE RANGE.</p> 	
<p>THE LINCOLN ELECTRIC CO. CLEVELAND, OHIO U.S.A. 9-13-92 S20324</p>	

## POWER CORD CONNECTION

A 10 ft. (3.0m) power cord is provided and wired into the machine. Follow the power cord connection instructions. Incorrect connection may result in equipment damage.

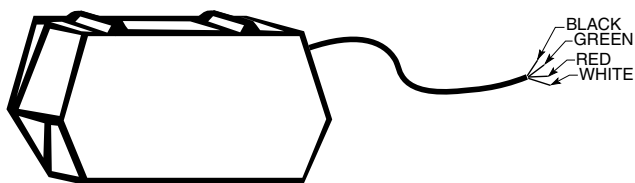

### Single Phase Input

1. Connect green lead to ground per U.S. National Electrical Code.
2. Connect black and white leads to power.
3. Wrap red lead with tape to provide 600V insulation.

### Three Phase Input

1. Connect green lead to ground per U.S. National Electrical Code.
2. Connect black, red and white leads to power.

Install in accordance with all local and national electric codes.

## Recommended Fuse Sizes Based On The U.S. National Electrical Code And Maximum Machine Outputs

	Input Volts <sup>(1)</sup>	Fuse Size in Amps (Time Delay Fuses)
3 phase 50/60 Hz	208	60
	230	60
	460	40
1 phase 50/60 Hz	208 <sup>(2)</sup>	85
	230 <sup>(2)</sup>	80
	460	50
3 phase 60 Hz	575	30

<sup>(1)</sup> Input voltage must be within  $\pm 10\%$  of rated value.

<sup>(2)</sup> When operating on these inputs, at outputs exceeding 200A/60% or 165A/100%, the input line cord should be changed to an input conductor of 6 AWG or larger.

## CONNECTION OF WIRE FEEDERS TO THE INVERTEC

(Note: IEC units do not have 110 VAC auxiliary power).

### LN-25 Connection Instructions

1. Turn the Invertec power switch "off".
2. Connect the electrode cable to the output terminal of polarity required by electrode. Connect the work lead to the other terminal.
3. LN-25 with remote control options K431 and K432. Use K876 adapter with K432 cable or modify K432 cable with K867 universal adapter plug. See connection diagram S19899 and S19309 or S19405 at the back of this manual.
4. Place the local-remote switch in the "remote" position if output control is desired at the wire feeder rather than the Invertec. (LN-25 must have K431 and K432 options for remote output control operation).

### LN-7 Connection Instructions

1. Turn the Invertec power switch "off".
2. Connect the K480 control cable from the LN-7 to the Invertec control cable connector. The control cable connector is located at the rear of the Invertec.
3. Connect the electrode cable to the output terminal of polarity required by electrode. Connect the work lead to the other terminal.
4. Place the local-remote switch in the "local" position to allow output control at the Invertec. (K864



remote control adapter and K857 remote control are required for remote output control).

5. Set the meter polarity switch on the rear of the Invertec to coincide with wire feeder polarity used. The wire feeder will now display the welding voltage.
6. If K480 is not available, see connection diagram S19404 for modification of K291 or K404 LN-7 input cable with K867 universal adapter plug.

### **General Instructions for Connection of Wire Feeders to Invertec**

Wire feeders other than LN-7 and LN-25 may be used provided that the auxiliary power supply capacity of the Invertec is not exceeded. K867 universal adapter plug is required. See connection diagram S19406 and S19386 at the back of this manual for more information.

### **Remote Control of Invertec**

Remote control K857, hand amptrol K963 and foot amptrol K870 require K864 remote control adapter. See 19309 instruction at the back of this manual for connection information.

### **K954-1 MIG PULSER**

The MIG Pulser is a hand-held "pendant" type GMAW Pulsing option for the V300 Power Source. Refer to the Mig Pulser's IM manual (IM555) for connection information.

### **Parallel Operation**

The Invertec's are operable in parallel in both CC and CV modes. For best results, the currents of each machine should be reasonably well shared. As an example, with two machines set up in parallel for a 400 amp procedure, each machine should be set to deliver approximately 200 amps, not 300 amps from one and 100 amps from the other. This will minimize nuisance shutdown conditions. In general, more than two machines in parallel will not be effective due to the voltage requirements of procedures in that power range.

To set machine outputs, start with output control pots and arc force/pinch pots in identical positions. If running in a CC mode, adjust outputs and arc forces to maintain current sharing while establishing the proper output current. In CV modes, the pots in identical positions. Then switch the machine meters to amps and adjust one of the output control pots for current balance. Check the voltage and if readjustment is necessary, repeat the current balancing step. Pinch settings should also be kept identical on the machines.

### **K900-1 DC TIG Starter Connection**

This versatile new kit was made to mate with the Invertec.

A control cable assembly is supplied with the kit to connect the kit to an Invertec. The cable can be connected, either end, at the DC TIG Starter kit and at the Invertec by attaching to the 14-pin Amphenols on the backs of each unit. Refer to diagram S20405 at the back of this manual.

A negative output cable assembly is also supplied with the DC TIG Starter kit to connect the kit with the Invertec's negative output terminal.

All Magnum™ one and two piece water-cooled torches with 7/8 left-hand threads and gas-cooled torches with 7/8 and 5/16 right-hand threads can be connected to the starter kit.

To secure the DC TIG Starter kit to the bottom of the Invertec and for more detailed instructions, refer to the K900-1 manual.

## LN-9 GMA Connection Instructions

1. Turn the Invertec power switch "off".
2. Connect the K596 control cable assembly from the LN-9 GMA to the Invertec control cable connector. The control cable connector is located at the rear of the Invertec.
3. Connect the electrode cable to the output terminal of polarity required by electrode. Connect the work lead to the other terminal.
4. Place the local-remote switch in the "remote" position to allow output control at the LN-9 GMA.
5. Set the meter polarity switch on the rear of the Invertec to coincide with wire feeder polarity used. The wire feeder will now display the welding voltage.
6. K608-1 adapter is required in LN-9 GMA for LN-9 type control. K608-1 is installed in line with P10 connection at the LN-9 GMA voltage board. See diagram S20607 at the back of this manual.
7. K442-1 Pulse Power Filter Board is also required for GMAW, but should be disconnected for FCAW.
8. If K596 is not available, see connection diagram S20608 at the back of this manual for modification of K196 LN-9 GMA input cable with K867 universal adapter plug.

## Output Cables

Select the output cable size based upon the following chart.

Cable sizes for Combined Length of Electrode and Work Cable (Copper) 75° rated:

Duty Cycle	Current	Length Up 61m (200 ft.)	61-76m (200-250 ft.)
100%	250	1/0	1/0
60%	300	1/0	2/0

## Quick Disconnect Plugs

A quick disconnect system is used for the welding cable connections. The welding plug included with the machine is designed to accept a welding cable size of 1/0 to 2/0.

1. Remote 25mm (1 in.) of welding cable insulation.

2. Slide rubber boot onto cable end. The boot end may be trimmed to match the cable diameter. Soap or other lubricant will help to slide the boot over the cable.

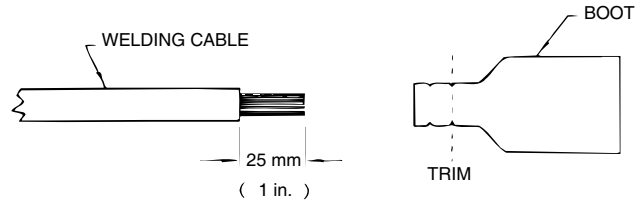

3. Slide the copper tube into the brass plug.
4. Insert cable into copper tube.

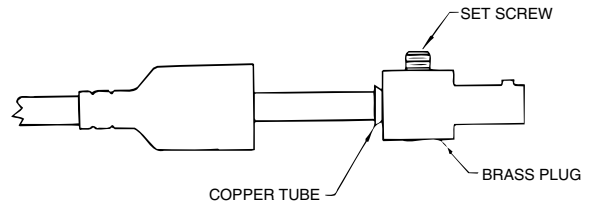

5. Tighten set screw to collapse copper tube. Screw must apply pressure against welding cable. The top of the set screw will be well below the surface of the brass plug after tightening.
6. Slide rubber boot over brass plug. The rubber boot must be positioned to completely cover all electrical surfaces after the plug is locked into the receptacle.

## OPERATING INSTRUCTIONS

### ⚠ WARNING



#### ELECTRIC SHOCK can kill.

- Do not touch electrically live parts or electrode with skin or wet clothing.
- Insulate yourself from work and ground.
- Always wear dry insulating gloves.



#### FUMES AND GASES can be dangerous.

- Keep your head out of fumes.
- Use ventilation or exhaust to remove fumes from breathing zone.

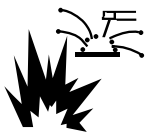

#### WELDING SPARKS can cause fire or explosion.

- Keep flammable material away.
- Do not weld on closed containers.



#### ARC RAYS can burn eyes and skin.

- Wear eye, ear and body protection.

See additional warning information at front of this operator's manual.

### DUTY CYCLE

The Inverter is rated at 300 amps, 60% duty cycle for 3 phase inputs (based on a 10 minute cycle). It is also rated at 250 amps, 100% duty cycle.

### CONTROL FUNCTION / OPERATION

**Power Switch** - Place the lever in the "ON" position to energize the machine. When the power is on, the digital meter will activate and the fan will operate.

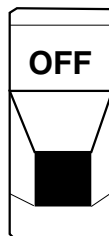

**Output Control** - This controls the output voltage in the CV modes and output current in the CC modes.

Control is provided over the entire output range of the power source with 1 turn of the control knob. This control may be adjusted while under load to change power source output.

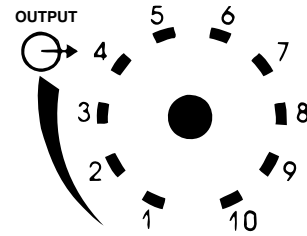

**Local/Remote Switch** - Place in the "LOCAL" position to allow output adjustment at the machine. Place in the "REMOTE" position to allow output adjustment at the wire feeder or with a remote control option package.

REMOTE



**Digital Meter Switch** - Select either "A" for amps or "V" for volts to display welding current or voltage on the meter.

When welding current is not present, the meter will display the set current for the CC modes or the set voltage for the CV modes. This set reading is an indication of machine control setting. For a more precise process reading, read meter during actual welding.



### Mode Switch

**GTAW** Optimized for both scratch start and Hi-Freq kit use.

**CC SOFT** Best for EXX18 thru EXX28 stick electrodes.

**CC Crisp** Use this mode for stick welding with EXX10 thru EXX14 electrodes. Non-welding applications such as resistive heating or output tests with resistive loads should be done in this mode with Arc Force Control set to minimum.

**CV FCAW** This setting has been optimized for Innershield® and Outershield® flux-cored electrodes.

**CV GMAW** Short circuit, glob and spray transfer solid wire and gas welding are done in this mode. Low end procedures, less than 17V, may operate better in the FCAW mode. **Voltage in the GMAW mode can become erratic when welding is attempted using voltages equal to or less than 17V DC+.**

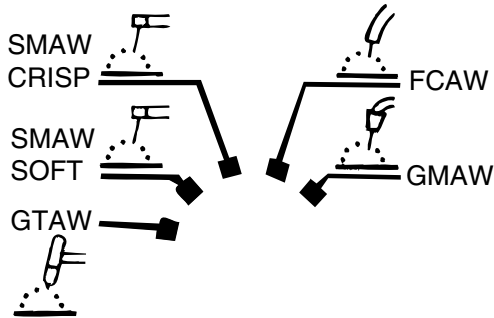

**Output Terminals Switch**

For processes and equipment that require energized machine terminals (stick, TIG, air-carbon arc cutting or hot tip LN-25), set the Output Terminals Switch to “ON” position.

Set to the REMOTE (OFF) position when using LN-25 with K431 and K432 options or LN-7 which will allow the gun trigger to energize the welding terminals.

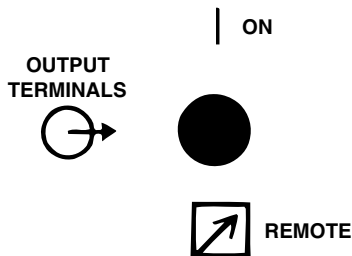

**Arc Force / Inductance Control**

This control functions in all modes except GTAW. For CC modes, this control acts as an Arc Force adjustment. The arc is soft at the minimum settings and more forceful or driving at the maximum settings. Higher spatter levels may be present at the maximum settings.

For CV modes, this control will set the degree of “pinch effect” which predominantly affects short circuit transfer. In FCAW, the maximum setting is generally preferred. With GMAW, the upper half of the range is preferred with CO<sub>2</sub> or high content CO<sub>2</sub> mixed. The lower half is for inert gas mixes.

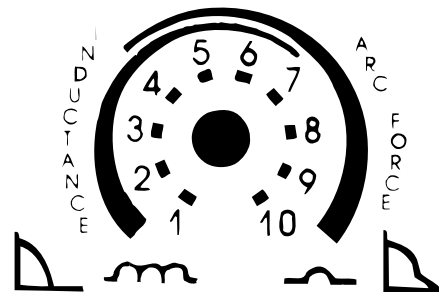

**Recommended Arc Force / Inductance Settings For Selected Applications**

**Full Range Is 1-10,  
1 Is Very Soft, 10 Is Very Crisp**

Mode	Process	Nominal Setting	Recommended Adjustment Range
CC SMAW 1	EXX18 thru EXX28 stick	5	1 (gentle, may stick) to 9 (forceful, more spatter)
CC SMAW 2	EXX10 thru EXX14 stick	6	3 to 10
	Air Carbon Arc Cutting	1	None
CV FCAW	Innershield or Outershield	10	None
	Air Carbon Arc Cutting	1	None
CV GMAW*	CO <sub>2</sub> or 25% CO <sub>2</sub> or similar gas mixes	7.5	5 to 10
	98% Ar-2% O <sub>2</sub> Ar, 90% He-7.5% Ar 2.5% CO <sub>2</sub> and other predominantly inert gases	5	1 to 10

\* 1 = Lowest pinch, highest inductance and least spatter.  
10 = Highest pinch, lowest inductance and most spatter.

## Meter Polarity Switch

The wire feeder polarity switch is located at the rear of the machine. The switch provides a work connection for wire feeder voltmeters. Place the switch in the position of the electrode polarity indicated by the decal. The switch does not change the welding polarity.

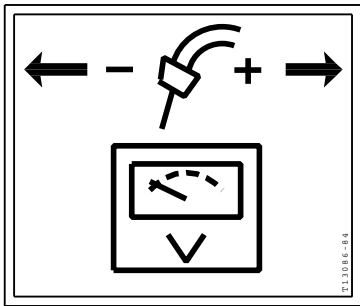

## Auxiliary Power

A 24 VAC @ 1 amp supply is included for use with the LN-25 wire feeder (24 volts needed for K431 and K432 options). This supply is protected by a self-resetting current limiter.

A 42 VAC @ 5.5 amp supply is included for use with other wire feeders. This supply is protected by a 6 amp breaker located on the rear of the machine.

A 110/115 VAC @ 2 amp supply is included for use with the LN-7 or LN-9 GMA wire feeders. This supply is protected by a 2.5 amp breaker located on the rear of the machine. It is NOT available on IEC units.

All three supplies are not to be loaded simultaneously.

## MAINTENANCE

### ⚠ WARNING



**ELECTRIC SHOCK** can kill.

- Have an electrician install and service this equipment.
- Turn the input power off at the fuse box before working on equipment.
- Do not touch electrically hot parts.



**EXPLODING PARTS** can cause injury.

- Failed parts can explode or cause other parts to explode when power is applied.
- Always wear a face shield and long sleeves when servicing.

## Capacitor Discharge Procedure

1. Obtain a power resistor (25 ohms, 25 watts).
2. Hold resistor body with electrically insulated glove. **DO NOT TOUCH TERMINALS.** Connect the resistor terminals across the two hex head cap screws in the position shown. Hold in each position for 1 second. For 575 VAC only, repeat for second capacitor. Repeat for the capacitor(s) on the other side of the machine

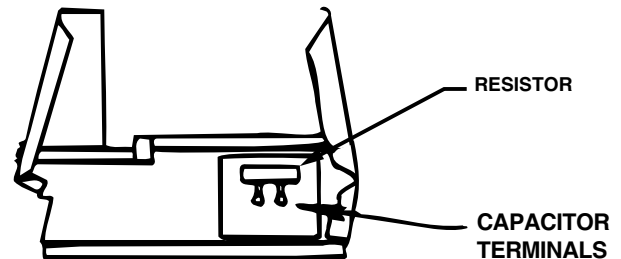

3. Use a DC voltmeter to check that voltage is not present across either capacitor.

## Routine Maintenance

1. Every 6 months or so the machine should be cleaned with a low pressure airstream. Keeping the machine clean will result in cooler operation and higher reliability. Be sure to clean these areas:
  - Power, switch, driver, protection and control printed circuit boards.
  - Power switch
  - Main transformer
  - Input rectifier (located in front of fan blade)
  - Heat sink fins
2. Examine the sheet metal case for dents or breakage. Repair the case as required. Keep the case in good condition to insure that high voltage parts are protected and correct spacings are maintained. All external sheet metal screws must be in place to insure case strength and electrical ground continuity.

## PERIODIC MAINTENANCE

### Overload Protection

The machine is electrically protected from producing high output currents. Should the output current exceed 340-360A, an electronic protection circuit will reduce the current to approximately 150A. The machine will continue to produce this low current until the protection circuit is reset. Reset occurs when the output load is removed.

### Thermal Protection

Thermostats protect the machine from excessive operating temperatures. Excessive temperatures may be caused by a lack of cooling air or operating the machine beyond the duty cycle and output rating. If excessive operating temperature should occur, the thermostat will prevent output voltage or current. The meter will remain energized during this time.

Thermostats are self-resetting once the machine cools sufficiently. If the thermostat shutdown was caused by excessive output or duty cycle and the fan is operating normally, the Power Switch may be left on and the reset should occur within a 15 minute period. If the fan is not turning or the air intake louvers were obstructed, then the power must be switched off for 15 minutes in order to reset. The fan problem or air obstruction must also be corrected.

### Filter Capacitor Conditioning

A protection circuit is included to monitor the voltage across filter capacitors C1 and C2 (also C14 and C15 on 575 VAC units). In the event that the capacitor voltage is too high, the protection circuit will prevent output. The protection circuit may prevent output providing all these circumstances are met:

1. Machine is internally connected for 380 VAC, or higher input voltage.
2. Machine did not have power applied for many months.
3. Machine did not produce output when power was first switched on.

If these circumstances apply, the proper action is to switch the machine on and let it idle for up to 30 minutes. This is required to condition the filter capacitors after an extended storage time. The protection circuit will automatically reset once the capacitor conditioning and resultant voltage levels are acceptable. It may be necessary to turn the power switch off and back on again after this period.

## TROUBLESHOOTING

### WARNING



**ELECTRIC SHOCK** can kill.

- Have an electrician install and service this equipment.
- Turn the input power off at the fuse box before working on equipment.
- Do not touch electrically hot parts.



**EXPLODING PARTS** can cause injury.

- Failed parts can explode or cause other parts to explode when power is applied.
- Always wear a face shield and long sleeves when servicing.

### Visual Inspection

Clean interior of machine with a low pressure airstream. Make a thorough inspection of all components. Look for signs of overheating, broken leads or other obvious problems. Many problems can be uncovered with a good visual inspection.

### Open Circuit Voltage

The open circuit voltage of the Invertec V300-PRO is 60 to 75 VDC and cannot be adjusted by the output control.

### Test Conditions

Perform all testing at the lowest input voltage available, except where a higher voltage is required by a test step. Make ohmmeter checks only after power has been disconnected from machine and after capacitors have been discharged.

Certain high voltage connections have been insulated with RTV sealant. It is necessary to break through the sealant with a sharp probe in order to make voltage or resistance checks.

Disconnect any control cables from remote control receptacle.

## TROUBLESHOOTING GUIDE

Trouble	What To Do
Not output but fan operates and meter is on.	Perform test steps 1A and 1B.
Poor welding, weld settings drift, or output power is low.	<ol style="list-style-type: none"> <li>1. Check front panel wiring and controls.</li> <li>2. Replace Control PC Board.</li> </ol>
Main fuses open or Switch PC boards overheated.	Perform test steps 4 and 5 for both Switch PC Boards and 7.
Output turns on momentarily then switches off and repeats. Machine is connected for 380 VAC or higher input voltage.	Perform test steps 3B, 4 and 5.
OCV is normal (approx. 65-75V) but output power is low (less than 20V and 100A). Machine makes squealing noise while under load. Machine is connected for 230 VAC, or lower, input voltage.	Perform test steps 4 and 5 for both Switch PC Boards.
Open circuit voltage is 1-2 volts.	Perform test step 6.
Output control not functioning on remote control. Local control OK.	<ol style="list-style-type: none"> <li>1. Check remote control assembly.</li> <li>2. Check S3, Local/Remote switch.</li> </ol>
Machine does not produce more than 250A output when connected to 3 phase supply.	<ol style="list-style-type: none"> <li>1. Replace main fuse if blown.</li> <li>2. Replace Protection PC Board.</li> <li>3. Replace Control PC Board.</li> <li>4. Perform test step 7.</li> </ol>
Machine does not produce more than 200 A output while connected to 1 phase supply.	Normal operation.
Machine operates OK at 230 VAC or lower. No output at 380 VAC or higher.	Perform test step 2.
Poor EXX10 stick electrode (5P) performance. Arc "pops out".	Check D6 and D12, L1 and L2.
No output or reduced output the first time power is applied to the machine.	Check reconnect panel - connections and fuse.

### CAUTION

If for any reason you do not understand the test procedures or are unable to perform the tests/repairs safely, contact your local Authorized Field Service Facility for technical troubleshooting assistance before you proceed.

## TEST PROCEDURES

Step	Test	Check	Test Result	Conclusion	Next Test Step	Repair Action
1A	Output pilot circuit (set S4 on)	223A to 210	24 VAC	Fan thermostat, choke thermostat, T1 transformer and S4 all OK.	1B	
			0 VAC	Check above components.		
1B		302 (pos) to 275D (neg)	15 VDC	T1 and 15V power supply OK.	2	
			0 VDC	Check T1 and Power PC Board.		
2	Protection PC board output (set S4 on)	313 (neg) to 311 (pos)	<1 VDC	Protection PC Board OK		Replace Power and Control PC Boards
			>5 VDC		3A	
3A	Static capacitor balance (set S4 off)  380 VAC input and higher test	Compare voltage across terminals 9 & 12 of each Switch PC Board. 575 VAC -- 407 VDC 460 VAC -- 325 VDC 440 VAC -- 311 VDC 415 VAC -- 293 VDC 380 VAC -- 269 VDC 575 VAC only - compare voltage across 9A & 13 and 13 & 12A; then, 9B & 15 and 15 & 12B	<25 VDC difference between readings	C1, C2, R1, R9 - OK (575 VAC machine C14, C15 - OK)	3B	Replace Protection PC Board
			>25 VDC difference	Check above components.		
3B	Dynamic capacitor balance (set S4 on)  380 VAC input and higher test	Connect as in step 3A. Same voltages as above.	<25 VDC	OK		
			>25 VDC	Power PC Board or Switch PC Boards are damaged.	4 and 5	

### CAUTION

If for any reason you do not understand the test procedures or are unable to perform the tests/repairs safely, contact your local Authorized Field Service Facility for technical troubleshooting assistance before you proceed.



Step	Test	Check	Test Result	Conclusion	Next Test Step	Repair Action
4	Switch PC Board resistance test.	Terminals on Switch PC Board: 1/8 (pos) to 12 (neg)	>1K ohms	OK	cont	
			<100 ohms	Short	5	Replace Switch PC Board
	No dynamic test is possible.	1/8 (neg) to 12 (pos)	<100 ohms	OK	cont	
			>1K ohms	Open	5	Replace Switch PC Board
	Remove leads 401/403, 1/8, 9, 12, 4/5 and 402/404.	9 (pos) to 4/5 (neg)	>1K ohms	OK	cont	
			<100 ohms	Short	5	Replace Switch PC Board
	9 (neg) to 4/5 (pos)	<100 ohms	OK	cont		
		>1K ohms	Open	5	Replace Switch PC Board	
	1/8 (pos) to 9 (neg)	<100 ohms	OK	cont		
		>1K ohms	Open	5	Replace Switch PC Board	
	1/8 (neg) to 9 (pos)	>1K ohms	OK	cont		
		<100 ohms	Short	5	Replace Switch PC Board	
	12 (pos) to 4/5 (neg)	<100 ohms	OK	cont		
		>1K ohms	Open	5	Replace Switch PC Board	
	12 (neg) to 4/5 (pos)	>1K ohms	OK	cont		
		<100 ohms	Short	5	Replace Switch PC Board	
	12 (pos) to 401/403 (neg)	>1K ohms	OK	cont		
		<100 ohms	Short	5	Replace Switch PC Board	
	12 (neg) to 401/403 (pos)	<100 ohms	OK	cont		
		>1K ohms	Open	5	Replace Switch PC Board	
	9 (pos) to 402/404 (neg)	<100 ohms	OK	cont		
		>1K ohms	Open	5	Replace Switch PC Board	
	9 (neg) to 402/404 (pos)	>1K ohms	OK	cont		
		<100 ohms	Short	5	Replace Switch PC Board	

**⚠ CAUTION**

If for any reason you do not understand the test procedures or are unable to perform the tests/repairs safely, contact your local Authorized Field Service Facility for technical troubleshooting assistance before you proceed.

Step	Test	Check	Test Result	Conclusion	Next Test Step	Repair Action
5	Snubber Resistors	Lead 401 to terminal 12	25 ohms	OK	cont	
			>30 ohms <20 ohms	R4 open R4 shorted		Replace R4
	Disconnect leads 401, 402, 403 and 404 from Switch PC Board	Lead 402 to terminal 9	25 ohms	OK	cont	
			>30 ohms <20 ohms	R5 open R5 shorted		Replace R5
		Lead 403 to terminal 12	25 ohms	OK	cont	
			>30 ohms <20 ohms	R6 open R6 shorted		Replace R6
		Lead 404 to terminal 9	25 ohms	OK	cont	
			>30 ohms <20 ohms	R7 open R7 shorted		Replace R7
6	Output diodes	+ output plug (pos) to - output plug (neg)	<100 ohms	Shorted output diode D1 thru D12		Test individually
	Remove output load		>200 ohms	Output diodes OK		

**⚠ CAUTION**

If for any reason you do not understand the test procedures or are unable to perform the tests/repairs safely, contact your local Authorized Field Service Facility for technical troubleshooting assistance before you proceed.

Step	Test	Check	Test Result	Conclusion	Next Test Step	Repair Action
7	D13 Input Rectifier	9 (pos) to H1 (neg)	>1K ohms	OK	cont	
			<100 ohms	Shorted	4-5	Replace D13, inspect S1, test C1 and C2
		9 (pos) to A (neg)	>1K ohms	OK	cont	
			<100 ohms	Shorted	4-5	Replace D13, inspect S1, test C1 and C2
		9 (pos) to H5 (neg)	>1K ohms	OK	cont	
			<100 ohms	Shorted	4-5	Replace D13, inspect S1, test C1 and C2
		12 (neg) to H1 (pos)	>1K ohms	OK	cont	
			<100 ohms	Shorted	4-5	Replace D13, inspect S1, test C1 and C2
		12 (neg) to A (pos)	>1K ohms	OK	cont	
			<100 ohms	Shorted	4-5	Replace D13, inspect S1, test C1 and C2
		12 (neg) to H5 (pos)	>1K ohms	OK	cont	
			<100 ohms	Shorted	4-5	Replace D13, inspect S1, test C1 and C2
		9 (neg) to H1 (pos)	<100 ohms	OK	cont	
			>1K ohms	Open	4-5	Replace D13, inspect S1, test C1 and C2
		9 (neg) to A (pos)	<100 ohms	OK	cont	
			>1K ohms	Open	4-5	Replace D13, inspect S1, test C1 and C2
		9 (neg) to H5 (pos)	<100 ohms	OK	cont	
			>1K ohms	Open	4-5	Replace D13, inspect S1, test C1 and C2
		12 (pos) to H1 (neg)	<100 ohms	OK	cont	
			>1K ohms	Open	4-5	Replace D13, inspect S1, test C1 and C2
		12 (pos) to A (neg)	<100 ohms	OK	cont	
			>1K ohms	Open	4-5	Replace D13, inspect S1, test C1 and C2
		12 ( pos) to H5 (neg)	<100 ohms	OK	cont	
			>1K ohms	Open	4-5	Replace D13, inspect S1, test C1 and C2

## Matched Parts

Certain parts must be replaced in matched sets. Matched sets are required in the following areas:

Output diodes: D1, D2, D3, D4 and D5  
Output diodes: D7, D8, D9, D10 and D11  
Capacitor bleeder resistors: R1 and D9  
Capacitors: C1 and C2  
Capacitors: C1, C2, C14 and C15 (575 VAC only)

## Switch PC Board Repairs

If a test indicates that a Switch PC Board is defective, both Switch PC Boards must be replaced.

Replacement boards must have completely identical part numbers. A defective module is likely to damage other devices in the power circuitry. The defect may be subtle and not detectable by an ohmmeter measurement. Unknown defective parts may cause newly replaced parts to fail.

In addition to replacing the Switch PC Boards, replace C1 and C2 (also C14 and C15 of the 575 VAC V300-PRO) if the following conditions are met:

1. Machine was operating from 380 VAC or higher supply when failure occurred.
2. Switch PC Boards have burned areas.

## Switch PC Board Replacement Procedure

### **WARNING**



**ELECTRIC SHOCK** can kill.

- Have an electrician install and service this equipment.
- Turn the input power off at the fuse box before working on equipment.
- Do not touch electrically hot parts.



**EXPLODING PARTS** can cause injury.

- Failed parts can explode or cause other parts to explode when power is applied.
- Always wear a face shield and long sleeves when servicing.

1. Carefully disconnect the leads at the top of the Switch PC Board.
2. Remove the four socket head cap screws with a 3/16" hex key wrench.
3. While holding the Switch PC Board, remove the hex head cap screws from the center area of the board.
4. Remove the board.

5. Thoroughly clean the heat sink surface.
6. Apply a thin layer (ideally .005-.010") of Dow 340 Heat Sink Compound to the module mounting surfaces of the new Switch PC Board and a thinner layer (.002") to the capacitor terminals. Keep the heat sink compound away from the screw threads since this compound will affect the torque specifications.
7. Carefully place the Switch PC Board onto the heat sink. Be sure the mounting holes are lined up before making full contact with the heat sink.
8. Caution: The heat sink and the capacitor terminals are relatively soft material and it is very easy to cross-thread the mounting screws. Holding the Switch PC Board, install the 4 socket head cap screws, finger tight only. Then install the hex head cap screws into the capacitor, finger tight only.
9. Torque the 4 socket head cap screws to 44 inch-lbs force (5 N - m). Then torque the capacitor hex head cap screws to 55 inch-lbs force (6 N - m).
10. Reconnect all the leads to the board.

Before applying input power to the machine, check all electrical connections. An incorrect connection will result in machine damage when the power is switched on.

## Test After Repair

1. Short terminals 14 and 53 of the Protection PC Board. Connect an ohmmeter, set for X1000 range, to terminals 9 (+) and 12 (-) of the Switch PC Board. The meter will show the capacitors charging up. The meter may take a minute or so to stabilize. The value must not exceed 8600 ohms. Test both boards. For 575V only units - measure across each power capacitor, 2 per switch board; All four readings should be approximately 5,000 ohms.
2. If OK, remove the short and proceed with the power test.
3. Fuse input supply with 5 amp fuses.
4. Check output open circuit voltages. Do not apply output load.
5. Connect machine for 460 (V300-PRO), or 575 (V300-PRO, 575V), or 380, 415 or 440 (V300-I) VAC input.
6. Check output open circuit voltages. Do not apply output load.
7. Fuse for 20 amps and test under load.

## Replacement of Power Modules and Output Diodes

Input rectifier, D13, is a power module. When mounting power modules, the heat sink and module mounting surface should be clean and free of burrs and foreign material. Apply heatsink compound (Dow 340) as a uniform layer ideally .010" thick, to eliminate all air pockets. This may be verified by mounting and then removing the module. When removed, the compound on both surfaces will appear textured as if a vacuum had created veinlike ridges when the parts were separated. If the compound does not have this appearance, apply more heatsink compound and recheck.

Replacement of output diodes D1 thru D12 is similar. Clean and brighten mounting surface with fine steel wool. Compound should be used on surface between diode and heat sink when mounting individual diodes.

The compound should be applied to the heat sink in a very thin layer, less than 0.001 in. DO NOT apply on diode stud and mounting nut threads.

Components must have proper torque applied to mounting screws and to electrical terminals. Torque the modules according to the following:

Component	Component to Heat Sink Torque $\pm 10\%$	Terminal Torque $\pm 10\%$
Switch Board		
Module	44 Inch - Lbs. <sup>(1)</sup> (5N - m)	N.A.
Capacitor	N.A.	55 Inch - Lbs. (6.3 N - m)
Input Rectifier (M15454-1)	6 Inch - Lbs. <sup>(2)</sup> (0.7 N - m)	26 Inch - Lbs. 3 (N - m)
Output Diode (M15482-2)	25 Inch - Lbs. (3 N - m)	N.A.

<sup>(1)</sup> Retorque after 3 hours to allow for spread of compound.

<sup>(2)</sup> Tighten in staggered fashion one quarter turn at a time.

## Environment Protection

High voltage connections are covered with an RTV sealant to prevent malfunction in severe environments. Sealant must be applied to connections which have been opened or otherwise lost their protection. A noncorrosive electronic grade sealant such as Dow Corning 3140, 3145, 738, Columbus Adhesives 0172 or GE RTV-162 is recommended. Sealant may also be purchased from Lincoln Electric (order E2519 Silicone Rubber RTV Coating). Apply sealant after machine is repaired and tested.

High voltage areas which require sealant are as listed:  
- Input rectifier D13, all 5 terminals.

## Printed Circuit Board Replacement

1. Handle PC Boards by edges only.
2. Store PC Boards only in the bags that disperse static charges.
3. Inspect PC Board for burned conductors or components. If damage is visible, inspect the machine wiring for grounds or shorts to avoid damaging a new PC Board.
4. If there is no visible damage to the PC Board, install a new PC Board and see if the problem is fixed. If the problem is fixed by the new board, reinstall the old board and see if the problem reoccurs. If the problem does not reoccur, check the wiring harness and plugs for loose connections.

# REMOTE CONTROL ADAPTERS

**WARNING:**



**ELECTRIC SHOCK CAN KILL**

TURN THE POWER SWITCH OF THE WELDING POWER SOURCE "OFF" BEFORE INSTALLING PLUGS ON CABLES OR WHEN CONNECTING OR DISCONNECTING PLUGS TO WELDING POWER SOURCE.

STRAIGHT PLUG (14 PIN)  
TO POWER SOURCE

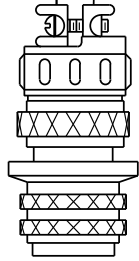

K864

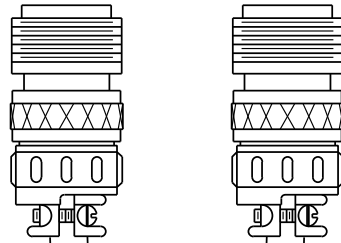

CABLE RECEPTACLE (6 SOCKET)

- TO:
- 1) K857 REMOTE CONTROL
  - 2) K963 HAND AMPTRON
  - 3) K870 FOOT AMPTRON

STRAIGHT PLUG (14 PIN)  
TO POWER SOURCE

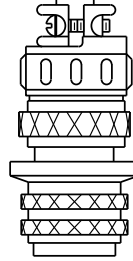

K876

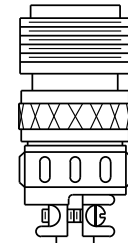

CABLE RECEPTACLE (6 SOCKET)

- TO:
- 1) LN-25 WIRE FEEDERS

# K867 UNIVERSAL ADAPTER FOR 14-PIN WIRE FEEDER RECEPTACLE

## INSTALLATION INSTRUCTIONS

THIS CONNECTOR IS MEANT TO BE USED WITH LINCOLN POWER SOURCES WHICH HAVE A 14-PIN WIRE FEEDER RECEPTACLE. IT IS DESIGNED TO ALLOW THE USER TO MAKE CONNECTIONS TO ANY OF THE 14 CIRCUITS PRESENT IN THE WIRE FEEDER RECEPTACLE.

CONSULT THE WIRING DIAGRAM OF THE POWER SOURCE AND WIRE FEEDER THIS ADAPTER WILL BE USED WITH.

NOT ALL CIRCUITS ARE PRESENT IN EVERY POWER SOURCE, NOR ARE THEY REQUIRED FOR PROPER WIRE FEEDER OPERATION.

1. TURN THE POWER SWITCH OF THE WELDING POWER SOURCE OFF BEFORE INSTALLING THIS ADAPTER TO WIRE FEEDER CABLE.
2. CONSULT THE APPROPRIATE EQUIPMENT WIRING DIAGRAMS FOR THE CONNECTIONS TO UNIVERSAL ADAPTER.

THE STANDARD CONNECTOR PIN DESIGNATIONS AND FUNCTIONS ARE SHOWN BELOW.

NOTE: 115V AC (31, 32), 42V AC (41, 42), 24V AC (SPARE) AND TRIGGER CIRCUIT (2, 4)

MAY OR MAY NOT BE ISOLATED, INDEPENDENT CIRCUITS INSIDE THE WELDER.

3. USE LUG, CRIMP SPLICE OR SOLDER CONNECTIONS AS REQUIRED AND INSULATE EACH USED AND UNUSED LEAD IN THE UNIVERSAL ADAPTER. THE INSULATING METHOD MUST BE RATED FOR 120V AC OR GREATER.

(SEE APPROPRIATE WIRING DIAGRAM)

THESE FUNCTIONS ARE LISTED FOR

REFERENCE ONLY AND EACH MAY OR

MAY NOT BE PRESENT IN YOUR EQUIPMENT.

PIN	LEAD	STANDARD FUNCTION
A	32	115V AC
B	GND	CHASSIS CONNECTION
C	2	TRIGGER CIRCUIT
D	4	TRIGGER CIRCUIT
E	77	OUTPUT CONTROL
F	76	OUTPUT CONTROL
G	75	OUTPUT CONTROL
H	21	WORK
I	41	42V AC
J	31	115V AC
K	42	42V AC
L	82	WELDING MODE CONTROL
M	81	WELDING MODE CONTROL
N	SPARE	24V AC

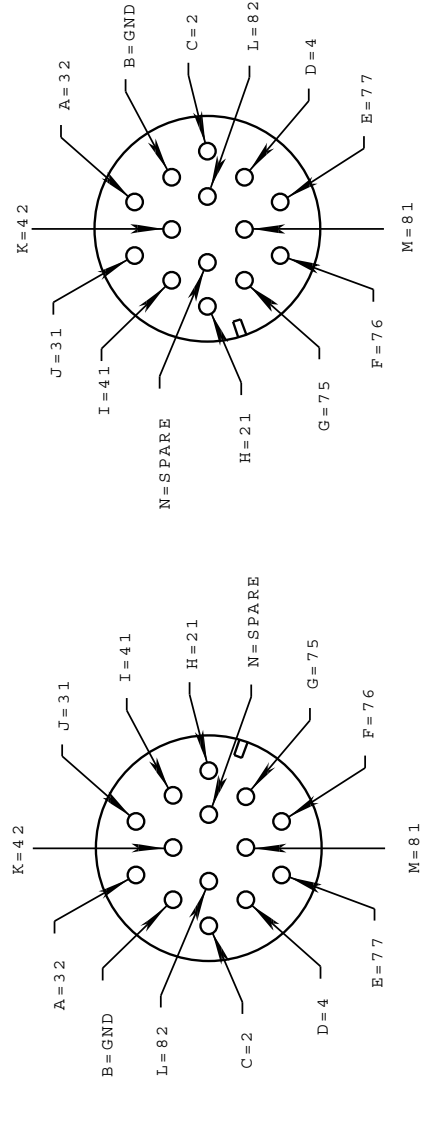

14-PIN BOX RECEPTACLE, FRONT VIEW

14-PIN BOX RECEPTACLE, REAR VIEW

AND 14-PIN CABLE PLUG, REAR VIEW

AND 14-PIN CABLE PLUG, FRONT VIEW

# K867 PLUG TO LN-7 - CONNECTION DIAGRAM

<p><b>WARNING</b></p> 	<ul style="list-style-type: none"> <li>• Turn off input power to the Welding Power Source using the disconnect switch at the fuse box Before connecting the wire feeder.</li> <li>• Only qualified persons should install, use or service this machine.</li> </ul>
<p>ELECTRIC SHOCK CAN KILL</p>	

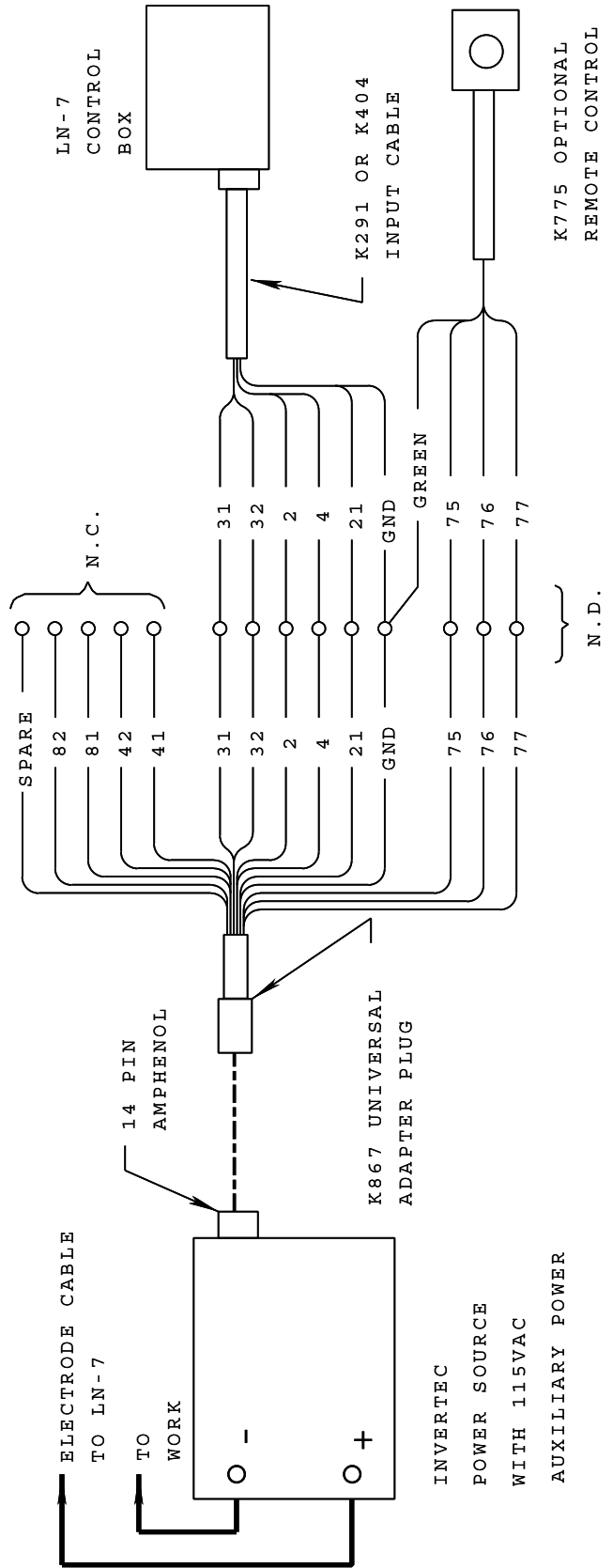

- N.A. WELDING CABLE MUST BE SIZED FOR CURRENT AND DUTY CYCLE OF APPLICATION.
- N.B. DIAGRAM SHOWS ELECTRODE POSITIVE. TO CHANGE POLARITY, TURN POWER "OFF", REVERSE ELECTRODE AND WORK CABLE AT POWER SOURCE.
- N.C. INSULATE EACH UNUSED LEAD INDIVIDUALLY.
- N.D. SPLICE LEADS AND INSULATE.



# K867 PLUG TO LN-25 - CONNECTION DIAGRAM

 <p><b>WARNING</b></p>	<ul style="list-style-type: none"> <li>• Turn off input power to the Welding Power Source using the disconnect switch at the fuse box Before connecting the wire feeder.</li> <li>• Only qualified persons should install, use or service this machine.</li> </ul>
<p><b>ELECTRIC SHOCK CAN KILL</b></p>	

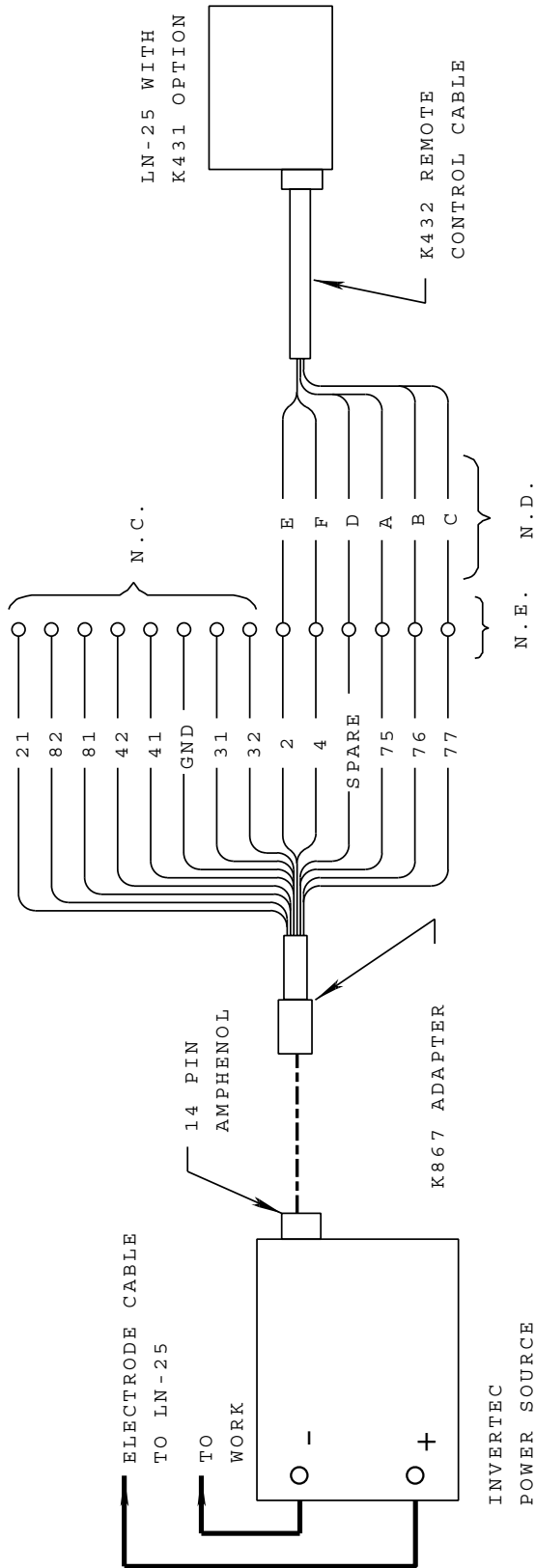

- N.A. WELDING CABLE MUST BE SIZED FOR CURRENT AND DUTY CYCLE OF APPLICATION.
- N.B. DIAGRAM SHOWS ELECTRODE POSITIVE. TO CHANGE POLARITY, TURN POWER "OFF", REVERSE ELECTRODE AND WORK CABLE AT POWER SOURCE.
- N.C. INSULATE EACH UNUSED LEAD INDIVIDUALLY.
- N.D. REMOVE 6 PIN PLUG FROM K432 CABLE IN ORDER TO CONNECT K867 PLUG. LABEL EACH LEAD (A THRU F) AS THEY ARE REMOVED FROM 6 PIN PLUG.
- N.E. SPLICE LEADS AND INSULATE.

# K867 UNIVERSAL ADAPTER / INVERTEC - CONNECTION DIAGRAM

**WARNING**



**ELECTRIC SHOCK CAN KILL**

- Turn off input power to the Welding Power Source using the disconnect switch at the fuse box Before connecting the wire feeder.
- Only qualified persons should install, use or service this machine.

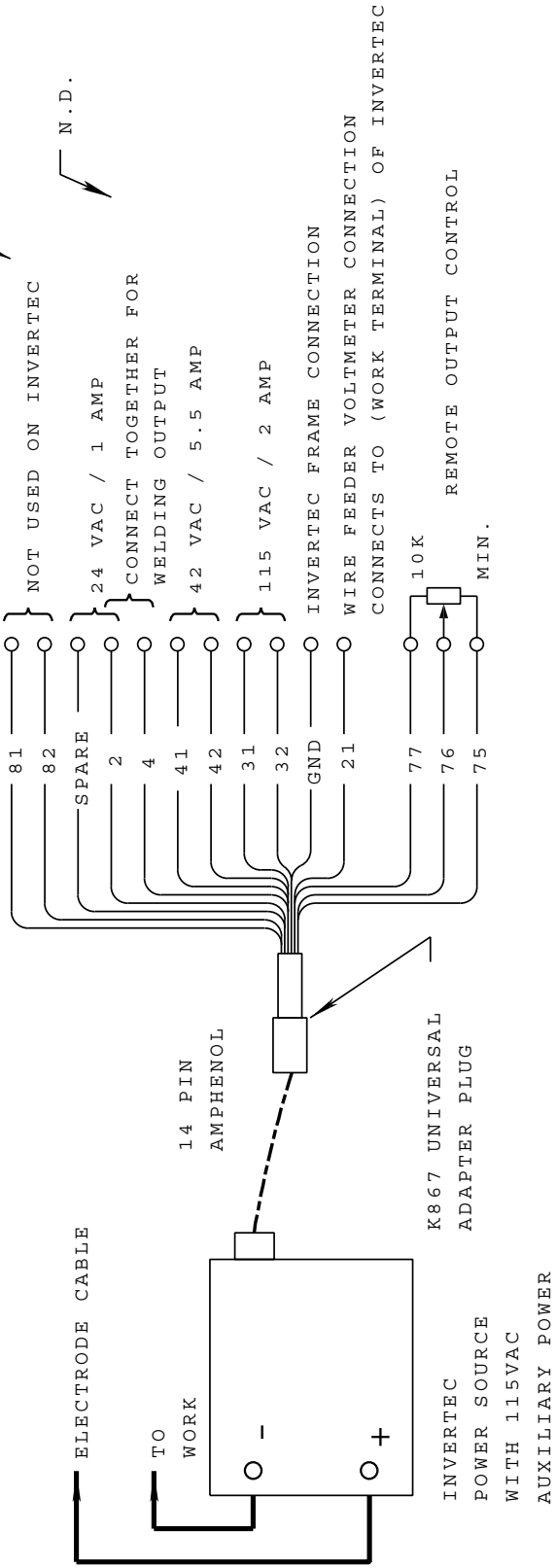

- N.A. WELDING CABLE MUST BE SIZED FOR CURRENT AND DUTY CYCLE OF APPLICATION.
- N.B. DIAGRAM SHOWS ELECTRODE POSITIVE. TO CHANGE POLARITY, TURN POWER "OFF", REVERSE ELECTRODE AND WORK CABLE AT POWER SOURCE.
- N.C. INSULATE EACH UNUSED LEAD INDIVIDUALLY.
- N.D. FOR WIRE FEEDERS THAT RETURN A SIGNAL FOR WELDING OUTPUT, USE ISOLATION RELAY TO CLOSE LEADS 2 & 4.

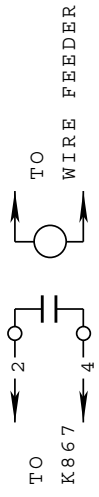

# K876 ADAPTER TO LN-25 - CONNECTION DIAGRAM

 <p><b>WARNING</b></p>	<ul style="list-style-type: none"> <li>• Turn off input power to the Welding Power Source using the disconnect switch at the fuse box Before connecting the wire feeder.</li> <li>• Only qualified persons should install, use or service this machine.</li> </ul>
<p><b>ELECTRIC SHOCK CAN KILL</b></p>	

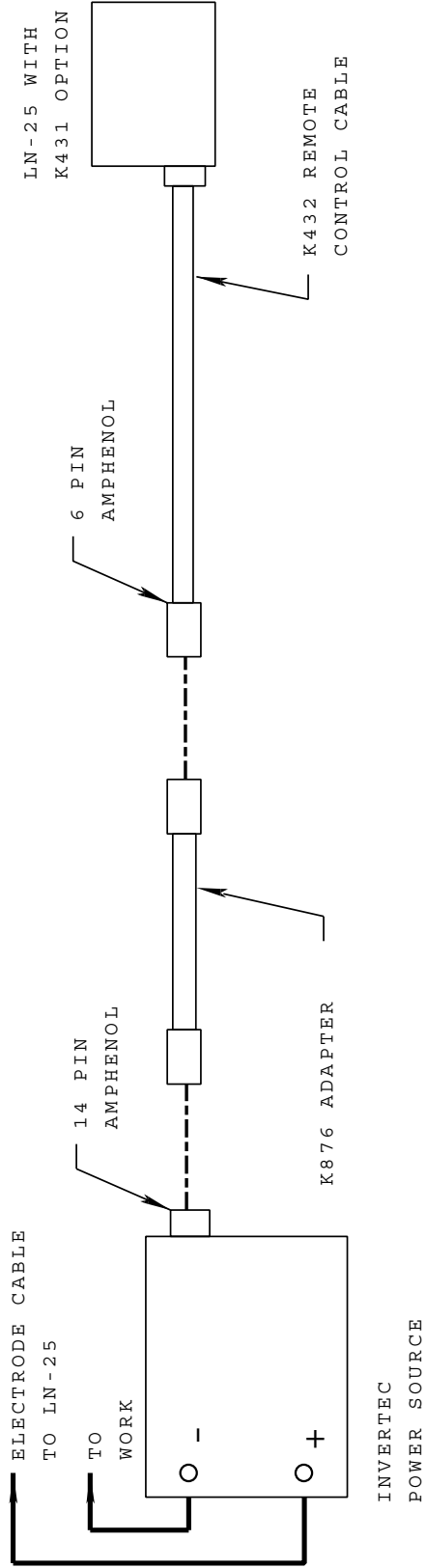

- N.A. WELDING CABLE MUST BE SIZED FOR CURRENT AND DUTY CYCLE OF APPLICATION.
- N.B. DIAGRAM SHOWS ELECTRODE POSITIVE. TO CHANGE POLARITY, TURN POWER "OFF", REVERSE ELECTRODE AND WORK CABLE AT POWER SOURCE.
- N.C. FOR INVERTECS WITH 6 PIN AMPHENOL, K432 CABLE CAN BE CONNECTED DIRECTLY.

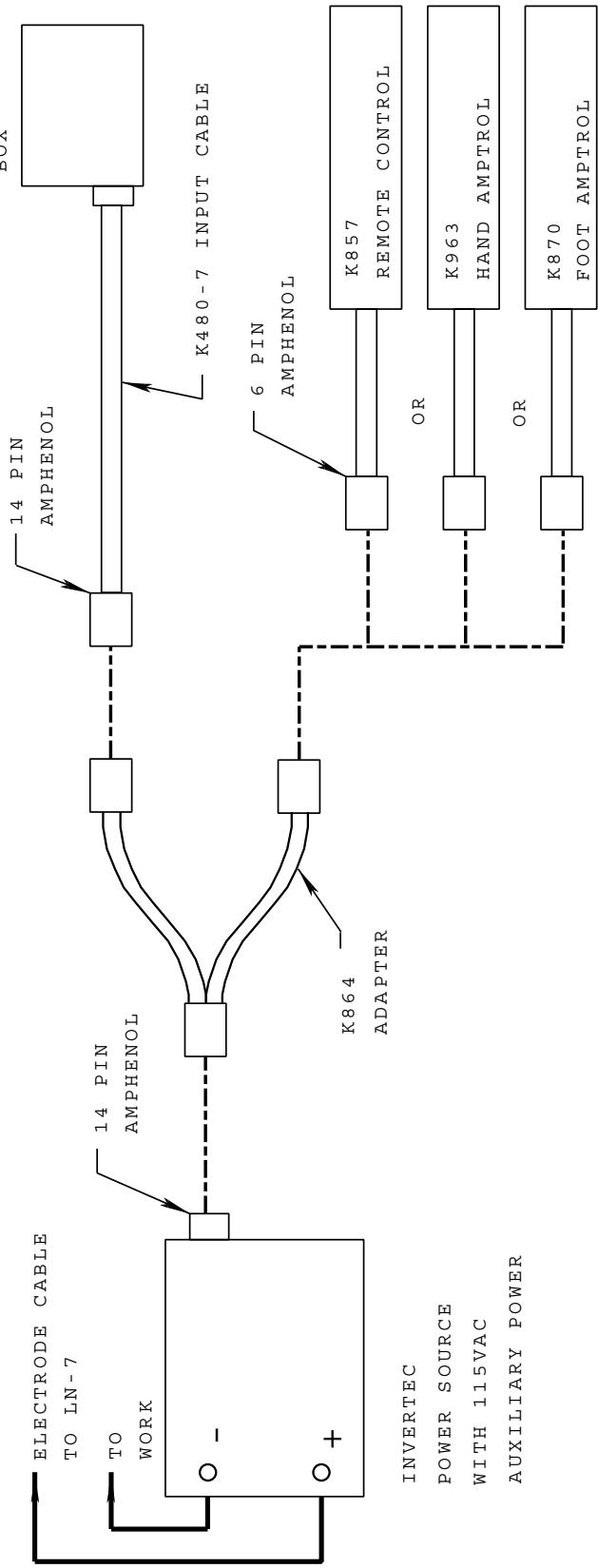

# K864 ADAPTER TO LN-7 & REMOTE CONTROL - CONNECTION DIAGRAM

 <p><b>WARNING</b></p>	<ul style="list-style-type: none"> <li>• Turn off input power to the Welding Power Source using the disconnect switch at the fuse box Before connecting the wire feeder.</li> <li>• Only qualified persons should install, use or service this machine.</li> </ul>
<p><b>ELECTRIC SHOCK CAN KILL</b></p>	



- N.A. WELDING CABLE MUST BE SIZED FOR CURRENT AND DUTY CYCLE OF APPLICATION.
- N.B. DIAGRAM SHOWS ELECTRODE POSITIVE. TO CHANGE POLARITY, TURN POWER "OFF", REVERSE ELECTRODE AND WORK CABLE AT POWER SOURCE.
- N.C. K480-7 INPUT CABLE CAN BE CONNECTED DIRECTLY IF REMOTE CONTROL IS NOT REQUIRED.
- N.D. K864 ADAPTER CANNOT BE USED WITH AN LN-25.

# K900-1 DC TIG STARTER - CONNECTION DIAGRAM

 <p style="text-align: center; margin: 0;"><b>WARNING</b></p>	<ul style="list-style-type: none"> <li>Turn off input power to the Welding Power Source using the disconnect switch at the fuse box before connecting the DC Tig Starter to the power source, or the Amptrol or Wire Feeder to the DC Tig Starter.</li> <li>Only qualified persons should install, use or service this machine.</li> </ul>
 <p style="text-align: center; margin: 0;"><b>ELECTRIC SHOCK CAN KILL</b></p>	

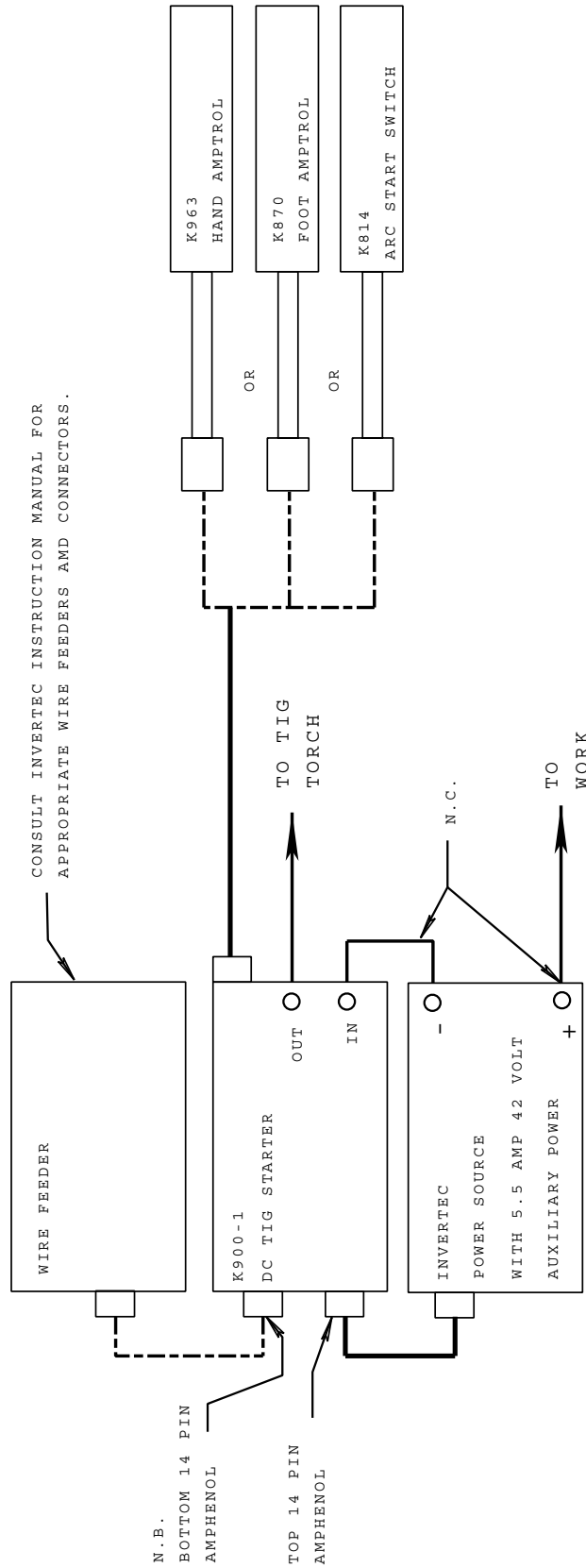

- N.A. WELDING CABLE MUST BE SIZED FOR CURRENT AND DUTY CYCLE OF APPLICATION.
- N.B. A WIRE FEEDER CAN BE PLUGGED INTO THE DC TIG STARTER TO REDUCE PROCESS CONVERSION TIME.
- N.C. SET UP SHOWN IS FOR DC NEGATIVE TIG WELDING. DC POSITIVE WELDING IS OBTAINED BY REVERSING THE OUTPUT CONNECTIONS ON THE INVERTEC AND SETTING THE INVERTEC'S ELECTRODE POLARITY SWITCH TO POSITIVE.

# LN-9 GMA WITH K596 CABLE TO INVERTEC - CONNECTION DIAGRAM

 <p><b>WARNING</b></p>	<ul style="list-style-type: none"> <li>• Turn off input power to the Welding Power Source using the disconnect switch at the fuse box before connecting the wire feeder.</li> <li>• Only qualified persons should install, use or service this machine.</li> </ul>
<p>ELECTRIC SHOCK CAN KILL</p>	

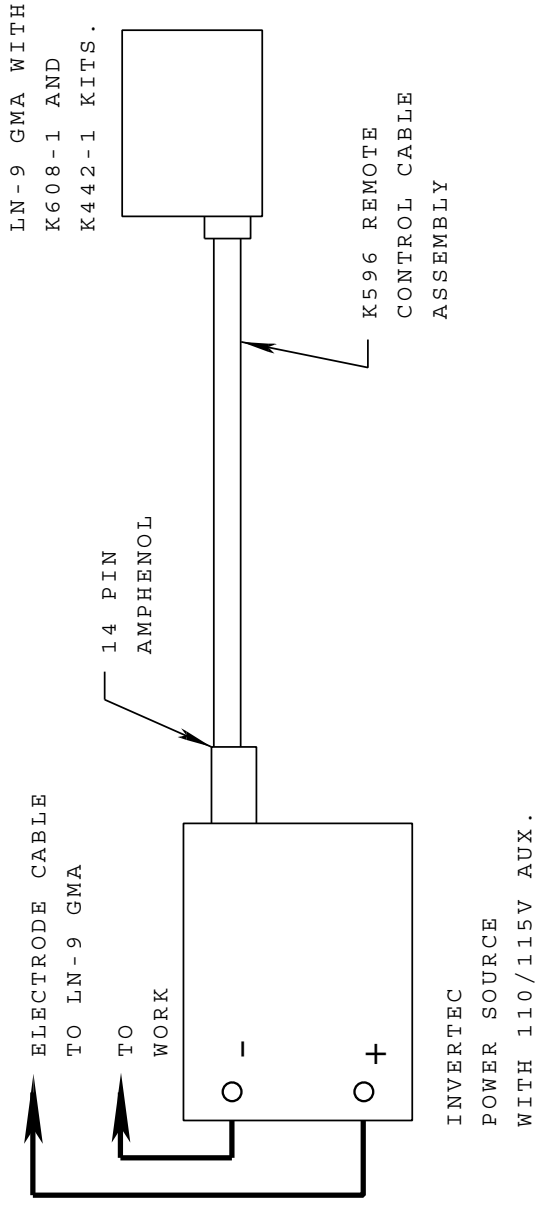

- N.A. WELDING CABLE MUST BE SIZED FOR CURRENT AND DUTY CYCLE OF APPLICATION.
- N.B. DIAGRAM SHOWS ELECTRODE POSITIVE. TO CHANGE POLARITY, TURN POWER "OFF", REVERSE ELECTRODE AND WORK CABLE AT POWER SOURCE. SET METER POLARITY SWITCH ON REAR OF INVERTEC TO COINCIDE WITH POLARITY USED. SET LN-9 GMA POLARITY SWITCH ALSO.
- N.C. INSTALL K608-1 ADAPTER IN LINE WITH P10 TO LN-9 GMA VOLTAGE BOARD PER INSTRUCTIONS IN V300 MANUAL.
- N.D. FOR GMA WELDING, INSTALL PULSE POWER FILTER KIT K442-1 IN LN-9 GMA.

LN-9 GMA WITH K196 CABLE AND K867 PLUG TO INVERTEC - CONNECTION DIAGRAM

**WARNING**



**ELECTRIC SHOCK CAN KILL**

- Turn off input power to the Welding Power Source using the disconnect switch at the fuse box Before connecting the wire feeder.
- Only qualified persons should install, use or service this machine.

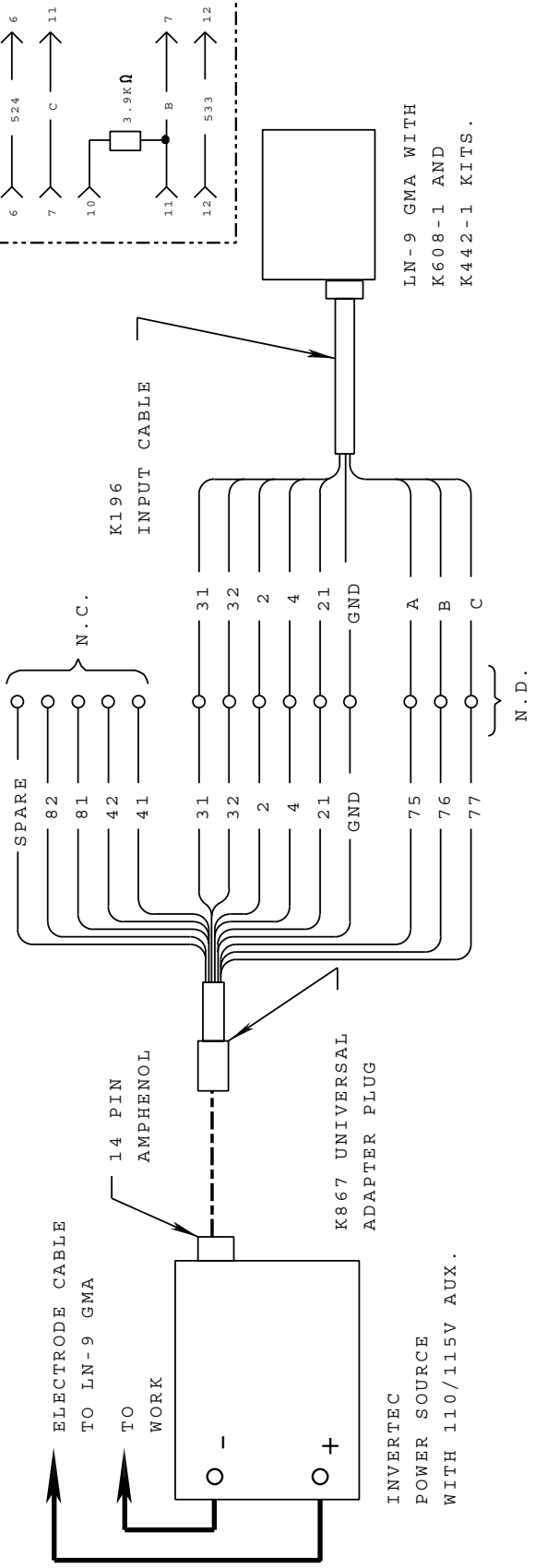

K608-1 CONNECTION DETAIL

P10, J10	2	530A	P10, J10	2
	3	521		3
	4	500		4
	5	500		5
	6	524		6
	7	C		11
	10			7
	11			12
	12			7

3.9KΩ

- N.A. WELDING CABLE MUST BE SIZED FOR CURRENT AND DUTY CYCLE OF APPLICATION.
- N.B. DIAGRAM SHOWS ELECTRODE POSITIVE. TO CHANGE POLARITY, TURN POWER "OFF", REVERSE ELECTRODE AND WORK CABLE AT POWER SOURCE. SET METER POLARITY SWITCH ON REAR OF INVERTEC TO COINCIDE WITH POLARITY USED. SET LN-9 GMA POLARITY SWITCH ALSO.
- N.C. INSULATE EACH UNUSED LEAD INDIVIDUALLY.
- N.D. SPLICE LEADS AND INSULATE.
- N.E. INSTALL K608-1 ADAPTER IN LINE WITH P10 TO LN-9 GMA VOLTAGE BOARD AND SECURE TO ADJACENT HARNESS WITH WIRE TIE PROVIDED. TURN "START" TRIMMER ON VOLTAGE BOARD FULLY 'CCW'.
- N.F. FOR GMAW WELDING, INSTALL PULSE POWER FILTER KIT K442-1 IN LN-9 GMA.

WIRING DIAGRAM V300-PRO Code 10256, V300-I Code 10258

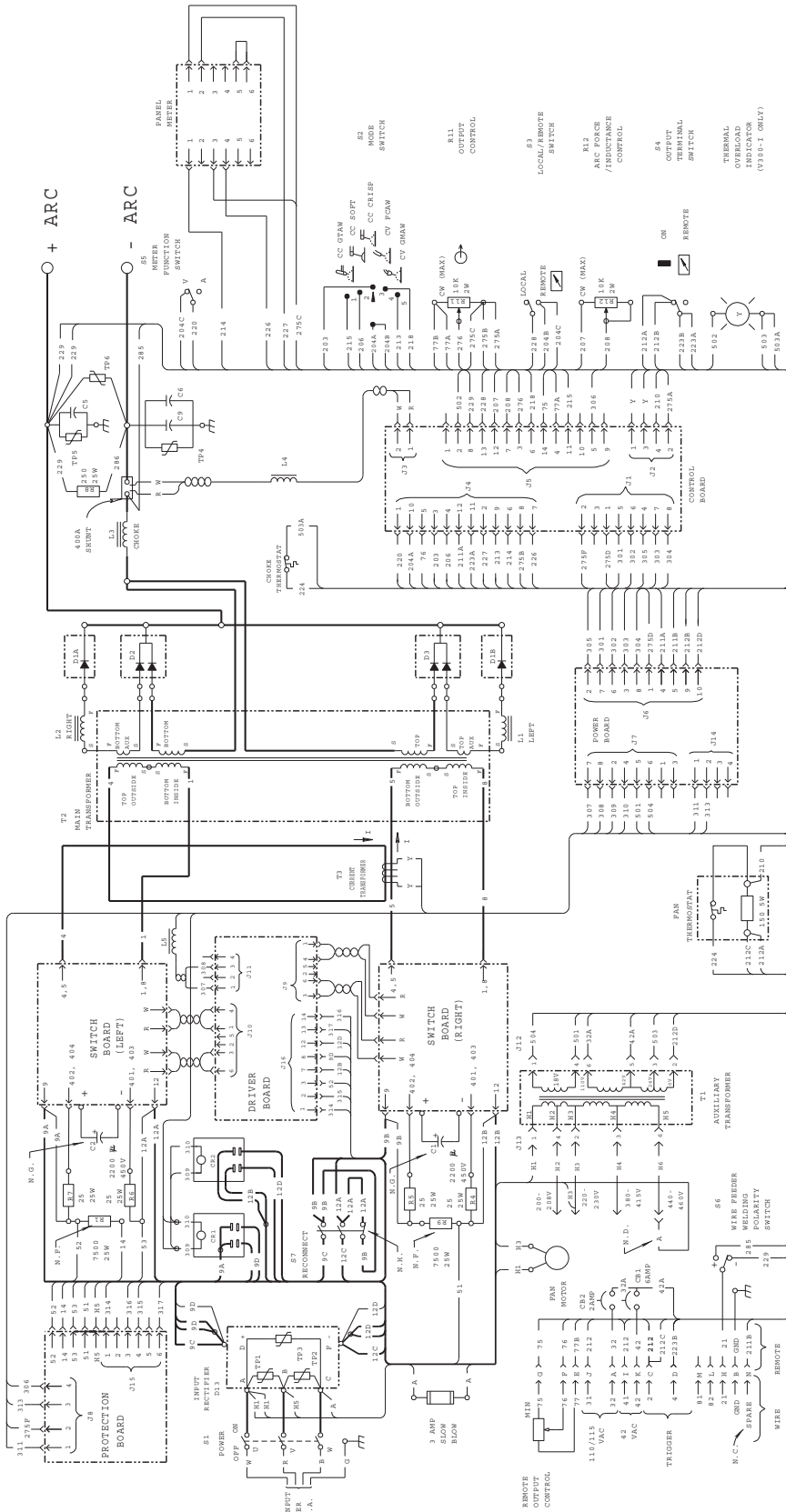

- NOTES:
- FOR MACHINES SUPPLIED WITH INPUT CABLES (V300-PRO) CONNECT BLACK & WHITE WIRES TO SUPPLY CIRCUIT. FOR SINGLE PHASE INPUT, CONNECT GREEN LEAD TO GROUND PER NATIONAL ELECTRIC CODE. WRAP RED LEAD WITH TAPE TO PROVIDE 100V. INSULATION. FOR THREE PHASE INPUT, CONNECT GREEN LEAD TO GROUND PER NATIONAL ELECTRIC CODE. FOR MACHINES NOT SUPPLIED WITH INPUT CABLES (V300-I) FOR SINGLE PHASE INPUT, GROUND MACHINE PER NATIONAL AND LOCAL ELECTRICAL CODES. CONNECT TERMINALS U & W TO SUPPLY CIRCUIT. FOR THREE PHASE INPUT, GROUND MACHINE PER NATIONAL AND LOCAL ELECTRICAL CODES. SINCE COMPONENTS OR CIRCUITS OF A PRINTED CIRCUIT BOARD MAY CHANGE WITHOUT AFFECTING THE INTERCHANGEABILITY OF A COMPLETE BOARD, THIS DIAGRAM MAY NOT SHOW THE EXACT COMPONENTS OR CIRCUITS HAVING A COMMON CODE NUMBER.
  - PLACE "A" LEAD ON APPROPRIATE CONNECTION FOR INPUT VOLTAGE. CONNECTION SHOWN IS FOR 440-460V OPERATION. N.F. R1, R9 BLEEDER RESISTORS ARE A MATCHED SET. N.G. C1, C2 CAPACITORS ARE A MATCHED SET. N.M. PLACE SWITCH IN APPROPRIATE POSITION FOR INPUT VOLTAGE. CONNECTION SHOWN IS FOR 385-465V OPERATION.

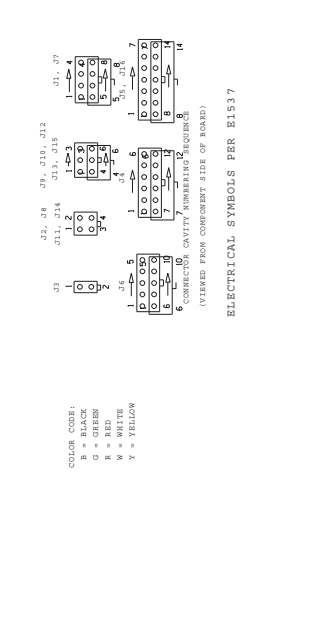
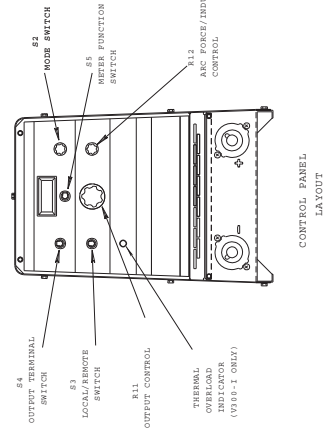

NOTE: This diagram is for reference only. It may not be accurate for all machines covered by this manual. The specific diagram for a particular code is pasted inside the machine on one of the enclosure panels. If the diagram is illegible, write to the Service Department for a replacement. Give the equipment code number.





# NOTES

---

INVERTEC V300-PRO & V300-I



# NOTES

---

INVERTEC V300-PRO & V300-I



# NOTES

---

INVERTEC V300-PRO & V300-I





<b>WARNING</b>	<ul style="list-style-type: none"> <li>Do not touch electrically live parts or electrode with skin or wet clothing.</li> <li>Insulate yourself from work and ground.</li> </ul>	<ul style="list-style-type: none"> <li>Keep flammable materials away.</li> </ul>	<ul style="list-style-type: none"> <li>Wear eye, ear and body protection.</li> </ul>
Spanish <b>AVISO DE PRECAUCION</b>	<ul style="list-style-type: none"> <li>No toque las partes o los electrodos bajo carga con la piel o ropa mojada.</li> <li>Aislese del trabajo y de la tierra.</li> </ul>	<ul style="list-style-type: none"> <li>Mantenga el material combustible fuera del área de trabajo.</li> </ul>	<ul style="list-style-type: none"> <li>Protéjase los ojos, los oídos y el cuerpo.</li> </ul>
French <b>ATTENTION</b>	<ul style="list-style-type: none"> <li>Ne laissez ni la peau ni des vêtements mouillés entrer en contact avec des pièces sous tension.</li> <li>Isolez-vous du travail et de la terre.</li> </ul>	<ul style="list-style-type: none"> <li>Gardez à l'écart de tout matériel inflammable.</li> </ul>	<ul style="list-style-type: none"> <li>Protégez vos yeux, vos oreilles et votre corps.</li> </ul>
German <b>WARNUNG</b>	<ul style="list-style-type: none"> <li>Berühren Sie keine stromführenden Teile oder Elektroden mit Ihrem Körper oder feuchter Kleidung!</li> <li>Isolieren Sie sich von den Elektroden und dem Erdboden!</li> </ul>	<ul style="list-style-type: none"> <li>Entfernen Sie brennbares Material!</li> </ul>	<ul style="list-style-type: none"> <li>Tragen Sie Augen-, Ohren- und Körperschutz!</li> </ul>
Portuguese <b>ATENÇÃO</b>	<ul style="list-style-type: none"> <li>Não toque partes elétricas e electrodos com a pele ou roupa molhada.</li> <li>Isole-se da peça e terra.</li> </ul>	<ul style="list-style-type: none"> <li>Mantenha inflamáveis bem guardados.</li> </ul>	<ul style="list-style-type: none"> <li>Use proteção para a vista, ouvido e corpo.</li> </ul>
Japanese <b>注意事項</b>	<ul style="list-style-type: none"> <li>通電中の電気部品、又は溶材にヒフやぬれた布で触れないこと。</li> <li>施工物やアースから身体が絶縁されている様にして下さい。</li> </ul>	<ul style="list-style-type: none"> <li>燃えやすいものの側での溶接作業は絶対にしてはなりません。</li> </ul>	<ul style="list-style-type: none"> <li>目、耳及び身体に保護具をして下さい。</li> </ul>
Chinese <b>警告</b>	<ul style="list-style-type: none"> <li>皮肤或湿衣物切勿接触带电部件及焊条。</li> <li>使你自已与地面和工作件绝缘。</li> </ul>	<ul style="list-style-type: none"> <li>把一切易燃物品移离工作场所。</li> </ul>	<ul style="list-style-type: none"> <li>佩戴眼、耳及身体劳动保护用具。</li> </ul>
Korean <b>위험</b>	<ul style="list-style-type: none"> <li>전도체나 용접봉을 젖은 형갑 또는 피부로 절대 접촉치 마십시오.</li> <li>모재와 접지를 접촉치 마십시오.</li> </ul>	<ul style="list-style-type: none"> <li>인화성 물질을 접근시키지 마십시오.</li> </ul>	<ul style="list-style-type: none"> <li>눈, 귀와 몸에 보호장구를 착용하십시오.</li> </ul>
Arabic <b>تحذير</b>	<ul style="list-style-type: none"> <li>لا تلمس الاجزاء التي يسري فيها التيار الكهربائي أو الألكترود بجسدك أو بالملابس المبللة بالماء.</li> <li>ضع عازلا على جسمك خلال العمل.</li> </ul>	<ul style="list-style-type: none"> <li>ضع المواد القابلة للاشتعال في مكان بعيد.</li> </ul>	<ul style="list-style-type: none"> <li>ضع أدوات وملابس واقية على عينيك وأذنيك وجسمك.</li> </ul>

READ AND UNDERSTAND THE MANUFACTURER'S INSTRUCTION FOR THIS EQUIPMENT AND THE CONSUMABLES TO BE USED AND FOLLOW YOUR EMPLOYER'S SAFETY PRACTICES.

SE RECOMIENDA LEER Y ENTENDER LAS INSTRUCCIONES DEL FABRICANTE PARA EL USO DE ESTE EQUIPO Y LOS CONSUMIBLES QUE VA A UTILIZAR, SIGA LAS MEDIDAS DE SEGURIDAD DE SU SUPERVISOR.

LISEZ ET COMPRENEZ LES INSTRUCTIONS DU FABRICANT EN CE QUI REGARDE CET EQUIPMENT ET LES PRODUITS A ETRE EMPLOYES ET SUIVEZ LES PROCEDURES DE SECURITE DE VOTRE EMPLOYEUR.

LESEN SIE UND BEFOLGEN SIE DIE BETRIEBSANLEITUNG DER ANLAGE UND DEN ELEKTRODENEINSATZ DES HERSTELLERS. DIE UNFALLVERHÜTUNGSVORSCHRIFTEN DES ARBEITGEBERS SIND EBENFALLS ZU BEACHTEN.

			
<ul style="list-style-type: none"> <li>● Keep your head out of fumes.</li> <li>● Use ventilation or exhaust to remove fumes from breathing zone.</li> </ul>	<ul style="list-style-type: none"> <li>● Turn power off before servicing.</li> </ul>	<ul style="list-style-type: none"> <li>● Do not operate with panel open or guards off.</li> </ul>	<b>WARNING</b>
<ul style="list-style-type: none"> <li>● Los humos fuera de la zona de respiración.</li> <li>● Mantenga la cabeza fuera de los humos. Utilice ventilación o aspiración para gases.</li> </ul>	<ul style="list-style-type: none"> <li>● Desconectar el cable de alimentación de poder de la máquina antes de iniciar cualquier servicio.</li> </ul>	<ul style="list-style-type: none"> <li>● No operar con panel abierto o guardas quitadas.</li> </ul>	Spanish <b>AVISO DE PRECAUCION</b>
<ul style="list-style-type: none"> <li>● Gardez la tête à l'écart des fumées.</li> <li>● Utilisez un ventilateur ou un aspirateur pour ôter les fumées des zones de travail.</li> </ul>	<ul style="list-style-type: none"> <li>● Débranchez le courant avant l'entretien.</li> </ul>	<ul style="list-style-type: none"> <li>● N'opérez pas avec les panneaux ouverts ou avec les dispositifs de protection enlevés.</li> </ul>	French <b>ATTENTION</b>
<ul style="list-style-type: none"> <li>● Vermeiden Sie das Einatmen von Schweißrauch!</li> <li>● Sorgen Sie für gute Be- und Entlüftung des Arbeitsplatzes!</li> </ul>	<ul style="list-style-type: none"> <li>● Strom vor Wartungsarbeiten abschalten! (Netzstrom völlig öffnen; Maschine anhalten!)</li> </ul>	<ul style="list-style-type: none"> <li>● Anlage nie ohne Schutzgehäuse oder Innenschutzverkleidung in Betrieb setzen!</li> </ul>	German <b>WARNUNG</b>
<ul style="list-style-type: none"> <li>● Mantenha seu rosto da fumaça.</li> <li>● Use ventilação e exaustão para remover fumo da zona respiratória.</li> </ul>	<ul style="list-style-type: none"> <li>● Não opere com as tampas removidas.</li> <li>● Desligue a corrente antes de fazer serviço.</li> <li>● Não toque as partes elétricas nuas.</li> </ul>	<ul style="list-style-type: none"> <li>● Mantenha-se afastado das partes moventes.</li> <li>● Não opere com os painéis abertos ou guardas removidas.</li> </ul>	Portuguese <b>ATENÇÃO</b>
<ul style="list-style-type: none"> <li>● ヒュームから頭を離すようにして下さい。</li> <li>● 換気や排煙に十分留意して下さい。</li> </ul>	<ul style="list-style-type: none"> <li>● メンテナンス・サービスに取りかかる際には、まず電源スイッチを必ず切って下さい。</li> </ul>	<ul style="list-style-type: none"> <li>● パネルやカバーを取り外したまま機械操作をしないで下さい。</li> </ul>	Japanese <b>注意事項</b>
<ul style="list-style-type: none"> <li>● 頭部遠離煙霧。</li> <li>● 在呼吸區使用通風或排風器除煙。</li> </ul>	<ul style="list-style-type: none"> <li>● 維修前切斷電源。</li> </ul>	<ul style="list-style-type: none"> <li>● 儀表板打開或沒有安全罩時不準作業。</li> </ul>	Chinese <b>警告</b>
<ul style="list-style-type: none"> <li>● 얼굴로부터 용접가스를 멀리하십시오.</li> <li>● 호흡지역으로부터 용접가스를 제거하기 위해 가스제거기나 통풍기를 사용하십시오.</li> </ul>	<ul style="list-style-type: none"> <li>● 보수전에 전원을 차단하십시오.</li> </ul>	<ul style="list-style-type: none"> <li>● 관널이 열린 상태로 작동치 마십시오.</li> </ul>	Korean <b>위험</b>
<ul style="list-style-type: none"> <li>● ابعد رأسك بعيداً عن الدخان.</li> <li>● استعمل التهوية أو جهاز ضغط الدخان للخارج لكي تبعد الدخان عن المنطقة التي تتنفس فيها.</li> </ul>	<ul style="list-style-type: none"> <li>● اقطع التيار الكهربائي قبل القيام بأية صيانة.</li> </ul>	<ul style="list-style-type: none"> <li>● لا تشغيل هذا الجهاز اذا كانت الاغطية الحديدية الواقية ليست عليه.</li> </ul>	Arabic <b>تحذير</b>

LEIA E COMPREENDA AS INSTRUÇÕES DO FABRICANTE PARA ESTE EQUIPAMENTO E AS PARTES DE USO, E SIGA AS PRÁTICAS DE SEGURANÇA DO EMPREGADOR.

使う機械や溶材のメーカーの指示書をよく読み、まず理解して下さい。そして貴社の安全規定に従って下さい。

請詳細閱讀並理解製造廠提供的說明以及應該使用的銀焊材料，並請遵守貴方的有閣勞動保護規定。

이 제품에 동봉된 작업지침서를 숙지하시고 귀사의 작업자 안전수칙을 준수하시기 바랍니다.

اقرأ بتعمق وافهم تعليمات المصنع المنتج لهذه المعدات والمواد قبل استعمالها واتبع تعليمات الوقاية لصاحب العمل.



• World's Leader in Welding and Cutting Products •

• Sales and Service through Subsidiaries and Distributors Worldwide •

Cleveland, Ohio 44117-1199 U.S.A. TEL: 216.481.8100 FAX: 216.486.1751 WEB SITE: [www.lincolnelectric.com](http://www.lincolnelectric.com)

—