

LN-10 Heads & Controls Boom Mount or Bench Models

For use with: LN-10 Control - Boom Mount Code 10442, 10831
 10 Series Wire Drive - Boom Mount Code 10443, 10444, 10763, 10764, 10818, 10819
 LN-10 Boom Package Code 10445, 10765, 10820
 Synergic 7F Drive Code 10190, 10191
 LN-10 - Bench Model Code 10440, 10441, 10761, 10762, 10816, 10817
 LN-10 - Zipline Boom Package Code 10497, 10498, 10771, 10772, 10824

Safety Depends on You

Lincoln arc welding and cutting equipment is designed and built with safety in mind. However, your overall safety can be increased by proper installation ... and thoughtful operation on your part. **DO NOT INSTALL, OPERATE OR REPAIR THIS EQUIPMENT WITHOUT READING THIS MANUAL AND THE SAFETY PRECAUTIONS CONTAINED THROUGHOUT.** And, most importantly, think before you act and be careful.

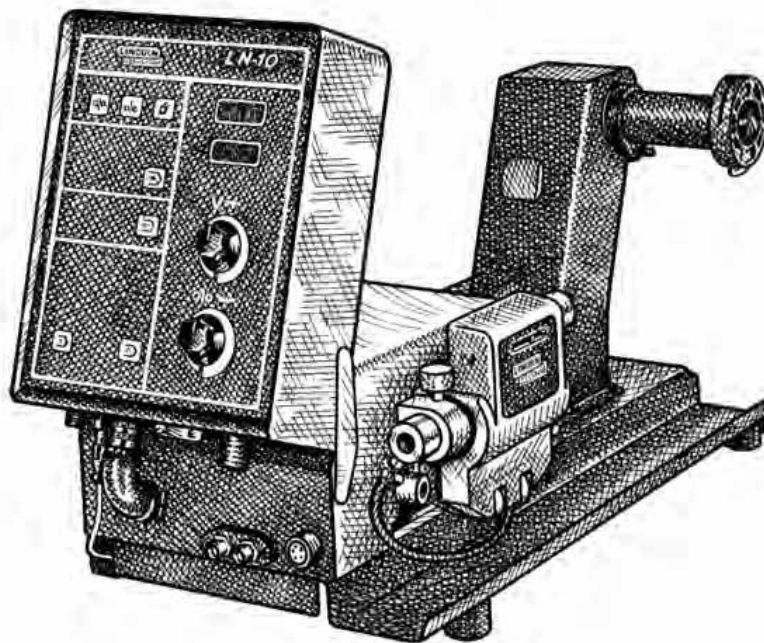

OPERATOR'S MANUAL



LINCOLN[®]
ELECTRIC

Copyright © 2007 Lincoln Global Inc.

• World's Leader in Welding and Cutting Products •

• Sales and Service through Subsidiaries and Distributors Worldwide •

Cleveland, Ohio 44117-1199 U.S.A. TEL: 216.481.8100 FAX: 216.486.1751 WEB SITE: www.lincolnelectric.com

! WARNING

! CALIFORNIA PROPOSITION 65 WARNINGS !

Diesel engine exhaust and some of its constituents are known to the State of California to cause cancer, birth defects, and other reproductive harm.

The Above For Diesel Engines

The engine exhaust from this product contains chemicals known to the State of California to cause cancer, birth defects, or other reproductive harm.

The Above For Gasoline Engines

ARC WELDING CAN BE HAZARDOUS. PROTECT YOURSELF AND OTHERS FROM POSSIBLE SERIOUS INJURY OR DEATH. KEEP CHILDREN AWAY. PACEMAKER WEARERS SHOULD CONSULT WITH THEIR DOCTOR BEFORE OPERATING.

Read and understand the following safety highlights. For additional safety information, it is strongly recommended that you purchase a copy of "Safety in Welding & Cutting - ANSI Standard Z49.1" from the American Welding Society, P.O. Box 351040, Miami, Florida 33135 or CSA Standard W117.2-1974. A Free copy of "Arc Welding Safety" booklet E205 is available from the Lincoln Electric Company, 22801 St. Clair Avenue, Cleveland, Ohio 44117-1199.

BE SURE THAT ALL INSTALLATION, OPERATION, MAINTENANCE AND REPAIR PROCEDURES ARE PERFORMED ONLY BY QUALIFIED INDIVIDUALS.



FOR ENGINE powered equipment.

1.a. Turn the engine off before troubleshooting and maintenance work unless the maintenance work requires it to be running.



1.b. Operate engines in open, well-ventilated areas or vent the engine exhaust fumes outdoors.



1.c. Do not add the fuel near an open flame welding arc or when the engine is running. Stop the engine and allow it to cool before refueling to prevent spilled fuel from vaporizing on contact with hot engine parts and igniting. Do not spill fuel when filling tank. If fuel is spilled, wipe it up and do not start engine until fumes have been eliminated.

1.d. Keep all equipment safety guards, covers and devices in position and in good repair. Keep hands, hair, clothing and tools away from V-belts, gears, fans and all other moving parts when starting, operating or repairing equipment.

1.e. In some cases it may be necessary to remove safety guards to perform required maintenance. Remove guards only when necessary and replace them when the maintenance requiring their removal is complete. Always use the greatest care when working near moving parts.



1.f. Do not put your hands near the engine fan. Do not attempt to override the governor or idler by pushing on the throttle control rods while the engine is running.

1.g. To prevent accidentally starting gasoline engines while turning the engine or welding generator during maintenance work, disconnect the spark plug wires, distributor cap or magneto wire as appropriate.



1.h. To avoid scalding, do not remove the radiator pressure cap when the engine is hot.



ELECTRIC AND MAGNETIC FIELDS may be dangerous

2.a. Electric current flowing through any conductor causes localized Electric and Magnetic Fields (EMF). Welding current creates EMF fields around welding cables and welding machines

2.b. EMF fields may interfere with some pacemakers, and welders having a pacemaker should consult their physician before welding.

2.c. Exposure to EMF fields in welding may have other health effects which are now not known.

2.d. All welders should use the following procedures in order to minimize exposure to EMF fields from the welding circuit:

2.d.1. Route the electrode and work cables together - Secure them with tape when possible.

2.d.2. Never coil the electrode lead around your body.

2.d.3. Do not place your body between the electrode and work cables. If the electrode cable is on your right side, the work cable should also be on your right side.

2.d.4. Connect the work cable to the workpiece as close as possible to the area being welded.

2.d.5. Do not work next to welding power source.

Mar '95



ELECTRIC SHOCK can kill.

- 3.a. The electrode and work (or ground) circuits are electrically "hot" when the welder is on. Do not touch these "hot" parts with your bare skin or wet clothing. Wear dry, hole-free gloves to insulate hands.
- 3.b. Insulate yourself from work and ground using dry insulation. Make certain the insulation is large enough to cover your full area of physical contact with work and ground.
- In addition to the normal safety precautions, if welding must be performed under electrically hazardous conditions (in damp locations or while wearing wet clothing; on metal structures such as floors, gratings or scaffolds; when in cramped positions such as sitting, kneeling or lying, if there is a high risk of unavoidable or accidental contact with the workpiece or ground) use the following equipment:**
- Semiautomatic DC Constant Voltage (Wire) Welder.
 - DC Manual (Stick) Welder.
 - AC Welder with Reduced Voltage Control.
- 3.c. In semiautomatic or automatic wire welding, the electrode, electrode reel, welding head, nozzle or semiautomatic welding gun are also electrically "hot".
- 3.d. Always be sure the work cable makes a good electrical connection with the metal being welded. The connection should be as close as possible to the area being welded.
- 3.e. Ground the work or metal to be welded to a good electrical (earth) ground.
- 3.f. Maintain the electrode holder, work clamp, welding cable and welding machine in good, safe operating condition. Replace damaged insulation.
- 3.g. Never dip the electrode in water for cooling.
- 3.h. Never simultaneously touch electrically "hot" parts of electrode holders connected to two welders because voltage between the two can be the total of the open circuit voltage of both welders.
- 3.i. When working above floor level, use a safety belt to protect yourself from a fall should you get a shock.
- 3.j. Also see Items 6.c. and 8.



ARC RAYS can burn.

- 4.a. Use a shield with the proper filter and cover plates to protect your eyes from sparks and the rays of the arc when welding or observing open arc welding. Headshield and filter lens should conform to ANSI Z87.1 standards.
- 4.b. Use suitable clothing made from durable flame-resistant material to protect your skin and that of your helpers from the arc rays.
- 4.c. Protect other nearby personnel with suitable, non-flammable screening and/or warn them not to watch the arc nor expose themselves to the arc rays or to hot spatter or metal.



FUMES AND GASES can be dangerous.

- 5.a. Welding may produce fumes and gases hazardous to health. Avoid breathing these fumes and gases. When welding, keep your head out of the fume. Use enough ventilation and/or exhaust at the arc to keep fumes and gases away from the breathing zone. **When welding with electrodes which require special ventilation such as stainless or hard facing (see instructions on container or MSDS) or on lead or cadmium plated steel and other metals or coatings which produce highly toxic fumes, keep exposure as low as possible and below Threshold Limit Values (TLV) using local exhaust or mechanical ventilation. In confined spaces or in some circumstances, outdoors, a respirator may be required. Additional precautions are also required when welding on galvanized steel.**
5. b. The operation of welding fume control equipment is affected by various factors including proper use and positioning of the equipment, maintenance of the equipment and the specific welding procedure and application involved. Worker exposure level should be checked upon installation and periodically thereafter to be certain it is within applicable OSHA PEL and ACGIH TLV limits.
- 5.c. Do not weld in locations near chlorinated hydrocarbon vapors coming from degreasing, cleaning or spraying operations. The heat and rays of the arc can react with solvent vapors to form phosgene, a highly toxic gas, and other irritating products.
- 5.d. Shielding gases used for arc welding can displace air and cause injury or death. Always use enough ventilation, especially in confined areas, to insure breathing air is safe.
- 5.e. Read and understand the manufacturer's instructions for this equipment and the consumables to be used, including the material safety data sheet (MSDS) and follow your employer's safety practices. MSDS forms are available from your welding distributor or from the manufacturer.
- 5.f. Also see item 1.b.

AUG 06

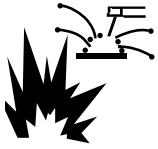

WELDING and CUTTING SPARKS can cause fire or explosion.

6.a. Remove fire hazards from the welding area. If this is not possible, cover them to prevent the welding sparks from starting a fire.

Remember that welding sparks and hot materials from welding can easily go through small cracks and openings to adjacent areas. Avoid welding near hydraulic lines. Have a fire extinguisher readily available.

- 6.b. Where compressed gases are to be used at the job site, special precautions should be used to prevent hazardous situations. Refer to "Safety in Welding and Cutting" (ANSI Standard Z49.1) and the operating information for the equipment being used.
- 6.c. When not welding, make certain no part of the electrode circuit is touching the work or ground. Accidental contact can cause overheating and create a fire hazard.
- 6.d. Do not heat, cut or weld tanks, drums or containers until the proper steps have been taken to insure that such procedures will not cause flammable or toxic vapors from substances inside. They can cause an explosion even though they have been "cleaned". For information, purchase "Recommended Safe Practices for the Preparation for Welding and Cutting of Containers and Piping That Have Held Hazardous Substances", AWS F4.1 from the American Welding Society (see address above).
- 6.e. Vent hollow castings or containers before heating, cutting or welding. They may explode.
- 6.f. Sparks and spatter are thrown from the welding arc. Wear oil free protective garments such as leather gloves, heavy shirt, cuffless trousers, high shoes and a cap over your hair. Wear ear plugs when welding out of position or in confined places. Always wear safety glasses with side shields when in a welding area.
- 6.g. Connect the work cable to the work as close to the welding area as practical. Work cables connected to the building framework or other locations away from the welding area increase the possibility of the welding current passing through lifting chains, crane cables or other alternate circuits. This can create fire hazards or overheat lifting chains or cables until they fail.
- 6.h. Also see item 1.c.
- 6.i. Read and follow NFPA 51B "Standard for Fire Prevention During Welding, Cutting and Other Hot Work", available from NFPA, 1 Batterymarch Park, PO box 9101, Quincy, Ma 022690-9101.
- 6.j. Do not use a welding power source for pipe thawing.

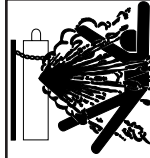

CYLINDER may explode if damaged.

- 7.a. Use only compressed gas cylinders containing the correct shielding gas for the process used and properly operating regulators designed for the gas and pressure used. All hoses, fittings, etc. should be suitable for the application and maintained in good condition.
- 7.b. Always keep cylinders in an upright position securely chained to an undercarriage or fixed support.
- 7.c. Cylinders should be located:
 - Away from areas where they may be struck or subjected to physical damage.
 - A safe distance from arc welding or cutting operations and any other source of heat, sparks, or flame.
- 7.d. Never allow the electrode, electrode holder or any other electrically "hot" parts to touch a cylinder.
- 7.e. Keep your head and face away from the cylinder valve outlet when opening the cylinder valve.
- 7.f. Valve protection caps should always be in place and hand tight except when the cylinder is in use or connected for use.
- 7.g. Read and follow the instructions on compressed gas cylinders, associated equipment, and CGA publication P-1, "Precautions for Safe Handling of Compressed Gases in Cylinders," available from the Compressed Gas Association 1235 Jefferson Davis Highway, Arlington, VA 22202.



FOR ELECTRICALLY powered equipment.

- 8.a. Turn off input power using the disconnect switch at the fuse box before working on the equipment.
- 8.b. Install equipment in accordance with the U.S. National Electrical Code, all local codes and the manufacturer's recommendations.
- 8.c. Ground the equipment in accordance with the U.S. National Electrical Code and the manufacturer's recommendations.

Jan, 07

Mar. '93



Thank You

for selecting a **QUALITY** product by Lincoln Electric. We want you to take pride in operating this Lincoln Electric Company product ... as much pride as we have in bringing this product to you!

CUSTOMER ASSISTANCE POLICY

The business of The Lincoln Electric Company is manufacturing and selling high quality welding equipment, consumables, and cutting equipment. Our challenge is to meet the needs of our customers and to exceed their expectations. On occasion, purchasers may ask Lincoln Electric for advice or information about their use of our products. We respond to our customers based on the best information in our possession at that time. Lincoln Electric is not in a position to warrant or guarantee such advice, and assumes no liability, with respect to such information or advice. We expressly disclaim any warranty of any kind, including any warranty of fitness for any customer's particular purpose, with respect to such information or advice. As a matter of practical consideration, we also cannot assume any responsibility for updating or correcting any such information or advice once it has been given, nor does the provision of information or advice create, expand or alter any warranty with respect to the sale of our products.

Lincoln Electric is a responsive manufacturer, but the selection and use of specific products sold by Lincoln Electric is solely within the control of, and remains the sole responsibility of the customer. Many variables beyond the control of Lincoln Electric affect the results obtained in applying these types of fabrication methods and service requirements.

Subject to Change – This information is accurate to the best of our knowledge at the time of printing. Please refer to www.lincolnelectric.com for any updated information.

Please Examine Carton and Equipment For Damage Immediately

When this equipment is shipped, title passes to the purchaser upon receipt by the carrier. Consequently, Claims for material damaged in shipment must be made by the purchaser against the transportation company at the time the shipment is received.

Please record your equipment identification information below for future reference. This information can be found on your machine nameplate.

Product _____

Model Number _____

Code Number or Date Code _____

Serial Number _____

Date Purchased _____

Where Purchased _____

Whenever you request replacement parts or information on this equipment, always supply the information you have recorded above. The code number is especially important when identifying the correct replacement parts.

On-Line Product Registration

- Register your machine with Lincoln Electric either via fax or over the Internet.
- For faxing: Complete the form on the back of the warranty statement included in the literature packet accompanying this machine and fax the form per the instructions printed on it.
- For On-Line Registration: Go to our **WEB SITE at www.lincolnelectric.com**. Choose "Quick Links" and then "Product Registration". Please complete the form and submit your registration.

Read this Operators Manual completely before attempting to use this equipment. Save this manual and keep it handy for quick reference. Pay particular attention to the safety instructions we have provided for your protection. The level of seriousness to be applied to each is explained below:

WARNING

This statement appears where the information **must** be followed **exactly** to avoid **serious personal injury** or **loss of life**.

CAUTION

This statement appears where the information **must** be followed to avoid **minor personal injury** or **damage to this equipment**.

	Page
Installation	Section A
Technical Specifications	A-1
General Description	A-1
Recommended Processes and Equipment	A-2
Installation of the LN-10 Boom Mount Wire Feeder Components	A-2
Mounting the LN-10 Wire Drive Unit	A-2
Mounting Synergic 7F Wire Drive Unit (K679-1 or -2)	A-3
Mounting the LN-10 Control Box	A-3
Connecting Wire Drive Unit to Control Box	A-3
Electrode Routing	A-4
Wire Drive Speed Range Selection	A-4
Control Speed Range Setting	A-4
10 Series Wire Drive Ratio Selection	A-4
Wire Feed Drive Roll Kits	A-5
Procedure to Install Drive Roll and Guide Tubes	A-5
Synergic 7F 4-Roll Kits (KP655 and KP656)	A-5
10 Series Wire Drive Roll Kit Installation	A-5
Gun and Cable Assemblies with Standard Connection	A-6
GMAW Guns	A-6
Innershield Guns	A-6
Gun Cable Connection with Standard Connection	A-6
Gun and Cable Assemblies with Fast-Mate Connection	A-6
GMAW Guns	A-6
Gun Cable Connection with Fast-Mate Connection	A-7
Water Connections (For Water Cooled Guns)	A-7
10 Series Wire Drives	A-7
Synergic 7F Drives (K679)	A-7
GMAW Shielding Gas	A-7
Gas Guard Regulator	A-7
Electrical Installation	A-8
Input Cable: LN-10 Control to Power Source	A-8
Work Cable	A-8
Optional Features Installation	A-9
Boom and Bench Conversions	A-9
<hr/>	
Operation	Section B
Safety Precautions	B-1
Duty Cycle	B-1
LN-10 Control DIP Switch Setup	B-1 thru B-5
Keypad and Display Operation	B-6 thru B-9
Dual Procedure Remote Control (K1449-1)	10
Wire Reel Loading	B-10
Feeding Electrode and Brake Adjustment	B-11
Drive Roll Pressure Setting	B-11
Procedure for Setting Angle of Feedplate	B-12
Gas Guard Regulator Setting	B-12
Making a Weld	B-12
Wire Reel Changing	B-13
Loss of Voltage Sense Shutdown	B-13
Wire Feed Overload Protection	B-13
Grounding Lead Protector	B-13
Explanation of Prompting and Error Messages	B-14
<hr/>	
Accessories	Section C
Drive Roll and Guide Tube Kits	C-1
Other Optional Features	C-2 thru C-4
<hr/>	
Maintenance	Section D
Safety Precautions	D-1
Routine Maintenance	D-1
Avoiding Wire Feeding Problems	D-1
Periodic Maintenance	D-1
Procedure for Removing Feedplate from Wire Feeder	D-1
<hr/>	
Troubleshooting	Section E
Safety Precautions	E-1
Troubleshooting Procedures	E-2 Thru E-8
Procedure for Replacing PC Boards	E-9

TABLE OF CONTENTS

	Page
Diagrams	Section F
Wiring (LN-10 Control)	F-1
Wiring (10 Series Wire Drive)	F-2
Dimension Print.....	F-3
<hr/>	
Parts List	P311 Series
<hr/>	

TECHNICAL SPECIFICATIONS – LN-10 Heads & Controls

WIRE DRIVE OR WIRE DRIVE SECTION OF FEEDER							
SPEC.#	TYPE	Speed	Wire Size		Speed	Wire Size	
			LOW SPEED RATIO	HIGH SPEED RATIO		Solid	Cored
K1563-1,-3 Std Drive	10 Series Boom Mount	35-500 IPM (0.89-12.7 M/M)	.025 - 3/32 in. (0.6 - 2.4 mm)	.035 - .120 in. (0.9 - 3.0 mm)	.50 - 750 IPM (1.25 - 19.0 M/M)	.025 - 1/16 in. (0.6 - 1.6 mm)	.035 - 5/64 in. (0.9 - 2.0 mm)
K1563-2,-4 Hi-Speed	10 Series Boom Mount	55 - 825 IPM (1.40 - 21.0 M/M)	.025 - 1/16 in. (0.6 - 1.6 mm)	.035 - 5/64 in. (0.9 - 2.0 mm)	80 - 1250 IPM (2.00 - 31.8 M/M)	.025 - .045 in. (0.6 - 1.2 mm)	.035 - .045 in. (0.9 - 1.2 mm)
K679-1 Std Drive	Synergic 7F* Boom Mount	50 - 770 IPM (1.27 - 19.5 M/M)	.025 - 1/16 in. (0.6 - 1.6 mm)	.035 - 5/64 in. (0.9 - 2.0 mm)	---	---	---
K679-2 Hi-Speed	Synergic 7F* Boom Mount	---	---	---	80 - 1200 IPM (2.00 - 30.5 M/M)	.025 - .045 in. (0.6 - 1.2 mm)	.035 - .045 in. (0.9 - 1.2 mm)
K1559-1,-3 Std Drive	LN-10 Bench Model	35-500 IPM (0.89-12.7 M/M)	.025 - 3/32 in. (0.6 - 2.4 mm)	.035 - .120 in. (0.9 - 3.0 mm)	50 - 750 IPM (1.25 - 19.0 M/M)	.025 - 1/16 in. (0.6 - 1.6 mm)	.035 - 5/64 in. (0.9 - 2.0 mm)
K1559-2,-4 Hi-Speed	LN-10 Bench Model	55 - 825 IPM (1.40 - 21.0 M/M)	.025 - 1/16 in. (0.6 - 1.6 mm)	.035 - 5/64 in. (0.9 - 2.0 mm)	80 - 1250 IPM (2.00 - 31.8 M/M)	.025 - .045 in. (0.6 - 1.2 mm)	.035 - .045 in. (0.9 - 1.2 mm)

CONTROLS, HEADS AND COMPLETE UNITS								
SPEC.#	TYPE	INPUT POWER	PHYSICAL SIZE			Weight	TEMPERATURE RATING	
			Height	Width	Depth		Operating	Storage
K1562-1Δ,-2Δ Control	LN-10 Controls	40-42 Vac + 10% 4.0 Amps 50/60 Hz (K1562-1) 6.0 Amps 50/60 Hz (K1562-2)	14.80 " (375.9 mm)	14.20 " (360.7mm)	4.20 " (106.7 mm)	18.0 Lbs (8.2 Kg)	K-1563-1,-2 K-1563-3,-4	+40°C to -20°C +40°C to -40°C
K1563-1Δ,-3Δ Std Drive	10 Series Boom Mount	X	7.81 " (198.4 mm)	14.71 " (373.6 mm)	11.00" (27.94 mm)	25.0 Lbs (11.3 Kg)		
K1563-2,-4 Hi-Speed						30.0 Lbs (13.6 Kg)		
K679-1 Std Drive	Synergic 7F* Boom Mount	X	11.5" (285.8mm)	7.16" (181.9 mm)	8.06" (204.7mm)	16.5 Lbs (7.5 Kg.)		
K679-2 Hi-Speed	Synergic 7F* Boom Mount							
K1559-1,-3 Std Drive	LN-10 Bench Model	40-42 Vac + 10% 4.0 Amps 50/60 Hz (K1559-1,-2) 6.0 Amps 50/60 Hz (K1559-3,-4)	20.46 " (519.7 mm)	14.73 " (366.5 mm)	30.35 " (770.9 mm)	65.0 Lbs (29.5 Kg)		
K1559-2,-4 Hi-Speed						70.0 Lbs (31.8 Kg)		

• Excluding Wire Reel
 Δ Included with K1561-Series, LN-10 Boom Packages
 *Synergic 7F wire drives use 4-roll drives with 2 driven rolls(Drive roll kits not common with 10 Series heads)

GENERAL DESCRIPTION

The LN-10 is a modular line of 42VAC input 4-roll wire feeders. A single control with dual procedure presettability of wire feed speed (in IPM or M/min) and arc voltage is used with a single DC welding power source.

The LN-10 models have controls providing keypad or remote selectability of either of two procedures.

The units offer 4 independently selectable gun trigger modes for each procedure; cold feed, 2 step and 4-step trigger and spot weld mode.

Also, 4 selectable, presettable timers for each procedure; preflow, postflow, burnback and spot weld time.

Arc starting can be optimized for each procedure with 5 selectable wire feed acceleration rates, and independent control of slower run-in procedure.

A gas purge key is provided, as well as cold feed forward and reverse keys with independently adjustable forward feed speed setting.



All of these features are selected with a tactile-feel keypad, and are set independently using one of two rotating knob encoders, setting levels are displayed on one of two digital LED displays.

The 10 Series Wire Drive assemblies include a heavy duty head with externally changeable gear ratio and 4 driven roll drives housed together in a single combination mounting and connection box. Gun adapters are available to permit use with a variety of standard welding guns.

Available Models:

The LN-10 Wire Feeder system is available configured in both Bench and Boom models.

Bench Models consists of an LN-10 control and a 10 Series wire drive assembly premounted on a platform with a dual 2" O.D. spindle mounting.

Boom Models consist of an LN-10 control and a choice of wire drives designed to be mounted separately and joined by available head to control cable assemblies.

The head to control cable assemblies are available in two types; one control cable is required for each head:

K1498-"L" Includes a control cable with a 14-pin ms style connection on each end, and a 3/0 weld cable. Available in lengths "L" of 16, 20 or 25 ft. (4.9, 6.1 or 7.6 m)

K681-"L" Same as above but does not include weld cable available in lengths "L" of 12, 16 or 25 ft. (3.6, 4.9 or 7.6 m).

LN-10 Boom Packages (K1564-Series) are also available which include:

- LN-10 Control Box
- 10 Series Wire Drive
- Appropriate length Control and Weld Cables to connect Control to Wire Drive
- Accessories specific to the Boom package ordered

RECOMMENDED PROCESSES AND EQUIPMENT

The LN-10 Wire Feeder system is recommended for use with solid wire gas-metal-arc or CV Submerged arc processes, as well as cored wire for Outershield GMA or Innershield processes.

The wire type and size range for the wire drive used, and gear ratio change selected, are given in the Specifications.

Recommended power sources are Lincoln Electric Company constant voltage power sources with 42 VAC auxiliary power and a 14-pin connector receptacle. At the time of printing these include: CV 250, CV300-I, CV-300, CV400-I, CV-400, CV500-I, DC-400, DC-600, CV-655, Invertec V300-PRO, V350-PRO DC-650 PRO and DC- 655.

The DC-250, DC-1000 and the Pulse Power 500 (CV mode only) may also be used with the LN-10 if the optional K1520-1 115V / 42V Transformer Kit is used.

SAFETY PRECAUTIONS



ELECTRIC SHOCK can kill.

- Turn the input power off at the power source disconnect switch before attempting to connect the input power to the LN-10 Control.

- Only qualified personnel should perform this installation.

INSTALLATION OF THE LN-10 BOOM MOUNT WIRE FEEDER COMPONENTS

Mounting the 10 Series Double Header Wire Drive

Mount the 10 Series wire drive to the boom or structure using the four 5/16-18 threaded mounting holes located on the bottom of the drive connection box. See Figure A.1 for the size and location of the mounting holes. The feed plate assembly is electrically "hot" when the gun trigger is pressed. Therefore, make certain the feed plate does not come in contact with the structure on which the unit is mounted.

The wire drive unit should be mounted so that the drive rolls are in a vertical plane so dirt will not collect in the drive roll area. Pivot the feed plate so it will point down at an angle so the wire feed gun cable will not be bent sharply as it comes from the unit. See "Procedure for setting angle of Feed Plate" in the OPERATION section of this manual.

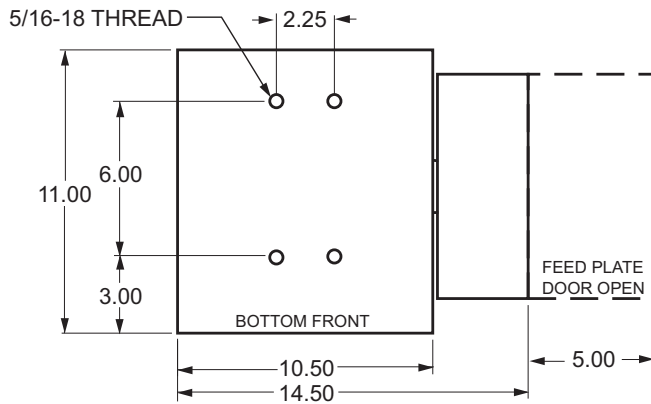

FIGURE A.1

Mounting Synergic 7F Wire Drive Unit (K679-1 or -2)

Mount the wire feed unit by means of the insulated mounting bracket attached to the bottom of the gearbox. Reference L9777 (included with Drive unit) to find the size and location of the mounting holes. The gearbox assembly is electrically "hot" when the gun trigger is pressed. Therefore, make certain the gearbox does not come in contact with the structure on which the unit is mounted.

The wire feed unit should be mounted so that the drive rolls are in a vertical plane so dirt will not collect in the drive roll area. Position the mechanism so it will point down at about a 45° angle so the wire feed gun cable will not be bent sharply as it comes from the unit.

Note: The K1562-1 control box must be used with the K679-1 or -2.

Mounting the LN-10 Control Box

The same control box is used for both a 10 Series drive, or a Synergic 7F drive. The back plate of the control box has two keyhole slots and one bottom slot for mounting. See Figure A.2 for the size and location of these slots. Mount the box at some convenient location close to the wire drive unit which will enable the desired control cable to reach between the control box and the wire drive unit.

- Drill the required holes in the mounting surface, partially install 1/4-20 screws.
- Mount the box.
- Tighten the screws.

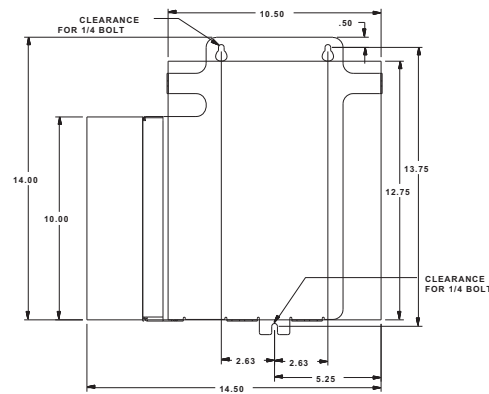

FIGURE A.2

Connecting Wire Drive Unit to Control Box

One head to control cable assembly is required. The Head to Control cable assemblies are available in two types:

K1498-"L" -Includes a control cable with 14-pin ms-style connectors on each end, and a 3/0 weld cable (rated 600 amps, 60% duty cycle) to route between the wire drive and the control box. Available in lengths "L" of 16 ft. (4.9 m), 20 ft. (6.1 m) and 25 ft. (7.6 m)

K681-"L" - Same as K1498, but does not include weld cable. Available in lengths "L" of 12 ft (3.6 m), 16 ft (4.9 m) and 25 ft. (7.6 m).

- Making certain the cables are protected from any sharp corners which may damage their jackets, mount the cable assembly along the boom so the end with the female amphenol connector pins is at the wire feed unit.
- Connect the 14-socket cable connectors to the mating receptacles on the back of the wire feed unit connection box.
- At the same end, connect the electrode lead to the 1/2" connection bolt on the front of the left wire drive head feed plate.
- At the control box end, connect the 14 pin connectors of the cable to the mating receptacle on the bottom of the control box.
- At the control box current sensor, slip the cover box up off the sensor and connect the electrode cable(s) to the top bolt connection.

Electrode Routing

The electrode supply may be either from reels, Readi-Reels, spools, or bulk packaged drums or reels. Observe the following precautions:

- a) The electrode must be routed to the wire drive unit so that the bends in the wire are at a minimum, and also that the force required to pull the wire from the reel into the wire drive unit is kept at a minimum.
- b) The electrode is "hot" when the gun trigger is pressed and must be insulated from the boom and structure.
- c) If more than one wire feed unit shares the same boom and are not sharing the same power source output stud, their wire and reels must be insulated from each other as well as insulated from their mounting structure.

WIRE DRIVE SPEED RANGE SELECTION

The rated speed and wire size range for each wire drive head is shown in the SPECIFICATIONS in the front of this section.

Control Speed Range Setting

The speed range is set up to match the wire feed head connected to the LN-10 control by properly setting the switch (S1) code on the control board inside the control box. See OPERATION "Setting the DIP Switches" for setting instructions.

10 Series Wire Drive Ratio Selection

The 10 Series type drives include two external gear sizes; a 1" dia. gear and a 1-1/2" dia. gear. The smaller gear provides the low speed range ratio, and the larger gear provides the high speed range ratio per the SPECIFICATIONS in the front of this section.

The following procedure is for changing ratio of the 10 Series wire drive:

- 1) Pull open the Pressure Door.
- 2) Remove the Phillips head screw retaining the pinion gear to be changed and remove the gear. If the gear is not easily accessible or difficult to remove, remove the feedplate from the gearbox. To remove feedplate:

- a) Loosen the clamping collar screw using a 3/16" Allen wrench. The clamping collar screw is accessed from the bottom of the feedplate. It is the screw which is perpendicular to the feeding direction.
- b) Loosen the retaining screw, which is also accessed from bottom of feeder, using a 3/16" Allen wrench. Continue to loosen the screw until the feedplate can be easily pulled off of the wire feeder.
- 3) Loosen, but do not remove, the screw on the lower right face of the feedplate with a 3/16" Allen wrench.
- 4) Remove the screw on the left face of the feedplate. If changing from high speed (larger gear) to low speed (smaller gear), line the lower hole on the left face of the feedplate with the threads on the clamping collar. Line the upper hole with the threads to install larger gear for high speed feeder. If feedplate does not rotate to allow holes to line up, further loosen the screw on right face of feedplate.
- 5) Install gear onto output shaft and secure with flat washer, lock washer, and Phillips head screw which were previously removed.
- 6) Tighten the screw on lower right face of feedplate.
- 7) Re-attach feedplate to wire feeder if removed in Step 2.
- 8) Feedplate will be rotated out-of-position due to the gear change. To re-adjust angle of feedplate:
 - a) Loosen the clamping collar using a 3/16" Allen wrench. The clamping collar screw is accessed from the bottom of the feedplate. It is the screw which is perpendicular to the feeding direction.
 - b) Rotate feedplate to the desired angle and tighten clamping collar screw.
- 9) Make sure to properly set the switch (S2) code on the control board inside the control box for the new gear size installed. See OPERATION "Setting the DIP Switch" for setting instructions.

WIRE FEED DRIVE ROLL KITS

NOTE: The maximum rated solid and cored wire sizes for each wire drive head and selected drive ratio is shown on the SPECIFICATIONS in the front of this section.

The electrode sizes that can be fed with each roll and guide tube are stenciled on each part. Check the kit for proper components.

Synergic 7F Wire Drives (K679) use 4-Roll drive roll kits with 2 driven rolls, per Table C.1 in ACCESSORIES. These kits are common with those used for the 4-Roll LN-7 GMA and LN-9 GMA Lincoln Wire Feeders, but are not common with those used with the 10 Series wire drive units. Installation instructions are included with the kits.

10 Series Wire Drives use 4-Roll drive roll kits with 4 driven rolls, per Table C.1 in ACCESSORIES.

PROCEDURE TO INSTALL DRIVE ROLL AND WIRE GUIDES

⚠ WARNING



ELECTRIC SHOCK can kill.

- Do not touch electrically live parts such as output terminals or internal wiring.
- When inching with gun trigger, electrode and drive mechanism are “hot” to work and ground and could remain energized several seconds after the gun trigger is released.
- Turn OFF input power at welding power source before installation or changing drive roll and/or guide tubes.
- Welding power source must be connected to system ground per the National Electrical Code or any applicable local codes.
- Only qualified personnel should perform this installation.

Observe all additional Safety Guidelines detailed throughout this manual.

Synergic 7F Wire Drive 4-Roll Kits (KP655 and KP656)

- 1) Turn OFF welding power source.
- 2) Release both quick release levers by sliding the levers sideways into the open positions.

- 3) Remove clamping screw & clamping collar from the drive shaft closest to the incoming side of the feeder.
- 4) Install drive roll onto keyed shaft. (Do not exceed the maximum wire size rating of the wire drive.) Replace collar and tighten clamping screw.
- 5) Back out the set screw for the middle guide tube. Install the middle guide tube and slide it up against the drive roll. **DO NOT TIGHTEN THE MIDDLE GUIDE AT THIS TIME.**
- 6) Install the outgoing drive roll following the same procedure as steps 3 & 4.
- 7) Center the middle guide between the two drive rolls and tighten in place.
- 8) Back out the screws for the incoming and outgoing guide tubes.
- 9) Install the longer guide tube in the rear hole near the incoming drive roll. Slide the tube in until it almost touches the roll. Tighten in place.
- 10) Install the remaining guide tube in the front hole. Be certain that the proper plastic insert is used. Fine wire chisel point tube must have largest radius next to drive roll. Tighten in place.
- 11) Re-latch both quick release levers.
- 12) To start new electrode, straighten the first 6" (150mm) and cut off the first 1" (25 mm). Insert free end through the incoming tube. Press gun trigger and push wire into the drive roll.

TO SET IDLE ROLL PRESSURE, see “Idle Roll Pressure Setting” in OPERATION.

10 Series Wire Drive Roll Kit Installation (KP1505 and KP1507)

- 1) Turn OFF Welding Power Source.
- 2) Pull open Pressure Door to expose rolls and wire guides.
- 3) Remove Outer Wire Guide by turning knurled thumb screws to unscrew from Feedplate.
- 4) Remove drive rolls, if any are installed, by pulling straight off shaft. Remove inner guide.
- 5) Insert inner Wire Guide, groove side out, over the two locating pins in the feedplate.

- 6) Install each drive roll by pushing over shaft until it butts up against locating shoulder on the drive roll shaft. (Do Not exceed maximum wire size rating of the wire drive).
- 7) Install Outer Wire Guide by sliding over locating pins and tightening in place.
- 8) Engage upper drive rolls if they are in the "open" position and close Pressure Door.

TO SET IDLE ROLL PRESSURE, see "Idle Roll Pressure Setting" in OPERATION.

GUN AND CABLE ASSEMBLIES WITH STANDARD CONNECTION

The 10 Series Wire Drive Heads each require a K1500 Gun Adapter installed See "Gun Adapters" in ACCESSORIES section. The K1500-2 Gun Adapter and Trigger Cable for Magnum 200-400 guns are factory included with the LN-10.

GMAW Guns

An expanding line of Magnum gun and cable assemblies are available to allow welding with solid and cored electrodes using the GMAW process See the appropriate Magnum literature for descriptions of the 200 to 550 ampere air cooled gun and cables that are available. Gun cable lengths range from 10 ft. (3.0 m) to 25 ft. (7.6 m) and feed electrode sizes .025" (0.6 mm) to 3/32" (2.4 mm). The entire line of Magnum Fast-Mate gun and cable assemblies can also be used by installing a K489-2 Fast-Mate adapter kit. See "Gun and Cable Assemblies with Fast-Mate Connection" in this section for details.

Innershield Guns

K126 and K115 gun and cable assemblies are available to allow welding with Innershield electrodes. Gun cable lengths range from 10 ft. (3.0 m) to 15 ft. (4.5 m) The 350 ampere K126 will feed electrode sizes .062 (1.6 mm) to 3/32" (2.4 mm). The 450 ampere K115 will feed 5/64" (2.0 mm) to 3/32" (2.4 mm) electrode.

Three smoke extraction gun and cable assemblies are available, 250 ampere K309, 350 ampere K206 and the 500 ampere K289. All gun cable lengths are 15 ft. (4.5 m). These guns will feed electrode sizes .062" (1.6 mm) to 3/32" (2.4 mm) and require the use of the K184 vacuum unit for use with the LN-10.

Gun Cable Connection with Standard Connection

1. Check that the drive rolls and guide tubes are proper for the electrode size and type being used. If necessary, change them per "Wire Drive Roll Kits" in this section.
2. Lay the cable out straight. Insert the connector on the welding conductor cable into the brass conductor block on the front of the wire drive head. Make sure it is all the way in and tighten the hand clamp. Keep this connection clean and bright. Connect the trigger control cable polarized plug into the mating 5 cavity receptacle on the front of the wire drive unit.
3. For GMA Gun Cables with separate gas fitting (10 Series Wire Drive using K1500-1 Gun Adapter), connect the 3/16" I.D. gas hose from the wire drive unit to the gun cable barbed fitting.

GUN AND CABLE ASSEMBLIES WITH FAST-MATE CONNECTION

(Requires K489-2 Fast Mate™ Adapter Kit used with the K1500-1 Gun Adapter)

GMAW Guns

An expanding line of Magnum Fast-Mate™ air cooled and water cooled gun and cable assemblies are available to allow welding with solid and cored electrodes using the GMAW process. See the appropriate Magnum literature for descriptions of the 200 to 400 ampere air cooled gun and cables that are available as well as the Magnum "Super Cool" 450 ampere water cooled gun and cable. Gun cable lengths range from 10 ft. (3.0 m) to 25 ft. (7.6 m) and feed electrode sizes .025" (0.6 mm) to 5/64" (2.0 mm).

An expanding line of Magnum X-Tractor gun and cable assemblies provides fume extraction capability for welding with solid and cored electrodes using the GMAW process. See the appropriate Magnum literature for descriptions of the 250 to 400 ampere air cooled gun and cables that are available. Gun cable lengths range from 10 ft. (3.0 m) to 15 ft. (4.5 m) and feed electrode sizes .035" (0.9 mm) to 1/16" (1.6 mm). These guns require the use of either the K173-1 or K184* vacuum units.

*Requires S14927-8 connector hose and an S20591 hose adapter.

Gun Cable Connection with Fast-Mate Connection

1. Check that the drive rolls, feeder guide tubes and gun connector guide tube are appropriate for the electrode size being used. If necessary, change them per "Wire Drive Roll Kits" in this section.
2. Connect gun to gun connector making sure all pins and gas tube line up with appropriate holes in connector. Tighten gun by turning large nut on gun cable clockwise.

10 SERIES WIRE DRIVE WATER CONNECTIONS (FOR WATER COOLED GUNS)

10 Series Wire Drive: must have a K590-4 Water Connection Kit installed for water cooled guns. (See ACCESSORIES).

Using male quick-connect fittings, connect the water hoses to the coolant inlet and outlet on the back of the wire drive. Connect the other ends of these hoses to the appropriate ports on the water cooling units.

In the event the water line fittings on your water cooled gun are incompatible with the female quick connects on the front of the wire drive, male quick-connects (L.E. Part No. S19663) are provided in the Kit for installation on 3/16" (5 mm) I.D. hose (Customer to provide appropriate clamps). The feeder connectors self seal when disconnected.

Synergic 7F Wire Drive (K679) :Must have a K682-2 Water Connection Kit installed. (See ACCESSORIES).

Using hose clamps provided with the K682-2 kit, connect appropriate water hoses to the coolant inlet and outlet fittings on the back of the K682-2 Kit. Connect the other ends of these hoses to the appropriate ports on the water cooling units.

In the event the water line fittings on your water cooled gun are incompatible with the female quick connects on the front of the K682-2 Kit male quick-connects are provided with the kit for installation on 3/16 (5 mm) I.D. hose (Customer to provide appropriate clamps). The feeder connectors self seal when disconnected.

GMAW Shielding Gas

WARNING



CYLINDER may explode if damaged.

- Keep cylinder upright and chained to support.
- Keep cylinder away from areas where it may be damaged.
- Never lift welder with cylinder attached.
- Never allow welding electrode to touch cylinder.
- Keep cylinder away from welding or other live electrical circuits.



BUILDUP OF SHIELDING GAS may harm health or kill.

- Shut off shielding gas supply when not in use.

SEE AMERICAN NATIONAL STANDARD Z-49.1, "SAFETY IN WELDING AND CUTTING" PUBLISHED BY THE AMERICAN WELDING SOCIETY.

Customer must provide a cylinder of shielding gas, a pressure regulator, a flow control valve, and a hose from the flow valve to the gas inlet fitting of the wire drive unit.

Connect a supply hose from the gas cylinder flow valve outlet to the 5/8-18 female inert gas fitting on the back panel of the wire drive or, if used, on the inlet of the Gas Guard regulator. (See Below).

Gas Guard Regulator - The Gas Guard Regulator is an optional accessory (K659-1) on these models.

Install the 5/8-18 male outlet of the regulator to the 5/8-18 female gas inlet on the back panel of the wire drive. Secure fitting with flow adjuster key at top. Attach gas supply to 5/8-18 female inlet of regulator per instructions above.

ELECTRICAL INSTALLATION

WARNING



ELECTRIC SHOCK can kill.

- Do not touch electrically live parts such as output terminals or internal wiring.
- When inching with gun trigger, electrode and drive mechanism are “hot” to work and ground and could remain energized several seconds after the gun trigger is released.
- Turn OFF input power at welding power source before installation or changing drive roll and/or guide tubes.
- Welding power source must be connected to system ground per the National Electrical Code or any applicable local codes.
- Only qualified personnel should perform this installation.

Current 60% Duty Cycle	Copper Work Cable Size, AWG
	Up to 100 ft Length (30m)
400 Amps	00 (67 mm ²)
500 Amps	000 (85 mm ²)
600 Amps	000 (85 mm ²)

Observe all additional Safety Guidelines detailed throughout this manual.

Input Cable: LN-10 Control to Power Source

K1501-10 (Control Cable only)

Consists of a 9-conductor control cable with 14-pin control cable plug, without electrode cable, and is available in a length of 10 ft. (3 m).

With input power disconnected from the power source, install the input cable per the following:

- 1) Connect the end of the control cable with the 14-pin cable plug to the mating receptacle on the power source.
- 2) Connect the electrode lead to the power source output terminal of the desired polarity.
- 3) Connect the 9-socket plug of the control cable to the mating receptacle on the bottom of the LN-10 control box.
- 4) Slip the current sensor cover off enough to expose the input connector stud. Connect the electrode cable from the power source to this stud with the nut provided, then reclose the current sensor cover.

Work Cable

Connect a work lead of sufficient size and length (per the following table) between the proper output terminal on the power source and the work. Be sure the connection to the work makes tight metal-to-metal electrical contact.

OPTIONAL FEATURES INSTALLATION

Dual Procedure Switch Options

K683-1 Dual Procedure Switch (One per gun) - Requires K686-2 Adapter for LN-10. Kit includes gun switch, and mountings for Lincoln Innershield and Magnum guns, with 15 ft. (4.5 m) control cable and 3-pin plug. K686-2 Adapter permits 3-pin plug and 5-pin gun trigger plug to be connected to LN-10 5-pin Trigger/Dual Procedure receptacle.

Connect the 5-pin plug of the K686-2 Adapter to the LN-10 Wire Feeder Trigger/Dual Procedure 5-socket receptacle.

The 3-pin plug of the K683-1 Dual Procedure switch connects to the 3-socket receptacle of the Adapter, and the 5-pin plug of the welding gun connects to the 5-socket receptacle of the Adapter.

K683-3 Dual Procedure Switch Kit includes gun switch, and mountings for Lincoln Innershield and Magnum guns, with 15 ft. (4.5m) control cable and 5-pin plug with two leads to connect to gun trigger.

Connect the 5-pin plug of the K683-3 Dual procedure Switch to the LN-10 Wire Feeder Trigger/Dual Procedure 5-socket receptacle.

The two lead plug cord extending out of the 5-pin plug of the Dual Procedure switch is to be connected to the two trigger leads of the welding gun per the instructions shipped with the kit.

K1449-1 Dual Procedure Remote Control

Provides remote rotating knob encoder control of Wire Feed Speed and Voltage, along with a dual procedure selector switch, when the remote control is connected and REMOTE is selected by the LN-10 Procedure key. The LN-10 A or B procedure light will also be on to indicate which procedure is selected by the remote control.

The 4-pin plug of the remote control connects to the mating receptacle on the bottom of the LN-10 Control box.

The K1450-”L” Extension cable is used to extend the 16 ft (5m) cable attached to the remote control. Lengths ”L” are available to match the Length of the control to boom mount wire drive cable being used.

K1561-1 Robotics Interface Module - The module plugs directly into the LN-10 control board and provides an interface to a properly equipped Fanuc robot.

When installed and properly configured, the K1561-1 Robotics Interface Module allows complete control of the welding process from the robot controller.

The Lincoln Electric Company’s Automation Center should be contacted for questions regarding installation or operation of the Robotics Interface Module.

All other options, see ACCESSORIES section, are shipped with installation instructions.

BOOM AND BENCH CONVERSIONS

The modular design of these feeders allows them to be converted from bench to boom models or vice versa. Some additional parts are required to make this conversion.

Materials Required for bench to boom conversion:

S13100-197 Plug and Lead assembly, allows a control cable to connect from control box to the wire drive.

G2868 Mounting Bracket, allows reed switch to be relocated to control box.

K1498-16 AND K1498-25 Control Box to Wire Drive, Control cable and power cable from control box to wire drive.

Materials Required for boom to bench conversion:

L10286-1 Wire Reel Stand, for LN-10 or STT-10, mount the reed switch onto the reel stand.

S22777 Control Box Support Bracket, to mount the control box onto the wire drive.

S13100-198 Plug and Lead Assembly, electrical connection between control box and wire drive.

OPERATING INSTRUCTIONS

Safety Precautions

WARNING



ELECTRIC SHOCK can kill.

- Do not touch electrically live parts such as output terminals or internal wiring.
- Unless using cold feed feature when inching with gun trigger, electrode and drive mechanism are "hot" to work and ground and could remain energized several seconds after the gun trigger is released.
- Turn OFF input power at welding power source before Control switch setup or changing drive roll and/or guide tubes.
- Welding power source must be connected to system ground per the National Electrical Code or any applicable local codes.
- Only qualified personnel should operate this Equipment.

Observe all additional Safety Guidelines detailed throughout this manual.

Duty Cycle

The LN-10 models are rated at 60% duty cycle * for a maximum current of 600 amps.

* Based on a 10 minute time period (6 minutes on, and 4 minutes off).

LN-10 CONTROL DIP SWITCH SETUP

Initial set up of the LN-10 control for the system components being used and for general operator preferences is done using a pair of 8-pole DIP switches located inside the LN-10 control box.

"Other: Power Source Independent" power source selection dip switch setting:

The LN-10 is designed to work with the following Lincoln Electric power sources: CV250, CV300-I, CV300, CV400-I, CV400, CV500-I, CV655, DC250, DC400, DC600, DC650 PRO, DC1000, Pulse Power 500 (non-pulse CV modes only), the V300 PRO, V350 PRO, and the DC655. To use the LN-10 with other power sources, the "Other: Power Source Independent" power source selection dip switch setting (S1 switches 1-4 in the OFF position) may be used. All LN-10 features operate as described elsewhere in this manual except for the following differences:

1. Instead of displaying a preset value in volts, the top display will show a number from "0.00" to "10.00" in increments of 0.02. The number can be used for setting run-in "voltage" as well as "weld preset voltage". When the trigger is closed or while welding, the top display will display actual arc voltage.

The voltage displayed while welding can be used to determine the arc voltage to be expected for a given number setting. Actual arc voltage display will still flash for 5 seconds after a weld has been completed.

2. If a loss of arc voltage occurs, wire will NOT stop feeding. The Loss of Voltage Sense Shutdown feature is disabled to permit the use of the LN-10 with power source connections that do not connect the work voltage back to the LN-10 through the input power cable. The actual weld voltage while welding will NOT be shown on the top display if the work voltage is not available to the LN-10 through the input power cable.

Setup DIP Switch Access

- 1) Shut off the input power to the LN-10 control by turning off the power at the welding power source it

WARNING

is connected to.

Have qualified personnel do the set up and maintenance work. Turn the input power off at the power source before working inside the wire feeder.

- 2) Remove the two screws on the top of the LN-10 control box door and swing the door down to open.
- 3) Locate the two 8-pole DIP switches, near the top left corner of the LN-10 Control P.C. board, labeled S1 and S2.

NOTE: Switch settings are only programmed during input power-up restoration.

Setting the DIP Switches

The DIP switches are each labeled with an “ON” arrow showing the on direction for each of the 8 individual switches in each DIP switch (S1 and S2). The functions of these switches are also labeled and set as described below:



Wire Drive Head Selection

The LN-10 control is set up for proper presettable wire feed speed by setting S1 DIP switches (5 to 8) as appropriate per the following examples for the head specification and 10 Series wire drive external gear selection being used:

For K1563-1,-3 or K1564-Series (LN-10 Boom) or K1559-1 (LN-10 Bench) with 35-500 IPM (0.89-12.7 m/m) Low Speed Ratio set S1 DIP Switch as follows:

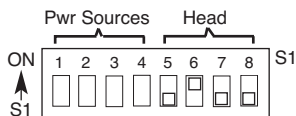

For K1563-1,-3 or K1564-Series (LN-10 Boom) or K1559-1 (LN-10 Bench) with 50-750 IPM (1.25-19.0 m/m) High Speed Ratio set S1 DIP Switch as follows: (initial factory setting)

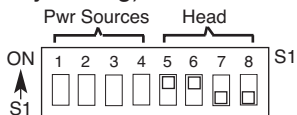

For K1563-2,-4 (LN-10 Boom) or K1559-2 (LN-10 Bench) with 55-825 IPM (1.40-21.0 m/m) Low Speed Ratio set S1 DIP Switch as follows:

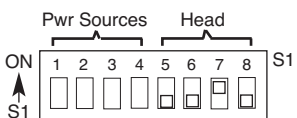

For K1563-2,-4 (LN-10 Boom) or K1559-2 (LN-10 Bench) with 80-1250 IPM (2.00-31.8 m/m) High Speed Ratio set S1 DIP Switch as follows:

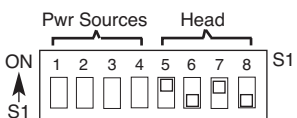

For K679-1 (Single Head Boom) with 50-770 IPM (1.27-19.5 m/m) Low Speed Ratio set S1 DIP Switch as follows:

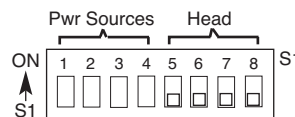

For K679-2 (Single Head Boom) with 80-1200 IPM (2.00-30.5 m/m) High Speed Ratio set S1 DIP Switch as follows:

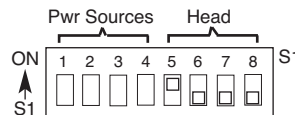

Note: The K679-1 and -2 require the K1562-1 control box.

Welding Power Source Selection

The LN-10 Control is set up for proper presettable weld voltage control by setting S1 DIP switches (1 to 4) as appropriate per the following information for the welding power source being used:

CV-250/CV 300-I:

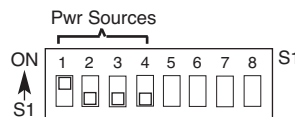

CV-300/CV 400-I:

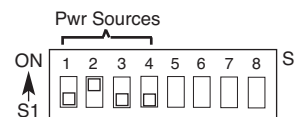

CV-400/CV 500-I:

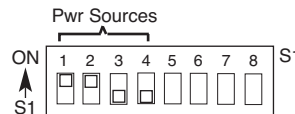

CV-655: (initial factory setting)

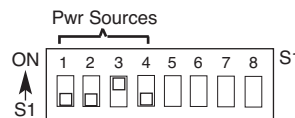

V350-PRO And V450-PRO:

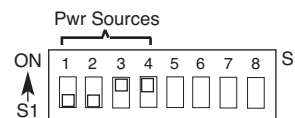

DC-250: *

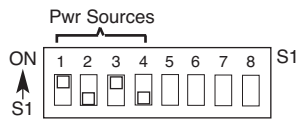

DC-400:

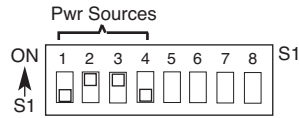

DC-600:

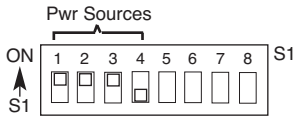

DC-650 PRO:

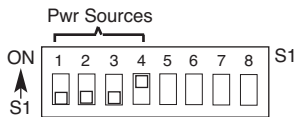

DC-1000: *

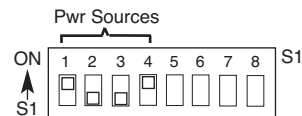

Pulse Power 500: *

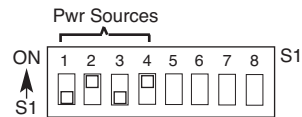

V300 PRO:

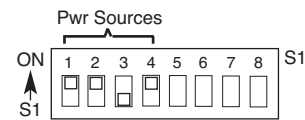

**10.0 TO 45.0 VOLT LINEAR PRESET
(FOR POWER SOURCES WITH LINEAR VOLTAGE
CONTROL PROTOCOL)**

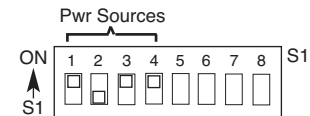

0.0 TO 10.0 LINEAR PRESET:

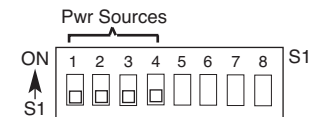

Metric/English Wire Feed Speed Display Selection

The LN-10 Control is set up for Wire Feed Speed display in Metric units (m/min.) or English units (IPM) by setting S2 DIP Switch 1 (Labeled “M”):

S2 switch 1 OFF = IPM (as shipped)

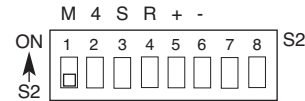

S2 switch 1 ON = m/min

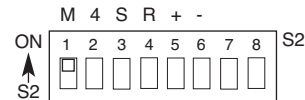

4-Step Trigger Mode Operation Selection

The LN-10 Control is set up for 4-Step Trigger mode operation with or without weld current interlock by setting S2 DIP switch 2 (Labeled “4”).

When 4-Step trigger mode is selected on the LN-10 keypad (See Keypad and Display Operation in this section) S2 DIP switch setting determines the 4-step trigger operation:

S2 switch 2 OFF = 4-Step with current interlock operation: (As shipped)

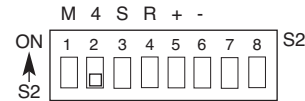

- 1) Closing Trigger initiates gas preflow time followed by Run-in speed and strike voltage until arc strike initiates welding.
- 2) Opening Trigger after welding arc is established continues welding with weld current interlock. (Breaking arc stops the feeder operation).
- 3) Reclosing Trigger continues welding but shuts off current interlock function.
- 4) Reopening Trigger stops wire feed and initiates burnback time, then gas postflow time.

* Requires optional K1520-1 115V/42V Transformer Kit.

S2 switch 2 ON = 4-Step without current interlock operation:

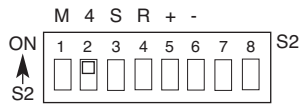

- 1) Closing Trigger initiates gas flow.
- 2) Opening Trigger initiates gas preflow timer followed by Run-in speed and strike voltage until arc strike initiates welding. (Trigger is released before arc is struck, but once established breaking arc stops the feeder operation).
- 3) Reclosing Trigger stops wire feed and initiates burnback time, then gas postflow time.
- 4) Reopening Trigger stops gas flow if, or when, post-flow time is over.

Security Mode Selection

The LN-10 Control is set up for Security Mode (See “Security Mode” in this section) by setting S2 DIP Switch 3 (Labeled “S”):

S2 switch 3 ON = Security mode ON

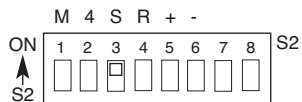

S2 switch 3 OFF = Security mode OFF (as shipped)

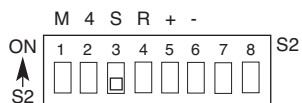

Robotics Mode Selection

The LN-10 control is set up for Robotics Mode by setting the S2 DIP Switch 4 (Labeled “R”). For Robotics Interface Mode to operate, a K1561-1 Robotics Interface Module must be installed.

S2 switch 4 ON = Robotics mode ON



S2 switch 4 OFF = Robotics mode OFF (As shipped)

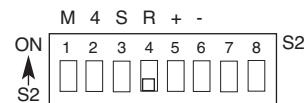

Maximum Limits Setting Mode Selection

The LN-10 control is set up for allowing a maximum weld WFS and arc voltage setting for each procedure by setting S2 DIP Switch 5 (Labeled “+”)

S2 switch 5 ON = Max. Limits Setting mode ON



When Maximum Limits Setting mode is selected, all keys except the procedure key are disabled. Welding is not allowed while in this mode. The mode is used for maximum limits setup only. See “Limits Setting Mode” in this section for the correct procedure for setting the WFS and voltage limits.

S2 switch 5 OFF = Maximum Limits Setting mode OFF (As shipped)



Minimum Limits Setting Mode Selection

The LN-10 control is set up for allowing a minimum weld WFS and arc voltage setting for each procedure by setting S2 DIP Switch 6 (Labeled "-").

S2 switch 6 ON - Minimum Limits Setting mode ON

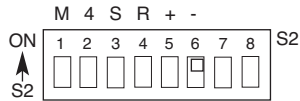

When Minimum Limits Setting mode is selected, all keys except the procedure key are disabled. Welding is not allowed while in this mode. The mode is used for minimum limits setup only. See "Limits Setting Mode" in this section for the correct procedure for setting the WFS and voltage limits.

S2 switch 6 OFF = Minimum Limits Setting mode OFF (As shipped)

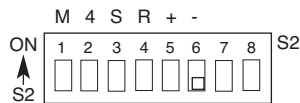

KEYPAD AND DISPLAY OPERATION

Power-Down Save

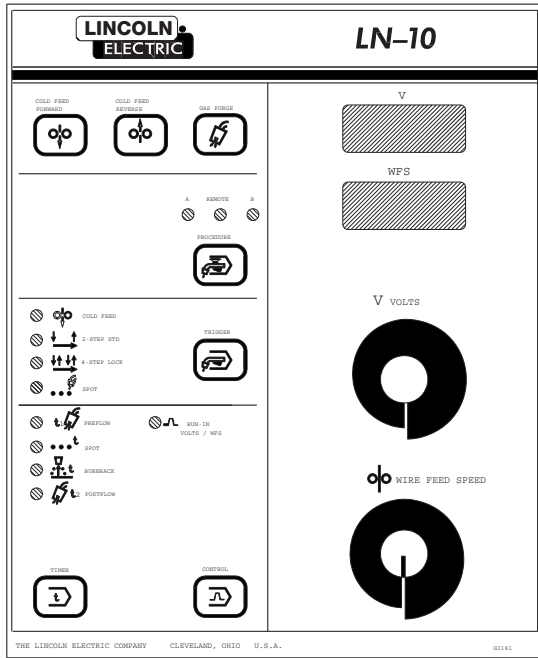

Keypad and Display Description

Keypad - Seven key, membrane type with "snap" tactile feel and embossed domes. Long life design. Spatter resistant surface.

Displays - Two digital LED displays with .56" (14.2 mm) character height. Top (3-1/2 digit) displays Preset and Actual (while welding) arc voltage in volts with (+) or (-) polarity indicators, and also displays all timers in seconds. Bottom (4 digit) displays preset wire feed speed in IPM, or m/m, and acceleration selection.

Indicator Lights - Extra bright red LEDs for viewing at almost any angle. Always indicate the feeder and procedure selected, trigger mode being used and function or timer being displayed.

Rotating Encoders - Knob controls increase or decrease settings of volts and wire feed speed. (initially factory set to minimum) Alternately, the top encoder adjusts timer settings and bottom selects acceleration settings when selected for these parameters to be displayed.

Power to the LN-10 is supplied and controlled from the power source. The LN-10 automatically senses the loss of power when the power source is turned off. Dual procedure settings, including; trigger mode, cold feed speed, Run-in and weld speed and voltage, timers and acceleration are automatically saved for each feeder when power is removed. This feature does not require batteries and when power is restored it will automatically return all settings to the state they were in when power was removed. The operator may overwrite any or all of these settings following power up recall.

Operation Keys

Procedure Lights - Indicate which procedure (A or B) is selected for the selected feeder. The Procedure select key selects A or B, or if REMOTE Light is selected, the procedure selection light is controlled by connection of an optional Dual Procedure gun switch (K683-1, -3) or Dual Procedure Remote Control (K1449-1).

Cold Feed Keys - energize the wire feeder but not the power source or gas solenoid valve. Cold Feed Forward speed is factory set at 200 IPM, but is adjustable with WFS encoder knob and displayed on WFS display (with "Cld" shown on the Voltage display) only while pressing Cold Feed Forward, and the last speed set is stored in memory for the next cold feeding, unless changed in Cold Feed trigger mode (see following section). Cold Feed Reverse retracts wire at a fixed 80 IPM speed which is not adjustable.

Gas Purge key - energizes the gas solenoid valve but not the wire feeder or power source.

Trigger Mode Selection

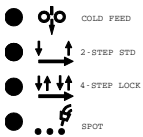

Trigger Mode Select key

- enables operator to choose mode of operation shown by the indicator lights. Pressing key causes mode lights to

sequence (top to bottom) starting from the current indicated selection.

Top Light - Indicates gun trigger has been selected to perform the Cold Feed Forward function in exactly the same manner as Cold Feed Forward key (See Operation Keys - Cold Feed Keys) with the same memory stored adjustable speed setting, and "Clid" shown on the Voltage display.

Second Light - indicates 2-step (standard) trigger mode.

1. Trigger closure energizes the solenoid valve, then the wire feeder and the power source after Prewflow time.
2. Releasing the trigger turns off the wire feeder, then power source after burnback time and then the gas solenoid valve after Postflow time.

Third Light - indicates 4-step (lock) trigger mode. This mode may be selected to include or exclude weld current interlock. (See "4-Step Trigger Mode Operation Selection" in this section for 4 step Trigger Mode operation)

Bottom Light - indicates Spot Weld Mode, which will only light if a spot time is set (See "Display Control Keys" in this section). If set to 0.0 seconds, spot mode light selection will be skipped. Trigger closure energizes the gas solenoid valve, then wire feeder and the power source. The spot timer starts when current flows. The wire feeder and power source then solenoid valve are all turned off when the spot on timer times out even though the trigger is opened or is still closed. Prewflow/Postflow and burnback timers are also functional in spot mode. (See "Display Control Keys" in this section).

Display Control Keys

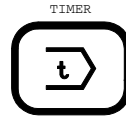

Timer Select key - enables operator to choose burnback, spot or gas timers, as indicated by the appropriate light. Pressing the key causes lights to sequence (top to bottom, then all off) starting from the current indicated selection.

When a timer is selected the Voltage display shows the time setting in seconds, as indicated by "SEC" displayed on the speed display. The times are set using the Voltage encoder knob.

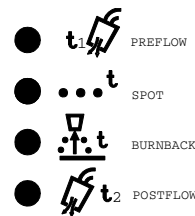

Top Light - indicates preflow time is being displayed, set 0.0 to 2.5 seconds (0.2 sec as shipped). This is the time the shielding gas flows before the wire feed and power source are activated.

Second Light - indicates spot time is being displayed, set 0.0 (as shipped) to 199.9 seconds.

Third Light - indicates burnback time is being displayed, set 0.00 (as shipped) to 0.25 seconds. This is the time the arc power is delayed at the stop of the weld, and should be set to the lowest time required to prevent the wire sticking in the weld.

Bottom Light - indicates postflow time is being displayed, set 0.0 to 10.0 seconds (0.5 sec as shipped).

This is the time the shielding gas flows after the wire feed and power source are deactivated.

Pressing Timer Select Key again, or closing the gun trigger, shuts all timer lights off, indicating weld Voltage and Wire Feed Speed are again being displayed, and set by the appropriate encoder knob.

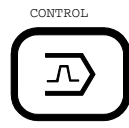

Control Select key - enables operator to choose Run-In procedure as indicated by the light turning on. When light is on, the settings of Run-In Wire Feed Speed and Voltage are displayed. After Weld procedure is set, Run-in procedure should be set to optimize arc starting.

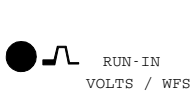

Speed encoder knob can adjust run-in speed between min. rated speed and up to the procedure Weld speed setting. Run-in speed setting can not exceed Weld speed

setting. Run-in speed setting of 100 IPM or less is recommended for optimum starting. Factory setting is near min. rated speed.

If set below minimum rated speed “-” will show on the WFS display, indicating Run-in speed is set to match weld speed setting.

The Run-in (strike) voltage can be set above or below the Weld voltage setting up to a max of 60 V. If set below a min of 10 V, the Run-In (strike) voltage display shows “---”, indicating the Run-In Voltage is set to match the weld voltage setting. Also, the difference between Run-in voltage and Weld voltage settings is maintained automatically if the Weld voltage setting is changed, so the run-in voltage encoder knob does not need to be changed to follow the Weld voltage setting.

When trigger is closed (and preflow time is over) the wire feeds at Run-In speed and volts until the welding arc strikes, which causes the feed speed and volts to change to Weld settings.

If the arc does not strike within about 2 seconds, the Run-In speed automatically changes to Weld speed to permit “Hot” feeding at higher speed setting for loading wire.

Pressing control key again, or closing the gun trigger, shuts off light indicating knob settings and displays are returned to Weld Voltage and Wire Feed Speed.

Digital “Memory” Voltmeter

When the welding gun trigger is activated, the top LN-10 display reads actual welding voltage from 0.0 to 60.0 VDC with automatic polarity indication for positive (+) or negative (-) electrode.

If actual voltage drops below 8.0 volts for over 0.8 sec when the trigger is closed, Loss of Voltage Sense Shutdown will occur. See “Loss of Voltage Sense Shutdown” in this section.

The last welding voltage monitored at the end of the weld is displayed for 5 seconds after the weld has stopped, as indicated by a 5 second “blinking” display. This allows checking actual weld voltage after weld has stopped.

Any keypad or trigger operation will interrupt the 5 second memory display.



Acceleration Selection

To provide optimum starting of various processes and procedures, the wire feed acceleration of the LN-10 can be set to five levels; 1 thru 5, for each feeder and procedure. 1 is the slowest acceleration and 5 is the fastest. (Factory set to 4.)

To change acceleration hold the Gas Purge Key closed, then press the Control key. The top (Voltage) display shows “Acc” indicating acceleration setting, 1 thru 5, is displayed on the bottom (Speed) display. Use the speed encoder knob to change setting from 1 thru 5.

To exit this function, and enter the acceleration setting into the procedure memory, press both keys again or close the trigger.

Security Mode

Security mode is used to capture timer, acceleration, and control selections and settings, then to disable these selections until security mode is deactivated. Encoder knob setting changes of cold feed, weld speed and weld voltage are not disabled.

Security mode is activated, or deactivated, by shutting off the input power to the LN-10 with all Timer and Control settings as desired for both procedures for both Feeders. Then setting S2 DIP switch 3 inside the LN-10 Control Box ON or OFF and restoring input power (See “Setting DIP Switches” in this section).

When activated, the Timer and Control selections no longer light, but function with the captured settings. All other keys and encoder knob controls function normally.

Maximum and Minimum Limits Setting Modes

Limits setting modes are available for limiting the range for setting wire feed speed and voltage. The limits can be set independently for each procedure. The following steps should be followed for setting the maximum and minimum limits:

1. Turn off the power at the power source.
2. Remove the two screws at the top of the LN-10 control box and open the control box door.
3. Put DIP switch S2 switch 5 in the ON position.
4. Close the control box door.
5. Turn on the power at the power source.
6. Set the maximum WFS and voltage limits for procedure A and procedure B using the two encoder knobs and the procedure key. The maximum WFS limit can be set for the entire range of the wire drive that is being used. The maximum voltage limit can be set over the range of 10.0 to 60.0 volts. The maximum limits can be turned off independently for each procedure by turning the encoder knobs clockwise until the appropriate display (WFS or voltage) reads "OFF" while the correct procedure light is lit. (The limits are set to "OFF" from the factory).
7. Turn off the power at the power source.
8. Open the control box door.
9. Put DIP switch S2 switch 5 in the OFF position and DIP switch S2 switch 6 in the ON position.
10. Close the control box door.
11. Turn on the power at the power source.
12. Set the minimum WFS and voltage limits for procedure A and procedure B using the two encoder knobs and the procedure key. The minimum WFS limit can be set from the minimum speed of the wire drive that is being used to the maximum limit that has been set for the selected procedure. The minimum voltage limit can be set over the range of 10.0 to the maximum voltage limit that has been set for the selected procedure. The minimum limits can be turned off independently for each procedure by turning the encoder knobs counter clockwise until the appropriate display (WFS or voltage) reads "OFF" while the correct procedure light is lit. (The limits are set to "OFF" from the factory).
13. Turn off the power at the power source.
14. Open the control box door.
15. Put DIP switch S2 switch 6 in the OFF position.
16. Close the control box door.
17. Reinstall the two screws that had previously been removed in step 2.

DUAL PROCEDURE REMOTE CONTROL (K1449-1)

When this option is connected to the LN-10 Control Box receptacle, and the Procedure Key selects "REMOTE" the front panel knob controls and procedure selection is transferred to the knob encoder controls and Procedure Selector Switch of the remote, which function in the exact same manner. Remote knob encoders set Weld voltage and wire feed speed, as well as Trigger Cold Feed Speed, but not Timers or Run-In.

If using the optional K683-1, -3 Dual Procedure Switch, for a wire drive, to select A or B along with the (K1449-1) remote, both the front panel and remote Procedure selector and switch must be set to "REMOTE" and "Gun Switch" (center) positions.

The LN-10 Procedure lights indicate whether A or B is remotely selected.

WIRE REEL LOADING - READI-REELS, SPOOLS OR COILS

To Mount a 30 Lb. (14 kg) Readi-Reel Package (Using the Molded Plastic K363-P Readi-Reel Adapter:)

The Spindle should be located in the **LOWER** mounting hole.

- 1) Depress the Release Bar on the Retaining Collar and remove it from the spindle.
- 2) Place the Adapter on the spindle.
- 3) Re-install the Retaining Collar. Make sure that the Release Bar "pops up" and that the collar retainers fully engage the retaining groove on the spindle.
- 4) Rotate the spindle and adapter so the retaining spring is at the 12 o'clock position.
- 5) Position the Readi-Reel so that it will rotate in a direction when feeding so as to be de-reeled from bottom of the coil.
- 6) Set one of the Readi-Reel inside cage wires on the slot in the retaining spring tab.
- 7) Lower the Readi-Reel to depress the retaining spring and align the other inside cage wires with the grooves in the molded adapter.
- 8) Slide cage all the way onto the adapter until the retaining spring "pops up" fully.

⚠ WARNING

Check to be sure the Retaining Spring has fully returned to the locking position and has **SECURELY** locked the Readi-Reel Cage in place. Retaining Spring must rest on the cage, not the welding electrode.

- 9) To remove Readi-Reel from Adapter, depress retaining spring tab with thumb while pulling the Readi-Reel cage from the molded adapter with both hands. Do not remove adapter from spindle.

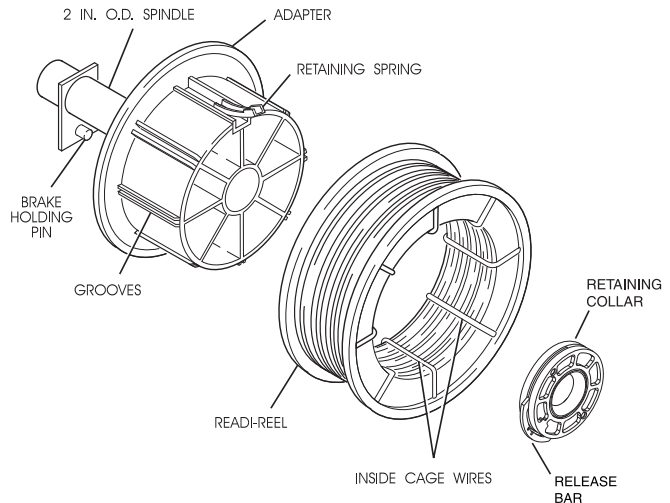

FIGURE B.1

To Mount 10 to 44 Lb. (4.5-20 kg) Spools (12"/300 mm Diameter) or 14Lb.(6 Kg) Innershield Coils:

The Spindle should be located in the **LOWER** mounting hole.

(For 8" (200 mm) spools, a K468 spindle adapter must first be slipped onto spindle.)

(For 13-14 lb. (6 Kg) Innershield coils, a K435 Coil Adapter must be used).

- 1) Depress the Release Bar on the Retaining Collar and remove it from the spindle.
- 2) Place the spool on the spindle making certain the spindle brake pin enters one of the holes in the back side of the spool. Be certain the wire comes off the reel in a direction so as to de-reel from the bottom of the coil.
- 3) Re-install the Retaining Collar. Make sure that the Release Bar "pops up" and that the collar retainers fully engage the retaining groove on the spindle.

To Mount a 50-60 Lb. (22.7-27.2 kg) Coil: (Using K1504-1 Coil Reel) (For 50-60 lb Readi-Reels a K438 Readi-Reel Adapter must be used).

The Spindle must be located in the **UPPER** mounting hole.

- 1) With the K1504-1 Coil Reel mounted on to the 2" (51 mm) spindle (or with reel laying flat on the floor) loosen the spinner nut and remove the reel cover. (See Figure B.2).
- 2) Before cutting the tie wires, place the coil of electrode on the reel so it unwinds from the bottom as the reel rotates.
- 3) Tighten the spinner nut against the reel cover as much as possible by hand using the reel cover spokes for leverage. **DO NOT** hammer on the spinner nut arms.
- 4) Cut and remove only the tie wire holding the free end of the coil. Hook the free end around the rim of the reel cover and secure it by wrapping it around. Cut and remove the remaining tie wires.

⚠ CAUTION

Always be sure the free end of the coil is securely held while the tie wires are being cut and until the wire is feeding through the drive rolls. Failure to do this will result in "backlashing" of the coil, which may tangle the wire. A tangled coil will not feed so it must either be untangled or discarded.

- 5) Be sure the coil reel is engaged with the spindle brake pin and the Release Bar on the Retaining Collar "pops up" and that the collar retainers fully engage the retaining groove on the spindle.

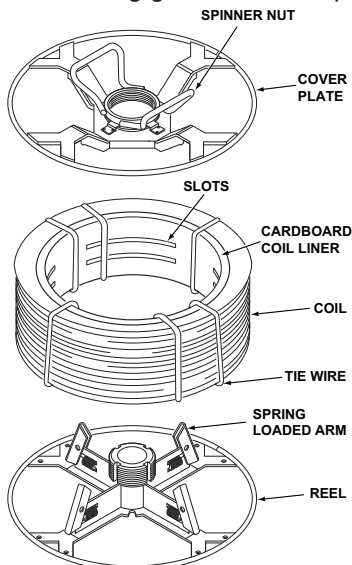

FIGURE B.2

FEEDING ELECTRODE AND BRAKE ADJUSTMENT

- 1) Turn the Reel or spool until the free end of the electrode is accessible.
- 2) While tightly holding the electrode, cut off the bent end and straighten the first 6" (150 mm). Cut off the first 1" (25 mm). (If the electrode is not properly straightened, it may not feed or may jam causing a "birdnest".)
- 3) Insert the free end through the incoming guide tube.
- 4) Press the Cold Inch key or the Cold Feed Mode gun trigger and push the electrode into the drive roll.

⚠ WARNING

When feeding with the gun trigger, unless "COLD FEED" trigger mode is selected, the electrode and drive mechanism are always "HOT" to work and ground and could remain "HOT" several seconds after the gun trigger is released.

- 5) Feed the electrode through the gun.
- 6) Adjust the brake tension with the thumbscrew on the spindle hub, until the reel turns freely but with little or no overrun when wire feeding is stopped. Do not overtighten.

DRIVE ROLL PRESSURE SETTING

The LN-10 pressure is factory pre-set to about position "2" as shown on the pressure indicator on the front of the feedplate door. This is an approximate setting.

The optimum drive roll pressure varies with type of wire, surface condition, lubrication, and hardness. Too much pressure could cause "birdnesting", but too little pressure could cause wire feed slippage with load and/or acceleration. The optimum drive roll setting can be determined as follows:

- 1) Press end of gun against a solid object that is electrically isolated from the welder output and press the gun trigger for several seconds.
- 2) If the wire "birdnests", jams, or breaks at the drive roll, the drive roll pressure is too great. Back the pressure setting out 1/2 turn, run new wire through gun, and repeat above steps.
- 3) If the only result is drive roll slippage, disengage the gun, pull the gun cable forward about 6" (150 mm). There should be a slight waviness in the exposed wire. If there is no waviness, the pressure is too low. Increase the pressure setting turn, reconnect the gun, tighten locking clamp and repeat the above steps.
- 4) Use Control Select and encoder knobs to set desired Weld feed speed and voltage then Run-in speed and voltage to optimize arc starting. (Set for each procedure if using front panel, remote control or optional dual procedure switch.) (Refer to "Operation Keys" and "Display Control Keys" in this section)
- 5) Adjust the wire feed acceleration if desired, for each feeder and procedure. (Refer to "Acceleration Selection" in this section)
- 6) Use Timer Select and Voltage Encoder knob to set desired timers. (Refer to "Trigger Mode Selection" in this section)
- 7) Feed the electrode through the gun and cable and then cut the electrode within approximately .38" (9.5 mm) of the end of the contact tip for solid wire and within approximately .75" (19mm) of the extension guide for cored wire.

PROCEDURE FOR SETTING ANGLE OF FEEDPLATE

- 1) Loosen the clamping collar screw using a 3/16" Allen wrench. The clamping collar screw is accessed from the bottom of the feedplate. It is the screw which is perpendicular to the feeding direction.
- 2) Rotate feedplate to the desired angle and tighten clamping collar screw.

GAS GUARD REGULATOR SETTING

NOTE: Gas supply pressure must be regulated to a maximum of 80 psi(5.5 bar).

- 1) With the gas supply shut off, the Gas Guard regulator flow adjusting Key should be set to maximum (full clockwise) which is rated to be 60 SCFH (28 l/min).
- 2) Adjust gas supply flow rate for a level higher than will be required, then adjust Gas Guard flow adjusting Key counterclockwise to the desired gas flow rate.

MAKING A WELD

- 1) Use only a Lincoln Electric recommended constant voltage DC power source compatible with the LN-10 Wire Feeder.
- 2) Properly connect the electrode and work leads for the correct electrode polarity.
- 3) Use the Mode Selection key to set desired trigger mode for each procedure. (Refer to "Trigger Mode Selection" in this section)

- 8) Connect work cable to metal to be welded. Work cable must make good electrical contact to the work. The work must also be grounded as stated in "Arc Welding Safety Precautions".

WARNING



When using an Open Arc process, it is necessary to use correct eye, head, and body protection.

- 9) If used, be sure shielding gas valve is turned on.
- 10) Position electrode over joint. End of electrode may be lightly touching the work.
- 11) Lower welding helmet, close gun trigger, and start welding. Hold the gun so the contact tip to work distance gives the correct electrical stickout as required for the procedure being used.
- 12) To stop welding, release the gun trigger and then pull the gun away from the work after the arc goes out and Postflow time, if used, is over.
- 13) If necessary to optimize arc starting, readjust wire speed acceleration, (Refer to "Acceleration Selection" in this section) and/or Run-In speed, (Refer to "Display Control Keys" in this section).

WIRE REEL CHANGING

At the end of a coil, remove the last of the old electrode coil from the conductor cable by either pulling it out at the nozzle end of the gun or by using the following procedure:

- 1) Cut the end of the electrode off at the gun end. Do not break it off by hand because this puts a slight bend in the wire making it difficult to pull it back through the nozzle.
- 2) Disconnect the gun cable from the gun connector on the LN-10 wire drive unit and lay the gun and cable out straight.
- 3) Using pliers to grip the wire, pull it out of the cable from the connector end.
- 4) After the electrode has been removed, reconnect the gun cable to the drive. Load a new reel of electrode per the instructions in "Wire Reel Loading" in this section.

LOSS OF VOLTAGE SENSE SHUTDOWN

If the actual displayed voltage, when the trigger is closed, drops below 8.0 volts for over 0.8 second it is assumed the voltage feed back sensing circuit to the LN-10 is opened or faulty, so Loss of Voltage Sense Shutdown occurs until the trigger is released.

This shutdown stops the motor, shuts off the gas flow and disables the power source output to prevent the LN-10 voltage control from driving the power source output too high due to loss of proper feedback sensing via #21 (WORK) and #67 (ELECTRODE) sensing leads.

WIRE FEED OVERLOAD PROTECTION

The LN-10 has solid-state overload protection of the wire drive motor. If the wire drive motor becomes overloaded for an extended period of time, the protection circuitry turns off the power source, wire feed and gas solenoid, and then displays "H30" on the WFS display (with blank Voltage display). This indicates the wire drive motor is overloaded and will remain shut down for about 30 seconds before the unit will automatically reset. The "H30" display decrements every second until it reaches "H00". At that time, the unit resets automatically and the previous displays will return indicating the unit is ready to operate again. Overloads can result from improper tip size, liner, drive rolls, or guide tubes, obstructions or bends in the gun cable, feeding wire that is larger than the rated capacity of the feeder or any other factors that would impede normal wire feeding. (See "Avoiding Wire Feeding Problems" in the MAINTENANCE section).

GROUNDING LEAD PROTECTOR

The frame of the LN-10 Control is grounded to the frame of the power source by a lead in the control cable. An overload protector prevents welding current from damaging this lead if the electrode circuit touches the wire feeder frame while the electrode is electrically hot.

If such a grounding lead fault occurs, the WFS display will show "GLP," (with blank Voltage display) and the trigger circuit will be disabled. To reset the circuit, release the trigger, make sure that the electrode is not touching the wire feeder frame, and then either press any key on the keypad or close the trigger. When the GLP circuit is reset, the "GLP" display is removed and the wire feeder is returned to normal operating mode.

EXPLANATION OF PROMPTING AND ERROR MESSAGES

<u>Display</u>	<u>Prompt or Error</u>
Acc	Displayed on Voltage display, indicates WFS display is showing acceleration setting, "1" to "5" (See "Acceleration Selection" in this section).
OFF	Displayed on WFS and voltage displays; indicates limits for WFS or voltage are off for the displayed procedure. (See "Maximum and Minimum Limits Setting Modes" in this section).
SEC	Displayed on WFS display, indicates Voltage display is showing a Timer setting in seconds. (See "Display Control Keys" in this section)
GLP	Displayed on WFS display, indicates that the Grounding Lead Protector circuit was activated due to excessive current flow into the wire feeder frame. When the GLP circuit is activated the wire feeder is disabled (the trigger output to the power source is opened up, the motor is stopped, and the gas solenoid is turned off). To resume normal operation, release the trigger, make sure that the electrode is not touching the wire feeder frame, and then either press a key on the keypad or close the trigger. (See "Grounding Lead Protector" in this section)
Cld	Displayed on Voltage display when Cold Feed Forward or Cold Feed Reverse Key is pressed, or Cold Feed Trigger mode is selected. Indicates wire is fed "cold" (no weld voltage) at the speed indicated on the WFS display. (See "Operation Keys" and "Trigger Mode Selection" in this section).
---	Displayed on Voltage or WFS displays with RUN-IN selected, indicates setting will match those set for Weld Voltage and Wire Feed Speed (See "Display Control Keys" in this section).
HXX	Displayed on WFS display, indicates wire feed overload. XX indicates time remaining in seconds before unit resets automatically. (See "Wire Feed Overload Protection" in this section and "Avoiding Wire Feeding Problems" in the MAINTENANCE section).

Er EEPROM error. Usually occurs at power-up. Indicates one or more of the recalled settings is out of acceptable limits. Press any key to return to normal operation. Be sure to check all voltage, wire feed speed, acceleration and timer settings before you proceed.

TABLE C.1 – DRIVE ROLL AND GUIDE TUBE KITS

Wire Size		4-Roll DH Drive (4-Driven)	4-Roll Single Drive (2-Driven)
<u>Solid Steel Electrode</u>			
0.025"	(0.6 mm)	KP1505 - 030S	KP655 - 025S
0.030"	(0.8 mm)	KP1505 - 030S	KP655 - 030S
0.035"	(0.9 mm)	KP1505 - 035S	KP655 - 035S
0.040"	(1.0 mm)	KP1505 - 040S	KP655 - 035S
0.040"	(1.0 mm)	KP1505 - 045S	KP655 - 035S
0.045"	(1.2 mm)	KP1505 - 045S	KP655 - 052S
0.052"	(1.4 mm)	KP1505 - 052S	KP655 - 052S
1/16"	(1.6 mm)	KP1505 - 1/16S	KP655 - 1/16
5/64"	(2.0 mm)	KP1505-5/64	KP655 - 3/32
3/32"	(2.4 mm)	KP1505-3/32	-----
<u>Cored Electrode</u>			
0.030	(0.8 mm)	KP1505 - 035C	-----
0.035"	(0.9 mm)	KP1505 - 035C	KP655 - 035C
0.040"	(1.0 mm)	KP1505 - 045C	KP655 - 035C
0.045"	(1.2 mm)	KP1505 - 045C	KP655 - 052C
0.052"	(1.4 mm)	KP1505 - 052C	KP655 - 052C
1/16"	(1.6 mm)	KP1505 - 1/16C	KP655 - 1/16
0.068" - 0.072"	(1.7 - 1.8 mm)	KP1505 - 068	KP655 - 3/32
5/64"	(2.0 mm)	KP1505 - 5/64	KP655 - 3/32
3/32"	(2.4 mm)	KP1505 - 3/32	-----
7/64"	Lincore Hard Facing (2.8mm)	KP1505 - 7/64H	-----
7/64"	(2.8mm)	KP1505 - 7/64	-----
.120"	(3.0mm)	KP1505 - 120	-----
<u>Aluminum Electrode</u>			
0.035"	(0.9 mm)	KP1507 - 035A	KP656 - 035A
0.040"	(1.0 mm)	KP1507 - 040A	-----
3/64"	(1.2 mm)	KP1507 - 3/64A	KP656 - 3/64A
1/16"	(1.6 mm)	KP1507 - 1/16A	KP656 - 1/16A
<u>Aluminum Electrode</u>			
<u>(For use with Binzel Guns Only)</u>			
0.040"	(1.0 mm)	-----	KP647 - 040A
3/64"	(1.2 mm)	-----	KP647 - 3/64A
1/16"	(1.6 mm)	-----	KP647 - 1/16A

INPUT CABLE ASSEMBLIES:

K1797-25

Consists of a 14-conductor control cable extension 25' in length.

K1797-50

Consists of a 14-conductor control cable extension 50' in length.

Note: Extensions can only be connected up to 100' Maximum length.

K1520-1 115V/42V TRANSFORMER KIT

Required to use LN-10 with Lincoln Power Sources without 42VAC auxiliary and a 14-pin connector receptacle. These power sources include the DC-250, DC-600 (Below Code 10500), DC-1000 and Pulse Power 500. Also can be used with older DC-400 models.

K590-4 WATER CONNECTION KIT

Includes water cooled gun tube fittings and self-sealing outlet and inlet quick-connectors for mounting into the DH wire drive connection box.

K659-1 GAS GUARD REGULATOR

Adjustable flow regulator with removable adjuster key for CO₂ and Argon blend gases. Mounts onto wire drive gas inlet, and reduces gas waste and arc start "blow" by reducing surge caused by excess pressure in supply hose.

K1449-1 DUAL PROCEDURE REMOTE CONTROL

Includes a remote control box with a 16 ft. (5 m) length control cable with 4-pin plug for the mating receptacle on the bottom of the LN-10 control box. The remote control box contains a procedure selector switch and 2 rotating knob encoders, one controls arc voltage and the other controls wire feed speed, which function the same as comparable controls on the LN-10 front panel, when the remote is connected and selected by the LN-10 Procedure Key.

K1450-"L" - Extension cables are available in lengths "L" of 12, 16 or 25 ft. (3.6, 4.9 or 7.6) to match the control to Feeder cable length used.

K683-1 DUAL PROCEDURE SWITCH

Requires K686-2 Adapter for LN-10. Kit includes gun switch, and mountings for Lincoln Innershield and Magnum guns, with 15 ft. (4.5 m) control cable and 3-pin plug. K686-2 Adapter permits 3-pin plug and 5-pin gun trigger plug to be connected to LN-10 5-pin Trigger/Dual Procedure receptacle.

K683-3 DUAL PROCEDURE SWITCH

Kit includes gun switch, and mountings for Lincoln Innershield and Magnum guns, with 15 ft. (4.5m) control cable and 5-pin plug with two leads to connect to gun trigger.

SPINDLE ADAPTERS:

K162H (Not required for LN-10 Bench Models) Spindle for boom mounting Readi-Reels and 2" (51 mm) I.D. spools with 60 lb. (27.2 kg) capacity. User mounted to appropriately prepared boom framework. Includes an easily adjustable friction brake for control of overrun.

When a 2" (51 mm) spindle is used with Readi-Reels or coils not on 12" (305 mm) O.D. spools, an adapter is required:

Coil Adapter:

K1504-1 Permits 50 lb to 60 lb (22.7-27.2 Kg.) Coils to be mounted on 2" (51 mm) O.D. spindles.

K435 Permits 14 lb. (6 kg) Innershield coils to be mounted on 2" (51 mm) O.D. spindles.

K468 Permits 8" (203 mm) O.D. spools to be mounted on 2" (51 mm) O.D. spindles.

Readi-Reel Adapters:

K363P Adapts Lincoln Readi-Reel coils of electrode 30 lb. (14 kg) and 22 lb. (10 kg) to a 2" (51 mm) spindle. Durable molded plastic one piece construction. Designed for easy loading; adapter remains on spindle for quick changeover.

K438 Adapts Lincoln Readi-Reel coils of electrode 50-60 lb. (22.7-27.2 kg) to a 2" (51 mm) spindle.

GUN ADAPTERS (FOR 10 SERIES WIRE DRIVE)

The LN-10 wire feeder is equipped with a factory installed K1500-2 gun connection kit. This kit is for guns having a Tweco #2-#4 type connector. The LN-10 has been designed to make connecting a variety of guns easy and inexpensive with the K1500 series of gun connection kits. Gun trigger and dual procedure lead connections connect to the single 5 pin receptacle on the front of the feed head box.

Magnum 200/300/400 Guns

The easiest and least expensive way to use Magnum 200/300/400 guns with the LN-10 wire feeder is to order them with the K466-2 connector kit, or to buy a completely assembled Magnum gun having the K466-2 connector (such as the K497-21,-22,-23 dedicated Magnum 400 guns and the K497-20,-21 dedicated Magnum 200 guns).

Magnum 550 Guns

The easiest and least expensive way to use the Magnum 550 guns with LN-10 wire feeders is to order the gun with the K613-2 connector kit, and install a K1500-3 gun connection kit to the wire feeder.

Lincoln Innershield and Sub Arc Guns

All of these guns can be connected to the LN-10 by using the K1500-1 Adapter Kit.

Lincoln Fume Extraction Guns

The K556 (250XA) and K566 (400XA) guns require that a K489-7 Fast-Mate adapter kit be installed.

The K206, K289, and K309

require only the installation of a K1500-1 connector in the LN-10 wire feeder.

Non-Lincoln Guns

Most competitive guns can be connected to the LN-10 by using one of the K1500 series adapter kits.

K1500-1 (Lincoln Innershield gun standard connection)

Use this kit to connect the following guns: Guns having a Lincoln standard innershield gun connector, Magnum 200/300/400 with K466-1 connector kit, and Magnum 550 guns with the K613-1 gun connection kit.

K1500-2 (Tweco #2-#4 type connection)

The K1500-2 gun adapter comes factory installed on the LN-10 wire feeder. Use this adapter for guns that have a Tweco #2-#4 connector. Such guns include Magnum 200/300/400 guns with K466-2 connector kit, and completely factory assembled Magnum guns that are factory equipped with the K466-2 connector (such as the K471-21, -22, and -23 dedicated Magnum 400 guns and the K497-20 and -21 Magnum 200 guns).

K1500-3 (Tweco #5 connection)

For Magnum 550 gun with K613-2 Connection Kit, and any other gun having a Tweco #5 connector .

K1500-4 (Miller connection)

For any gun having a newer style Miller connector.

GUN RECEIVER BUSHINGS AND GUN ADAPTERS**K489-7** (Dual Schedule Fast-Mate Adapter)

This adapter installs directly into the wire drive feed-plate, to provide for use of guns with Fast-Mate or European style gun connections. This K489-7 will handle both standard Fast-Mate and Dual Schedule Fast-Mate guns.

GUN AND CABLE ASSEMBLIES

The following Lincoln gun and cable assemblies are compatible with 10 Series Wire Feed heads with appropriate K1500 Gun Adapter:

K126 (Requires K1500-1) Innershield gun and cable assemblies are rated at 350 amps, 60% duty cycle. (Consult sales specifications for appropriate models)

K115 (Requires K1500-1) Innershield gun and cable assemblies are rated at 450 amps, 60% duty cycle. (Consult sales specifications for appropriate models)

K470 (With K466-9 requires K1500-2) Magnum 300 GMAW gun and cable assemblies are rated 300 amps, 60% duty cycle. (Consult sales specifications for appropriate models)

K471 (With K466-9 requires K1500-2) Magnum 400 GMAW gun and cable assemblies are rated 400 amps, 60% duty cycle. (Consult sales specifications for appropriate models)

K497 (With K466-9 requires K1500-2) Magnum 200 GMAW gun and cable assemblies are rated 200 amps, 60% duty cycle. (Consult sales specifications for appropriate models)

K541 (With K466-9 requires K1500-2) Magnum 400 Short Neck GMAW gun and cable assemblies are rated 400 amps, 60% duty cycle. (Consult sales specifications for appropriate models)

K598 (With K613-7 requires K1500-3) Magnum 550 GMAW gun and cable assemblies are rated 550 amps, 60% duty cycle. (Consult sales specifications for appropriate models) The following Lincoln gun and cable assemblies are equipped with a Fast-Mate™ connector. They can be used with 10 Series wire feed models by installing a K489-2 Fast-Mate™ adapter kit and a K1500-1 Lincoln Gun adapter.

K684 Magnum "Super Cool" FM water cooled GMAW gun and cable assemblies are rated 450 amps, 100% duty cycle (CO2). (Consult sales specifications for appropriate models)

K498 Magnum 200 FM GMAW gun and cable assemblies are rated for 200 amps 60% duty cycle. (Consult sales specifications for appropriate models)

K534 Magnum 250L FM GMAW gun and cable assemblies are rated for 250 amps, 30% duty cycle. (Consult sales specifications for appropriate models)

K478 Magnum 300 FM GMAW gun and cable assemblies are rated for 300 amps, 60% duty cycle. (Consult sales specifications for appropriate models)

K479 Magnum 400 FM GMAW gun and cable assemblies are rated for 400 amps, 60% duty cycle. (Consult sales specifications for appropriate models)

USING DUAL PROCEDURE WITH FAST-MATE GUNS

There are a number of different options available for using dual procedure with Fast-Mate guns. These configurations are outlined below along with any additional required equipment.

Using Dual Schedule with Fast-Mate Guns on -10 Series Feeders

Configuration 1

K489-7 Dual Schedule Fast-Mate adapter

K575-Magnum 400 DS/FM gun (or competitive DS/FM gun)

Configuration 2

K489-7-Dual Schedule Fast-Mate adapter

K683-1-Dual Procedure Switch (3 pin)

K686-2-"Y" adapter (3pin + 5 pin to 5 pin)

K*-Non-DS Fast-Mate gun (Magnum 450WC, Magnum 200, Magnum 300, Magnum 400, and others)

K1558-1 REMOTE SWITCH INTERFACE MODULE

The Module provides for user interface connection of an external switch (flow switch, etc.) which must be closed to enable the feeder welding operation. Also, the Module provides for interface connection of external equipment (fume extractor, etc.) to the Module's isolated relay contacts which actuate when the feeder welding gas solenoid is activated (representing welding operation in process).

K1561-1 ROBOTICS INTERFACE MODULE

The module plugs directly into the LN-10 control board and provides an interface to a properly equipped Fanuc robot. When installed and properly configured, the K1561-1 Robotics Interface Module allows complete control of the welding process from the robot controller.

The Lincoln Electric Company's Automation Center should be contacted for questions regarding installation or operation of the Robotics Interface Module.

K1557-1 SWIVEL MOUNT

The K1557-1 Swivel mount attaches to the power source. This kit includes a feeder adapter plate that allows the feeder to rotate on top of the power source. The feeder can be easily separated from the swivel mount at any time. This option is compatible with the K1556-1 Light Duty Caster Kit.

K1556-1 LIGHT DUTY CASTER KIT

This option provides 4 casters and all required hardware to mount it to the Power Feed 10. This option is compatible with the K1557-1 Swivel Mount.

K1555-1 INSULATED LIFT HOOK

For applications where an insulated lift hook is required. This kit provides an easily installed, heavy duty insulated lift eye that mounts to the wire reel stand mast. See the instructions provided with the kit for installation.

K1634-1 WIRE REEL ENCLOSURE KIT

The K1634-1 Wire Reel Enclosure Kit provides the necessary parts to cover the wire and protect it from excessive dirt and contamination. The kit is not for use with 60lb coils (most 30 lb, 15kg, 44 lb fiber spools, and smaller coils will work). The kit includes a 2 part plastic reel cover, a Magnum conduit adapter for the incoming end of the wire feeder feed plate, and a short length of Magnum conduit to go between the reel cover and the feedplate.

MAINTENANCE

Safety Precautions

WARNING



ELECTRIC SHOCK can kill.

- Do not touch electrically live parts such as output terminals or internal wiring.
- When inching with gun trigger, electrode and drive mechanism are “hot” to work and ground and could remain energized several seconds after the gun trigger is released.
- Turn OFF input power at welding power source before installation or changing drive roll and/or guide tubes.
- Welding power source must be connected to system ground per the National Electrical Code or any applicable local codes.
- Only qualified personnel should perform this installation.

Observe all additional Safety Guidelines detailed throughout this manual.

Routine Maintenance

Drive Rolls and Guide Tubes

After feeding every coil of wire, inspect the drive roll section. Clean it as necessary. Do not use a solvent for cleaning the idle roll because it may wash the lubricant out of the bearing. The driver roll and guide tubes are stamped with the wire sizes they will feed. If a wire size other than that stamped on the roll(s) is to be used, the roll(s) and guide tubes must be changed.

The drive rolls for .035” (0.9mm) through .052” (1.3mm) cored electrode and 1/16” (1.6mm) through 3/32” (2.4mm) electrode have a double set of teeth so they can be reversed for additional life. Drive rolls for .023” (0.6 mm) through .052” (1.3 mm) solid electrodes and aluminum sizes have no teeth, but use two grooves so they also can be reversed for additional life.

See “Procedure to Install Drive Roll and Guide Tubes” in the INSTALLATION section for roll changing instructions.

Wire Reel Mounting - Readi-Reels and 10lb through 30lb (4.5-14kg) Spools

No routine maintenance required. Do not lubricate 2” (51mm) spindle.

Avoiding Wire Feeding Problems

Wire feeding problems can be avoided by observing the following gun handling and feeder set up procedures:

- Do not kink or pull cable around sharp corners.
- Keep the electrode cable as straight as possible when welding or loading electrode through cable.
- Do not allow dolly wheels or trucks to run over cables.
- Keep cable clean by following maintenance instructions.
- Use only clean, rust-free electrode. The Lincoln electrodes have proper surface lubrication.
- Replace contact tip when the arc starts to become unstable or the contact tip end is fused or deformed.
- Do not use excessive wire spindle brake settings.
- Use proper drive rolls, guide tubes and drive roll pressure settings.

Periodic Maintenance

Wire Drive Motor and Gearbox

Every year inspect the gearbox and coat the gear teeth with a moly-disulfide filled grease. Do not use graphite grease.

Every six months check the motor brushes. Replace them if they are less than 1/4” long.

Gun and Cable Maintenance

See appropriate Operator’s Manual.

Procedure for Removing Feedplate from Wire Feeder

- 1) Loosen the clamping collar screw using a 3/16” Allen wrench. The clamping collar screw is accessed from the bottom of the feedplate. It is the screw which is perpendicular to the feeding direction.
- 2) Loosen the retaining screw, which is also accessed from bottom of feeder, using a 3/16” Allen wrench. Continue to loosen the screw until the feedplate can be easily pulled off of the wire feeder.

LN-10

LINCOLN[®]
ELECTRIC

HOW TO USE TROUBLESHOOTING GUIDE

WARNING

Service and Repair should only be performed by Lincoln Electric Factory Trained Personnel. Unauthorized repairs performed on this equipment may result in danger to the technician and machine operator and will invalidate your factory warranty. For your safety and to avoid Electrical Shock, please observe all safety notes and precautions detailed throughout this manual.

This Troubleshooting Guide is provided to help you locate and repair possible machine malfunctions. Simply follow the three-step procedure listed below.

Step 1. LOCATE PROBLEM (SYMPTOM).

Look under the column labeled “PROBLEM (SYMPTOMS)”. This column describes possible symptoms that the machine may exhibit. Find the listing that best describes the symptom that the machine is exhibiting.

Step 2. POSSIBLE CAUSE.

The second column labeled “POSSIBLE CAUSE” lists the obvious external possibilities that may contribute to the machine symptom.

Step 3. RECOMMENDED COURSE OF ACTION

This column provides a course of action for the Possible Cause, generally it states to contact your local Lincoln Authorized Field Service Facility.

If you do not understand or are unable to perform the Recommended Course of Action safely, contact your local Lincoln Authorized Field Service Facility.

CAUTION

If for any reason you do not understand the test procedures or are unable to perform the tests/repairs safely, contact your **Local Lincoln Authorized Field Service Facility** for technical troubleshooting assistance before you proceed.

Observe all Safety Guidelines detailed throughout this manual

PROBLEMS (SYMPTOMS)	POSSIBLE CAUSE	RECOMMENDED COURSE OF ACTION
Rough wire feeding or wire not feeding, but drive rolls are turning.	<ol style="list-style-type: none"> 1. Gun cable kinked and/or twisted. 2. Wire jammed in gun and cable. 3. Check for current position of drive rolls relative to split wire guide groove. 4. Drive rolls may not be seated properly. 5. Gun cable dirty. 6. Worn drive roll. 7. Worn nozzle or cable liner. 9. Partially flashed or melted contact tip 10. Incorrect drive roll pressure. 11. Improper liner, contact tip, or inner/outer wire guides. 12. Incorrect wire drive or gear ratio selection on the control p.c. board. 	<p>If all recommended possible areas of misadjustment have been checked and the problem persists, Contact your local Lincoln Authorized Field Service Facility.</p>
Variable or "hunting" arc.	<ol style="list-style-type: none"> 1. Wrong size, worn and/or melted contact tip. 2. Worn work cable or poor work connection. 3. Loose electrode or work cable connections. 4. Wrong polarity. 5. Gas nozzle extended beyond gun tip or wire stickout too long while welding. 6. Poor gas shielding on processes requiring gas. 7. Improper power source selection on the control p.c. board. 	

 **CAUTION**

If for any reason you do not understand the test procedures or are unable to perform the tests/repairs safely, contact your **Local Lincoln Authorized Field Service Facility** for technical troubleshooting assistance before you proceed.

Observe all Safety Guidelines detailed throughout this manual

PROBLEMS (SYMPTOMS)	POSSIBLE CAUSE	RECOMMENDED COURSE OF ACTION
Poor arc striking with sticking or “blast-offs”, weld porosity, narrow and ropy looking bead, or electrode stubbing into the plate while welding.	<ol style="list-style-type: none"> 1. Improper procedures or techniques. 2. Improper gas shielding. 	<p>If all recommended possible areas of misadjustment have been checked and the problem persists, Contact your local Lincoln Authorized Field Service Facility.</p>
Tip seizes in the diffuser.	<ol style="list-style-type: none"> 1. Tip overheating because of prolonged or excessive high current and/or duty cycle welding. 	
Motor does not turn when trigger is pulled.	<ol style="list-style-type: none"> 1. The wire drive motor may be overloaded. “Hxx” will be displayed on the WFS display, where “xx” is the number of seconds until the wire drive attempts to run again. 2. A jumper plug or K1558-1 Remote Switch Interface Module must be properly installed into connector J5. 3. Damaged wiring in the trigger circuit. 4. Control p.c. board failure. 	
The drive motor does not turn although arc voltage is present and the gas solenoid is on.	<ol style="list-style-type: none"> 1. Damaged leads to the drive motor. 2. Damaged wire drive motor. 3. Damaged control p.c. board. 	
No control of wire feed speed. Motor turns. Gas solenoid operates properly and arc voltage is present. Wire feed speed can be set on the display, but has no control of the wire feed speed.	<ol style="list-style-type: none"> 1. Damaged leads to the motor tachometer. 2. Damaged tachometer. 3. Damaged control p.c. board 	
Wire feed motor turns and gas solenoid operates, but no arc voltage is present.	<ol style="list-style-type: none"> 1. Power source is unable to provide arc voltage because of thermal shutdown or other failure. 	

 **CAUTION**

If for any reason you do not understand the test procedures or are unable to perform the tests/repairs safely, contact your **Local Lincoln Authorized Field Service Facility** for technical troubleshooting assistance before you proceed.

Observe all Safety Guidelines detailed throughout this manual

PROBLEMS (SYMPTOMS)	POSSIBLE CAUSE	RECOMMENDED COURSE OF ACTION
Speed does not change when weld current flows.	<ol style="list-style-type: none"> 1. Run-in and weld speeds are set to the same value. 2. Current sensing reed switch is not operating properly. 3. The wiring from the control p.c. board to the weld current sensing reed switch is damaged. 4. Damaged control p.c. board. 	<p>If all recommended possible areas of misadjustment have been checked and the problem persists, Contact your local Lincoln Authorized Field Service Facility.</p>
Voltmeter does not function properly. Welding may or may not vary from normal procedure. Wire feeds properly.	<ol style="list-style-type: none"> 1. The work sense lead (#21) or the electrode sense lead (#67) may have intermittent or poor connections. 2. Improper power source selection on the control p.c. board. 3. Control p.c. board failure. 	
Cold feed forward or cold feed reverse buttons on keypad do not work, but motor control otherwise functions properly.	<ol style="list-style-type: none"> 1. The connector from the control p.c. board to the display p.c. board or the connector from the display p.c. board to the keypad are loose or improperly inserted. 2. Damaged keypad 3. Damaged display p.c. board. 4. Damaged control p.c. board. 	
Gas purge key does not operate the gas solenoid, but gas flow does occur while welding.	<ol style="list-style-type: none"> 1. The connector from the control p.c. board to the display p.c. board or the connector from the display p.c. board to the keypad are loose or improperly inserted. 2. Damaged keypad 3. Damaged display p.c. board. 3. Damaged control p.c. board. 	

 **CAUTION**

If for any reason you do not understand the test procedures or are unable to perform the tests/repairs safely, contact your **Local Lincoln Authorized Field Service Facility** for technical troubleshooting assistance before you proceed.

Observe all Safety Guidelines detailed throughout this manual

PROBLEMS (SYMPTOMS)	POSSIBLE CAUSE	RECOMMENDED COURSE OF ACTION
Pressing the procedure key does not select between A - Remote - B.	<ol style="list-style-type: none"> 1. The connector from the control p.c. board to the display p.c. board or the connector from the display p.c. board to the keypad are loose or improperly inserted. 2. Damaged keypad 3. Damaged display p.c. board. 4. Damaged control p.c. board. 	<p>If all recommended possible areas of misadjustment have been checked and the problem persists, Contact your local Lincoln Authorized Field Service Facility.</p>
Pressing the timer or control key has no effect while not welding.	<ol style="list-style-type: none"> 1. Make sure that the DIP switches on the control p.c. board are not set for security mode. 2. The connector from the control p.c. board to the display p.c. board or the connector from the display p.c. board to the keypad are loose or improperly inserted. 3. Damaged keypad 4. Damaged display p.c. board. 5. Damaged control p.c. board. 	
Pressing the trigger key has no effect while not welding.	<ol style="list-style-type: none"> 1. The connector from the control p.c. board to the display p.c. board or the connector from the display p.c. board to the keypad are loose or improperly inserted. 2. Damaged keypad 3. Damaged display p.c. board. 4. Damaged control p.c. board. 	

 **CAUTION**

If for any reason you do not understand the test procedures or are unable to perform the tests/repairs safely, contact your **Local Lincoln Authorized Field Service Facility** for technical troubleshooting assistance before you proceed.

Observe all Safety Guidelines detailed throughout this manual

PROBLEMS (SYMPTOMS)	POSSIBLE CAUSE	RECOMMENDED COURSE OF ACTION
One of the knobs changes the display, but the other doesn't.	<ol style="list-style-type: none"> 1. The display is in a mode that can only use one encoder. 2. The connector from the control p.c. board to the encoder p.c. boards may be loose or improperly inserted. 3. Damaged encoder p.c. board. 4. Damaged control p.c. board. 	<p>If all recommended possible areas of misadjustment have been checked and the problem persists, Contact your local Lincoln Authorized Field Service Facility.</p>
Neither knob changes the display.	<ol style="list-style-type: none"> 1. The connector from the control p.c. board to the encoder p.c. boards may be loose or improperly inserted. 2. Damaged control p.c. board. 3. Damaged encoder p.c. boards. 	
Displays & LED's on keypad are off. The green and red LED's on the control p.c. board are off.	<ol style="list-style-type: none"> 1. Power source is off. 2. Power source supply is not supplying 42 VAC to the wire feeder control box. 3. Damaged input power wiring in the LN-10 control box. 4. Damaged control p.c. board. 	
Displays & LED's on keypad are off. The green and red LED's on the control p.c. board are both blinking at about one second intervals.	<ol style="list-style-type: none"> 1. The connectors from the control p.c. board to the display p.c. board are loose or improperly inserted. 2. Damaged display p.c. board. 3. Damaged control p.c. board. 	
Displays & LED's on keypad are off. The green or red LED on the control p.c. board is blinking at a very fast or erratic rate.	<ol style="list-style-type: none"> 1. Damaged control p.c. board. 	

 **CAUTION**

If for any reason you do not understand the test procedures or are unable to perform the tests/repairs safely, contact your **Local Lincoln Authorized Field Service Facility** for technical troubleshooting assistance before you proceed.

Observe all Safety Guidelines detailed throughout this manual

PROBLEMS (SYMPTOMS)	POSSIBLE CAUSE	RECOMMENDED COURSE OF ACTION
The K1449-1 remote control is not functioning when the Procedure LED is in the REMOTE position.	<ol style="list-style-type: none"> 1. The remote control Amphenol connection is not securely attached. 2. Faulty wiring from the Amphenol connector to the control p.c. board. 3. Damaged remote control. 4. Damaged control p.c. board. 	<p>If all recommended possible areas of misadjustment have been checked and the problem persists, Contact your local Lincoln Authorized Field Service Facility.</p>
Dual procedure switch is not functioning at the gun.	<ol style="list-style-type: none"> 1. Machine and remote control not properly set for using a dual procedure switch at the gun 2. Disconnected or damaged wiring between the wire drive and control box. 3. Damaged wiring in the LN-10 wire drive. 4. Damaged wiring in the LN-10 control box. 5. Damaged control p.c. board. 	
Wire feed speed is consistent and adjustable, but operates at the wrong speed.	<ol style="list-style-type: none"> 1. DIP switch S1 is incorrectly set for the wrong wire drive or gear ratio. 2. Damaged control p.c. board. 	

 **CAUTION**

If for any reason you do not understand the test procedures or are unable to perform the tests/repairs safely, contact your **Local Lincoln Authorized Field Service Facility** for technical troubleshooting assistance before you proceed.

Observe all Safety Guidelines detailed throughout this manual

PROBLEMS (SYMPTOMS)	POSSIBLE CAUSE	RECOMMENDED COURSE OF ACTION
'Er' is displayed on power up.	<ol style="list-style-type: none"> EEPROM error detected. Damaged control p.c. board. 	<p>If all recommended possible areas of misadjustment have been checked and the problem persists, Contact your local Lincoln Authorized Field Service Facility.</p>
'GLP' is displayed.	<ol style="list-style-type: none"> Ground Loop Protection fault occurred GLP reed switch failure. Damaged control p.c. board. 	
After pressing the trigger, wire feeds for a couple seconds, but stops. The voltage display reads less than 8.0 volts while the wire is feeding.	<ol style="list-style-type: none"> Power source work & electrode sense lead polarity switch or jumper is not correctly set. Damaged wiring between the control p.c. board and the work and electrode connections. Damaged control p.c. board 	
The knobs do not control the complete range of wire feed speed or voltage.	<ol style="list-style-type: none"> Limits are set for wire feed speed or voltage. DIP switch S1 is incorrectly set for the wrong wire drive or gear ratio. Improper power source selection on the control p.c. board. 	
Gas solenoid not operating properly or intermittent.	<ol style="list-style-type: none"> Inlet gas pressure exceeding 80 psi(5.5 bar). Verify that gas pressure regulator is operating properly. 	

 **CAUTION**

If for any reason you do not understand the test procedures or are unable to perform the tests/repairs safely, contact your **Local Lincoln Authorized Field Service Facility** for technical troubleshooting assistance before you proceed.

Observe all Safety Guidelines detailed throughout this manual

PC BOARD TROUBLESHOOTING GUIDE - CONTROL P.C. BOARD

WARNING



ELECTRIC SHOCK can kill.

- Have a qualified individual install and service this equipment.
- Turn the power source input power off at the disconnect switch before working on this equipment.
- Do not touch electrically hot parts.

- c. If PC board is visibly damaged mechanically, inspect for cause, then remedy before installing a replacement PC board.

If there is damage to the PC board or if replacing PC board corrects problem, return it to the local Lincoln Electric Field Service Shop.

Procedure for Replacing PC Boards

Before replacing a PC board which is suspected of being defective, visually inspect the PC board in question for any electrical or mechanical damage to any of its components and conductors on the back of the board.

- a. If there is no visible damage to the PC board, install a new one and see if this remedies the problem. If the problem is remedied, reinstall the old PC board to see if the problem still exists. If it does no longer exist with old PC board:
1. Check the PC board harness connector pins for corrosion, contamination, or looseness.
 2. Check leads in the plug harness for loose or intermittent connection.
- b. If PC board is visibly damaged electrically, before possibly subjecting the new PC board to the same cause of failure, check for possible shorts, opens, or grounds caused by:
1. Frayed or pinched lead insulation.
 2. Poor lead termination, such as a poor contact or a short to adjacent connection or surface.
 3. Shorted or open motor leads, or other external leads.
 4. Foreign matter or interference behind the PC boards.

CAUTION

If for any reason you do not understand the test procedures or are unable to perform the tests/repairs safely, contact your **Local Lincoln Authorized Field Service Facility** for technical troubleshooting assistance before you proceed.

WIRING DIAGRAM (LN-10 / STT-10 WIRE DRIVE)

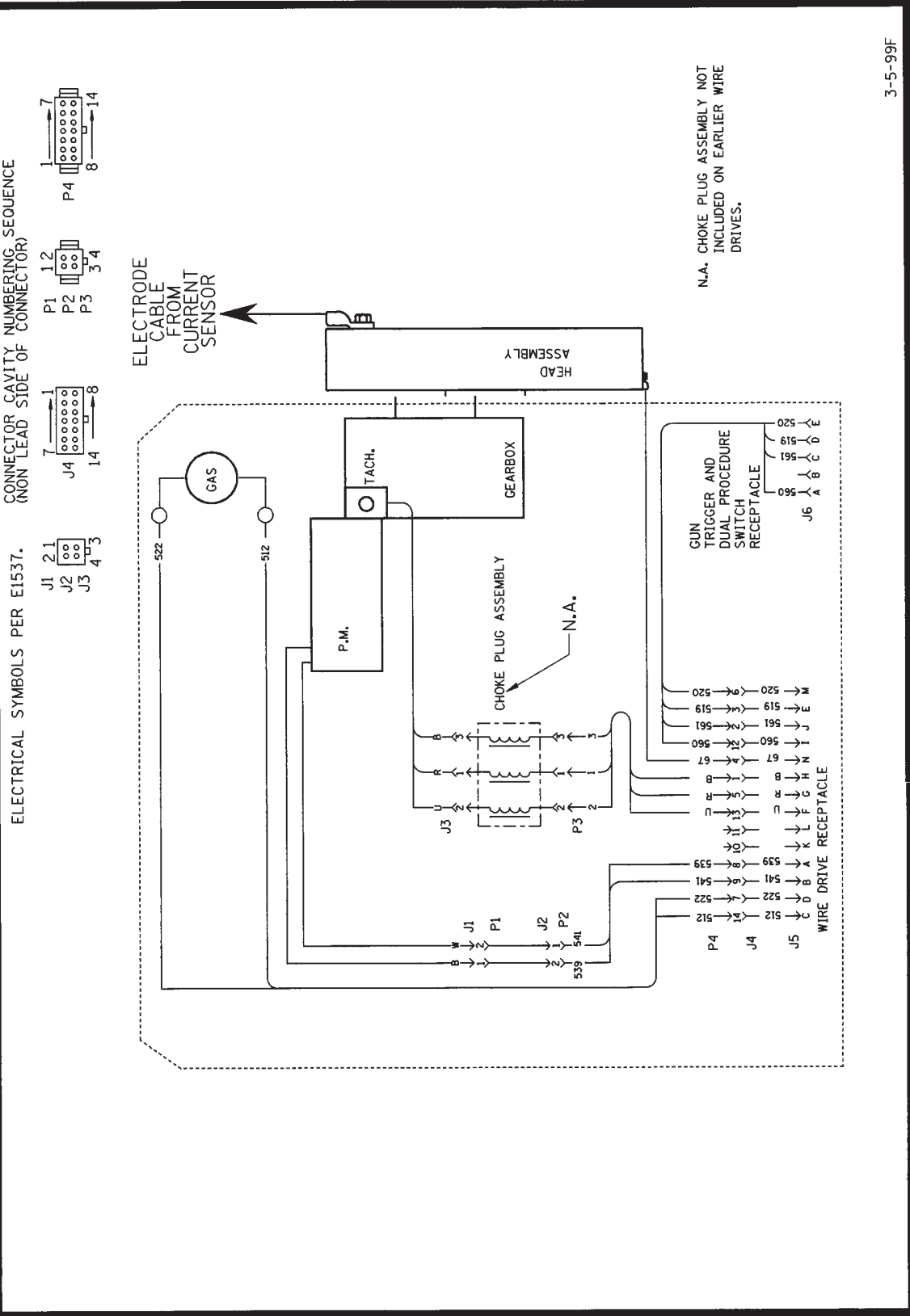

NOTE: This diagram is for reference only. It may not be accurate for all machines covered by this manual. The specific diagram for a particular code is pasted inside the machine on one of the enclosure panels. If the diagram is illegible, write to the Service Department for a replacement. Give the equipment code number.

WIRING DIAGRAM (LN-10 / STT-10 WIRE DRIVE)

CONNECTOR CAVITY NUMBERING SEQUENCE
(NON LEAD SIDE OF CONNECTOR)

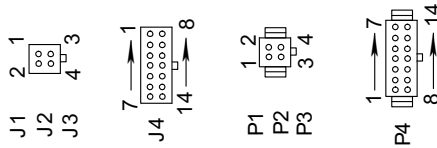

ELECTRICAL SYMBOLS PER E157.

ELECTRODE
CABLE
FROM
CURRENT
SENSOR

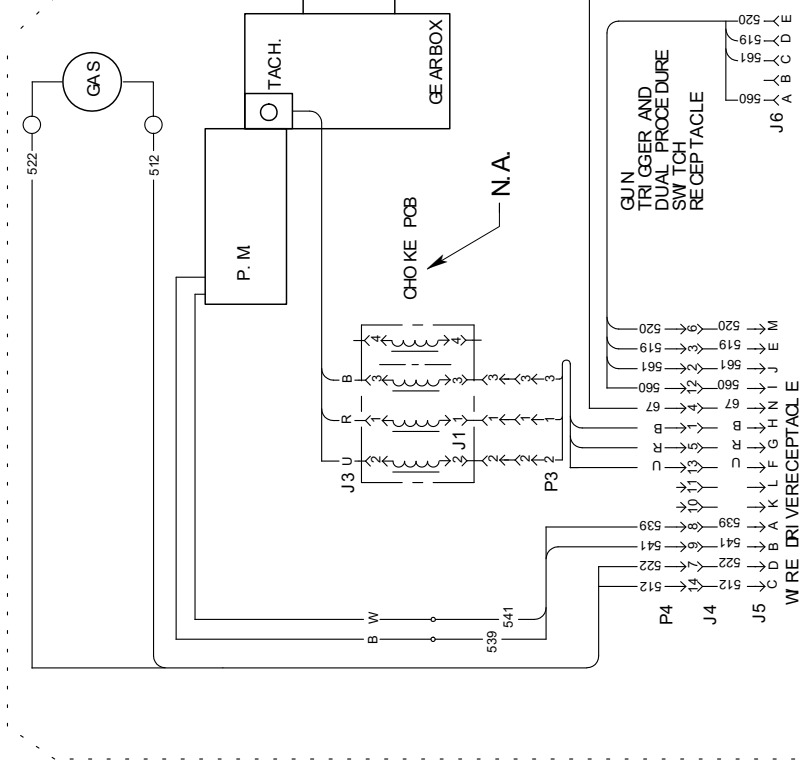

N. A. CHOKER COIL ASSEMBLY NOT
INCLUDED ON EARLIER WIRE
DRIVES.

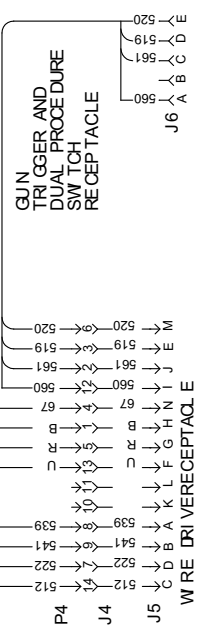

3-9-2001E

M19828

NOTE: This diagram is for reference only. It may not be accurate for all machines covered by this manual. The specific diagram for a particular code is pasted inside the machine on one of the enclosure panels. If the diagram is illegible, write to the Service Department for a replacement. Give the equipment code number.

DIAGRAMS

DIMENSION PRINT

BENCH MODEL DIMENSION PRINT

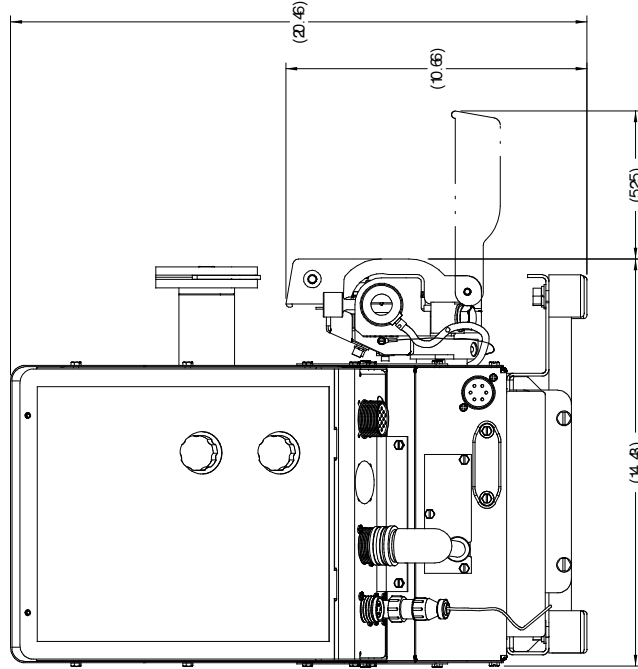

7-2000
M 18903

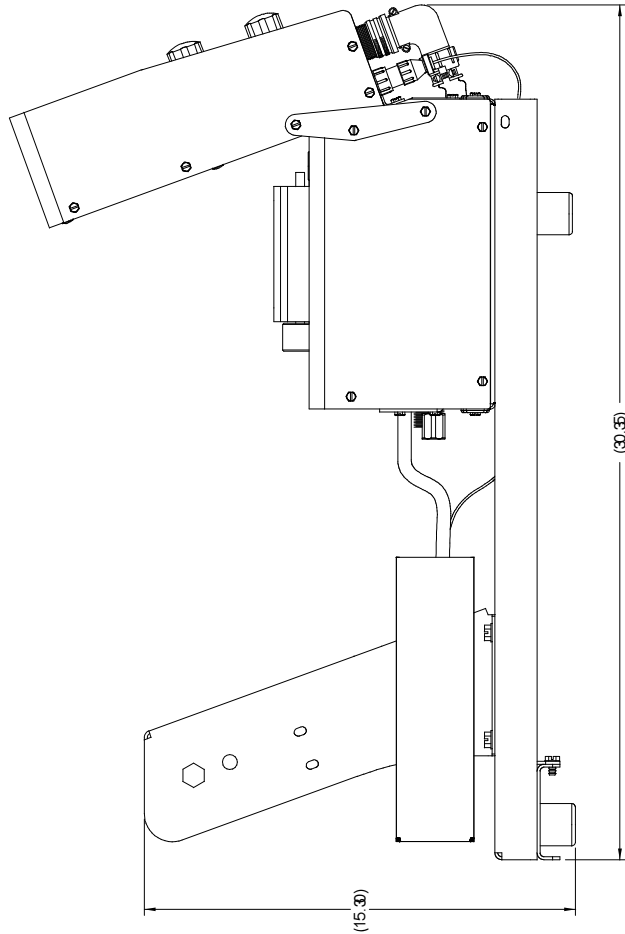

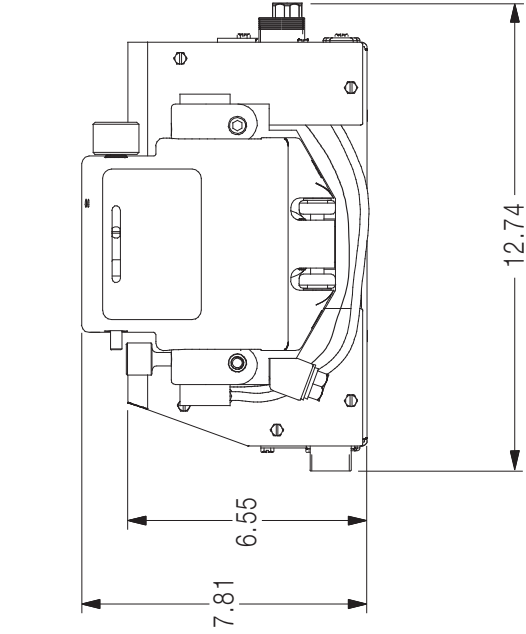

**WIRE DRIVE
DIMENSION PRINT**

7-2000
M18904

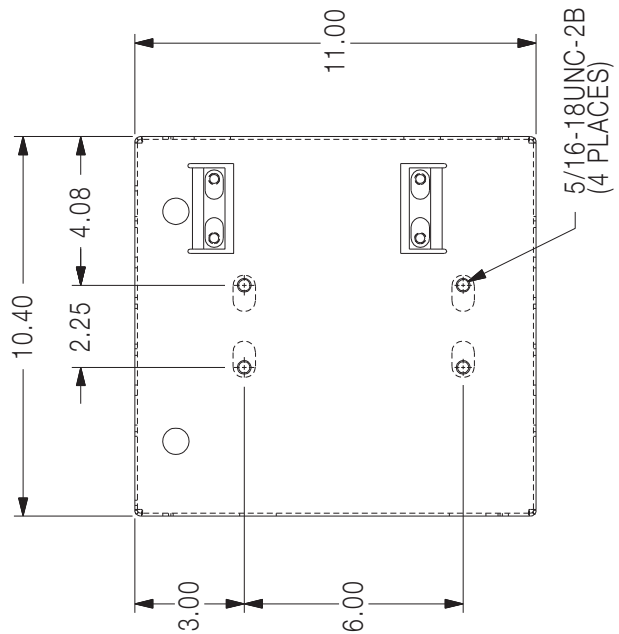
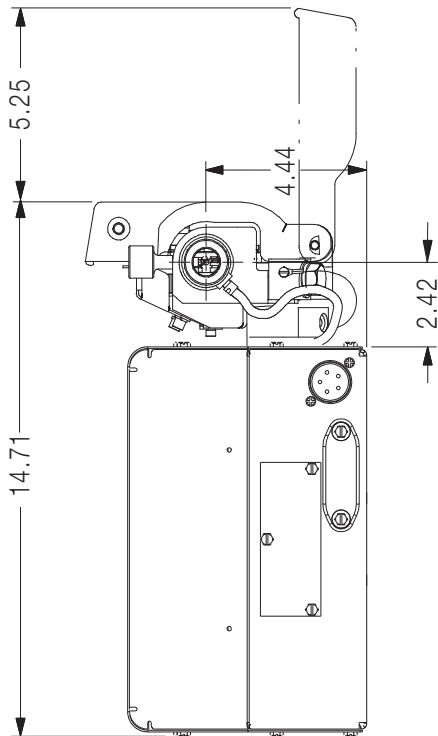

Boom Model Control Box
Dimension Print

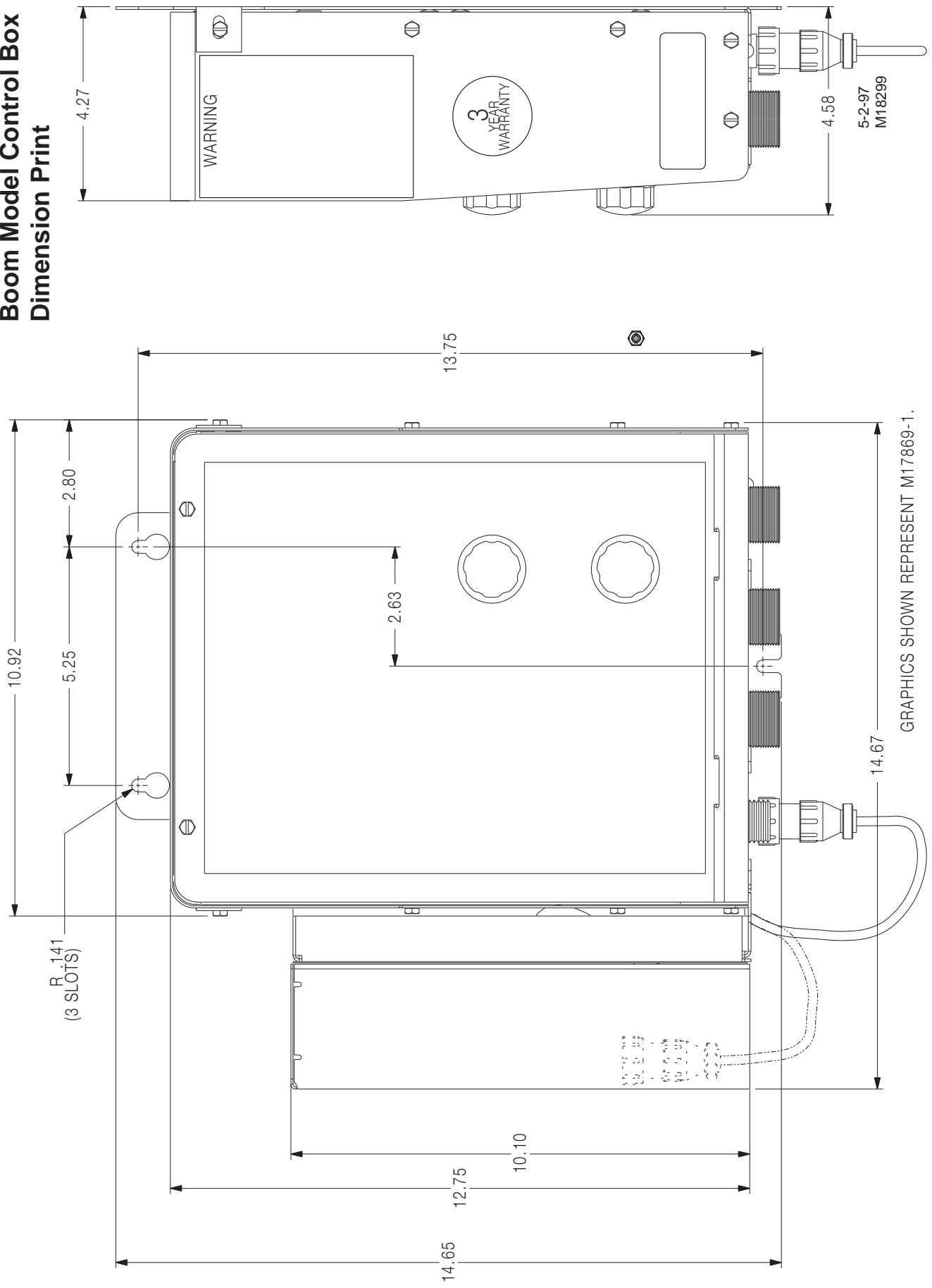

WARNING	<ul style="list-style-type: none"> Do not touch electrically live parts or electrode with skin or wet clothing. Insulate yourself from work and ground. 	<ul style="list-style-type: none"> Keep flammable materials away. 	<ul style="list-style-type: none"> Wear eye, ear and body protection.
Spanish AVISO DE PRECAUCION	<ul style="list-style-type: none"> No toque las partes o los electrodos bajo carga con la piel o ropa mojada. Aíslese del trabajo y de la tierra. 	<ul style="list-style-type: none"> Mantenga el material combustible fuera del área de trabajo. 	<ul style="list-style-type: none"> Protéjase los ojos, los oídos y el cuerpo.
French ATTENTION	<ul style="list-style-type: none"> Ne laissez ni la peau ni des vêtements mouillés entrer en contact avec des pièces sous tension. Isolez-vous du travail et de la terre. 	<ul style="list-style-type: none"> Gardez à l'écart de tout matériel inflammable. 	<ul style="list-style-type: none"> Protégez vos yeux, vos oreilles et votre corps.
German WARNUNG	<ul style="list-style-type: none"> Berühren Sie keine stromführenden Teile oder Elektroden mit Ihrem Körper oder feuchter Kleidung! Isolieren Sie sich von den Elektroden und dem Erdboden! 	<ul style="list-style-type: none"> Entfernen Sie brennbares Material! 	<ul style="list-style-type: none"> Tragen Sie Augen-, Ohren- und Körperschutz!
Portuguese ATENÇÃO	<ul style="list-style-type: none"> Não toque partes elétricas e electrodos com a pele ou roupa molhada. Isole-se da peça e terra. 	<ul style="list-style-type: none"> Mantenha inflamáveis bem guardados. 	<ul style="list-style-type: none"> Use proteção para a vista, ouvido e corpo.
Japanese 注意事項	<ul style="list-style-type: none"> 通電中の電気部品、又は溶材にヒフやぬれた布で触れないこと。 施工物やアースから身体が絶縁されている様にして下さい。 	<ul style="list-style-type: none"> 燃えやすいものの側での溶接作業は絶対にしてはなりません。 	<ul style="list-style-type: none"> 目、耳及び身体に保護具をして下さい。
Chinese 警告	<ul style="list-style-type: none"> 皮肤或湿衣物切勿接触带电部件及焊条。 使你自已与地面和工作件绝缘。 	<ul style="list-style-type: none"> 把一切易燃物品移离工作场所。 	<ul style="list-style-type: none"> 佩戴眼、耳及身体劳动保护用具。
Korean 위험	<ul style="list-style-type: none"> 전도체나 용접봉을 젖은 형갑 또는 피부로 절대 접촉치 마십시오. 모재와 접지를 접촉치 마십시오. 	<ul style="list-style-type: none"> 인화성 물질을 접근시키지 마십시오. 	<ul style="list-style-type: none"> 눈, 귀와 몸에 보호장구를 착용하십시오.
Arabic تحذير	<ul style="list-style-type: none"> لا تلمس الاجزاء التي يسري فيها التيار الكهربائي أو الألكترود بجند الجسم أو بالملابس المبللة بالماء. ضع عازلا على جسمك خلال العمل. 	<ul style="list-style-type: none"> ضع المواد القابلة للاشتعال في مكان بعيد. 	<ul style="list-style-type: none"> ضع أدوات وملابس واقية على عينيك وأذنيك وجسمك.

READ AND UNDERSTAND THE MANUFACTURER'S INSTRUCTION FOR THIS EQUIPMENT AND THE CONSUMABLES TO BE USED AND FOLLOW YOUR EMPLOYER'S SAFETY PRACTICES.

SE RECOMIENDA LEER Y ENTENDER LAS INSTRUCCIONES DEL FABRICANTE PARA EL USO DE ESTE EQUIPO Y LOS CONSUMIBLES QUE VA A UTILIZAR, SIGA LAS MEDIDAS DE SEGURIDAD DE SU SUPERVISOR.

LISEZ ET COMPRENEZ LES INSTRUCTIONS DU FABRICANT EN CE QUI REGARDE CET EQUIPMENT ET LES PRODUITS A ETRE EMPLOYES ET SUIVEZ LES PROCEDURES DE SECURITE DE VOTRE EMPLOYEUR.

LESEN SIE UND BEFOLGEN SIE DIE BETRIEBSANLEITUNG DER ANLAGE UND DEN ELEKTRODENEINSATZ DES HERSTELLERS. DIE UNFALLVERHÜTUNGSVORSCHRIFTEN DES ARBEITGEBERS SIND EBENFALLS ZU BEACHTEN.

			
<ul style="list-style-type: none"> ● Keep your head out of fumes. ● Use ventilation or exhaust to remove fumes from breathing zone. 	<ul style="list-style-type: none"> ● Turn power off before servicing. 	<ul style="list-style-type: none"> ● Do not operate with panel open or guards off. 	WARNING
<ul style="list-style-type: none"> ● Los humos fuera de la zona de respiración. ● Mantenga la cabeza fuera de los humos. Utilice ventilación o aspiración para gases. 	<ul style="list-style-type: none"> ● Desconectar el cable de alimentación de poder de la máquina antes de iniciar cualquier servicio. 	<ul style="list-style-type: none"> ● No operar con panel abierto o guardas quitadas. 	Spanish AVISO DE PRECAUCION
<ul style="list-style-type: none"> ● Gardez la tête à l'écart des fumées. ● Utilisez un ventilateur ou un aspirateur pour ôter les fumées des zones de travail. 	<ul style="list-style-type: none"> ● Débranchez le courant avant l'entretien. 	<ul style="list-style-type: none"> ● N'opérez pas avec les panneaux ouverts ou avec les dispositifs de protection enlevés. 	French ATTENTION
<ul style="list-style-type: none"> ● Vermeiden Sie das Einatmen von Schweißrauch! ● Sorgen Sie für gute Be- und Entlüftung des Arbeitsplatzes! 	<ul style="list-style-type: none"> ● Strom vor Wartungsarbeiten abschalten! (Netzstrom völlig öffnen; Maschine anhalten!) 	<ul style="list-style-type: none"> ● Anlage nie ohne Schutzgehäuse oder Innenschutzverkleidung in Betrieb setzen! 	German WARNUNG
<ul style="list-style-type: none"> ● Mantenha seu rosto da fumaça. ● Use ventilação e exaustão para remover fumo da zona respiratória. 	<ul style="list-style-type: none"> ● Não opere com as tampas removidas. ● Desligue a corrente antes de fazer serviço. ● Não toque as partes elétricas nuas. 	<ul style="list-style-type: none"> ● Mantenha-se afastado das partes moventes. ● Não opere com os painéis abertos ou guardas removidas. 	Portuguese ATENÇÃO
<ul style="list-style-type: none"> ● ヒュームから頭を離すようにして下さい。 ● 換気や排煙に十分留意して下さい。 	<ul style="list-style-type: none"> ● メンテナンス・サービスに取りかかる際には、まず電源スイッチを必ず切して下さい。 	<ul style="list-style-type: none"> ● パネルやカバーを取り外したまま機械操作をしないで下さい。 	Japanese 注意事項
<ul style="list-style-type: none"> ● 頭部遠離煙霧。 ● 在呼吸區使用通風或排風器除煙。 	<ul style="list-style-type: none"> ● 維修前切斷電源。 	<ul style="list-style-type: none"> ● 儀表板打開或沒有安全罩時不準作業。 	Chinese 警告
<ul style="list-style-type: none"> ● 얼굴로부터 용접가스를 멀리하십시오. ● 호흡지역으로부터 용접가스를 제거하기 위해 가스제거기나 통풍기를 사용하십시오. 	<ul style="list-style-type: none"> ● 보수전에 전원을 차단하십시오. 	<ul style="list-style-type: none"> ● 판넬이 열린 상태로 작동치 마십시오. 	Korean 위험
<ul style="list-style-type: none"> ● ابعء رأسك بعيداً عن الدخان. ● استعمل التهوية أو جهاز ضغط الدخان للخارج لكي تبعد الدخان عن المنطقة التي تتنفس فيها. 	<ul style="list-style-type: none"> ● اقطع التيار الكهربائي قبل القيام بأية صيانة. 	<ul style="list-style-type: none"> ● لا تشغيل هذا الجهاز اذا كانت الاغطية الحديدية الواقية ليست عليه. 	Arabic تحذير

LEIA E COMPREENDA AS INSTRUÇÕES DO FABRICANTE PARA ESTE EQUIPAMENTO E AS PARTES DE USO, E SIGA AS PRÁTICAS DE SEGURANÇA DO EMPREGADOR.

使う機械や溶材のメーカーの指示書をよく読み、まず理解して下さい。そして貴社の安全規定に従って下さい。

請詳細閱讀並理解製造廠提供的說明以及應該使用的銀焊材料，並請遵守貴方的有閣勞動保護規定。

이 제품에 동봉된 작업지침서를 숙지하시고 귀사의 작업자 안전수칙을 준수하시기 바랍니다.

اقرأ بتمعن وافهم تعليمات المصنع المنتج لهذه المعدات والمواد قبل استعمالها واتبع تعليمات الوقاية لصاحب العمل.



• World's Leader in Welding and Cutting Products •

• Sales and Service through Subsidiaries and Distributors Worldwide •

Cleveland, Ohio 44117-1199 U.S.A. TEL: 216.481.8100 FAX: 216.486.1751 WEB SITE: www.lincolnelectric.com