

## Table of Contents

|  |            |
|--|------------|
| <b>Introduction</b>                      | <b>4</b>   |
| <b>Instrument Cluster</b>                | <b>10</b>  |
| Warning and control lights               | 10         |
| Gauges                                   | 15         |
| <b>Entertainment Systems</b>             | <b>17</b>  |
| AM/FM stereo with in-dash six CD         | 17         |
| AM/FM stereo cassette with CD            | 21         |
| Navigation system                        | 25         |
| <b>Climate Controls</b>                  | <b>90</b>  |
| Electronic automatic temperature control | 90         |
| Rear window defroster                    | 97         |
| <b>Lights</b>                            | <b>98</b>  |
| Headlamps                                | 98         |
| Turn signal control                      | 101        |
| Bulb replacement                         | 102        |
| <b>Driver Controls</b>                   | <b>107</b> |
| Windshield wiper/washer control          | 107        |
| Steering wheel adjustment                | 108        |
| Power windows                            | 111        |
| Mirrors                                  | 112        |
| Speed control                            | 116        |
| Message center                           | 127        |
| <b>Locks and Security</b>                | <b>142</b> |
| Keys                                     | 142        |
| Locks                                    | 142        |
| Anti-theft system                        | 146        |

## Table of Contents

|                                      |            |
|--------------------------------------|------------|
| <b>Seating and Safety Restraints</b> | <b>157</b> |
| Seating                              | 157        |
| Safety restraints                    | 164        |
| Air bags                             | 177        |
| Child restraints                     | 189        |
| <b>Driving</b>                       | <b>201</b> |
| Starting                             | 201        |
| Brakes                               | 204        |
| Traction control/AdvanceTrac         | 207        |
| Transmission operation               | 210        |
| Vehicle loading                      | 218        |
| Trailer towing                       | 222        |
| Recreational towing                  | 222        |
| <b>Roadside Emergencies</b>          | <b>223</b> |
| Getting roadside assistance          | 223        |
| Hazard flasher switch                | 224        |
| Fuel pump shut-off switch            | 224        |
| Fuses and relays                     | 225        |
| Changing tires                       | 235        |
| Jump starting                        | 240        |
| Wrecker towing                       | 246        |
| <b>Customer Assistance</b>           | <b>247</b> |
| Reporting safety defects (U.S. only) | 255        |
| <b>Cleaning</b>                      | <b>256</b> |

## Table of Contents

|                                       |            |
|---------------------------------------|------------|
| <b>Maintenance and Specifications</b> | <b>262</b> |
| Engine compartment                    | 264        |
| Engine oil                            | 266        |
| Battery                               | 269        |
| Fuel information                      | 277        |
| Air filter(s)                         | 288        |
| Tire Information                      | 292        |
| Part numbers                          | 304        |
| Refill capacities                     | 305        |
| Lubricant specifications              | 306        |
| <b>Accessories</b>                    | <b>312</b> |
| <b>Index</b>                          | <b>314</b> |

All rights reserved. Reproduction by any means, electronic or mechanical including photocopying, recording or by any information storage and retrieval system or translation in whole or part is not permitted without written authorization from Ford Motor Company. Ford may change the contents without notice and without incurring obligation.

Copyright © 2004 Ford Motor Company

## Introduction

### CALIFORNIA Proposition 65 Warning



**WARNING:** Engine exhaust, some of its constituents, and certain vehicle components contain or emit chemicals known to the State of California to cause cancer and birth defects or other reproductive harm. In addition, certain fluids contained in vehicles and certain products of component wear contain or emit chemicals known to the State of California to cause cancer and birth defects or other reproductive harm.

### CONGRATULATIONS

Congratulations on acquiring your new Lincoln. Please take the time to get well acquainted with your vehicle by reading this handbook. The more you know and understand about your vehicle, the greater the safety and pleasure you will derive from driving it.

For more information on Ford Motor Company and its products visit the following website:

- In the United States: [www.ford.com](http://www.ford.com)
- In Canada: [www.ford.ca](http://www.ford.ca)
- In Mexico: [www.ford.com.mx](http://www.ford.com.mx)
- In Australia: [www.ford.com.au](http://www.ford.com.au)

Additional owner information is given in separate publications.

This *Owner's Guide* describes every option and model variant available and therefore some of the items covered may not apply to your particular vehicle. Furthermore, due to printing cycles it may describe options before they are generally available.

Remember to pass on the *Owner's Guide* when reselling the vehicle. It is an integral part of the vehicle.



**Fuel pump shut-off switch:** In the event of an accident the safety switch will automatically cut off the fuel supply to the engine. The switch can also be activated through sudden vibration (e.g. collision when parking). To reset the switch, refer to the *Fuel pump shut-off switch* in the *Roadside Emergencies* chapter.

### SAFETY AND ENVIRONMENT PROTECTION

#### **Warning symbols in this guide**

How can you reduce the risk of personal injury and prevent possible damage to others, your vehicle and its equipment? In this guide, answers to such questions are contained in comments highlighted by the warning triangle symbol. These comments should be read and observed.

#### **Warning symbols on your vehicle**

When you see this symbol, it is imperative that you consult the relevant section of this guide before touching or attempting adjustment of any kind.



#### **Protecting the environment**

We must all play our part in protecting the environment. Correct vehicle usage and the authorized disposal of waste, cleaning and lubrication materials are significant steps towards this aim. Information in this respect is highlighted in this guide with the tree symbol.



#### **BREAKING-IN YOUR VEHICLE**

Your vehicle does not need an extensive break-in. Try not to drive continuously at the same speed for the first 1,000 miles (1,600 km) of new vehicle operation. Vary your speed frequently in order to give the moving parts a chance to break in.

Drive your new vehicle at least 500 miles (800 km) before towing a trailer.

Do not add friction modifier compounds or special break-in oils during the first few thousand miles (kilometers) of operation, since these additives may prevent piston ring seating. See *Engine oil* in the *Maintenance and Specifications* chapter for more information on oil usage.

## Introduction

### SPECIAL NOTICES

#### Emission warranty

The New Vehicle Limited Warranty includes Bumper-to-Bumper Coverage, Safety Restraint Coverage, Corrosion Coverage, and 6.0L Power Stroke Diesel Engine Coverage. In addition, your vehicle is eligible for Emissions Defect and Emissions Performance Warranties. For a detailed description of what is covered and what is not covered, refer to the *Warranty Guide* that is provided to you along with your Owner's Guide.

#### Special instructions

For your added safety, your vehicle is fitted with sophisticated electronic controls.



Please read the section *Supplemental restraint system (SRS)* in the *Seating and Safety Restraints* chapter. Failure to follow the specific warnings and instructions could result in personal injury.



Front seat mounted rear-facing child or infant seats should **NEVER** be placed in front of an active passenger air bag.

#### Service Data Recording

Service data recorders in your vehicle are capable of collecting and storing diagnostic information about your vehicle. This potentially includes information about the performance or status of various systems and modules in the vehicle, such as engine, throttle, steering or brake systems. In order to properly diagnose and service your vehicle, Ford Motor Company, Ford of Canada, and service and repair facilities may access vehicle diagnostic information through a direct connection to your vehicle when diagnosing or servicing your vehicle.

## Introduction

### **Event Data Recording**

Other modules in your vehicle — event data recorders — are capable of collecting and storing data during a crash or near crash event. The recorded information may assist in the investigation of such an event. The modules may record information about both the vehicle and the occupants, potentially including information such as:

- how various systems in your vehicle were operating;
- whether or not the driver and passenger seatbelts were buckled;
- how far (if at all) the driver was depressing the accelerator and/or the brake pedal;
- how fast the vehicle was traveling; and
- where the driver was positioning the steering wheel.

To access this information, special equipment must be directly connected to the recording modules. Ford Motor Company and Ford of Canada do not access event data recorder information without obtaining consent, unless pursuant to court order or where required by law enforcement, other government authorities or other third parties acting with lawful authority. Other parties may seek to access the information independently of Ford Motor Company and Ford of Canada.

### **MIDDLE EAST/NORTH AFRICA VEHICLE SPECIFIC INFORMATION**

For your particular global region, your vehicle may be equipped with features and options that are different from the ones that are described in this *Owner's Guide*; therefore, a supplement has been supplied that complements this book. By referring to the pages in the provided supplement, you can properly identify those features, recommendations and specifications that are unique to your vehicle. **Refer to this Owner's Guide for all other required information and warnings.**

## Introduction

These are some of the symbols you may see on your vehicle.











### Vehicle Symbol Glossary

|                                 |   |                                   |  |
|---------------------------------|---|-----------------------------------|--|
| Safety Alert                    |    | See Owner's Guide                 |    |
| Fasten Safety Belt              |    | Air Bag-Front                     |    |
| Air Bag-Side                    |    | Child Seat                        |    |
| Child Seat Installation Warning |    | Child Seat Lower Anchor           |    |
| Child Seat Tether Anchor        |    | Brake System                      |    |
| Anti-Lock Brake System          |   | Brake Fluid - Non-Petroleum Based |   |
| Traction Control                |  | AdvanceTrac <sup>™</sup>          |  |
| Master Lighting Switch          |  | Hazard Warning Flasher            |  |
| Fog Lamps-Front                 |  | Fuse Compartment                  |  |
| Fuel Pump Reset                 |  | Windshield Wash/Wipe              |  |
| Windshield Defrost/Demist       |  | Rear Window Defrost/Demist        |  |



## Introduction

### Vehicle Symbol Glossary

|                                     |   |   |  |
|-------------------------------------|---|---|--|
| Power Windows<br>Front/Rear         |    | Power Window Lockout                              |    |
| Child Safety Door<br>Lock/Unlock    |    | Interior Luggage<br>Compartment Release<br>Symbol |    |
| Panic Alarm                         |    | Engine Oil  |    |
| Engine Coolant                      |    | Engine Coolant<br>Temperature                     |    |
| Do Not Open When Hot                |    | Battery   |    |
| Avoid Smoking, Flames,<br>or Sparks |    | Battery Acid                                      |    |
| Explosive Gas                       |  | Fan Warning                                       |  |
| Power Steering Fluid                |  | Maintain Correct Fluid<br>Level                   |  |
| Emission System                     |  | Engine Air Filter                                 |  |
| Passenger Compartment<br>Air Filter |  | Jack  |  |
| Check fuel cap                      |  | Low tire warning                                  |  |

## Instrument Cluster

### WARNING LIGHTS AND CHIMES

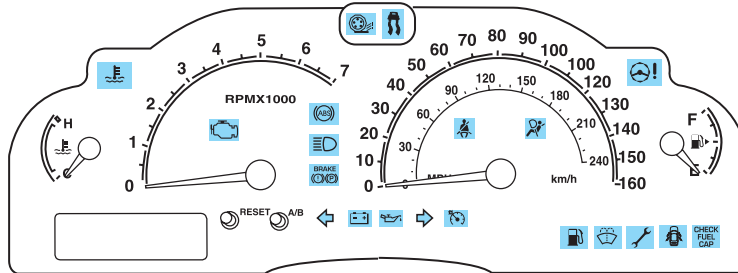

Warning lights and gauges can alert you to a vehicle condition that may become serious enough to cause expensive repairs. A warning light may illuminate when a problem exists with one of your vehicle's functions. Many lights will illuminate when you start your vehicle to make sure the bulb works. If any light remains on after starting the vehicle, have the respective system inspected immediately.

**Check engine:** The *Check Engine* indicator light illuminates when the ignition is first turned to the ON position to check the bulb. Solid illumination after the engine is started indicates the On Board Diagnostics System (OBD-II) has detected a malfunction. Refer to *On board diagnostics (OBD-II)* in the *Maintenance and Specifications* chapter. If the light is blinking, engine misfire is occurring which could damage your catalytic converter. Drive in a moderate fashion (avoid heavy acceleration and deceleration) and have your vehicle serviced immediately.

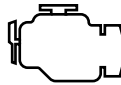

Under engine misfire conditions, excessive exhaust temperatures could damage the catalytic converter, the fuel system, interior floor coverings or other vehicle components, possibly causing a fire.

#### **Check fuel cap (if equipped):**

Illuminates when the fuel cap may not be properly installed. Continued driving with this light on may cause the Check engine warning light to come on. Refer to *Fuel filler cap* in the *Maintenance and Specifications* chapter.

**CHECK  
FUEL  
CAP**

## Instrument Cluster

**Brake system warning light:** To confirm the brake system warning light is functional, it will momentarily illuminate when the ignition is turned to the ON position when the engine is not running, or in a position between ON and START, or by applying the parking brake when the ignition is turned to the ON position. If the brake system warning light does not illuminate at this time, seek service immediately from your dealership. Illumination after releasing the parking brake indicates low brake fluid level and the brake system should be inspected immediately by your servicing dealership.



 Driving a vehicle with the brake system warning light on is dangerous. A significant decrease in braking performance may occur. It will take you longer to stop the vehicle. Have the vehicle checked by your dealer immediately.

**Anti-lock brake system:** If the ABS light stays illuminated or continues to flash, a malfunction has been detected, have the system serviced immediately. Normal braking is still functional unless the brake warning light also is illuminated.



**Air bag readiness:** If this light fails to illuminate when ignition is turned to ON, continues to flash or remains on, have the system serviced immediately. A chime will also sound when a malfunction in the supplemental restraint system has been detected.



**Safety belt:** Reminds you to fasten your safety belt. A chime will also sound to remind you to fasten your safety belt.



**Charging system:** Illuminates when the battery is not charging properly.



## Instrument Cluster

**Engine oil pressure:** Illuminates when the oil pressure falls below the normal range, refer to *Engine oil* in the *Maintenance and specifications* chapter.

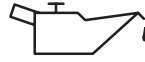

**Engine coolant temperature:** Illuminates when the engine coolant temperature is high. Stop the vehicle as soon as possible, switch off the engine and let cool. Refer to *Engine coolant* in the *Maintenance and specifications* chapter.



Never remove the coolant recovery cap while the engine is running or hot.

**Transmission PRNDL indicator:**

Displays the gearshift positions. If an “E” character is displayed or flashing, this indicates a transmission malfunction, contact your dealer immediately. Operating the transmission with the “E” character illuminated may cause additional damage to the transmission.



**AdvanceTrac™ (if equipped):**

Illuminates when the AdvanceTrac™ system is active. If the light remains on, have the system serviced immediately, refer to the *Driving* chapter for more information.



**Traction Control™ active:**

Illuminates when the Traction Control™ is active. If the light remains on, have the system serviced immediately, refer to the *Driving* chapter for more information.



**Steering column lock (if equipped):**

Illuminates when the steering column is locked. If the light stays on the vehicle will not start, make sure the key is the correct key, refer to *Securilock™* in the *Locks and Security* chapter.



## Instrument Cluster

**Low fuel (if equipped):**

Illuminates when the fuel level in the fuel tank is at or near empty (refer to *Fuel gauge* in this chapter).



**Speed control:** Illuminates when the speed control is activated. Turns off when the speed control system is deactivated.



**Low washer fluid (if equipped):**

Illuminates when the windshield washer fluid is low.



**Door ajar (if equipped):**

Illuminates when the ignition is in the ON position and any door or trunk is ajar.



**Turn signal:** Illuminates when the left or right turn signal or the hazard lights are turned on. If the indicators stay on or flash faster, check for a burned out bulb.



**High beams:** Illuminates when the high beam headlamps are turned on.



**Electronic throttle control (if equipped):** Illuminates when the engine has defaulted to a 'limp-home' operation. Report the fault to a dealer at the earliest opportunity.



## Instrument Cluster

### WARNING CENTER

The instrument cluster is equipped with a warning center that will provide the following warning messages:

**Bulb warning:** Displays when one of the exterior front turn/park lamps or rear brake/turn/tail lamps bulb has burned out. Depress the RESET control to return to the Trip odometer display.

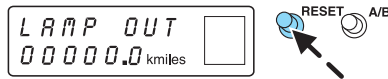

**Park brake ON:** Displayed when the park brake is ON. If the warning stays on after the park brake is off, contact your dealer as soon as possible.



**Park brake ON & needs service:** Displayed when the park brake is ON and malfunctioning. If the warning stays on or continues to come on, contact your dealer as soon as possible.

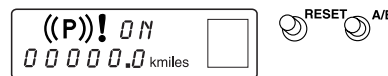

**Service park brake:** Displayed when the park brake needs servicing. If the warning stays on or continues to come on, contact your dealer as soon as possible.

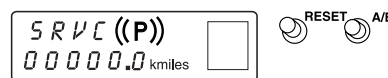

**Apply park brake:** Displayed when the park brake needs to be applied. If the warning stays on or continues to come on, contact your dealer as soon as possible.

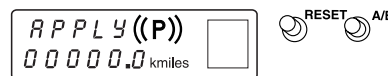

**Foot on brake:** Displayed when the foot brake needs to be applied. If the warning stays on or continues to come on, contact your dealer as soon as possible.

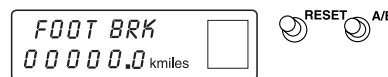

**Key-in-ignition warning chime:** Sounds when the key is left in the ignition in the OFF/LOCK or ACCESSORY position and the driver's door is opened.

**Headlamps on warning chime:** Sounds when the headlamps or parking lamps are on, the ignition is off (the key is not in the ignition) and the driver's door is opened.

## Instrument Cluster

### GAUGES

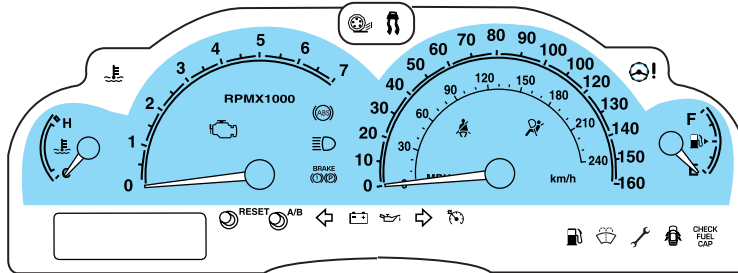

**Speedometer:** Indicates the current vehicle speed.

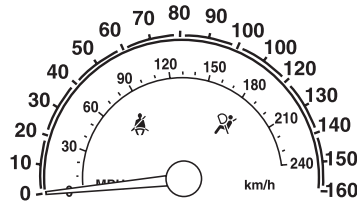

**Engine coolant temperature gauge:** Indicates engine coolant temperature. At normal operating temperature, the needle will be in the normal range (between “H” and “C”). **If it enters the red section, the engine is overheating. Stop the vehicle as soon as safely possible, switch off the engine and let the engine cool.**



Never remove the coolant reservoir cap while the engine is running or hot.

**Odometer:** Registers the total miles (kilometers) of the vehicle.

- Standard instrument cluster



## Instrument Cluster

- Optional instrument cluster

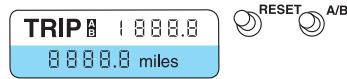

**Trip odometer:** Registers the miles (kilometers) of individual journeys. To reset, depress the RESET control. To switch the display from Trip A to the Trip B, depress the A/B control.

- Standard instrument cluster



- Optional instrument cluster

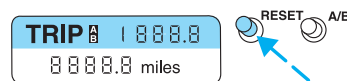

**Tachometer:** Indicates the engine speed in revolutions per minute. Driving with your tachometer pointer continuously at the top of the scale may damage the engine.

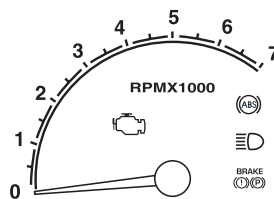

**Fuel gauge:** Indicates approximately how much fuel is left in the fuel tank (when the ignition is in the ON position). The fuel gauge may vary slightly when the vehicle is in motion or on a grade.



Refer to *Filling the tank* in the *Maintenance and Specifications* chapter for more information.



## Entertainment Systems

### AUDIOPHILE SATELLITE READY AM/FM STEREO IN-DASH SIX CD RADIO (IF EQUIPPED)

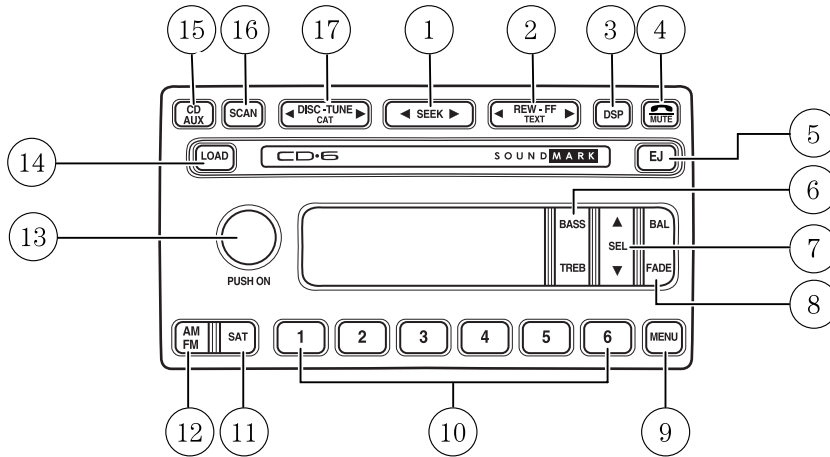

1. **Seek:** Press and release SEEK ◀ / ▶ for previous/next strong station, selection or track.



2. **Rewind:** In CD mode, press until desired selection is reached.



**Fast forward:** In CD mode, press until desired selection is reached.

**TEXT:** TEXT is only available when equipped with Satellite radio. Your Audiophile radio comes equipped with Satellite ready capability. The kit to enable Satellite reception is available through your Lincoln dealer. Detailed Satellite instructions are included with the dealer installed kit. *Dealer installed satellite kit available only in the continental United States.*

#### 3. DSP (Digital Signal

**Processing):** Press DSP to access the Ambiance menu. Ambiance gives the feeling of “being there” to your music, creating increased clarity as well as an open and spacious feel to the music. Press SEL to engage/disengage. Turn the volume control to increase/decrease the level of ambiance.

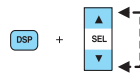

## Entertainment Systems

**Occupancy:** Press DSP again to change the occupancy mode to optimize sound for ALL SEATS, DRIVER SEAT or REAR SEATS. Press SEL to scroll through settings.

4. **Mute:** Press to MUTE playing media; press again to return to playing media



5. **Eject:** Press to eject a CD. Press and hold to eject all loaded discs.



6. **Bass:** Press BASS; then press SEL ▼ / ▲ to decrease/increase the bass output.

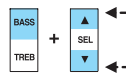

**Treble:** Press TREB; then press SEL ▼ / ▲ to decrease/increase the treble output.



7. **Select:** Use with Bass, Treble, Balance and Fade controls to adjust levels and set the clock.



8. **Balance:** Press BAL; then press SEL ▼ / ▲ to shift sound to the left/right speakers.

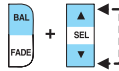

**Fade:** Press FADE; then press SEL ▼ / ▲ to shift sound to the rear/front speakers.

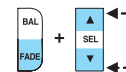

9. **Menu:** Press MENU and SEL to access clock mode, RDS on/off, Traffic announcement mode, Program type mode, and Shuffle mode.

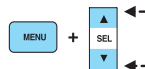

The Federal Communications Commission (FCC) and the Canadian Radio and Telecommunications Commission (CRTC) recommend that FM radio broadcasters use RDS technology to transmit information. FM radio stations are independently operated and individually elect to use RDS technology to transmit station ID and program type as desired.

**RDS on/off** (Radio Data System) : Allows traffic, program type and station information from RDS-equipped FM stations.

## Entertainment Systems

**Traffic:** In FM mode with RDS ON, this feature allows you to hear traffic broadcasts. With the feature ON, press SEEK or SCAN to find a station broadcasting a traffic report (if it is broadcasting RDS data). *Traffic information is not available in most U.S. markets.*

**FIND Program type:** In FM mode and with RDS ON, this feature allows you to search RDS-equipped stations for a certain category of music format: Classic, Country, Info, Jazz, Oldies, R&B, Religious, Rock, Soft, Top 40. Select type them press SEEK or SCAN.

**Show TYPE:** In FM mode with RDS ON, this feature displays the station's call letters and format.

**Shuffle:** With a CD playing, press to play tracks in a random order. Press MENU until SHUF appears in the display. Use SEL to select SHUF DISC, SHUF TRAC or SHUF OFF.

**Compression:** With a CD playing, this feature brings soft and loud CD passages together for a more consistent listening level. Press MENU until compression status is displayed. Press the SEL control to enable the compression feature when COMP OFF is displayed. Press the SEL control again to disable the feature when COMP ON is displayed.

**Setting the clock:** Press MENU until SELECT HOUR or SELECT MINS is displayed. Use SEL to manually increase (▲) or decrease (▼) the hours/minutes. Press MENU again to disengage clock mode.

10. **Memory presets:** To set a station: Select frequency band AM/FM1/FM2; tune to a station, press and hold a preset button until sound returns.



11. **SAT (if equipped):** Your Audiophile radio comes equipped with Satellite Ready capability. The kit to enable the Satellite reception is available through your Lincoln dealer. Detailed satellite instructions are included with the dealer installed kit. *Dealer installed satellite kit available only in the continental United States.*



12. **AM/FM:** Press to select AM/FM1/FM2 frequency band.



## Entertainment Systems

**Autoset:** Allows you to set the strongest local radio stations without losing your original manually set preset stations for AM/FM1/FM2 . Press and momentarily hold AM/FM. AUTOSET will flash on the display. When the six strongest stations are filled, the station stored in preset 1 will begin playing. If there are less than six strong stations, the system will store the last one in the remaining presets. Press again to disengage.

13. **Power/volume:** Press to turn ON/OFF; turn to increase or decrease volume levels.



**Speed sensitive volume:** Radio volume changes automatically and slightly with vehicle speed to compensate for road and wind noise. Recommended level is 1–3. Level 0 turns the feature off and level 7 is the maximum setting. Press and hold the volume control for five seconds. Then press SEL to increase (▲) or decrease (▼) the volume setting. The level will appear in the display.

14. **Load:** Press to load a CD. Press and hold to load up to six discs.



15. **CD AUX:** Press to access CD or AUX mode.



**CD units are designed to play commercially pressed 4.75 in (12 cm) audio compact discs only. Due to technical incompatibility, certain recordable and re-recordable compact discs may not function correctly when used in Ford CD players. Irregular shaped CDs, CDs with a scratch protection film attached, and CDs with homemade paper (adhesive) labels should not be inserted into the CD player. The label may peel and cause the CD to become jammed. It is recommended that homemade CDs be identified with permanent felt tip marker rather than adhesive labels. Ballpoint pens may damage CDs. Please contact your dealer for further information.**

16. **Scan:** Press SCAN to hear a brief sampling of radio stations or CD tracks. Press again to stop.



17. **Disc/Tune:** Press ◀ or ▶ to manually tune down/up the radio frequency band, or to listen to the previous/next track on the CD.



## Entertainment Systems

**CAT:** CAT is only available when equipped with Satellite Radio. Your Audiophile radio comes equipped with Satellite ready capability. The kit to enable Satellite reception is available through your Lincoln dealer. Detailed Satellite instructions are included with the dealer installed kit. *Dealer installed satellite kit available only in the continental United States.*

For information regarding SIRIUS Satellite Radio, please call toll-free 888-539-SIRIUS (888-539-7474) or visit the SIRIUS website at [www.siriusradio.com](http://www.siriusradio.com)

### PREMIUM AM/FM STEREO/CASSETTE/SINGLE CD (IF EQUIPPED)

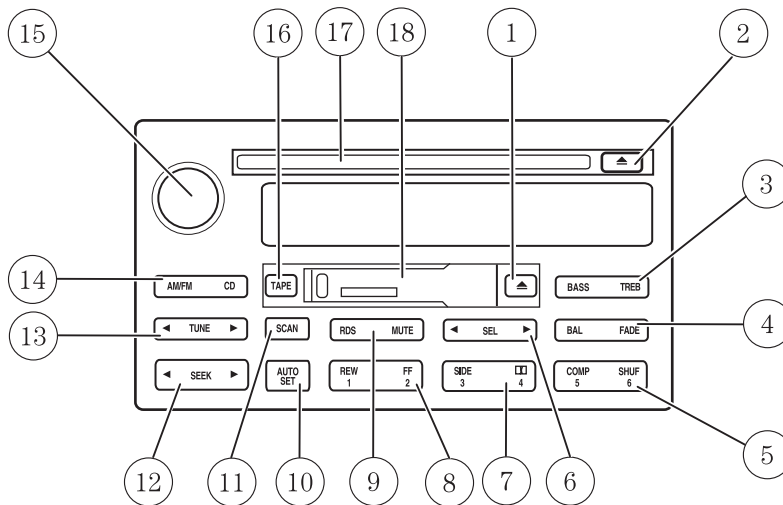

1. **Eject:** Press to eject a cassette.



2. **Eject:** Press to eject a CD.



3. **Bass:** Allows you to increase or decrease the audio system's bass output. Press BASS then press SEL to decrease ◀ or increase ▶ the bass levels.



## Entertainment Systems

**Treble:** Allows you to increase or decrease the audio system's treble output. Press TREB then press SEL to decrease ◀ or increase ▶ the treble levels.



4. **Balance:** Allows you to shift speaker sound between the right and left speakers. Press BAL then press SEL to shift sound to the left ◀ or right ▶.



**Fade:** Allows you to shift speaker sound between the front and rear speakers. Press FADE then press SEL to shift the sound to the rear ◀ or the front ▶.



5. **COMP (Compression):** In CD mode, press to bring soft and loud passages together for a more consistent listening level.



**SHUF (Shuffle):** Press to play CD tracks in random order.



6. **Select:** Use to adjust bass, treble, balance and fade levels.



7. **Side 1–2:** Press to change sides on the tape.



**Dolby:  Dolby® noise reduction:** Reduces tape noise and hiss; press to activate/deactivate.



8. **REW (Rewind):** Works in tape and CD modes.



In tape mode, radio play continues until rewind is stopped (with the TAPE control) or the beginning of the tape is reached.

In CD mode, REW control reverses the CD within the current track.

**FF (fast forward):** Works in tape and CD modes.



In the tape mode, tape direction automatically reverses when the end of the tape is reached.

## Entertainment Systems

In CD mode, FF advances the CD within the current track.

9. **Mute:** Press to mute the playing media.



**RDS:** (Radio Data System): Allows you to access FM stations which are RDS- equipped. Press RDS then SEL to select from:

**Traffic** — Allows you to receive traffic announcements and control their volume level. **Traffic information is not available in most U.S. markets.**

**Program Type** — Allows you to set your audio system to select from RDS-equipped stations for categories such as: Classic, Country, Info., Jazz, Oldies, R&B, Religious, Rock, Soft, Top 40.

**Show** — Allows you to view the frequency and program type of the chosen radio station.

The Federal Communications Commission (FCC) and the Canadian Radio and Telecommunications Commission (CRTC) recommend that FM radio broadcasters use RDS technology to transmit information. FM radio stations are independently operated and individually elect to use RDS technology to transmit station ID and program type as desired.

**Setting the clock:** Press RDS until SELECT HOUR or SELECT MINS is displayed. Press SEL to increase (▲) or decrease (▼).

10. **Autoset:** Press to set first six strong stations into AM, FM1 or FM2 memory buttons; press again to return to normal stations.



11. **Scan:** Works in radio, tape and CD modes. Press SCAN for a brief sampling of radio stations, tape selections or CD tracks.



12. **Seek:** Works in radio, tape and CD modes. Press to access the previous ◀ or next ▶ listenable radio station, tape selection or CD track.



13. **Tune:** Works in radio mode. Press to manually advance up or down the frequency band.



## Entertainment Systems

14. **AM/FM/CD:** Press AM/FM to select a radio frequency. Press while in tape or CD mode to return to radio mode. Press CD to enter CD mode and to play a CD already in the system.



**CD units are designed to play commercially pressed 4.75 in (12 cm) audio compact discs only. Due to technical incompatibility, certain recordable and re-recordable compact discs may not function correctly when used in Ford CD players. Irregular shaped CDs, CDs with a scratch protection film attached, and CDs with homemade paper (adhesive) labels should not be inserted into the CD player. The label may peel and cause the CD to become jammed. It is recommended that homemade CDs be identified with permanent felt tip marker rather than adhesive labels. Ballpoint pens may damage CDs. Please contact your dealer for further information.**

15. **Power/volume:** Press to turn the system on/off. Turn to raise/lower the volume.

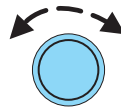

**Speed sensitive volume:** (if equipped) Radio volume changes automatically and slightly with vehicle speed to compensate for road and wind noise. Press and hold the volume control for five seconds. Then press SEL to increase (▲) or decrease (▼) the volume setting. The level will appear in the display.

16. **TAPE:** Press to play reverse side of the tape.



17. **CD door:** Insert the disc with the playing side down and printed side up.

18. **Tape door:** Insert the tape facing the right.

### RADIO FREQUENCIES

AM and FM frequencies are established by the Federal Communications Commission (FCC) and the Canadian Radio and Telecommunications Commission (CRTC). Those frequencies are:

AM - 530, 540–1700, 1710 kHz

FM- 87.7, 87.9–107.7, 107.9 MHz



## Entertainment Systems

### RADIO RECEPTION FACTORS

There are three factors that can effect radio reception:

- Distance/strength: The further you travel from an FM station, the weaker the signal and the weaker the reception.
- Terrain: Hills, mountains, tall buildings, power lines, electric fences, traffic lights and thunderstorms can interfere with your reception.
- Station overload: When you pass a broadcast tower, a stronger signal may overtake a weaker one and play while the weak station frequency is displayed.

### CD/CD PLAYER CARE

Do:

- Handle discs by their edges only. Never touch the playing surface.
- Inspect discs before playing. Clean only with an approved CD cleaner and wipe from the center out.

Don't:

- Expose discs to direct sunlight or heat sources for extended periods of time.
- Insert more than one disc into each slot of the CD changer magazine.
- Clean using a circular motion.

**CD units are designed to play commercially pressed 12 cm (4.75 in) audio compact discs only. Due to technical incompatibility, certain recordable and re-recordable compact discs may not function correctly when used in Ford CD players. Irregular shaped CDs, CDs with a scratch protection film attached, and CDs with homemade paper (adhesive) labels should not be inserted into the CD player. The label may peel and cause the CD to become jammed. It is recommended that homemade CDs be identified with permanent felt tip marker rather than adhesive labels. Ball point pens may damage CDs. Please contact your dealer for further information.**

### AUDIO SYSTEM WARRANTY AND SERVICE

Refer to the *Warranty Guide* for audio system warranty information. If service is necessary, see your dealer or qualified technician.

### LINCOLN NAVIGATION SYSTEM (IF EQUIPPED)

Your vehicle may be equipped with a Lincoln Navigation System which allows you to listen to the radio, play CDs and also navigate the vehicle using a navigation DVD.

## Entertainment Systems

### **THX audio system (if equipped)**

Your vehicle may be equipped with the THX® certified premium audio system. This system creates optimal acoustic quality for all seating positions and road conditions.



The system offers an advanced speaker system, amplifier, subwoofer and equalizer.

Your Lincoln Navigation System has a large range of features, yet is easy to use. Guidance is shown on the display screen and is supplemented with voice prompts. The display screen provides full information for operating the system through use of menus, text screens and map displays. Screen selections are made by touching the desired selection on the screen.

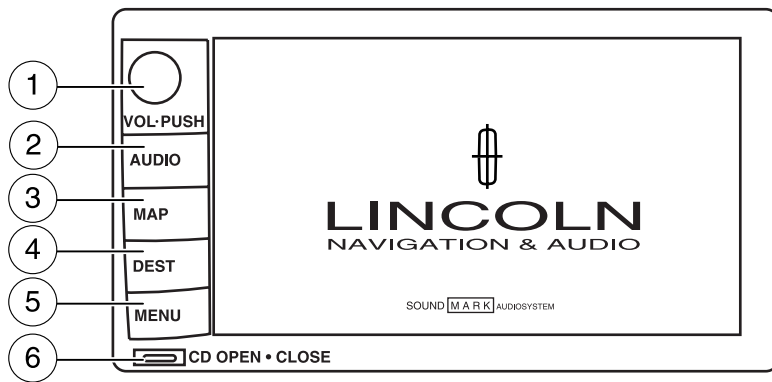

1. **VOL-PUSH:** Press to turn the system ON/OFF. Turn to adjust the audio volume level.
2. **AUDIO:** Press to enter audio mode and access radio, CD, CDDJ, DVD (if equipped) settings.
3. **MAP:** Press to enter map mode and view your current vehicle position on the map. Press and hold to obtain additional position information. This will not function without a map DVD loaded.

## Entertainment Systems

4. **DEST:** Press to enter Destination Entry mode. This allows you to enter a destination and route to it. With an active route, pressing DEST allows the user to request a Detour, display entire route, select route preferences, or change or cancel the destination. This will not function without a map DVD loaded.
5. **MENU:** Press to access system settings such as display, brightness, clock mode (if equipped), etc.
6. **CD OPEN CLOSE:** Press to open/close the display screen and access the CD player.

### ***Cold temperature advisory***

When operating the system below 32° Fahrenheit (0° Celsius), the display screen requires 20–30 minutes warm-up to achieve maximum brightness. Ensure that the system display setting is set to DAY mode until maximum brightness is achieved (refer to *Menu mode* section). Once maximum brightness is achieved, revert to AUTO mode display setting.

### ***Initial map display***

After pressing AGREE to the initial WARNING screen, you will move into the initial map screen which shows the current vehicle location. Pressing the globe icon will take you to the user settings — audible feedback, navigation units, language and clock (if equipped).



### **Quick Start — How to get going**

#### **To play a radio station:**

1. Ensure that the vehicle ignition is on.
2. Press AUDIO.

## Entertainment Systems

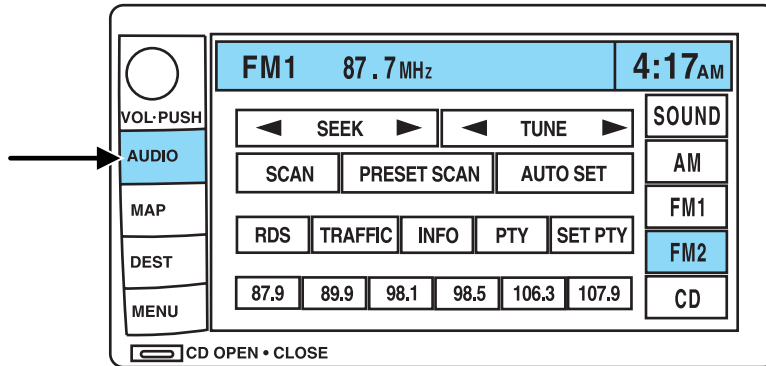

3. Select AM, FM1 or FM2.
4. Press TUNE to adjust manually up (▶) or down (◀) the frequency band.
5. Press SEEK to find the next strong station up (▶) or down (◀).

**Note:** If PTY (program type) is selected, the station selection will be limited. Refer to *Program Type (PTY)* for further information.

### To play a previously loaded CD:

1. Ensure that the vehicle ignition is on.
2. Press AUDIO.
3. Press CD to select a CD which is already loaded. (NO CD will appear in the display if there are no CDs loaded into the system). Use the controls (1–6) to select the desired CD.
4. CD will begin to play.

## Entertainment Systems

### To load CDs:

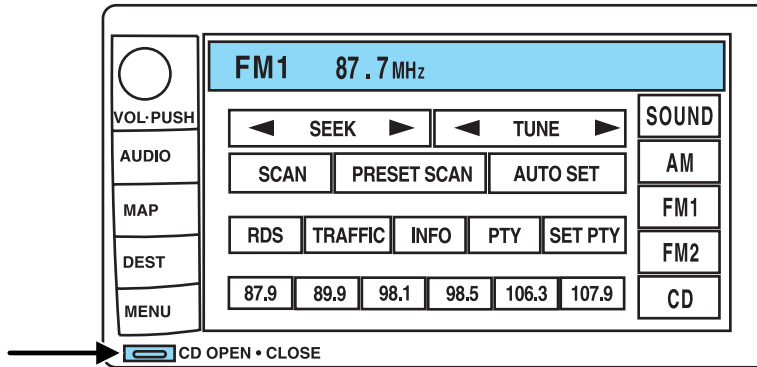

1. Press CD OPEN CLOSE at the bottom of the screen to load a CD. (The screen will open).
2. Press LOAD and select the desired slot. Or, press and hold LOAD to auto load all available slots. The slot indicator lights blink rate will increase when the system is ready to accept a disc. Push CD OPEN CLOSE to close the screen. Once closed, the CD will begin to play.
3. Use the touch controls to advance tracks, scan, pause, etc.

### To use the Navigation system:

1. Ensure that the vehicle ignition is on, and the navigation DVD is loaded into the navigation DVD player. Refer to *Loading the map DVD* or *Navigation system — DVD location* in the Index for your vehicle's navigation DVD location.

## Entertainment Systems

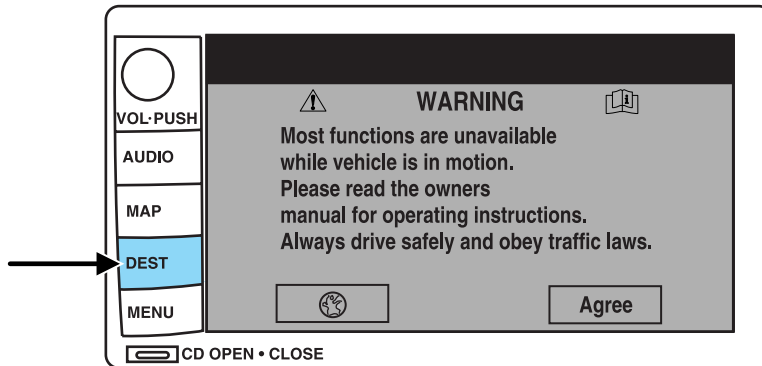

2. Press DEST. The warning screen will appear. After reading, press AGREE. The screen will show a map with your current location. Press DEST again.

3. Select the desired type of destination entry. You may select “Address”, “Point of Interest”, “Emergency” or “Previous Dest” from the first screen.

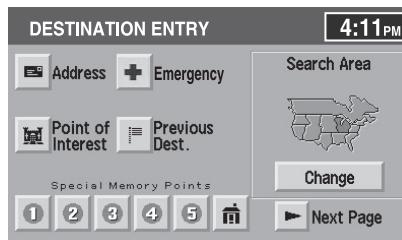

Or, press “▶ Next Page” to access selections of “Memory Point”, “Select from map”, “Freeway Ent/Exit” and “Special Memory Points.” After making your selection, enter any required information.

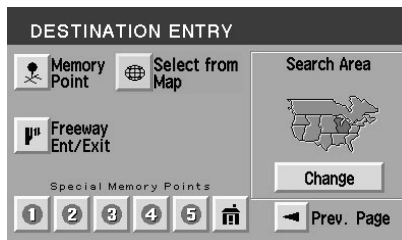

## Entertainment Systems

4. Press DEST at the bottom of the map screen.
5. Choose the desired route by pressing the NEXT button (if it appears). There can be up to three alternative routes.
6. Press START to begin the navigation guidance.

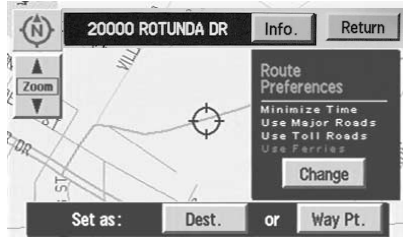

### To adjust the voice guidance volume:

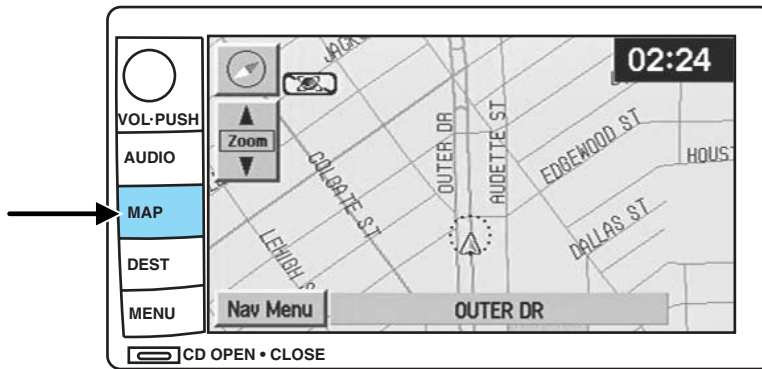

1. Press the MAP hard key.
2. Press “Nav Menu” at the bottom left hand corner of the screen.
3. Press On/Off to turn the voice guidance option on/off. Use the numeric keys (1–7) to determine the volume level of the guidance voice prompts.



### **Voice activated commands (if equipped)**

Your Lincoln Navigation System (LNS) may be equipped with a voice activated feature which allows you to “speak” certain commands to the system. Speaking clearly will help to ensure that the system correctly responds to your commands. Ensure that the commands are spoken in English (not any other language) and that they are spoken exactly as they are written, or they may not function.

## Entertainment Systems

Press VOICE briefly (on your steering wheel controls) and the voice icon  appears on the Navigation display. Press REPEAT to hear the previous command repeated from the navigation system.

The voice activated command feature will not operate if a map DVD is not inserted into the navigation DVD unit.

At any time, you may say these commands to change modes:

- Radio
- AM
- FM1
- FM2
- CD
- Power on
- Audio on
- Audio off
- Power off
- CD Changer (if equipped)
- DVD (if equipped)

During normal radio operation, you may say:

- Seek up
- Seek down

Disc operation commands you may say when using a rear seat DVD (if equipped):

- Track up
- Previous track
- Disc down
- Previous disc
- Track down
- Disc up
- Next disc

During CDDJ or in-dash CD play, you may say:

- Track up
- Previous track
- Next disc
- Previous disc
- Track down
- Disc up
- Disc down

To change the screen display, you may say the following commands:

- Screen off
- Day mode on
- Night mode on
- Auto mode on
- Screen day mode
- Screen night mode
- Screen auto mode

**Note:** If you say “Screen off”, you must touch the screen in order to activate the screen again. The screen will not turn on again with a voice command.



## Entertainment Systems

Commands that jump over screens:

- Current position
- Map
- Current location

While in navigation map mode, the following commands are available:

- Zoom in
- Minimum scale
- North up
- Heading up
- Map direction
- Mark this point
- Zoom out
- Maximum scale
- Change to North up
- Change to heading up
- Change map direction
- Mark

While in navigation POI mode, the following commands are available by voice activation:

- Automobile club
- Auto service & maintenance
- Gas station
- Parking garage
- ATM
- City hall
- Community center
- Exhibition center
- Higher education
- College
- Library
- School
- Casino
- Marina
- Park & recreation
- Performing arts
- Skiing
- Stadium
- Winery
- I'm hungry
- American food
- AAA (Triple A)
- Auto service
- Gas
- Parking lot
- Bank
- Civic center
- Convention center
- Court house
- University
- Hospital
- Police station
- Amusement park
- Golf course
- Museum
- Parks & recreation
- Ski resort
- Sports complex
- Tourist attraction
- Restaurant
- American restaurant
- Chinese restaurant

## Entertainment Systems

- Chinese food
- Continental food
- French food
- Italian food
- Japanese food
- Mexican food
- Seafood
- Other food
- Shopping mall
- Airport
- Ferry terminal
- Hotel
- Rental car agency
- Rest stop
- Train station
- City center
- Commuter rail station
- Continental restaurant
- French restaurant
- Italian restaurant
- Japanese restaurant
- Mexican restaurant
- Seafood restaurant
- Other restaurant
- Shopping
- Grocery store
- Bus station
- Historical monument
- Park and ride
- Rest area
- Tourist information
- Business facility
- POI off
- City center

While in navigation destination (DEST) mode, the following commands are available:

- Home
- Previous starting point
- Next way point map
- Second way point map
- Fourth way point map
- Destination map
- Cancel destination
- Go home
- Go starting point
- First way point map
- Third way point map
- Fifth way point map
- Delete destination

While in navigation guidance mode, the following commands are available by voice activation:

- Repeat guidance
- Louder
- Voice guidance off
- Open guidance screen
- Arrow guidance
- Repeat voice
- Softer
- Voice guidance on
- Close guidance screen
- Arrow guide

## Entertainment Systems

- Change to arrow guidance
- Turn list guidance
- Change to turn list guidance
- Entire route map
- Route overview
- Detour
- Change to arrow guide
- Turn list guide
- Change to turn list guide
- Entire route
- Reroute
- Detour entire route

Navigation help commands you may speak at any time:

- Help
- Destination
- Radio
- Map help
- Guidance help
- Disc help
- Map
- Guidance
- Disc
- Destination help
- Radio help

### Audio mode

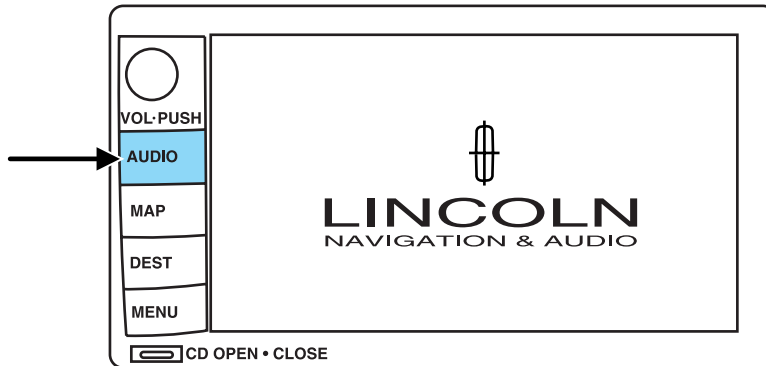

Your Lincoln Navigation Audio System has many features including a full range of audio functions. To access these functions, press AUDIO on the main bezel. This will take you into audio mode.

## Entertainment Systems

### **Volume/power control**

Press knob to turn the audio system on/off. Turn to raise or lower volume. The levels will be displayed on the screen.

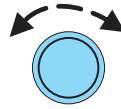

To activate the navigation mode, press MAP or DEST.

To adjust the navigation voice output level, select the NAV MENU button via the map screen.

### **Speed compensated volume (SCV)**

With this feature, radio volume changes automatically with vehicle speed to compensate for road and wind noise. To engage the SCV feature:

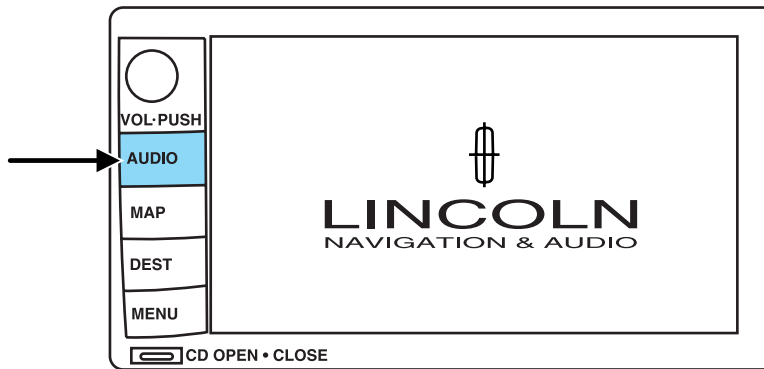

1. Press AUDIO.
2. Press SOUND.

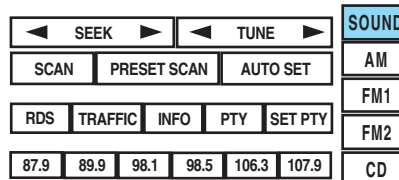

## Entertainment Systems

3. SCV is located in the middle of the screen. Press to turn on.
4. Select setting 1 to 7 or turn off.

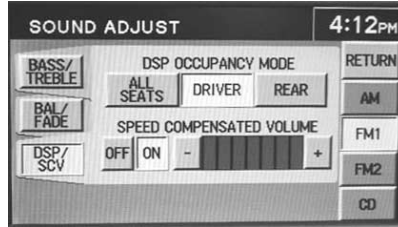

The recommended level for the speed compensated volume is from level 1 through level 3. When activated, level 1 is the minimum setting and level 7 is the maximum setting.

### **AM/FM select**

The AM/FM control works in radio, CD and navigation modes.

#### **AM/FM select in radio mode**

Press AM/FM1/FM2 to switch between AM/FM1/FM2 memory preset stations.

#### **AM/FM select in CD mode**

Press to stop CD play and begin radio play.

#### **AM/FM select in navigation mode**

The radio will continue to play in the background of the navigation screens. To access, press AUDIO then AM/FM1/FM2.

### **Seek**

- Press ► / ◀ to find the next listenable station up/down the frequency band.
- Press ► / ◀ to advance to the next/previous track on a CD.

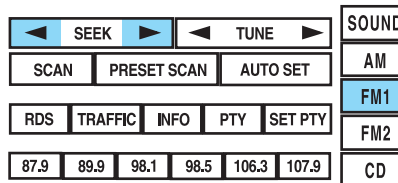

## Entertainment Systems

### **Tune adjust**

Press TUNE to manually move down/up (◀/▶) the frequency band.

In CD mode, press TRACK to select the previous/next (◀/▶).

|          |             |       |      |         |       |     |
|----------|-------------|-------|------|---------|-------|-----|
| ◀ SEEK ▶ | ◀ TUNE ▶    | SOUND |      |         |       |     |
| SCAN     | PRESET SCAN | AM    |      |         |       |     |
| RDS      | TRAFFIC     | INFO  | PTY  | SET PTY | FM1   |     |
| 87.9     | 89.9        | 98.1  | 98.5 | 106.3   | 107.9 | FM2 |
|          |             |       |      |         |       | CD  |

### **Scan**

Press SCAN for a brief sampling of all listenable stations and CD tracks. Press again to disable and remain on the current selection.

|          |             |       |      |         |       |     |
|----------|-------------|-------|------|---------|-------|-----|
| ◀ SEEK ▶ | ◀ TUNE ▶    | SOUND |      |         |       |     |
| SCAN     | PRESET SCAN | AM    |      |         |       |     |
| RDS      | TRAFFIC     | INFO  | PTY  | SET PTY | FM1   |     |
| 87.9     | 89.9        | 98.1  | 98.5 | 106.3   | 107.9 | FM2 |
|          |             |       |      |         |       | CD  |

### **Preset scan**

Press PRESET SCAN to scan the stations stored in the memory presets.

|          |             |       |      |         |       |     |
|----------|-------------|-------|------|---------|-------|-----|
| ◀ SEEK ▶ | ◀ TUNE ▶    | SOUND |      |         |       |     |
| SCAN     | PRESET SCAN | AM    |      |         |       |     |
| RDS      | TRAFFIC     | INFO  | PTY  | SET PTY | FM1   |     |
| 87.9     | 89.9        | 98.1  | 98.5 | 106.3   | 107.9 | FM2 |
|          |             |       |      |         |       | CD  |

### **Autoset memory preset**

Autoset allows you to set strong radio stations without losing your original manually set preset stations. This feature is helpful on trips when you travel between cities with different radio stations.

## Entertainment Systems

### Starting autoselect memory preset

1. Select a frequency band using AM/FM1/FM2.

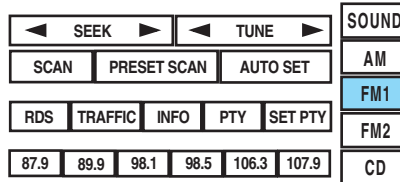

2. Press AUTO SET.

3. When the first six strong stations are filled, the station stored in memory preset control 1 will start playing.

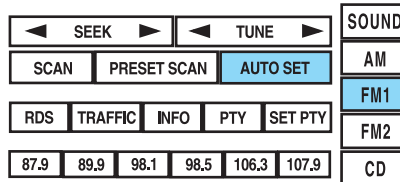

If there are less than six strong stations available on the frequency band, the remaining memory preset controls will all store the last strong station available.

To deactivate autoselect and return to your audio system's manually set memory stations, press the AUTO SET again.

### Radio data system (RDS) feature

This feature allows your audio system to receive text information from RDS-equipped FM radio stations such as station call letters, program type, etc. When in FM mode, press RDS to activate/deactivate.

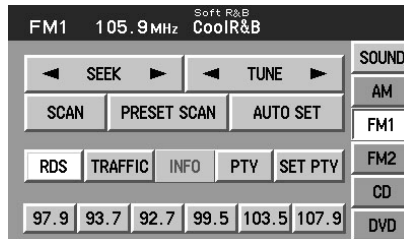

## Entertainment Systems

### Traffic function

Select TRAFFIC for traffic information broadcast from certain stations which will automatically interrupt radio or CD playback at a preset volume level.

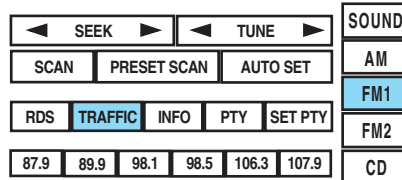

**Traffic information not available in most U.S. markets.**

### Information feature

Press INFO to view the frequency, call letters and PTY category of the selected FM station.

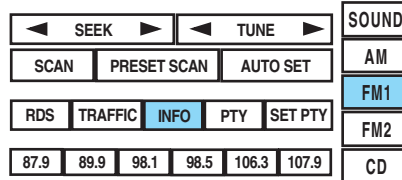

**Note:** Not all stations support INFO function.

### Program type (PTY)

This feature allows you to search for Radio Data System (RDS) stations selectively by their program type.

Ensure that the RDS function is turned on. Press PTY to turn the feature on/off.

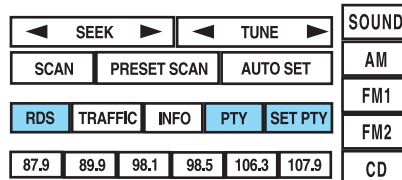

### To set/change PTY:

Ensure that the RDS function is turned on.  
Press SET PTY to select from the following program types:

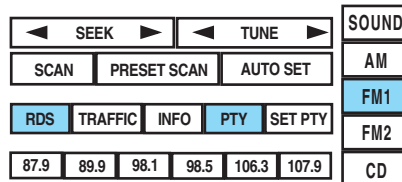



## Entertainment Systems

- All
- Classical
- Country
- Information
- Jazz
- Religious
- Rock
- Soft
- Top 40

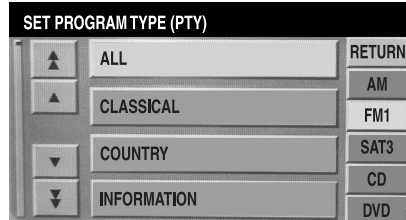

Once PTY has been programmed, press SEEK (▶ / ◀) or SCAN to initiate a search up or down the frequency.

Preset scan and Autoset also initiate PTY searches. The search will stop when the desired program type has been reached. If no program type is found, a message will display.

**Note:** Not all stations support PTY information.

### Sound functions

To access settings for Bass, Treble, Balance, Fade, DSP (Digital Signal Programming), SCV (Speed Compensated Volume), and Occupancy modes:

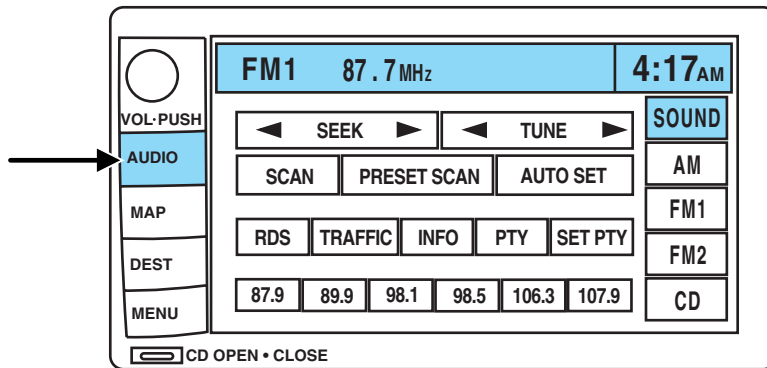

1. Press AUDIO.
2. Press SOUND.
3. Select from Bass/Treb; Bal/Fade; DSP/SCV.

## Entertainment Systems

4. Press +/- to increase/decrease the levels.

**Bass** : Allows you to increase or decrease the audio system's bass output.

**Treble** : Allows you to raise or lower the audio system's treble output.

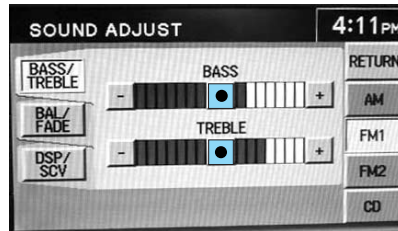

**Fade** : Allows you to adjust the amount of sound emitted from the front and rear speakers.

**Balance** : Allows you to adjust the sound distribution between the right and left speakers.

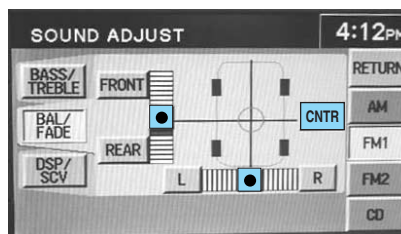

**SCV (Speed Compensated Volume)**: Automatically compensates for road wind and noise. Refer to *Speed compensated volume* earlier in this chapter.

**DSP Occupancy mode**: Use to optimize the sound based upon the occupants in the vehicle. Select from ALL SEATS, REAR SEATS or DRIVER SEAT.

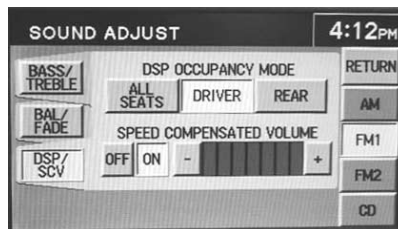

### Setting memory preset stations

The radio is equipped with six station memory preset controls. These controls can be used to select up to six preset AM stations and twelve FM stations (six in FM1 and six in FM2).

1. Select the frequency band with the AM/FM1/FM2 touch controls.
2. Select a station.
3. Press and hold a memory preset until the sound returns. The frequency will appear in the preset.

42

## Entertainment Systems

### Satellite ready capability

Your Lincoln navigation system comes equipped with Satellite ready capability. The kit to enable Satellite reception is available through your Lincoln dealer. Detailed Satellite instructions are included with the dealer installed kit.

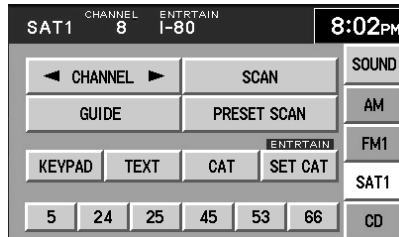

### CD mode

**CD units are designed to play commercially pressed 12 cm (4.75 in) audio compact discs only. Due to technical incompatibility, certain recordable and re-recordable compact discs may not function correctly when used in Ford CD players. Irregular shaped CDs, CDs with a scratch protection film attached, and CDs with homemade paper (adhesive) labels should not be inserted into the CD player. The label may peel and cause the CD to become jammed. It is recommended that homemade CDs be identified with permanent felt tip marker rather than adhesive labels. Ball point pens may damage CDs. Please contact your dealer for further information.**

#### Playing a previously loaded CD:

To begin CD play (if a CD is already loaded), press AUDIO hard button and then CD.

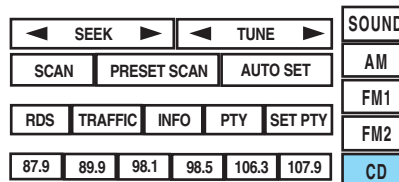

## Entertainment Systems

Press CD. CD play will begin where it stopped last.

### Loading a CD:

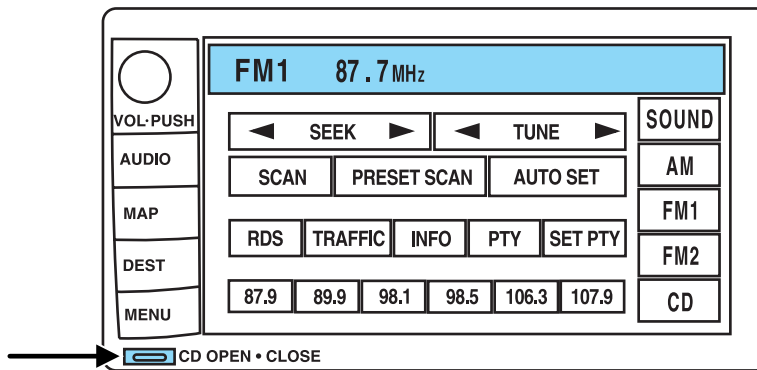
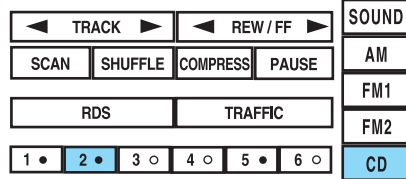

1. Press CD OPEN CLOSE on the bezel.

## Entertainment Systems

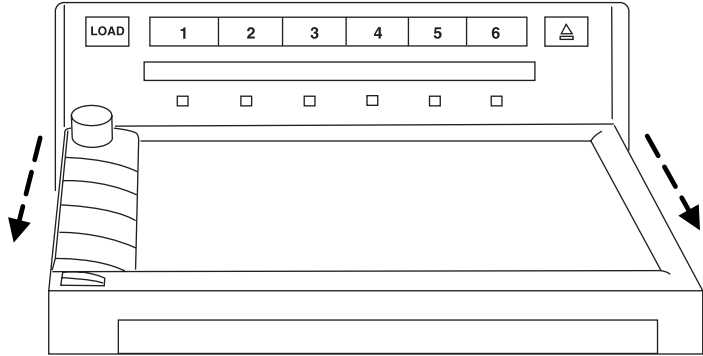

2. The navigation screen will fold down, allowing you access to the in-dash six CD system.
3. Press LOAD and the desired CD slot number. The indicator light will blink slowly at first, then quickly, signaling the system is ready.
4. Insert a disc.
5. **To load more than one disc**, press and hold LOAD. This will initiate autoload and will allow you to load all open CD slots. After an allotted time, the screen will close automatically or you may press CD OPEN CLOSE on the bezel again.
6. Once the screen closes, the system will start playing the last CD loaded.

### **Track**

Press **▶ / ◀** to advance to the next/previous track.

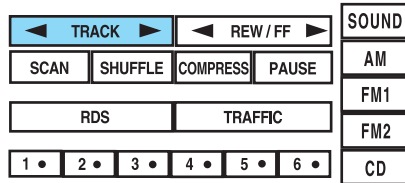

## Entertainment Systems

### Rewind/fast forward in CD mode

Press to reverse or advance (◀ / ▶) in the current CD track.

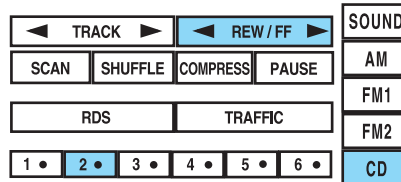

### Scan feature in CD mode

Press SCAN to hear a brief sampling of all tracks on the current CD. Press again to disengage and remain with the current track.

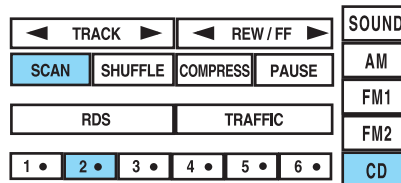

### Shuffle feature in CD mode

When in CD (or CDDJ mode), press SHUFFLE to engage the shuffle feature. Press to select from shuffling between tracks (SHUFFLE TRACK) on the current CD or between all tracks on all CDs (SHUFFLE DISC). All tracks will be played in random order. Press again to disengage (SHUFFLE OFF).

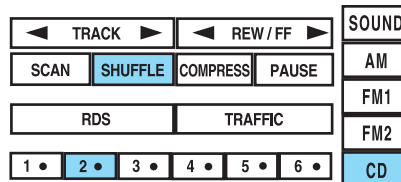

### Compression feature

The compression feature works in CD mode and boosts more quiet music and lowers louder music to minimize the need for volume adjustments.

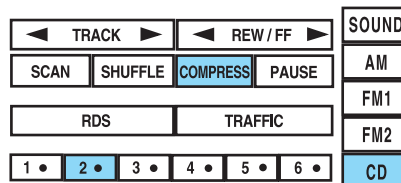

When in CD or CDDJ mode, press COMPRESS to engage or disengage the compression feature.

## Entertainment Systems

### Pause

In CD mode, press PAUSE to pause the current track. Press again to continue playing.

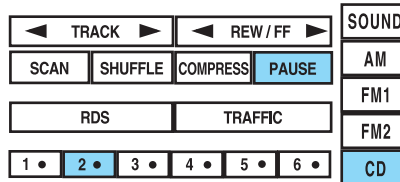

### Map mode

#### Map display information

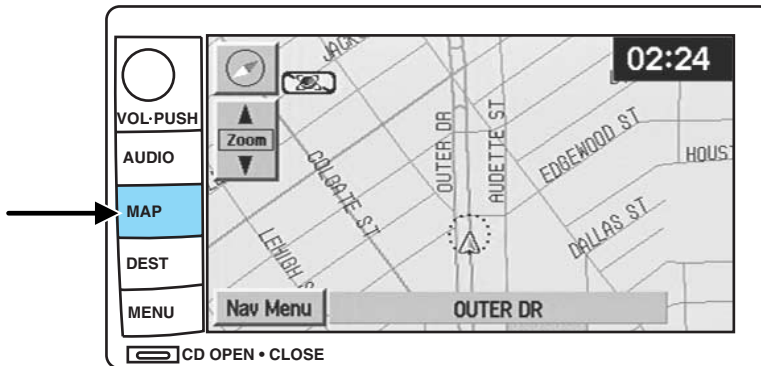

To access the map display, press MAP on the bezel.

Once pressed, the current map display will appear on the screen showing the current vehicle location.



#### Zoom control

When 'Zoom' is pressed, the scale indicator is shown on the screen. The scale markings are: 1/32, 1/16, 1/4, 1/8, 1/2, 1, 2, 4, 8, 16, 32, 64, 128 miles. The control can be used in a number of ways:

- Touch and hold one of the arrow buttons for the map to be displayed again at each zoom level.

## Entertainment Systems

- Touch one of the arrow buttons repeatedly for the map to be displayed again at the final zoom level.
- Touch one of the segments of the scale indicator for the map to be displayed at the selected zoom level.

### **Additional map function buttons**

To initiate the display of additional map function buttons, tap the map anywhere on the screen or press the MAP hard key. These additional features will disappear from the screen within five seconds unless pressed.

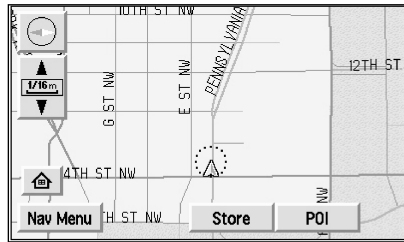

- **STORE** - stores current vehicle location as a memory point. Refer to *Memory Points* for further information.
- **POI** (Point of Interest)- brings up the Quick POI menu which allows the user to perform two functions:
  - Display POI icons on the map for one category.
  - Select local map area POIs as destinations or waypoints. The list of local area POIs can be sorted by distance, name, or icon. Refer to *Points of Interest* for further information.

If home has been previously programmed in the “Nav Menu”, the home icon (house) will appear on the screen and is able to be selected as a destination.

To delete POI icons from the map, touch the map again and press the POI off button.



## Entertainment Systems

### **Route preferences**

After entering a destination, the Route preferences will appear on the screen showing what is currently selected. You may choose to activate/deactivate selections which the system will factor in when calculating your route. Those options are:

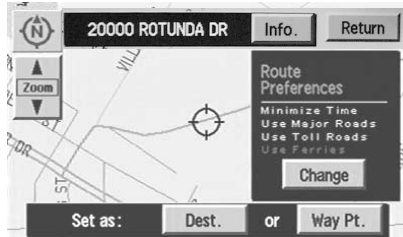

- Minimize Time/Distance
- Use Major Roads
- Use Toll Roads
- Use Ferries



### **Information function**

INFO will appear on the screen when you have calculated a destination. Press INFO for more information about the current destination, if available.

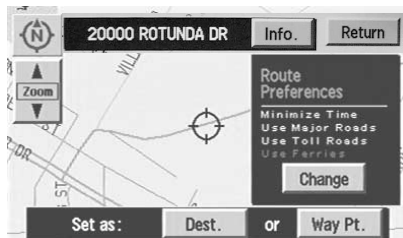

## Entertainment Systems

You will be able to view the information (if available) as well as choose to store the destination as a memory point by pressing OK.

| PREVIOUS DESTINATION  |                             | Return |
|-----------------------|-----------------------------|--------|
| Store as memory point |                             | OK     |
| Name                  | : MILITARY ST, DEARBORN, MI |        |
| Address               | : MILITARY ST               |        |
| City                  | : DEARBORN, MI              |        |

### Screen symbols

**Navigation symbol** — Indicates the current vehicle position and points to the direction in which the vehicle is currently traveling.



**Destination symbol** — Indicates the current route destination.

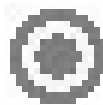

**Next turn symbol** — Shows the next maneuver that will need to be taken on the current route.



**North up button** — Indicates that the map is displayed with north to the top of the screen. Press to toggle between “North up” and “Heading up” map display states.



**Heading up button** — Indicates that the map is displayed with the vehicle heading to the top of the screen. The position of the pointer indicates the direction of north on the map. Press to toggle between “North up” and “Heading up” map display states.



## Entertainment Systems

**Avoid areas or points** — The “X” symbol indicates a point. to be avoided in route calculations.



If the avoid point is enlarged to an avoid area, it will appear on the screen as a shaded box.



**Way point symbol** — Indicates the location of a way point (locations you wish to visit in route to your ultimate destination) on the map.



**Home position symbol** — Indicates the location on the map, currently stored as the home position.



**Stored location symbol** — Indicates the location of a memory point. This is the default symbol used when the point is stored. (If desired, an icon of your own choice can be selected from the 15 icons available.) Refer to *Choosing from the icon list*.



**GPS symbol**— Indicates that insufficient GPS satellite signals are being received for accurate map positioning. The symbol is not displayed under normal operation.



**Speaker icon symbol**— Press to turn voice guidance on/off.



### **Navigation menu**

To access the Navigation Menu, press NAV MENU at the bottom of the map screen.



## Entertainment Systems

Once pressed, the Navigation Menu will display showing the following options:

- Route Options/Preferences
- Navigation Set Up
- Display Options
- Stored Locations
- On Route Scroll
- Voice Guidance/Volume



Depending upon whether or not a route is active will determine if route options/route preferences is contained on the Navigation Menu.

### **Route options (destination entered)**

Once in navigation mode and a route is currently active, press “Chng. route” to access the ROUTE OPTIONS screen. Choose from the following selections:

- **Detour:** Press to select a detour around the current route. Refer to *Detour options* later in this chapter for further information.
- **Route Preferences:** When creating a destination, select from: Minimize Time/Distance, Use Major Roads, Use Toll Roads, Use Ferries.
- **Display Whole Route:** Will enter MAP mode and display your entire chosen route.



**Note:** Route preference appears on the Nav menu when no destination is entered.



While driving under route guidance, only follow an instruction when it is safe to do so as the system cannot be aware of changing conditions. Use voice guidance as much as possible, and only view the display when driving conditions permit.

## Entertainment Systems



Ensure that you follow highway code restrictions and do not take any risks. For example, if you are unable to make a U-turn, continue on your journey. The navigation system will recalculate your route to get you back to an appropriate road to your destination.

### **Navigation set up**

The Navigation Set up screen will allow you to make adjustments to the navigation displays.

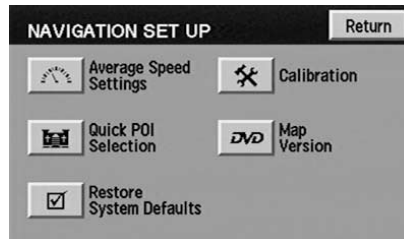

### **Average speed settings**

Allows you to set approximate speeds you drive. These speeds enable the navigation system to aid in calculating timing for routes.

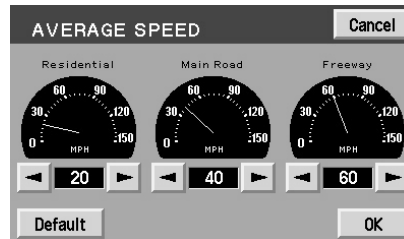

### **Quick POI (Point of Interest)**

Allows you to change the Quick POI menu settings. Select the desired Quick POI (Gas, ATM, etc.) and then press 'List Categories' for further categories, or 'Map Area POIs' to show the desired POIs on your current map.

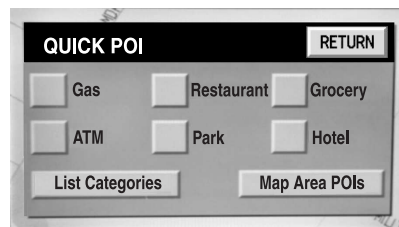

## Entertainment Systems

### **Restore system defaults**

Resets all system user-selectable options to the default (automatic) values (i.e. guidance, voice, search area and route preferences).

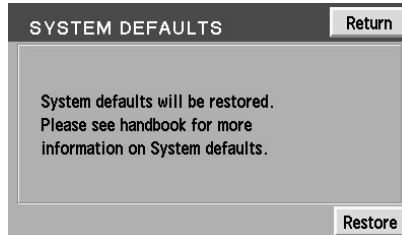

### **Calibration**

This feature is helpful if the car has been towed, or if you notice it is not registering at the correct vehicle location on the map.

Press "Position" to reposition the vehicle location. Press the screen to scroll the map to the desired location and press OK to confirm.

Press "Distance" to calibrate by distance and improve the navigation accuracy. It is recommended to activate this function after every tire replacement. When the button is highlighted, calibration is in process and will turn off automatically when complete.

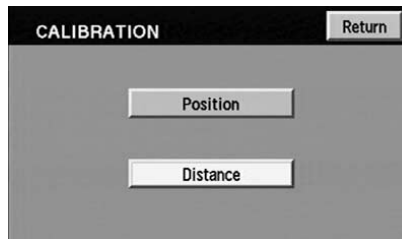

### **DVD map version**

Displays the version of the inserted navigation DVD. Refer to *Ordering additional map DVDs* for further information.

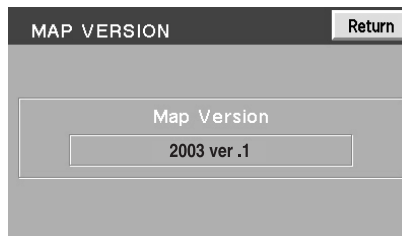

## Entertainment Systems

### Display Options

The Display Options screen will allow you make adjustments to the navigation display screen. You can choose from:

- Map Mode (Dual or Full)
- Guidance Mode (Arrows or Turn list)
- Guidance Display (On or Off)
- Time to destination (Show or Hide)

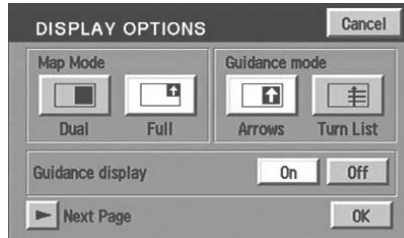

### Stored locations

The Stored locations screen will allow you to choose from destinations that have been saved into the navigation system.

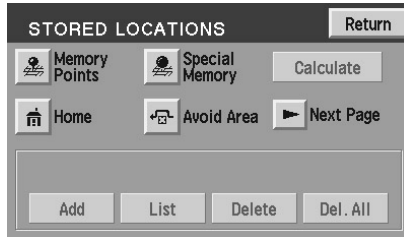

## Entertainment Systems

In this screen, you can select from Memory Points, Special Memory Points, Home, Avoid Area, Destination and Way Point, or Previous Destination. Please refer to the *Destination menu* section for a complete description of the functions.

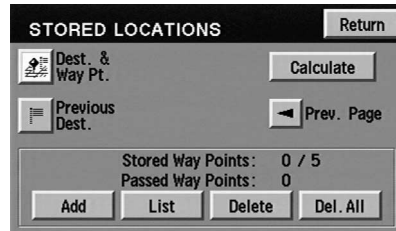

### ***On route scroll***

The system automatically scrolls through the entire planned navigation route either forwards or backwards. To activate, press the arrow buttons at the bottom left of the map screen.

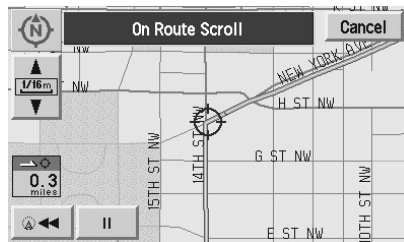

### ***Voice guidance/volume***

Allows you to turn the voice guidance option on/off and to determine the volume level of the guidance voice prompts. To adjust:



## Entertainment Systems

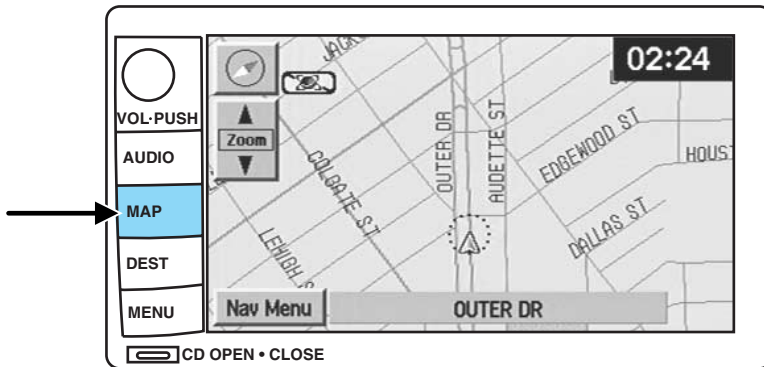

1. Press the MAP hard key.
2. Press “Nav Menu” at the bottom left hand corner of the screen.
3. Press the speaker icon to turn the voice guidance option on/off. Press the desired number to select the volume level for the voice prompts.



### Home

To set home for the first time:

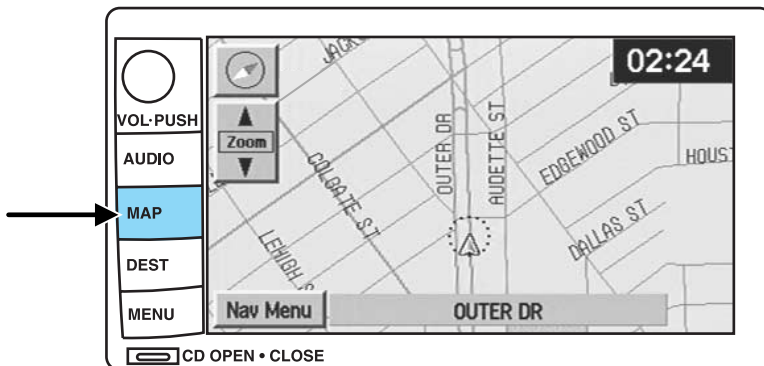

1. Press MAP.
2. Press “Nav. Menu”.

## Entertainment Systems

3. Press “Stored Locations”.



4. Press “Home”.

5. Press “Add”.



6. Select the desired menu item you wish to set as Home (Address, Memory Point, Point of Interest, Previous Destination).

7. Enter the required details.

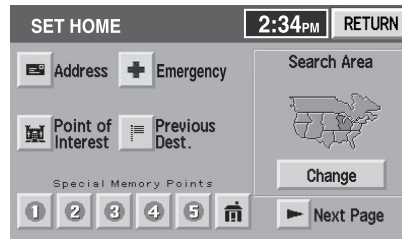

8. Press OK to set the home position.



## Entertainment Systems

To view home, press the home icon (house) on the Destination Entry screen.



**To view the set home position**

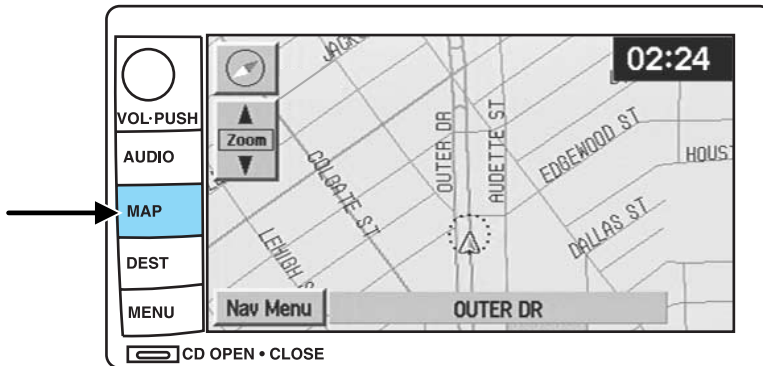

1. Press MAP.
2. Press "Nav. Menu".
3. Press "Stored Locations".



## Entertainment Systems

4. Press “Home”.
5. Press “List”.



### Deleting a home location

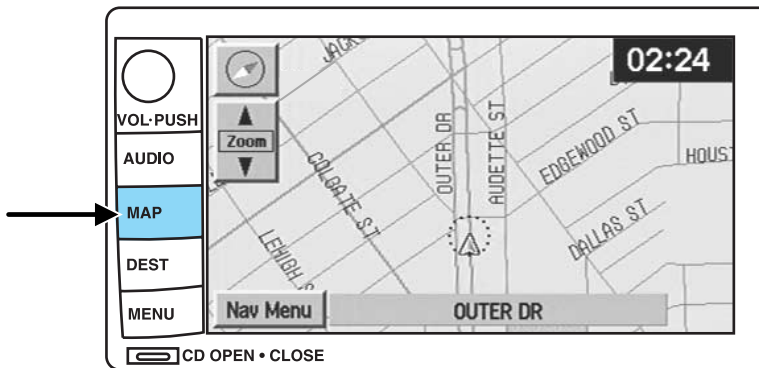

1. Press MAP.
2. Press “Nav. Menu”.
3. Press “Stored Locations”.



# Entertainment Systems

- 4. Press "Home".
- 5. Press "Delete".

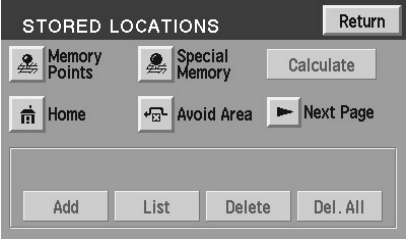

- 6. Press YES to confirm.



### Special memory points

There are five possible special memory points that you can set.

To set a memory point:

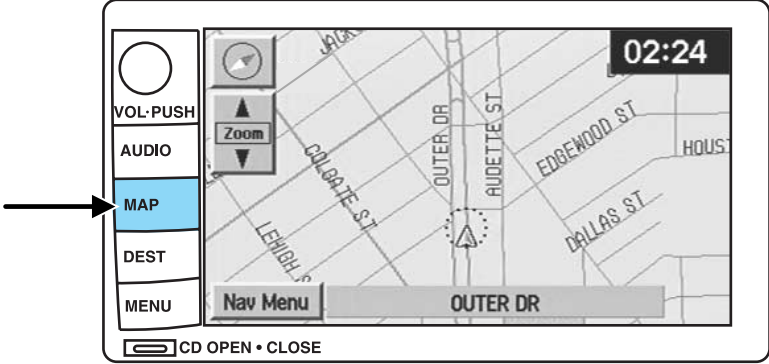

## Entertainment Systems

1. Press the MAP hard key.
2. Press “Nav. Menu”.
3. Press “Stored Locations”.



4. Press “Special Memory”.
5. Press “Add” and select a position.
6. Select point 1–5.
7. Input a destination.
8. Press OK.

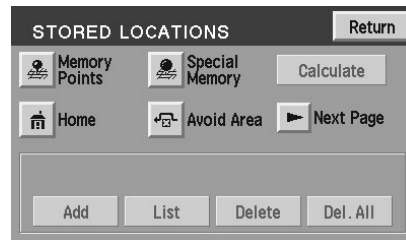

Once all five special memory points are entered, the “Add” control will read as “Full”. You must delete points before more can be added.

## Entertainment Systems

To delete a memory point:

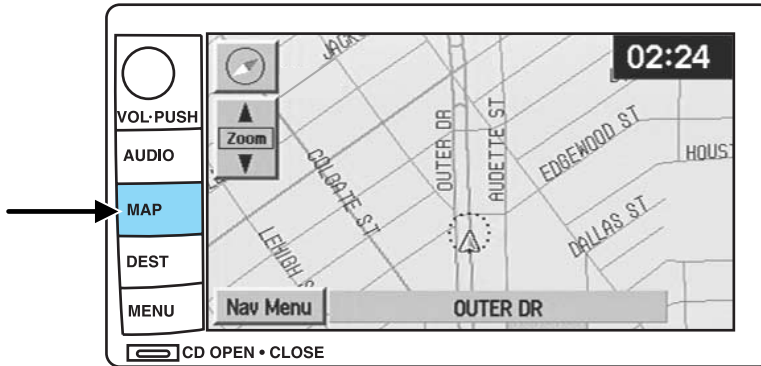

1. Press the MAP hard key.
2. Press “Nav. Menu”.
3. Press “Stored Locations”.



4. Press “Special Memory”.
5. Press “Delete”. The list will display.
6. Select the special memory point to delete.
7. Press “Del. all” to delete all entered special memory points.
8. Press “Yes” to confirm.

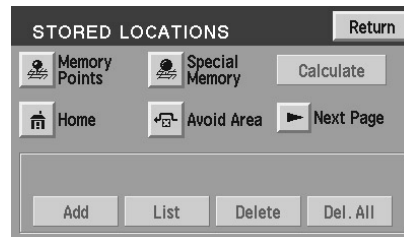

## Entertainment Systems

### **Detour options**

You may engage the detour option once a route has already been calculated by the system. To access the detour option:

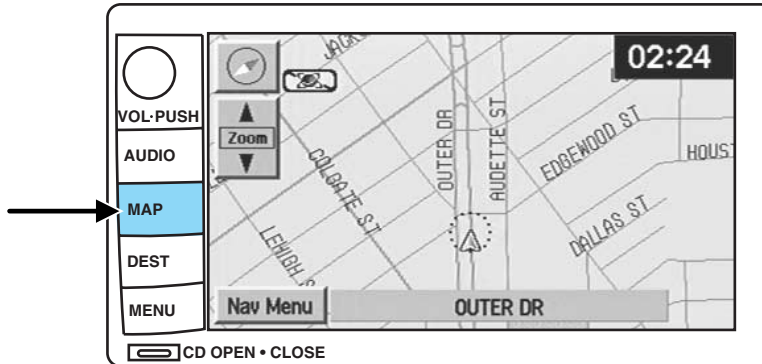

1. Press the MAP hard key
2. Press "Chg. Route".

Press DETOUR to activate. Use the soft controls to select and enter the number of miles you want to deviate off of the current road.

Press DETOUR to confirm the selection and to activate the detour around the specified areas.

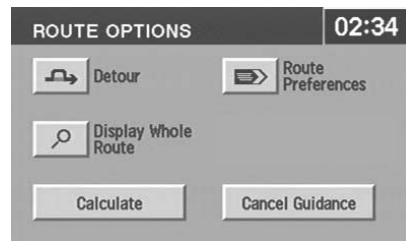



## Entertainment Systems

Press NEW ROUTE if you would like the system to plan a different route. The system may calculate an entirely new route, depending on what is available.

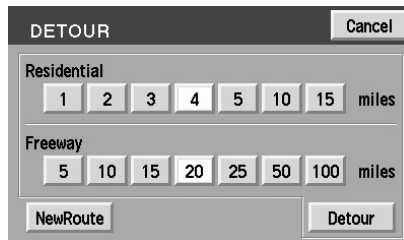

### **Route interruptions**

In the course of your destination, you may decide to temporarily leave your planned route for gas, food, etc. If you turn off the ignition, the option to continue the route guidance will be displayed when the ignition is turned on again. The route can be accessed once again after you press “Agree” on the warning screen.

### **Route alterations or cancellations**

To cancel or change your current route from the map, press DEST. You may then select from Detour, Display whole route, Route preferences, Destination Entry, Calculate or Cancel Guidance.

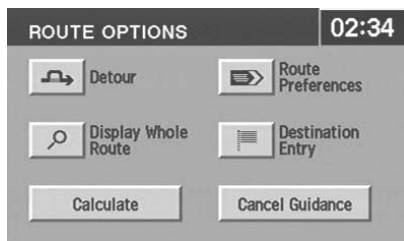

### **Avoiding an area while under guidance**

For one reason or another, you may choose to avoid a certain area while in route to your destination. To select the area to avoid:

- From the MAP screen, press Nav Menu.
- Select Route Options, then Display Whole Route
- Press Turn List

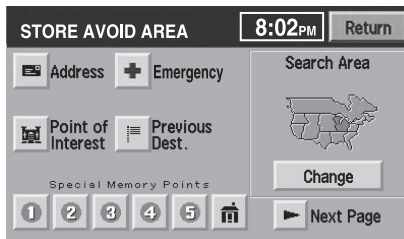

## Entertainment Systems

- Press Avoid next to the street to be avoided
- Choose OK to confirm
- Press Reroute to activate

The new area is added to the list of stored avoid areas.

**Note:** In some circumstances, it may not be possible to avoid all selected areas.

### **Listing areas to avoid**

You can list all areas noted as “avoid”.

- Press “Nav Menu”.
- Press “Stored locations”.
- Press “Avoid area”.
- Press LIST to view all previously stored selections.
- Select the desired one. The map screen will be displayed, showing the location and address of the selected area.

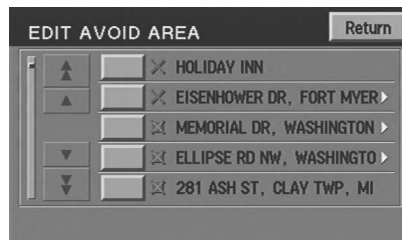

Press Enlarge or Reduce to adjust the size of the visible area. Scroll the map as required.

### **Deleting areas to avoid**

To delete a selection from the “Avoid area” list:

- From the stored locations menu, select “Avoid area”.
- Press DELETE
- Select the desired area to be deleted.
- Press DEL. ALL to delete all stored areas.
- Press YES to confirm.

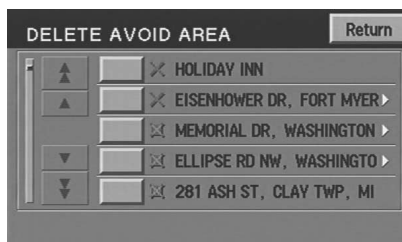

## Entertainment Systems

### Destination menu

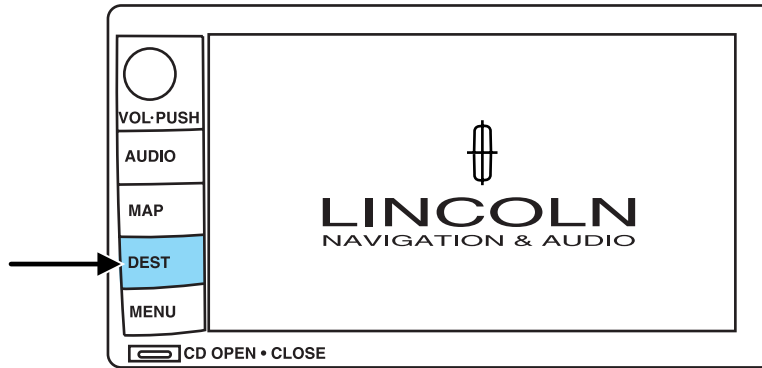

Press DEST on the main bezel to access the navigation mode.

#### **Initial map display**

After pressing AGREE to the initial WARNING screen, you will move into the initial map screen which shows the current vehicle location. Pressing the globe icon will take you to the user settings — audible feedback, navigation units, language and clock (if equipped).

**Note:** There may be a slight time delay between the soft key and the hard key functions.



## Entertainment Systems

### Route options

Once in navigation mode and a route is currently active, press the DEST hard key. The ROUTE OPTIONS screen will appear and allow you to choose from the following selections:



- **Detour** — Press to select a detour around the current route.
- **Route Preferences** — When creating a destination, select from: Minimize Time/Distance, Use Major Roads, Use Toll Roads, Use Ferries.
- **Display Whole Route:** Will enter MAP mode and display your entire chosen route.
- **Destination Entry:** Allows you to enter a new destination or select from entries in: Address book, Points of Interest or Previous Destinations.

 While driving under route guidance, only follow an instruction when it is safe to do so as the system cannot be aware of changing conditions. Use voice guidance as much as possible, and only view the display when driving conditions permit.

 Ensure that you follow highway code restrictions and do not take any risks. For example, if you are unable to make a U-turn, continue on your journey. The navigation system will recalculate your route to get you back to an appropriate road to your destination.

## Entertainment Systems

### Destination entry

#### Search area

The mapped areas covered by your map DVD are reflected in the Search Area map that is displayed on the Destination Entry screen. Your navigation system uses a regional search area. This area is the area from which navigational directions will be used.

To check your area or reset, press CHANGE under the search area listing. The map will open and allow you to select another regional area. Ensure that your search area is correct prior to setting your destination.



#### Selecting a destination

Press DEST to set a destination. From this menu, you may select from the following options:

- **Address**— Use to select a destination based on a known street address.
- **Point of Interest**— Use to select a destination that is a point of interest location (i.e., airport, restaurant, hospital).
- **Previous Destination** — Use to select a destination from among the last 20 entered destinations
- **Emergency** — Use to select the Emergency screen which will give you the location of the closest Hospital, Police Station and Dealer.

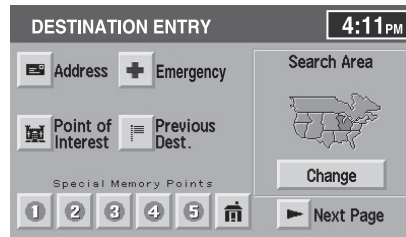

## Entertainment Systems

Press ► 'Next Page' to access more selections:

- **Memory point** — Use to select from a memory point.
- **Freeway exit/entrance** — Use to select a certain freeway exit or entrance.
- **Select from map** — Use to select a place on the map.
- **Special Memory Points** — Use to select a destination from previously stored entries.

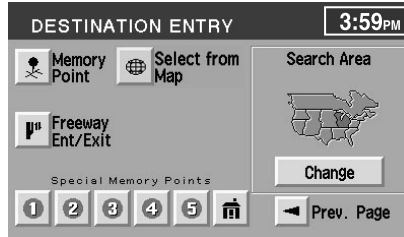

### Address

1. From the destination entry screen, select "Address".

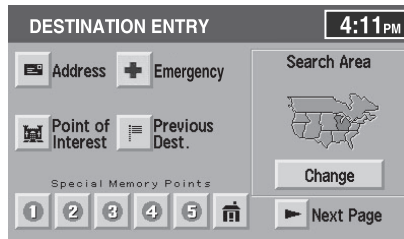

2. Input the house/building number and press OK.

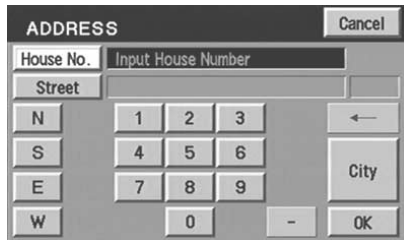

## Entertainment Systems

3. Use the keyboard to type in the street name. When you are typing the street name, the system may bring up possible roads that you can select from. Use the arrows to scroll up or down to select the desired street.

The screenshot shows the 'ADDRESS' screen with a 'Cancel' button in the top right. Below the title bar, there are two input fields: 'House No.' containing '272' and 'Street' containing 'PUL'. To the right of the 'Street' field is a numeric keypad with '57' displayed. Below these fields is a grid of letters A through X, with a left arrow button to the right of the 'H' key. To the right of the letter grid is a 'City' label and a 'List' button. At the bottom of the screen, there are buttons for 'Others' and 'Sym.'.

4. Once the address is entered, the system will pull up some possible city and state matches. If one of those is correct, select it. If not, you may press either “5 near cities” for another listing of five possible cities and states (if available). Or, press “Input City Name”.

The screenshot shows the 'ADDRESS' screen with a 'Return' button in the top right. Below the title bar, there is a list of five city and state matches, each with a small square selection box to its left: 'PIONEER VILLAGE, KY', 'PIONEER TWP, MI', 'ZEELAND, MI', 'LANSING, MI', and 'DEARBORN, MI'. At the bottom of the screen, there are two buttons: '5 near Cities' and 'Input City Name'.

5. You may use the keyboard to input the desired city.

The screenshot shows the 'ADDRESS' screen with a 'Cancel' button in the top right. Below the title bar, there are two input fields: 'City' containing 'Input City Name' and a numeric keypad containing '9668'. Below these fields is a grid of letters A through X, with a left arrow button to the right of the 'H' key. To the right of the letter grid is a 'List' button. At the bottom of the screen, there are buttons for 'Others' and 'Sym.'.

## Entertainment Systems

### **Points of interest (POI)**

Select “Point of Interest” from the Destination Entry Menu. In this next menu, you will have the following options:

- **By Name**— Enter POI name on the keyboard. Touch “List” to display the list of matching points of interest. If there are too many matches being listed, try entering the town name first.
- **By Category** — Press “Category”. Scroll down the list to select the category, then sub-category desired. Once you have selected a category, your entry of the POI will be restricted to that category.

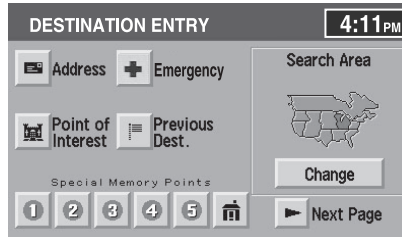

### **Previous destination**

Press “Previous Destination” on the Destination Entry Menu.

1. Select (touch) the desired item from the list of destinations previously reached. The item details will be listed.
2. Confirm destination details.





## Entertainment Systems

### Deleting stored locations

Your navigation system allows you to delete any stored locations (previous destinations, memory points, special memory points, home, avoid areas, destination and way points, etc.) To delete any of these stored locations:

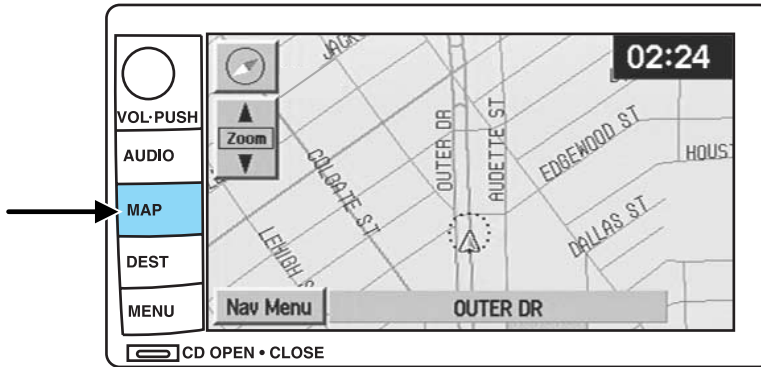

1. Press the MAP hard key.
2. Press "Nav Menu" in the bottom left hand corner of the screen.
3. Press "Stored locations".

Nav Menu



## Entertainment Systems

4. Select the desired item you wish to delete (previous destination, memory point, etc.).
5. Press “Delete” at the bottom of the screen.

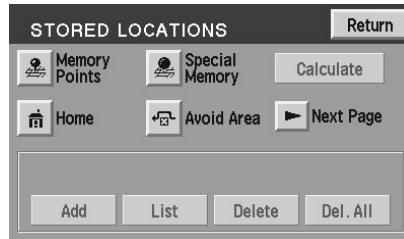

6. The list of stored locations will be displayed.
7. Select (touch) the entry to be deleted. The item details will be listed.
8. Press YES to confirm the deletion.



9. Press DELETE ALL to delete all stored locations.



### Emergency

Your navigation system is equipped with a separate Emergency screen. To access the Emergency screen, press “Emergency”.

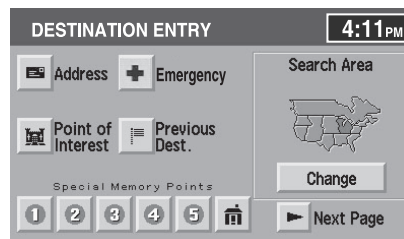

## Entertainment Systems

This screen will list the closest police station, hospital and dealer to your current location.

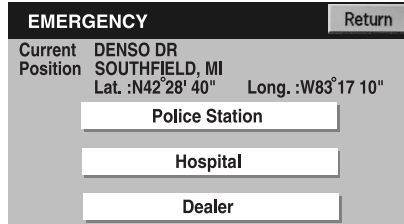

### Memory point

Your navigation system allows you to go to special destinations you may wish to again visit. To view any of these “memory points” without a route calculated:

1. Press the DEST hard control.
2. Press “▶ Next page” on the Destination Entry screen.
3. Select “Memory Point”.
4. Select the desired item.
5. Confirm the details.
6. Press “Destination” to calculate a route to that memory point.

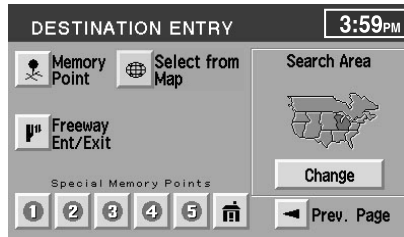

**Note:** The list can be sorted by date, name or icon by pressing the appropriate button.

### Adding a memory point

You may add more memory points to be stored in the system.

1. With the map displayed, touch your finger to the screen to scroll to the desired location. When you reach the desired location, remove your finger from the screen and the map will stop scrolling. STORE will appear on the screen.

2. Press STORE to add the location to the memory point list.

You may also add a memory point via the Navigation menu.

## Entertainment Systems

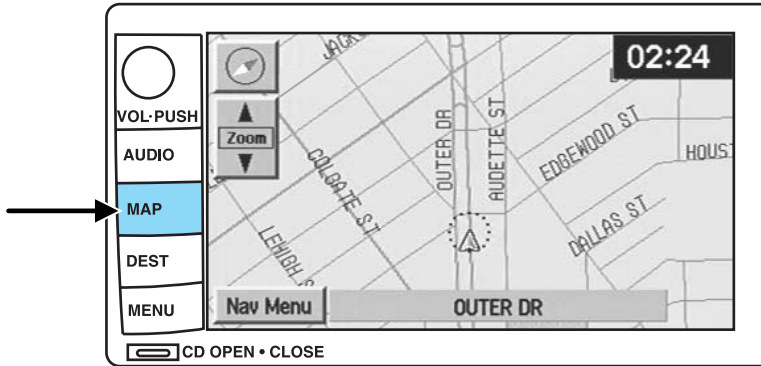

1. Press the MAP hard key.
2. Press “Nav Menu” in the bottom left hand corner of the screen.

Nav Menu

3. Press “Stored locations”.



4. Select “Memory Point”.
5. Press “Add” at the bottom of the screen.
6. Select the desired menu item.
7. Enter/select any required details. The new point will be added to the stored list of memory points.
8. Press OK. The new point will be added to the list of stored memory points.



76

## Entertainment Systems

To give the new memory point a name:

1. Select it from the list.
2. Press NAME.
3. Enter the desired name.

### **Accessing memory point lists**

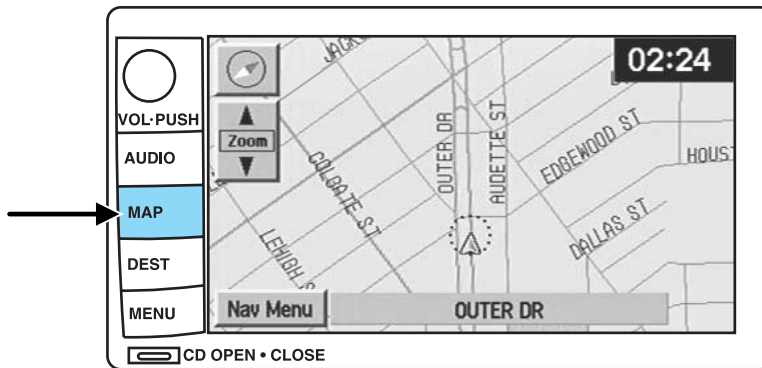

1. Press the MAP hard key.
2. Press “Nav Menu” in the bottom left hand corner of the screen.
3. Press “Stored locations”.



## Entertainment Systems

4. Press “Memory Point”.
5. Press LIST

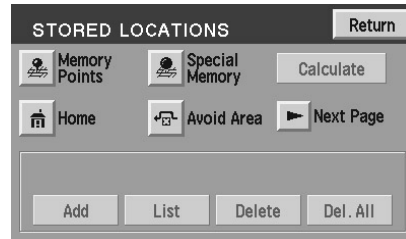

6. Select the desired entry to view its location details.

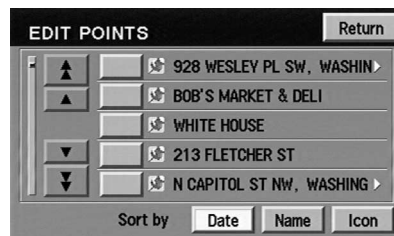

### **Sorting memory point lists**

1. Access the desired list.
2. Press the button to sort the list as desired (i.e. date, name, or icon).

When sorted by distance, the points are ordered by distance from the current vehicle location. When sorting by icon, the icons are listed in the order they appear on the icon selection screen.

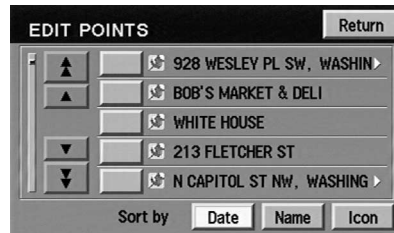

## Entertainment Systems

### **Choosing from the icon list**

After selecting a location, press ICON to edit. There will be 15 normal and three sound icons displayed. Press the icon you wish to use.

The normal icons will be displayed on the map to indicate the map location identified with that icon. The audible icon will sound a distinctive chime when the vehicle is approaching the memory point associated with that icon.

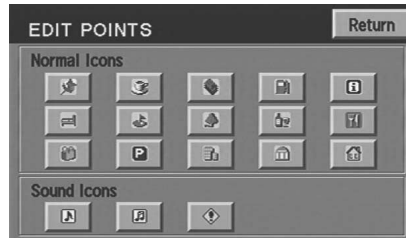

### **Deleting a memory point**

- In the Memory Point Menu, press DELETE.
- Select the entry to be deleted.
- The system will ask you to confirm deletion. Press YES to confirm.

The screen will briefly show “Memory Point Deleted”.

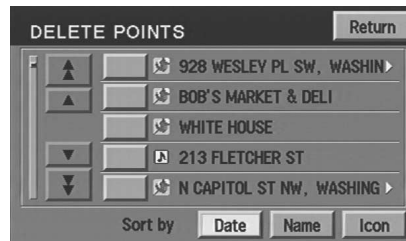

### **Deleting all memory points**

- In the Memory Point Menu, press DELETE ALL.

**Del. All**

- The system will ask you to confirm deletion. Press YES to confirm.

The screen will briefly show “All Memory Points Deleted”.

## Entertainment Systems

### Freeway Entrance/Exit

To set a freeway entrance or exit as a destination:

1. Press the DEST hard key.
2. Press “▶ Next page” to access the second page of the Destination Entry menu.
3. Select “Freeway Entrance/Exit”.

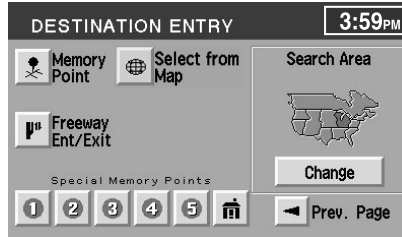

1. **Enter freeway name**— Enter the freeway name using the keyboard. Press “List” to select a freeway from those displayed.

To enter numbers in the freeway name, press “Sym”.



2. **Select entrance/exit**— Press “Entrance” if you wish to join the freeway at this junction. Press “Exit” if you wish to leave the freeway at this junction.

3. **Select Junction**— The screen will display a list of junctions on the freeway. They can be listed either by distance, (from the current vehicle location), by pressing the “Dist” button or alphabetically by pressing the “A-Z” button. Select the desired entrance or exit.

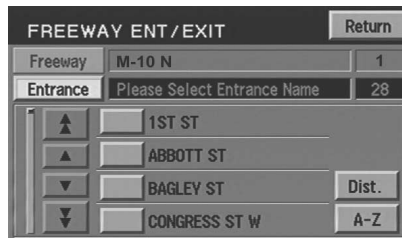

The destination details are displayed for confirmation.



## Entertainment Systems

### **Destination and way points**

The Store Dest. & Way Point menu is used after a destination or way point has been entered for the first time using the Destination Entry menu. You can store and delete destinations and way points (locations you wish to visit in route to your ultimate destination). You can also select the order in which you visit them.

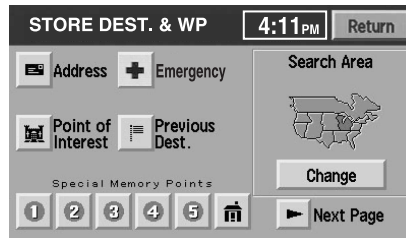

### **Adding (storing) a destination or way point**

- Once a destination is entered, press ADD to store the location. The Store Dest. & Way Point menu is displayed.
- Select whether you want to store an Address, Point of Interest or Previous Destination.
- Enter the necessary details for the selection.
- If a destination was entered, it will be stored as the current location. If a way point was entered, it will be added to the list of way points.

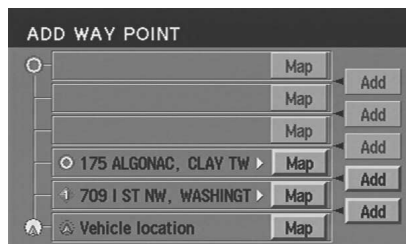

### **Listing destinations and way points**

Press LIST to display the stored way points and destination (if entered).

The first way point to be visited is at the bottom of the list and the destination is at the top.

You may view the map location of any entry. On the map, location details for the entry are displayed at the top of the screen.

To adjust the position of the way point (or destination), scroll the map as required.

Press OK.

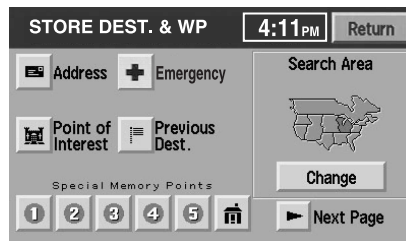

## Entertainment Systems

### **Editing and changing order of way points and destination**

Press “Chg. Order” to change the order in which the way points are visited. The points are listed chronologically from bottom up, the destination being on the top.

Press the MAP button to edit the way point location on the map display.

Press OK to confirm.



### **Deleting way points and destination**

After pressing DELETE, the list of way points and the destination (if entered) is displayed, showing the 'Delete Dest. &Way Pt.' menu.

Select the entry to be deleted. Press YES to confirm.

Press DELETE ALL to delete all way points. Press YES to confirm.



### **Selecting route criteria**

Once you have selected a destination, you may change the routing criteria by pressing “Change” in the route preferences screen. Refer to *Route preferences* for further information.

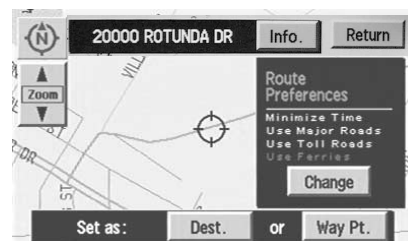

## Entertainment Systems

### **Route calculation**

Once the route criteria is selected, the navigation system automatically calculates the selected destination. The route appears on the display screen and a voice prompt provides instructions.

The system may calculate up to four routes for the desired destination. Press "Next" to scroll through the various planned routes. Press "Start" to confirm the route selection and begin route guidance.

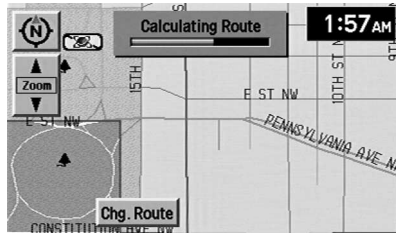

### **Next route**

Your navigation system may map more than one route to the same destination. After the destination has been calculated, it will appear on the map screen. Press NEXT in the upper right hand corner to scroll through other possible routes to the same destination.

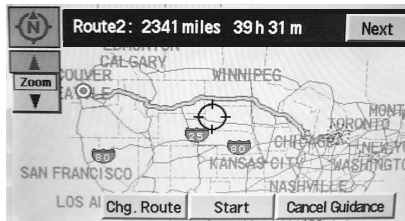

## Entertainment Systems

### Menu mode

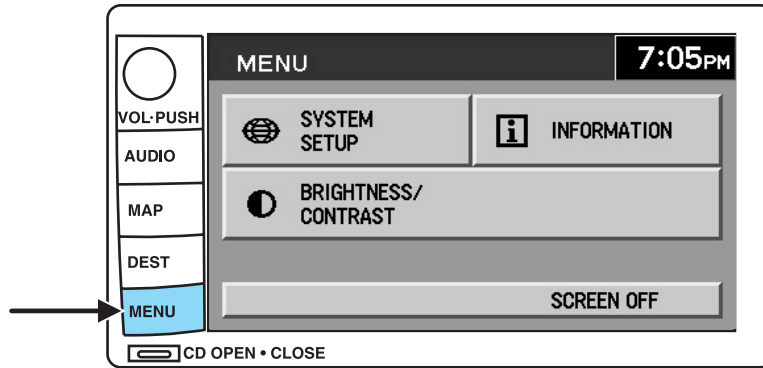

To access menu mode, press the MENU hard control.

Menu mode allows you to access:

- System Set-up
- Information — Gives you the Lincoln Customer Assistance Center information.



- Brightness/Contrast — Allows you to adjust the brightness and contrast on the screen.

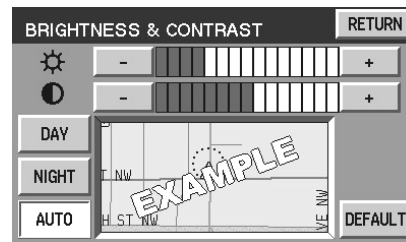

## Entertainment Systems

- Screen off — Allows you to turn off the navigation screen.

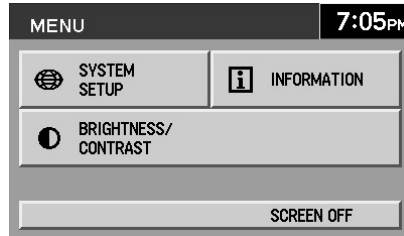

### System setup

The system set up menu contains the following user settings:

- Audible Feedback — Press to activate audible voice navigation commands. Press again to deactivate.
- Navigation Units — Press to toggle between Metric/English units.
- Language — Press to toggle between English, French, or Spanish.
- Clock

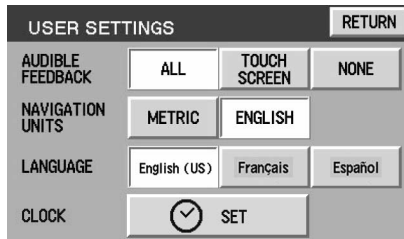

### Setting the clock

Once in Menu mode, press CLOCK to set the hours/minutes.

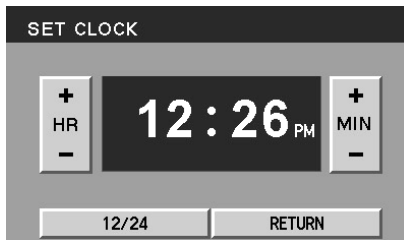

## Entertainment Systems

### General information

#### **Safety information**

**Please read and follow all stated safety precautions. Failure to do so may increase your risk of collision and personal injury. Ford Motor Company shall not be liable for any damages of any type arising from failure to follow these guidelines.**

Do not attempt to service, repair or modify the system. See your Ford or Lincoln Mercury dealer.



The driver must not attempt to operate any detailed operation of the navigation system while the vehicle is in motion. Give full attention to driving and to the road. Pull off the road and park in a safe place before performing detailed operations.

**If the system is used for an extended period of time with the vehicle stationary, ensure that the engine is running to avoid draining the battery.**

Do not apply pressure to the display screen.

The navigation system is not a substitute for your personal judgement.

Route suggestions should not supersede local traffic regulations or safe driving practices.

Do not follow route suggestions if they direct you to perform an unsafe or illegal maneuver, would place you in an unsafe situation, or would route you into an area that you consider unsafe.

Drivers should not rely on screen displays while their vehicle is in motion. Let the voice guide you. If viewing is necessary, pull off the road to a safe location.

Do not use the navigation system to locate emergency services.

For road safety reasons, the driver should program the system only when the vehicle is stationary. Certain functions will therefore not operate while the vehicle is in motion.

The map database DVD does not reflect road detours, closures or construction, road characteristics such as rough road surface, slope or grade, weight or height restrictions, traffic congestion, weather or similar conditions.

To use the system as effectively and safely as possible, obtain an up-to-date map database DVD whenever they become available.

Set the volume level so that you can hear directions clearly.

## Entertainment Systems

Do not disassemble or modify the system as this may lead to damage and void your warranty. If a problem occurs, stop using the system immediately and contact your Ford or Lincoln Dealer.

### ***Federal Communication Commission (FCC) Compliance***

Changes or modifications not approved by Ford Lincoln Mercury could void user's authority to operate the equipment. This equipment has been tested and found to comply with the limits for a Class B digital device, pursuant to Part 15 of the FCC Rules. These limits are designed to provide reasonable protection against harmful interference in a residential installation. This equipment generates, uses and can radiate radio frequency energy and, if not installed and used in accordance with the instructions, may cause harmful interference to radio communications.

However, there is no guarantee that interference will not occur in a particular installation. If this equipment does cause harmful interference to radio or television reception, which can be determined by turning the equipment off and on, the user is encouraged to consult the dealer or an experienced radio/TV technician for help.

**The database reflects reality as existing before you received the database and it comprises data and information from government and other sources, which may contain errors and omissions. Accordingly, the database may contain inaccurate or incomplete information due to the passage of time, changing circumstances, and due to the nature of the sources used. The database does not include or reflect information on neighborhood safety, law enforcement, emergency assistance, construction work, road or lane closures, vehicle or speed restrictions, road slope or grade, bridge height, weight or other limits, road or traffic conditions, special events, traffic congestion, or travel time.**

### ***Radio reception factors***

There are certain factors that may effect your radio reception.

- **Distance/strength.** The further an FM signal travels, the weaker it is. The listenable range of the average FM station is approximately 40 km (24 miles). This range can be affected by "signal modulation." Signal modulation is a process radio stations use to increase their strength/volume relative to other stations.
- **Terrain.** Hills, mountains and tall buildings between your vehicle's antenna and the radio station signal can cause FM reception problems. Static can be caused on AM stations by power lines, electric fences,

## Entertainment Systems

traffic lights and thunderstorms. Moving away from an interfering structure (out of its “shadow”) returns your reception to normal.

- **Station overload.** Weak signals are sometimes captured by stronger signals when you pass a broadcast tower. A stronger signal may temporarily overtake a weaker signal and play while the weak station frequency is displayed.

### ***Principles of GPS (global positioning system) operation***

Your system directs you based on information derived from global positioning satellites, road maps stored on the DVD, sensors in your vehicle and the desired destination. The system compiles all necessary information to guide you to your selected destination. Space satellites determine the vehicle’s current location and transmit position and time signals to your car.

If the vehicle has been parked for a long period of time, the navigation function may be temporarily unresponsive. The navigation system will operate reliably again once GPS reception is available for a few minutes.

### ***Limited GPS reception***

System performance may be adversely affected if GPS reception is interrupted or interference occurs over a distance of several miles. The following are possible causes for GPS reception being interrupted. If the vehicle is:

- in multi-story parking garages
- in tunnels and under bridges
- inside or in between buildings
- by forests or tree-lined avenues
- in heavy rain showers and thunderstorms
- in valleys and in mountainous regions
- roads under cliffs

Ensure that you do not have any metal objects on the rear parcel shelf. If your windows are tinted, ensure that you use non-metal tinting instead of metal oxide tinting. Both of these factors can interrupt GPS reception.

### ***Cleaning the display***

Do not spray cleaning fluid directly onto the unit. Instead, spray onto a soft cloth and gently wipe the unit. Only recommended products should be used.

- Recommended products- Rubbing alcohol based cleaner (i.e., methyl alcohol) or a damp clean cloth.



## Entertainment Systems

- Not harmful but not recommended- ammonia cleaner, neutral detergent.
- Harmful to system and not recommended- acid cleaner, alkali cleaner, benzene cleaner.

Do not clean any part of the system with benzene, paint thinner or any other solvent.

Do not spill liquids of any kind onto the unit.

### **Loading the map DVD**

- Your navigation DVD unit is located in the trunk.
- Ensure that the vehicle ignition is ON.
- If a DVD is already loaded in the Navigation unit, push the eject button.
- Load the DVD with the printed side up. Do not allow moisture or foreign objects to enter the slot.

The navigation system utilizes a database stored in a special format on a DVD. It is recommended always to use the latest update of this map DVD.

- The navigation system will only work with DVDs specifically intended for your navigation system.
- Always store the map DVDs in their protective cases when not in use.

### **Ordering additional map DVDs**

If you wish to order a replacement or additional map, please call 1-888-NAV-MAPS (1-888-628-6277) or to log onto [www.navtech.com](http://www.navtech.com).

### **Latest map DVDs**

The map content is constantly changing due to new roads, traffic restrictions, etc. . Therefore, it is not always possible to exactly match the DVD map with the current roadways. For best results, always use the latest version of the map DVD. Map information is regularly updated, but all areas are not necessarily covered to the same level of detail. Some areas, in particular private roads, may not be included on the database. To help with accuracy, always use the latest DVD version for navigation.

### **Customer service**

If you need help operating your navigation/audio system, want to report a map database error or want to obtain a map DVD, please call 1 (888) 628-6277 (NAV-MAPS) or log onto [www.navtech.com](http://www.navtech.com).

## Climate Controls

### DUAL ELECTRONIC AUTOMATIC TEMPERATURE CONTROL (DEATC) SYSTEM (IF EQUIPPED)

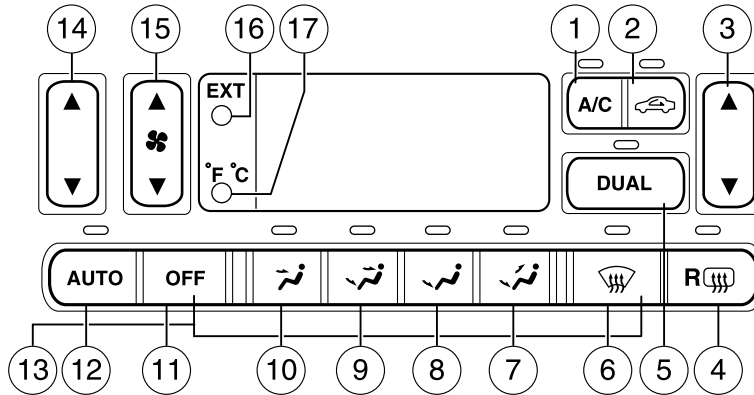

1. **A/C control:** Press to turn on and manually control the air conditioning. Press again to disengage. Press AUTO for the system to automatically control the temperature.



2. **Recirculation control:** Press to engage/disengage. Used to manually enable or disable recirculated air operation. When activated, recirculates air in the cabin thereby reducing the amount of time to cool down the interior of the vehicle. May also help reduce undesired odors from reaching the interior of the vehicle. Will work in all modes except defrost. Recirculation turns off automatically when floor, floor/defrost or defrost mode is selected. To reduce humidity inside the vehicle, turn recirculation off.



3. **Passenger side temperature control:** Press to engage the dual zone feature of the DEATC system. Allows the passenger to choose and control a different temperature than the driver, if desired.



4. **Rear defrost:** Press to defrost the rear window. Refer to *Rear window defrost* in this section for more information.





## Climate Controls

5. **DUAL** zone selector: Press to toggle the system between single zone and dual zone control.



6.  (Defrost): Distributes outside air through the windshield defroster ducts and the demister outlets. Can be used to clear ice or fog from the windshield. The system will automatically provide outside air to reduce window fogging.

7.  : Distributes air through the windshield defroster ducts, demister outlets, and the front and rear seat floor ducts. The system will automatically provide outside air to reduce window fogging.

8.  : Distributes air through the floor and rear seat floor ducts. The system will automatically provide outside air to reduce window fogging.

9.  : Distributes air through the instrument panel, center console registers, and the front and rear seat floor ducts.

10.  : Distributes air through the instrument panel and center console registers.

11. **OFF**: Outside air is shut out and the fan will not operate.



12. **Auto**: To engage automatic temperature control, press AUTO and select the desired temperature using the temperature control. The system will automatically determine fan speed, airflow location, A/C on or off, and outside or recirculated air, to heat or cool the vehicle to reach the desired temperature.



13. **Manual override controls**: Allows you to manually select where airflow is directed. To return to full automatic control, press AUTO.



14. **Driver's side temperature control**: Controls the temperature on the driver side of the vehicle in dual zone and controls the temperature of the entire vehicle in single zone.



## Climate Controls

15. **Fan Speed:** Press to manually increase/decrease fan speed. In manual mode, the display will show  with a bar graph to indicate fan speed. Fan speed can be manually adjusted in AUTO mode. To allow the system to automatically control fan speed, press AUTO.



16. **EXT control:** Press to display the outside air temperature. Press again to return to interior temperature. Exterior readings are most accurate when the vehicle is moving.



17. **Temperature conversion:** Press to toggle between Fahrenheit and Celsius temperature on the DEATC display only. The set point temperatures in Celsius will be displayed in half-degree increments.







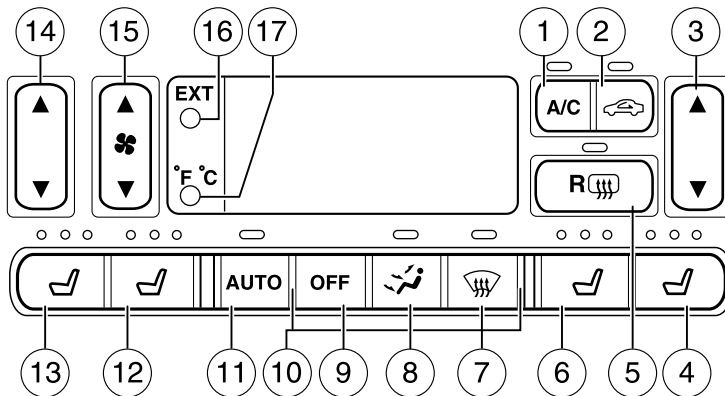

**Heated wiper rest:** Heats the windshield wiper blades in order to reduce the chance of ice buildup and to aid in defrosting. This feature operates automatically when the outside temperature is near or below freezing.

### DUAL ELECTRONIC AUTOMATIC TEMPERATURE CONTROL (DEATC) SYSTEM WITH HEATED AND COOLED SEATS (IF EQUIPPED)



## Climate Controls

1. **A/C control:** Press to turn on and manually control the air conditioning. Press again to disengage. Press AUTO for the system to automatically control the temperature. 
  2. **Recirculation control:** Press to engage/disengage. Used to manually enable or disable recirculated air operation. When activated, recirculates air in the cabin thereby reducing the amount of time to cool down the interior of the vehicle. May also help reduce undesired odors from reaching the interior of the vehicle. Will work in all modes except defrost. Recirculation turns off automatically when floor, floor/defrost or defrost mode is selected. To reduce humidity inside the vehicle, turn recirculation off. 
  3. **Passenger side temperature control:** Press to engage the dual zone feature of the DEATC system. Allows the passenger to choose and control a different temperature than the driver, if desired. 
  4. **Passenger heated seat:** Press to turn on the passenger side heated seat. Press once for full heat (three lights above passenger heated seat control will be illuminated). Press a second time to select medium heat (two lights). Press a third time to select low heat (one light). Press a fourth time to disengage the feature (all lights will be off).
  5.  (Rear defrost): Press to defrost the rear window. Refer to *Rear Window Defrost* for more information.
  6. **Passenger cooled seat:** Press to turn on the passenger side cooled seat. Press once for full cool (three lights above passenger cooled seat control will be illuminated). Press a second time to select medium cool (two lights). Press a third time to select low cool (one light). Press a fourth time to disengage the feature (all lights will be off).
- Automatic heated/cooled passenger seat:** To engage, press the passenger side heat and cool seat controls simultaneously. The center light above the passenger side heated and cooled controls will illuminate and the display will show . This allows the seat to automatically heat or cool based on the climate control temperature selected. Press either control to disengage.
7.  (Defrost): Distributes outside air through the windshield defroster ducts and the demister outlets. Can be used to clear ice or fog from the windshield. The system will automatically provide outside air to reduce window fogging.

## Climate Controls

8.  **Airflow direction control:** Press to toggle through the air distribution modes listed below. The selected mode will illuminate in the display.

 —Distributes air through the windshield defroster ducts, demister outlets and the front and rear seat floor ducts. The system will automatically provide outside air to reduce window fogging.

 : Distributes air through the floor and rear seat floor ducts. The system will automatically provide outside air to reduce window fogging.

 : Distributes air through the instrument panel, center console registers, and the front and rear seat floor ducts.

 : Distributes air through the instrument panel and center console registers.

9. **Off:** Outside air is shut out and the fan will not operate.

OFF

10. **Manual override controls:** Allows you to manually select where airflow is directed. To return to full automatic control, press AUTO.

11. **Auto:** Press to engage automatic temperature control. Use the temperature control to select the desired temperature setting. The system will automatically determine fan speed, airflow location, A/C on or off, and outside or recirculated air to heat or cool the vehicle, allowing it to reach the desired temperature. Press and hold AUTO for about two seconds to toggle between single zone and dual zone temperature control.

AUTO

12. **Driver heated seat:** Press to turn on the driver side heated seat. Press once for full heat (three lights above driver heated seat control will be illuminated). Press a second time to select medium heat (two lights). Press a third time to select low heat (one light). Press a fourth time to disengage the feature (all lights will be off).

13. **Driver cooled seat:** Press to turn on the driver side cooled seat. Press once for full cool (three lights above driver cooled seat control will be illuminated). Press a second time to select medium cool (two lights). Press a third time to select low cool (one light). Press a fourth time to disengage the feature (all lights will be off).

**Automatic heated/cooled driver seat:** To engage, press the driver side heat and cool seat controls simultaneously. The center light above the driver side heated and cooled controls will illuminate and the display will

## Climate Controls

show . This allows the seats to automatically heat or cool based on the climate control temperature selected. Press either control to disengage.

### 14. Driver's side temperature

**control:** Controls the temperature on the driver side of the vehicle in dual zone and controls the temperature of the entire vehicle in single zone.



15. **Fan Speed:** Press to manually increase/decrease fan speed. In manual mode, the display will show  with a bar graph to indicate fan speed. Fan speed can be manually adjusted in AUTO mode.

To allow the system to automatically control fan speed, press AUTO.



16. **EXT control:** Press to display the outside air temperature. Press again to return to interior

temperature. Exterior readings are most accurate when the vehicle is moving.



### 17. Temperature conversion:

Press to toggle between Fahrenheit and Celsius temperature on the DEATC display only. The set point temperatures in Celsius will be displayed in half-degree increments.



**Heated wiper rest:** Heats the windshield wiper blades in order to reduce the chance of ice buildup and to aid in defrosting. This feature operates automatically when the outside temperature is near or below freezing.

## OPERATING TIPS

- To reduce fog build up on the windshield during humid weather, place the air flow selector in the  position.
- To reduce humidity build up inside the vehicle:  
Do not drive with the air flow selector in the OFF position.  
Do not drive with recirculation engaged.
- In order to allow the vehicle to “breathe” using the outside air inlet vents, do not leave the air flow selector in the OFF position when the vehicle is parked.
- Do not put objects under the front seats that will interfere with the airflow.

## Climate Controls

- Remove any snow, ice or leaves from the air intake area at the base of the windshield.
- With the ignition in the OFF position after operating the vehicle, some vehicle sounds related to the climate control system may be heard.
- Approximately two minutes after key off, the air distribution doors may adjust their positions as part of the normal operating process.
- Demisters, located at the far left and right sides of the dash, usually blow out a small amount of airflow in order to reduce side window fogging.
- Outboard panel registers, located at the left and right sides of the dash, blow out a small amount of airflow when in Floor, Floor/Defrost, and Defrost modes. This also reduces side window fogging.
- Do not place items over the climate temperature sensor grid. This may cause improper operation of the system.

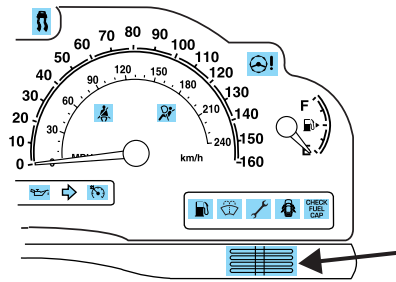

To aid in side window defogging/demisting in cold weather:

1. Select .
2. Ensure that recirculation is disengaged.
3. Set the temperature control to full heat.
4. Set the fan to the highest speed.
5. Direct the outer instrument panel vents towards the side windows.

To increase airflow to the outer instrument panel vents, close the vents located in the middle of the instrument panel.



Do not place objects on top of the instrument panel as these objects may become projectiles in a collision or sudden stop.



## Climate Controls

### REAR WINDOW DEFROSTER

Press the rear window defroster control to clear the rear window and sideview mirrors of thin ice or fog. The light above the control will illuminate to indicate that the rear defrost is operating.

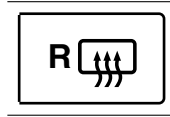

The ignition must be in the RUN position and the engine running in order to operate the rear window defroster.

The rear window defroster turns off automatically after a predetermined amount of time, if a low battery condition is detected, or if the ignition is turned to the OFF position. To manually turn off the rear window defroster at any time, press the control again.

**Do not use razor blades or other sharp objects to clean the inside of the rear window or to remove decals from the inside of the rear window. This may cause damage to the heated grid lines and will not be covered by your warranty.**

### CABIN AIR FILTER

Your vehicle is equipped with a Cabin air filter. The particulate air filtration system is designed to reduce the concentration of airborne particles such as dust, spores and pollen in the air being supplied to the interior of the vehicle. The particulate filtration system gives the following benefits to customers:

- Improves the customer's driving comfort by reducing particle concentration
- Improves the interior compartment cleanliness
- Protects the climate control components from particle deposits

The filter is located just in front of the windshield under the cowl grille on the passenger side of the vehicle.

For more information, or to replace the filter, see your Ford, Lincoln or Mercury Dealer.

## Lights

### HEADLAMP CONTROL ☼

○ Turns the lamps off.

☼ Turns on the parking lamps, instrument panel lamps, license plate lamps and tail lamps.

☼ Turns the headlamps on.

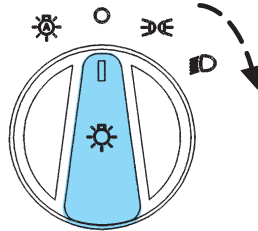

### Autolamp control ☼

The autolamp system provides light sensitive automatic on-off control of the exterior lights normally controlled by the headlamp control.

- To turn autolamps on, rotate the control counterclockwise to the auto position.
- To turn autolamps off, rotate the control clockwise to the off position (○).

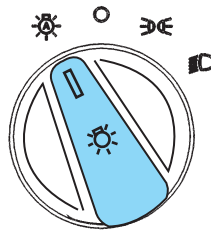

The autolamp system also keeps the lights on for a period of time after the ignition switch is turned to OFF. The period of time that the lights remain on is set at the factory but the time may be adjusted using the sequence below.

#### *Exit delay programming sequence*

1. Start with the ignition in the RUN position and autolamps selected on the headlight switch.
2. Turn the ignition to the OFF position. (This will start a 10 second timer during which steps 3 through 6 must be completed.)
3. Turn the autolamps OFF.
4. Turn the ignition to the RUN position.
5. Turn the ignition to the OFF position.
6. Turn the autolamps on (The park lamps and low beams will turn on.)
7. Turn the autolamps off after the desired delay time is reached. (The maximum programmable delay is 3 minutes. The lights that turned on in step 6 will turn off.)

## Lights

### Foglamp control (if equipped)

The foglamps can be turned on when the headlamp control is pulled toward you and is in any of the following positions:

- Parking lamps
- Low beams
- Autolamps

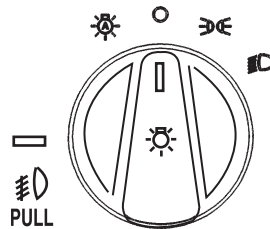

### Daytime running lamps (DRL) (if equipped)

Turns the highbeam headlamps on with a reduced output.

To activate with automatic transmission:

- the ignition must be in the RUN position;
- the headlamp control is in the OFF position, Parking lamps position, or Autolamp position when the autolamp function has not turned on the headlamps (daytime); and
- the transmission is out of Park.



Always remember to turn on your headlamps at dusk or during inclement weather. The Daytime Running Light (DRL) System does not activate your tail lamps and generally may not provide adequate lighting during these conditions. Failure to activate your headlamps under these conditions may result in a collision.

### High beams

Pull toward you until control stops to activate. Repeat to deactivate.

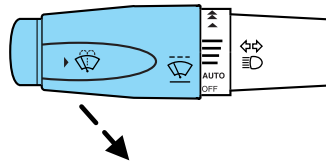

## Lights

### Flash to pass

Pull toward you slightly to activate and release to deactivate.

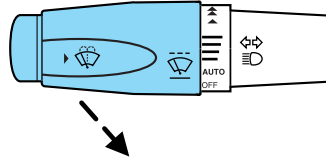

### PANEL DIMMER CONTROL

Use to adjust the brightness of the instrument panel during parklamp, headlamp and autolamp operation.

- Rotate up to brighten.
- Rotate down to dim.
- Rotate fully up to turn on the interior lights.

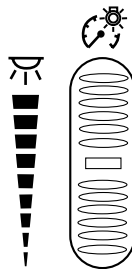

Note: The panel dimmer control is not active when the autolamp system has determined that it is daytime.

### HEADLAMP VERTICAL AIM ADJUSTMENT

Your vehicle is equipped with VOL (Visual Optical Left) headlamps.

1. Park the vehicle on a level surface approximately 7.6 meters (25 feet) from a vertical wall or screen directly in front of it.

- (1) Eight feet
- (2) VOL - subtract 50 mm (2.1 in) from the measurement of the center of the low beam lamp to the ground.
- (3) Twenty five feet

## Lights

- (4) Horizontal reference line

2. Measure the height from the center of your headlamp to the ground and mark a 2.4 meter (8 foot) horizontal reference line on the vertical wall or screen 50 mm (2.1 in) below this height (a piece of masking tape works well). The center of the lamp is marked by a 3.0 mm circle on the headlamp lens (use the low beam center mark).

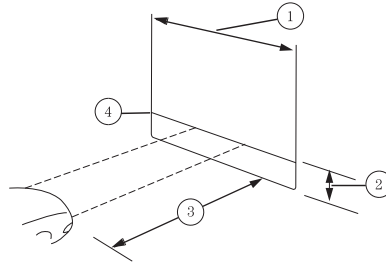

3. Turn on the low beam headlamps to illuminate the wall or screen and open the hood.

4. On the wall or screen you will observe a light pattern with flat edges at the top of the beam pattern. If the flat edges are not at the horizontal reference line, the beam will need to be adjusted. To see a clearer light pattern for adjusting, you may want to block the light from one headlamp while adjusting the other.

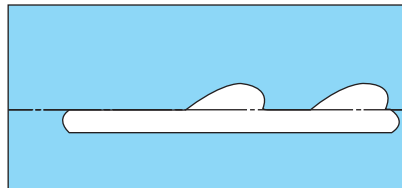

5. Locate the vertical adjuster on each headlamp, then use a 6 mm allen wrench or screwdriver to adjust the headlamp up or down.

6. HORIZONTAL AIM IS NOT REQUIRED FOR THIS VEHICLE AND IS NON-ADJUSTABLE.

7. Close the hood and turn off the lamps.

### TURN SIGNAL CONTROL ⇐⇒

- Push down to activate the left turn signal.
- Push up to activate the right turn signal.

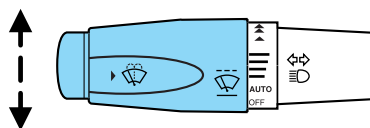

## Lights

### INTERIOR LAMPS

#### Map lamps

The map lamps and controls are located on the dome lamp. Press the controls in front of each map lamp to activate the lamps.

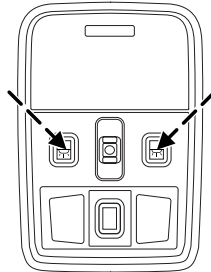

### BULBS

#### Replacing exterior bulbs

Check the operation of all the bulbs frequently.

#### Using the right bulbs

Replacement bulbs are specified in the chart below. Headlamp bulbs must be marked with an authorized "D.O.T." for North America and an "E" for Europe to assure lamp performance, light brightness and pattern and safe visibility. The correct bulbs will not damage the lamp assembly or void the lamp assembly warranty and will provide quality bulb burn time.

| Function                        | Trade Number     |
|---------------------------------|------------------|
| Headlamp low beam               | H11LL            |
| Headlamp low beam (HID)         | D2R              |
| Headlamp high beam              | 9005             |
| Park and turn lamp (front)      | 3457 A/K (amber) |
| Side marker lamp (front)        | LED*             |
| Foglamp                         | 9145             |
| Tail lamp, brakelamp, side lamp | 3157K            |
| Rear turn lamp                  | 3157 A/K (amber) |
| Backup lamp                     | 921              |
| License plate lamp              | 168              |

## Lights

| Function   | Trade Number  |
|--|---------------|
| High-mount brakelamp   | LED*          |
| Map lamp (with moon roof)                                    | 906           |
| Rail lamp (rear)   | 168           |
| Map lamp (front)   | 906           |
| Sun visor lighted mirror lamp                                | E9SB-13465-BA |
| Glove compartment  | 194           |
| Ashtray  | 194           |
| Luggage compartment lamp                                     | 212-2         |
| All replacement bulbs are clear in color except where noted. |               |
| To replace all instrument panel lights - see your dealer.    |               |

\* See your dealer or a qualified technician for LED replacement.

### Interior bulbs

Check the operation of all bulbs frequently.

### Map lamps

For bulb replacement, see a qualified service technician or your dealer.

### Replacing headlamp bulbs

The headlamp assembly contains the low beam bulb, the high beam bulb, park/turn lamp bulb and led side marker. To replace any of these items, the headlamp assembly must be removed from the vehicle as follows:

1. Make sure headlamp switch is in the OFF position, then open the hood.
2. Lift the hood and remove the upper and lower sight shields by removing the seven plastic retaining pins.
3. On the headlamp assembly, remove the three headlamp attaching bolts (8mm socket).

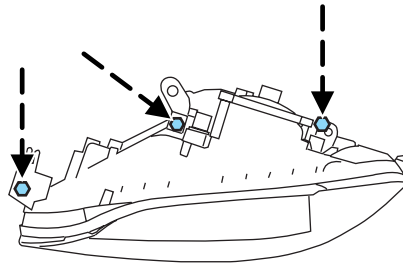

## Lights

### **Replacing headlamp bulbs - lowbeam**

1. Remove the headlamp assembly as described under *Replacing headlamp bulbs* earlier in this section.

2. Remove the four T20 torx head screws holding the bulb retaining cover on.

3. Turn the bulb counterclockwise and remove it by pulling the bulb straight out.

4. Disconnect the electrical connector.

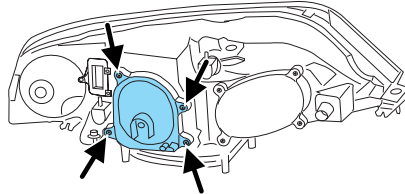

Handle a halogen headlamp bulb carefully and keep out of children's reach. Grasp the bulb only by its plastic base and do not touch the glass. The oil from your hand could cause the bulb to break the next time the headlamps are operated.

Install the new bulb in reverse order, while also replacing the seal on the bulb retaining cover. The kits for replacement seals are available at Lincoln or Ford dealers.

### **Replacing HID headlamp bulb (if equipped)**

The low beam headlamps on your vehicle use a “high intensity discharge” source. These lamps operate at a high voltage. The bulb is replaceable. When the bulb is burned out, the HID bulb must be replaced by your dealer or a qualified technician.

### **Replacing headlamp bulbs - highbeam**

1. Remove the headlamp assembly as described under *Replacing headlamp bulbs* earlier in this section.

2. Remove the four T20 torx head screws holding the bulb retaining cover on.

3. Turn the bulb counterclockwise and remove it by pulling the bulb straight out.

4. Disconnect the electrical connector.

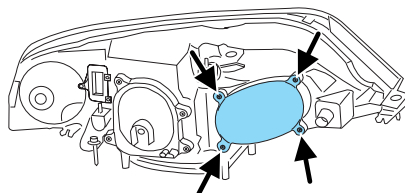



## Lights

Install the new bulb in reverse order, while also replacing the seal on the bulb retaining cover. The kits for replacement seals are available at Lincoln or Ford dealers.

### **Replacing the LED sidemarker**

1. Remove the headlamp assembly as described under *Replacing headlamp bulbs* earlier in this section.
2. Remove the three T20 torx head screws holding the bulb retaining cover on.
3. Pull the LED assembly straight out and replace with a new assembly.

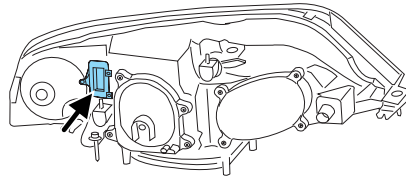

Install the new assembly in reverse order, while also replacing the seal on the bulb retaining cover. The kits for replacement seals are available at Lincoln or Ford dealers.

### **Replacing front parking lamp/turn signal lamp bulbs**

1. Remove the headlamp assembly as described under *Replacing headlamp bulbs* earlier in this section.
2. Turn the bulb counterclockwise and pull it straight out of the headlamp assembly.

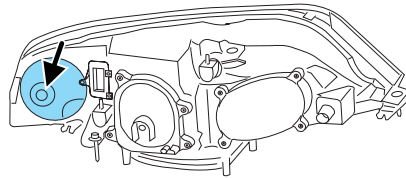

Install the new bulb in reverse order.

## Lights

### **Replacing foglamp bulbs**

1. Make sure the headlamp switch is in the OFF position and disconnect the electrical connector from the foglamp bulb.
2. Rotate the foglamp bulb counterclockwise and remove from the foglamp.

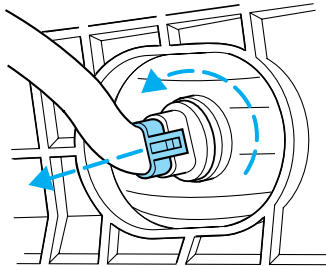

Install the new bulb in reverse order.

### **Replacing high-mount brakelamp bulbs**

Your vehicle is equipped with an LED center high-mount stop lamp. It is designed to last the life of the vehicle. If replacement is required, the entire assembly must be replaced as follows:

1. Pull down on the headliner, near the location of the high-mount stop lamp, to release the dual lock attachment.
2. Expose enough of the high-mount stop lamp to disconnect the electrical wire and remove the two retaining bolts (8 mm head).

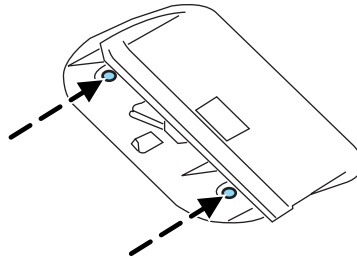

3. Remove and replace the high-mount stop lamp bulb.

Install the new stop lamp in reverse order.

### **Replacing tail lamp/backup bulbs**

For bulb replacement, see a dealer or qualified technician.

### **Replacing license plate lamp bulbs**

For bulb replacement, see a dealer or qualified technician.

## Driver Controls

### MULTI-FUNCTION LEVER

**Windshield wiper:** Rotate the end of the control away from you to increase the speed of the wipers; rotate towards you to decrease the speed of the wipers.

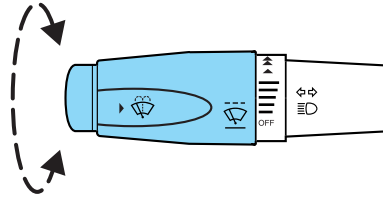

**Windshield washer:** Push the end of the stalk:

- Quickly pressing the end of the stalk switch causes a single wipe without washer fluid.
- Push and hold the end of the stalk to activate the washer. The wash cycle will continue for up to ten seconds or until released. After release, there will be three clearing wipes.

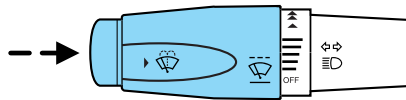

**Note:** The windshield wiper will not automatically cycle if the washer fluid is low, refer to *Windshield washer fluid* in the *Maintenance and Specifications* chapter.

### Changing the wiper blades

To replace the wiper blades:

1. Pull the passenger side wiper arm away from the windshield into the service position. Turn the blade at an angle from the wiper arm.

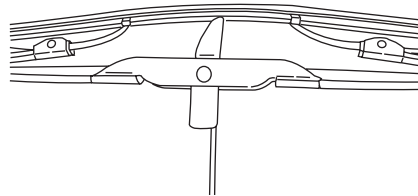

## Driver Controls

2. Firmly press the release tab from the bottom side of the wiper arm to unlock wiper blade from wiper arm.

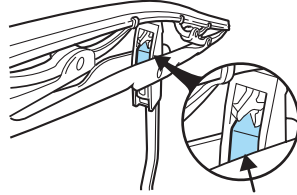

3. Pull the wiper blade down toward the windshield to remove it from the arm.

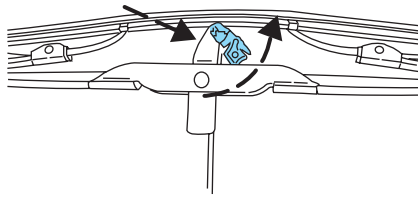

4. Attach the new wiper to the wiper arm and reposition the clip until it locks.

Repeat for driver's side wiper arm.

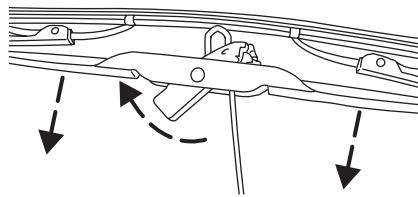

### POWER TILT/TELESCOPE STEERING COLUMN

The steering column can be adjusted manually by moving the four-way rocker adjustment control located below the turn signal/wiper control stalk. Hold the control to adjust.

The telescope function is adjusted by moving the control toward the driver to telescope out and toward the instrument panel to telescope in.

The tilt function is adjusted by moving the control up or down.

#### **Easy entry/exit feature**

When you remove the key, the column will move, if this feature is activated through the Message Center, to the full in and up position,

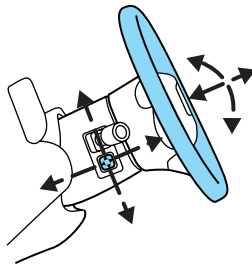

## Driver Controls

refer to the *Message Center* in the *Driver Controls* chapter. When the key is inserted into the ignition, the column will return to the previous setting.

**Note:** The easy entry/exit feature will prevent the steering wheel from returning to the memory position until the key is inserted into the ignition.

### Memory feature

The steering column positions are saved when doing a memory set function and can be recalled along with the vehicle personality features when a memory position is selected through the remote entry transmitter, keyless entry keypad or memory switch on the driver's door (if equipped with memory feature). Refer to *Memory seats/steering column/mirrors/adjustable pedals* in the *Seating and Safety Restraints* chapter.

If the steering column adjustment control is pressed during memory recall it will cancel the automatic operation and the column will respond to manual adjustment of the control.



Never adjust the steering wheel when the vehicle is moving.

### STEERING COLUMN LOCK (IF EQUIPPED)

The steering column will automatically lock when the key is removed from the ignition. When the vehicle key is inserted into the ignition, the steering column will automatically unlock.

### ILLUMINATED VISOR MIRROR

To turn on the visor mirror lamps, lift the mirror cover. Adjust the amount of light by sliding the control.

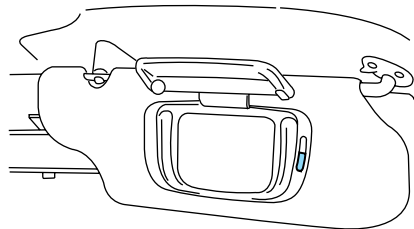

### OVERHEAD CONSOLE

The appearance of your vehicle's overhead console will vary according to your option package.

## Driver Controls

### Storage compartment

Press to open the storage compartment.

The storage compartment may be used to secure sunglasses or a similar object.

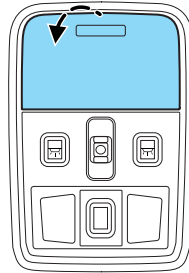

### AUXILIARY POWER POINT

**Power outlets are designed for accessory plugs only. Do not hang any type of accessory or accessory bracket from the plug. Improper use of the power outlet can cause damage not covered by your warranty.**

The auxiliary power point is located on the instrument panel next to the cigarette lighter. Push the top door to access the power point.

Do not plug optional electrical accessories into the cigarette lighter. Use the power point.

Do not use the power point for operating the cigarette lighter element.

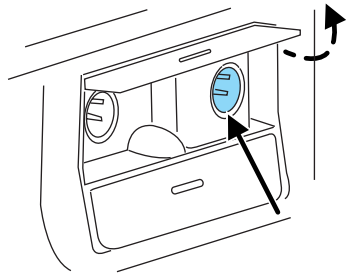

Another auxiliary power point is located in the center console, refer to the *Center Console* in this chapter for more information.

The Maximum power each power point can supply depends on the fuse rating. For example: a 20A fuse should supply a maximum of 240 Watts, a 15A fuse should supply a maximum of 180 Watts and a 10A fuse should supply a maximum of 120 Watts. Exceeding these limits will result in a blown fuse.

Always keep the power point caps closed when not being used.

## Driver Controls

### POWER WINDOWS



Do not leave children unattended in the vehicle and do not let children play with the power windows. They may seriously injure themselves.



When closing the power windows, you should verify they are free of obstructions and ensure that children and/or pets are not in the proximity of the window openings.

Press the rocker switches to open and close windows.

- Press the bottom portion of the rocker switch to open.
- Press the top portion of the rocker switch to close.

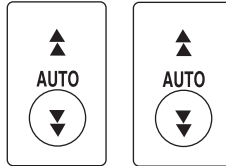

### Express Down (One Touch Down)

To make the front driver or passenger windows open fully without holding the window control, press the bottom portion of the driver window control completely down to the second detent or “Express Down” position. Press the control in either direction to stop window operation.

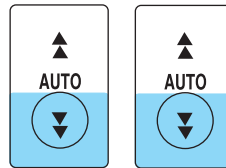

### Express Up (One Touch Up)

To make the front driver or passenger windows close fully without holding the window control, press the top portion of the driver window control completely down to the second detent or “Express Up” position. Press the control in either direction to stop window operation.

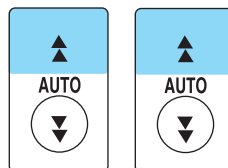

## Driver Controls



When closing the power windows, you should verify they are free of obstructions and ensure that children and/or pets are not in the proximity of the window openings.

### **Restoring the Express up functionality**

Under low battery power conditions, Express Up only functionality may be lost. To reset this function after restoring full battery power, press the rocker switch to the Express Up position, hold the switch until the glass reaches the stall position and continue to hold for 2 seconds.

### **Accessory delay**

With accessory delay, the window switches may be used for up to ten minutes after the ignition switch is turned to the OFF position or until either front door is opened.

### **Bounce Back (Front Windows Only)**

When an obstacle has been detected in the window opening as the window is moving upward, the window will automatically move down and stop at a prescribed position.

### **Bounce Back Override (Front Windows Only)**

To override Bounce Back, within 2 seconds after reaching Bounce Back position, if the rocker switch is moved from the Neutral to the Express Up position **the window will travel up with no bounce back protection**. If the switch is released before the window reaches fully closed position, the window will stop. For example: Bounce Back Override can be used to overcome the resistance of ice on the window or seals.

### **Window lock**

The window lock feature allows only the driver to operate the rear power windows.

To lock out the rear window controls press the right side of the control. Press the left side to restore the window controls.

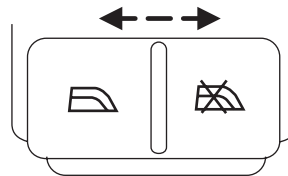

## MIRRORS

### **Automatic dimming inside rear view mirror (if equipped)**

Your vehicle is equipped with an inside rear view mirror which has an auto-dimming function. The electronic day/night mirror will change from



## Driver Controls

the clear state to the non-glare state when bright lights (glare) reach the mirror. When the mirror detects bright light from behind, it will automatically adjust (darken) to minimize glare at night only.

The mirror will automatically return to the clear state whenever the vehicle is placed in R (Reverse)(when the mirror is on).

Do not block the sensor on the backside of the mirror since this may impair proper mirror performance. (Examples: no parking stickers or hanging tags.)

Ensure the mirror is pulled down low enough to prevent visibility interference with the overhead console. The mirror support arm has two pivot points which lets you adjust the mirror UP or DOWN and from SIDE to SIDE.

### Without Navigation System

Press the control to turn the mirror on. Press the control again to turn the mirror off.

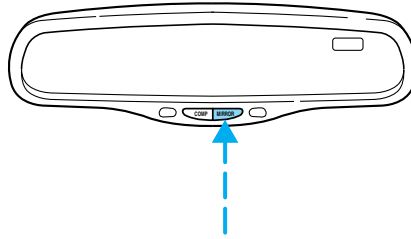

### With Navigation System

The illuminated LED to the right of the AUTO button indicates if the mirror is in the auto-dimming function. To turn the mirror off push the OFF button until the LED goes out.

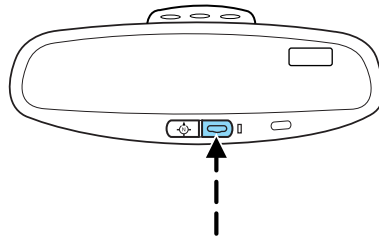

### Electronic compass (if equipped)

The compass reading will remain accurate during most driving conditions. Unknown to the driver, the compass is continuously re-calibrating due to changing magnetic fields and subtle, slow changes in vehicle magnetics which can occur over the life of the vehicle. If heading appears inaccurate re-calibrate mirror, refer to *Compass calibration adjustment*.

## Driver Controls

The compass reading will remain fixed when significant levels of magnetic interference are experienced (such as steel bridges). The compass will return to normal operation upon leaving the magnetized area.

If highly magnetized items (such as magnetic mount antennas) are placed very near the compass the display will change to "C". If a "C" is displayed, remove the source of magnetic interference and re-calibrate compass, refer to *Compass calibration adjustment*.

Most geographic areas (zones) have a magnetic north compass point that varies slightly from the northerly direction on maps. A correct zone setting will eliminate this error. Refer to *Compass zone adjustment*.

### Compass zone adjustment

1. Determine which compass zone you are in by referring to the zone map.
2. Turn the ignition to the ON/RUN position.

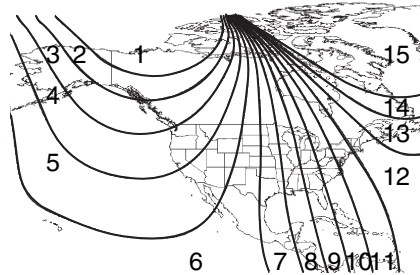

3. With the compass display turned on, press and hold the COMP side of the control for no more than six seconds until the zone selection number appears in the mirror display window. If a "C" appears repeat this step.

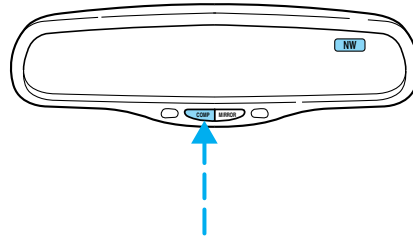

4. Release the COMP side of the control, then press it down again.
5. Repeatedly press until your zone number is shown in the mirror display, then release.
6. The display will show all segments, then return to normal compass mode within ten seconds.

### Compass calibration adjustment

Perform this adjustment in an open area free from steel structures and high voltage lines.

## Driver Controls

1. Start the vehicle.
2. Press and hold the COMP side of the control until “C” appears in the mirror display.
3. Drive the vehicle slowly (less than 5 km/h [3 mph]) in circles until the display reads a direction.
4. The compass is now calibrated.

### Power side view mirrors

To adjust your mirrors:

1. Select ◀ to adjust the left mirror or ▶ to adjust the right mirror.
2. Move the disk control in the direction you wish to tilt the mirror.
3. Return to the center position to disable the adjust function.

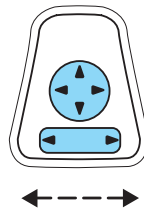

### Memory feature

The power side view mirror positions are saved when doing a memory set function and can be recalled along with the vehicle personality features when a memory position is selected through the remote entry transmitter, keyless entry keypad or memory switch on the driver's door (if equipped with memory feature). Refer to *Memory seats/steering column/mirrors/adjustable pedals* in the *Seating and Safety Restraints* chapter.

### Heated outside mirrors

Both mirrors are heated automatically to remove ice, mist and fog when the rear window defrost is activated.

**Do not remove ice from the mirrors with a scraper or attempt to readjust the mirror glass if it is frozen in place.**

**These actions could cause damage to the glass and mirrors.**

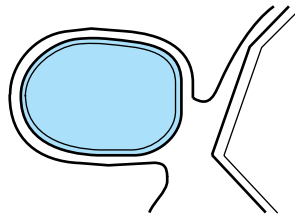

## Driver Controls

### Fold-away mirrors (if equipped)

Pull the side mirrors in carefully when driving through a narrow space, like an automatic car wash.

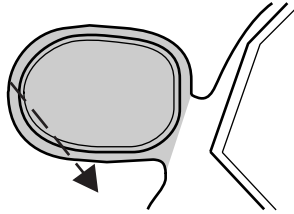

### POWER ADJUSTABLE FOOT PEDALS

The accelerator and brake pedal should only be adjusted when the vehicle is stopped and the gearshift lever is in the P (Park) position.

Press and hold the rocker control (located on the instrument panel) to adjust accelerator and brake pedal.

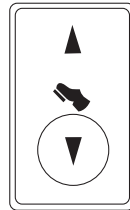

- Press the top of the control to adjust the pedals away from you.
- Press the bottom of the control to adjust the pedals towards you.

### Memory feature

The accelerator and brake pedal positions are saved when doing a memory set function and can be recalled along with the vehicle personality features when a memory position is selected through the remote entry transmitter, keyless entry keypad or memory switch on the driver's door (if equipped with memory feature). Refer to *Memory seats/steering column/mirrors/adjustable pedals* in the *Seating and Safety Restraints* chapter.



Never adjust the accelerator and brake pedal with feet on the pedals while the vehicle is moving.

### SPEED CONTROL

With speed control set, you can maintain a speed of 30 mph (48 km/h) or more without keeping your foot on the accelerator pedal. Speed control does not work at speeds below 30 mph (48 km/h).

## Driver Controls





Do not use the speed control in heavy traffic or on roads that are winding, slippery or unpaved.

### Setting speed control

The controls for using your speed control are located on the steering wheel for your convenience.

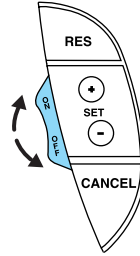
1. Press the ON control and release it.
2. Accelerate to the desired speed.



3. Press the SET + control and release it.
4. Take your foot off the accelerator pedal.
5. The indicator  light on the instrument cluster will turn on.

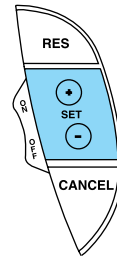

### Note:

- Vehicle speed may vary momentarily when driving up and down a steep hill.
- If the vehicle speed increases above the set speed on a downhill, you may want to apply the brakes to reduce the speed.
- If the vehicle speed decreases more than 10 mph (16 km/h) below your set speed on an uphill, your speed control will disengage.

## Driver Controls

### **Resuming a set speed**

Press the RES control and release it. This will automatically return the vehicle to the previously set speed. The RES control will not work if the vehicle speed is not faster than 30 mph (48 km/h).

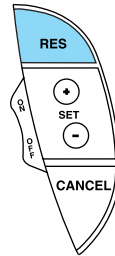

### **Increasing speed while using speed control**

There are two ways to set a higher speed:

- Press and hold the SET + control until you get to the desired speed, then release the control. You can also use the SET + control to operate the Tap-Up function. Press and release this control to increase the vehicle set speed in small amounts by 1 mph (1.6 km/h).
- Use the accelerator pedal to get to the desired speed. When the vehicle reaches that speed press and release the SET + control.

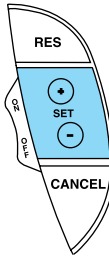

### **Reducing speed while using speed control**

There are two ways to reduce a set speed:

- Press and hold the CANCEL or SET - control until you get to the desired speed, then release the control. You can also use the CANCEL or SET - control to operate the Tap-Down function. Press and release this control to decrease the vehicle set speed in small amounts by 1 mph (1.6 km/h).

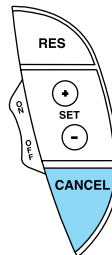

## Driver Controls

- Depress the brake pedal until the desired vehicle speed is reached, press the SET + control.

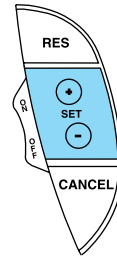

### Turning off speed control

There are two ways to turn off the speed control:

- Depress the brake pedal . This will not erase your vehicle's previously set speed.
- Press the speed control OFF control.

**Note:** When you turn off the speed control or the ignition, your speed control set speed memory is erased.

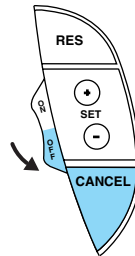

## STEERING WHEEL CONTROLS

These controls allow you to operate some audio control features.

### Audio control features

Press MEDIA to select AM, FM1, FM2, CD, or TAPE (if equipped).



## Driver Controls

### In AM, FM1, or FM2 mode:

- Press  $\Delta$  or  $\nabla$  to select preset stations within the selected radio band.

### In Tape mode:

- Press  $\Delta$  or  $\nabla$  to select the next selection on the tape.

### In CD mode:

- Press  $\Delta$  or  $\nabla$  to select the next selection on the CD.

### In any mode:

- Press VOL + or - to adjust volume.

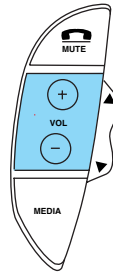
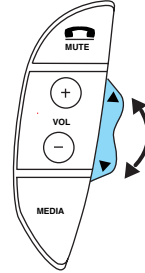

Press the PHONE/MUTE control to mute the playing media. Press again to return to the playing media.



### Navigation steering wheel controls (if equipped)

These controls allow you to operate some audio and navigation control features when the vehicle is equipped with the navigation feature.



## Driver Controls

### Audio control features

Press MEDIA to select:

- AM, FM1, FM2, or
- CD.

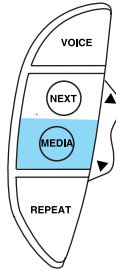

### In AM, FM1, or FM2 mode:

- Press NEXT to select preset stations within the selected radio band.

### In CD mode:

- Press NEXT to select the next selection on the CD.

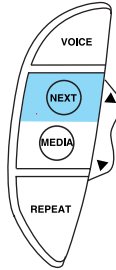

### In any mode:

- Press VOL  $\Delta$  or  $\nabla$  to adjust volume.

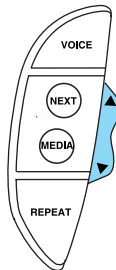

## Driver Controls

### Navigation control features

Press and hold VOICE until the voice  icon appears to use the navigation voice guidance.

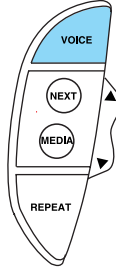

Press REPEAT control to hear previous command repeated from the navigation system.

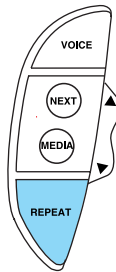

### MOON ROOF (IF EQUIPPED)

To open the moon roof:

- Push up on the control to raise the moon roof to the vent position.
- Push up on the control, while the moon roof is in the slide range, to activate the Auto-Tilt feature.
- Push the front portion of the control rearward to open the moon roof.
- Press the front portion of the control past the first detent to activate the **Auto Open** feature.

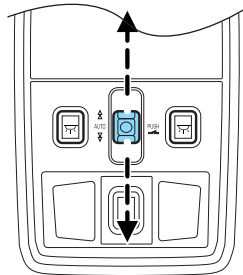

To close the moon roof:

- Press the rear portion of the control forward to close the moon roof.
- Press the rear portion of the control past the first detent to activate the **Auto close** feature.

## Driver Controls

- To close from the vent, intermediate and full open positions, push the rear portion of the control forward.



Do not let children play with the moon roof or leave children unattended in the vehicle. They may seriously hurt themselves.



When closing the moon roof, you should verify it is free of obstructions and ensure that children and/or pets are not in the proximity of the window openings.

### Bounce Back

When an obstacle has been detected in the moon roof opening as the moon roof is closing, the moon roof will automatically open and stop at a prescribed position.

#### **Bounce Back Override**

To override Bounce Back, within 2 seconds after reaching Bounce Back position, if the switch is moved from the Neutral to the auto close position **the moon roof will close with no bounce back protection.** If the switch is released before the moon roof reaches fully closed position, the moon roof will stop. For example: Bounce Back Override can be used to overcome the resistance of ice on the moon roof or seals.

### HOMELINK® WIRELESS CONTROL SYSTEM (IF EQUIPPED)

The HomeLink® Wireless Control System, located on the driver's visor, provides a convenient way to replace up to three hand-held transmitters with a single built-in device. This feature will learn the radio frequency codes of most transmitters to operate garage doors, entry gate operators, security systems, entry door locks, and home or office lighting.



When programming your HomeLink® Wireless Control System to a garage door or gate, be sure that people and objects are out of the way to prevent potential harm or damage.

Do not use the HomeLink® Wireless Control System with any garage door opener that lacks safety stop and reverse features as required by U.S. federal safety standards (this includes any garage door opener model manufactured before April 1, 1982). A garage door which cannot detect an object, signaling the door to stop and reverse, does not meet current U.S. federal safety standards. For more information, contact HomeLink® at: **www.homelink.com** or **1-800-355-3515**.

## Driver Controls

Retain the original transmitter for use in other vehicles as well as for future programming procedures (i.e. new HomeLink® equipped vehicle purchase). It is also suggested that upon the sale of the vehicle, the programmed HomeLink® buttons be erased for security purposes, refer to *Programming* in this section.

### Programming

**Do not program HomeLink® with the vehicle parked in the garage.**

**Note:** Your vehicle may require the ignition switch to be turned to the ACC position for programming and/or operation of the HomeLink®. It is also recommended that a new battery be placed in the hand-held transmitter of the device being programmed to HomeLink® for quicker training and accurate transmission of the radio-frequency signal.

1. Press and hold the two outside buttons releasing only when the red light begins to flash after 20 seconds. **Do not** repeat step one to program additional hand-held transmitters to the remaining two HomeLink® buttons. This will erase previously programmed hand-held transmitter signals into HomeLink®.

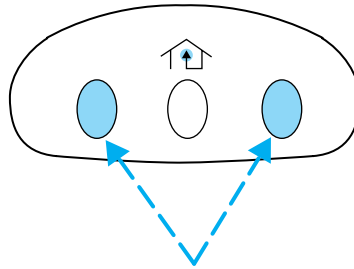

2. Position the end of your hand-held transmitter 1–3 inches (2–8 cm) away from the HomeLink® button you wish to program (located on your visor) while keeping the red light in view.

3. Simultaneously press and hold both the HomeLink® and hand-held transmitter button. **Do not release the buttons until step 4 has been completed.**

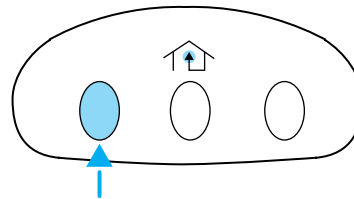

Some entry gates and garage door openers may require you to replace step 3 with procedures noted in the “Gate Operator and Canadian Programming” in this section for Canadian residents.

4. The red light will flash slowly and then rapidly. Release both buttons when the red light flashes rapidly. (The rapid flashing light indicates acceptance of the hand-held transmitters’ radio frequency signals.)

5. Press and hold the just-trained HomeLink® button and observe the red light. If the light is a constant red, programming is complete and your

## Driver Controls

device should activate when the HomeLink® button is pressed and released. **Note:** To program the remaining two HomeLink® buttons, begin with step 2 in the “Programming” section — **do not** repeat step 1.

**Note:** If the red light blinks rapidly for two seconds and then turns to a continuous red, proceed with steps 6 through 8 to complete programming of a rolling code equipped device.

6. At the garage door opener receiver (motor-head unit) in the garage, locate the “learn” or “smart” button (usually near where the hanging antenna wire is attached to the unit).

7. Press and release the “learn” or “smart” button. (The name and color of the button may vary by manufacturer.)

**Note:** There are 30 seconds in which to initiate step eight.

8. Return to the vehicle and firmly press, hold for two seconds and release the HomeLink® button. Repeat the press/hold/release sequence again, and, depending on the brand of the garage door opener (or other rolling code equipped device), repeat this sequence a third time to complete the programming.

HomeLink® should now activate your rolling code equipped device. To program additional HomeLink® buttons begin with step 2 in the “Programming” section. For questions or comments, please contact HomeLink at [www.homelink.com](http://www.homelink.com) or 1-800-355-3515.

### Gate Operator & Canadian Programming

During programming, your hand-held transmitter may automatically stop transmitting — not allowing enough time for HomeLink® to accept the signal from the hand-held transmitter.

After completing steps 1 and 2 outlined in the “Programming” section, replace step 3 with the following:

**Note:** If programming a garage door opener or gate operator, it is advised to unplug the device during the “cycling” process to prevent overheating.

- Continue to press and hold the HomeLink® button (note step 3 in the “Programming” section) while you press and release — **every two seconds** (“cycle”) your hand-held transmitter until the frequency signal has been accepted by the HomeLink®. The indicator light will flash slowly and then rapidly after HomeLink® accepts the radio frequency signal.

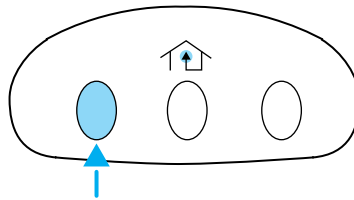

## Driver Controls

- Proceed with step 4 in the “Programming” section.

### Operating the HomeLink® Wireless Control System

To operate, simply press and release the appropriate HomeLink® button. Activation will now occur for the trained product (garage door, gate operator, security system, entry door lock, or home or office lighting etc.). For convenience, the hand-held transmitter of the device may also be used at any time. In the event that there are still programming difficulties, contact HomeLink® at [www.homelink.com](http://www.homelink.com) or **1-800-355-3515**.

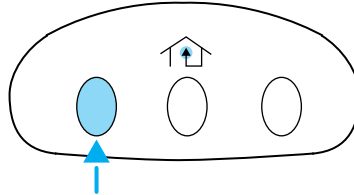

### Erasing HomeLink® buttons

To erase the three programmed buttons (individual buttons cannot be erased):

- Press and hold the two outer HomeLink® buttons until the indicator light begins to flash-after 20 seconds. Release both buttons. Do not hold for longer than 30 seconds.

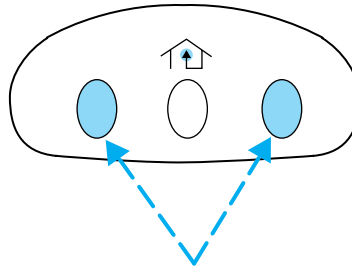

HomeLink® is now in the train (or learning) mode and can be programmed at any time beginning with step 2 in the “Programming” section.

### Reprogramming a single HomeLink® button

To program a device to HomeLink® using a HomeLink® button previously trained, follow these steps:

1. Press and hold the desired HomeLink® button. **Do NOT** release the button.
2. The indicator light will begin to flash after 20 seconds. Without releasing the HomeLink® button, follow step 2 in the “Programming” section.

For questions or comments, contact HomeLink® at [www.homelink.com](http://www.homelink.com) or **1-800-355-3515**.

### CELL PHONE USE

The use of Mobile Communications Equipment has become increasingly important in the conduct of business and personal affairs. However,

## Driver Controls

drivers must not compromise their own or others' safety when using such equipment. Mobile Communications can enhance personal safety and security when appropriately used, particularly in emergency situations. Safety must be paramount when using mobile communications equipment to avoid negating these benefits.

Mobile Communication Equipment includes, but is not limited to cellular phones, pagers, portable email devices, in vehicle communications systems, telematics devices and portable two-way radios.



A driver's first responsibility is the safe operation of the vehicle. The most important thing you can do to prevent a crash is to avoid distractions and pay attention to the road. Wait until it is safe to operate Mobile Communications Equipment.

### MESSAGE CENTER (IF EQUIPPED)

With the ignition in the RUN position, the message center, located on your instrument cluster, displays important vehicle information by monitoring vehicle systems. When you change displays, a brief indicator chime will sound. The system will also notify you of potential vehicle problems with a system warnings display followed by a long indicator chime.

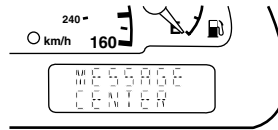

#### Operator selectable features

These features are controlled by the message center controls located above the radio.

#### **FUEL**

Press this control for the following displays:

- Distance to Empty
- Average Fuel Economy
- Display On/Off



#### **RESET**

Press this control to select and reset functions shown in the FUEL, SETUP and STATUS controls.

#### **SETUP**

Press this control for the following displays:

- Units (English/Metric)

## Driver Controls

- Autolocks
- Easy Exit Seat (if equipped)
- Autolamp Delay
- Lock Chirp (if equipped)
- Language

### **STATUS**

Selecting this function from the STATUS control causes the message center to cycle through each of the systems being monitored. For each of the monitored systems, the message center will indicate either an OK message or a warning message for four seconds.

The sequence of the status check report is as follows:

- washer fluid level
- oil life in XX%
- AC (cabin) filter XX%
- engine temperature
- brake fluid level
- charging system
- doors closed (driver and passenger side, front and rear). This message can only be reset by closing the door(s). If the RESET control is pressed, PLEASE CLOSE DOOR will be displayed.
- trunk status
- exterior lamps (front and rear turn, brake, tail and side repeater lamp (if equipped) status)
- Traction Control<sup>™</sup> or AdvanceTrac<sup>™</sup> (if equipped)

### **Message center functions**

#### ***Dist To Empty (DTE)***

Selecting this function from the FUEL control estimates approximately how far you can drive with the fuel remaining in your tank under normal driving conditions.

Remember to turn the ignition OFF when refueling to allow this feature to correctly detect the added fuel.

The DTE function will display LOW FUEL LEVEL and sound a tone for one second when you have approximately 80 km (50 miles) to empty. If you RESET this warning message, this display and tone will return within 10 minutes.





## Driver Controls

DTE is calculated using a running average fuel economy, which is based on your recent driving history of 800 km (500miles). This value is not the same as the average fuel economy display. The running average fuel economy is reinitialized to a factory default value if the battery is disconnected.

### **Fuel Econ Avg**

Select this function from the FUEL control to display your average fuel economy in liters/100 km or miles/gallon.



XXX AVERAGE  
L / 100 KM

If you calculate your average fuel economy by dividing liters of fuel used by 100 kilometers traveled (miles traveled by gallons used), your figure may be different than displayed for the following reasons:

- your vehicle was not perfectly level during fill-up
- differences in the automatic shut-off points on the fuel pumps at service stations
- variations in top-off procedure from one fill-up to another
- rounding of the displayed values to the nearest 0.1 liter (gallon)

### **Checking your highway fuel economy using the electronic message center display**

The following procedure will allow you to accurately monitor your actual highway fuel economy. Since this procedure requires the vehicle speed control system to be set to highway speeds, it must be run only on suitable roadways where long distance speed control can be safely maintained.

You may notice gradual improvement in fuel economy over the course of your vehicle's break-in period (approximately 1,600 kilometers [1,000 miles]).

1. Press the FUEL control to display miles to empty. Press again to display average fuel economy.



AVERAGE FUEL  
ECONOMY

2. Set the speed control. Refer to *Speed control* in this chapter.

3. Press the RESET control to clear the system memory.

- *Actual highway fuel economy is now displayed.* This current average measure will change as the speed control system changes the engine speed to maintain a constant vehicle speed. This is most noticeable in hilly environments.

## Driver Controls

4. Drive the vehicle at least 8 km (5 miles) with the speed control system engaged to display a stabilized average.
5. Record the highway fuel economy for future reference.

It is important to press the RESET control after setting the speed control to get accurate highway fuel economy readings.

### **Display On/Off**

Select this function from the FUEL control to turn your message center display OFF or ON.

### **Units (English/Metric)**

1. Select this function from the SETUP control for the current units to be displayed.
2. Press the RESET control to change from English to Metric.



UNITS  
< ENG > METRIC

### **Autolocks**

1. Select this function from the SETUP control for the current display mode.
2. Press the RESET control to turn the autolocks ON or OFF.



AUTO LOCKS  
< ON > OFF

### **Easy exit seat (if equipped)**

1. Select this function from the SETUP control for the current display mode.
2. Press the RESET control to turn the easy entry/exit ON or OFF.



EASY EXIT SEAT  
< ON > OFF

### **Autolamp delay**

1. Select this function from the SETUP control for the current display mode.
2. Press the RESET control to select a new Autolamp delay value.

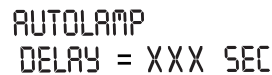

AUTOLAMP  
DELAY = XXX SEC

## Driver Controls

### **Lock chirp (if equipped)**

1. Select this function from the SETUP control for the current display mode.
2. Press the RESET control to turn the lock chirp ON or OFF.

LOCK CHIRP  
ON > OFF

### **Language**

1. Select this function from the SETUP control for the current language to be displayed.
2. Pressing the RESET control cycles the message center through each of the language choices.
3. Press and hold the RESET control to set the language choice.

ENGLISH  
RESET FOR NEW

FOR ENGLISH  
HOLD RESET

SET TO  
ENGLISH

### **System warnings**

System warnings alert you to possible problems or malfunctions in your vehicle's operating systems.

In the event of a multiple warning situation, the message center will cycle the display to show all warnings by displaying each one for 4 seconds.

The message center will display the last selected feature if there are no more warning messages. This allows you to use the full functionality of the message center after you acknowledge the warning by pressing the RESET control and clearing the warning message.

## Driver Controls

Warning messages that have been reset are divided into two categories:

- They will reappear on the display ten minutes from the reset.
- They will not reappear until an ignition OFF-RUN cycle has been completed.

This acts as a reminder that these warning conditions still exist within the vehicle.

| Warnings                     | Status                           |
|------------------------------|----------------------------------|
| Engine power reduced         | Warning cannot be reset          |
| Pull off road safely         |                                  |
| Turn off ignition            |                                  |
| Driver's door ajar           |                                  |
| Passenger door ajar          |                                  |
| Driver rear door ajar        |                                  |
| Passenger rear door ajar     |                                  |
| Park brake on & need service |                                  |
| Park brake on                |                                  |
| Check engine temp            | Warning returns after 10 minutes |
| Check charging system        |                                  |
| Transmission overheated      |                                  |
| Check transmission           |                                  |
| Low fuel level               |                                  |
| Check fuel cap               |                                  |
| ETC-engine failsafe mode     |                                  |

## Driver Controls

| Warnings                                | Status   |
|---|--|
| Low brake fluid level                   | Warning returns after the ignition key is turned from OFF to RUN |
| Check tail lamps                        |  |
| Check brake lamps                       |  |
| Check front turn lamps                  |  |
| Check side repeater lamps (if equipped) |  |
| Check rear turn lamps                   |  |
| Check Traction Control                  |  |
| Check AdvanceTrac (if equipped)         |  |
| Trunk ajar                              |  |
| Low washer fluid                        |  |
| Check AC (cabin) filter                 |  |
| Change oil soon                         |  |
| Oil change required                     |  |
| Service park brake                      |  |
| Apply park brake                        |  |
| Foot on brake                           |  |
| Data error                              |  |

**ENGINE POWER REDUCED.** Displayed when the engine is overheating. Stop the vehicle as soon as safely possible and turn off the engine. If this warning stays on, contact your dealer as soon as possible.

**PULL OFF ROAD SAFELY.** Displayed when the engine is overheating. Stop the vehicle as soon as safely possible and turn off the engine. If this warning stays on, contact your dealer as soon as possible.

**TURN OFF IGNITION.** Displayed when the engine is overheating. Turn off the engine. If this warning stays on, contact your dealer as soon as possible.

**DRIVER'S DOOR AJAR.** Displayed when the driver's door is not completely closed.

**PASSENGER DOOR AJAR.** Displayed when the passenger side door is not completely closed.

**DRIVER'S REAR DOOR AJAR.** Displayed when the driver's rear door is not completely closed.

## Driver Controls

**PASSENGER REAR DOOR AJAR.** Displayed when the passenger side rear door is not completely closed.

**PARK BRAKE ON & NEED SERVICE.** Displayed when the park brake is ON and malfunctioning. If the warning stays on or continues to come on, contact your dealer as soon as possible.

**PARK BRAKE ON.** Displayed when the park brake is ON. If the warning stays on after the park brake is off, contact your dealer as soon as possible.

**CHECK ENGINE TEMP.** Displayed when the engine coolant is overheating. Stop the vehicle as soon as safely possible, turn off the engine and let it cool. Check the coolant and coolant level. Refer to *Engine coolant* in the *Maintenance and specifications* chapter. If the warning stays on or continues to come on, contact your dealer as soon as possible.

**CHECK CHARGING SYSTEM.** Displayed when the electrical system is not maintaining proper voltage. If you are operating electrical accessories when the engine is idling at a low speed, turn off as many of the electrical loads as soon as possible. If the warning stays on or comes on when the engine is operating at normal speeds, have the electrical system checked as soon as possible.

**TRANSMISSION OVERHEATED.** Indicates the transmission is overheating. This warning may appear when driving in a low gear at a high speed for an extended period of time. Stop the vehicle as soon as safely possible, turn off the engine and let it cool. Check the transmission fluid and level. Refer to *Transmission fluid* in the *Maintenance and specifications* chapter. If the warning stays on or continues to come on, contact your dealer for transmission service as soon as possible.

**CHECK TRANSMISSION.** Indicates the transmission is not operating properly. If this warning stays on, contact your dealer as soon as possible.

**LOW FUEL LEVEL.** Displayed when you have approximately 80 km (50 miles) to empty.

**CHECK FUEL CAP.** Displayed when the fuel filler cap is not properly installed. Check the fuel filler cap for proper installation. Refer to *Fuel filler cap* in the *Maintenance and specifications* chapter.

**ETC-ENGINE FAILSAFE MODE.** Displayed when the engine has defaulted to a 'limp-home' operation. If the warning stays on or continues to come on, contact your dealer as soon as possible.

## Driver Controls

**LOW BRAKE FLUID.** Indicates the brake fluid level is low and the brake system should be inspected immediately. Refer to *Checking and adding brake fluid* in the *Maintenance and specifications* chapter.

**CHECK TAIL LAMPS.** Displayed when the tail lamps are activated and at least one is burned out. Check the lamps as soon as safely possible and have the burned out lamp replaced.

**CHECK BRAKE LAMPS.** Displayed when the brake lamps are activated and at least one is burned out. Check the lamps as soon as safely possible and have the burned out lamp replaced. The center high-mount brakelamp is not monitored.

**CHECK FRT TURN LAMPS.** Displayed when the turn signals are activated and at least one is burned out. Check the lamps as soon as safely possible and have the burned out lamp replaced.

**CHECK SIDE REPEATER LAMPS (if equipped).** Displayed when the turn signals are activated and at least one is burned out. Check the lamps as soon as possible and have the burned out lamp replaced.

**CHECK REAR TURN LAMPS.** Displayed when the turn signals are activated and at least one is burned out. Check the lamps as soon as possible and have the burned out lamp replaced.

**CHECK TRACTION CONTROL.** Displayed when the Traction Control™ system is not operating properly. If this message is displayed on the message center **and** the amber T/C OFF light in the Traction Control™ on/off switch is **not** illuminated, the Traction Control™ system will be partially operable. If this warning stays on, contact your dealer for service as soon as possible. For further information, refer to *Traction control™* in the *Driving* chapter.

**CHECK ADVANCETRAC (if equipped).** Displayed when the AdvanceTrac™ system is not operating properly. If this message is displayed on the message center the AdvanceTrac™ system will be partially operable. If this warning stays on while the engine is running, contact your dealer for service as soon as possible. For further information, refer to *AdvanceTrac™ stability enhancement system* in the *Driving* chapter.

**TRUNK AJAR.** Displayed when the trunk is not completely closed.

**LOW WASHER FLUID.** Indicates the washer fluid reservoir is less than one quarter full. Check the washer fluid level. Refer to *Checking and adding washer fluid* in the *Maintenance and specifications* chapter.

## Driver Controls

**CHECK A/C (cabin) FILTER.** Displayed when the A/C cabin filter life remaining is 5 percent or less. When A/C filter life left is between 5% and 0%, the CHANGE A/C FILTER SOON message will be displayed. When A/C filter life left reaches 0%, the A/C FILTER CHANGE REQUIRED message will be displayed.

To reset the A/C filter monitoring system to 100% after each A/C Filter change:

1. Press the STATUS control to access the System Check function, the message center will display A/C FILTER XXX% RESET FOR NEW.

A/C FILTER XX X %  
RESET FOR NEW

2. Press and hold the RESET control to set to 100%, the message center will display IF NEW FILTER HOLD RESET.

IF NEW FILTER  
HOLD RESET

3. After a successful reset, the message center will display A/C FILTER LIFE SET TO 100%.

A/C FILTER LIFE  
SET TO XX X %

**CHANGE OIL SOON/OIL CHANGE REQUIRED.** Displayed when the engine oil life remaining is 5 percent or less. When oil life left is between 5% and 0%, the CHANGE OIL SOON message will be displayed. When oil life left reaches 0%, the OIL CHANGE REQUIRED message will be displayed.

An oil change is required whenever indicated by the message center. USE ONLY RECOMMENDED ENGINE OILS.

To reset the oil monitoring system to 100% after each oil change [approximately 8,000 km (5,000 miles) or 180 days] perform the following:

1. Press the STATUS control to access the System Check function. Press RESET to reset oil %.

OIL LIFE XX X %  
RESET FOR NEW



## Driver Controls

2. Press and hold the RESET control to set to 100%.

IF NEW OIL  
HOLD RESET

3. After a successful reset, the message center will display OIL LIFE SET TO 100%.

OIL LIFE SET  
TO XX %

To reset the oil monitoring system to your personalized oil life %:

1. Press the STATUS control to access the System Check function. Press RESET to reset oil %.

OIL LIFE XX %  
RESET FOR NEW

2. Press RESET and SETUP controls at the same time to activate a service mode which will display OIL LIFE XX% RESET TO ALTER.

OIL LIFE XX%  
RESET TO ALTER

3. Press RESET until you find your personalized OIL LIFE XX%.

OIL LIFE SET  
TO XX %

**SERVICE PARK BRAKE.** Displayed when the park brake needs servicing. If the warning stays on or continues to come on, contact your dealer as soon as possible.

**APPLY PARK BRAKE.** Displayed when the park brake needs to be applied. If the warning stays on or continues to come on, contact your dealer as soon as possible.

**FOOT ON BRAKE.** Displayed when the foot brake needs to be applied. If the warning stays on or continues to come on, contact your dealer as soon as possible.

**DATA ERROR.** These messages indicate improper operation of the vehicle network communication between electronic modules.

- Fuel computer
- Engine sensor
- Gear selection

## Driver Controls

- Door sensor
- Trunk sensor
- Exterior lamps
- Traction Control<sup>™</sup> and AdvanceTrac<sup>™</sup> (if equipped)
- Memory feature

Contact your dealer as soon as possible if these messages occur on a regular basis.

### INTERIOR TRUNK CONTROL

Press the remote trunk release control on the instrument panel to open the trunk.

You can render the switch inoperable by locking the button with your master key. Do this and also lock your glove box before you give your vehicle to the valet personnel **(do not give them the master key or remote entry keyfob, only the gray valet key)**.

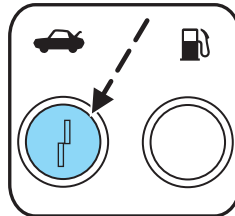

The remote trunk release control and power door locks will be disabled when the vehicle perimeter alarm system is armed. This control will not work until the vehicle perimeter alarm system is disarmed. Refer to *Perimeter Alarm System* in the *Locks and Security* chapter.

### FUEL DOOR RELEASE

Press the remote fuel door release control on the instrument panel to open the fuel door.

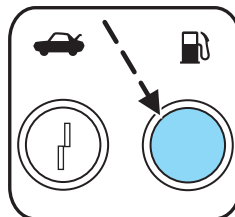

## Driver Controls

The fuel door has a manual override release located in the trunk. Pull the tab to open the fuel door.

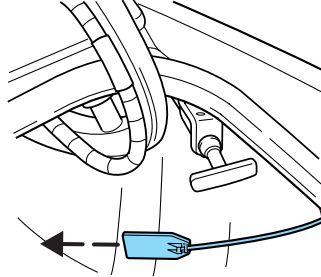

### REMOVAL/INSTALLATION OF ASHTRAY

In order to prevent damage, follow these instructions when removing/installing the ashtray.

Removal:

1. Push the ashtray face to slide open.

**Note:** Do not remove the ashtray drawer.

2. Pull the ashtray insert upward from the ashtray drawer and remove.

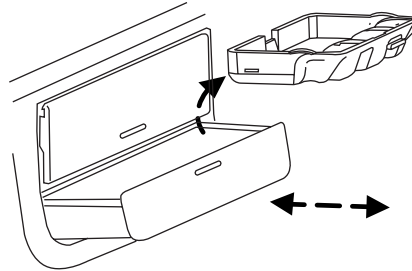

Installation:

1. Place the ashtray insert into the ashtray drawer.
2. Push the ashtray drawer in to close.

## Driver Controls

### CENTER CONSOLE

Your vehicle may be equipped with a variety of console features. These include:

1. Cupholders
2. Sliding arm rest (lift latch to slide forward or rearward)

**Note:** Slide the arm rest to the rearward position to open the utility compartment

3. Utility compartment, inside has power point (front drivers side) and coin holders (front passenger side)
4. Air vents to the rear seating positions
5. Traction control<sup>™</sup>/AdvanceTrac<sup>™</sup> (if equipped)
6. Electronic park brake

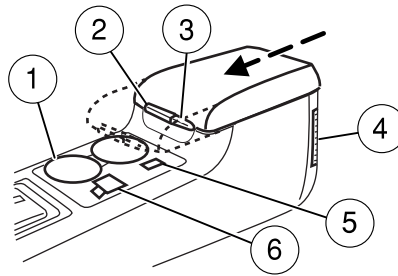

Use only soft cups in the cupholder. Hard objects can injure you in a collision.

### POSITIVE RETENTION FLOOR MAT

Position the driver floor mat so that the eyelet is over the pointed end of the retention post and rotate forward to lock in. Make sure that the mat does not interfere with the operation of the accelerator or the brake pedal. To remove the floor mat, reverse the installation procedure.

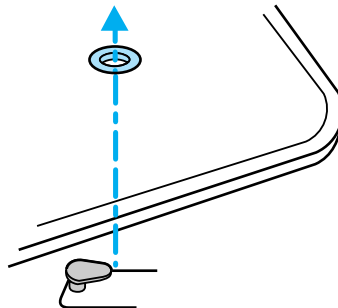

## Driver Controls

### **CARGO NET (IF EQUIPPED)**

The cargo net secures lightweight objects in the cargo area.



This net is not designed to restrain objects during a collision.

There are four straps on the net and six anchors in the trunk that can be used for securing different sized objects.

To attach the cargo net to the anchors:

- Take the bottom strap of one side of the net and push the anchor through the strap loop.
- Take the top strap of same side of the net and push the anchor through the strap loop.
- Repeat steps 1 and 2 for the other side.

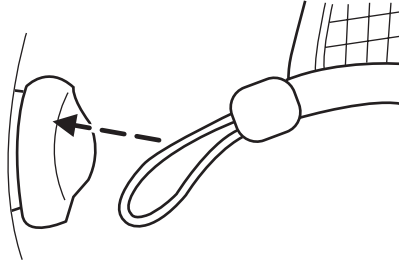

### **LUGGAGE RACK (IF EQUIPPED)**

The luggage rack is dealer installed only. See your local Lincoln Mercury dealership.

The maximum load is 75 kg (165 lb) on the luggage rack structure. The vehicle's roof panel is not designed to carry a load.

When loading the luggage rack, it is recommended to evenly distribute the load, as well as maintain a low center of gravity. Ensure that the load is securely fastened.

## Locks and Security

### KEYS

Your vehicle is equipped with two master keys and a valet key lock system. The master key will access the driver's door, trunk, glove box, remote trunk release control and ignition. The valet key will access door and ignition only.

Refer to the *Securilock™ Passive Anti-Theft System* section for information on Securilock™ keys.

### POWER DOOR LOCKS

Press the top of the control to unlock all doors and the bottom to lock all doors.

When the vehicle's security system is armed, the power door locks and remote trunk release control are disabled; these features will not work until the security system is disarmed.

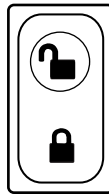

### Smart locks

With the key in any ignition position:

- The driver's door will automatically unlock if it is locked by the driver's power lock control while the driver's door is open.
- All doors will automatically unlock if the passenger's door is locked by the passenger's power lock control while the passenger's door is open.

The vehicle may still be locked with the key in the ignition, and performing one of the following actions:

- Pressing the manual lock button on the door.
- Operating the remote entry transmitter.
- Operating the keyless entry keypad (with the driver's door closed).
- Operating the driver's door with a key.

### Opening all windows and moonroof (if equipped)

You can open the vehicle's windows and moonroof (if equipped) by using the door key or the  control on the remote entry transmitter.

Press and hold the  control on the remote entry transmitter, or turn the key toward the front of the vehicle and hold it for more than two

## Locks and Security

seconds to begin to open all the windows and moonroof. Releasing the  control on the remote entry transmitter, or returning the key to the center position will stop all motion.

**Note:** The ignition must be in the 2 (OFF) position and the accessory delay feature must not be activated in order for this feature to operate.

### ***Closing all windows and moonroof (if equipped)***

**Note:** This operation is only available using the door key in the driver door lock cylinder.

You can close the vehicle's windows and moonroof (if equipped) by using the door key.

Turn the key toward the back of the vehicle and hold it for more than two seconds to begin to close all the windows and moonroof. Releasing the key to the center position will stop all motion.

**Note:** The ignition must be in the 2 (OFF) position and the accessory delay feature must not be activated in order for this feature to operate.





The rear windows do not have bounce-back protection. If an obstruction occurs, turn the key toward the front of the vehicle and hold for more than two seconds in order to reopen all the windows and moonroof.



Before operating power windows and moonroofs, you should verify that they are free of obstructions and ensure that children and/or pets are not in the proximity of window openings.

### **Central locking/Two stage unlocking**

When unlocking the driver door with the key, turn it once toward the front of the vehicle to unlock that door only, if the two-stage unlocking is enabled. Turn the key a second time to unlock all doors. When locking, turn the key toward the back of the vehicle to lock all doors.

Two stage unlocking may be disabled and re-enabled (to allow all vehicle doors to unlock simultaneously) by simultaneously pressing the  and  controls on the remote entry transmitter for four seconds.

**Note:** The turn lamps will flash twice to confirm that a change to the feature has occurred.

## Locks and Security

### Childproof door locks

- When these locks are set, the rear doors cannot be opened from the inside.
- The rear doors can be opened from the outside when the doors are unlocked.

The childproof locks are located on the rear edge of each rear door and must be set separately for each door. **Note:** Setting the lock for one door will not automatically set the lock for both doors.

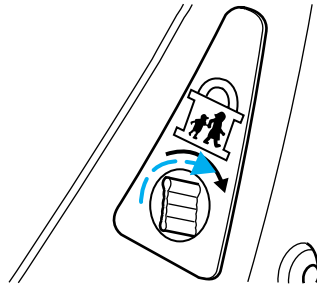

- Rotate the control in the direction of the arrow to engage the childproof lock.
- Rotate the control in the opposite direction to disengage the childproof lock.

### INTERIOR LUGGAGE COMPARTMENT RELEASE

Your vehicle is equipped with a mechanical interior luggage compartment release handle that provides a means of escape for children and adults in the event they become locked inside the luggage compartment.

Adults are advised to familiarize themselves with the operation and location of the release handle.

To open the luggage compartment door (lid) from within the luggage compartment, pull the illuminated “T” shaped handle and push up on the trunk lid. The handle is composed of a material that will glow for hours in darkness following brief exposure to ambient light.

The “T” shaped handle will be located either on the luggage compartment door (lid) or inside the luggage compartment near the tail lamps.

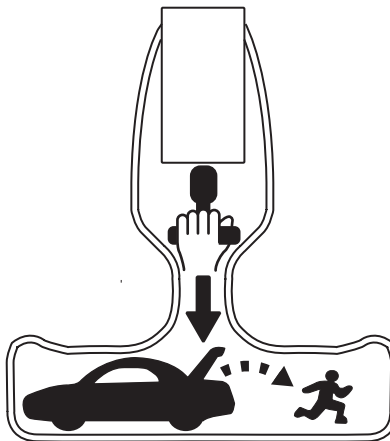



## Locks and Security



Keep vehicle doors and luggage compartment locked and keep keys and remote transmitters out of a child's reach. Unsupervised children could lock themselves in the trunk and risk injury. Children should be taught not to play in vehicles.

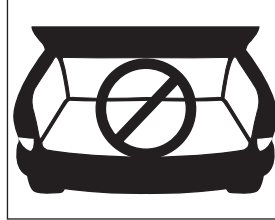

On hot days, the temperature in the trunk or vehicle interior can rise very quickly. Exposure of people or animals to these high temperatures for even a short time can cause death or serious heat-related injuries, including brain damage. Small children are particularly at risk.

### REMOTE ENTRY SYSTEM

This device complies with part 15 of the FCC rules and with RS-210 of Industry Canada. Operation is subject to the following two conditions: (1) This device may not cause harmful interference, and (2) This device must accept any interference received, including interference that may cause undesired operation.

**Changes or modifications not expressly approved by the party responsible for compliance could void the user's authority to operate the equipment.**

The typical operating range for your remote entry transmitter is approximately 33 feet (10 meters). A decrease in operating range could be caused by:

- weather conditions,
- nearby radio towers,
- structures around the vehicle, or
- other vehicles parked next to your vehicle.

The remote entry system allows you to perform the following tasks using the remote entry transmitter:

## Locks and Security

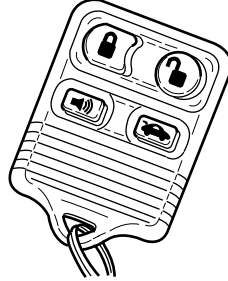

- unlock the vehicle doors.
- lock all the vehicle doors.
- open the trunk.
- activate the personal alarm.
- open all windows and moonroof (if equipped).
- arm and disarm the perimeter anti-theft system.
- operate the illuminated entry feature.
- operate the memory seat/mirror/steering column/adjustable pedals feature (if equipped).
- enable/disable the two-stage unlocking feature.



When the vehicle is armed, the interior power door lock controls and remote interior trunk release control are disabled. These features will not work until the vehicle is disarmed. Refer to *Central locking/Two-stage unlocking* information in this chapter.

If there is any potential remote keyless entry problem with your vehicle, ensure **ALL remote entry transmitters** are taken to the dealership to aid in troubleshooting.

### Unlocking the doors

1. Press  and release to:
  - unlock the driver's door only, if the two-stage unlocking feature is enabled.
  - unlock all doors, if the two-stage unlocking feature is disabled.
  - deactivate the perimeter alarm (if activated). **Note:** The interior lamps will illuminate and the turn signal lamps will display two short flashes to indicate the deactivation of the perimeter alarm. Additionally, if the memory seat/mirror/steering column/adjustable pedals feature (if equipped) is activated, the corresponding seat/mirror/steering column/adjustable pedals positions will be recalled. The memory seat/mirror/steering column/adjustable pedals feature (if equipped) will not return to the memory position until the key is inserted into the ignition when the easy entry/exit feature is activated.
2. Press  and release again within five seconds to unlock all the doors.

## Locks and Security

The remote entry system comes with an illuminated entry feature. This feature turns on the puddle lamps and the interior lamps for 20 seconds or until the ignition is turned to the 5 (START) position.

The inside lights will not turn off if:

- they have been turned on using the dimmer control or
- any door is open.

The battery saver feature will turn off the interior lamps 40 minutes after the ignition is turned to the 2 (OFF) position.

### **Opening all windows and moonroof (if equipped)**



Press  and hold for more than two seconds in order to begin opening the windows and moonroof (if equipped).

- The  control can then be released and the windows and moonroof will complete the opening operation. **Note:** If the moonroof is in the vent range, the moonroof will move to full vent.
- If any other remote entry transmitter control is pressed during the opening operation, all window and moonroof movement will stop.

**Note:** The ignition must be in the 2 (OFF) position and the accessory delay feature must be not activated in order for this feature to operate.

### **Locking the doors**

1. Press  and release to lock all the doors and arm the perimeter alarm system (also enables the ignition tamper security system).

- **Note:** With the first press of the  control, the turn signal lamps will flash once to confirm the doors, trunk and hood are closed. If any door, the trunk or the hood is open, the turn signal lamps will flash five times.
2. Press  and release again within three seconds to confirm that all the doors, trunk and hood are closed.
- **Note:** With the second press of the  control (within 3 seconds of the first), the horn will chirp once to confirm the doors, trunk and hood are closed. The horn will chirp twice if any of the doors, the trunk or the hood are not properly closed (if enabled). The horn chirp feature may be enabled/disabled by an authorized dealer or by using the message center (if equipped). Refer to *Message center* in the *Driver Controls* chapter for more information.

### **Sounding a panic alarm**

Press  on the remote transmitter to activate the alarm.

## Locks and Security

Press  a second time to deactivate the alarm. You may also deactivate the alarm in the following ways:

- Press  on the remote transmitter.
- Turn the ignition to the 4 (RUN) position.
- Wait 30 seconds for the alarm to time-out.

### Opening the trunk

Press  once to open the trunk.

- Ensure that the trunk is closed and latched before driving your vehicle. Failure to properly latch the trunk may cause objects to fall out or block the driver's rear view.

### Replacing the battery

The remote entry transmitter uses one coin type three-volt lithium battery CR2032 or equivalent.

To replace the battery:

1. Twist a thin coin between the two halves of the remote entry transmitter near the key ring. DO NOT TAKE THE RUBBER COVER AND CIRCUIT BOARD OFF THE FRONT HOUSING OF THE REMOTE ENTRY TRANSMITTER.

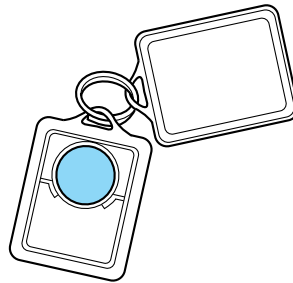

2. Do not wipe off any grease on the battery terminals on the back surface of the circuit board.

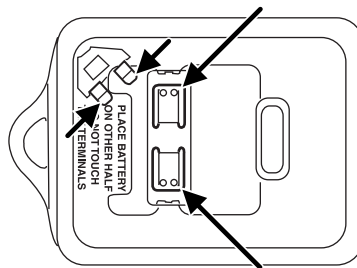

3. Remove the old battery. **Note:** Please refer to local regulations when disposing of transmitter batteries.

## Locks and Security

4. Insert the new battery. Refer to the diagram inside the remote entry transmitter for the correct orientation of the battery. Press the battery down to ensure that the battery is fully seated in the battery housing cavity.

5. Snap the two halves back together.

**Note:** Replacement of the battery will **not** cause the remote transmitter to become deprogrammed from your vehicle. The remote transmitter should operate normally after battery replacement.

### Replacing lost remote entry transmitters

If you would like to have your remote entry transmitter reprogrammed because you lost one, or would like to buy additional remote entry transmitters, you can either reprogram them yourself, or take **all remote entry transmitters** to your authorized dealer for reprogramming.

### How to reprogram your remote entry transmitters

You must have **all remote entry transmitters** (maximum of four) available before beginning this procedure.

To reprogram the remote entry transmitters:

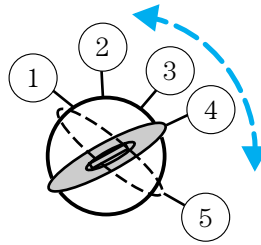

1. Ensure the vehicle is electronically unlocked.
2. Put the key in the ignition.
3. Turn the key from the 1 (LOCK) position to 4 (RUN).
4. Cycle eight times rapidly (within 10 seconds) between the 1 (LOCK) position and 4 (RUN). **Note:** The eighth turn must end in the 4 (RUN) position.
5. The doors will lock, then unlock, to confirm that the programming mode has been activated.
6. Within 20 seconds press any button on the remote entry transmitter.  
**Note:** If more than 20 seconds have passed you will need to start the procedure over again.

## Locks and Security

7. The doors will lock, then unlock, to confirm that this remote entry transmitter has been programmed.
8. Repeat Step 6 to program each additional remote entry transmitter.
9. Turn the ignition to the 1 (LOCK) position after you have finished programming all of the remote entry transmitters.
10. The doors will lock, then unlock, to confirm that the programming mode has been exited.

### **Illuminated entry**

The remote entry system comes with an illuminated entry feature. This feature turns on the interior lamps for 20 seconds or until the ignition is turned to the 5 (START) position.

The inside lights will not turn off if:

- they have been turned on using the dimmer control or
- any door is open.

The battery saver feature will turn off the interior lamps 40 minutes after the ignition is turned to the 2 (OFF) position.

### **Autolock**

The autolock feature will lock the vehicle's doors when:

- all the doors are closed,
- the ignition is in the 4 (RUN) position,
- you shift into forward or reverse, and
- the vehicle speed is greater than 3 mph (5 km/h).

### **Relock**

The autolock feature repeats when:

- either door is opened then closed while the ignition is in the 4 (RUN) position, and
- you shift into forward or reverse, and
- the vehicle speed is greater than 3 mph (5 km/h).

### **Deactivating/activating autolock**

Your vehicle comes with the autolock feature activated; in order to deactivate the feature, take your vehicle to an authorized dealer, or use the message center (if equipped). Refer to *Message center* in the *Driver Controls* chapter for more information.

## Locks and Security

### Memory seat feature

The remote entry system allows you to recall the memory seat/mirror/steering column/adjustable pedals feature.

Press  to automatically move the seat/mirror/steering column/adjustable pedals to the desired memory position. **Note:** The seat and steering column will not travel to their final position if the key is not in the ignition and the easy entry feature is enabled.

### Activating the memory feature

To activate this feature:

1. Position the seat, mirrors, steering column and adjustable pedals to the positions you desire.
2. Press the SET control on the driver's door panel.
3. Within 5 five seconds, press any control on the remote transmitter and then press the 1 or 2 control on the driver's door panel to associate with the Driver 1 or Driver 2 positions.
4. Repeat this procedure for another remote transmitter if desired.

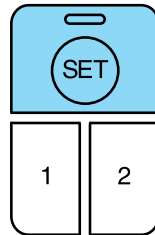

### Deactivating the memory feature

To deactivate this feature:

1. Press the SET control on the driver's door panel.
2. Within 5 five seconds, press any control on the remote transmitter which you would like to deactivate and then press the SET control on the driver's door panel again.
3. Repeat this procedure for another remote transmitter if desired.

### KEYLESS ENTRY SYSTEM

You can use the keyless entry keypad to:

- lock or unlock the doors without using a key.
- open the trunk.
- recall memory seat/mirrors/steering column/adjustable pedals positions 1 or 2.

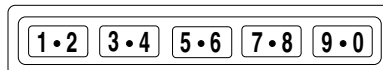

## Locks and Security

The keypad can be operated with the factory set 5–digit entry code; this code is located on the owner’s wallet card in the glove box, is marked on the computer module, and is available from your authorized dealer. You can also create your own 5–digit personal entry code.

When pressing the controls on the keypad, press the middle of the controls to ensure a good activation.

### Programming a personal entry code

To create your own personal entry code:

1. Enter the factory set code.
2. Within five seconds press the 1 • 2 on the keypad.
3. Enter your personal 5–digit code. Each number must be entered within five seconds of each other.
4. Enter a sixth digit to indicate which personality feature should be recalled by the personal code. **Note:** The lock motors will cycle, locked then unlocked.
  - 1 • 2 recalls driver personality 1.
  - 3 • 4 recalls driver personality 2.
  - 9 • 0 does not recall a driver personality.

Wait 5 seconds without pressing a keypad button in order to store a personal entry code.

### Tips:

- Do not set a code that uses five of the same number.
- Do not use five numbers in sequential order.
- The factory set code will work even if you have set your own personal code.
- If you set a personal code and store it over an existing personal code it will erase that personal code only.

### Erasing personal codes

1. Enter the factory set 5–digit code. The keyless entry keypad and interior lights will illuminate and the driver’s door will unlock.
2. Press and release the 1 • 2 within five seconds of completing Step 1.
3. Press and hold the 1 • 2 for two seconds to erase the customer programmed codes.

All personal codes are now erased and only the factory set 5–digit code will work.



## Locks and Security

**Note:** To exit programming mode, either wait 5 seconds after pressing 1 • 2 on the keypad, or press the 7 • 8 and 9 • 0 pads simultaneously to lock all vehicle doors and end programming mode.

### Anti-scan feature

If the wrong code has been entered several times, the keypad will go into an anti-scan mode. This mode disables the keypad for one minute and the keypad illumination will flash.

The anti-scan feature will turn off after:

- one minute of keypad inactivity.
- pressing the UNLOCK  control on the remote entry transmitter.
- the ignition is turned to the 4 (RUN) position.

### Unlocking and locking the doors using keyless entry

**To unlock the driver's door,** enter the factory set 5-digit code or your personal code. Each number must be pressed within five seconds of each other. The interior lamps will illuminate when the driver's door is unlocked.

**To unlock all doors,** press the 3 • 4 control within five seconds.

**To lock all doors,** press the 7 • 8 and the 9 • 0 at the same time. The driver's door must be closed to lock all doors. You **do not** need to enter the keypad code first. **Note:** The interior lamps will turn off.

### ***Recalling a memory seat/mirrors/steering column/adjustable pedals position 1 or 2***

- Unlock the vehicle using the personal entry code 1 in order to recall memory position 1.
- Unlock the vehicle using the personal entry code 2 in order to recall memory position 2.

### Releasing the trunk with the keyless entry system

To release/open the trunk, enter the factory-set code or personal code (driver door unlocks) and press 5 • 6 within five seconds.

### **SECURILOCK™ PASSIVE ANTI-THEFT SYSTEM**

SecuriLock™ passive anti-theft system is an engine immobilization system. This system is designed to prevent the engine from being started unless a **coded key programmed to your vehicle** is used. The use of the wrong type of coded key may lead to a “no-start” condition.

## Locks and Security

Your vehicle comes with three coded keys; additional coded keys may be purchased from your dealer. The dealer can program your spare keys to your vehicle or you can program the keys yourself. Refer to the *Programming spare keys* section in this chapter for instructions on how to program the coded key.

**Note:** The SecuriLock<sup>™</sup> passive anti-theft system is not compatible with non-Ford aftermarket remote start systems. Use of these systems may result in vehicle starting problems and a loss of security protection.

**Note:** Large metallic objects, electronic devices that are used to purchase gasoline or similar items, or a second coded key on the same key chain may cause vehicle starting issues. You need to prevent these objects from touching the coded key while starting the engine. These objects will not cause damage to the coded key, but may cause a momentary issue if they are too close to the key when starting the engine. If a problem occurs, turn the ignition to the 2 (OFF) position, remove all objects on the key chain away from the coded key and restart the engine.

### Theft indicator

The theft indicator is located on top of the instrument panel.

- When the ignition is in the 2 (OFF) position, the indicator will flash once every 2 seconds if the vehicle is locked and the perimeter alarm is armed.

If a problem occurs with the SecuriLock<sup>™</sup> system, the indicator will flash rapidly or glow steadily when the ignition is in the 4 (RUN) position. If this occurs, the vehicle should be taken to an authorized dealer for service.

### Replacement keys

If your keys are lost or stolen and you don't have an extra coded key, you will need to have your vehicle towed to a dealership. The key codes need to be erased from your vehicle and new coded keys will need to be programmed.

Replacing coded keys can be very costly. Store an extra programmed key away from the vehicle in a safe place to help prevent any inconveniences. Please visit an authorized dealer to purchase additional spare or replacement keys.

### Programming spare keys

A maximum of eight keys can be coded to your vehicle. Only SecuriLock<sup>™</sup> keys can be used. To program a **coded key** yourself, you

## Locks and Security

will need two previously programmed **coded keys** (keys that already operate your vehicle's engine) and the new unprogrammed key(s) readily accessible for timely implementation of each step in the procedure.

If two previously programmed **coded keys** are not available, you must take your vehicle to an authorized Ford dealer to have the spare **coded key(s)** programmed.

Please read and understand the entire procedure before you begin.

1. Insert the first previously programmed **coded key** into the ignition from 1 (LOCK) to 4 (RUN) (maintain ignition in the 4 (RUN) position for at least three seconds, but no more than ten seconds).

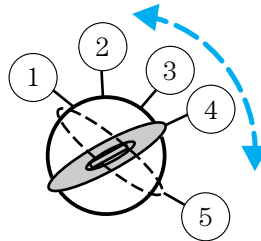

2. Turn the ignition to the 1 (LOCK) position and remove the first **coded key** from the ignition.

3. Within ten seconds of turning the ignition to the 1 (LOCK) position, insert the second previously programmed coded key into the ignition and turn the ignition from the 1 (LOCK) position to the 4 (RUN) position (maintain ignition in the 4 (RUN) position for at least three seconds, but no more than ten seconds).

4. Turn the ignition to the 1 (LOCK) position and remove the second **coded key** from the ignition.

5. Within twenty seconds of turning the ignition to the 1 (LOCK) position, insert the new unprogrammed key (new key/valet key) into the ignition and turn the ignition from 1 (LOCK) to 4 (RUN) (maintain ignition in the 4 (RUN) position for at least three seconds). This step will program your new key to a **coded key**.

6. To program additional new unprogrammed key(s), wait at least twenty seconds and then repeat this procedure from Step 1.

If successful, the new **coded key(s)** will start the vehicle's engine and the theft indicator will flash on and off. You may repeat Steps 1 through 5. If failure repeats, take your vehicle to your authorized dealer in order to have new spare key(s) programmed.

### PERIMETER ALARM SYSTEM

The perimeter anti-theft system will warn you in the event of an unauthorized entry to your vehicle.

## Locks and Security

If there is any potential perimeter anti-theft problem with your vehicle, ensure **ALL remote entry transmitters** are taken to the dealership to aid in troubleshooting.

### Arming the system

When armed, this system will respond if unauthorized entry is attempted. When unauthorized entry occurs, the system will flash the turn signal lamps and will sound the horn.

The system is ready to arm whenever key is removed from the ignition. Any of the following actions will prearm the alarm system:

- Press the  control on the remote entry transmitter.
- Press the driver or passenger interior power door lock control while that respective door is open, then close the door.
- Lock the vehicle with the key in the driver's door key cylinder.
- Lock the vehicle by pressing the 7 • 8 and the 9 • 0 on the keypad at the same time (with the driver's door closed).

### Theft indicator

When the vehicle is locked using one of the listed methods, the theft indicator located on the instrument panel will flash briefly every 2 seconds to indicate that the perimeter alarm system is armed.

### Disarming the system

You can disarm the system by any of the following actions:

- Unlock the doors by pressing the  control on your remote entry transmitter.
- Unlock the doors with a key. Turn the key full travel (toward the front of the vehicle) to ensure the alarm disarms.
- Unlock the doors by entering the factory-set code or any of the three custom codes into the keyless entry keypad.
- Turn the ignition to the 4 (RUN) position with a SecuriLock<sup>™</sup> coded key.

### Triggering the anti-theft system

The armed system will be triggered if any door, the trunk or the hood is opened without using the key, the remote entry transmitter or valid keypad code.

## Seating and Safety Restraints

### SEATING

#### Notes:



Reclining the seatback can cause an occupant to slide under the seat's safety belt, resulting in severe personal injuries in the event of a collision.



Do not pile cargo higher than the seatbacks to reduce the risk of injury in a collision or sudden stop.

### Adjustable head restraints

Head restraints help to limit head motion in the event of a rear collision. Adjust your head restraint so that it is located directly or as close as possible behind your head.

The head restraints can be moved up and down.

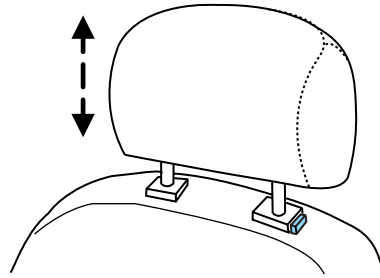

Push control to lower head restraint.

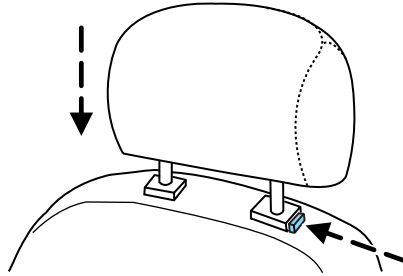

## Seating and Safety Restraints

### Using the manual lumbar support (if equipped)

The lumbar control is located on the front of the seat cushion.

Turn to adjust lumbar support.

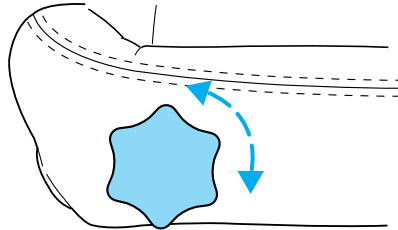

### Using the power lumbar support (if equipped)

The power lumbar control is located on the outboard side of the seat.

Press the front of the control to increase firmness.

Press the back of the control to decrease firmness.

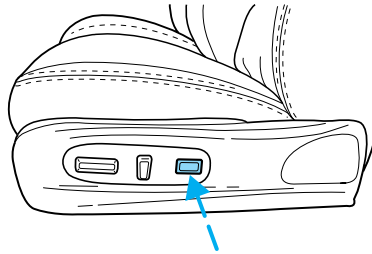

### Adjusting the power seats

The power seat controls are located on the outboard side of each seat.



Never adjust the driver's seat or seatback when the vehicle is moving.



Always drive and ride with your seatback upright and the lap belt snug and low across the hips.



Reclining the seatback can cause an occupant to slide under the seat's safety belt, resulting in severe personal injuries in the event of a collision.

## Seating and Safety Restraints

Rotate the vertical control to adjust the seatback.

- Driver
- Passenger

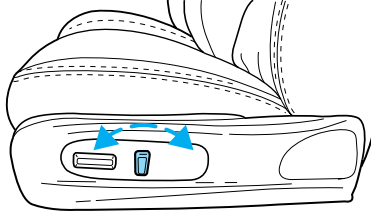

Slide the control forward or backward to move the seat forward or backward.

- Driver
- Passenger

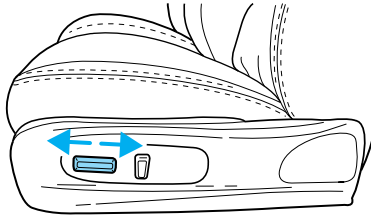

Move the control up or down to move the seat up and down.

- Driver
- Passenger

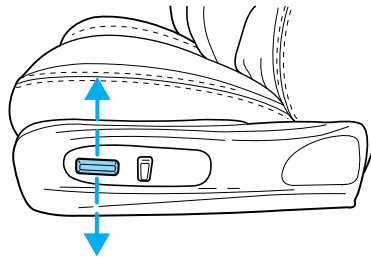

Move front/rear of control up or down to tilt the front/rear of the seat cushion.

- Driver

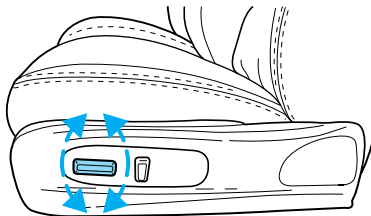

### Easy entry/easy exit feature (if equipped)

This feature automatically moves the driver's seat backward 5 cm (2 inches) when the key is removed from the ignition cylinder.

The seat will move 5 cm (2 inches) forward (to the original position) when the key is placed in the ignition cylinder.

## Seating and Safety Restraints

### ***Deactivating/activating the easy entry/easy exit feature***

The easy entry/easy exit feature can be turned off or on through the vehicle message center (if equipped). If your vehicle does not have a message center, the feature can be turned off or on by your dealer.

### **Memory seats/steering column/mirrors/adjustable pedals (if equipped)**

This system allows automatic positioning of the driver seat, adjustable pedals, outside rearview mirrors, and power adjusted tilt/telescope steering column to two programmable positions.

The memory seat control is located on the driver door.

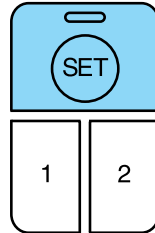

- To program position one, move the driver seat, steering column, exterior mirrors, and adjustable pedals to the desired positions using the associated controls. Press the SET control. The SET control light will briefly illuminate. While the light is illuminated, press control 1.
- To program position two, repeat the previous procedure using control 2.

A position can only be recalled when the transmission gearshift is in Park (automatic transmission). A memory seat position may be programmed at any time.

The memory seat positions are also recalled when you press your remote entry transmitter UNLOCK control and the transmitter is programmed to a memory seat position or when you enter a valid customer code 1 or 2 on the keypad.

To program the memory seat to remote entry transmitter, refer to *Remote entry system* in the *Locks and security chapter*.

**Note: The seat will not travel to its final position if the key is not in the ignition and the easy entry feature is enabled.**

### **Climate controlled seats operation**

The controls for the climate controlled seats are located on the dual electronic automatic temperature control (DEATC) system. Refer to *Climate controls* for more information.



## Seating and Safety Restraints

### ***Climate controlled seats air filter replacement***

The climate controlled seat system includes air filters that must be replaced periodically. Refer to the *Scheduled Maintenance Guide* for more information.

- There is a filter located under each front seat.

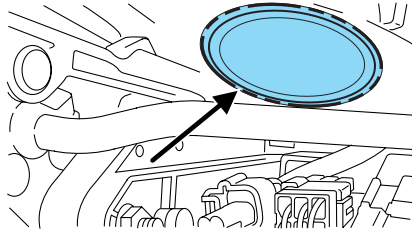

- They can be accessed from the second row seat. Move the front seats all the way forward and up to ease access.

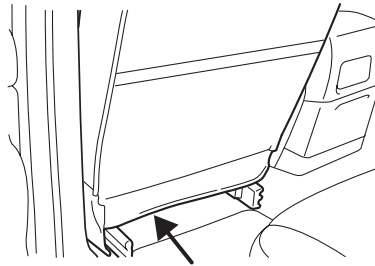

To remove an air filter:

- Remove key from ignition.
- Push up on the outside rigid edge of the filter and rotate toward the front of the vehicle once tabs are released.

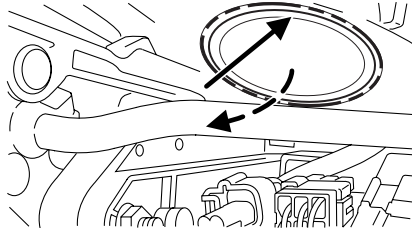

## Seating and Safety Restraints

- Remove filter.

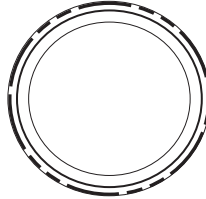

To install a filter:

- First, position the filter in its housing making sure that the far forward end is all the way up in the housing. Then push in on the center of the outside edge of the filter and rotate up into the housing until it clips into position.

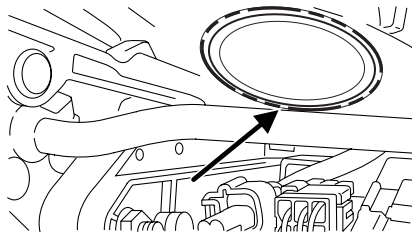

## REAR SEATS

### Adjustable rear head restraints (if equipped)

Head restraints help to limit head motion in the event of a rear collision. Adjust your head restraint so that it is located directly or as close as possible behind your head.

The head restraints can be moved up and down.

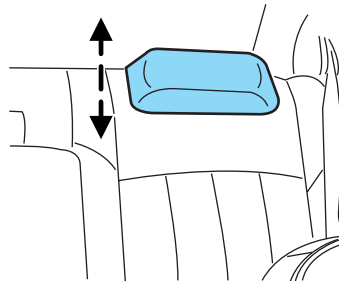

## Seating and Safety Restraints

Push control to lower head restraint.

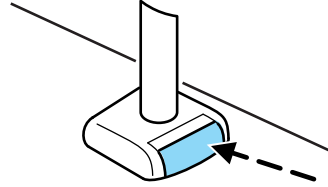

### Rear heated seats (if equipped)

- Push the indicated side of the button for low heat.
- Push again to deactivate.



- Push the indicated side of the button for high heat.
- Push again to deactivate.



The heated seats will activate when the ignition is in the RUN position. When activated, they will turn off automatically after 10 minutes or when the ignition is turned to the OFF position.

The indicator lights will illuminate when each heated seat has been activated.

### Split-folding rear seatbacks

One or both rear seatbacks can be folded down to provide additional cargo space.

## Seating and Safety Restraints

To lower the seatback(s), pull the release handle(s) located inside the trunk.

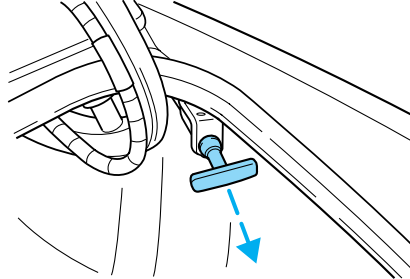

Fold the seatback(s) down.

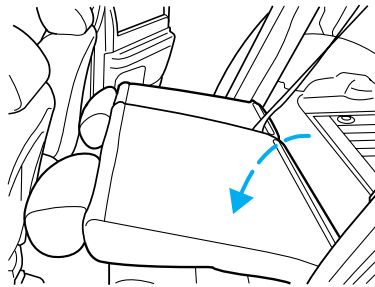

When raising the seatback(s), make sure you hear the seat latch into place.

Make sure that the safety belts for the rear center passenger is properly routed over the rear seatback.

### SAFETY RESTRAINTS

#### Personal Safety System

The Personal Safety System provides an improved overall level of frontal crash protection to front seat occupants and is designed to help further reduce the risk of air bag-related injuries. The system is able to analyze different occupant conditions and crash severity before activating the appropriate safety devices to help better protect a range of occupants in a variety of frontal crash situations.

Your vehicle's Personal Safety System consists of the following items:

- Driver and passenger dual-stage air bag supplemental restraints
- Driver and front passenger side air bags
- Driver and passenger side air curtains (if equipped)
- Front safety belts with pretensioners, energy management retractors, and safety belt usage sensors

## Seating and Safety Restraints

- Driver's seat position sensor
- Front crash severity sensor
- Restraints Control Module (RCM) with impact and safing sensors
- Restraint system warning light and back-up tone
- The electrical wiring for the air bags, crash sensor(s), safety belt pretensioners, front safety belt usage sensors, driver seat position sensor, and indicator lights

### ***How does the personal safety system work?***

The Personal safety system can adapt the deployment strategy of your vehicle's safety devices according to crash severity and occupant conditions. A collection of crash and occupant sensors provides information to the Restraints control module (RCM). During a crash, the RCM activates the safety belt pretensioners and/or either one or both stages of the dual-stage air bag supplemental restraints based on crash severity and occupant conditions.

The fact that the pretensioners or air bags did not activate for both front seat occupants in a collision does not mean that something is wrong with the system. Rather, it means the Personal safety system determined the accident conditions (crash severity, belt usage, etc.) were not appropriate to activate these safety devices. Front air bags and pretensioners are designed to activate only in frontal and near-frontal collisions, not rollovers, side-impacts, or rear-impacts unless the collision causes sufficient longitudinal deceleration.

### ***Driver and passenger dual-stage air bag supplemental restraints***

The dual-stage air bags offer the capability to tailor the level of air bag inflation energy. A lower, less forceful energy level is provided for more common, moderate-severity impacts. A higher energy level is used for the most severe impacts. Refer to *Air bag supplemental restraints* section in this chapter.

### ***Front crash severity sensor***

The front crash severity sensor enhances the ability to detect the severity of an impact. Positioned up front, it provides valuable information early in the crash event on the severity of the impact. This allows your Personal safety system to distinguish between different levels of crash severity and modify the deployment strategy of the dual-stage air bags and safety belt pretensioners.

## Seating and Safety Restraints

### ***Driver's seat position sensor***

The driver's seat position sensor allows your Personal safety system to tailor the deployment level of the driver dual-stage air bag based on seat position. The system is designed to help protect smaller drivers sitting close to the driver air bag by providing a lower air bag output level.



Air bags can kill or injure a child in a child seat. **NEVER** place a rear-facing child seat in front of an active air bag. If you must use a forward-facing child seat in the front seat, move the seat all the way back.



Always transport children 12 years old and under in the back seat and always properly use appropriate child restraints.

### ***Front safety belt usage sensors***

The front safety belt usage sensors detect whether or not the driver and front outboard passenger safety belts are fastened. This information allows your Personal safety system to tailor the air bag deployment and safety belt pretensioner activation depending upon safety belt usage. Refer to *Safety belt* section in this chapter.

### ***Front safety belt pretensioners***

The safety belt pretensioners at the front outboard seating positions are designed to tighten the safety belts firmly against the occupant's body during a frontal or near-frontal collision. This maximizes the effectiveness of the safety belts to improve protection. The safety belt pretensioners can be either activated alone or, if the collision is of sufficient severity, together with the air bags.

### ***Front safety belt energy management retractors***

The front safety belt energy management retractors allow webbing to be pulled out of the retractor in a gradual and controlled manner in response to the occupant's forward momentum. This helps reduce the risk of force-related injuries to the occupant's chest by limiting the load on the occupant. Refer to *Energy management feature* section in this chapter.

### ***Determining if the Personal safety system is operational***

The Personal safety system uses a warning light in the instrument cluster or a back-up tone to indicate the condition of the system. Refer to the *Warning light* section in the *Instrument cluster* chapter. Routine maintenance of the Personal safety system is not required.

## Seating and Safety Restraints

The Restraints control module (RCM) monitors its own internal circuits and the circuits for the air bag supplemental restraints, crash sensor(s), safety belt pretensioners, front safety belt buckle sensors, and driver seat position sensor. In addition, the RCM also monitors the restraints warning light in the instrument cluster. A difficulty with the system is indicated by one or more of the following.

- The warning light will either flash or stay lit.
- The warning light will not illuminate immediately after ignition is turned on.
- A series of five beeps will be heard. The tone pattern will repeat periodically until the problem and warning light are repaired.

If any of these things happen, even intermittently, have the Personal safety system serviced at your dealership or by a qualified technician immediately. Unless serviced, the system may not function properly in the event of a collision.

### Safety restraints precautions



Always drive and ride with your seatback upright and the lap belt snug and low across the hips.



To reduce the risk of injury, make sure children sit in the back seat where they can be properly restrained.



Never let a passenger hold a child on his or her lap while the vehicle is moving. The passenger cannot protect the child from injury in a collision.



All occupants of the vehicle, including the driver, should always properly wear their safety belts, even when an air bag supplemental restraint system (SRS) is provided.



It is extremely dangerous to ride in a cargo area, inside or outside of a vehicle. In a collision, people riding in these areas are more likely to be seriously injured or killed. Do not allow people to ride in any area of your vehicle that is not equipped with seats and safety belts. Be sure everyone in your vehicle is in a seat and using a safety belt properly.

## Seating and Safety Restraints



In a rollover crash, an unbelted person is significantly more likely to die than a person wearing a safety belt.



Each seating position in your vehicle has a specific safety belt assembly which is made up of one buckle and one tongue that are designed to be used as a pair. 1) Use the shoulder belt on the outside shoulder only. Never wear the shoulder belt under the arm. 2) Never swing the safety belt around your neck over the inside shoulder. 3) Never use a single belt for more than one person.



Always transport children 12 years old and under in the back seat and always properly use appropriate child restraints.



Safety belts and seats can become hot in a vehicle that has been closed up in sunny weather; they could burn a small child. Check seat covers and buckles before you place a child anywhere near them.

### Combination lap and shoulder belts

1. Insert the belt tongue into the proper buckle (the buckle closest to the direction the tongue is coming from) until you hear a snap and feel it latch. Make sure the tongue is securely fastened in the buckle.

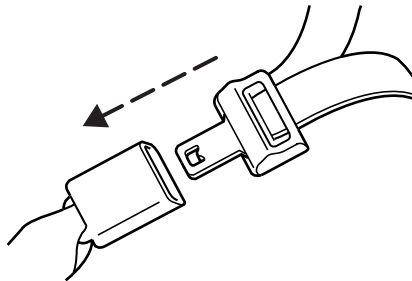



## Seating and Safety Restraints

2. To unfasten, push the release button and remove the tongue from the buckle.

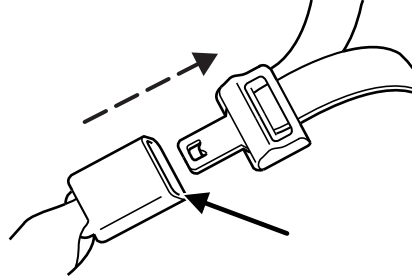

### Energy management feature

- This vehicle has a seat belt system with an energy management feature at the front outboard seating positions to help further reduce the risk of injury in the event of a head-on collision.
- This seat belt system has a retractor assembly that is designed to pay out webbing in a controlled manner. This feature is designed to help reduce the belt force acting on the occupant's chest.

 **BELT AND RETRACTOR ASSEMBLY MUST BE REPLACED** if the seat belt assembly “automatic locking retractor” feature or any other seat belt function is not operating properly when checked according to the procedures in Workshop Manual.

 Failure to replace the belt and retractor assembly could increase the risk of injury in collisions.

The front outboard and rear safety restraints in the vehicle are combination lap and shoulder belts. The front passenger and rear seat safety belts have two types of locking modes.

### Vehicle sensitive mode

This is the normal retractor mode, which allows free shoulder belt length adjustment to your movements and locking in response to vehicle movement. For example, if the driver brakes suddenly or turns a corner sharply, or the vehicle receives an impact of approximately 8 km/h (5 mph) or more, the combination safety belts will lock to help reduce forward movement of the driver and passengers.

## Seating and Safety Restraints

### Automatic locking mode

#### **How to use the automatic locking mode**

- Buckle the combination lap and shoulder belt.

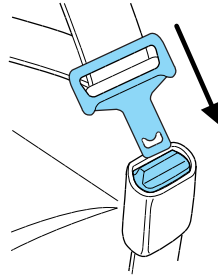

- Grasp the shoulder portion and pull downward until the entire belt is pulled out.

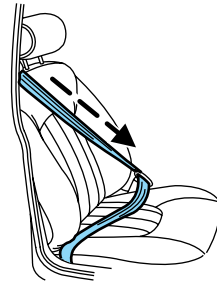

- Allow the belt to retract. As the belt retracts, you will hear a clicking sound. This indicates the safety belt is now in the automatic locking mode.

In this mode, the shoulder belt is automatically pre-locked. The belt will still retract to remove any slack in the shoulder belt. The automatic locking mode is not available on the driver safety belt.

This mode should be used **any time** a child safety seat is installed in the vehicle. Children 12 years old and under should be properly restrained in the rear seat whenever possible. Refer to *Safety restraints for children* or *Safety seats for children* later in this chapter.

#### **How to disengage the automatic locking mode**

Unbuckle the combination lap and shoulder belt and allow it to retract completely to disengage the automatic locking mode and return to the vehicle sensitive (emergency) locking mode.

## Seating and Safety Restraints

 After any vehicle collision, the combination lap and shoulder belt system at all passenger seating positions must be checked by a qualified technician to verify that the “automatic locking retractor” feature for child seats is still functioning properly, in addition to other checks for proper seat belt system function.

 **BELT AND RETRACTOR ASSEMBLY MUST BE REPLACED** if the safety belt assembly “automatic locking retractor” feature or any other safety belt function is not operating properly. In addition, all safety belts should be checked for proper function. Failure to replace the belt and retractor assembly could increase the risk of injury in collisions.

### Safety belt pretensioner

Your vehicle is equipped with safety belt pretensioners at the driver and front outboard passenger seating positions.

The safety belt pretensioner is a device which removes excess webbing from the safety belt system. The safety belt pretensioner uses the same crash sensor system as the front air bag supplemental restraint system (SRS). When the safety belt pretensioner deploys, webbing from the lap and shoulder belt is tightened. The driver and front passenger seat belt system (including retractors, buckles and height adjusters) must be replaced if the vehicle is involved in a collision that results in deployment of front air bags and safety belt pretensioners. Refer to the *Safety belt maintenance* section in this chapter.

 Failure to replace the safety belt assembly under the above conditions could result in severe personal injuries in the event of a collision.

## Seating and Safety Restraints

### Front safety belt height adjustment

Adjust the height of the shoulder belt so the belt rests across the middle of your shoulder.

To adjust the shoulder belt height, push the button and slide the height adjuster up or down. Release the button and pull down on the height adjuster to make sure it is locked in place.



Position the safety belt height adjusters so that the belt rests across the middle of your shoulder. Failure to adjust the safety belt properly could reduce the effectiveness of the seat belt and increase the risk of injury in a collision.

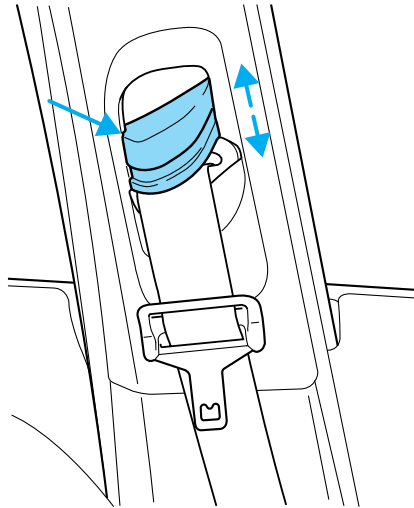

### Safety belt warning light and indicator chime

The safety belt warning light illuminates in the instrument cluster and a chime sounds to remind the occupants to fasten their safety belts.

### Conditions of operation

| If...   | Then...   |
|---|---|
| The driver's safety belt is not buckled before the ignition switch is turned to the RUN position...               | The safety belt warning light illuminates 1-2 minutes and the warning chime sounds 4-8 seconds. |
| The driver's safety belt is buckled while the indicator light is illuminated and the warning chime is sounding... | The safety belt warning light and warning chime turn off.                                       |
| The driver's safety belt is buckled before the ignition switch is turned to the RUN position...                   | The safety belt warning light and indicator chime remain off.                                   |

## Seating and Safety Restraints

### BeltMinder

The BeltMinder feature is a supplemental warning to the safety belt warning function. This feature provides additional reminders to the driver that the driver's safety belt is unbuckled by intermittently sounding a chime and illuminating the safety belt warning lamp in the instrument cluster.

| <b>If...</b>  | <b>Then...</b>  |
|---|---|
| The driver's safety belt is not buckled approximately 5 seconds after the safety belt warning light has turned off...                     | The BeltMinder feature is activated - the safety belt warning light illuminates and the warning chime sounds for 6 seconds every 30 seconds, repeating for approximately 5 minutes or until safety belt is buckled. |
| The driver's safety belt is buckled while the safety belt indicator light is illuminated and the safety belt warning chime is sounding... | The BeltMinder feature will not activate.   |
| The driver's safety belt is buckled before the ignition switch is turned to the ON position...  | The BeltMinder feature will not activate.   |

## Seating and Safety Restraints

The following are reasons most often given for not wearing safety belts:  
(All statistics based on U.S. data)

| Reasons given...                       | Consider...  |
|--|--|
| "Crashes are rare events"              | <b>36700 crashes occur every day.</b> The more we drive, the more we are exposed to "rare" events, even for good drivers. <i>1 in 4 of us will be seriously injured in a crash during our lifetime.</i>              |
| "I'm not going far"                    | <b>3 of 4</b> fatal crashes occur within <b>25</b> miles (40 km) of home.  |
| "Belts are uncomfortable"              | We design our safety belts to enhance comfort. If you are uncomfortable - try different positions for the safety belt upper anchorage and seatback which should be as upright as possible; this can improve comfort. |
| "I was in a hurry"                     | <b>Prime time for an accident.</b><br>BeltMinder reminds us to take a few seconds to buckle up.  |
| "Safety belts don't work"              | <b>Safety belts</b> , when used properly, <b>reduce risk of death</b> to front seat occupants by <b>45% in cars</b> , and by <b>60% in light trucks</b> .  |
| "Traffic is light"                     | <b>Nearly 1 of 2 deaths occur in single-vehicle crashes</b> , many when no other vehicles are around.  |
| "Belts wrinkle my clothes"             | Possibly, but a serious crash can do much more than wrinkle your clothes, particularly if you are unbelted.  |
| "The people I'm with don't wear belts" | Set the example, teen deaths occur 4 times more often in vehicles with TWO or MORE people. Children and younger brothers/sisters imitate behavior they see.  |

## Seating and Safety Restraints

| Reasons given...             | Consider...   |
|------------------------------|---|
| "I have an air bag"          | Air bags offer greater protection when used with safety belts. Frontal airbags are not designed to inflate in rear and side crashes or rollovers.     |
| "I'd rather be thrown clear" | Not a good idea. <b>People</b> who are <b>ejected are 40 times more likely to DIE.</b> Safety belts help prevent ejection, WE CAN'T "PICK OUR CRASH". |



Do not sit on top of a buckled safety belt to avoid the Belt Minder chime. Sitting on the safety belt will increase the risk of injury in an accident. To disable (one-time) or deactivate the Belt Minder feature please follow the directions stated below.

### **One time disable**

Any time the safety belt is buckled and then unbuckled during an ignition ON cycle, the BeltMinder will be disabled for that ignition cycle only.

### **Deactivating/activating the BeltMinder feature**

*Read steps 1 - 9 thoroughly before proceeding with the deactivation/activation programming procedure.*

The BeltMinder feature can be deactivated/activated by performing the following procedure:

Before following the procedure, make sure that:

- The parking brake is set
- The gearshift is in P (Park) (automatic transmission)
- The ignition switch is in the OFF position
- All vehicle doors are closed
- The driver's safety belt is unbuckled
- The parklamps/headlamps are in OFF position (If vehicle is equipped with Autolamps, this will not affect the procedure.)



To reduce the risk of injury, do not deactivate/activate the Belt Minder feature while driving the vehicle.

## Seating and Safety Restraints

1. Turn the ignition switch to the RUN (or ON) position. (DO NOT START THE ENGINE)
2. Wait until the safety belt warning light turns off. (Approximately 1–2 minutes)
  - Steps 3–5 must be completed within 60 seconds or the procedure will have to be repeated.
3. Buckle then unbuckle the safety belt three times, ending with the safety belt unbuckled. This can be done before or during BeltMinder warning activation.
4. Turn on the parklamps/headlamps, turn off the parklamps/headlamps.
5. Buckle then unbuckle the safety belt three times, ending with the safety belt unbuckled.
  - After step 5 the safety belt warning light will be turned on for three seconds.
6. Within seven seconds of the safety belt warning light turning off, buckle then unbuckle the safety belt.
  - This will disable BeltMinder if it is currently enabled, or enable BeltMinder if it is currently disabled.
7. Confirmation of disabling BeltMinder is provided by flashing the safety belt warning light four times per second for three seconds.
8. Confirmation of enabling BeltMinder is provided by flashing the safety belt warning light four times per second for three seconds, followed by three seconds with the safety belt warning light off, then followed by flashing the safety belt warning light four times per second for three seconds again.
9. After receiving confirmation, the deactivation/activation procedure is complete.

### **Safety belt extension assembly**

If the safety belt is too short when fully extended, there is a 8 inch (20 cm) safety belt extension assembly that can be added (part number 611C22). This assembly can be obtained from your dealer at no cost.

Use only extensions manufactured by the same supplier as the safety belt. Manufacturer identification is located at the end of the webbing on the label. Also, use the safety belt extension only if the safety belt is too short for you when fully extended.



## Seating and Safety Restraints



Do not use extensions to change the fit of the shoulder belt across the torso.

### Safety belt maintenance

Inspect the safety belt systems periodically to make sure they work properly and are not damaged. Inspect the safety belts to make sure there are no nicks, tears or cuts. Replace if necessary. All safety belt assemblies, including retractors, buckles, front seat belt buckle assemblies, buckle support assemblies (slide bar-if equipped), shoulder belt height adjusters (if equipped), shoulder belt guide on seatback (if equipped), child safety seat LATCH and tether anchors, and attaching hardware, should be inspected after a collision. Ford Motor Company recommends that all safety belt assemblies in use in vehicles involved in a collision be replaced. However, if the collision was minor and a qualified technician finds that the belts do not show damage and continue to operate properly, they do not need to be replaced. Safety belt assemblies not in use during a collision should also be inspected and replaced if either damage or improper operation is noted.



Failure to inspect and if necessary replace the safety belt assembly under the above conditions could result in severe personal injuries in the event of a collision.

Refer to *Interior* in the *Cleaning* chapter.

### AIR BAG SUPPLEMENTAL RESTRAINT SYSTEM (SRS)

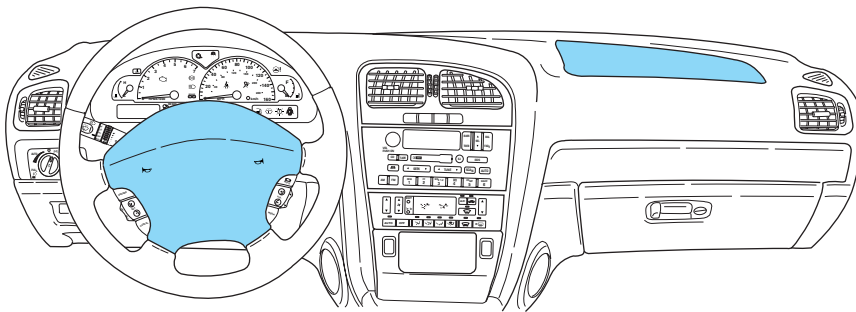



## Seating and Safety Restraints

### Important SRS precautions

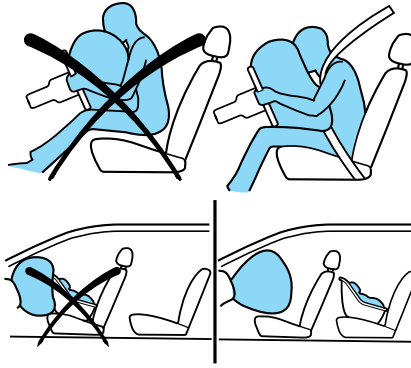
The SRS is designed to work with the safety belt to help protect the driver and right front passenger from certain upper body injuries. Air bags DO NOT inflate slowly; there is a risk of injury from a deploying air bag.



 All occupants of the vehicle, including the driver, should always properly wear their safety belts, even when an air bag supplemental restraint system (SRS) is provided.

 Always transport children 12 years old and under in the back seat and always properly use appropriate child restraints.

 The National Highway Traffic Safety Administration (NHTSA) recommends a minimum distance of at least 10 inches (25 cm) between an occupant's chest and the driver air bag module.

 Never place your arm over the air bag module as a deploying air bag can result in serious arm fractures or other injuries.

To properly position yourself away from the air bag:

- Move your seat to the rear as far as you can while still reaching the pedals comfortably.
- Recline the seat slightly one or two degrees from the upright position.

 Do not put anything on or over the air bag module. Placing objects on or over the air bag inflation area may cause those objects to be propelled by the air bag into your face and torso causing serious injury.

## Seating and Safety Restraints

 Do not attempt to service, repair, or modify the air bag supplemental restraint systems or its fuses. See your Ford or Lincoln Mercury dealer.

 Modifying or adding equipment to the front end of the vehicle (including frame, bumper, front end body structure and tow hooks) may affect the performance of the air bag system, increasing the risk of injury. Do not modify the front end of the vehicle.

### Children and air bags

Children must always be properly restrained. Accident statistics suggest that children are safer when properly restrained in the rear seating positions than in the front seating position. Failure to follow these instructions may increase the risk of injury in a collision.

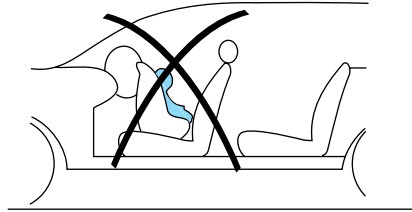

 Air bags can kill or injure a child in a child seat. **NEVER** place a rear-facing child seat in front of an active air bag. If you must use a forward-facing child seat in the front seat, move the seat all the way back.

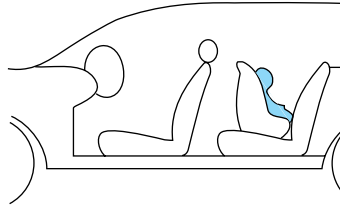

## Seating and Safety Restraints

### How does the safety belt pretensioner and air bag supplemental restraint system work?

The safety belt pretensioner and air bag SRS are designed to activate when the vehicle sustains longitudinal deceleration sufficient to cause the sensors to close an electrical circuit that initiates pretensioner activation and air bag inflation.

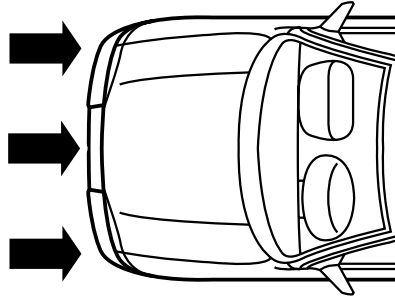

The fact that the pretensioners and air bags did not activate in a collision does not mean that something is wrong with the system. Rather, it means the forces were not of the type sufficient to cause activation. Front air bags and pretensioners are designed to activate in frontal and near-frontal collisions, not rollover, side-impact, or rear-impacts unless the collision causes sufficient longitudinal deceleration.

The air bags inflate and deflate rapidly upon activation. After air bag deployment, it is normal to notice a smoke-like, powdery residue or smell the burnt propellant. This may consist of cornstarch, talcum powder (to lubricate the bag) or sodium compounds (e.g., baking soda) that result from the combustion process that inflates the air bag. Small amounts of sodium hydroxide may be present which may irritate the skin and eyes, but none of the residue is toxic.



While the system is designed to help reduce serious injuries, contact with a deploying air bag may also cause abrasions, swelling or temporary hearing loss. Because air bags must inflate rapidly and with considerable force, there is the risk of death or serious injuries such as fractures, facial and eye injuries or internal injuries, particularly to occupants who

## Seating and Safety Restraints

are not properly restrained or are otherwise out of position at the time of air bag deployment. Thus, it is extremely important that occupants be properly restrained as far away from the air bag module as possible while maintaining vehicle control.



Several air bag system components get hot after inflation. Do not touch them after inflation.



If the air bag has deployed, **the air bag will not function again and must be replaced immediately.** If the air bag is not replaced, the unrepaired area will increase the risk of injury in a collision.

The SRS consists of:

- driver and passenger air bag modules (which include the inflators and air bags)
- side air bags. Refer to *Side air bag system* later in this chapter
- safety belt pretensioners
- one or more impact and safing sensors
- a readiness light and tone
- and the electrical wiring which connects the components

The diagnostic module monitors its own internal circuits and the supplemental air bag electrical system wiring (including the impact sensors), the system wiring, the air bag system readiness light, the air bag back up power, the air bag ignitors and safety belt pretensioners.

### Determining if the system is operational

The SRS uses a readiness light in the instrument cluster or a tone to indicate the condition of the system. Refer to the *Air bag readiness* section in the *Instrument cluster* chapter. Routine maintenance of the air bag is not required.

Any difficulty with the system is indicated by one or more of the following:

- The readiness light will either flash or stay lit
- The readiness light will not illuminate immediately after ignition is turned to the RUN position



## Seating and Safety Restraints

- A series of five beeps will be heard. The tone pattern will repeat periodically until the problem and/or light are repaired.

If any of these things happen, even intermittently, have the SRS serviced at your dealership or by a qualified technician immediately. Unless serviced, the system may not function properly in the event of a collision.

### Side air bag system



Do not place objects or mount equipment on or near the air bag cover on the side of the seatbacks of the front seats or in front seat areas that may come into contact with a deploying air bag. Failure to follow these instructions may increase the risk of personal injury in the event of a collision.



Do not use accessory seat covers. The use of accessory seat covers may prevent the deployment of the side air bags and increase the risk of injury in an accident.



Do not lean your head on the door. The side air bag could injure you as it deploys from the side of the seatback.



Do not attempt to service, repair, or modify the air bag SRS, its fuses or the seat cover on a seat containing an air bag. See your Ford or Lincoln Mercury dealer.



All occupants of the vehicle should always wear their safety belts even when an air bag SRS is provided.

## Seating and Safety Restraints

### **How does the side air bag system work?**

The side air bag system consists of the following:

- An inflatable nylon bag (air bag) with a gas generator concealed behind the outboard bolster of the driver and front passenger seatbacks.
- A special seat cover designed to allow air bag deployment.
- The same warning light, electronic control and diagnostic unit as used for the front air bags.
- Two crash sensors located under the outboard side of the front seats, attached near the floor.

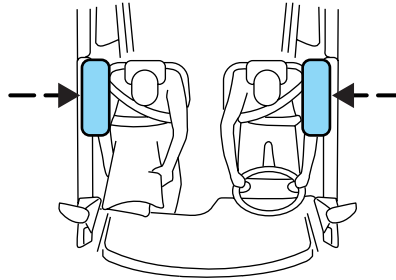

Side air bags, in combination with seat belts, can help reduce the risk of severe injuries in the event of a significant side impact collision.

The side air bags are fitted on the outboard side of the seatbacks of the front seats. In certain lateral collisions, the air bag on the side affected by the collision will be inflated, even if the respective seat is not occupied. The air bag was designed to inflate between the door panel and occupant to further enhance the protection provided occupants in side impact collisions.

The air bag SRS is designed to activate when the vehicle sustains lateral deceleration sufficient to cause the sensors to close an electrical circuit that initiates air bag inflation.

The fact that the air bags did not inflate in a collision does not mean that something is wrong with the system. Rather, it means the forces were not of the type sufficient to cause activation. Side air bags are designed to inflate in side-impact collisions, not roll-over, rear-impact, frontal or near-frontal collisions, unless the collision causes sufficient lateral deceleration.



Several air bag system components get hot after inflation. Do not touch them after inflation.

## Seating and Safety Restraints



If the side air bag has deployed, **the air bag will not function again. The side air bag system (including the seat) must be inspected and serviced by a qualified technician in accordance with the vehicle service manual.** If the air bag is not replaced, the unrepaired area will increase the risk of injury in a collision.

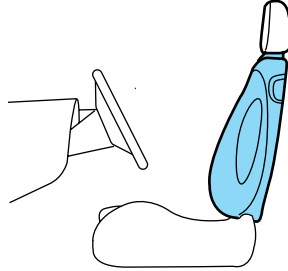

### ***Determining if the system is operational***

The SRS uses a readiness light in the instrument cluster or a tone to indicate the condition of the system. Refer to the *Air bag readiness* section in the *Instrument cluster* chapter. Routine maintenance of the air bag is not required.

Any difficulty with the system is indicated by one or more of the following:

- The readiness light (same light as used for front air bag system) will either flash or stay lit.
- The readiness light will not illuminate immediately after ignition is turned to the RUN position.
- A series of five beeps will be heard. The tone pattern will repeat periodically until the problem and light are repaired.

If any of these things happen, even intermittently, have the SRS serviced at your dealership or by a qualified technician immediately. Unless serviced, the system may not function properly in the event of a collision.





## Seating and Safety Restraints

### Side air curtain system (if equipped)

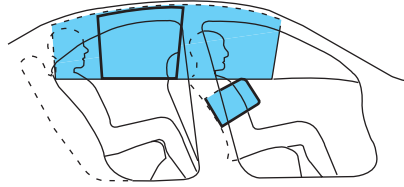
 Do not place objects or mount equipment on or near the airbag cover on the side of the seatbacks of the front seats or in front seat areas that may come into contact with a deploying airbag. Failure to follow these instructions may increase the risk of personal injury in the event of a collision.



 Do not place objects or mount equipment on or near the headliner at the siderail that may come into contact with a deploying side air curtain. Failure to follow these instructions may increase the risk of personal injury in the event of a collision.

 Do not place objects or mount equipment on or near the side air curtain cover.

 Do not lean your head on the door. The side airbag could injure you as it deploys from the seat.

 Do not lean your head on the door. The side air curtain could injure you as it deploys from the headliner.

## Seating and Safety Restraints



Do not attempt to service, repair, or modify the side air curtain system, its fuses, the A, B, or C pillar trim, or the headliner on a vehicle containing a side air curtain. See your Ford or Lincoln Mercury dealer.



Do not attempt to service, repair, or modify the air bag supplemental restraint system, its fuses, or the seat cover on a seat containing an air bag. See your Ford or Lincoln Mercury dealer.



All occupants of the vehicle, including the driver, should always wear their safety belts even when an inflatable curtain is provided.



To reduce the risk of injury, do not obstruct or place objects in the deployment of the inflatable curtain.

## Seating and Safety Restraints

### **How does the side air curtain system work?**

The design and development of the side air curtain system included recommended testing procedures that were developed by a group of automotive safety experts known as the Side Airbag Technical Working Group. These recommended testing procedures help reduce the risk of injuries related to the deployment of side air bags (including side air curtain systems).

The side air curtain system consists of the following:

- An inflatable nylon curtain with a gas generator concealed behind the headliner and above the doors.
- The headliner will flex to open above the side doors to allow air curtain deployment.
- The same warning light, electronic control and diagnostic unit as used for the front airbags.
- Two crash sensors located under the outboard side of the front seats, attached near the floor.
- Two crash sensors located at the base of the “C” pillars above the wheel house.
- An inflatable nylon bag (airbag) with a gas generator concealed behind the outboard bolster of the driver and front passenger seatbacks.
- A special seat cover to allow airbag deployment (front seats only).

Side air curtains and side air bags, in combination with seat belts, can help reduce the risk of severe injuries in the event of a significant side impact collision.

The side air curtains are mounted to the sheet metal above the first and second row seats. In certain lateral collisions, the air curtain and seat-mounted side air bag on the side affected by the collision will be inflated, even if the respective seat is not occupied. The air curtain was designed to inflate between the side window area and occupant to further enhance the head protection provided to occupants in side

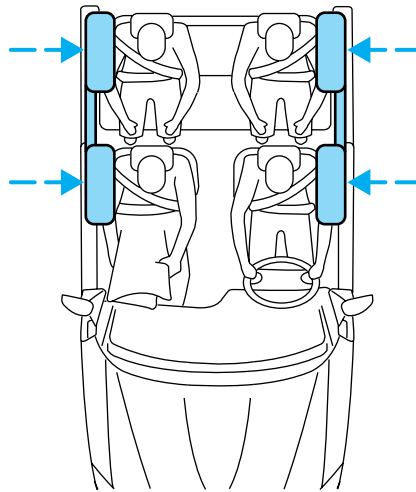

## Seating and Safety Restraints

impact collisions. The seat-mounted side air bag was designed to inflate between the door panel and occupant to further enhance the protection provided occupants in side impact collision.

The side air curtain system SRS is designed to activate when the vehicle sustains lateral deceleration sufficient to cause the sensors to close an electrical circuit that initiates air curtain and seat-mounted side air bag inflation.

The fact that the side air curtain and seat-mounted side air bag did not inflate in a collision does not mean that something is wrong with the system. Rather, it means the forces were not of the type sufficient to cause activation. The side air curtain system is designed to inflate in side impact collisions, not roll-over, rear impact, frontal or near-frontal collisions, unless the collision causes sufficient lateral deceleration.



Several air bag system components get hot after inflation. Do not touch them after inflation.



If the side air curtain has deployed, **the air curtain will not function again. The side air curtain system (including the A, B and C pillar trim and headliner) must be inspected and serviced by a qualified technician in accordance with the vehicle service manual.** If the air curtain is not replaced, the unrepaired area will increase the risk of injury in a collision.

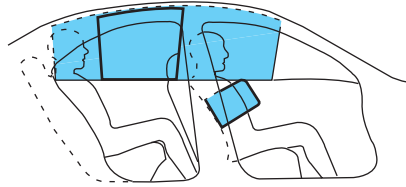

### ***Determining if the system is operational***

The SRS uses a readiness light in the instrument cluster or a tone to indicate the condition of the system. Refer to the *Air bag readiness* section in the *Instrument cluster* chapter. Routine maintenance of the air bag is not required.

## Seating and Safety Restraints

Any difficulty with the system is indicated by one or more of the following:

- The readiness light (same light as used for front air bag system) will either flash or stay lit.
- The readiness light will not illuminate immediately after ignition is turned to the RUN position.
- A series of five beeps will be heard. The tone pattern will repeat periodically until the problem and light are repaired.

If any of these things happen, even intermittently, have the SRS serviced at your dealership or by a qualified technician immediately. Unless serviced, the system may not function properly in the event of a collision.

### **Disposal of air bags and air bag equipped vehicles (including pretensioners)**

See your local dealership or qualified technician. Air bags **MUST BE** disposed of by qualified personnel.

### **SAFETY RESTRAINTS FOR CHILDREN**

See the following sections for directions on how to properly use safety restraints for children. Also see *Air bag supplemental restraint system (SRS)* in this chapter for special instructions about using air bags.

#### **Important child restraint precautions**

You are required by law to use safety restraints for children in the U.S. and Canada. If small children (generally children who are four years old or younger and who weigh 40 lbs[18 kg] or less) ride in your vehicle, you must put them in safety seats made especially for children. Many states require that children use approved booster seats until they are eight years old. Check your local and state or provincial laws for specific requirements regarding the safety of children in your vehicle. When possible, always place children under age 12 in the rear seat of your vehicle. Accident statistics suggest that children are safer when properly restrained in the rear seating positions than in the front seating position.



Never let a passenger hold a child on his or her lap while the vehicle is moving. The passenger cannot protect the child from injury in a collision.

Always follow the instructions and warnings that come with any infant or child restraint you might use.

## Seating and Safety Restraints

### Children and safety belts

If the child is the proper size, restrain the child in a safety seat. Children who are too large for child safety seats (as specified by your child safety seat manufacturer) should always wear safety belts.

Follow all the important safety restraint and air bag precautions that apply to adult passengers in your vehicle.

If the shoulder belt portion of a combination lap and shoulder belt can be positioned so it does not cross or rest in front of the child's face or neck, the child should wear the lap and shoulder belt. Moving the child closer to the center of the vehicle may help provide a good shoulder belt fit.



Do not leave children, unreliable adults, or pets unattended in your vehicle.

### Child booster seats

Children outgrow a typical convertible or toddler seat when they weigh 40 pounds (18 kg) and are around 4 years of age. Although the lap/shoulder belt will provide some protection, these children are still too small for lap/shoulder belts to fit properly, which could increase the risk of serious injury.

To improve the fit of both the lap and shoulder belt on children who have outgrown child safety seats, Ford Motor Company recommends use of a belt-positioning booster.

Booster seats position a child so that safety belts fit better. They lift the child up so that the lap belt rests low across the hips and the knees bend comfortably. Booster seats also make the shoulder belt fit better and more comfortably for growing children.

### When children should use booster seats

Children need to use booster seats from the time they outgrow the toddler seat until they are big enough for the vehicle seat and lap/shoulder belt to fit properly. Generally this is when they weigh about 80 lbs (36 kg) (about 8 to 12 years old).

## Seating and Safety Restraints

Booster seats should be used until you can answer YES to ALL of these questions:

- Can the child sit all the way back against the vehicle seat back with knees bent comfortably at the edge of the seat without slouching?

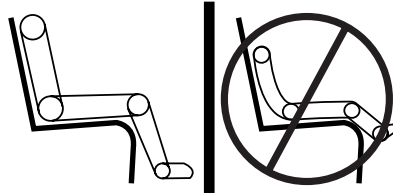

- Does the lap belt rest low across the hips?
- Is the shoulder belt centered on the shoulder and chest?
- Can the child stay seated like this for the whole trip?

### **Types of booster seats**

There are two types of belt-positioning booster seats:

- Those that are backless.

If your backless booster seat has a removable shield, remove the shield and use the lap/shoulder belt. If a seating position has a low seat back and no head restraint, a backless booster seat may place your child's head (top of ear level) above the top of the seat. In this case, move the backless booster to another seating position with a higher seat back and lap/shoulder belts.



- Those with a high back.

If, with a backless booster seat, you cannot find a seating position that adequately supports your child's head, a high back booster seat would be a better choice.



Both can be used in any vehicle in a seating position equipped with lap/shoulder belts if your child is over 40 lbs (18 kg).

## Seating and Safety Restraints

The shoulder belt should cross the chest, resting snugly on the center of the shoulder. The lap belt should rest low and snug across the hips, never up high across the stomach.

If the booster seat slides on the vehicle seat, placing a rubberized mesh sold as shelf or carpet liner under the booster seat may improve this condition.

### The importance of shoulder belts

Using a booster without a shoulder belt increases the risk of a child's head hitting a hard surface in a collision. For this reason, you should never use a booster seat with a lap belt only. It is best to use a booster seat with lap/shoulder belts in the back seat- the safest place for children to ride.



Follow all instructions provided by the manufacturer of the booster seat.



Never put the shoulder belt under a child's arm or behind the back because it eliminates the protection for the upper part of the body and may increase the risk of injury or death in a collision.



Never use pillows, books, or towels to boost a child. They can slide around and increase the likelihood of injury or death in a collision.

## SAFETY SEATS FOR CHILDREN

### Child and infant or child safety seats

Use a safety seat that is recommended for the size and weight of the child. Carefully follow all of the manufacturer's instructions with the safety seat you put in your vehicle. If you do not install and use the safety seat properly, the child may be injured in a sudden stop or collision.



## Seating and Safety Restraints

When installing a child safety seat:

- Review and follow the information presented in the *Air Bag Supplemental Restraint System* section in this chapter.
- Use the correct safety belt buckle for that seating position.
- Insert the belt tongue into the proper buckle until you hear a snap and feel it latch. Make sure the tongue is securely fastened in the buckle.
- Keep the buckle release button pointing up and away from the safety seat, with the tongue between the child seat and the release button, to prevent accidental unbuckling.
- Place seat back in upright position.
- Put the safety belt in the automatic locking mode. Refer to *Automatic locking mode*.
- LATCH lower anchors are recommended for use by children up to 48 pounds (22 kg) in a child restraint. Top tether anchors can be used for children up to 60 pounds (27 kg) in a child restraint, and to provide upper torso restraint for children up to 80 pounds (36 kg) using an upper torso harness and a belt-positioning booster.

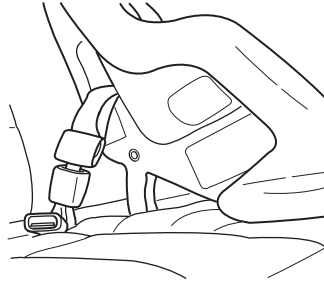

Ford recommends the use of a child safety seat having a top tether strap. Install the child safety seat in a seating position with LATCH and tether anchors. For more information on top tether straps and anchors, refer to *Attaching safety seats with tether straps* in this chapter. For more information of LATCH anchors refer to *Attaching safety seats with LATCH (Lower Anchors and Tethers for Children) attachments* in this chapter.



Carefully follow all of the manufacturer's instructions included with the safety seat you put in your vehicle. If you do not install and use the safety seat properly, the child may be injured in a sudden stop or collision.



Rear-facing child seats or infant carriers should never be placed in the front seats.

## Seating and Safety Restraints

### Installing child safety seats with combination lap and shoulder belts

 Air bags can kill or injure a child in a child seat. **NEVER** place a rear-facing child seat in front of an active air bag. If you must use a forward-facing child seat in the front seat, move the seat all the way back.

 Children 12 and under should be properly restrained in the rear seat whenever possible.

1. Position the child safety seat in a seat with a combination lap and shoulder belt.

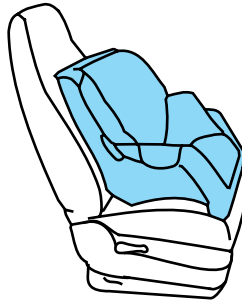

2. Pull down on the shoulder belt and then grasp the shoulder belt and lap belt together.

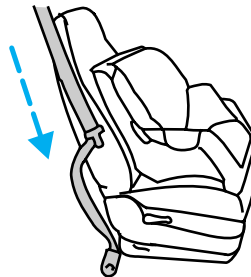

## Seating and Safety Restraints

3. While holding the shoulder and lap belt portions together, route the tongue through the child seat according to the child seat manufacturer's instructions. Be sure the belt webbing is not twisted.

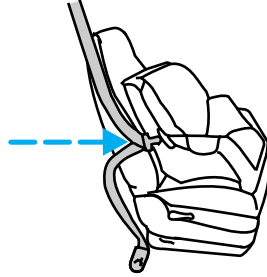

4. Insert the belt tongue into the proper buckle (the buckle closest to the direction the tongue is coming from) for that seating position until you hear a snap and feel the latch engage. Make sure the tongue is latched securely by pulling on it.

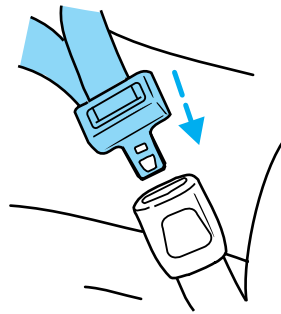

5. To put the retractor in the automatic locking mode, grasp the shoulder portion of the belt and pull downward until all of the belt is pulled out and a click is heard.

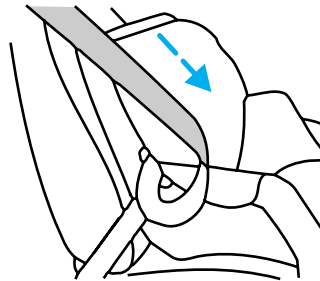

6. Allow the belt to retract. The belt will click as it retracts to indicate it is in the automatic locking mode.

## Seating and Safety Restraints

7. Pull the lap belt portion across the child seat toward the buckle and pull up on the shoulder belt while pushing down with your knee on the child seat.

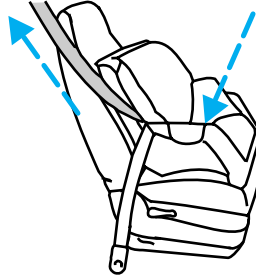

8. Allow the safety belt to retract to remove any slack in the belt.

9. Before placing the child in the seat, forcibly move the seat forward and back to make sure the seat is securely held in place. To check this, grab the seat at the belt path and attempt to move it side to side and forward. There should be no more than one inch of movement for proper installation.

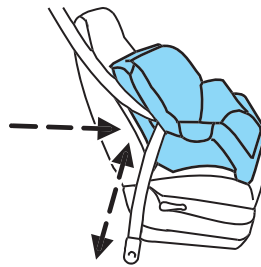

10. Try to pull the belt out of the retractor to make sure the retractor is in the automatic locking mode (you should not be able to pull more belt out). If the retractor is not locked, unbuckle the belt and repeat steps two through nine.

Check to make sure the child seat is properly secured before each use.

### Attaching child safety seats with tether straps

Most new forward-facing child safety seats include a tether strap which goes over the back of the seat and hooks to an anchoring point. Tether straps are available as an accessory for many older safety seats. Contact the manufacturer of your child seat for information about ordering a tether strap.

The rear seats of your vehicle are equipped with built-in tether strap anchors located behind the seats as described below.

The tether anchors in your vehicle are located under a cover marked with the tether anchor symbol (shown with title).

## Seating and Safety Restraints

The tether strap anchors in your vehicle are in the following positions (shown from top view):

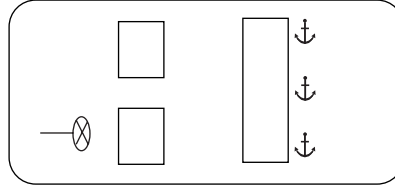

Attach the tether strap only to the appropriate tether anchor as shown. The tether strap may not work properly if attached somewhere other than the correct tether anchor.

1. Position the child safety seat on the seat cushion.
2. Route the child safety seat tether strap over the back of the seat.

For vehicles with adjustable head restraints, route the tether strap under the head restraint and between the head restraint posts, otherwise route the tether strap over the top of the seatback.

3. Locate the correct anchor for the selected seating position.



4. Open the tether anchor cover.



## Seating and Safety Restraints

5. Clip the tether strap to the anchor as shown.

 If the tether strap is clipped incorrectly, the child safety seat may not be retained properly in the event of a collision.

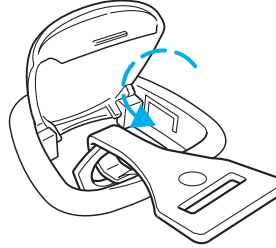

6. Install the child safety seat tightly using the LATCH anchors or safety belts. Follow the instructions in this chapter.

7. Tighten the child safety seat tether strap according to the manufacturer's instructions.

 If the safety seat is not anchored properly, the risk of a child being injured in a collision greatly increases.

### Attaching safety seats with LATCH (Lower Anchors and Tethers for Children) attachments for child seat anchors

Some child safety seats have two rigid or webbing mounted attachments that connect to two anchors at certain seating positions in your vehicle. This type of child seat eliminates the need to use seat belts to attach the child seat. For forward-facing child seats, the tether strap must also be attached to the proper tether anchor. See *Attaching safety seats with tether straps* in this chapter.

Your vehicle has LATCH anchors for child seat installation at the seating positions marked with the child seat symbol.

The anchors on both sides of the center of the rear seat are provided primarily for child seats at the outboard seats, and are further apart than the pairs of lower anchors for child seat installation at other seats. A child seat with rigid LATCH attachments cannot be installed at the center rear seat. A child seat with LATCH attachments on belt webbing can be used at the center rear seat unless a child seat at an outboard rear seat is attached to one of these lower anchors. Install a child seat onto the lower anchors at the center rear seat **ONLY IF** the child restraint manufacturer

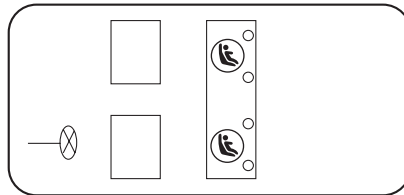

## Seating and Safety Restraints

recommends that the child seat can be installed to anchors that are spaced up to 500 mm (20 in) apart.



Never attach two LATCH child safety seats to the same anchor. In a crash, one anchor may not be strong enough to hold two child safety seat attachments and may break, causing serious injury or death.

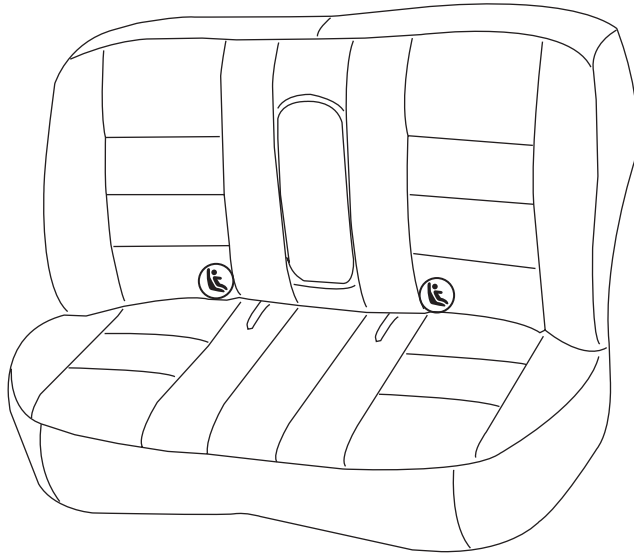

The lower anchors for child seat installation are recessed at the rear section of the rear seat between the cushion and seat back. The inboard LATCH anchors are located below and behind the locator symbols on the seat back. The outboard LATCH anchors are 11 inches (280 mm) outboard of the locator symbols.

## Seating and Safety Restraints

Follow the child seat manufacturer's instructions to properly install a child seat with LATCH attachments. Two plastic LATCH guides can be obtained at no charge from any Ford or Lincoln-Mercury dealer. They snap onto the LATCH lower anchors in the seat to help attach a child seat with rigid attachments. The guides hold the seat trim away to expose the anchor and make it easier to attach some child seats.

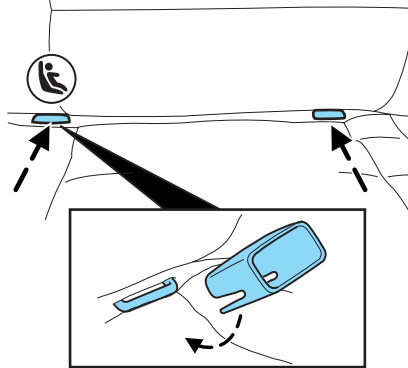

Attach LATCH lower attachments of the child seat only to the anchors shown.

If you install a child seat with rigid LATCH attachments, do not tighten the tether strap enough to lift the child seat off the vehicle seat cushion when the child is seated in it. Keep the tether strap just snug without lifting the front of the child seat. Keeping the child seat just touching the vehicle seat gives the best protection in a severe crash.

Each time you use the safety seat, check that the seat is properly attached to the lower anchors and tether anchor. Try to tilt the child seat from side to side. Also try to tug the seat forward. Check to see if the anchors hold the seat in place.



If the safety seat is not anchored properly, the risk of a child being injured in a crash greatly increases.



### STARTING

#### Positions of the ignition

1. LOCK, locks the gearshift lever and allows key removal. (The steering wheel will not lock after key removal.)

2. OFF, shuts off the engine and all accessories without locking the steering wheel. This position also allows the automatic transmission shift lever to be moved from the P (Park) position without the brake pedal being depressed.

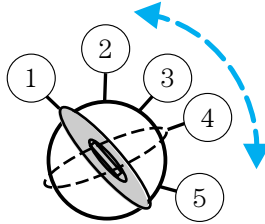

When the key is in the ignition and in the OFF position, the automatic transmission shift lever can be moved from the P (Park) position without the brake pedal depressed. To avoid unwanted vehicle movement, always set the parking brake.

3. ACCESSORY, allows the electrical accessories such as the radio to operate while the engine is not running.

4. RUN, all electrical circuits operational. Warning lights illuminated. Key position when driving.

5. START, cranks the engine. Release the key as soon as the engine starts.

#### Preparing to start your vehicle

Engine starting is controlled by the powertrain control system. This system meets all Canadian Interference-Causing Equipment standard requirements regulating the impulse electrical field strength of radio noise.

When starting a fuel-injected engine, don't press the accelerator before or during starting. Only use the accelerator when you have difficulty starting the engine. For more information on starting the vehicle, refer to *Starting the engine* in this chapter.



Extended idling at high engine speeds can produce very high temperatures in the engine and exhaust system, creating the risk of fire or other damage.

## Driving

 Do not park, idle, or drive your vehicle in dry grass or other dry ground cover. The emission system heats up the engine compartment and exhaust system, which can start a fire.

 Do not start your vehicle in a closed garage or in other enclosed areas. Exhaust fumes can be toxic. Always open the garage door before you start the engine. See *Guarding against exhaust fumes* in this chapter for more instructions.

 If you smell exhaust fumes inside your vehicle, have your dealer inspect your vehicle immediately. Do not drive if you smell exhaust fumes.

### **Important safety precautions**

When the engine starts, the idle RPM runs faster to warm the engine. If the engine idle speed does not slow down automatically, have the vehicle checked.

Before starting the vehicle:

1. Make sure all occupants buckle their safety belts. For more information on safety belts and their proper usage, refer to the *Seating and Safety Restraints* chapter.
2. Make sure the headlamps and electrical accessories are off.
  - Make sure the parking brake is set.

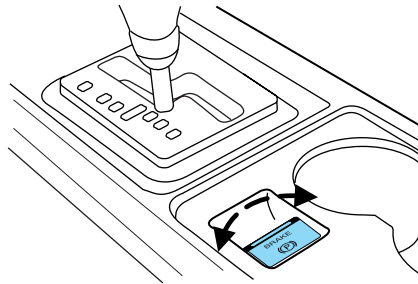

- Make sure the gearshift is in P (Park).

## Driving

- Turn the key to 4 (ON) without turning the key to 5 (START).

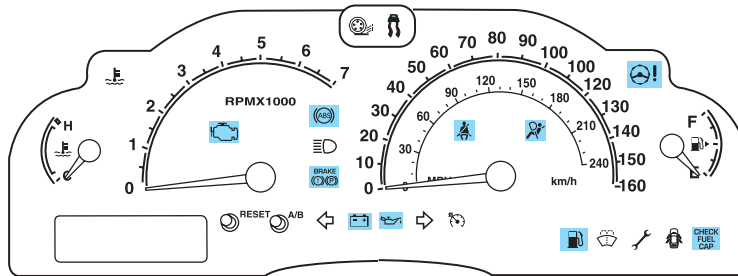
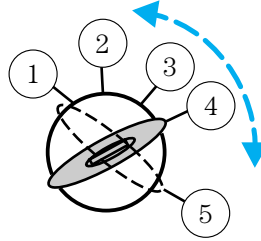

Make sure the corresponding lights illuminate or illuminate briefly. If a light fails to illuminate, have the vehicle serviced.

- If the driver's safety belt is fastened, the  light may not illuminate.

### Starting the engine

**Note:** Whenever you start your vehicle, release the key as soon as the engine starts. Excessive cranking could damage the starter.

1. Turn the key to 5 (START) without pressing the accelerator pedal and release as soon as the engine starts. The key will return to 4 (RUN).

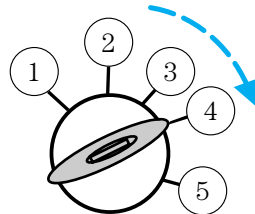

**Note:** If the engine does not start within five seconds on the first try, turn the key to 3 (OFF), wait 10 seconds and try again. If engine still fails to start, press the accelerator to the floor and try again: this will allow the engine to crank with the fuel shut off in case the engine is flooded with fuel.

2. When the engine starts, release the key, then release the accelerator pedal gradually as the engine speeds up.

## Driving

3. After idling for a few seconds, apply the brake, shift into gear and drive.

### Using the engine block heater (if equipped)

An engine block heater warms the engine coolant which aids in starting and heater/defroster performance. Use of an engine block heater is strongly recommended if you live in a region where temperatures reach -10°F (-23°C) or below. For best results, plug the heater in at least three hours before starting the vehicle. The heater can be plugged in the night before starting the vehicle.



To reduce the risk of electrical shock, do not use your heater with ungrounded electrical systems or two-pronged (cheater) adapters.

### Guarding against exhaust fumes

Carbon monoxide is present in exhaust fumes. Take precautions to avoid its dangerous effects.



If you smell exhaust fumes inside your vehicle, have your dealer inspect your vehicle immediately. Do not drive if you smell exhaust fumes.

### Important ventilating information

If the engine is idling while the vehicle is stopped for a long period of time, open the windows at least one inch (2.5 cm) or adjust the heating or air conditioning to bring in fresh air.

### BRAKES

Occasional brake noise is normal. If a metal-to-metal, continuous grinding or continuous squeal sound is present, the brake linings may be worn-out and should be inspected by a qualified service technician. If the vehicle has continuous vibration or shudder in the steering wheel while braking, the vehicle should be inspected by a qualified service technician.

Refer to *Brake system warning light* in the *Instrument Cluster* chapter for information on the brake system warning light.



### Four-wheel anti-lock brake system (ABS)

Your vehicle is equipped with an Anti-lock Braking System (ABS). This system helps you maintain steering control during emergency stops by

keeping the brakes from locking. Noise from the ABS pump motor and brake pedal pulsation may be observed during ABS braking; this is normal and should be no reason for concern.

### **ABS warning lamp**

The ABS lamp in the instrument cluster momentarily illuminates when the ignition is turned on. If the light does not illuminate during start up, remains on or flashes, the ABS may be disabled and may need to be serviced.

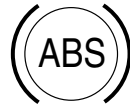

Even when the ABS is disabled, normal braking is still effective. (If your BRAKE warning lamp illuminates with the parking brake released, have your brake system serviced immediately.)



### **Using ABS**

When hard braking is required, apply continuous force on the brake pedal; do not pump the brake pedal since this will reduce the effectiveness of the ABS and will increase your vehicle's stopping distance. The ABS will be activated immediately, allowing you to retain full steering control during hard braking and on slippery surfaces. However, the ABS does not decrease stopping distance.

### **Parking brake**

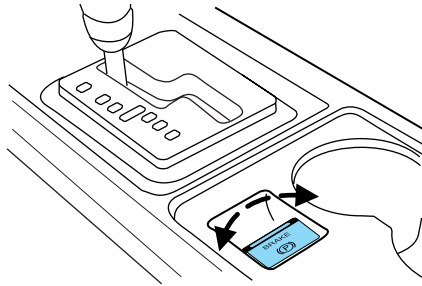

To set the parking brake, pull the lever up. To release the parking brake, make sure the ignition is turned to ON, depress the brake pedal, then gently push the parking brake lever down.

## Driving

The BRAKE warning lamp will illuminate and will remain illuminated until the parking brake is released.



The parking brake will automatically disengage when the gearshift lever is moved from P (Park) with the ignition in the ON position or if the engine is running. The parking brake will also disengage if a gear is selected and the accelerator pedal is depressed.

If the battery is disconnected (or removed), it will be necessary to reset the parking brake; the message center will display APPLY PARK BRAKE followed by FOOT ON BRAKE or APPLY ((P)) followed by FOOT BRK. With the ignition on and the engine not running, depress the brake pedal and apply the parking brake. The brake lamp will illuminate; this is normal and the parking brake is now reset. To release the parking brake, push the lever down with your foot on the brake pedal.

If there is a failure in the parking brake system, the amber warning light on the parking brake control will illuminate. See your dealer or a qualified technician for service on the parking brake system.

## STEERING

To prevent damage to the power steering system:

- Never hold the steering wheel at its furthest turning points (until it stops) for more than a few seconds when the engine is running.
- Do not operate the vehicle with a low power steering pump fluid level (below the MIN mark on the reservoir).

If the power steering system breaks down (or if the engine is turned off), you can steer the vehicle manually, but it takes more effort.

If the steering wanders or pulls, check for:

- an improperly inflated tire
- uneven tire wear
- loose or worn suspension components
- loose or worn steering components
- improper steering alignment

A high crown in the road or high crosswinds may also make the steering seem to wander/pull.

### Speed sensitive steering

The steering in your vehicle is speed sensitive. At high speeds, steering assist will decrease to improve steering feel. At lower speeds, maneuverability will be increased.

If the amount of effort required to steer your vehicle changes while driving at a constant vehicle speed, have the power steering system checked by your dealer or a qualified service technician.

### TRACTION CONTROL™

Your vehicle may be equipped with a Traction Control™ system. This system helps you maintain the stability and steerability of your vehicle, especially on slippery road surfaces such as snow- or ice-covered roads and gravel roads. The system will allow your vehicle to make better use of available traction in these conditions.

During Traction Control™ operation, the traction control active light will illuminate, you may hear an electric motor type of sound coming from the engine compartment and the engine will not “rev-up” when you push further on the accelerator. This is normal system behavior and should be no reason for concern.

The Traction Control™ switch, located on the center console by the gearshift lever, has an indicator light that illuminates when the system is off. The Traction Control™ system will automatically turn on every time the ignition is turned off and on.

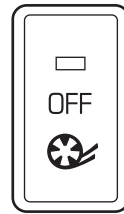

If you should become stuck in snow or ice or on a very slippery road surface, try switching the Traction Control™ system off. This may allow excess wheel spin to “dig” the vehicle out and enable a successful “rocking” maneuver.

If the Traction Control system is activated excessively in a short period of time, the brake portion of the system will shut down to allow the brakes to cool down. A limited Traction Control function using only engine power reduction will still help control the wheels from over-spinning. When the brakes have cooled down, the system will again function normally. Anti-lock braking is not affected by this condition and will function normally during the cool-down period.

If a system fault is detected, the traction control switch's OFF indicator will illuminate and your vehicle should be serviced.

## Driving

### **AdvanceTrac™ Stability Enhancement System (if equipped)**

The AdvanceTrac™ system provides a stability enhancement feature as well as a traction enhancement feature. It helps your vehicle maintain traction, when driving on slippery and/or hilly road surfaces, by detecting and controlling wheel spin. Excessive wheel spin is controlled by momentarily reducing engine power and rapidly applying the anti-lock brakes. The system is a driver aid which makes your vehicle easier to handle primarily on snow and ice-covered roads.

If your vehicle should become stuck in deep snow or mud, try switching the AdvanceTrac™ system off by pressing the AdvanceTrac™ button. This will allow your tires to “dig” for traction.

If the AdvanceTrac™ system is activated excessively in a short period of time, the brake portion of the system will shut down to allow the brakes to cool down. A limited AdvanceTrac™ function using only engine power reduction will still help control the wheels from over-spinning. When the brakes have cooled down, the system will again function normally. Anti-lock braking is not affected by this condition and will function normally during the cool-down period.

AdvanceTrac™ enhances your vehicle's stability during maneuvers that require all available tire traction, like in wet/snowy/icy road conditions and/or when performing emergency maneuvers. In an emergency lane-change, the driver will experience better overall vehicle traction, and have better control of the vehicle.

The AdvanceTrac™ system helps the driver maintain steering control if the vehicle begins to slide excessively left or right or spin out. AdvanceTrac™ will attempt to correct the sliding motion by applying brake force at individual tires and, if necessary, by reducing engine power.

Driving conditions which may activate AdvanceTrac™ include:

- Taking a turn too fast
- Maneuvering quickly to avoid an accident, pedestrian or obstacle
- Hitting a patch of ice
- Changing lanes on a snow-rutted road
- Entering a snow-free road from a snow-covered side street, or vice versa
- Entering a paved road from a gravel road, or vice versa
- Hitting a curb while turning
- Driving on slick surfaces



## Driving

The AdvanceTrac™ system automatically turns on when the engine is started. However, the system does not function when the vehicle is traveling in R (Reverse); the ABS and traction enhancement features will continue to function.

The AdvanceTrac™ button allows the driver to control the availability of the AdvanceTrac™ system.

AdvanceTrac™ system status is indicated by a warning indicator light with a “sliding car” icon in the instrument cluster that will flash when the system is active and an indicator light in the control button that will illuminate when the system is turned off. In vehicles with a message center, the message “ADVANCETRAC OFF” will be displayed.

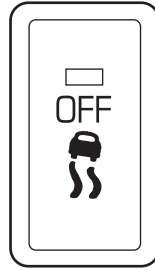

If a failure is detected in the AdvanceTrac™ system, the warning indicator light in the instrument cluster will stay on. If the warning indicator light in the instrument cluster remains on while the engine is running, have the system serviced immediately.

Pressing the control once will disable the AdvanceTrac™ stability enhancement and the engine power reduction portion of the traction enhancement feature; the brake portion of the traction enhancement feature will still function normally. Pressing and holding the control for more than five seconds will disable the AdvanceTrac™ stability enhancement **and** traction enhancement feature. If the vehicle is stuck in snow or mud or when driving in deep sand, switching off the AdvanceTrac™ system may be beneficial so the wheels are allowed to spin. If your vehicle seems to lose engine power while driving in deep sand or very deep snow, switching off the AdvanceTrac™ stability enhancement feature will restore full engine power and will enhance momentum through the obstacle.

Some drivers may notice a slight movement of the brake pedal when the AdvanceTrac™ performs a system self-check. During AdvanceTrac™ operation you may experience the following:

- A rumble or grinding noise
- A slight deceleration of the vehicle
- The AdvanceTrac™ indicator light will flash
- If your foot is on the brake pedal, you will feel a vibration in the pedal.

## Driving

- If the driving condition is severe and your foot is not on the brake, the brake pedal will move to apply higher brake forces. You may also hear a whoosh of air from under the instrument panel during this severe condition.

All these conditions are normal during AdvanceTrac™ operation.

**Do not alter or modify your vehicle's wheel/tire size, suspension or steering; the resulting changes to the vehicle's handling can adversely affect the AdvanceTrac™ system.**

**Modification/Addition of supplemental radio components, such as a subwoofer, may adversely affect the performance of the AdvanceTrac™ system.**



Aggressive driving in any road conditions can cause you to lose control of your vehicle increasing the risk of severe personal injury or property damage. The occurrence of an AdvanceTrac™ event is an indication that at least some of the tires have exceeded their ability to grip the road; this may lead to an increased risk of loss of vehicle control, vehicle rollover, personal injury and death. If you experience a severe road event, SLOW DOWN.

## AUTOMATIC TRANSMISSION OPERATION

### Brake-shift interlock

This vehicle is equipped with a brake-shift interlock feature that prevents the gearshift lever from being moved from P (Park) when the ignition is in the RUN position unless brake pedal is depressed.

If you cannot move the gearshift lever out of P (Park) with ignition in the RUN position and the brake pedal depressed:

1. Apply the parking brake, turn ignition key to LOCK, then remove the key.
2. Insert the key and turn it to OFF. **Apply the brake pedal and shift to N (Neutral).**



When the key is in the ignition and in the OFF position, the automatic transmission shift lever can be moved from the P (Park) position without the brake pedal depressed. To avoid unwanted vehicle movement, always set the parking brake.

3. Start the vehicle.

## Driving

If it is necessary to use the above procedure to move the gearshift lever, it is possible that a fuse has blown or the vehicle's brakelamps are not operating properly. Refer to *Fuses and relays* in the *Roadside Emergencies* chapter.



Do not drive your vehicle until you verify that the brakelamps are working.



Always set the parking brake fully and make sure the gearshift is latched in P (Park). Turn the ignition to the LOCK position and remove the key whenever you leave your vehicle.



If the parking brake is fully released, but the brake warning lamp remains illuminated, the brakes may not be working properly. See your dealer or a qualified service technician.

### Driving with a 5-speed automatic transmission

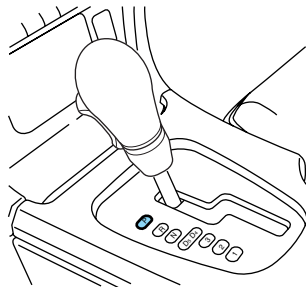

This vehicle is equipped with an adaptive Transmission Shift Strategy. Adaptive Shift Strategy offers the optimal transmission operation and shift quality. When the vehicle's battery has been disconnected for any type of service or repair, the transmission will need to relearn the normal shift strategy parameters, much like having to reset your radio stations when your vehicle battery has been disconnected. The Adaptive Transmission Strategy allows the transmission to relearn these operating parameters. This learning process could take several transmission upshifts and downshifts; during this learning process, slightly firmer shifts may occur. After this learning process, normal shift feel and shift scheduling will resume.

## Driving

### **P (Park)**

This position locks the transmission and prevents the rear wheels from turning.

To put your vehicle in gear:

- Start the engine
- Depress the brake pedal
- Move the gearshift lever into the desired gear

To put your vehicle in P (Park):

- Come to a complete stop
- Move the gearshift lever and securely latch it in P (Park)



Always set the parking brake fully and make sure the gearshift is latched in P (Park). Turn the ignition to the LOCK position and remove the key whenever you leave your vehicle.

### **R (Reverse)**

With the gearshift lever in R (Reverse), the vehicle will move backward. Always come to a complete stop before shifting into and out of R (Reverse).

### **N (Neutral)**

With the gearshift lever in N (Neutral), the vehicle can be started and is free to roll. Hold the brake pedal down while in this position.

### **Drive 5 (Overdrive)**

The normal driving position for the best fuel economy. Transmission operates in gears one through five.

### **Drive 4 (Overdrive cancelled)**

Activated when the transmission shift lever is moved to the D4 position.

- This position allows for all forward gears 1–4, except overdrive.
- Provides engine braking.
- Use when driving conditions cause excessive shifting from O/D to other gears. Examples: city traffic, hilly terrain, heavy loads and when engine braking is required.
- To return to D5 (overdrive mode), move the transmission shift lever into the D5 position.
- Select D4 at higher speeds will cause the transmission to downshift into fourth gear.

### **3 (Third)**

This position allows for third gear only.

- Provides engine braking.
- To return to D5 or D4, move the transmission shift lever into the D5 or D4 position.
- Selecting 3 (Third) at higher speeds will cause the transmission to downshift to third gear at the appropriate vehicle speed.

### **2 (Second)**

This position allows for second gear only.

- Provides engine braking.
- Use to start-up on slippery roads.
- To return to D5 or D4, move the transmission shift lever into the D5, D4 or 3 (Third) position.
- Selecting 2 (Second) at higher speeds will cause the transmission to downshift to second gear at the appropriate vehicle speed.

### **1 (First)**

This position allows for first gear only.

- Provides maximum engine braking.
- Will not downshift into first gear at high speeds; will cause the transmission to downshift to a lower gear, then allows for first gear when the vehicle reaches slower speeds.

### **Forced downshifts**

- Allowed in Overdrive or Drive.
- Depress the accelerator to the floor.
- Allows transmission to select an appropriate gear.

### ***Driving with a 5-speed automatic transmission with the Select Shift Transmission (SST) shifter (if equipped)***

#### ***Understanding gearshift positions***

The Select Shift Transmission (SST) shifter allows the driver to select between the transmission's automatic shift mode or the manually selected shift mode.

## Driving

### **Automatic shift mode**

Operates like a normal automatic transmission for P (Park), R (Reverse), N (Neutral), D5 and D4.

Refer to *Driving with a 5-speed automatic transmission* in this chapter for P (Park), R (Reverse), N (Neutral), D5 and D4 information.

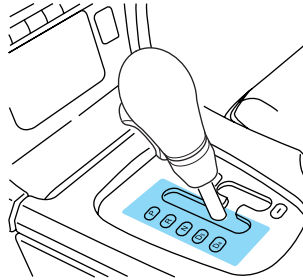

### **Manual shift mode**

With the gearshift lever in D5 (Overdrive), the gearshift lever can be moved to the right and into the manual shift mode. The transmission will remain in the manual shift mode until the gearshift lever is moved back to D5 (Overdrive).

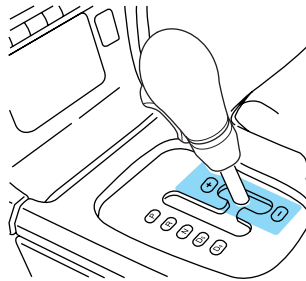

### **+ and - position operation**

These positions allow the driver to manually select the appropriate upshift (+) or downshift (-) and gear range.

- Can only be entered from the D5 position.
- Gear ranges 1-5 provide the same function and ratio as found in the D5 or D4 automatic mode positions.
- Transmission will not upshift or downshift unless the selector lever is moved forward or rearward.
- One tap forward (+) will **command** the transmission to upshift one gear range.

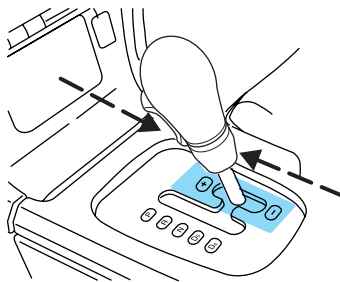

## Driving

- One tap rearward (-) will **command** the transmission to downshift one gear range.
- Upshifts are allowed at any vehicle speed, with the exception of 4th and 5th gear. The transmission will not do a 4th or 5th gear start. Ensure that the transmission is returned to 1st gear once the vehicle is stopped. If this is not done, and the transmission is in 2nd or 3rd gear, the vehicle will remain in that gear. However, if the transmission is in 4th or 5th gear, the transmission will automatically return to 1st gear.
- When downshifting at normal road speeds, the transmission will only allow a downshift into the **next lower** gear.
- If shifter (-) is tapped more than once in rapid succession, the transmission will downshift only into the next lower gear, then when the vehicle reaches a speed below a calibrated entry speed, the transmission will allow a downshift into the next lower gear if again selected by the driver. This is to prevent engine and transmission damage and to keep the engine and transmission within allowable RPM ranges.
- An electronic indicator on the instrument cluster will display the selected gear.

### **Recommended shift speeds**

Upshift according to the following chart:

| <b>Recommended upshift schedule</b> |                  |
|-------------------------------------|------------------|
| Shift from:                         |                  |
| 1 - 2                               | 15 mph (24 km/h) |
| 2 - 3                               | 25 mph (40 km/h) |
| 3 - 4                               | 40 mph (64 km/h) |
| 4 - 5                               | 45 mph (72 km/h) |

### **If your vehicle gets stuck in mud or snow**

If your vehicle gets stuck in mud or snow, it may be rocked out by shifting between forward and reverse gears, stopping between shifts in a steady pattern. Press lightly on the accelerator in each gear.

**Do not rock the vehicle if the engine is not at normal operating temperature or damage to the transmission may occur.**

**Do not rock the vehicle for more than a minute or damage to the transmission and tires may occur, or the engine may overheat.**

## Driving

### REAR PARK ASSIST (IF EQUIPPED)

The rear park assist system sounds a tone to warn the driver of obstacles near the rear bumper when the R (Reverse) gear is selected.



To help avoid personal injury, please read and understand the limitations of the rear park assist system as contained in this section. The park assist is only an aid for some (generally large and fixed) objects when moving in reverse on a flat surface at “parking speeds”. Inclement weather may also affect the function of the system; this may include reduced performance or a false activation.



To help avoid personal injury, always use caution when in R (Reverse) and when using the rear park assist.



This system is not designed to prevent contact with small or moving objects. The system is designed to provide a warning to assist the driver in detecting objects to avoid damaging the vehicle. The system may not detect smaller objects, particularly those close to the ground.



Certain add-on devices such as large trailer hitches, bike or surfboard racks and any device that may block the normal detection zone of the Rear Park Assist system may create false beeps.

The system will assist the driver in detecting certain objects while the vehicle slowly moves in reverse at speeds less than 6 mph (10 km/h). The system is not effective at speeds greater than 6 mph (10 km/h) and may not detect certain angular or moving objects.



## Driving

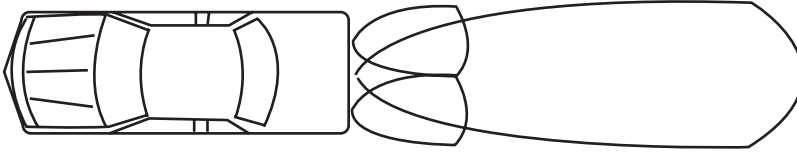

The system detects obstacles within approximately 16 feet (5 meters), at speeds above 2 mph [3 km/h]), behind the rear bumper with a decreased coverage area at the outer corners of the bumper. If the vehicle speed is below 2 mph [3 km/h]), the system will detect objects up to 10 feet (3 meters) behind the vehicle with a decreased coverage area at the outer corners of the bumper. In the figure, the smaller objects behind the vehicle represent the near-vehicle and bumper corner coverage area of the park aid system and the large object represents the extended coverage area. As you move closer to the obstacle, the rate of the tone increases. When the distance to the obstacle is less than 18 inches (45.0 cm), the tone will sound continuously. If the system detects an object that is approaching the vehicle at such as rate that rapid braking is required, a very high rate tone will sound. If this tone is heard while reversing, the driver is advised to slow down immediately until the tone either changes to a slower rate or stops. While receiving a warning the radio volume will be reduced to a predetermined level. After the warning goes away, the radio will return to the previous volume. The radio volume may be overridden using the radio volume control.

The rear park assist is automatically enabled when the gear selector is placed in R (Reverse) and the ignition is ON. A park assist control allows the driver to disable the system only when the ignition is ON, and the gear selector is in R (Reverse).

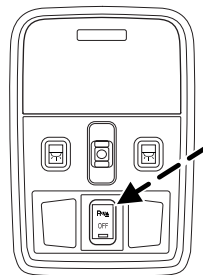

The OFF indicator remains illuminated when the system is disabled. Press the control to disable or enable the system. Once disabled, the system will remain disabled until the control is pressed or until the next ignition cycle.

The indicator will remain illuminated to indicate a failure of the rear park assist.

## Driving

**Always keep the sensors (located on the rear bumper/fascia) free from snow, ice and large accumulations of dirt (do not clean the sensors with sharp objects). These elements may cause the system to operate inaccurately.**

**If the vehicle sustains damage to the rear bumper/fascia, leaving it misaligned or bent, the sensing zone may be altered causing inaccurate measurement of obstacles or false alarms.**

### DRIVING THROUGH WATER

If driving through deep or standing water is unavoidable, proceed very slowly especially when the depth is not known. Never drive through water that is higher than the bottom of the hubs (for trucks) or the bottom of the wheel rims (for cars). When driving through water, traction or brake capability may be limited. Also, water may enter your engine's air intake and severely damage your engine or your vehicle may stall. **Driving through deep water where the transmission vent tube is submerged may allow water into the transmission and cause internal transmission damage.**

**Once through the water, always dry the brakes by moving your vehicle slowly while applying light pressure on the brake pedal.** Wet brakes do not stop the vehicle as quickly as dry brakes.

### VEHICLE LOADING – WITH AND WITHOUT A TRAILER

This section will guide you in the proper loading of your vehicle and/or trailer, to keep your loaded vehicle weight within its design rating capability, with or without a trailer. Properly loading your vehicle will provide maximum return of vehicle design performance. Before loading your vehicle, familiarize yourself with the following terms for determining your vehicle's weight ratings, with or without a trailer, from the vehicle's Safety Certification Label and Tire Label:

**Base Curb Weight** – is the weight of the vehicle including a full tank of fuel and all standard equipment. It does not include passengers, cargo, or optional equipment.

**Vehicle Curb Weight** – is the weight of your new vehicle when you picked it up from your dealer plus any aftermarket equipment.



**Cargo Weight** – includes all weight added to the Base Curb Weight, including cargo and optional equipment. When towing, trailer tongue load or king pin weight is also part of cargo weight.

**GAW (Gross Axle Weight)** – is the total weight placed on each axle (front and rear) – including vehicle curb weight and all payload.

**GAWR (Gross Axle Weight Rating)** – is the maximum allowable weight that can be carried by a single axle (front or rear). **These numbers are shown on the Safety Compliance Certification Label located on the driver's door or door pillar. The total load on each axle must never exceed its GAWR.**



Exceeding the Safety Certification Label axle weight rating limits could result in substandard vehicle handling, performance, engine, transmission and/or structural damage, serious damage to the vehicle, loss of control and personal injury.

**Note:** For trailer towing information refer to *Trailer towing* found in this chapter or the *RV and Trailer Towing Guide* provided by your dealership.

## Driving

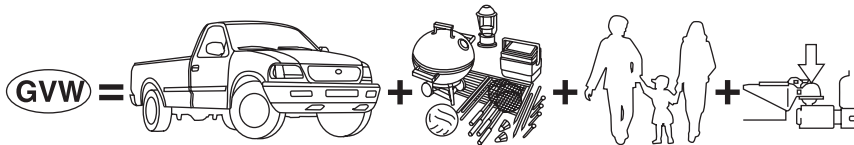

**GVW (Gross Vehicle Weight)** – is the Vehicle Curb Weight + cargo + passengers.

**GVWR (Gross Vehicle Weight Rating)** – is the maximum allowable weight of the fully loaded vehicle (including all options, equipment, passengers and cargo). **The GVWR is shown on the Safety Compliance Certification Label located on the driver's door or door pillar. The GVW must never exceed the GVWR.**

| Sample Safety Compliance Certification Label<br><small>(Refer to actual label on your vehicle)</small>                           |                         |                    |         |
|--|-------------------------|--------------------|---------|
| Front GAWR   | GVWR                    | Rear GAWR          |         |
| <b>MFD. BY FORD MOTOR CO. IN U.S.A.</b>  |                         |                    |         |
| DATE: 06/95  | GVWR: 6250 LB/2834 KG   |                    |         |
| FRONT GAWR: 3450 LB<br>1564KG  | WITH 1713KG             | REAR GAWR: 3777 LB | WITH    |
| P265/75R15SL   | TIRES P265/75R15SL      |                    | TIRES   |
| 15X7.5J  | RIMS 15X7.5J            |                    | RIMS    |
| AT 30 PSI COLD   | AT 30 PSI COLD          |                    |         |
| THIS VEHICLE CONFORMS TO ALL APPLICABLE FEDERAL MOTOR VEHICLE SAFETY STANDARDS IN EFFECT ON THE DATE OF MANUFACTURE SHOWN ABOVE. |                         |                    |         |
| XXXXXXXXXXXX   | VIN: 1FTEX14H0SKB 00000 |                    | F0018   |
| TYPE: XXXXXXXXXXXX   |                         |                    | TC183   |
|  |                         |                    |         |
| EXT PNT: XXXXXXXX  |                         |                    | DSO     |
| WD   | TYPE-GVW                | BODY               | TRANS   |
| 155  |                         | REM                | E       |
|  |                         |                    | HB      |
|  |                         |                    | TAPE    |
|  |                         |                    | SPRINGS |
|  |                         |                    | MM      |



Exceeding the Safety Certification Label axle weight rating limits could result in substandard vehicle handling, performance, engine, transmission and/or structural damage, serious damage to the vehicle, loss of control and personal injury.



**GCW (Gross Combined Weight)** – is the weight of the loaded vehicle (GVW) plus the weight of the fully loaded trailer.

**GCWR (Gross Combined Weight Rating)** – is the maximum allowable weight of the vehicle and the loaded trailer – including all cargo and passengers – that the vehicle can handle without risking damage. (Important: The towing vehicle's braking system is rated for operation at GVWR, not at GCWR. Separate functional brakes should be used for safe control of towed vehicles and for trailers where the GCW of the towing vehicle plus the trailer exceed the GVWR of the towing vehicle. **The GCW must never exceed the GCWR.**

**Maximum Loaded Trailer Weight** – is the highest possible weight of a fully loaded trailer the vehicle can tow. It assumes a vehicle with only mandatory options, no cargo (internal or external), a tongue load of 10–15% (conventional trailer) or king pin weight of 15–25% (fifth wheel trailer), and driver only (150 lbs [68 kg]). **Consult your dealership (or the *RV and Trailer Towing Guide* provided by your dealership) for more detailed information.**

**Tongue Load or Fifth Wheel King Pin Weight** – refers to the amount of the weight that a trailer pushes down on a trailer hitch.

**Examples:** For a 5,000 lbs. (2,268 kg) conventional trailer, multiply 5,000 by 0.10 and 0.15 to obtain a proper tongue load range of 500 to 750 lbs. (227 to 340 kg). For an 11,500 lbs. (5,216 kg) fifth wheel trailer, multiply by 0.15 and 0.25 to obtain a proper king pin load range of 1,725 to 2,875 lbs. (782 to 1,304 kg)



Do not exceed the GVWR or the GAWR specified on the certification label.



Do not use replacement tires with lower load carrying capacities than the originals because they may lower the vehicle's GVWR and GAWR limitations. Replacement tires with a higher limit than the originals do not increase the GVWR and GAWR limitations.

## Driving



Exceeding any vehicle weight rating limitation could result in serious damage to the vehicle and/or personal injury.

### TRAILER TOWING

Your vehicle is not equipped to tow. No towing packages are available through Ford or Lincoln/Mercury dealers.

### RECREATIONAL TOWING (ALL WHEELS ON THE GROUND)

Follow these guidelines for your specific powertrain combination to tow your vehicle with all four wheels on the ground (such as behind a recreational vehicle).

These guidelines are designed to ensure that your transmission is not damaged due to insufficient lubrication.

#### **All Rear Wheel Drive (RWD) vehicles:**

This applies to all cars and 4x2 trucks/sport utilities with rear wheel drive capability.

- Place the transmission in N (Neutral)
- Maximum speed is 35 mph (56 km/h)
- Maximum distance is 50 miles (80 km)

If a distance of 50 miles (80 km) or a speed of 35 mph (56 km/h) must be exceeded, you must disconnect the driveshaft.

**Ford recommends the driveshaft be removed/installed only by a qualified technician. Improper removal/installation of the driveshaft may cause damage to the driveshaft and internal transmission components.** See your local dealer for driveshaft removal/installation.

## Roadside Emergencies

### GETTING ROADSIDE ASSISTANCE

To fully assist you should you have a vehicle concern, Ford Motor Company offers a complimentary roadside assistance program. This program is separate from the New Vehicle Limited Warranty. The service is available:

- 24-hours, seven days a week
- for the New Vehicle Limited Warranty period of three years or 36,000 miles (60,000 km), whichever occurs first on Ford and Mercury vehicles, and four years or 50,000 miles (80,000 km) on Lincoln vehicles.

Roadside assistance will cover:

- changing a flat tire
- jump-starts
- lock-out assistance
- limited fuel delivery
- towing of your disabled vehicle to the nearest Ford Motor Company dealership, or your selling dealer if within 35 miles (56.3 km) of the nearest Ford Motor Company dealership (one tow per disablement). Even non-warranty related tows, like accidents or getting stuck in the mud or snow, are covered (some exclusions apply, such as impound towing or repossession).

### Canadian customers refer to your Owner Information Guide for information on:

- coverage period
- exact fuel amounts
- towing of your disabled vehicle
- emergency travel expense reimbursement
- travel planning benefits

### USING ROADSIDE ASSISTANCE

Complete the roadside assistance identification card and place it in your wallet for quick reference. In the United States, this card is found in the Owner Guide portfolio in the glove compartment in Ford vehicles and is mailed to you if you own a Mercury or Lincoln. In Canada, the card is found in the *Owner Information Guide* in the glove compartment.

U.S. Ford or Mercury vehicle customers who require roadside assistance, call 1-800-241-3673; Lincoln vehicle customers call 1-800-521-4140.

## Roadside Emergencies

Canadian customers who require roadside assistance, call 1-800-665-2006.

If you need to arrange roadside assistance for yourself, Ford Motor Company will reimburse a reasonable amount. To obtain reimbursement information, U.S. Ford or Mercury vehicles customers call 1-800-241-3673; Lincoln vehicle customers call 1-800-521-4140.

Canadian customers who need to obtain reimbursement information, call 1-800-665-2006.

### ROADSIDE COVERAGE BEYOND BASIC WARRANTY

In the United States, you may purchase additional roadside assistance coverage beyond this period through the Ford Auto Club by contacting your Ford or Lincoln Mercury dealer.

Similarly in Canada, for uninterrupted Roadside Assistance coverage, you may purchase extended coverage prior to your Basic Warranty's Roadside Assistance expiring. For more information and enrollment, contact 1-877-294-2582 or visit our website at [www.ford.ca](http://www.ford.ca).

### HAZARD FLASHER

The hazard flasher is located on the steering column, just behind the steering wheel. The hazard flashers will operate when the ignition is in any position or if the key is not in the ignition.

Push in the flasher control and all front and rear direction signals will flash. Press the flasher control again to turn them off. Use it when your vehicle is disabled and is creating a safety hazard for other motorists.

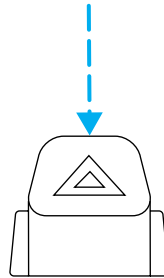

**Note:** With extended use, the flasher may run down your battery.

### FUEL PUMP SHUT-OFF SWITCH FUEL RESET

This device stops the electric fuel pump from sending fuel to the engine when your vehicle has had a substantial jolt.

After an accident, if the engine cranks but does not start, this switch may have been activated.



## Roadside Emergencies

This switch is located in the driver's footwell, behind the kick panel.

To reset the switch:

1. Turn the ignition OFF.
2. Check the fuel system for leaks.
3. If no leaks are apparent, reset the switch by pushing in on the reset button.
4. Turn the ignition ON.
5. Wait a few seconds and return the key to OFF.
6. Make another check for leaks.

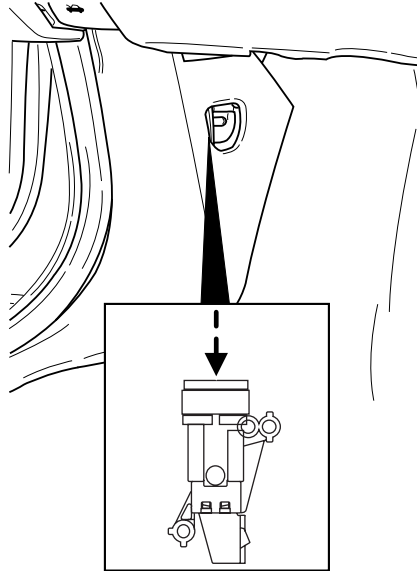

## FUSES AND RELAYS

### Fuses

If electrical components in the vehicle are not working, a fuse may have blown. Blown fuses are identified by a broken wire within the fuse. Check the appropriate fuses before replacing any electrical components.

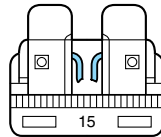

**Note:** Always replace a fuse with one that has the specified amperage rating. Using a fuse with a higher amperage rating can cause severe wire damage and could start a fire.

## Roadside Emergencies

### *Standard fuse amperage rating and color*

| COLOR       |            |                |            |                      |                     |
|-------------|------------|----------------|------------|----------------------|---------------------|
| Fuse rating | Mini fuses | Standard fuses | Maxi fuses | Cartridge maxi fuses | Fuse link cartridge |
| 2A          | Grey       | Grey           | —          | —                    | —                   |
| 3A          | Violet     | Violet         | —          | —                    | —                   |
| 4A          | Pink       | Pink           | —          | —                    | —                   |
| 5A          | Tan        | Tan            | —          | —                    | —                   |
| 7.5A        | Brown      | Brown          | —          | —                    | —                   |
| 10A         | Red        | Red            | —          | —                    | —                   |
| 15A         | Blue       | Blue           | —          | —                    | —                   |
| 20A         | Yellow     | Yellow         | Yellow     | Blue                 | Blue                |
| 25A         | Natural    | Natural        | —          | —                    | —                   |
| 30A         | Green      | Green          | Green      | Pink                 | Pink                |
| 40A         | —          | —              | Orange     | Green                | Green               |
| 50A         | —          | —              | Red        | Red                  | Red                 |
| 60A         | —          | —              | Blue       | —                    | Yellow              |
| 70A         | —          | —              | Tan        | —                    | Brown               |
| 80A         | —          | —              | Natural    | —                    | Black               |

### **Passenger compartment fuse panel**

The fuse panel is located on the right-hand side kick panel. Remove the panel cover to access the fuses.

To remove a fuse use the fuse puller tool provided on the fuse panel cover.

## Roadside Emergencies

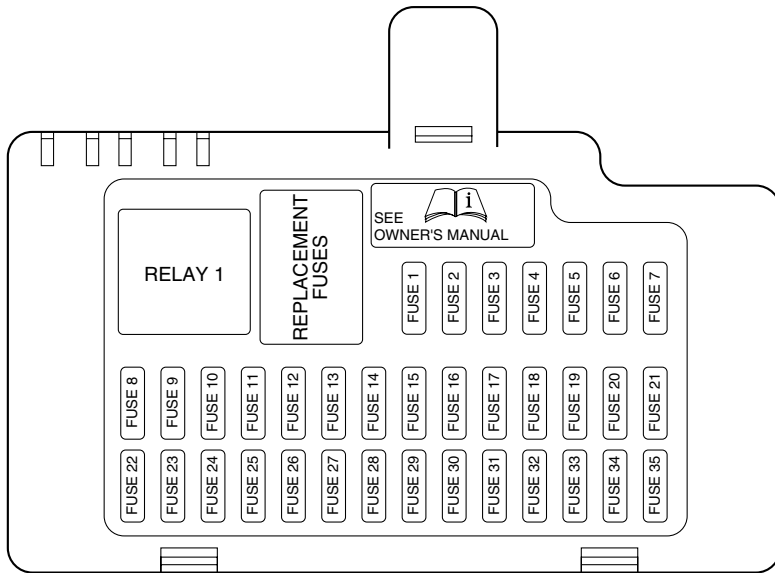

The fuses are coded as follows.

| Fuse/Relay Location | Fuse Amp Rating | Passenger Compartment Fuse Panel Description                                   |
|---------------------|-----------------|--|
| 1                   | 5A              | Starter relay coil   |
| 2                   | 5A              | Radio  |
| 3                   | 5A              | ABS/TCS/AdvanceTrac <sup>™</sup>   |
| 4                   | 5A              | Cluster, Powertrain Control Module (PCM) relay, Fuel pump relay, REM           |
| 5                   | 10A             | Restraints Control Module (RCM)  |
| 6                   | 10A             | OBD II   |
| 7                   | 5A              | DDM, DSM, Anti-theft LED, Power mirror switch, Electric Park Brake switch, PCM |
| 8                   | 5A              | Right front turn, Right front sidemarker, Right front park lamps               |
| 9                   | 15A             | Right front low beam/HID   |

## Roadside Emergencies

| Fuse/Relay Location | Fuse Amp Rating | Passenger Compartment Fuse Panel Description                  |
|---------------------|-----------------|---|
| 10                  | 5A              | Left front turn, Left front sidemarker, Left front park lamps |
| 11                  | 10A             | Left front high beam  |
| 12                  | 5A              | Electrochromic mirror   |
| 13                  | 5A              | Cluster   |
| 14                  | 5A              | DATC  |
| 15                  | 5A              | O/D cancel, ABS/Traction-Assist switch                        |
| 16                  | 5A              | Heated seat controls, Climate control seat module             |
| 17                  | 5A              | RCM, Alternator warning lamp                                  |
| 18                  | 20A             | Radio, CIA, Navigation unit                                   |
| 19                  | 15A             | Tilt/Tele motors  |
| 20                  | 10A             | FEM, DATC, Cluster, REM                                       |
| 21                  | 7.5A            | Not used (spare)  |
| 22                  | 10A             | DDM, Driver door mirror                                       |
| 23                  | 10A             | Right front high beam   |
| 24                  | 5A              | PATS  |
| 25                  | 15A             | Left front low beam/HID                                       |
| 26                  | 5A              | Wiper module  |
| 27                  | 10A             | Radio, Navigation unit  |
| 28                  | 5A              | Not Used (spare)  |
| 29                  | 5A              | FEM, Reverse park assist                                      |
| 30                  | 5A              | FEM, Passenger power mirror                                   |
| 31                  | —               | Not used  |
| 32                  | 20A             | Cigar lighter   |
| 33                  | 10A             | Switch backlighting, FEM                                      |
| 34                  | 10A             | Not used (spare)  |
| 35                  | 5A              | Stop lamp signal  |

## Roadside Emergencies

### Front power distribution box

The front power distribution box is located in the engine compartment. The power distribution box contains high-current fuses that protect your vehicle's main electrical systems from overloads.

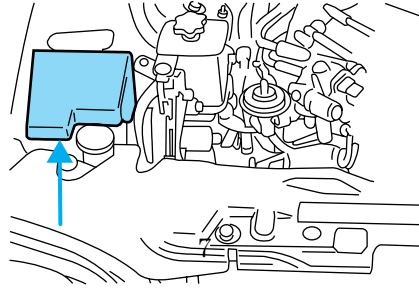

Always disconnect the battery before servicing high current fuses.



To reduce risk of electrical shock, always replace the cover to the Power Distribution Box before reconnecting the battery or refilling fluid reservoirs.

If the battery has been disconnected and reconnected, refer to the *Battery* section of the *Maintenance and specifications* chapter.

## Roadside Emergencies

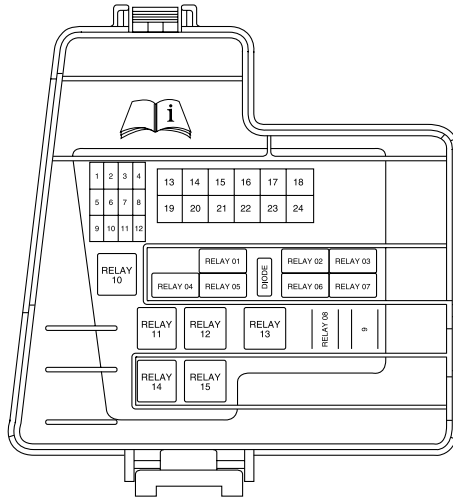

The high-current fuses are coded as follows.

| Fuse/Relay Location | Fuse Amp Rating | Power Distribution Box Description                               |
|---------------------|-----------------|--|
| 1                   | 10A*            | A/C clutch, Coolant control valve, Auxiliary coolant pump        |
| 2                   | —               | Not used   |
| 3                   | 15A*            | Fog lamp   |
| 4                   | 20A*            | Horn   |
| 5                   | 15A*            | Fuel injectors, Electric cooling fan, Mass Air Flow (MAF) sensor |
| 6                   | 15A*            | Transmission solenoid, EGR                                       |
| 7                   | —               | Not used   |
| 8                   | —               | Not used   |
| 9                   | —               | Not used   |
| 10                  | —               | Not used   |
| 11                  | 15A*            | HEGOs  |
| 12                  | 15A*            | Coil-on-plug   |

## Roadside Emergencies

| Fuse/Relay Location           | Fuse Amp Rating | Power Distribution Box Description  |
|-------------------------------|-----------------|-------------------------------------|
| 13                            | 30A**           | Heated wiper park                   |
| 14                            | 30A**           | ABS module                          |
| 15                            | —               | Not used                            |
| 16                            | 30A**           | Blower motor                        |
| 17                            | —               | Not used                            |
| 18                            | —               | Not used                            |
| 19                            | 30A**           | Electric park brake                 |
| 20                            | 30A**           | Wiper motor                         |
| 21                            | 30A**           | Starter solenoid                    |
| 22                            | 40A**           | ABS motor                           |
| 23                            | —               | Not used                            |
| 24                            | —               | Not used                            |
| Relay 01                      | —               | Not used                            |
| Relay 02                      | —               | Not used                            |
| Relay 03                      | —               | Coil-on-plug and HEGOs              |
| Relay 04                      | —               | Right-hand HID headlamps            |
| Relay 05                      | —               | Auxiliary coolant pump (V8 engines) |
| Relay 06                      | —               | Left-hand HID headlamps             |
| Relay 07                      | —               | Fog lamps                           |
| Relay 08                      | —               | A/C clutch                          |
| Fuse 09                       | —               | Not used                            |
| Relay 10                      | —               | Blower motor                        |
| Relay 11                      | —               | Not used                            |
| Relay 12                      | —               | Heated wiper park                   |
| Relay 13                      | —               | Horn                                |
| Relay 14                      | —               | PCM power                           |
| Relay 15                      | —               | Starter motor                       |
| Diode                         | —               | PCM                                 |
| *Mini fuses **Cartridge fuses |                 |                                     |

## Roadside Emergencies

### ***In-line fuse for electric cooling fan***

There is a 60A maxi fuse for the electric cooling fan located in a wiring harness behind the front passenger side trim panel under the dash panel. The trim panel must be removed and the carpet on the front passenger side must be lifted to access this fuse. See a qualified technician to have this fuse replaced, if necessary.

### **Rear power distribution box**

The rear power distribution box is located in the luggage compartment under the spare tire well cover. The power distribution box contains high-current fuses that protect your vehicle's main electrical systems from overloads.

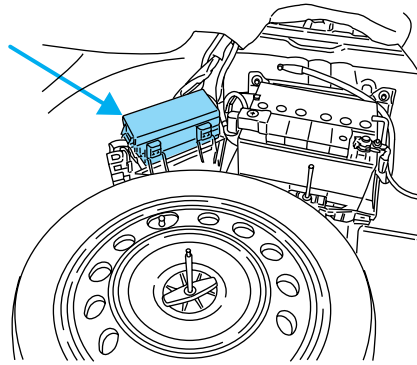

Always disconnect the battery before servicing high current fuses.



To reduce risk of electrical shock, always replace the cover to the Power Distribution Box before reconnecting the battery or refilling fluid reservoirs.

If the battery has been disconnected and reconnected, refer to the *Battery* section of the *Maintenance and specifications* chapter.



## Roadside Emergencies

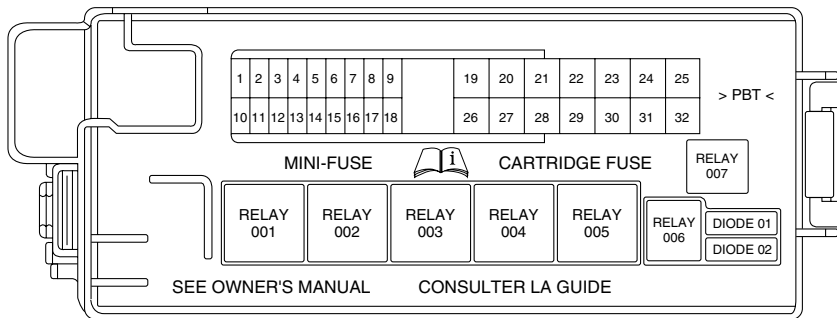

The high-current fuses are coded as follows.

| Fuse/Relay Location | Fuse Amp Rating | Power Distribution Box Description                   |
|---------------------|-----------------|--|
| 1                   | 15A*            | Decklid release solenoid, Passenger door lock motors |
| 2                   | 10A*            | Right rear turn lamp, License plate lamp             |
| 3                   | 5A*             | Left rear stop/tail lamp                             |
| 4                   | 10A*            | Fuel door release solenoid, Decklid lamp             |
| 5                   | 10A*            | Courtesy and map lamps, Radio antenna module         |
| 6                   | 10A*            | Left rear turn and back-up lamps                     |
| 7                   | 5A*             | Right rear stop/tail lamp                            |
| 8                   | 5A*             | Center high-mounted stop lamp                        |
| 9                   | 5A*             | Heated mirror  |
| 10                  | 20A*            | Power point - console                                |
| 11                  | 20A*            | Rear heated seats                                    |
| 12                  | 20A*            | Power point - ashtray                                |
| 13                  | —               | Not used   |
| 14                  | 10A*            | Navigation unit                                      |
| 15                  | 5A*             | Alternator sense                                     |
| 16                  | 20A*            | Moonroof   |

## Roadside Emergencies

| Fuse/Relay Location      | Fuse Amp Rating | Power Distribution Box Description |
|--------------------------|-----------------|------------------------------------|
| 17                       | 15A*            | Fuel pump motor                    |
| 18                       | 20A*            | Subwoofer amp                      |
|                          | 30A*            | THX amp, Subwoofer amp             |
| 19                       | 20A**           | REM - Left rear window             |
| 20                       | 30A**           | Front window motors                |
| 21                       | 20A**           | Driver lumbar, Power seats         |
| 22                       | 20A**           | Ignition switch                    |
| 23                       | 30A**           | SSP4                               |
| 24                       | 30A**           | SSP3                               |
| 25                       | 40A**           | P-J/B                              |
| 26                       | 30A**           | Climate control seat module        |
| 27                       | 30A**           | SSP1                               |
| 28                       | 20A**           | Passenger lumbar, Power seats      |
| 29                       | 40A**           | Rear defroster                     |
| 30                       | 20A**           | REM - Right rear window            |
| 31                       | 30A**           | Powertrain main power              |
| 32                       | 30A**           | SSP2                               |
| Relay 001                | —               | SSP1                               |
| Relay 002                | —               | SSP4                               |
| Relay 003                | —               | Rear defroster                     |
| Relay 004                | —               | SSP3                               |
| Relay 005                | —               | SSP2                               |
| Relay 006                | —               | Not used                           |
| Relay 007                | —               | Fuel pump motor                    |
| Diode 01                 | —               | Not used                           |
| Diode 02                 | —               | Fuel pump motor                    |
| *Mini fuses **Maxi fuses |                 |                                    |

## Roadside Emergencies

### CHANGING THE TIRES

If you get a flat tire while driving, do not apply the brake heavily. Instead, gradually decrease your speed. Hold the steering wheel firmly and slowly move to a safe place on the side of the road.



The use of tire sealants is not recommended and may damage your tires.

### T-Type/Mini-Spare Tire Information

Your vehicle may be equipped with a T-type/mini-spare tire or a full-size spare tire. The T-type/mini-spare tire will have the words “Temporary Use Only” molded into the tire sidewall. This spare tire is considered “temporary”. Replace the T-type/mini-spare with a tire of the same size, speed rating and load carrying capacity as the other road tires as soon as possible.

When driving with the T-type/mini-spare tire **do not:**

- Exceed 50 mph (80 km/h)
- Load the vehicle beyond maximum vehicle load rating listed on the Safety Compliance Label
- Tow a trailer
- Use snow chains on the end of the vehicle with the T-type/mini spare tire
- Use more than one T-type/mini spare tire at a time
- Use commercial car washing equipment
- Try to repair the T-type/mini spare tire

Use of a T-type/mini spare tire at any one wheel location can lead to impairment of the following:

- Handling, stability and braking performance
- Comfort and noise
- Ground clearance and parking at curbs
- Winter weather driving capability
- Wet weather driving capability

## Roadside Emergencies

### Dissimilar spare tire/wheel information



Failure to follow these guidelines could result in an increased risk of loss of vehicle control, injury or death.

Your vehicle may be equipped with a dissimilar spare tire/wheel. A dissimilar spare tire/wheel is defined as a spare tire and/or wheel that is different in brand, size or appearance from the road tires and wheels. If you have a dissimilar spare tire/wheel, then it is intended for temporary use only. This means that if you need to use it, you should replace it as soon as possible with a road tire/wheel that is the same size and type as the road tires and wheels that were originally provided by Ford. If the dissimilar spare tire or wheel is damaged, it should be replaced rather than repaired.

When driving with the dissimilar spare tire/wheel, **do not:**

- Exceed 70 mph (113 km/h)
- Use more than one dissimilar spare tire/wheel at a time
- Use commercial car washing equipment
- Use snow chains on the end of the vehicle with the dissimilar spare tire/wheel

The usage of a dissimilar spare tire/wheel can lead to impairment of the following:

- Handling, stability and braking performance
- Comfort and noise
- Ground clearance and parking at curbs
- Winter weather driving capability
- Wet weather driving capability
- All-Wheel Driving Capability (if applicable)
- Load Leveling Adjustment (if applicable)

When driving with the dissimilar spare tire/wheel additional caution should be given to:

- Towing a trailer
- Driving vehicles equipped with a camper body
- Driving vehicles with a load on the cargo rack

Drive cautiously when using a dissimilar spare tire/wheel and seek service as soon as possible.

## Roadside Emergencies

### Tire change procedure

 To help prevent the vehicle from moving when you change a tire, be sure the parking brake is set, then block (in both directions) the wheel that is diagonally opposite (other side and end of the vehicle) to the tire being changed.

 If the vehicle slips off the jack, you or someone else could be seriously injured.

1. Park on a level surface, activate hazard flashers and set parking brake.
2. Place gearshift lever in P (Park), turn engine OFF, and block the diagonally opposite wheel.
3. Lift the trunk cargo cover and remove the spare tire, jack and lug wrench.

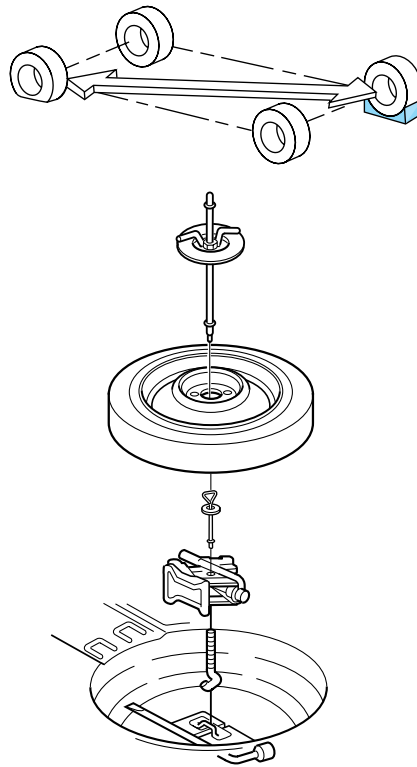

## Roadside Emergencies

4. Loosen each wheel lug nut one-half turn counterclockwise but do not remove them until the wheel is raised off the ground.

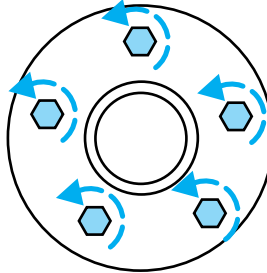

5. Put the jack in the jack notch next to the tire you are changing. Turn the jack handle clockwise until the wheel is completely off the ground.

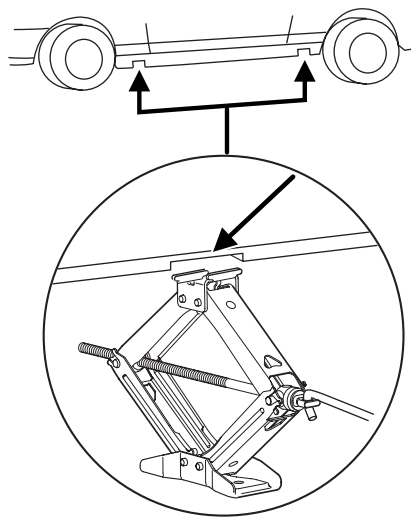

## Roadside Emergencies

### Never use the rear differential as a jacking point.

 To lessen the risk of personal injury, do not put any part of your body under the vehicle while changing a tire. Do not start the engine when your vehicle is on the jack. The jack is only meant for changing the tire.

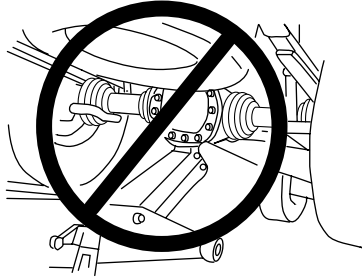

6. Remove the lug nuts with the lug wrench.
7. Replace the flat tire with the spare tire, making sure the valve stem is facing outward. Reinstall lug nuts until the wheel is snug against the hub. Do not fully tighten the lug nuts until the wheel has been lowered.
8. Lower the wheel by turning the jack handle counterclockwise.
9. Remove the jack and fully tighten the lug nuts in the order shown. Refer to *Wheel lug nut torque specifications* later in this chapter for the proper lug nut torque specification.
10. Put flat tire, jack and lug wrench away. Make sure jack is fastened so it does not rattle when you drive.
11. Unblock the wheels.

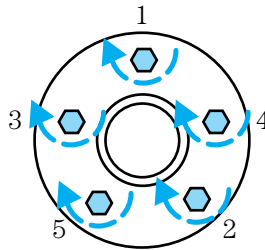

## Roadside Emergencies

### Wheel lug nut torque specifications

Retighten the lug nuts to the specified torque at 500 miles (800 km) after any wheel disturbance (tire rotation, changing a flat tire, wheel removal, etc.).

| Bolt size | Wheel lug nut torque* |     |
|-----------|-----------------------|-----|
|           | lb.ft.                | N•m |
| M12 x 1.5 | 100                   | 135 |

\* Torque specifications are for nut and bolt threads free of dirt and rust. Use only Ford recommended replacement fasteners.



When a wheel is installed, always remove any corrosion, dirt or foreign materials present on the mounting surfaces of the wheel or the surface of the front disc brake hub and rotor that contacts the wheel. Installing wheels without correct metal-to-metal contact at the wheel mounting surfaces can cause the wheel nuts to loosen and the wheel to come off while the vehicle is in motion, resulting in loss of control.

### JUMP STARTING YOUR VEHICLE



The gases around the battery can explode if exposed to flames, sparks, or lit cigarettes. An explosion could result in injury or vehicle damage.



Batteries contain sulfuric acid which can burn skin, eyes and clothing, if contacted.

**Do not attempt to push-start your vehicle. Automatic transmissions do not have push-start capability; doing so may damage the catalytic converter.**



## Roadside Emergencies

### Preparing your vehicle

Your battery is located in the trunk of your vehicle.

When the battery is disconnected or a new battery is installed, the transmission must relearn its shift strategy. As a result, the transmission may have firm and/or soft shifts. This operation is considered normal and will not affect function or durability of the transmission. Over time, the adaptive learning process will fully update transmission operation to its optimum shift feel.

1. **Use only a 12-volt supply to start your vehicle.**
2. Do not disconnect the battery of your disabled vehicle as this could damage the vehicle's electrical system. Keep the battery vent hose attached at all times.
3. Park the booster vehicle close to the trunk of your disabled vehicle making sure the two vehicles **do not** touch. Set the parking brake on both vehicles and stay clear of the engine cooling fan and other moving parts.
4. Check all battery terminals and remove any excessive corrosion before you attach the battery cables. Ensure the vent caps are tight and level.
5. Turn the heater fan on in both vehicles to protect any electrical surges. Turn all other accessories off.

### Connecting the jumper cables

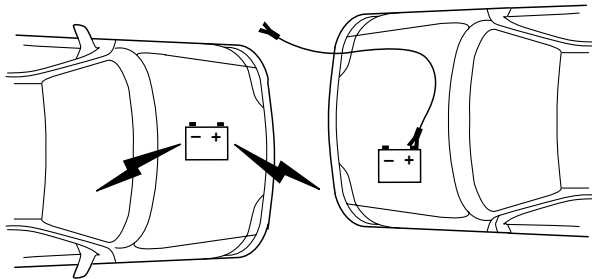

1. Connect the positive (+) jumper cable to the positive (+) terminal of the discharged battery.

**Note:** In the illustrations, *lightning bolts* are used to designate the assisting (boosting) battery.

## Roadside Emergencies

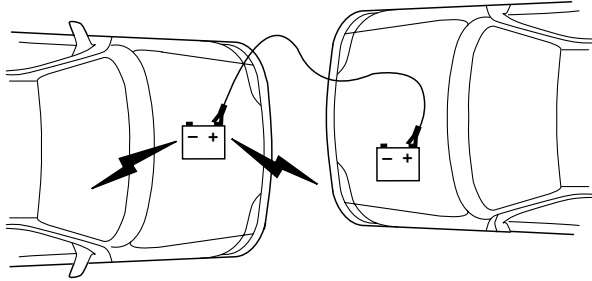

2. Connect the other end of the positive (+) cable to the positive (+) terminal of the assisting battery.

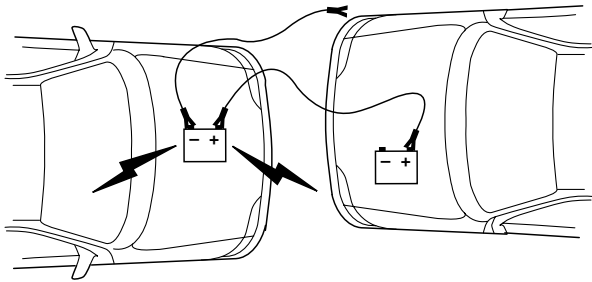

3. Connect the negative (-) cable to the negative (-) terminal of the assisting battery.

## Roadside Emergencies

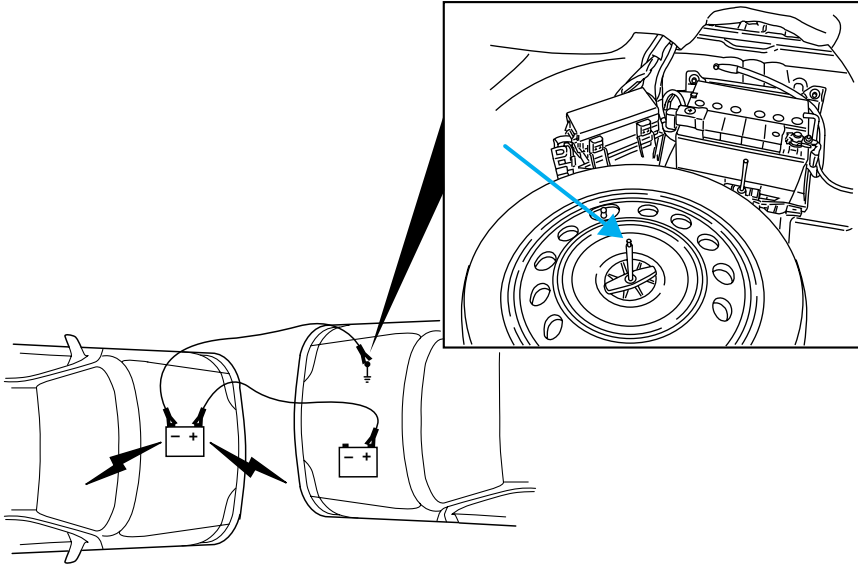

4. Make the final connection of the negative (-) cable to the spare tire tie-down stud. (Your vehicle may be equipped with a plastic cap on top of the tire tie-down stud. This cap must be removed prior to attaching the cable to the stud.)



Do not connect the end of the second cable to the negative (-) terminal of the battery to be jumped. A spark may cause an explosion of the gases that surround the battery.

5. Ensure that the cables are clear of fan blades, belts, moving parts of both engines, or any fuel delivery system parts.

### **Jump starting**

1. Start the engine of the booster vehicle and run the engine at moderately increased speed.
2. Start the engine of the disabled vehicle.
3. Once the disabled vehicle has been started, run both engines for an additional three minutes before disconnecting the jumper cables.

## Roadside Emergencies

### Removing the jumper cables

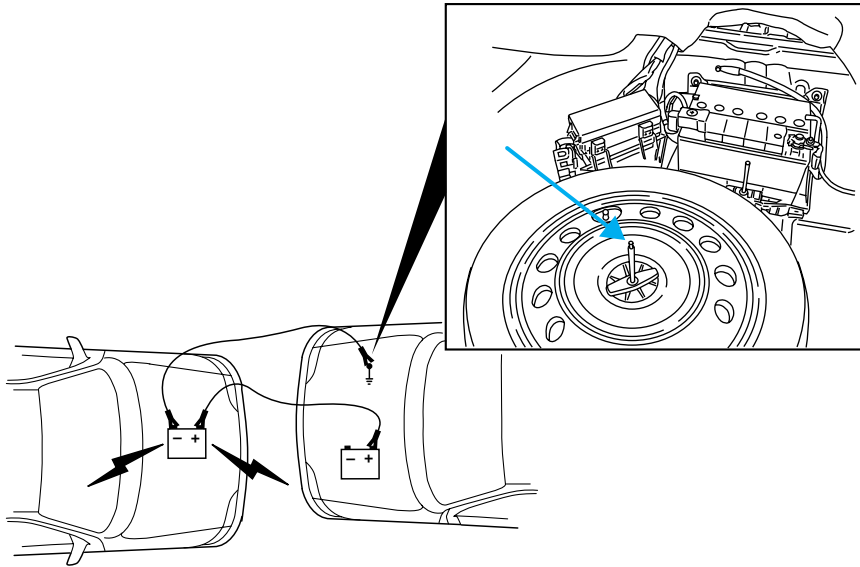

**Remove the jumper cables in the reverse order that they were connected.**

1. Remove the jumper cable from the spare tire tie-down stud.

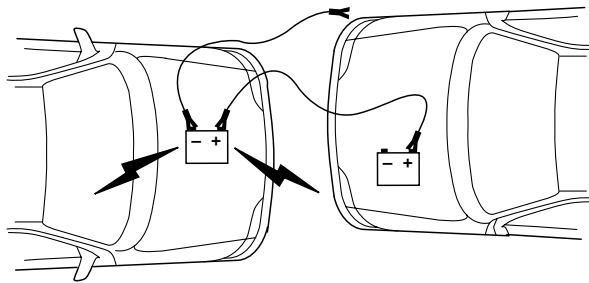

2. Remove the jumper cable on the negative (-) connection of the booster vehicle's battery.

## Roadside Emergencies

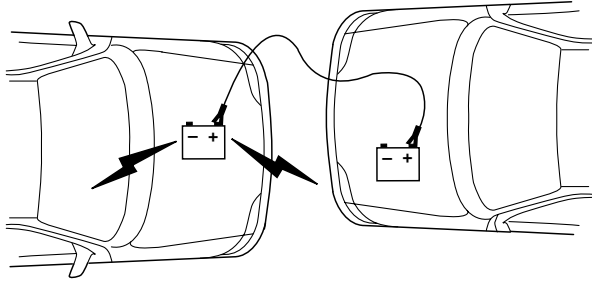

3. Remove the jumper cable from the positive (+) terminal of the booster vehicle's battery.

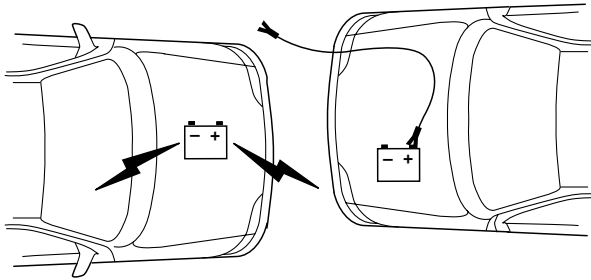

4. Remove the jumper cable from the positive (+) terminal of the disabled vehicle's battery.

After the disabled vehicle has been started and the jumper cables removed, allow it to idle for several minutes so the engine computer can *relearn* its idle conditions.

## Roadside Emergencies

### WRECKER TOWING

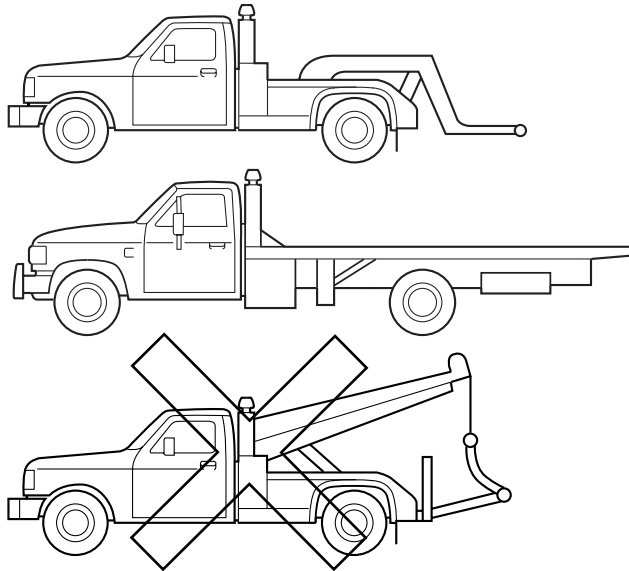

If you need to have your vehicle towed, contact a professional towing service or, if you are a member of a roadside assistance program, your roadside assistance service provider.

It is recommended that your vehicle be towed with a wheel lift or flatbed equipment. Do not tow with a slingbelt. Ford Motor Company has not approved a slingbelt towing procedure.

**If the vehicle is towed by other means or incorrectly, vehicle damage may occur.**

Ford Motor Company produces a towing manual for all authorized tow truck operators. Have your tow truck operator refer to this manual for proper hook-up and towing procedures for your vehicle.

## Customer Assistance

### GETTING THE SERVICES YOU NEED

#### At home

You must take your Lincoln or Mercury vehicle to an authorized Lincoln Mercury dealer for warranty repairs. While any Ford, Lincoln or Mercury dealership handling your vehicle line will provide warranty service, we recommend you return to your selling dealer who wants to ensure your continued satisfaction. Please note that certain warranty repairs require special training and/or equipment, so not all dealers are authorized to perform all warranty repairs. This means that, depending on the warranty repair needed, you may have to take your vehicle to another dealer. A reasonable time must be allowed to perform a repair after taking your vehicle to the dealership. Repairs will be made using Ford or Motorcraft parts, or remanufactured or other parts that are authorized by Ford.

If you have questions or concerns, or are unsatisfied with the service you are receiving, follow these steps:

1. Contact your Sales Representative or Service Advisor at your selling/servicing dealership.
2. If your inquiry or concern remains unresolved, contact the Sales Manager, Service Manager or Customer Relations Manager.
3. If you require assistance or clarification on Ford Motor Company policies or procedures, please contact the Ford Customer Relationship Center at the number below.

#### Away from home

If you own a Ford or Mercury vehicle and are away from home when your vehicle needs service, or if you need more help than the dealership could provide, after following the steps described above, contact the Ford Customer Relationship Center to find an authorized dealership to help you.

In the United States:

Ford Motor Company  
Customer Relationship Center  
P.O. Box 6248  
Dearborn, MI 48121  
1-800-392-3673 (FORD)  
(TDD for the hearing impaired: 1-800-232-5952)  
[www.customersaskford.com](http://www.customersaskford.com)

In Canada:

Customer Relationship Centre

## Customer Assistance

Ford Motor Company of Canada, Limited  
P.O. Box 2000  
Oakville, Ontario L6J 5E4  
1-800-565-3673 (FORD)  
www.ford.ca

If you own a Lincoln vehicle and are away from home when your vehicle needs service, or if you need more help than the dealership could provide, after following the steps described above, contact the Ford Customer Relationship Center to find an authorized dealership to help you.

In the United States:  
Ford Motor Company  
Customer Relationship Center  
P.O. Box 6248  
Dearborn, MI 48121  
1-800-521-4140  
(TDD for the hearing impaired: 1-800-232-5952)  
www.customersaskford.com

In Canada:  
Lincoln Centre  
Ford Motor Company of Canada, Limited  
P.O. Box 2000  
Oakville, Ontario L6J 5E4  
1-800-387-9333  
www.lincolncanada.com

In order to help you service your Lincoln vehicle, please have the following information available when contacting the Lincoln Centre:

- Your telephone number (home and business)
- The name of the dealer and the city where the dealership is located
- The year and make of your vehicle
- The date of vehicle purchase
- The current odometer reading
- The vehicle identification number (VIN)

If you still have a complaint involving a warranty dispute, you may wish to contact the Dispute Settlement Board (U.S.).

In some states (in the U.S.) you must directly notify Ford in writing before pursuing remedies under your state's warranty laws. Ford is also allowed a final repair attempt in some states.

248



## Customer Assistance

In the United States, a warranty dispute must be submitted to the Dispute Settlement Board before taking action under the Magnuson-Moss Warranty Act, or to the extent allowed by state law, before pursuing replacement or repurchase remedies provided by certain state laws. This dispute handling procedure is not required prior to enforcing state created rights or other rights which are independent of the Magnuson-Moss Warranty Act or state replacement or repurchase laws.

### **FORD EXTENDED SERVICE PLAN**

You can get more protection for your new car or light truck by purchasing Ford Extended Service Plan (Ford ESP) coverage. It provides the following:

- Benefits during the warranty period depending on the plan you purchase (such as: reimbursement for rentals; coverage for certain maintenance and wear items).
- Protection against covered repair costs after your Bumper-to-Bumper Warranty expires.

You may purchase Ford ESP from any participating Ford and Lincoln Mercury and Ford of Canada dealer. There are several plans available in various time, distance and deductible combinations which can be tailored to fit your own driving needs. Ford ESP also offers reimbursement benefits for towing and rental coverage.

When you buy Ford ESP, you receive Peace-of-Mind protection throughout the United States and Canada, provided by a network of more than 5,000 participating Ford or Lincoln Mercury and Ford of Canada dealers.

If you did not take advantage of the Ford Extended Service Plan at the time of purchasing your vehicle, you may still be eligible. Since this information is subject to change, please ask your dealer for complete details about Ford Extended Service Plan coverage options, or visit the Ford ESP website at [www.ford-esp.com](http://www.ford-esp.com).

### **THE DISPUTE SETTLEMENT BOARD (U.S. ONLY)**

The Dispute Settlement Board is:

- an independent, third-party arbitration program for warranty disputes.
- available free to owners and lessees of qualifying Ford Motor Company vehicles.

The Dispute Settlement Board may not be available in all states. Ford Motor Company reserves the right to change eligibility limitations, modify procedures and/or to discontinue this service without notice and without incurring obligations per applicable state law.

## Customer Assistance

### What kinds of cases does the Board review?

Unresolved warranty repair concerns or vehicle performance concerns as on Ford and Lincoln Mercury cars and Ford and Lincoln Mercury light trucks which are within the terms of any applicable written new vehicle warranty are eligible for review, except those involving:

- a non-Ford product
- a non-Ford dealership
- sales disputes between customer and dealer except those associated with warranty repairs or concerns with the vehicle's performance as designed
- a request for reimbursement of consequential expenses unless a service or product concern is being reviewed
- items not covered by the New Vehicle Limited Warranty (including maintenance and wear items)
- alleged personal injury/property damage claims
- cases currently in litigation
- vehicles not used primarily for family, personal or household purposes (except in states where the Dispute Settlement Board is required to review commercial vehicles)
- vehicles with non-U.S. warranties

Concerns are ineligible for review if the New Vehicle Limited Warranty has expired at receipt of your application and, in certain states eligibility is dependent upon the customer's possession of the vehicle.

Eligibility may differ according to state law. For example, see the unique brochures for California, West Virginia, Georgia and Wisconsin purchasers/lessees.

### Board membership

The Board consists of:

- Three consumer representatives
- A Ford or Lincoln Mercury dealership representative

Consumer candidates for Board membership are recruited and trained by an independent consulting firm. The dealership Board member is chosen from Ford and Lincoln Mercury dealership management, recognized for their business leadership qualities.

250

## Customer Assistance

### ***What the Board needs***

To have your case reviewed you must complete the application in the DSB brochure and mail it to the address provided on the application form. Some states will require you to use certified mail, with return receipt requested.

Your application is reviewed and, if it is determined to be eligible, you will receive an acknowledgment indicating:

- The file number assigned to your application.
- The toll-free phone number of the DSB's independent administrator.

Your dealership and a Ford Motor Company representative will then be asked to submit statements.

To properly review your case, the Board needs the following information:

- Legible copies of all documents and maintenance or repair orders relevant to the case.
- The year, make, model, and Vehicle Identification Number (VIN) listed on your vehicle ownership license.
- The date of repair(s) and mileage at the time of occurrence(s).
- The current mileage.
- The name of the dealer(s) who sold or serviced the vehicle.
- A brief description of your unresolved concern.
- A brief summary of the action taken by the dealer(s) and Ford Motor Company.
- The names (if known) of all the people you contacted at the dealership(s).
- A description of the action you expect to resolve your concern.

You will receive a letter of explanation if your application does not qualify for Board review.

### ***Oral presentations***

If you would like to make an oral presentation, indicate YES to question 6 on the application. While it is your right to make an oral presentation before the Board, this is not a requirement and the Board will decide the case whether or not an oral presentation is made. An oral presentation may be requested by the Board as well.

### ***Making a decision***

Board members review all available information related to each complaint, including oral presentations, and arrive at a fair and impartial decision. Board review may be terminated at any time by either party.

## Customer Assistance

Every effort is made to decide the case within 40 days of the date that all requested information is received by the Board. Since the Board generally meets once a month, it may take longer for the Board to consider some cases.

After a case is reviewed, the Board mails you a decision letter and a form on which to accept or reject the Board's decision. The decisions of the Board are binding on Ford (and, in some cases, on the dealer) but not on consumers who are free to pursue other remedies available to them under state or federal law.

### To request a DSB Brochure/Application

For a brochure/application, speak to your dealer or write/call the Board at the following address/phone number:

Dispute Settlement Board  
P.O. Box 1424  
Waukesha, WI 53187-1424  
1-800-428-3718

You may also contact the North American Customer Relationship Center at 1-800-392-3673 (Ford), TDD for the hearing impaired: 1-800-232-5952 or by writing to the Center at the following address:

Ford Motor Company  
Customer Relationship Center  
P.O. Box 6248  
Dearborn, Michigan 48121

### UTILIZING THE MEDIATION/ARBITRATION PROGRAM (CANADA ONLY)

In those cases where you continue to feel that the efforts by Ford and the dealer to resolve a factory-related vehicle service concern have been unsatisfactory, Ford of Canada participates in an impartial third party mediation/arbitration program administered by the Canadian Motor Vehicle Arbitration Plan (CAMVAP).

The CAMVAP program is a straight-forward and relatively speedy alternative to resolve a disagreement when all other efforts to produce a settlement have failed. This procedure is without cost to you and is designed to eliminate the need for lengthy and expensive legal proceedings.

In the CAMVAP program, impartial third-party arbitrators conduct hearings at mutually convenient times and places in an informal environment. These impartial arbitrators review the positions of the

252

## Customer Assistance

parties, make decisions and, when appropriate, render awards to resolve disputes. CAMVAP decisions are fast, fair, and final; the arbitrator's award is binding both to you and Ford of Canada.

CAMVAP services are available in all territories and provinces. For more information, without charge or obligation, call your CAMVAP Provincial Administrator directly at 1-800-207-0685.

### **GETTING ASSISTANCE OUTSIDE THE U.S. AND CANADA**

Before exporting your vehicle to a foreign country, contact the appropriate foreign embassy or consulate. These officials can inform you of local vehicle registration regulations and where to find unleaded fuel.

If you cannot find unleaded fuel or can only get fuel with an anti-knock index lower than is recommended for your vehicle, contact a district or owner relations/customer relationship office.

The use of leaded fuel in your vehicle without proper conversion may damage the effectiveness of your emission control system and may cause engine knocking or serious engine damage. Ford Motor Company/Ford of Canada is not responsible for any damage caused by use of improper fuel.

In the United States, using leaded fuel may also result in difficulty importing your vehicle back into the U.S.

If your vehicle must be serviced while you are traveling or living in Central or South America, the Caribbean, or the Middle East, contact the nearest Ford dealership. If the dealership cannot help you, write or call:

FORD MOTOR COMPANY  
WORLDWIDE DIRECT MARKET OPERATIONS  
1555 Fairlane Drive  
Fairlane Business Park #3  
Allen Park, Michigan 48101  
U.S.A.  
Telephone: (313) 594-4857  
FAX: (313) 390-0804

If you are in another foreign country, contact the nearest Ford dealership. If the dealership employees cannot help you, they can direct you to the nearest Ford affiliate office.

If you buy your vehicle in North America and then relocate outside of the U.S. or Canada, register your vehicle identification number (VIN) and new address with Ford Motor Company Worldwide Direct Market Operations.

## Customer Assistance

### **ORDERING ADDITIONAL OWNER'S LITERATURE**

To order the publications in this portfolio, contact Helm, Incorporated at:

HELM, INCORPORATED  
P.O. Box 07150  
Detroit, Michigan 48207

Or call:

**For a free publication catalog, order toll free: 1-800-782-4356**

Monday-Friday 8:00 a.m. - 6:00 p.m. EST

Helm, Incorporated can also be reached by their website:  
[www.helminc.com](http://www.helminc.com).

*(Items in this catalog may be purchased by credit card, check or money order.)*

### **Obtaining a French owner's guide**

French Owner's Guides can be obtained from your dealer or by writing to Ford Motor Company of Canada, Limited, Service Publications, P.O. Box 1580, Station B, Mississauga, Ontario L4Y 4G3.

### **IN CALIFORNIA (U.S. ONLY)**

California Civil Code Section 1793.2(d) requires that, if a manufacturer or its representative is unable to repair a motor vehicle to conform to the vehicle's applicable express warranty after a reasonable number of attempts, the manufacturer shall be required to either replace the vehicle with one substantially identical or repurchase the vehicle and reimburse the buyer in an amount equal to the actual price paid or payable by the consumer (less a reasonable allowance for consumer use). The consumer has the right to choose whether to receive a refund or replacement vehicle.

California Civil Code Section 1793.22(b) presumes that the manufacturer has had a reasonable number of attempts to conform the vehicle to its applicable express warranties if, within the first 18 months of ownership of a new vehicle or the first 18,000 miles (29,000 km), whichever occurs first:

1. Two or more repair attempts are made on the same non-conformity likely to cause death or serious bodily injury OR

## Customer Assistance

2. Four or more repair attempts are made on the same nonconformity (a defect or condition that substantially impairs the use, value or safety of the vehicle) OR
3. The vehicle is out of service for repair of nonconformities for a total of more than 30 calendar days (not necessarily all at one time)

In the case of 1 or 2 above, the consumer must also notify the manufacturer of the need for the repair of the nonconformity at the following address:

Ford Motor Company  
16800 Executive Plaza Drive  
Mail Drop 3NE-B  
Dearborn, MI 48126

### REPORTING SAFETY DEFECTS (U.S. ONLY)

If you believe that your vehicle has a defect which could cause a crash or could cause injury or death, you should immediately inform the National Highway Traffic Safety



Administration (NHTSA) in addition to notifying Ford Motor Company.

If NHTSA receives similar complaints, it may open an investigation, and if it finds that a safety defect exists in a group of vehicles, it may order a recall and remedy campaign. However, NHTSA cannot become involved in individual problems between you, your dealer, or Ford Motor Company.

To contact NHTSA, you may either call the Auto Safety Hotline toll-free at 1-800-424-9393 (or 366-0123 in the Washington D.C. area) or write to:

NHTSA  
400 Seventh Street  
U.S. Department of Transportation  
Washington, D.C. 20590

You can also obtain other information about motor vehicle safety from the Hotline.

## Cleaning

### WASHING THE EXTERIOR

Wash your vehicle regularly with cool or lukewarm water and a neutral Ph shampoo, such as Motorcraft Detail Wash (ZC-3-A), which is available from your dealer.

- Never use strong household detergents or soap, such as dish washing or laundry liquid. These products can discolor and spot painted surfaces.
- Never wash a vehicle that is “hot to the touch” or during exposure to strong, direct sunlight.
- Always use a clean sponge or car wash mitt with plenty of water for best results.
- Dry the vehicle with a chamois or soft terry cloth towel in order to eliminate water spotting.
- It is especially important to wash the vehicle regularly during the winter months, as dirt and road salt are difficult to remove and cause damage to the vehicle.
- Immediately remove items such as gasoline, diesel fuel, bird droppings and insect deposits because they can cause damage to the vehicle’s paintwork and trim over time.
- Remove any exterior accessories, such as antennas, before entering a car wash.
- **Suntan lotions and insect repellents can damage any painted surface; if these substances come in contact with your vehicle, wash off as soon as possible.**

### WAXING

Applying a polymer paint sealant to your vehicle every six months will assist in reducing minor scratches and paint damage.

- Wash the vehicle first.
- Do not use waxes that contain abrasives.
- Do not allow paint sealant to come in contact with any non-body (low-gloss black) colored trim, such as grained door handles, roof racks, bumpers, side moldings, mirror housings or the windshield cowl area. The paint sealant will “gray” or stain the parts over time.

### PAINT CHIPS

Your dealer has touch-up paint and sprays to match your vehicle’s color. Take your color code (printed on a sticker in the driver’s door jam) to your dealer to ensure you get the correct color.

256



## Cleaning

- Remove particles such as bird droppings, tree sap, insect deposits, tar spots, road salt and industrial fallout before repairing paint chips.
- Always read the instructions before using the products.

### ALUMINUM WHEELS AND WHEEL COVERS

Aluminum wheels and wheel covers are coated with a clearcoat paint finish. In order to maintain their shine:

- Clean weekly with Motorcraft Wheel and Tire Cleaner (ZC-37-A), which is available from your dealer. Heavy dirt and brake dust accumulation may require agitation with a sponge. Rinse thoroughly with a strong stream of water.
- Never apply any cleaning chemical to hot or warm wheel rims or covers.
- Some automatic car washes may cause damage to the finish on your wheel rims or covers. Chemical-strength cleaners, or cleaning chemicals, in combination with brush agitation to remove brake dust and dirt, could wear away the clearcoat finish over time.
- Do not use hydrofluoric acid-based or high caustic-based wheel cleaners, steel wool, fuels or strong household detergent.
- To remove tar and grease, use Motorcraft Bug and Tar Remover (ZC-42), available from your dealer.

### ENGINE

Engines are more efficient when they are clean because grease and dirt buildup keep the engine warmer than normal. When washing:

- Take care when using a power washer to clean the engine. The high-pressure fluid could penetrate the sealed parts and cause damage.
- Do not spray a hot engine with cold water to avoid cracking the engine block or other engine components.
- Spray Motorcraft Engine Shampoo and Degreaser (ZC-20) on all parts that require cleaning and pressure rinse clean.
- Cover the highlighted areas to prevent water damage when cleaning the engine.

## Cleaning

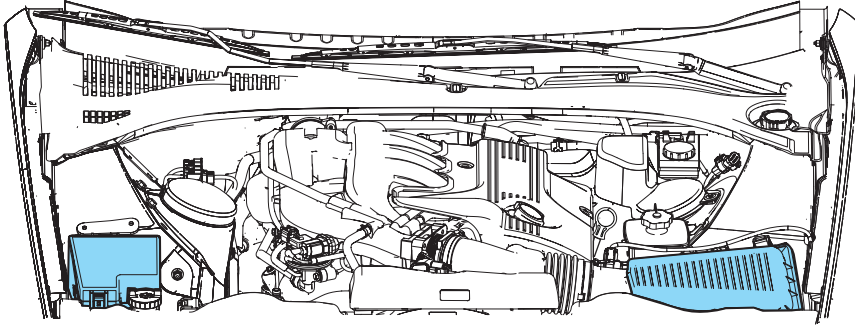

- **3.0L DOHC V6 engine**

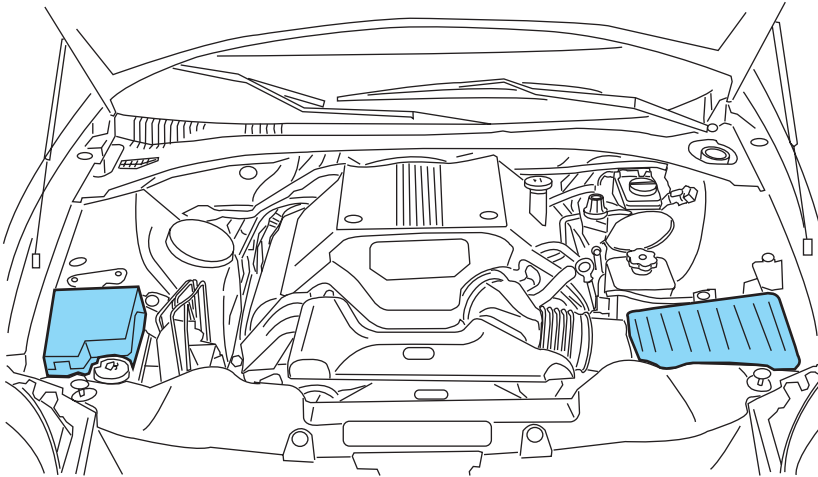

- **3.9L-4V V8 engine**

- Never wash or rinse the engine while it is running; water in the running engine may cause internal damage.

### **PLASTIC (NON-PAINTED) EXTERIOR PARTS**

Use only approved products to clean plastic parts. These products are available from your dealer.

- For routine cleaning, use Motorcraft Detail Wash (ZC-3-A).

258

## Cleaning

- If tar or grease spots are present, use Motorcraft Bug and Tar Remover (ZC-42).

### WINDOWS AND WIPER BLADES

The windshield, rear and side windows and the wiper blades should be cleaned regularly. If the wipers do not wipe properly, substances on the vehicle's glass or the wiper blades may be the cause. These may include hot wax treatments used by commercial car washes, tree sap, or other organic contamination. To clean these items, please follow these tips:

- The windshield, rear windows and side windows may be cleaned with a non-abrasive cleaner such as Motorcraft Ultra Clear Spray Glass Cleaner (ZC-23), available from your dealer.
- Do not use abrasives, as they may cause scratches.
- Do not use fuel, kerosene, or paint thinner to clean any parts.
- Wiper blades can be cleaned with isopropyl (rubbing) alcohol or windshield washer solution. Be sure to replace wiper blades when they appear worn or do not function properly.

**Do not use sharp objects, such as a razor blade, to clean the inside of the rear window or to remove decals, as it may cause damage to the rear window defroster's heated grid lines.**

### INSTRUMENT PANEL AND CLUSTER LENS

Clean the instrument panel with a damp cloth, then dry with a dry cloth.

- Avoid cleaners or polish that increase the gloss of the upper portion of the instrument panel. The dull finish in this area helps protect the driver from undesirable windshield reflection.



Do not use chemical solvents or strong detergents when cleaning the steering wheel or instrument panel to avoid contamination of the air bag system.

- Be certain to wash or wipe your hands clean if you have been in contact with certain products such as insect repellent and suntan lotion in order to avoid possible damage to the interior painted surfaces.

### INTERIOR TRIM

- Clean the interior trim areas with a damp cloth, then dry by wiping with a dry, soft, clean cloth.

## Cleaning

- Do not use household or glass cleaners as these may damage the finish.

### INTERIOR

For fabric, carpets, cloth seats, safety belts and seats equipped with side air bags:

- Remove dust and loose dirt with a vacuum cleaner.
- Remove light stains and soil with Motorcraft Extra Strength Upholstery Cleaner (ZC-41).
- If grease or tar is present on the material, spot-clean the area first with Motorcraft Spot and Stain Remover (ZC-14).
- Never saturate the seat covers with cleaning solution.
- Do not use household cleaning products or glass cleaners, which can stain and discolor the fabric and affect the flame retardant abilities of the seat materials.



Do not use cleaning solvents, bleach or dye on the vehicle's safety belts, as these actions may weaken the belt webbing.



Do not use chemical solvents or strong detergents when cleaning the seat-mounted side air bag. Such products could contaminate the side air bag system and affect performance of the side air bag in a collision.

### LEATHER SEATS

Your leather seating surfaces have a clear, protective coating over the leather.

- To clean, use a soft cloth with Motorcraft Deluxe Leather and Vinyl Cleaner (ZC-11-A). Dry the area with a soft cloth.
- To help maintain its resiliency and color, use the Motorcraft Deluxe Leather Care Kit (ZC-11-D), available from your authorized dealer.
- Do not use household cleaning products, alcohol solutions, solvents or cleaners intended for rubber, vinyl and plastics, or oil/petroleum-based leather conditioners. These products may cause premature wearing of the clear, protective coating.

**Note:** In some instances, color or dye transfer can occur when wet clothing comes in contact with leather upholstery. If this occurs, the leather should be cleaned immediately to avoid permanent staining.

### UNDERBODY

Flush the complete underside of your vehicle frequently. Keep body and door drain holes free from packed dirt.

### FORD, LINCOLN AND MERCURY CAR CARE PRODUCTS

Your Ford, Lincoln or Mercury dealer has many quality products available to clean your vehicle and protect its finishes. These quality products have been specifically engineered to fulfill your automotive needs; they are custom designed to complement the style and appearance of your vehicle. Each product is made from high quality materials that meet or exceed rigid specifications. For best results, use the following products or products of equivalent quality:

Motorcraft Custom Clearcoat Polish (ZC-8-A)

Motorcraft Custom Vinyl Protectant (not available in Canada) (ZC-40-A)

Motorcraft Vinyl Cleaner (Canada only) (CXC-93)

Motorcraft Vinyl Conditioner (Canada only) (CXC-94)

Motorcraft Deluxe Leather and Vinyl Cleaner (not available in Canada) (ZC-11-A)

Motorcraft Bug and Tar Remover (ZC-42)

Motorcraft Extra Strength Upholstery Cleaner (not available in Canada) (ZC-41)

Motorcraft Custom Bright Metal Cleaner (ZC-15)

Motorcraft Wheel and Tire Cleaner (ZC-37-A)

Motorcraft Dash and Vinyl Cleaner (ZC-38-A)

Motorcraft Car Care Kit (ZC-26)

Ford Premium Car Wash Concentrate (F2SZ-19523-WC)

Motorcraft Carlite Glass Cleaner (Canada only) (CXC-100)

Motorcraft Spot and Stain Remover (ZC-14)

Motorcraft Detail Wash (ZC-3-A)

Motorcraft Tire Clean and Shine (ZC-28)

Motorcraft Triple Clean (ZC-13)

Motorcraft Ultra-Clear Spray Glass Cleaner (not available in Canada) (ZC-23)

Motorcraft Engine Shampoo and Degreaser (ZC-20)

## Maintenance and Specifications

### SERVICE RECOMMENDATIONS

To help you service your vehicle:

- We highlight do-it-yourself items in the engine compartment for easy location.
- We provide a scheduled maintenance guide which makes tracking routine service easy.

If your vehicle requires professional service, your dealership can provide the necessary parts and service. Check your *Warranty Guide/Owner Information Guide* to find out which parts and services are covered.

Use only recommended fuels, lubricants, fluids and service parts conforming to specifications. Motorcraft parts are designed and built to provide the best performance in your vehicle.

### PRECAUTIONS WHEN SERVICING YOUR VEHICLE

- Do not work on a hot engine.
- Make sure that nothing gets caught in moving parts.
- Do not work on a vehicle with the engine running in an enclosed space, unless you are sure you have enough ventilation.
- Keep all open flames and other lit material away from the battery and all fuel related parts.

## Maintenance and Specifications

### Working with the engine off

1. Set the parking brake and ensure the gearshift is securely latched in P (Park).
2. Turn off the engine and remove the key.
3. Block the wheels to prevent the vehicle from moving unexpectedly.

### Working with the engine on

1. Set the parking brake and shift to P (Park).
2. Block the wheels.

**Note:** Do not start your engine with the air cleaner removed and do not remove it while the engine is running.

### OPENING THE HOOD

1. Inside the vehicle, pull the hood release handle located at the bottom left of the instrument panel.
2. Go to the front of the vehicle and release the auxiliary latch that is located under the front center of the hood by pushing upward on the handle.
3. Lift the hood until the lift cylinders hold it open.

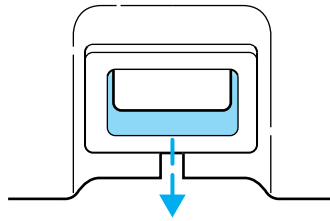

## Maintenance and Specifications

### IDENTIFYING COMPONENTS IN THE ENGINE COMPARTMENT

#### 3.0L DOHC V6 engine

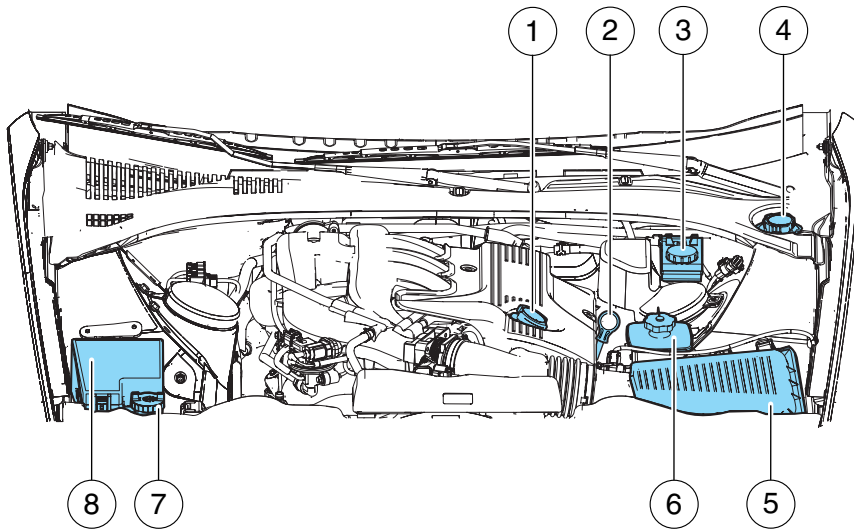

1. Engine oil filler cap
2. Engine oil dipstick
3. Brake fluid reservoir
4. Engine coolant reservoir
5. Air filter assembly
6. Power steering fluid reservoir
7. Windshield washer fluid reservoir
8. Power distribution box



## Maintenance and Specifications

### 3.9L-4V V8 engine

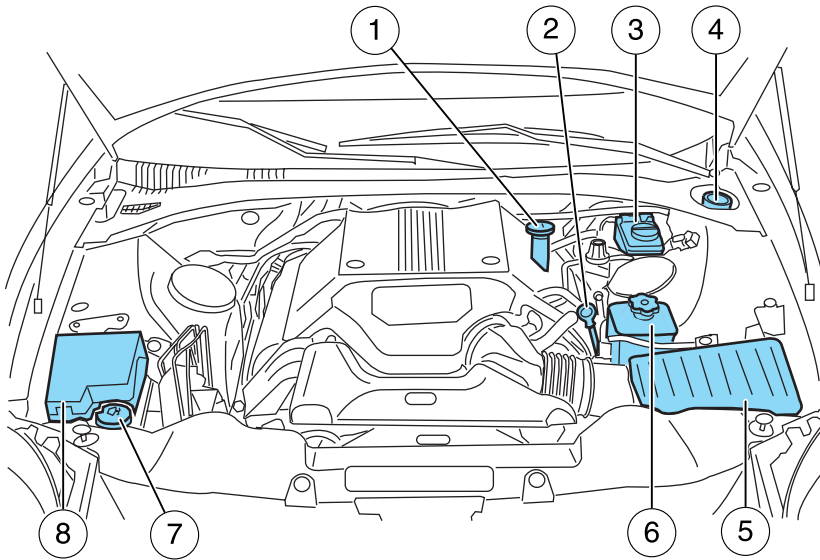

1. Engine oil filler cap
2. Engine oil dipstick
3. Brake fluid reservoir
4. Engine coolant reservoir
5. Air filter assembly
6. Power steering fluid reservoir
7. Windshield washer fluid reservoir
8. Power distribution box

## Maintenance and Specifications

### WINDSHIELD WASHER FLUID

Add fluid to fill the reservoir if the level is low. In very cold weather, do not fill the reservoir completely.

Only use a washer fluid that meets Ford specification WSB-M8B16-A2. Refer to *Lubricant specifications* in this chapter.

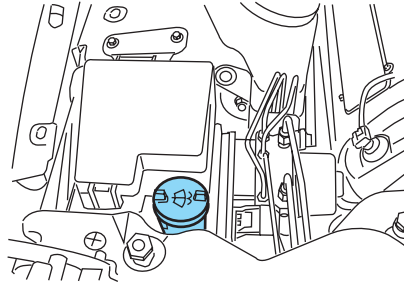

State or local regulations on volatile organic compounds may restrict the use of methanol, a common windshield washer antifreeze additive. Washer fluids containing non-methanol antifreeze agents should be used only if they provide cold weather protection without damaging the vehicle's paint finish, wiper blades or washer system.



If you operate your vehicle in temperatures below 40° F (4.5°C), use washer fluid with antifreeze protection. Failure to use washer fluid with antifreeze protection in cold weather could result in impaired windshield vision and increase the risk of injury or accident.

**Note:** Do not put washer fluid in the engine coolant reservoir. Washer fluid placed in the cooling system may harm engine and cooling system components.

### ENGINE OIL

#### Checking the engine oil

Refer to the scheduled maintenance guide for the appropriate intervals for checking the engine oil.

1. Make sure the vehicle is on level ground.
2. Turn the engine off and wait a few minutes for the oil to drain into the oil pan.
3. Set the parking brake and ensure the gearshift is securely latched in P (Park).
4. Open the hood. Protect yourself from engine heat.

266

## Maintenance and Specifications

5. Locate and carefully remove the engine oil level indicator (dipstick).

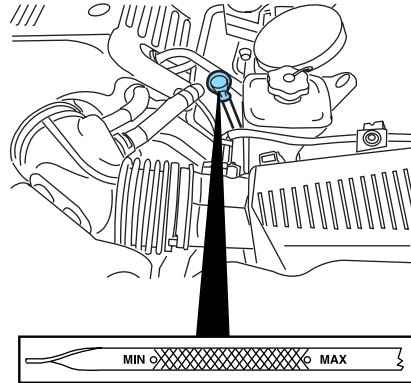

6. Wipe the indicator clean. Insert the indicator fully, then remove it again.

- If the oil level is **between the MIN and MAX marks**, the oil level is acceptable. **DO NOT ADD OIL.**
- If the oil level is below the MIN mark, add enough oil to raise the level within the MIN-MAX range.

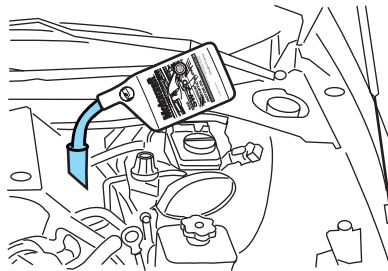

- Oil levels above the MAX mark may cause engine damage. Some oil must be removed from the engine by a service technician.

7. Put the indicator back in and ensure it is fully seated.

### Adding engine oil

1. Check the engine oil. For instructions, refer to *Checking the engine oil* in this chapter.
2. If the engine oil level is not within the normal range, add only certified engine oil of the recommended viscosity. Remove the engine oil filler cap and use a funnel to pour the engine oil into the opening.

## Maintenance and Specifications

3. Recheck the engine oil level. Make sure the oil level is not above the MAX mark on the engine oil level indicator (dipstick).
4. Install the indicator and ensure it is fully seated.
5. Fully install the engine oil filler cap by turning the filler cap clockwise tightly until clicks are heard, or until it is snug.

**To avoid possible oil loss, DO NOT operate the vehicle with the engine oil level indicator and/or the engine oil filler cap removed.**

### Engine oil and filter recommendations

Look for this certification trademark.

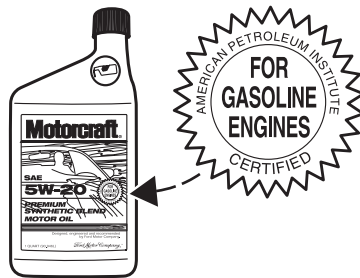

### **Use SAE 5W-20 engine oil.**

Only use oils “Certified For Gasoline Engines” by the American Petroleum Institute (API). To protect your engine’s warranty use Motorcraft SAE 5W-20 or an equivalent 5W-20 oil meeting Ford specification WSS-M2C153-H. **SAE 5W-20 oil provides optimum fuel economy and durability performance meeting all requirements for your vehicle’s engine.**

Do not use supplemental engine oil additives, cleaners or other engine treatments. They are unnecessary and could lead to engine damage that is not covered by Ford warranty.

Change your engine oil according to the appropriate schedule listed in the scheduled maintenance guide.

Ford production and aftermarket (Motorcraft) oil filters are designed for added engine protection and long life. If a replacement oil filter is used that does not meet Ford material and design specifications, start-up engine noises of knock may be experienced.

It is recommended you use the appropriate Motorcraft oil filter (or another brand meeting Ford specifications) for your engine application.

## Maintenance and Specifications

### BATTERY

Your vehicle is equipped with a Motorcraft maintenance-free battery which is located in the luggage compartment, next to the spare tire.

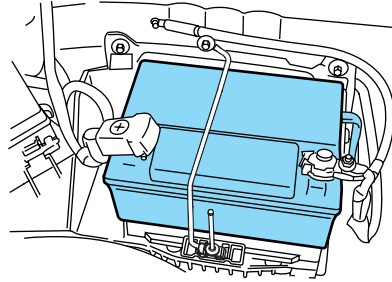

Your battery is designed to purge any battery gases to the outside of the vehicle by means of a vent hose. This vent hose **MUST** be attached at all times. Replacement batteries must be of the same vented design.

**If your battery has a cover/shield, make sure it is reinstalled after the battery has been cleaned or replaced.**

Your battery normally does not require additional water during its life of service. For longer, trouble-free operation, keep the top of the battery clean and dry. Make certain that the vent hose is attached. Also, make certain the battery cables are always tightly fastened to the battery terminals.

If you see any corrosion on the battery or terminals, remove the cables from the terminals and clean with a wire brush. You can neutralize the acid with a solution of baking soda and water.

**Note: Electrical or electronic accessories or components added to the vehicle by the dealer or the owner may adversely affect battery performance and durability.**

 Batteries normally produce explosive gases which can cause personal injury. Therefore, do not allow flames, sparks or lighted substances to come near the battery. When working near the battery, always shield your face and protect your eyes. Always provide proper ventilation.

 When lifting a plastic-cased battery, excessive pressure on the end walls could cause acid to flow through the vent caps, resulting in personal injury and/or damage to the vehicle or battery. Lift the battery with a battery carrier or with your hands on opposite corners.

## Maintenance and Specifications



Keep batteries out of reach of children. Batteries contain sulfuric acid. Avoid contact with skin, eyes or clothing. Shield your eyes when working near the battery to protect against possible splashing of acid solution. In case of acid contact with skin or eyes, flush immediately with water for a minimum of 15 minutes and get prompt medical attention. If acid is swallowed, call a physician immediately.



Battery posts, terminals and related accessories contain lead and lead compounds. **Wash hands after handling.**

Because your vehicle's engine is electronically controlled by a computer, some control conditions are maintained by power from the battery. When the battery is disconnected or a new battery is installed, the engine must relearn its idle and fuel trim strategy for optimum driveability and performance. To begin this process:

1. With the vehicle at a complete stop, set the parking brake.
  2. Put the gearshift lever in P (Park), turn off all accessories and start the engine.
  3. Run the engine until it reaches normal operating temperature.
  4. Allow the engine to idle for at least one minute.
  5. Turn the A/C on and allow the engine to idle for at least one minute.
  6. Drive the vehicle to complete the relearning process.
- The vehicle may need to be driven to relearn the idle and fuel trim strategy.
  - **If you do not allow the engine to relearn its idle trim, the idle quality of your vehicle may be adversely affected until the idle trim is eventually relearned.**

When the battery is disconnected or a new battery installed, the transmission must relearn its adaptive strategy. As a result of this, the transmission may shift firmly. This operation is considered normal and will not affect function or durability of the transmission. Over time the adaptive learning process will fully update transmission operation to its optimum shift feel.

If the battery has been disconnected or a new battery has been installed, the clock and the preset radio stations must be reset once the battery is reconnected.

## Maintenance and Specifications

- Always dispose of automotive batteries in a responsible manner. Follow your local authorized standards for disposal. Call your local authorized recycling center to find out more about recycling automotive batteries.

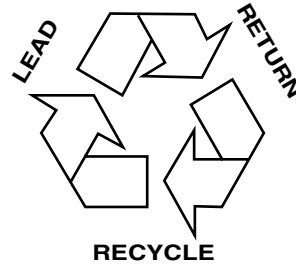

### ENGINE COOLANT

#### Checking engine coolant

The concentration and level of engine coolant should be checked at the mileage intervals listed in the *Scheduled Maintenance Guide*. The coolant concentration should be maintained at 50/50 coolant and distilled water, which equates to a freeze point of  $-34^{\circ}\text{F}$  ( $-36^{\circ}\text{C}$ ). Coolant concentration testing is possible with a hydrometer or antifreeze tester (such as the Rotunda Battery and Antifreeze Tester, 014-R1060). The level of coolant should be maintained at the "FULL COLD" level or within the "COLD FILL RANGE" in the coolant reservoir. If the level falls below, add coolant per the instructions in the *Adding engine coolant* section.

Your vehicle was factory-filled with a 50/50 engine coolant and water concentration. If the concentration of coolant falls below 40% or above 60%, the engine parts could become damaged or not work properly. **A 50–50 mixture of coolant and water provides the following:**

- **Freeze protection down to  $-34^{\circ}\text{F}$  ( $-36^{\circ}\text{C}$ ).**
- **Boiling protection up to  $265^{\circ}\text{F}$  ( $129^{\circ}\text{C}$ ).**
- **Protection against rust and other forms of corrosion.**
- **Enables calibrated gauges to work properly.**

## Maintenance and Specifications

When the engine is cold, check the level of the engine coolant in the reservoir.



- The engine coolant should be at the “FULL COLD” level or within the “COLD FILL RANGE” as listed on the engine coolant reservoir (depending upon application).
- Refer to the *Scheduled Maintenance Guide* for service interval schedules.
- Be sure to read and understand *Precautions when servicing your vehicle* in this chapter.

If the engine coolant has not been checked at the recommended interval, the engine coolant reservoir may become low or empty. If the reservoir is low or empty, add engine coolant to the reservoir. Refer to *Adding engine coolant* in this chapter.

**Note:** Automotive fluids are not interchangeable; do not use engine coolant, antifreeze or windshield washer fluid outside of its specified function and vehicle location.



## Maintenance and Specifications

### Adding engine coolant

When adding coolant, make sure it is a 50/50 mixture of engine coolant and distilled water. Add the mixture to the coolant reservoir, **when the engine is cool**, until the appropriate fill level is obtained.



Do not add engine coolant when the engine is hot. Steam and scalding liquids released from a hot cooling system can burn you badly. Also, you can be burned if you spill coolant on hot engine parts.



Do not put engine coolant in the windshield washer fluid container. If sprayed on the windshield, engine coolant could make it difficult to see through the windshield.

- **Add Motorcraft Premium Gold Engine Coolant (yellow-colored), VC-7-A (U.S., except CA and OR), VC-7-B (CA and OR only), meeting Ford Specification WSS-M97B51-A1.**

**Note:** Use of Motorcraft Cooling System Stop Leak Pellets, VC-6, may darken the color of Motorcraft Premium Gold Engine Coolant from yellow to golden tan.

- **Do not add/mix an orange-colored, extended life coolant such as Motorcraft Speciality Orange Engine Coolant, VC-2 (US) or CXC-209 (Canada), meeting Ford specification WSS-M97B44-D with the factory-filled coolant.** Mixing Motorcraft Speciality Orange Engine Coolant or any orange-colored extended life product with your factory filled coolant can result in degraded corrosion protection.
- A large amount of water without engine coolant may be added, in case of emergency, to reach a vehicle service location. In this instance, the cooling system must be drained and refilled with a 50/50 mixture of engine coolant and distilled water as soon as possible. Water alone (without engine coolant) can cause engine damage from corrosion, overheating or freezing.
- **Do not use alcohol, methanol, brine or any engine coolants mixed with alcohol or methanol antifreeze (coolant).** Alcohol and other liquids can cause engine damage from overheating or freezing.
- **Do not add extra inhibitors or additives to the coolant.** These can be harmful and compromise the corrosion protection of the engine coolant.

## Maintenance and Specifications

For vehicles with overflow coolant systems with a non-pressurized cap on the coolant recovery system, add coolant to the coolant recovery reservoir when the engine is cool. Add the proper mixture of coolant and water to the “FULL COLD” level. For all other vehicles, which have a coolant degas system with a pressurized cap, or if it is necessary to remove the coolant pressure relief cap on the radiator of a vehicle with an overflow system, follow these steps to add engine coolant.



To reduce the risk of personal injury, make sure the engine is cool before unscrewing the coolant pressure relief cap. The cooling system is under pressure; steam and hot liquid can come out forcefully when the cap is loosened slightly.

1. Before you begin, turn the engine off and let it cool.
2. When the engine is cool, wrap a thick cloth around the coolant pressure relief cap on the coolant reservoir (a translucent plastic bottle). Slowly turn cap counterclockwise (left) until pressure begins to release.
3. Step back while the pressure releases.
4. When you are sure that all the pressure has been released, use the cloth to turn it counterclockwise and remove the cap.
5. Fill the coolant reservoir slowly with the proper coolant mixture (see above), to within the “COLD FILL RANGE” or the “FULL COLD” level on the reservoir. If you removed the radiator cap in an overflow system, fill the radiator until the coolant is visible and radiator is almost full.
6. Replace the cap. Turn until tightly installed. (Cap must be tightly installed to prevent coolant loss.)

After any coolant has been added, check the coolant concentration, refer to *Checking engine coolant*. If the concentration is not 50/50 (protection to -34° F/-36° C), drain some coolant and adjust the concentration. It may take several drains and additions to obtain a 50/50 coolant concentration.

Whenever coolant has been added, the coolant level in the coolant reservoir should be checked the next few times you drive the vehicle. If necessary, add enough 50/50 concentration of engine coolant and distilled water to bring the liquid level to the proper level.

If you have to add more than 1.0 liter (1.0 quart) of engine coolant per month, have your dealer check the engine cooling system. Your cooling system may have a leak. Operating an engine with a low level of coolant can result in engine overheating and possible engine damage.

## Maintenance and Specifications

### Recycled engine coolant

Ford Motor Company does NOT recommend the use of recycled engine coolant in vehicles originally equipped with Motorcraft Premium Gold Engine Coolant since a Ford-approved recycling process is not yet available.



Used engine coolant should be disposed of in an appropriate manner. Follow your community's regulations and standards for recycling and disposing of automotive fluids.

### Coolant refill capacity

To find out how much fluid your vehicle's cooling system can hold, refer to *Refill capacities* in this section.

Fill your engine coolant reservoir as outlined in *Adding engine coolant* in this section.

### Severe climates

If you drive in extremely cold climates (less than  $-36^{\circ}\text{C}$  [ $-34^{\circ}\text{F}$ ):

- **It may be necessary to increase the coolant concentration above 50%.**
- **NEVER increase the coolant concentration above 60%.**
- **Increased engine coolant concentrations above 60% will decrease the overheat protection characteristics of the engine coolant and may cause engine damage.**
- **Refer to the chart on the coolant container to ensure the coolant concentration in your vehicle will provide adequate freeze protection at the temperatures in which you drive in the winter months.**

If you drive in extremely hot climates:

- **It is still necessary to maintain the coolant concentration above 40%.**
- **NEVER decrease the coolant concentration below 40%.**
- **Decreased engine coolant concentrations below 40% will decrease the corrosion protection characteristics of the engine coolant and may cause engine damage.**
- **Decreased engine coolant concentrations below 40% will decrease the freeze protection characteristics of the engine coolant and may cause engine damage.**

## Maintenance and Specifications

- **Refer to the chart on the coolant container to ensure the coolant concentration in your vehicle will provide adequate protection at the temperatures in which you drive.**



Vehicles driven year-round in non-extreme climates should use a 50/50 mixture of engine coolant and distilled water for optimum cooling system and engine protection.

### What you should know about fail-safe cooling

If the engine coolant supply is depleted, this feature allows the vehicle to be driven temporarily before incremental component damage is incurred. The “fail-safe” distance depends on ambient temperatures, vehicle load and terrain.

#### How fail-safe cooling works

If the engine begins to overheat:

- The engine coolant temperature gauge will move to the H (hot) area.
- The  symbol will illuminate.
- The  symbol will illuminate.
- The  symbol will illuminate.



If the engine reaches a preset over-temperature condition, the engine will automatically switch to alternating cylinder operation. Each disabled cylinder acts as an air pump and cools the engine.

When this occurs the vehicle will still operate. However:

- The engine power will be limited.
- The air conditioning system will be disabled.

Continued operation will increase the engine temperature and the engine will completely shut down, causing steering and braking effort to increase.

Once the engine temperature cools, the engine can be re-started. Take your vehicle to a service facility as soon as possible to minimize engine damage.

#### When fail-safe mode is activated

You have limited engine power when in the fail-safe mode, so drive the vehicle with caution. The vehicle will not be able to maintain high-speed

## Maintenance and Specifications

operation and the engine will run rough. Remember that the engine is capable of completely shutting down automatically to prevent engine damage, therefore:

1. Pull off the road as soon as safely possible and turn off the engine.
2. Arrange for the vehicle to be taken to a service facility.
3. If this is not possible, wait a short period for the engine to cool.
4. Check the coolant level and replenish if low.



Never remove the coolant reservoir cap while the engine is running or hot.

5. Re-start the engine and take your vehicle to a service facility.

**Driving the vehicle without repairing the engine problem increases the chance of engine damage. Take your vehicle to a service facility as soon as possible.**

### WHAT YOU SHOULD KNOW ABOUT AUTOMOTIVE FUELS

#### Important safety precautions



Do not overfill the fuel tank. The pressure in an overfilled tank may cause leakage and lead to fuel spray and fire.



The fuel system may be under pressure. If the fuel filler cap is venting vapor or if you hear a hissing sound, wait until it stops before completely removing the fuel filler cap. Otherwise, fuel may spray out and injure you or others.



If you do not use the proper fuel filler cap, excessive pressure or vacuum in the fuel tank may damage the fuel system or cause the fuel cap to disengage in a collision, which may result in possible personal injury.



Automotive fuels can cause serious injury or death if misused or mishandled.



Gasoline may contain benzene, which is a cancer-causing agent.

## Maintenance and Specifications

Observe the following guidelines when handling automotive fuel:

- Extinguish all smoking materials and any open flames before fueling your vehicle.
- Always turn off the vehicle before fueling.
- Automotive fuels can be harmful or fatal if swallowed. Fuel such as gasoline is highly toxic and if swallowed can cause death or permanent injury. If fuel is swallowed, call a physician immediately, even if no symptoms are immediately apparent. The toxic effects of fuel may not be visible for hours.
- Avoid inhaling fuel vapors. Inhaling too much fuel vapor of any kind can lead to eye and respiratory tract irritation. In severe cases, excessive or prolonged breathing of fuel vapor can cause serious illness and permanent injury.
- Avoid getting fuel liquid in your eyes. If fuel is splashed in the eyes, remove contact lenses (if worn), flush with water for 15 minutes and seek medical attention. Failure to seek proper medical attention could lead to permanent injury.
- Fuels can also be harmful if absorbed through the skin. If fuel is splashed on the skin and/or clothing, promptly remove contaminated clothing and wash skin thoroughly with soap and water. Repeated or prolonged skin contact with fuel liquid or vapor causes skin irritation.
- Be particularly careful if you are taking “Antabuse” or other forms of disulfiram for the treatment of alcoholism. Breathing gasoline vapors, or skin contact could cause an adverse reaction. In sensitive individuals, serious personal injury or sickness may result. If fuel is splashed on the skin, promptly wash skin thoroughly with soap and water. Consult a physician immediately if you experience an adverse reaction.



 When refueling always shut the engine off and never allow sparks or open flames near the filler neck. Never smoke while refueling. Fuel vapor is extremely hazardous under certain conditions. Care should be taken to avoid inhaling excess fumes.

 The flow of fuel through a fuel pump nozzle can produce static electricity, which can cause a fire if fuel is pumped into an ungrounded fuel container.

## Maintenance and Specifications

Use the following guidelines to avoid static build-up when filling an ungrounded fuel container:

- Place approved fuel container on the ground.
- DO NOT fill a fuel container while it is in the vehicle (including the cargo area).
- Keep the fuel pump nozzle in contact with the fuel container while filling.
- DO NOT use a device that would hold the fuel pump handle in the fill position.

### Fuel Filler Cap

Your fuel tank filler cap has an indexed design with a 1/8 turn on/off feature.

When fueling your vehicle:

1. Turn the engine off.
2. Carefully turn the filler cap counterclockwise 1/8 of a turn until it stops.
3. Pull to remove the cap from the fuel filler pipe.
4. To install the cap, align the tabs on the cap with the notches on the filler pipe.
5. Turn the filler cap clockwise 1/8 of a turn until it stops.

If the “Check Fuel Cap” indicator comes on and stays on after you start the engine, the fuel filler cap may not be properly installed. Turn off the engine, remove the fuel filler cap, align the cap properly and reinstall it.

**If you must replace the fuel filler cap, replace it with a fuel filler cap that is designed for your vehicle. The customer warranty may be void for any damage to the fuel tank or fuel system if the correct genuine Ford or Motorcraft fuel filler cap is not used.**



The fuel system may be under pressure. If the fuel filler cap is venting vapor or if you hear a hissing sound, wait until it stops before completely removing the fuel filler cap. Otherwise, fuel may spray out and injure you or others.



If you do not use the proper fuel filler cap, excessive pressure or vacuum in the fuel tank may damage the fuel system or cause the fuel cap to disengage in a collision, which may result in possible personal injury.

## Maintenance and Specifications

### Choosing the right fuel

Use only UNLEADED FUEL. The use of leaded fuel is prohibited by law and could damage your vehicle.

Your vehicle was not designed to use fuel or fuel additives with metallic compounds, including manganese-based additives. Studies indicate that these additives can cause your vehicle's emission control system to deteriorate more rapidly. In Canada, premium grade fuel generally contains more metallic additives than regular fuel. We recommend using regular grade fuel. In Canada, many fuels contain metallic additives, but fuels free of such additives may be available; check with your local fuel dealer.

Do not use fuel containing methanol. It can damage critical fuel system components.

Repairs to correct the effects of using a fuel for which your vehicle was not designed may not be covered by your warranty.

### Octane recommendations

Your vehicle is designed to use "Premium" unleaded gasoline with an (R+M)/2 octane rating of 91 or higher for optimum performance.

The use of gasolines with lower octane ratings may degrade performance. We do not recommend the use of gasolines labeled as "Premium" in high altitude areas that are sold with octane ratings of less than 91.

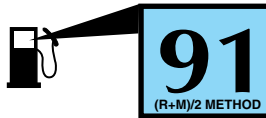

Do not be concerned if your engine sometimes knocks lightly. However, if it knocks heavily under most driving conditions while you are using fuel with the recommended octane rating, see your dealer or a qualified service technician to prevent any engine damage.

### Fuel quality

If you are experiencing starting, rough idle or hesitation driveability problems during a cold start, try a different brand of "Premium" unleaded gasoline. If the problems persist, see your dealer or a qualified service technician.

It should not be necessary to add any aftermarket products to your fuel tank if you continue to use high quality fuel of the recommended octane rating. Aftermarket products could cause damage to the fuel system. Repairs to correct the effects of using an aftermarket product in your fuel may not be covered by your warranty.

280



## Maintenance and Specifications

Many of the world's automakers approved the World-wide Fuel Charter that recommends gasoline specifications to provide improved performance and emission control system protection for your vehicle. Gasolines that meet the World-wide Fuel Charter should be used when available. Ask your fuel supplier about gasolines that meet the World-wide Fuel Charter.

### Cleaner air

Ford endorses the use of reformulated "cleaner-burning" gasolines to improve air quality.

### Running out of fuel

Avoid running out of fuel because this situation may have an adverse affect on powertrain components.

If you have run out of fuel:

- You may need to cycle the ignition from OFF to ON several times after refueling, to allow the fuel system to pump the fuel from the tank to the engine.
- Your "Check Engine" indicator may come on. For more information on the "Check Engine" indicator, refer to the *Instrument Cluster* chapter.

### Fuel Filter

For fuel filter replacement, see your dealer or a qualified service technician. Refer to the scheduled maintenance guide for the appropriate intervals for changing the fuel filter.

**Replace the fuel filter with an authorized Motorcraft part. The customer warranty may be void for any damage to the fuel system if an authorized Motorcraft fuel filter is not used.**

## ESSENTIALS OF GOOD FUEL ECONOMY

### Measuring techniques

Your best source of information about actual fuel economy is you, the driver. You must gather information as accurately and consistently as possible. Fuel expense, frequency of fill-ups or fuel gauge readings are NOT accurate as a measure of fuel economy. We do not recommend taking fuel economy measurements during the first 1,600 km (1,000 miles) of driving (engine break-in period). You will get a more accurate measurement after 3,000 km–5,000 km (2,000 miles–3,000 miles).

## Maintenance and Specifications

### Filling the tank

The advertised fuel capacity of the fuel tank on your vehicle is equal to the rated refill capacity of the fuel tank as listed in the *Refill capacities* section of this chapter.

The advertised capacity is the amount of the indicated capacity and the empty reserve combined. Indicated capacity is the difference in the amount of fuel in a full tank and a tank when the fuel gauge indicates empty. Empty reserve is the small amount of fuel remaining in the fuel tank after the fuel gauge indicates empty.

**The amount of usable fuel in the empty reserve varies and should not be relied upon to increase driving range. When refueling your vehicle after the fuel gauge indicates empty, you might not be able to refuel the full amount of the advertised capacity of the fuel tank due to the empty reserve still present in the tank.**

For consistent results when filling the fuel tank:

- Turn the engine/ignition switch to the off position prior to refueling, an error in the reading will result if the engine is left running.
- Use the same filling rate setting (low — medium — high) each time the tank is filled.
- Allow no more than 2 automatic click-offs when filling.
- Always use fuel with the recommended octane rating.
- Use a known quality gasoline, preferably a national brand.
- Use the same side of the same pump and have the vehicle facing the same direction each time you fill up.
- Have the vehicle loading and distribution the same every time.

Your results will be most accurate if your filling method is consistent.

### Calculating fuel economy

1. Fill the fuel tank completely and record the initial odometer reading (in kilometers or miles).
2. Each time you fill the tank, record the amount of fuel added (in liters or gallons).
3. After at least three to five tank fill-ups, fill the fuel tank and record the current odometer reading.
4. Subtract your initial odometer reading from the current odometer reading.
5. Follow one of the simple calculations in order to determine fuel economy:

## Maintenance and Specifications

Calculation 1: **Multiply liters used by 100, then divide by total kilometers traveled.**

Calculation 2: **Divide total miles traveled by total gallons used.**

Keep a record for at least one month and record the type of driving (city or highway). This will provide an accurate estimate of the vehicle's fuel economy under current driving conditions. Additionally, keeping records during summer and winter will show how temperature impacts fuel economy. In general, lower temperatures give lower fuel economy.

### Driving style — good driving and fuel economy habits

Give consideration to the lists that follow and you may be able to change a number of variables and improve your fuel economy.

#### **Habits**

- Smooth, moderate operation can yield up to 10% savings in fuel.
- Steady speeds without stopping will usually give the best fuel economy.
- Idling for long periods of time (greater than one minute) may waste fuel.
- Anticipate stopping; slowing down may eliminate the need to stop.
- Sudden or hard accelerations may reduce fuel economy.
- Slow down gradually.
- Driving at reasonable speeds (traveling at 88 km/h [55 mph] uses 15% less fuel than traveling at 105 km/h [65 mph]).
- Revving the engine before turning it off may reduce fuel economy.
- Using the air conditioner or defroster may reduce fuel economy.
- You may want to turn off the speed control in hilly terrain if unnecessary shifting between third and fourth gear occurs. Unnecessary shifting of this type could result in reduced fuel economy.
- Warming up a vehicle on cold mornings is not required and may reduce fuel economy.
- Resting your foot on the brake pedal while driving may reduce fuel economy.
- Combine errands and minimize stop-and-go driving.

#### **Maintenance**

- Keep tires properly inflated and use only recommended size.

## Maintenance and Specifications

- Operating a vehicle with the wheels out of alignment will reduce fuel economy.
- Use recommended engine oil. Refer to *Lubricant specifications* in this chapter.
- Perform all regularly scheduled maintenance items. Follow the recommended maintenance schedule and owner maintenance checks found in your vehicle scheduled maintenance guide.

### Conditions

- Heavily loading a vehicle may reduce fuel economy at any speed.
- Carrying unnecessary weight may reduce fuel economy (approximately 0.4 km/L [1 mpg] is lost for every 180 kg [400 lb] of weight carried).
- Adding certain accessories to your vehicle (for example bug deflectors, rollbars/light bars, running boards, ski/luggage racks) may reduce fuel economy.
- Using fuel blended with alcohol may lower fuel economy.
- Fuel economy may decrease with lower temperatures during the first 12–16 km (8–10 miles) of driving.
- Driving on flat terrain offers improved fuel economy as compared to driving on hilly terrain.
- Transmissions give their best fuel economy when operated in the top cruise gear and with steady pressure on the gas pedal.
- Close windows for high speed driving.

### EPA window sticker

Every new vehicle should have the EPA window sticker. Contact your dealer if the window sticker is not supplied with your vehicle. The EPA window sticker should be your guide for the fuel economy comparisons with other vehicles.

It is important to note the box in the lower left corner of the window sticker. These numbers represent the Range of L/100 km (MPG) expected on the vehicle under optimum conditions. Your fuel economy may vary depending upon the method of operation and conditions.

### EMISSION CONTROL SYSTEM

Your vehicle is equipped with various emission control components and a catalytic converter which will enable your vehicle to comply with applicable exhaust emission standards. To make sure that the catalytic converter and other emission control components continue to work properly:

## Maintenance and Specifications

- Use only the specified fuel listed.
- Avoid running out of fuel.
- Do not turn off the ignition while your vehicle is moving, especially at high speeds.
- Have the items listed in your *Scheduled Maintenance Guide* performed according to the specified schedule.

The scheduled maintenance items listed in the *Scheduled Maintenance Guide* are essential to the life and performance of your vehicle and to its emissions system.

If other than Ford, Motorcraft or Ford-authorized parts are used for maintenance replacements or for service of components affecting emission control, such non-Ford parts should be equivalent to genuine Ford Motor Company parts in performance and durability.



Do not park, idle, or drive your vehicle in dry grass or other dry ground cover. The emission system heats up the engine compartment and exhaust system, which can start a fire.

Illumination of the “Check Engine” light, charging system warning light or the temperature warning light, fluid leaks, strange odors, smoke or loss of engine power, could indicate that the emission control system is not working properly.



Exhaust leaks may result in entry of harmful and potentially lethal fumes into the passenger compartment.

Do not make any unauthorized changes to your vehicle or engine. By law, vehicle owners and anyone who manufactures, repairs, services, sells, leases, trades vehicles, or supervises a fleet of vehicles are not permitted to intentionally remove an emission control device or prevent it from working. Information about your vehicle's emission system is on the Vehicle Emission Control Information Decal located on or near the engine. This decal identifies engine displacement and gives some tune up specifications.

Please consult your *Warranty Guide* for complete emission warranty information.

### **On board diagnostics (OBD-II)**

Your vehicle is equipped with a computer that monitors the engine's emission control system. This system is commonly known as the On

## Maintenance and Specifications

Board Diagnostics System (OBD-II). This OBD-II system protects the environment by ensuring that your vehicle continues to meet government emission standards. The OBD-II system also assists the service technician in properly servicing your vehicle. When the *Check engine/Service engine soon* light illuminates, the OBD-II system has detected a malfunction. Temporary malfunctions may cause your *Check engine/Service engine soon* light to illuminate. Examples are:

1. The vehicle has run out of fuel. (The engine may misfire or run poorly.)
2. Poor fuel quality or water in the fuel.
3. The fuel cap may not have been securely tightened.

These temporary malfunctions can be corrected by filling the fuel tank with good quality fuel and/or properly tightening the fuel cap. After three driving cycles without these or any other temporary malfunctions present, the *Check engine/Service engine soon* light should turn off. (A driving cycle consists of a cold engine startup followed by mixed city/highway driving.) No additional vehicle service is required.

If the *Check engine/Service engine soon* light remains on, have your vehicle serviced at the first available opportunity.

### Readiness for Inspection/Maintenance (I/M) testing

In some localities, it may be a legal requirement to pass an I/M test of the on-board diagnostics system. If your *Check engine/Service engine soon* light is on, refer to the description in the *Warning lights and chimes* section of the *Instrument Cluster* chapter. Your vehicle may not pass the I/M test with the *Check engine/Service engine soon* light on.

If the vehicle's powertrain system or its battery has just been serviced, the on-board diagnostics system is reset to a "not ready for I/M test" condition. To ready the on-board diagnostics system for I/M testing, a minimum of 30 minutes of city and highway driving is necessary as described below:

- First, at least 10 minutes of driving on an expressway or highway.
- Next, at least 20 minutes driving in stop-and-go, city-type traffic with at least four idle periods.

Allow the vehicle to sit for at least eight hours without starting the engine. Then, start the engine and complete the above driving cycle. The engine must warm up to its normal operating temperature. Once started, do not turn off the engine until the above driving cycle is complete.

## Maintenance and Specifications

### POWER STEERING FLUID

Refer to the scheduled maintenance guide for the service interval schedules. If adding fluid is necessary, use only MERCON® ATF.

1. Start the engine and let it run until it reaches normal operating temperature (the engine coolant temperature gauge indicator will be near the center of the normal area between H and C).
2. While the engine idles, turn the steering wheel left and right several times.
3. Turn the engine off.
4. Check the fluid level in the reservoir. It should be between the MIN and MAX lines. Do not add fluid if the level is in this range.
5. If the fluid is low, add fluid in small amounts, continuously checking the level until it reaches the range between the MIN and MAX lines. Be sure to put the cap back on the reservoir.

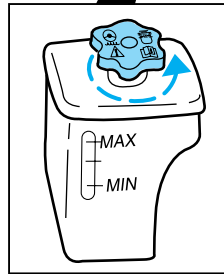
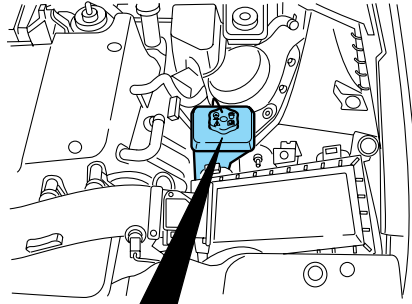

### BRAKE FLUID RESERVOIR

The fluid level will drop slowly as the brakes wear, and will rise when the brake components are replaced. Fluid levels between the "MIN" and "MAX" lines are within the normal operating range; there is no need to add fluid. If the fluid levels are outside of the normal operating range the performance of your brake system could be compromised; seek service from your dealer immediately.

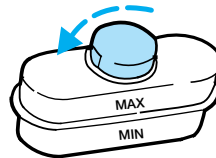

### TRANSMISSION FLUID

#### Checking automatic transmission fluid

The 5R55S transmission does not have a transmission fluid dipstick.

## Maintenance and Specifications

Refer to your *Scheduled Maintenance Guide* for scheduled intervals for fluid checks and changes. Your transmission does not consume fluid. However, the fluid level should be checked if the transmission is not working properly, i.e., if the transmission slips or shifts slowly or if you notice some sign of fluid leakage.

**Transmission fluid should be checked and, if required, fluid should be added by a qualified technician.**

Before adding any fluid, make sure the correct type is used. Use only MERCON® V automatic transmission fluid. The type of fluid used is indicated on the transmission fluid pan, extension housing and also in the *Lubricant specifications* section in this chapter.

**Use of a non-approved automatic transmission fluid may cause internal transmission component damage and void the warranty.**

Do not use supplemental transmission fluid additives, treatments or cleaning agents. The use of these materials may affect transmission operation and result in damage to internal transmission components.

### AIR FILTER MAINTENANCE

Refer to the scheduled maintenance guide for the appropriate intervals for changing the air filter element.

When changing the air filter element, use only the Motorcraft air filter element listed. Refer to *Motorcraft part numbers* in this chapter.

**Note:** Do not start your engine with the air cleaner removed and do not remove it while the engine is running.

#### Changing the air filter element

1. Loosen the hose clamp on the outlet tube at the air filter housing.

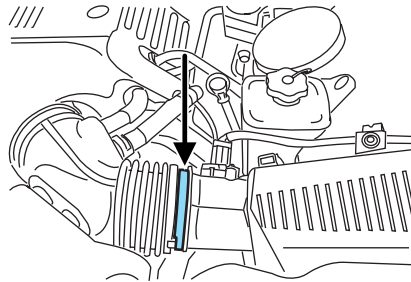



## Maintenance and Specifications

2. Release the two clamps that secure the cover to the air filter housing and place the cover aside.

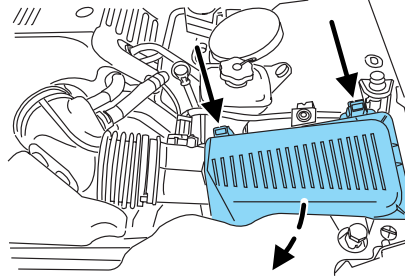

3. Remove the air filter element from the air filter housing.

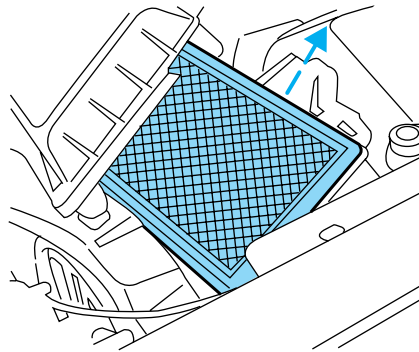

4. Wipe the air filter housing and cover clean to remove any dirt or debris and to ensure good sealing.

5. Install a new air filter element. Be careful not to crimp the filter element edges between the air filter housing and cover. This could cause filter damage and allow unmetered air to enter the engine if not properly seated.

## Maintenance and Specifications

6. Replace the air filter housing cover and secure the clamps. Be sure all of the tabs on front edge are correctly aligned as shown.

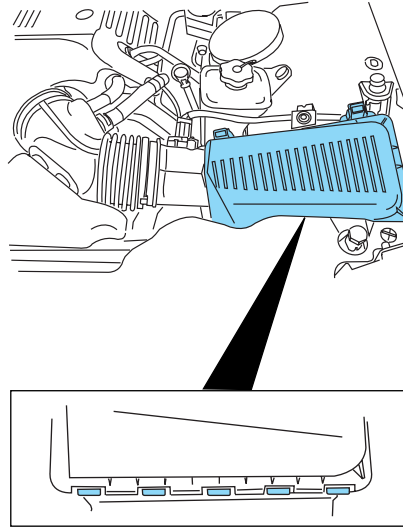

**Note:** If you encounter any difficulty in replacing your air filter element, have your vehicle serviced at your local dealer.

### INFORMATION ABOUT UNIFORM TIRE QUALITY GRADING

New vehicles are fitted with tires that have a rating on them called Tire Quality Grades. The Quality grades can be found where applicable on the tire sidewall between tread shoulder and maximum section width. For example:

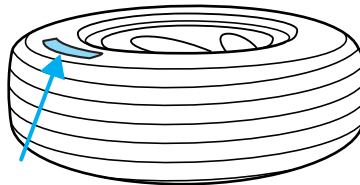

- **Treadwear 200 Traction AA Temperature A**

These Tire Quality Grades are determined by standards that the United States Department of Transportation has set.

Tire Quality Grades apply to new pneumatic tires for use on passenger cars. They do not apply to deep tread, winter-type snow tires, space-saver or temporary use spare tires, tires with nominal rim diameters of 10 to 12 inches or limited production tires as defined in Title 49 Code of Federal Regulations Part 575.104(c)(2).

## Maintenance and Specifications

**U.S. Department of Transportation-Tire quality grades:** The U.S. Department of Transportation requires Ford to give you the following information about tire grades exactly as the government has written it.

### Treadwear

The treadwear grade is a comparative rating based on the wear rate of the tire when tested under controlled conditions on a specified government test course. For example, a tire graded 150 would wear one and one-half (1 1/2) times as well on the government course as a tire graded 100. The relative performance of tires depends upon the actual conditions of their use, however, and may depart significantly from the norm due to variations in driving habits, service practices, and differences in road characteristics and climate.

### Traction AA A B C

The traction grades, from highest to lowest are AA, A, B, and C. The grades represent the tire's ability to stop on wet pavement as measured under controlled conditions on specified government test surfaces of asphalt and concrete. A tire marked C may have poor traction performance.



The traction grade assigned to this tire is based on straight-ahead braking traction tests, and does not include acceleration, cornering, hydroplaning or peak traction characteristics.

### Temperature A B C

The temperature grades are A (the highest), B and C, representing the tire's resistance to the generation of heat and its ability to dissipate heat when tested under controlled conditions on a specified indoor laboratory test wheel. Sustained high temperature can cause the material of the tire to degenerate and reduce tire life, and excessive temperature can lead to sudden tire failure. The grade C corresponds to a level of performance which all passenger car tires must meet under the Federal Motor Vehicle Safety Standard No. 109. Grades B and A represent higher levels of performance on the laboratory test wheel than the minimum required by law.



The temperature grade for this tire is established for a tire that is properly inflated and not overloaded. Excessive speed, underinflation, or excessive loading, either separately or in combination, can cause heat buildup and possible tire failure.

## Maintenance and Specifications

### TIRES

Tires are designed to give many thousands of miles of service, but they must be maintained in order to get the maximum benefit from them.

#### Glossary of tire terminology

- **Tire label:** A label showing the OE (Original Equipment) tire sizes, recommended inflation pressure and the maximum weight the vehicle can carry.
- **Tire Identification Number (TIN):** A number on the sidewall of each tire providing information about the tire brand and manufacturing plant, tire size and date of manufacture.
- **Inflation pressure:** A measure of the amount of air in a tire.
- **Standard load:** A class of P-metric or Metric tires designed to carry a maximum load at 35 psi [37 psi (2.5 bar) for Metric tires]. Increasing the inflation pressure beyond this pressure will not increase the tire's load carrying capability.
- **Extra load:** A class of P-metric or Metric tires designed to carry a heavier maximum load at 41 psi [43 psi (2.9 bar) for Metric tires]. Increasing the inflation pressure beyond this pressure will not increase the tire's load carrying capability.
- **kPa:** Kilopascal, a metric unit of air pressure.
- **PSI:** Pounds per square inch, a standard unit of air pressure.
- **B-pillar:** The structural member at the side of the vehicle behind the front door.
- **Bead area of the tire:** Area of the tire next to the rim.
- **Sidewall of the tire:** Area between the bead area and the tread.
- **Tread area of the tire:** Area of the perimeter of the tire that contacts the road when mounted on the vehicle.
- **Rim:** The metal support (wheel) for a tire or a tire and tube assembly upon which the tire beads are seated.

#### INFORMATION CONTAINED ON THE TIRE SIDEWALL

Federal law requires tire manufacturer's to place standardized information on the sidewall of all tires. This information identifies and describes the fundamental characteristics of the tire and also provides a U.S. DOT Tire Identification Number for safety standard certification and in case of a recall.

## Maintenance and Specifications

### Information on “P” type tires

P215/65R15 95H is an example of a tire size, load index and speed rating. The definitions of these items are listed below. (Note that the tire size, load index and speed rating for your vehicle may be different from this example.)

1. **P:** Indicates a tire, designated by the Tire and Rim Association (T&RA), that may be used for service on cars, SUVs, minivans and light trucks.

**Note:** If your tire size does not begin with a letter this may mean it is designated by either ETRTO (European Tire and Rim Technical Organization) or JATMA (Japan Tire Manufacturing Association).

2. **215:** Indicates the nominal width of the tire in millimeters from sidewall edge to sidewall edge. In general, the larger the number, the wider the tire.

3. **65:** Indicates the aspect ratio which gives the tire’s ratio of height to width.

4. **R:** Indicates a “radial” type tire.

5. **15:** Indicates the wheel or rim diameter in inches. If you change your wheel size, you will have to purchase new tires to match the new wheel diameter.

6. **95:** Indicates the tire’s load index. It is an index that relates to how much weight a tire can carry. You may find this information in your owner’s guide. If not, contact a local tire dealer.

**Note:** You may not find this information on all tires because it is not required by federal law.

7. **H:** Indicates the tire’s speed rating. The speed rating denotes the speed at which a tire is designed to be driven for extended periods of time under a standard condition of load and inflation pressure. The tires on your vehicle may operate at different conditions for load and inflation pressure. These speed ratings may need to be adjusted for the difference in conditions. The ratings range from 99 mph (159 km/h) to 186 mph (299 km/h). These ratings are listed in the following chart.

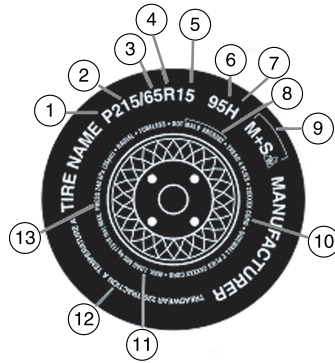

## Maintenance and Specifications

**Note:** You may not find this information on all tires because it is not required by federal law.

| Letter rating | Speed rating - mph (km/h) |
|---------------|---------------------------|
| Q             | 99 mph (159 km/h)         |
| R             | 106 mph (171 km/h)        |
| S             | 112 mph (180 km/h)        |
| T             | 118 mph (190 km/h)        |
| U             | 124 mph (200 km/h)        |
| H             | 130 mph (210 km/h)        |
| V             | 149 mph (240 km/h)        |
| W             | 168 mph (270 km/h)        |
| Y             | 186 mph (299 km/h)        |

**Note:** For tires with a maximum speed capability over 149 mph (240 km/h), tire manufacturers sometimes use the letters ZR. For those with a maximum speed capability over 186 mph (299 km/h), tire manufacturers always use the letters ZR.

**8. U.S. DOT Tire Identification Number (TIN):** This begins with the letters "DOT" and indicates that the tire meets all federal standards. The next two numbers or letters are the plant code for where it was manufactured, the next two are the tire size code and the last four numbers represent the week and year the tire was built. For example, the numbers 317 mean the 31st week of 1997. After 2000 the numbers go to four digits. For example, 2501 means the 25th week of 2001. The numbers in between are identification codes used for traceability. This information is used to contact customers if a tire defect requires a recall.

**9. M+S or M/S:** Mud and Snow. or

**AT:** All Terrain. or

**AS:** All Season.

**10. Tire Ply Composition and Material Used:** Indicates the number of plies or the number of layers of rubber-coated fabric in the tire tread and sidewall. Tire manufacturers also must indicate the ply materials in the tire and the sidewall, which include steel, nylon, polyester, and others.

## Maintenance and Specifications

11. **Maximum Load:** Indicates the maximum load in kilograms and pounds that can be carried by the tire. Refer to the tire label or the safety certification label, which is located on the B-Pillar or the edge of the driver's door, for the correct tire pressure for your vehicle

### 12. Treadwear, Traction and Temperature Grades

- **Treadwear:** The treadwear grade is a comparative rating based on the wear rate of the tire when tested under controlled conditions on a specified government test course. For example, a tire graded 150 would wear one and one-half (1½) times as well on the government course as a tire graded 100.
- **Traction:** The traction grades, from highest to lowest are AA, A, B, and C. The grades represent the tire's ability to stop on wet pavement as measured under controlled conditions on specified government test surfaces of asphalt and concrete. A tire marked C may have poor traction performance.
- **Temperature:** The temperature grades are A (the highest), B and C, representing the tire's resistance to the generation of heat and its ability to dissipate heat when tested under controlled conditions on a specified indoor laboratory test wheel.

13. **Maximum Permissible Inflation Pressure:** Tire manufacturer's maximum permissible pressure and/or the pressure at which the maximum load can be carried by the tire. This pressure is normally higher than the manufacturer's recommended cold inflation pressure which can be found on either the tire label or certification label which is located B-Pillar or the edge of the driver's door. The cold inflation pressure should never be set lower than the recommended pressure on the vehicle label.

The tire suppliers may have additional markings, notes or warnings such as standard load, radial tubeless, etc.

## Maintenance and Specifications

### Additional information contained on the tire sidewall for “LT” type tires

“LT” type tires have some additional information beyond those of “P” type tires; these differences are described below:

1. **LT:** Indicates a tire, designated by the Tire and Rim Association (T&RA), that is intended for service on light trucks.

#### 2. **Load Range/Load Inflation**

**Limits:** Indicates the tire’s load-carrying capabilities and its inflation limits.

#### 3. **Maximum Load Dual lbs. (kg)**

**at psi (kPa) cold:** Indicates the maximum load and tire pressure when the tire is used as a dual; defined as four tires on the rear axle (a total of six or more tires on the vehicle).

4. **Maximum Load Single lbs. (kg) at psi (kPa) cold:** Indicates the maximum load and tire pressure when the tire is used as a single; defined as two tires (total) on the rear axle.

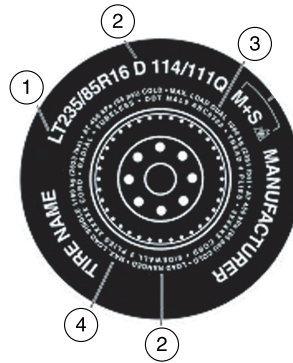



## Maintenance and Specifications

### Information on “T” type tires

T145/80D16 is an example of a tire size.

**Note:** The temporary tire size for your vehicle may be different from this example.

1. **T:** Indicates a type of tire, designated by the Tire and Rim Association (T&RA), that is intended for temporary service on cars, SUVs, minivans and light trucks.

2. **145:** Indicates the nominal width of the tire in millimeters from sidewall edge to sidewall edge. In general, the larger the number, the wider the tire.

3. **80:** Indicates the aspect ratio which gives the tire's ratio of height to width. Numbers of 70 or lower indicate a short sidewall.

4. **D:** Indicates a “diagonal” type tire.

**R:** Indicates a “radial” type tire.

5. **16:** Indicates the wheel or rim diameter in inches. If you change your wheel size, you will have to purchase new tires to match the new wheel diameter.

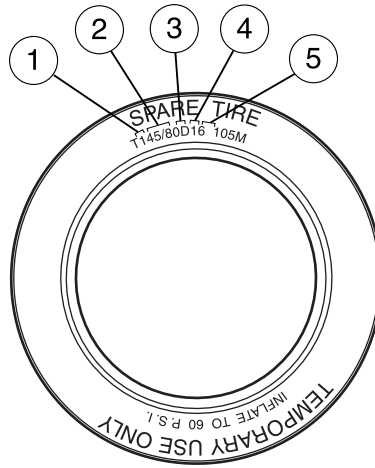

### Location of the tire label

You will find a tire label containing tire inflation pressure by tire size and other important information located on the B-Pillar or the edge of the driver's door.

## Maintenance and Specifications

### TIRE CARE

Improper or inadequate vehicle maintenance can also cause tires to wear abnormally. Here are some of the important maintenance items:

#### Inflating your tires

Use a tire gauge to check the tire inflation pressure, including the spare, at least monthly and before long trips. You are strongly urged to buy a reliable tire pressure gauge, as automatic service station gauges may be inaccurate. Ford recommends the use of a digital or dial type tire pressure gauge rather than a stick type tire pressure gauge.

Use the recommended cold inflation pressure for optimum tire performance and wear. Under-inflation or over-inflation may cause uneven treadwear patterns.



Under-inflation is the most common cause of tire failures and may result in severe tire cracking, tread separation or "blowout", with unexpected loss of vehicle control and increased risk of injury. Under-inflation increases sidewall flexing and rolling resistance, resulting in heat buildup and internal damage to the tire. It also may result in unnecessary tire stress, irregular wear, loss of vehicle control and accidents. A tire can lose up to half of its air pressure and not appear to be flat!

When weather temperature changes occur, tire inflation pressures also change. A 10° F (6° C) temperature drop can cause a corresponding drop of 1 psi (7 kPa) in inflation pressure. Check your tire pressures frequently and adjust them to the proper pressure which can be found on the tire label or certification label.

If you are checking tire pressure when the tire is hot, (i.e. driven more than 1 mile [1.6 km]), never "bleed" or reduce air pressure. The tires are hot from driving and it is normal for pressures to increase above recommended cold pressures. A hot tire at or below recommended cold inflation pressure could be significantly under-inflated.

To check the pressure in your tire(s):

1. Make sure the tires are cool, meaning they are not hot from driving even a mile.

**Note:** If you have to drive a distance to get air for your tire(s), check and record the tire pressure first and add the appropriate air pressure when you get to the pump. It is normal for tires to heat up and the air pressure inside to go up as you drive. Never "bleed" or reduce air pressure when tires are hot.

## Maintenance and Specifications

2. Remove the cap from the valve on one tire, then firmly press the tire gauge onto the valve and measure the pressure.

3. Add enough air to reach the recommended air pressure

**Note:** If you overfill the tire, release air by pushing on the metal stem in the center of the valve. Then recheck the pressure with your tire gauge.

4. Replace the valve cap.

5. Repeat this procedure for each tire, including the spare.

**Note:** Some spare tires require higher inflation pressure than the other tires. Check the tire label on the B pillar or the edge of the driver's door for the recommended spare tire pressure.

6. Visually inspect the tires to make sure there are no nails or other objects embedded that could poke a hole in the tire and cause an air leak.

7. Check the sidewalls to make sure there are no gouges, cuts or bulges.

### Tire and wheel alignment

A bad jolt from hitting a curb or pothole can cause the front end of your vehicle to become misaligned or cause damage to your tires. If your vehicle seems to pull to one side when you're driving, the wheels may be out of alignment. Have a qualified technician at a Ford or Lincoln/Mercury dealer check the wheel alignment periodically.

Wheel misalignment in the front or the rear can cause uneven and rapid treadwear of your tires and should be corrected by a qualified technician at a Ford or Lincoln/Mercury dealer. Front wheel drive (FWD) vehicles and those with an independent rear suspension require alignment of all four wheels.

The tires should also be balanced periodically. An unbalanced tire and wheel assembly may result in irregular tire wear.

### Tire rotation

Rotating your tires at the recommended interval (as indicated in the *Scheduled Maintenance Guide* that comes with your vehicle) will help your tires wear more evenly, providing better tire performance and longer tire life. Unless otherwise specified, rotate the tires approximately every 5,000 miles (8,000 km).

## Maintenance and Specifications

- Front Wheel Drive (FWD) vehicles (front tires at top of diagram)

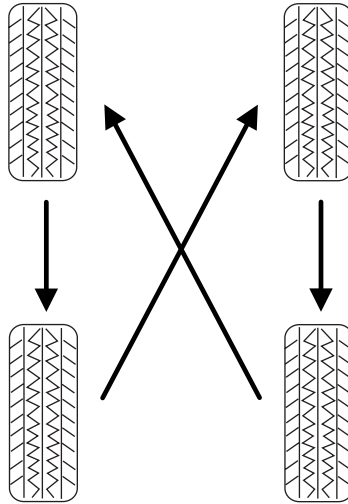

- Rear Wheel Drive (RWD) vehicles/Four Wheel Drive (4WD) vehicles (front tires at top of diagram)

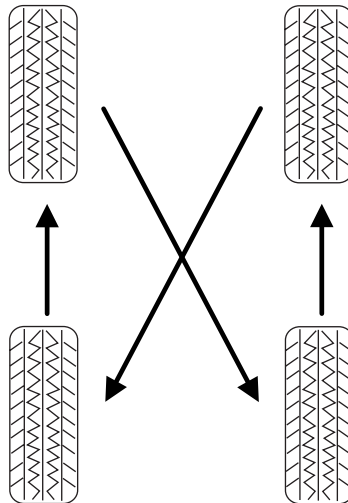

## Maintenance and Specifications

Sometimes irregular tire wear can be corrected by rotating the tires.

**Note:** If your tires show uneven wear ask a qualified technician at a Ford or Lincoln/Mercury dealership to check for and correct any wheel misalignment, tire imbalance or mechanical problem involved before tire rotation.

**Note:** Your vehicle may be equipped with a dissimilar spare tire/wheel. A dissimilar spare tire/wheel is defined as a spare tire and/or wheel that is different in brand, size or appearance from the road tires and wheels. If you have a dissimilar spare tire/wheel it is intended for temporary use only and should not be used in a tire rotation.

**Note:** After having your tires rotated, inflation pressure must be checked and adjusted to the vehicle requirements.

### Tire wear

Measure and inspect the tire tread on all your tires periodically. Advanced and unusual tire wear can reduce the ability of tread to grip the road in adverse (wet, snowy, etc.) conditions. Visually check your tires for uneven wear, looking for high and low areas or unusually smooth areas. Also check for signs of tire damage.

When the tread is worn down to 1/16th of an inch (2 mm), tires must be replaced to prevent your vehicle from skidding and hydroplaning.

Built-in treadwear indicators, or “wear bars”, which look like narrow strips of smooth rubber across the tread will appear on the tire when the tread is worn down to 1/16th of an inch (2 mm). When you see these “wear bars”, the tire is worn out and should be replaced.

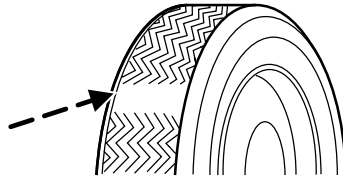

Inspect your tires frequently for any of the following conditions and replace them if one or more of the following conditions exist:

- Fabric showing through the tire rubber
- Bulges in the tread or sidewalls
- Cracks or cuts on the sidewalls
- Cracks in the tread groove
- Impact damage resulting from use
- Separation in the tread
- Separation in the sidewall

## Maintenance and Specifications

- Severe abrasion on the sidewall

If your vehicle has a leak in the exhaust system, a road tire or the spare tire may be exposed to hot exhaust temperatures requiring the tire to be replaced.

### Tire Replacement Requirements

Your vehicle is equipped with tires designed to provide safe ride and handling capability.



Only use replacement tires and wheels that are the same size and type (such as P-metric versus LT-metric or all-season versus all-terrain) as those originally provided by Ford. Use of any tire or wheel not recommended by Ford can affect the safety and performance of your vehicle, which could result in an increased risk of loss of vehicle control, vehicle rollover, personal injury and death. Additionally the use of non-recommended tires and wheels could cause steering, suspension, axle or transfer case/power transfer unit failure. If you have questions regarding tire replacement, see an authorized Ford or Lincoln/Mercury dealer.

Make sure all tires and wheels on the vehicle are of the same size, type, tread design, brand, load-carrying capacity and speed rating because it can affect the safety and performance of your vehicle, which could result in an increased risk of loss of vehicle control, vehicle rollover, personal injury and death.

You should replace the spare tire when you replace the other road tires due to the aging of the spare tire.

### Safety practices

Driving habits have a great deal to do with your tire mileage and safety.

- Observe posted speed limits
- Avoid fast starts, stops and turns
- Avoid potholes and objects on the road
- Do not run over curbs or hit the tire against a curb when parking

If your vehicle is stuck in snow, mud, sand, etc., **do not** rapidly spin the tires; spinning the tires can tear the tire and cause an explosion. A tire can explode in as little as three to five seconds.

## Maintenance and Specifications



Tire explosions can cause death, personal injury or property damage. Do not allow anyone to stand near, directly ahead or behind the spinning tire.



Never spin the tires in excess of the 35 mph (55 km/h) point indicated on the speedometer.

### **Highway hazards**

No matter how carefully you drive there's always the possibility that you may eventually have a flat tire on the highway. Drive slowly to the closest safe area out of traffic. This may further damage the flat tire, but your safety is more important.

If you feel a sudden vibration or ride disturbance while driving, or you suspect your tire or vehicle has been damaged, immediately reduce your speed. Drive with caution until you can safely pull off the road. Stop and inspect the tires for damage. If a tire is under-inflated or damaged, deflate it, remove wheel and replace it with your spare tire and wheel. If you cannot detect a cause, have the vehicle towed to the nearest repair facility or tire dealer to have the vehicle inspected.

### **SNOW TIRES AND CHAINS**



Snow tires must be the same size and grade as the tires you currently have on your vehicle.

The tires on your vehicle have all weather treads to provide traction in rain and snow. However, in some climates, you may need to use snow tires or chains.

Follow these guidelines when using snow tires and chains:

- Use only SAE Class S chains with P225/55R16 tires.
- Do not use tire chains with size P235/50R17 tires. Use of SAE Class S chains or other chain types may damage your vehicle.
- Install chains securely, verifying that the chains do not touch any wiring, brake lines or fuel lines.
- Drive cautiously. If you hear the chains rub or bang against your vehicle, stop and re-tighten the chains. If this does not work, remove the chains to prevent damage to your vehicle.
- If possible, avoid fully loading your vehicle.

## Maintenance and Specifications

- Remove the tire chains when they are no longer needed. Do not use tire chains on dry roads.
- The suspension insulation and bumpers will help prevent vehicle damage. Do not remove these components from your vehicle when using snow tires or chains.

### MOTORCRAFT PART NUMBERS

| Component          | 3.0L-4V V6 engine | 3.9L-4V V8 engine |
|--------------------|-------------------|-------------------|
| Air filter element | FA-1679           | FA-1679           |
| Fuel filter        | FG-1011           | FG-1011           |
| Battery (standard) | BXT-66-650        | BXT-66-650        |
| Battery (optional) | BXT-66-750        | BXT-66-750        |
| Oil filter         | FL-400S           | FL-218            |
| PCV valve          | <sup>1</sup>      |                   |
| Spark plugs        | <sup>2</sup>      |                   |

<sup>1</sup>The PCV valve is a critical emission component. It is one of the items listed in the *Scheduled Maintenance Guide* and is essential to the life and performance of your vehicle and to its emissions system.

For PCV valve replacement, see your dealer or a qualified service technician. Refer to the *Scheduled Maintenance Guide* for the appropriate intervals for changing the PCV valve.

**Replace the PCV valve with one that meets Ford material and design specifications for your vehicle, such as a Motorcraft or equivalent replacement part. The customer warranty may be void for any damage to the emissions system if such a PCV valve is not used.**

<sup>2</sup>For spark plug replacement, see your dealer or a qualified service technician. Refer to the *Scheduled Maintenance Guide* for the appropriate intervals for changing the spark plugs.

**Replace the spark plugs with ones that meet Ford material and design specifications for your vehicle, such as Motorcraft or equivalent replacement parts. The customer warranty may be void for any damage to the engine if such spark plugs are not used.**

Refer to Vehicle Emissions Control Information (VECI) decal for spark plug gap information.



## Maintenance and Specifications

### REFILL CAPACITIES

| Fluid  | Ford Part Name  | Application       | Capacity                         |
|--|---|-------------------|----------------------------------|
| Brake fluid                                      | Motorcraft High Performance DOT 3 Motor Vehicle Brake Fluid <sup>1</sup>            | All               | Fill to MAX line on reservoir    |
| Engine oil (includes filter change) <sup>6</sup> | Motorcraft SAE 5W-20 Premium Synthetic Blend Motor Oil (US)                         | 3.0L-4V V6 engine | 6.5L (6.9 quarts)                |
|  | Motorcraft SAE 5W-20 Super Premium Motor Oil (Canada)                               | 3.9L-4V V8 engine | 6.2L (6.5 quarts)                |
| Engine coolant <sup>2</sup>                      | Motorcraft Premium Gold Engine Coolant (yellow-colored)                             | 3.0L-4V V6 engine | 10.6L (11.2 quarts)              |
|  |   | 3.9L-4V V8 engine | 11.3L (11.9 quarts)              |
| Power steering fluid                             | Motorcraft MERCON® ATF  | All               | Fill to MAX line on reservoir    |
| Rear axle <sup>3</sup>                           | Motorcraft SAE 75W-90 Fuel Efficient High Performance Synthetic Rear Axle Lubricant | All               | 1.2-1.3L (2.5-2.7 pints)         |
| Fuel tank  | N/A   | All               | 68.2L (18.0 gallons)             |
| Transmission fluid <sup>4</sup>                  | Motorcraft MERCON®V ATF   | Automatic (5R55S) | 11.2L (11.9 quarts) <sup>5</sup> |
| Windshield washer fluid                          | Motorcraft Premium Windshield Washer Concentrate                                    | All               | Fill to line on reservoir        |

## Maintenance and Specifications

<sup>1</sup>Use only brake fluids certified to meet Ford specifications. Refer to *Lubricant Specifications* in this chapter. DOT 3 fluid is recommended. However, if DOT 3 is not available, DOT 4 fluid can be used.

<sup>2</sup>Add the coolant type originally equipped in your vehicle.

<sup>3</sup>Your vehicle's rear axle is filled with a synthetic rear axle lubricant and is considered lubricated for life. These lubricants do not need to be checked or changed unless a leak is suspected, service is required or the axle assembly has been submerged in water. The axle lubricant should be changed any time the rear axle has been submerged in water. Fill 6 mm to 14 mm (1/4 inch to 9/16 inch) below bottom of fill hole.

<sup>4</sup>Ensure the correct automatic transmission fluid is used. MERCON® and MERCON® V are not interchangeable. DO NOT MIX MERCON® and MERCON® V. Refer to the *Scheduled Maintenance Guide* to determine the correct service interval.

<sup>5</sup>Approximate dry capacity, includes cooler and tubes. Fluid level should be checked by a qualified service technician.

<sup>6</sup>Use of synthetic or synthetic blend motor oil is not mandatory. Engine oil need only meet the requirements of Ford specification WSS-M2C153-H and the API Certification mark.

### LUBRICANT SPECIFICATIONS

| Item  | Ford part name   | Ford part number | Ford specification          |
|---|--|------------------|-----------------------------|
| Brake fluid   | Motorcraft High Performance DOT 3 Motor Vehicle Brake Fluid <sup>1</sup> | PM-1             | ESA-M6C25-A and DOT 3       |
| Door weatherstrips  | Silicone Lubricant   | XL-6             | ESR-M13P4-A                 |
| Door latch, hood latch, auxiliary hood latch, door hinges, striker plates, seat tracks and fuel filler door hinge | Multi-Purpose Grease   | XG-4 or XL-5     | ESR-M1C159-A or ESB-M1C93-B |

## Maintenance and Specifications

| Item                         | Ford part name   | Ford part number   | Ford specification                       |
|------------------------------|--|--|--|
| Engine coolant               | Motorcraft Premium Gold Engine Coolant (yellow-colored)  | VC-7-A (U.S., except CA and OR), VC-7-B (CA and OR only) | WSS-M97B51-A1                            |
| Engine oil (all engines)     | Motorcraft SAE 5W-20 Premium Synthetic Blend Motor Oil (US)<br>Motorcraft SAE 5W-20 Super Premium Motor Oil (Canada) | XO-5W20-QSP (US)<br>CXO-5W20-LSP12 (Canada)              | WSS-M2C153-H with API Certification Mark |
| Lock cylinders               | Motorcraft Penetrating and Lock Lubricant  | Motorcraft XL-1  | none                                     |
| Power steering fluid         | Motorcraft MERCON® ATF   | XT-2-QDX   | MERCON®                                  |
| Rear Axle Lubricant          | Motorcraft SAE 75W-90 Fuel Efficient High Performance Synthetic Rear Axle Lubricant <sup>2</sup>                     | XY-75W90-QFEHP   |  |
| Automatic transmission fluid | Motorcraft MERCON®V ATF <sup>3</sup>   | XT-5-QM  | MERCON®V                                 |
| Windshield washer fluid      | Premium Windshield Washer Concentrate  | ZC-32-A  | WSB-M8B16-A2                             |

<sup>1</sup>Use only brake fluids certified to meet Ford specifications. DOT 3 fluid is recommended. However, if DOT 3 is not available, DOT 4 fluid can be used.

<sup>2</sup>Ford design rear axles contain a synthetic lubricant that does not require changing unless the axle has been submerged in water.

<sup>3</sup>Ensure the correct automatic transmission fluid is used. MERCON® and MERCON® V are not interchangeable. DO NOT MIX MERCON® and MERCON® V. Refer to the *Scheduled Maintenance Guide* to determine the correct service interval.

## Maintenance and Specifications

### ENGINE DATA

| Engine            | 3.0L-4V V6 engine  | 3.9L-4V V8 engine  |
|-------------------|--------------------|--------------------|
| Displacement      | 2 968 cc (181 cid) | 3 949 cc (241 cid) |
| Required fuel     | 91 octane          | 91 octane          |
| Firing order      | 1-4-2-5-3-6        | 1-5-4-2-6-3-7-8    |
| Ignition system   | Coil on plug       | Coil on plug       |
| Compression ratio | 10.5:1             | 10.75:1            |

### VEHICLE DIMENSIONS

| Vehicle dimensions | Inches (mm)  |
|--------------------|--------------|
| (1) Overall length | 193.9 (4925) |
| (2) Overall width  | 73.2 (1859)  |
| (3) Overall height | 56.0 (1424)  |
| (4) Wheelbase      | 114.5 (2909) |
| (5) Tread - Front  | 60.6 (1540)  |
| (5) Tread - Rear   | 60.7 (1543)  |

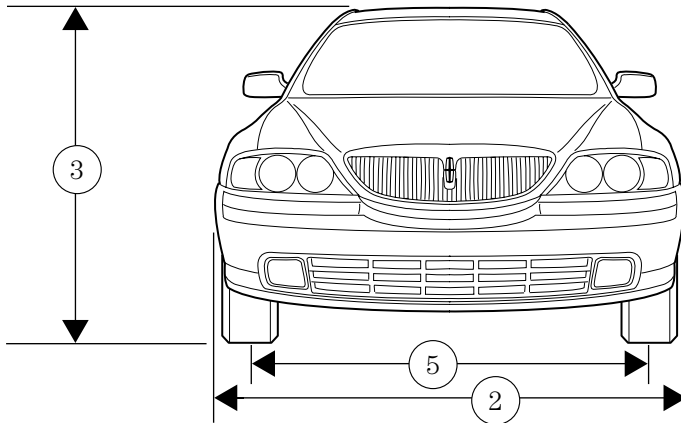

## Maintenance and Specifications

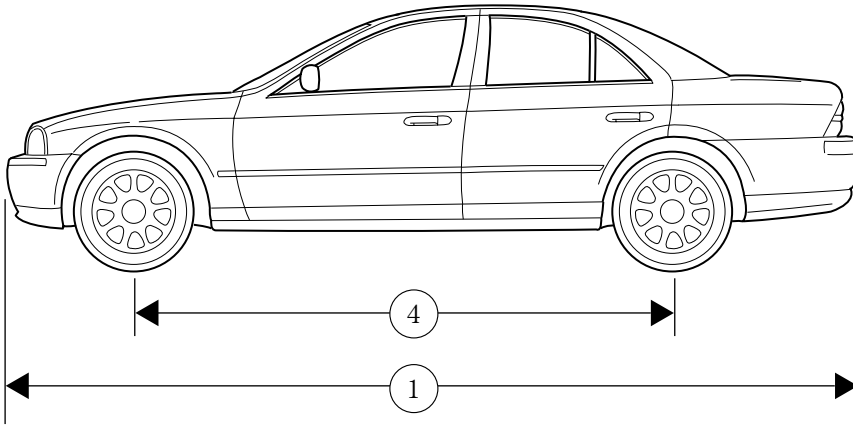

### IDENTIFYING YOUR VEHICLE

#### Vehicle identification number (VIN)

The vehicle identification number is attached to a metal tag and is located on the driver side instrument panel. (Please note that in the graphic XXXX is representative of your vehicle identification number.)

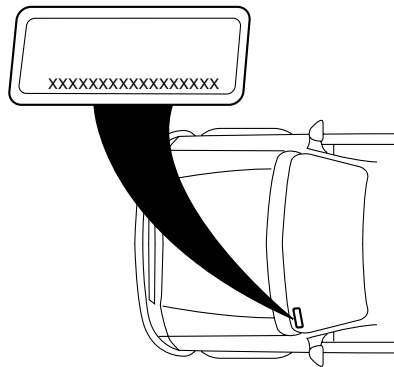

1. World manufacturer identifier
2. Brake type and gross vehicle weight rating (GVWR)
3. Vehicle line, series, body type
4. Engine type
5. Check digit
6. Model year

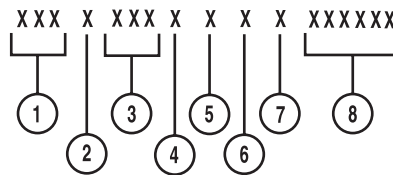

## Maintenance and Specifications

7. Assembly plant
8. Production sequence number

### Engine number

The engine number (the last eight numbers of the vehicle identification number) is stamped on the engine block, transmission, frame and transfer case (if equipped).

### Transmission/Transaxle code designations

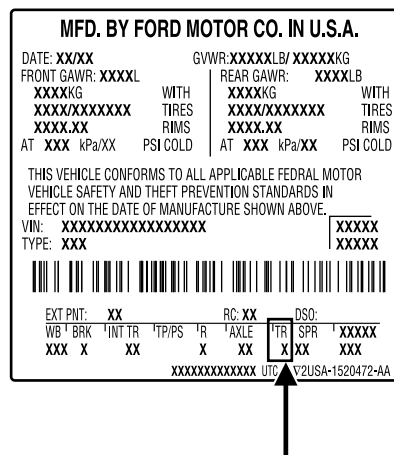

You can find a transmission/transaxle code on the vehicle certification label. The following table tells you which transmission or transaxle each code represents.

#### Truck application:

| Code | Transmission Description               |
|------|--|
|      | <i>Manual transmission</i>             |
| M    | Manual 5-speed (AKK)                   |
| C    | Manual 5-speed overdrive (Close ratio) |
| W    | Manual 5-speed overdrive (Dana ZF)     |
| G    | Manual 6-speed ZF                      |
|      | <i>Automatic transmission</i>          |

## Maintenance and Specifications

| Code | Transmission Description            |
|------|-------------------------------------|
| Y    | Automatic 4-speed overdrive (CD4E)  |
| U    | Automatic 4-speed overdrive (4R70W) |
| T    | Automatic 4-speed overdrive (4R44E) |
| E    | Automatic 4-speed overdrive (4R100) |
| J    | Automatic 5-speed overdrive (5R55E) |
|      | <i>Electric</i>                     |
| H    | One speed electric                  |
| D    | Automatic 5-speed overdrive (5R44E) |
| R    | Automatic 5-speed overdrive (5R55S) |

**Passenger car application:**

| Code | Transmission/Transaxle Description             |
|------|--|
|      | <i>Front wheel drive manual transaxle</i>      |
| R    | 5-speed overdrive (MTX75)                      |
| W    | 5-speed overdrive (M5)                         |
|      | <i>Front wheel drive automatic transaxle</i>   |
| A    | 4-speed overdrive (4F27E)                      |
| E    | 4-speed overdrive (4FE)                        |
| J    | 3-speed (Mazda)                                |
| L    | 4-speed overdrive (AX4S)                       |
| P    | 4-speed overdrive (4F20E)                      |
| X    | 4-speed overdrive (4F50N)                      |
| Y    | 4-speed overdrive (CD4E)                       |
|      | <i>Rear wheel drive manual transaxle</i>       |
| 5    | 5-speed (Mazda M5)                             |
|      | <i>Rear wheel drive automatic transmission</i> |
| U    | 4-speed overdrive (4R70W)                      |
| A    | 5-speed overdrive (5R55N)                      |

## Accessories

### LINCOLN ACCESSORIES FOR YOUR VEHICLE

A wide selection of Genuine Lincoln Accessories are available for your vehicle through your local authorized Lincoln or Ford of Canada dealer. These quality accessories have been specifically engineered to fulfill your automotive needs; they are custom designed to complement the style and aerodynamic appearance of your vehicle. In addition, each accessory is made from high quality materials and meets or exceeds Lincoln's rigorous engineering and safety specifications. Ford Motor Company will repair or replace any properly dealer-installed Genuine Lincoln Accessory found to be defective in factory-supplied materials or workmanship during the warranty period, as well as any component damaged by the defective accessory. The accessory will be warranted for whichever provides you the greatest benefit:

- 12 months or 12,000 miles (20,000 km) (whichever occurs first), or
- the remainder of your new vehicle limited warranty.

This means that Genuine Lincoln Accessories purchased along with your new vehicle and installed by the dealer are covered for the full length of your New Vehicle's Limited Warranty — 4 years or 50,000 miles (80,000 km) (whichever occurs first). Contact your dealer for details and a copy of the warranty.

#### **Not all accessories are available for all models.**

Following is a list of several Genuine Lincoln Accessory products. Not all accessories are available for all models. To find out what accessories are available for your vehicle, please contact your dealer or visit our online store at: [www.lincolnaccessories.com](http://www.lincolnaccessories.com).

#### **Exterior style**

Bug shields  
Deflectors  
Exterior trim kits  
Front end covers  
Grille inserts  
Headlamps, fog lights and Daytime Running Lamps (DRLs)  
Splash guards  
Wheels

#### **Interior style**

Cell phone holders  
Electrochromatic compass/temperature interior mirrors

312



## Accessories

Floor mats  
Interior trim kits  
Leather wrapped steering wheels  
Scuff plates  
Speed control

### **Lifestyle**

Bike racks  
Cargo organization and management  
Engine block heaters and blankets

### **Peace of mind**

Airbag anti-theft locks  
First aid and safety kits  
Full vehicle covers  
Locking gas cap  
Navigation systems  
Remote start  
Vehicle security systems

For maximum vehicle performance, keep the following information in mind when adding accessories or equipment to your vehicle:

- When adding accessories, equipment, passengers and luggage to your vehicle, do not exceed the total weight capacity of the vehicle or of the front or rear axle (GVWR or GAWR as indicated on the Safety Compliance Certification label). Consult your dealer for specific weight information.
- The Federal Communications Commission (FCC) and Canadian Radio Telecommunications Commission (CRTC) regulate the use of mobile communications systems — such as two-way radios, telephones and theft alarms - that are equipped with radio transmitters. Any such equipment installed in your vehicle should comply with FCC or CRTC regulations and should be installed only by a qualified service technician.
- Mobile communications systems may harm the operation of your vehicle, particularly if they are not properly designed for automotive use.

## Index

### A

- Accessory delay .....112
- AdvanceTrac .....208
- Air bag supplemental restraint system .....177–178, 182, 185
  - and child safety seats .....179
  - description .....178, 182, 185
  - disposal .....189
  - driver air bag .....180, 183, 187
  - indicator light .....181, 184, 188
  - operation .....180, 183, 187
  - passenger air bag ...180, 183, 187
  - side air bag .....182, 185
- Air cleaner filter .....288, 304
- Air conditioning .....90, 92
- Antifreeze
  - (see Engine coolant) .....271
- Anti-lock brake system
  - (see Brakes) .....204–205
- Anti-theft system .....155
  - arming the system .....156
  - disarming a triggered system .....156
- Audio system (see Radio) ...17, 21
- Automatic transmission
  - driving an automatic
  - overdrive .....211
  - fluid, adding .....287
  - fluid, checking .....287
  - fluid, refill capacities .....305
  - fluid, specification .....308
- Axle
  - lubricant specifications ..306, 308
  - refill capacities .....305

### B

- Battery .....269

314

- acid, treating emergencies ....269
- jumping a disabled battery ....240
- maintenance-free .....269
- replacement, specifications ...304
- servicing .....269
- BeltMinder .....173
- Brakes .....204
  - anti-lock .....204–205
  - anti-lock brake system (ABS)
    - warning light .....205
  - fluid, checking and adding ....287
  - fluid, refill capacities .....305
  - fluid, specifications .....306, 308
  - lubricant specifications ..306, 308
  - parking .....205
  - shift interlock .....210
- Bulbs .....102

### C

- Capacities for refilling fluids ...305
- Cargo net .....141
- Cell phone use .....126
- Changing a tire .....235
- Child safety restraints .....190
  - child safety belts .....190
- Child safety seats .....192
  - attaching with tether straps ..196
  - in front seat .....194
  - in rear seat .....194
- Cleaning your vehicle
  - engine compartment .....257
  - instrument panel .....259
  - interior .....260
  - interior trim .....259
  - plastic parts .....258
  - washing .....256
  - waxing .....256
  - wheels .....257

## Index

- wiper blades .....259
- Climate control (see Air conditioning or Heating) .....90, 92
- Clock adjust
  - 6-CD in dash .....19
  - AM/FM/Tape/CD .....23
- Compass, electronic .....113
  - calibration .....114
  - set zone adjustment .....114
- Console .....140
  - overhead .....109–110
- Controls
  - power seat .....158
  - steering column .....119
- Coolant
  - checking and adding .....271
  - refill capacities .....275, 305
  - specifications .....306, 308
- Cruise control (see Speed control) .....116
- Customer Assistance .....223
  - Ford accessories for your vehicle .....261
  - Ford Extended Service Plan .....249
  - Getting assistance outside the U.S. and Canada .....253
  - Getting roadside assistance ...223
  - Getting the service you need .....247
  - Ordering additional owner's literature .....254
  - The Dispute Settlement Board .....249
  - Utilizing the Mediation/Arbitration Program .....252
- D**
  - Daytime running lamps (see Lamps) .....99
  - Defrost
    - rear window .....97
  - Dipstick
    - automatic transmission
      - fluid .....287
      - engine oil .....266
  - Doors
    - central unlocking .....143
    - lubricant specifications .....306
  - Driving under special conditions .....215
    - through water .....218
- E**
  - Emergencies, roadside
    - jump-starting .....240
  - Emergency Flashers .....224
  - Emission control system .....284
  - Engine .....308
    - cleaning .....257
    - coolant .....271
    - fail-safe coolant .....276
    - idle speed control .....269
    - lubrication
      - specifications .....306, 308
      - refill capacities .....305
      - service points .....264–265
  - Engine block heater .....204
  - Engine oil .....266
    - checking and adding .....266
    - dipstick .....266
    - filter, specifications .....268, 304
    - recommendations .....268
    - refill capacities .....305

## Index

- specifications .....306, 308
- Exhaust fumes .....204
- F**
- Fail safe cooling .....276
- Floor mats .....140
- Fluid capacities .....305
- Foglamps .....99
- Fuel .....277
  - calculating fuel
  - economy .....129, 281
  - cap .....279
  - capacity .....305
  - choosing the right fuel .....280
  - comparisons with EPA fuel
  - economy estimates .....284
  - detergent in fuel .....281
  - filling your vehicle with
  - fuel .....277, 279, 282
  - filter, specifications .....281, 304
  - improving fuel economy .....281
  - octane rating .....280, 308
  - quality .....280
  - running out of fuel .....281
  - safety information relating to
  - automotive fuels .....277
- Fuses .....225–226
- G**
- Garage Door Opener  
(see Homelink wireless control  
system) .....123
- Gas cap (see Fuel cap) .....279
- Gas mileage  
(see Fuel economy) .....281
- Gauges .....15
- H**
- Hazard flashers .....224
- Head restraints .....157, 162
- Headlamps .....98
  - aiming .....100
  - autolamp system .....98
  - bulb specifications .....102
  - daytime running lights .....99
  - flash to pass .....100
  - replacing bulbs .....103–104
  - turning on and off .....98
- Heating
  - heating and air conditioning  
system .....90, 92
- Homelink wireless control  
system .....123
- Hood .....263
- I**
- Ignition .....201, 308
- Infant seats  
(see Safety seats) .....192
- Inspection/maintenance (I/M)  
testing .....286
- Instrument panel
  - cleaning .....259
  - cluster .....10
  - lighting up panel and  
interior .....100
- J**
- Jack .....235
  - positioning .....235
  - storage .....235
- Jump-starting your vehicle .....240
- K**
- Keyless entry system .....151
  - autolock .....150

## Index

- Keys .....142  
positions of the ignition .....201  
valet key .....142
- L**
- Lamps  
autolamp system .....98  
bulb replacement  
specifications chart .....102  
daytime running light .....99  
fog lamps .....99  
headlamps .....98  
headlamps, flash to pass .....100  
instrument panel, dimming ...100  
interior lamps .....102–103  
replacing bulbs .....102–106
- Lane change indicator  
(see Turn signal) .....101
- Lights, warning and indicator ...10  
anti-lock brakes (ABS) .....205
- Load limits .....218
- Locks  
autolock .....150  
childproof .....144  
doors .....142
- Lubricant specifications ...306, 308
- Lug nuts .....240
- Luggage rack .....141
- Lumbar support, seats .....158
- M**
- Message center .....127–128  
select button .....127  
warning messages .....131
- Mirrors .....109, 112  
automatic dimming rearview  
mirror .....112
- fold away .....116  
heated .....115  
programmable memory .....151  
side view mirrors (power) ....115
- Moon roof .....122
- Motorcraft parts .....281, 304
- N**
- Navigation system .....25  
cd functions .....43  
destination mode .....67  
DVD location .....89  
map mode .....47  
quick start .....27  
radio functions .....35
- O**
- Octane rating .....280
- Oil (see Engine oil) .....266
- P**
- Parking brake .....205
- Parts (see Motorcraft parts) ...304
- Pedals (see Power adjustable  
foot pedals) .....116
- Power adjustable foot pedals ...116
- Power distribution box  
(see Fuses) .....229, 232
- Power door locks .....142
- Power point .....110
- Power steering .....206–207  
fluid, checking and adding ...287  
fluid, refill capacity .....305  
fluid, specifications .....306, 308
- Power Windows .....111

## Index

### R

- Radio .....17, 21
- Rear Park Assist .....216
- Rear window defroster .....97
- Relays .....225
- Remote entry system .....146
  - opening the trunk .....148
- Roadside assistance .....223
- Roof rack .....141

### S

- Safety Belt Maintenance .....177
- Safety belts (see Safety restraints) .....164, 167–170, 172
- Safety Canopy .....182
- Safety defects, reporting .....255
- Safety restraints .....164, 167–172
  - belt minder .....173
  - extension assembly .....176
  - for adults .....168–170
  - for children .....189–190
  - safety belt maintenance .....177
  - warning light and chime .....172
- Safety seats for children .....192
- Seat belts  
(see Safety restraints) .....164
- Seats .....157
  - child safety seats .....192
  - climate control .....161
  - memory seat .....151, 160
- Select Shift Transmission  
(SST) shifter .....213
- Servicing your vehicle .....262
- Setting the clock
  - AM/FM/In-dash 6 CD .....19

- AM/FM/Tape/CD .....23
- Spark plugs,  
specifications .....304, 308
- Specification chart,  
lubricants .....306, 308
- Speed control .....116
- Starting your vehicle .....201–203
  - jump starting .....240
- Steering
  - speed sensitive .....207
- Steering column lock .....109
- Steering wheel
  - controls .....119
  - tilting .....108

### T

- Tilt steering wheel .....108
- Tires .....235, 290–292
  - alignment .....299
  - care .....298
  - changing .....235, 237
  - checking the pressure .....298
  - label .....297
  - replacing .....302
  - rotating .....299
  - safety practices .....302
  - sidewall information .....292
  - snow tires and chains .....303
  - spare tire .....235–236
  - terminology .....292
  - tire grades .....291
  - treadwear .....291, 301
- Towing .....222
  - recreational towing .....222
  - trailer towing .....222
  - wrecker .....246
- Traction control .....207
- Transmission .....210

## Index

- brake-shift interlock (BSI) ....210  
fluid, checking and adding  
  (automatic) .....287  
fluid, refill capacities .....305  
lubricant specifications ..306, 308  
Trunk .....144  
  remote release .....138, 148  
Turn signal .....101
- V**
- Vehicle dimensions .....308  
Vehicle Identification Number  
  (VIN) .....309  
Vehicle loading .....218
- Ventilating your vehicle .....204
- W**
- Warning lights (see Lights) .....10  
Washer fluid .....266  
Water, Driving through .....218  
Windows  
  power .....111  
Windshield washer fluid and  
  wipers .....107  
  checking and adding fluid ....266  
  replacing wiper blades .....107  
Wrecker towing .....246

