

•CONCEALED SCREW SURFACE BOLTS  
•CONCEALED SCREW SLIDE BOLTS

**No. 40**

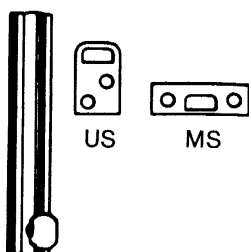

**Nos. 84**

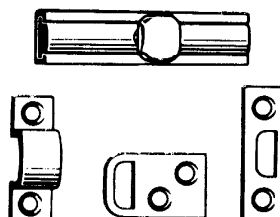

Solid Brass  
Lengths: No. 84 — 2 1/2"

**No. 144**

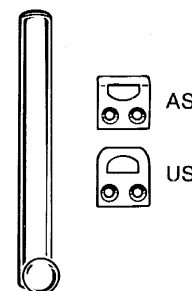

Solid Brass  
Lengths: 4", 6", 9", 12"

**WE NOW CARRY THE IVES LINE OF HINGES  
SEE PAGE 299**

**40 CONCEALED SCREW SURFACE BOLTS**

An outstanding line of modern surface bolts. Made of hand polished, extruded brass and aluminum

Extremely strong and durable with interlocking construction and heavy gauge track and rod. Concealed rod installation; no marring of bolt. Tension spring holds bolt in position. Width: 5/8". Projection: 3/4".

Individually polybagged with screws and both universal and mortise strike. 10 per box. (Surface strike available on special order.)

Code	Length	Throw	Finish	Price
IV40B26-3	3"	11/16"	Bright Chrome	15.70
IV40B26D-3	3"	11/16"	Satin Chrome	15.70
IV40B3-3	3"	11/16"	Polished Brass	15.00
IV40B26-4	4"	15/16"	Bright Chrome	16.50
IV40B26D-4	4"	15/16"	Satin Chrome	16.50
IV40B3-4	4"	15/16"	Polished Brass	15.70
IV40B26-6	6"	15/16"	Bright Chrome	19.20
IV40B26D-6	6"	15/16"	Satin Chrome	19.20
IV40B3-6	6"	15/16"	Polished Brass	18.50
IV40B26D-9	9"	15/16"	Satin Chrome	24.00

**144 CONCEALED SCREW SURFACE BOLTS**

Fully concealed, three-screw easy installation. With stainless steel tension spring that eliminates creep and prevents rod pull-out. 5/8" diameter half round rod; 1" projection; 1" throw.

Hand Polished Brass. Individually polybagged; 5 per box. Supplied with Universal and Angle strikes and hex key wrench.

Code	Length	Throw	Finish	Price
IV144B26-4	4"	1"	Polished Chrome	23.80
IV144B26-9	9"	1"	Polished Chrome	26.80
IV144B26-12	12"	1"	Polished Chrome	32.30

**MODERN SLIDE BOLTS**

Hand Polished Brass. Polybagged with screws; 10 per box. Supplied with Surface, Mortise and Universal strikes.

Code	Length	Throw	Finish	Price
IV84B3	2 1/2"	9/16"	Polished Brass	14.44

- STRAPLESS SURFACE BOLTS
- CHAIN DOOR GUARDS
- DELUXE SECURITY BOLTS

### STRAPLESS SURFACE BOLTS

Exclusive Ives stainless steel tension spring prevents rod "pull-outs" and insures permanent spring tension. Attractive, semi-concealed guides assure smooth operation and eliminate rod marring. Knobs, rods and guides are attractively styled and well proportioned.

Solid Hand Polished Brass. Individually polybagged with screws. 043 and 43 -10 per box; 143 -5 per box. Supplied with both Universal and Angle strikes. 143 furnished with guides in 12" length.

**Nos. 043, 43**

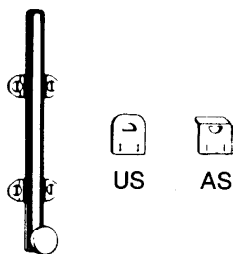

Solid Brass or Steel  
 No. 043 Lengths: 2", 3", 4", 6"  
 Brass only: 9"  
 No. 43 Lengths: 4", 6"  
 Brass only: 9", 12"

**No. 143**

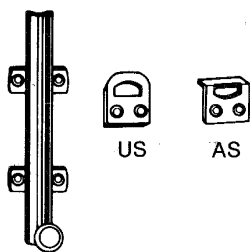

Solid Brass  
 Lengths: 6", 9", 12"

B = Brass      F = Steel

Code	Length	Half-Round Rod	Guides	Throw	Finish	Price
IV043B26-2	2"	3/8"	1 3/16"	3/8"	Polished Chrome	14.40
IV043B26-3	3"	3/8"	1 3/16"	3/4"	Polished Chrome	14.40
IV043B26-4	4"	3/8"	1 3/16"	3/4"	Polished Chrome	15.40
IV043B26-6	6"	3/8"	1 3/16"	3/4"	Satin Chrome	16.30
IV043F3-2	2"	3/8"	1 3/16"	3/4"	Brass Plate	4.21
IV043F3-12	12"	3/8"	1 3/16"	3/4"	Brass Plate	16.24
IV043F14-2	2"	3/8"	1 3/16"	3/4"	Bright Nickel	4.24
IV043F14-3	3"	3/8"	1 3/16"	3/4"	Bright Nickel	5.60
IV043F14-4	4"	3/8"	1 3/16"	3/4"	Bright Nickel	5.37
IV043F14-6	6"	3/8"	1 3/16"	3/4"	Bright Nickel	5.88
IV43B26-4	4"	1/2"	1 3/8"	1"	Satin Chrome	17.10
IV43B26-6	6"	1/2"	1 3/8"	1"	Polished Chrome	19.10
IV43B26-9	6"	1/2"	1 3/8"	1"	Polished Chrome	24.50
IV43B26D-9	9"	1/2"	1 3/8"	1"	Satin Chrome	24.50
IV43B26-12	12"	1/2"	1 3/8"	1"	Satin Chrome	31.40
IV43F3-4	4"	1/2"	1 3/8"	1"	Brass Plate	5.50
IV43F3-9	9"	1/2"	1 3/8"	1"	Brass Plate	5.50
IV43F3-12	12"	1/2"	1 3/8"	1"	Brass Plate	5.50
IV143B26-9	9"	5/8"	1 1/2"	1"	Bright Chrome	22.94
IV143B26-12	12"	5/8"	1 1/2"	1"	Bright Chrome	27.72
IV143B26D-12	12"	5/8"	1 1/2"	1"	Satin Chrome	27.72

### DELUXE SECURITY BOLTS

For the ultimate strength, security and simplicity in installation, with crisp and contemporary styling that blends with various door styles. Solid strength, hand polished brass bolt - 5/16" diameter, securely and permanently housed in an oversized precision-designed extrusion of solid brass.

The creep-proof bolt remains positively locked or unlocked. Full 5/8" throw. Individually polybagged, with three strikes and eight recessed head screws. 10 per box.

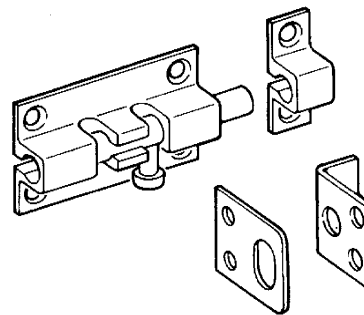

Solid Brass  
 Lengths: No. 87 — 2 1/4"

Code	Length	Width	Projection	Throw	Finish	Price
IV87B26D	2 1/4"	1 1/4"	15/32"	5/8"	Bright Chrome	24.20
IV87B3	2 1/4"	1 1/4"	15/32"	5/8"	Polished Brass	22.10

### CHAIN DOOR GUARDS

Economy model. Design, detail and finish of the finest quality craftsmanship. Welded twist link steel chain. Unusually narrow 11/16" chain holder for modern trims. Individually polybagged with sheet metal screws; 10 per box.



Solid Brass or Steel  
 Plate: 3 1/4" x 1 7/16"  
 Holder: 1 1/16" x 1 7/8"

B = Brass      F = Steel

Code	Finish	Price
IV481B3	Polished Brass	10.70
IV481B26	Bright Chrome	10.90
IV481B26D	Satin Chrome	12.50
IV481F4	Satin Brass	5.90
IV481F5	Antique Brass	6.70
IV481F10	Satin Bronze	6.70
IV481F15	Satin Nickel	5.90
IV481F26	Bright Chrome	5.90
IV481F26D	Satin Chrome	5.90
IV481F716	Aged Bronze	6.90

## DELUXE HEAVY DUTY SOLID BRASS SURFACE BOLTS

Rugged and handsome bolts for heavy doors. Extra heavy, 5/8" half round brass rod with 1 1/4" diameter knob. Bolts - 18" long and over. Furnished with three guides. Hand Polished Solid Brass. Packed with screws and one strike; 5 per box. Specify strike required.

**No. 253**

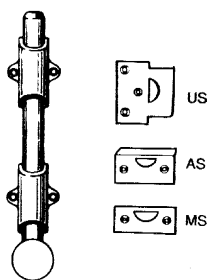

Solid Brass  
Lengths:  
8", 12", 18", 24", 30", 36"

**No. 353**

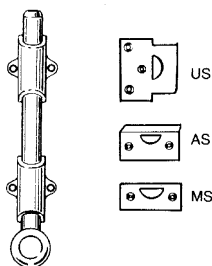

Solid Brass  
Length: 8", 12", 18", 24"

**No. 354**

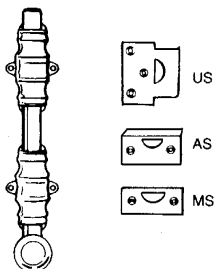

Solid Brass  
Length: 8", 12", 18", 24"

**No. 054**

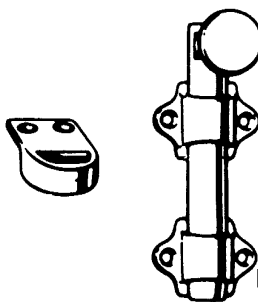

Solid Brass  
Rod length: 4 1/4"

**No. 54**

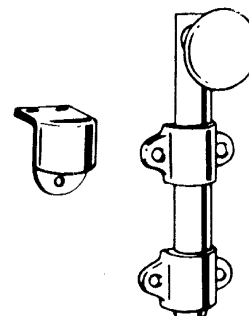

Solid Brass  
Rod length: 4 1/4"

**No. 56**

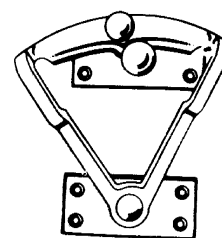

Solid Brass or Bronze  
Size: 4 1/2" H. x 4 1/2" W.  
Base: 2 3/4" x 1 1/4"

## DUTCH DOOR BOLTS

Practical, rugged and attractive; for use on Dutch doors and areas requiring extra security. Easy to operate, even against weather stripping. Crisp design, enhanced by a 1 1/4" knob. Chamfered rod end draws the two leaves of the door tightly together. Guides and strikes are cast, while the rod is made of heavy 5/8" stock. 4 1/4" length. Hand Polished Brass. Individually polybagged. Comes w/standard strike & screws.

Code	Width of Guide	Half-Round Rod	Throw	Finish	Price
IV054MB3	1 5/8"	5/8"	5/8"	Polished Brass	43.40
IV054MB15A	1 5/8"	5/8"	5/8"	Satin Nickel, Black	49.20
IV54B26	1 5/8"	5/8"	3/4"	Bright Chrome	51.54
IV55B26	1 5/8"	5/8"	3/4"	Bright Chrome	64.90
IV55B5	1 5/8"	5/8"	3/4"	Antique Brass	64.90

Code	Length	Width of Guides	Throw	Finish	Price
IV253B3-8	8"	1 9/16"	1 1/8"	Polished Brass	61.90
IV253B3-12	12"	1 9/16"	1 1/8"	Polished Brass	81.40

IV353B5-18	18"	1 9/16"	1 1/8"	Antique Brass	99.60
IV353B26-12	12"	1 9/16"	1 1/8"	Polished Chrome	82.10
IV353B10B-18	18"	1 9/16"	1 1/8"	Dark Bronze	104.10

IV354B26D-8	8"	1 3/4"	7/8"	Satin Chrome	108.10
IV354B10B-12	12"	1 3/4"	7/8"	Dark Bronze	133.10
IV354B26D-12	12"	1 3/4"	7/8"	Satin Chrome	133.10
IV354B5-24	24"	1 3/4"	7/8"	Antique Brass	171.50

## DUTCH DOOR QUADRANT-NON HANDED

Exclusive design, used to secure the top and bottom Dutch Doors - the most attractive and rugged non-handed Dutch quadrant available. Combines artistry craftsmanship and engineering excellence. Base: 2 3/4" x 1 1/4". Overall Height: 4 1/2". Overall Width: 4 1/2" Hand Polished Bronze. Individually boxed with screws.

IV56B5	Antique Brass	84.10
--------	---------------	-------



**Accredited Lock Supply**

www.acclock.com

**SLIDING DOOR EDGE PULL**

Rugged construction, quality made edge pull, finished to Ives' exacting specifications. Ideal for sliding doors. 3/4" width facilitates installation on thin doors. A spring automatically returns lever flush with plate.

Size: 3 7/8" x 3/4" x 1 5/8". Conforms with Federal Spec. No. 1861.

Hand Polished Wrought Brass plate and Extruded Brass lever. Individually polybagged with screws; 10 per box.

IV230B3	Polished Brass	12.00
IV230B5	Antique Brass	13.20
IV230B26	Bright Chrome	13.80
IV230B26D	Satin Chrome	13.80

**DOOR EDGE PULL**

**No. 230**



Solid Brass  
Size: 3 7/8" x 3/4" x 1 5/8"

**MORTISE DOOR BOLTS**

Hand polished brass knobs and escutcheons. 1 3/4" Strike; 1/2" Bolt. Individually polybagged with screws.



**STEEL BOLT**

Strong and smooth operating. Brass case.

Code	Backset	Throw	Finish	Price
IVS48B3	1 3/4"	1/2"	Polished Brass	15.90
IVS48B26D	1 3/4"	1/2"	Polished Brass	18.40

**DOOR GUARD**

Maintains security while door is slightly open.

Solid Brass. Arm Length: 4 3/4".

IV482B26	Bright Chrome	32.50
IV482B26D	Satin Chrome	32.50
IV482B3	Polished Brass	29.50
IV482B10	Satin Bronze	32.50
IV482B10B	Dark Bronze	32.50
IV482B15	Satin Nickel	44.60



**Aluminum**

IV482A26	Bright Chrome	10.40
IV482A26D	Satin Chrome	10.40
IV482A3	Polished Brass	8.80

**DUST PROOF STRIKES**

For Use With All IVES Automatic, Self-Latching and Manual Flush Bolts



Floor and/or threshold  
Solid Brass  
Size: 3 1/2" x 1 5/8"



Threshold only  
Solid Brass  
Fits 1 1/16" hole

Will not lock up or down. Spring tension calibrated for positive closing and eliminates binding. DP1 plate used for flush floor conditions.

IVDP1-3	Polished Brass	23.50
IVDP1-10	Satin Bronze	23.50
IVDP1-26D	Satin Chrome	23.50
IVDP2-3	Polished Brass	29.70
IVDP2-26D	Satin Chrome	29.70

**DOOR COORDINATORS FOR LABELED FIRE DOORS**

Reversible, low friction, automatic coordinating devices for use on pairs of doors with or without astragal to prevent the active door from closing ahead of the inactive door. Used on labeled fire doors with Ives automatic flush bolts. Exclusive design incorporates unique cam tour and nylon coated strike, in conjunction with a nylon roller which reduces friction as well the critical requirements of installation.

Nylon coated strike plate enables single-screw, centerpoint mounting for simplified installation. The drop of the arm is muffled by shock absorbing polyurethane foam tape.

Solid Brass. One per box, with installation instruction, sheet metal and machine screws for door bracket, wood and machine screws for strike plate, and coordinator base.

**Nos. 469, 469 1/2**

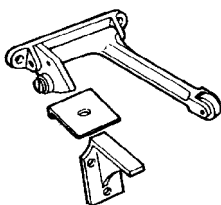

Solid Brass  
U.L. Listed  
469 - 6 3/4" Projection  
469 1/2" - 8 1/2" Projection

**COR7G (469)**

No Astragal or Astragal on Active Door - Doors from 3'4" to 4'.

Astragal on Inactive Door - Doors from 2'4" to 3'4".

Astragal on Both Doors - Doors from 2'4" to 2'10".

IVCOR7G-26D	Satin Chrome	63.60
IVCOR7G-10	Satin Bronze	76.50
IVCOR7G-10B	Dark Bronze	76.50



**COR9G (469 1/2)**

U.L. Listed for use as fire exit hardware. Conforms to Federal Spec. NO. 836.

Astragal on Inactive Door - Doors over 3'4".

Astragal on Both Doors - Doors over 2'10".

IVCOR9G-3	Polished Brass	86.50
IVCOR9G-4	Satin Brass	86.50
IVCOR9G-10	Satin Bronze	86.50
IVCOR9G-26	Polished Chrome	103.20
IVCOR9G-26D	Satin Chrome	72.90

**•AUTOMATIC FLUSH BOLTS  
•HINGES**

**AUTOMATIC FLUSH BOLTS FOR LABELED METAL AND WOOD FIRE DOORS**

Designed for hollow-metal, steel-covered or wood-covered composite fire door applications only. Recommended for doors that are normally held open or subject to low frequency use. Installed, top and bottom, on inactive leaf of a pair of doors. Fits 1 3/8" - 2 1/4" thick doors.

With positive latching and automatic unlatching features. Top and bottom bolts with full 15/16" throw; backset: 3/4". Bolt heads are equipped with bi-metal thermal lock safety device. Carry bar not required for astragal protection.

Brass. Nickel-plated, corrosion resistant shaft assembly. Packed one pair per box, with template and instructions for installation.

**AUTOMATIC LOCKING FEATURE**

When both fire doors are closed the ROD HEADS (top and bottom) will extend approximately 15/16" (23.8") beyond guides. During normal operation when active door is opened, bolts will retract and inactive door will be free to open. However, during a fire, when the temperature reaches about 170-180 degrees F. (76.7-82.2C.) the bi-metal locking arms on the rod heads begin to spread. These arms prevent the rod heads from retracting and keep the inactive door permanently locked.

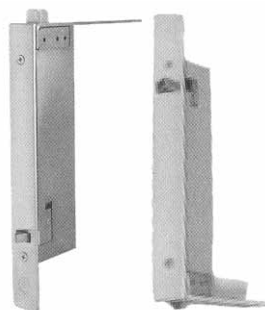

**FB41P**

Listed for use on the inactive leaf of a pair of classified wood-covered composite fire doors, swinging in pairs, not exceeding 1 1/2 hour fire rating or 8 feet in height. Simplified router mortise installation at the top and bottom corners of the door.

Furnished with sheet metal screws for bolts and strikes, and lead shields for the optional installation of standard bottom strike in a concrete floor. Sheet metal screws and shims furnished for wear plates. Machine screws for 1 3/4" standard door and bearing washers also supplied to reinforce door cutout.

**183<sup>10</sup>** per pair  
One pair in a box.

**ILFB41P-32D**  
**ILFB41P-3**

Satin Stainless Steel  
Polished Brass

**FB31P**

Listed for use on the inactive leaf of a pair of classified hollow-metal fire doors with a maximum rating of three hours, not exceeding 9 feet in height; and on steel covered composite fire doors not exceeding 8 feet high. Fits standard A.N.S.I door and frame preparation. Built-in, self-aligning rods(axial play); no height adjustment required.

Machine screws furnished for bolts, guides and standard strikes; sheet metal screws and lead shields for optional installation of standard bottom strike in concrete floor. Shims, sheet-metal and machine screws furnished for wear plate.

**No. 559**

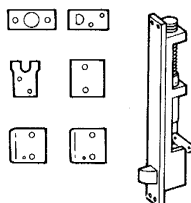

**IVFB31P-32D**  
**IVFB31P-3**

**175<sup>10</sup>** per pair

Satin Chrome  
Polished Brass

One pair in a box.

Steel and Brass  
Components  
For metal doors  
U.L. Listed

**ARCHITECTURAL HINGES**



**3CB1**

- For standard weight doors
- Medium frequency usage
- Packed with wood and machine screws

**3CB1HW for Heavy Weight Doors**

Available in these sizes:  
4.5" x 4.5"  
4.5" x 4"  
5" x 4.5" (3CB1HW)

Specify NRP for non-removable pin

Available in the following finishes:

- |     |                         |
|-----|-------------------------|
| 600 | Primed for Paint        |
| 605 | Bright Brass (3CB1HW)   |
| 630 | Satin Stainless Steel   |
| 632 | Bright Brass            |
| 633 | Satin Brass             |
| 639 | Satin Bronze            |
| 643 | Satin Bronze, Blackened |
| 651 | Bright Chrome           |
| 652 | Satin Chrome            |



**3PB1**

- For standard weight doors
- Low frequency usage
- Packed with wood and machine screws

Available in these sizes:  
4.5" x 4.5"  
4.5" x 4"

Available in the following finishes:

- |     |                         |
|-----|-------------------------|
| 600 | Primed for Paint        |
| 630 | Satin Stainless Steel   |
| 632 | Bright Brass            |
| 633 | Satin Brass             |
| 639 | Satin Bronze            |
| 643 | Satin Bronze, Blackened |
| 651 | Bright Chrome           |
| 652 | Satin Chrome            |

*Not for use with a door closer*

**Spring Hinge**



**3SP1**

- For automatic closing of doors
- Packed with wood and machine screws

Available in these sizes:  
4.5" x 4.5"

Available in the following finishes:

- |     |                         |
|-----|-------------------------|
| 600 | Primed for Paint        |
| 630 | Satin Stainless Steel   |
| 632 | Bright Brass            |
| 633 | Satin Brass             |
| 639 | Satin Bronze            |
| 643 | Satin Bronze, Blackened |
| 651 | Bright Chrome           |
| 652 | Satin Chrome            |

**•FLUSH BOLTS  
•U.L. LABELED EXTENSION FLUSH BOLTS**

**FLUSH BOLTS**

Individually polybagged with screws.

**Nos. 261, 262, 266**

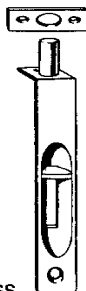

Solid Brass  
No. 261-4" x 3/4"  
No. 262-6" x 3/4"  
No. 266-6 x 3/4"

**No. 263, 264, 265**



No. 263  
Solid Brass  
Size: 5" x 3/4"  
  
Nos. 264, 265  
Solid Brass  
and Aluminum  
No. 264  
Size: 4 1/2" x 3/4"  
No. 265  
Size: 6" x 3/4"

**261**

High quality compact cast flush bolt. Deep cut provides good finger hold for easy operation. Unique spring design holds bolt automatically in retracted or projected position.

Code	Finish of Rod	Backset	Dia. of Bolt Head	Bolt Head Material	Throw	Price
IV261B26D	Satin Chrome	15/32"	5/16"	Brass	3/4"	<b>20.70</b>
IV261B3	Polished Brass	15/32"	5/16"	Brass	3/4"	<b>18.10</b>

**262**

Exceptionally smooth working, superior quality cast flush bolt. Double action spring design provides automatic holding of bolt in projected or retracted position.

Code	Finish of Rod	Backset	Dia. of Bolt Head	Bolt Head Material	Throw	Price
IV262B26D	Satin Chrome	15/32"	1/2"	Brass	1"	<b>30.40</b>
IV262B3	Polished Brass	15/32"	1/2"	Brass	1"	<b>26.40</b>

**263**

Moderately priced, deluxe quality line of hand polished, cast flush bolts. Designed for easy, fast, low cost installation. Features rounded face plate and lip for simplified door preparation. Deep cup finger hole and double action spring combine to ease both the operation and automatic holding of the bolt in either projected or retracted position.

Code	Finish of Rod	Backset	Dia. of Bolt Head	Bolt Head Material	Throw	Price
IV263B26D	Satin Chrome	15/32"	5/16"	Brass	3/4"	<b>20.70</b>
IV263B3	Polished Brass	15/32"	5/16"	Brass	3/4"	<b>18.00</b>
IV263B5	Antique Brass	15/32"	5/16"	Brass	3/4"	<b>20.70</b>

**264**

Compact, moderately priced, deluxe quality cast flush bolt. Extra long lip permits applications in a variety of construction designs.

Code	Finish of Rod	Backset	Dia. of Bolt Head	Bolt Head Material	Throw	Price
IV264B26D	Satin Chrome	15/32"	5/16"	Brass	3/4"	<b>20.70</b>
IV264B3	Polished Brass	15/32"	5/16"	Brass	3/4"	<b>18.00</b>

**No. 358**



**No. 458**



**No. 457**



Standard 457B and 458B extension flush bolts have been listed by Underwriters Laboratories for use on Class A, B, C, D, and E labeled doors.

**358 LABELED WOOD DOOR EXTENSION FLUSH BOLT**

Specifically designed for installation in all types of labeled wood covered composite doors. Requires only simple router mortise at top and bottom corners of the door. Top and bottom strikes comply with A.N.S.I. standard dimensions for manual bolts. Fits 1 3/8" to 2 1/4" thick doors. Not available for Rabbeted door installation.

Individually polybagged; two per box, with template, sheet metal screws for bolts and strikes, and machine screws (for standard 1 3/4" thick door) and bearing washers to reinforce door cutout.

Code	Finish of Rod	Backset	Dia. of Bolt Head	Bolt Head Material	Throw	Price
IVFB358-10B	Dark Bronze	3/4"	1/2"	Brass	3/4"	<b>34.00</b>
IVFB358-26D	Satin Chrome	3/4"	1/2"	Brass	3/4"	<b>34.00</b>
IVFB358-3	Polished Brass	3/4"	1/2"	Brass	3/4"	<b>34.00</b>

**457 and 458 EXTENSION FLUSH BOLTS FOR METAL DOORS**

Listed for use in hollow metal, metal clad, steel covered composite and sheet metal doors. Provides simplified installation in metal frames - round bolt head requires only a punched hole; use of strike optional. Specially designed guide and the bolt's flat side prevents turning.

Standard rod length: 12". Extruded Brass.

Packed with combination machine and wood screws for all parts.

Code	Finish of Rod	Backset	Dia. of Bolt Head	Bolt Head Material	Throw	Price
IVFB457-10	Satin Bronze	3/4"	1/2"	Brass	3/4"	<b>25.20</b>
IVFB457-26D	Satin Chrome	3/4"	1/2"	Brass	3/4"	<b>25.20</b>
IVFB457-3	Polished Brass	3/4"	1/2"	Brass	3/4"	<b>25.20</b>
IVFB457-10B	Dark Bronze	3/4"	1/2"	Brass	3/4"	<b>25.20</b>

IVFB458-10	Satin Bronze	3/4"	1/2"	Brass	3/4"	<b>21.30</b>
IVFB458-26D	Satin Chrome	3/4"	1/2"	Brass	3/4"	<b>19.90</b>
IVFB458-3	Polished Brass	3/4"	1/2"	Brass	3/4"	<b>21.30</b>
IVFB458-10B	Dark Bronze	3/4"	1/2"	Brass	3/4"	<b>21.30</b>



**•SELF LATCHING FLUSH BOLTS  
•HEAVY DUTY SECURITY SURFACE BOLTS**

**SELF-LATCHING FLUSH BOLTS**

U.L. Listed. Brass Components. Specially designed for installation in pairs on the inactive leaf of paired door openings where the inactive leaf is not required for exit purposes. Doors must be equipped with a coordinator. *Sold in pairs.*

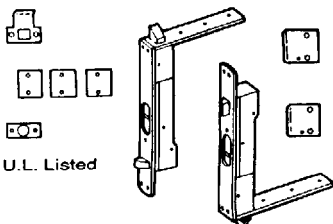

**IVFB61P-3** Polished Brass  
**IVFB61P-10** Satin Bronze  
**IVFB61P-32** Polished Stainless Steel  
**IVFB61P-32D** Satin Stainless Steel

**184<sup>80</sup>**

**FB61P FOR WOOD DOORS**

Used with labeled wood-covered composite fire doors not exceeding a 1 1/2 hour fire rating in 8 feet in height.

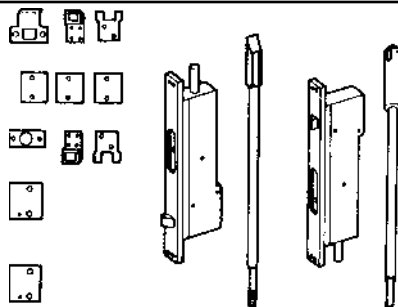

**IVFB51P-32D** Satin Stainless Steel  
**IVFB51P-3** Polished Brass  
**IVFB51P-10** Satin Bronze

**175<sup>10</sup>**

**FB51P FOR METAL DOORS**

Used for labeled hollow metal fire doors, not exceeding 9 feet in height, and on steel-covered composite fire doors, not exceeding 8 feet in height; both with a maximum rating of three hours.

Fits ANSI A115.4 door preparation for manual bolts. Spring actuated; manually retracted.

*Sold in pairs.*

**HEAVY DUTY SECURITY SURFACE BOLTS**

Listed by Underwriters Laboratories for use on the inactive leaf of a pair of doors.

- Standard Surface Bolt has 1" throw
- Ideal for all types of doors
- Fully concealed mounting prevents vandalism
- Available in locking version. Unit locks in both the up and down position. Locking bolts are furnished with 2 keys in 4 keying variations.
- Units packed with wood and machine screws to meet most field conditions.
- Constructed of heavy duty steel
- UL listed up to 3 hours when used on the inactive door of a pair up to 8' in height.
- Meets ANSI/BHMA A156.16, L84161

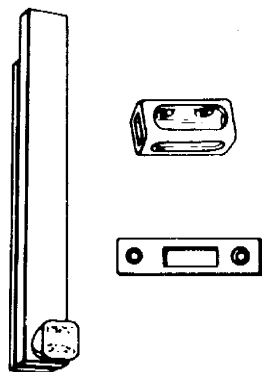

Steel  
 Concealed Screws  
 Length: 8"

U.L. Listed

**SB1630 CONCEALED SCREW SECURITY SURFACE BOLT**

**Body:** 8" long x 7/8" wide x 3/4" thick

**Overall Knob or Lock Housing Projection:** 1 1/2"

**Top Strike:** 1 1/4" wide x 7/8" tall x 15/16" deep

**Bottom Strike:** 3" long x 1" wide x 1/8" thick

<b>IVSB1630B-26D</b>	Bottom Bolt	Satin Chrome	<b>54.00</b>
<b>IVSB1630BL-26D</b>	Locking Top Bolt	Satin Chrome	<b>98.20</b>
<b>IVSB1630T-2G</b>	Top Bolt	Zinc Plated	<b>42.10</b>
<b>IVSB1630T-26D</b>	Top Bolt	Satin Chrome	<b>59.40</b>
<b>IVSB1630TB-10B</b>	Top/Bottom Bolt	Dark Bronze	<b>103.50</b>
<b>IVSB1630TBL-10B</b>	Top/Bottom Locking	Dark Bronze	<b>133.60</b>
<b>IVSB1630TBL-26D</b>	Top/Bottom Locking	Satin Chrome	<b>117.60</b>
<b>IVSB1630TL-26D</b>	Top/Bottom	Satin Chrome	<b>106.80</b>

**SB453 SURFACE BOLT**

Hand polished, all-steel construction for heavy duty use. Rod: 3/4" wide x 1/4" thick. 1 3/16" extra long throw for added security. 1 5/16" projection with an overall width of 2 1/32".

Individually polybagged with strike specified, and both machine and sheet metal screws.



Code	Length	Finish	Price
<b>IVSB453-8-TB-2C</b>	8"	Zinc	<b>38.30</b>
<b>IVSB453-12-TB-2C</b>	12"	Zinc	<b>48.30</b>
<b>IVSB453-8-TB-10</b>	8"	Satin Bronze	<b>46.10</b>
<b>IVSB453-12-TB-10</b>	12"	Satin Bronze	<b>51.60</b>
<b>IVSB453-8-TB-26D</b>	8"	Satin Chrome	<b>47.20</b>
<b>IVSB453-12-TB-26D</b>	12"	Satin Chrome	<b>59.60</b>

**SB454 SECURITY SURFACE BOLT**

Designed specifically to prevent manipulation. Positively holds bolt in locked position. Hand polished, all-steel construction for heavy duty use. Rod: 3/4" wide x 1/4" thick. 1 3/16" extra long throw for added security. 1 5/16" projection with an overall width of 2 1/32"

8" and 12": Individually polybagged with U.S. and M.S. template, and both machine and sheet metal screws. 5": Individually polybagged, packed with U.S., with 1/8" shim, installation and sheet screws only.



Code	Length	Finish	Price
<b>IVSB454-12-TB-10</b>	12"	Satin Bronze	<b>43.5</b>



B

**Accredited Lock Supply**

www.acclock.com

**•DOOR SILENCERS**

- Metal Frame
- Wood Frame

**•HINGE PIN DOOR STOP**

- FLEXIBLE DOOR STOP

**•ROLLER BUMPERS**

**“QUICK STALL” FLEXIBLE DOOR STOP**

Burnished Wrought Steel. Safe, practical, simple to install. Individually polybagged, 50 per box; with sheet metal screws for wood or metal application.

Code	Projection	Finish	Price
IV060F14	3"	Bright Nickel	1.00
IV060F3	3"	Bright Brass	1.00
IV061F14	4"	Bright Nickel	1.10
IV061F3	4"	Bright Brass	1.10

Nos. 060, 061



Steel  
No. 060 Projection: 3"  
No. 061 Projection: 4"

No. 69



Steel  
Door Openings: 70°–100°  
Replacement tip:  
IV09-310

No. 70

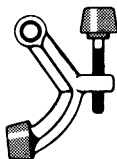

Aluminum  
Door Openings: 85°–125°  
Replacement tip:  
IVWSPART.1075

**HINGE PIN FOR DOOR STOPS**

The solution for locations where the installation of a standard door stop creates problems. Can be used on most types of hinged doors, while protecting walls, furniture and doors. Removable bushings accommodate 1/4" to 5/16" diameter hinge pins.

**69**

Burnished Wrought Steel. Positive slip-proof adjustment for door opening from 70;dg to 100;dg. Unbreakable, heavy gauge steel for a lifetime of service. Individually polybagged; 20 per box.

IV69F3	Bright Brass	4.00
--------	--------------	------

**70**

Burnished Cast Aluminum. For narrow trim installation. Provides a wide range of angular adjustment, from 85° to 125°. Permanently molded and cross-section designed. Features high quality rubber bumpers.

IV70A3	Polished Brass	2.10
IV70A92	Aluminum	2.10

**ROLLER BUMPERS**

Hand Polished Cast Brass roller bumpers eliminate the possibility of interlocking knobs, or of interfering doors from striking each other. Individually packed with sheet metal screws; 2 per box.

RB470



Solid Brass  
Reach: 2 3/4"

RB471, RB472



Solid Brass  
471 – 4 1/2" Projection  
472 – 6" Projection

Replacement roller package: IV09-137-626

**RB470**

Offset Arm type; used where two left hand or two right hand doors interfere, meeting a odd angles in a corner. Conforms to Federal Spec. No. 1342. Base: 1 5/8" x 2 1/4". Projection: 2 3/4". Reach: 2 3/4".

IVRB470-26D	Satin Chrome	34.50
IVRB470-3	Polished Brass	27.50

**RB471**

Straight Stem type; used where the doors in a corner are of opposite type. Base: 2" diameter. Projection: 4 1/2". Conforms to Federal Spec. No. 1341.

IVRB471-26D	Satin Chrome	31.20
IVRB471-3	Polished Brass	26.00

**RB472**

Straight stem type; used where the doors in a corner are of opposite type. Base: 2" diameter. Projection: 6". Conforms to Federal Spec. No. 1341A.

IVRB472-26D	Satin Chrome	32.90
IVRB472-3	Polished Brass	27.60

**DOOR SILENCERS**

Gray Rubber. For use on **metal frames**. Packed 100 per polybag with 1 inserter.

**IVSR64 29.30/bag**

Gray Rubber. For use on **wood frames**. Packed 100 per polybag with 1 inserter.

**IVSR65 29.30/bag**

Gray Rubber. Self adhesive, requires no drilling of frame. Packed in sheets of 100.

**IVSR66 29.30/sheet Specify Brown, Grey or White**



SR64



SR65



SR66



411R

**WALL DOOR STOP**

Self-adhesive bumper for use on clean, smooth flat surfaces only - glass, tile, metal, plaster or wood.

Material: Molded elastomeric Polymer. Overall Diameter: 1 7/8". Projection: 5/8". Packed 20 per box.

**IV411R-G** Gray Rubber  
**IV411R-W** White Rubber

**260** ea.



**•HEAVY DUTY DOOR STOPS**  
•Wall •Floor

**•HEAVY DUTY DOOR STOPS AND HOLDERS**

**HEAVY DUTY DOOR STOPS**

Finest quality, heavy duty door stops designed specially for commercial and public buildings. Features non-marring rubber tip. Hand Polished Cast Brass

**No. 443**



Solid Brass or Aluminum  
Projection: 3 3/4"

**No. 444**



Solid Brass or Aluminum  
Height: 3"

**No. 447**

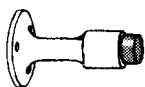

Solid Brass or Aluminum  
Projection: 3 5/8"

Replacement tip for WS443, WS445, WS446, WS447, WS448, WS449, FS450 -

**IV09-316 1.90**

**No. 448**



Solid Brass or Aluminum  
Height: 3"

**WS443 WALL STOP**

Conforms to Federal Spec. No. 1320E. Projection: 3 5/8". Base Diameter: 2 1/4". Packed individually with expansion shields; 2 per box.

<b>IVWS443-3</b>	Polished Brass	<b>32.00</b>
<b>IVWS443-10</b>	Satin Bronze	<b>38.50</b>
<b>IVWS443-26D</b>	Satin Chrome	<b>38.50</b>
<b>IVWS443-4</b>	Satin Brass	<b>39.90</b>

**FS444 FLOOR STOP**

Conforms to Federal Spec. No. 1328E. Designed for doors with undercut up to 2 1/2". Height: 3". Base Diameter: 2 1/2". Packed individually with expansion shields; 2 per box.

<b>IVFS444-3</b>	Polished Brass	<b>24.40</b>
<b>IVFS444-10</b>	Satin Bronze	<b>24.40</b>
<b>IVFS444-26D</b>	Satin Chrome	<b>23.50</b>

**WS447 WALL STOP**

Conforms to Federal Spec. No. 1320. Designed for doors with undercut up to 2 81/2". Height: 3 5/8". Base Diameter: 2 1/4". Packed with screws; 2 per box.

<b>IVWS447-3</b>	Polished Brass	<b>29.10</b>
<b>IVWS447-10</b>	Satin Bronze	<b>34.90</b>
<b>IVWS447-26D</b>	Satin Chrome	<b>34.90</b>
<b>IVWS447-26</b>	Polished Chrome	<b>34.90</b>

**FS448 FLOOR STOP**

Conforms to Federal Spec. No. 1328. Designed for doors with undercut up to 2 1/2". Height: 3". Base Diameter: 2 1/2". Packed with screws; 2 per box.

<b>IVFS448-3</b>	Polished Brass	<b>27.40</b>
<b>IVFS448-10</b>	Satin Bronze	<b>27.40</b>
<b>IVFS448-26D</b>	Satin Chrome	<b>27.40</b>
<b>IVFS448-28</b>	Polished Aluminum	<b>20.10</b>

**HEAVY DUTY DOOR STOPS AND HOLDERS**

Finest quality, heavy duty door stops designed specially for commercial applications, public buildings and high traffic areas. Hand Polished Cast Brass.

**No. 445**

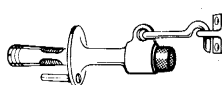

Solid Brass or Aluminum  
Projection: 3 5/8"

**No. 446**

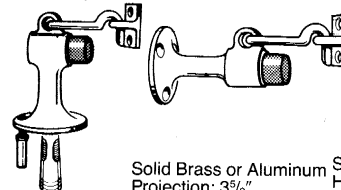

Solid Brass or Aluminum  
Height: 3 5/8"

**No. 450**

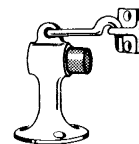

Solid Brass or Aluminum  
Projection: 3 5/8"

Solid Brass or Aluminum  
Height: 3 5/8"

**No. 451**

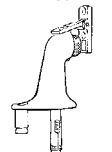

Solid Brass or Aluminum  
Height: 3 5/8"

**WS445 WALL STOP**

Conforms to Federal Spec. No. 1321E. Projection: 3 5/8". Base Diameter: 2 1/4". Packed with screws and expansion shields; 2 per box.

<b>IVWS445-3</b>	Polished Brass	<b>50.80</b>
<b>IVWS445-10</b>	Satin Bronze	<b>60.90</b>
<b>IVWS445-26D</b>	Satin Chrome	<b>60.90</b>
<b>IVWS445-15</b>	Satin Nickel	<b>63.30</b>

**FS446 FLOOR STOP**

Conforms to Federal Spec. No. 1329E. Designed for doors with undercut up to 2 1/2". Projection: 3 5/8". Base Diameter: 2 1/2". Packed with screws and expansion shields; 2 per box.

<b>IVFS446-3</b>	Polished Brass	<b>48.40</b>
<b>IVFS446-10</b>	Satin Bronze	<b>48.40</b>
<b>IVFS446-26D</b>	Satin Chrome	<b>34.40</b>
<b>IVFS446-28</b>	Polished Aluminum	<b>24.70</b>

**WS449 WALL STOP**

Conforms to Federal Spec. No. 1321. Projection: 3 5/8". Base Diameter 2 1/4". Packed with screws; 2 per box.

<b>IVWS449-3</b>	Polished Brass	<b>48.50</b>
<b>IVWS449-10</b>	Satin Bronze	<b>58.10</b>
<b>IVWS449-26D</b>	Satin Chrome	<b>58.10</b>

**FS450 FLOOR STOP**

Conforms to Federal Spec. No. 1329. Designed for doors with undercut up to 2 1/2". Projection: 3 5/8". Base Diameter: 2 1/2". Packed with screws; 2 per box.

<b>IVFS450-3</b>	Polished Brass	<b>51.40</b>
<b>IVFS450-10</b>	Satin Bronze	<b>51.40</b>
<b>IVFS450-26D</b>	Satin Chrome	<b>37.40</b>
<b>IVFS450-28</b>	Polished Aluminum	<b>27.80</b>

**FS451 FLOOR STOP**

Conforms to Federal Spec. No. 1329E. Designed for doors with undercut up to 2 1/2". Projection: 3 1/8". Base: 2 11/16"(L), 1 5/8"(W). Individually polybagged; 2 per box. Plate and holder furnished with sheet metal screws.

<b>IVFS451-10</b>	Satin Bronze	<b>51.00</b>
<b>IVFS451-3</b>	Polished Brass	<b>51.00</b>

# IVES®

B

**Accredited Lock Supply**

www.acclock.com

**• FLOOR DOOR STOPS  
• BASE DOOR STOPS**

**FLOOR DOOR STOPS**

No. 430



Solid Brass or Aluminum  
Height: 1 5/16"

No. 434

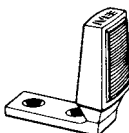

Steel  
Height: 2 5/8"

No. 441



Solid Brass or Aluminum  
Height: 2 1/8"

No. 442



Solid Brass or Aluminum  
Height: 2 7/8"

**430 FLOOR STOP**

Base Diameter: 1 1/4". Height: 1 5/16". With replaceable rubber tip. Machine Polished Cast Brass. Individually polybagged.

IV430MB5	Antique Brass	16.40
IV430MB26	Bright Chrome	16.40

**FS434 FLOOR STOP**

For undercut doors. Wrought steel with soft, resilient rubber. Overall Length: 2 3/4". Width: 1 5/8". Height: 2 1/8". Individually polybagged; with sheet metal screws and plastic anchor.

IVFS434-2C	Zinc	8.00
------------	------	------

**FS441 FLOOR STOP**

For doors, undercut to 1 1/2". Width non-marring rubber tip. Overall Length: 2 11/16". Width: 1 5/8". Height: 2 1/8". Supplied with metal screws. Hand Polished Cast Brass. Individually polybagged.

IVFS441-3	Polished Brass	20.70
IVFS441-26D	Satin Chrome	20.00

**FS442 FLOOR STOP**

For doors, undercut to 2". With non-marring rubber tip. Overall Length: 2 11/16". Width 1 5/8". Height: 2 7/8". Meets Federal Specs. - Type 1328. Hand Polished Cast Brass. Individually polybagged.

IVFS442-4	Satin Brass	24.30
IVFS442-10	Satin Bronze	24.30

**BASE DOOR STOPS**

Individually polybagged; 10 per box.

Nos. 60, 61

No. 062

No. 62

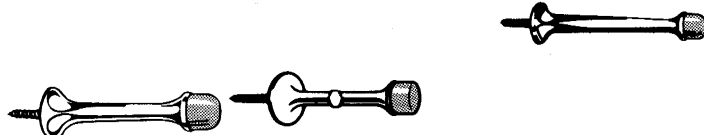

No. 64 Solid Brass or Aluminum  
Projection: 4 1/2" No. 65

Solid Brass or Aluminum  
No. 60 Projection: 3 3/4"  
No. 61 Projection: 3"

Solid Brass or Aluminum  
Projection: 2 1/2"

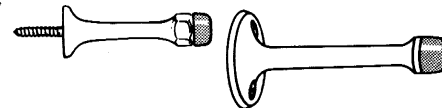

Solid Brass or Aluminum  
Projection: 3 1/4"

**60 DOOR STOP**

Machine Polished Cast Brass. Projection: 3 3/4"

Aluminum  
Projection: 3 3/4"

IV60MB3	Polished Brass	11.20
IV60MB5	Antique Brass	11.20
IV60MB26	Bright Chrome	14.70
IV60MB26D	Satin Chrome	14.70

**61 DOOR STOP**

Machine Polished Cast Brass. Projection: 3". Conforms to Federal Spec. 1322

IV61MB3	Polished Brass	11.20
IV61MB26	Bright Chrome	14.70
IV61MB26D	Satin Chrome	11.20

**062 DOOR STOP**

Machine Polished Cast Brass. Projection: 2 1/2". Conforms to Federal Spec. 1323.

IV062MB3	Polished Brass	9.10
IV062MB5	Antique Brass	7.40
IV062MB26	Bright Chrome	9.10
IV062MB15A	Satin Nickel, Blackened	9.10

**62 DOOR STOP**

Machine Polished Cast Brass. Projection: 4 1/2"

IV62A3	Aluminum, Bright Brass	4.50
IV62MB3	Polished Brass	13.70

**64 DOOR STOP**

Machine Polished Cast Brass. Projection: 3 1/4"

IV64MB3	Polished Brass	10.00
IV64MB26D	Satin Chrome	12.90

**WS65 DOOR STOP**

Brushed Cast Aluminum. Projection: 3 3/4". Individually polybagged, 20 per box; with sheet metal screws.

IVWS65A3	Polished Brass	4.20
IVWS65US27	Aluminum	4.20

- DOORS STOPS AND HOLDERS
- DOME DOOR STOPS
- LOCKGUARDS

## LOCK GUARDS

**LG10, LG12**



**LG14**



P/N	Material	Size	Price
IVLG10-USP	Steel, Prime Painted	2 1/2" x 9 1/2"	<b>23.60</b>
IVLG10-32D	Stainless Steel	2 1/2" x 9 1/2"	<b>34.70</b>
IVLG12-USP	Steel, Prime Painted	1 1/2" x 9 1/2"	<b>23.60</b>
IVLG12-32D	Stainless Steel	1 1/2" x 9 1/2"	<b>32.30</b>
IVLG14-32D	Stainless Steel	2 9/16" x 9 1/2"	<b>50.90</b>

## DOME DOOR STOPS

Hand Polished Cast Brass. With gray, non-marring rubber bumper. Individually polybagged with wood screws and plastic anchors; 10 per box.

**No. 436**



**No. 438**



### FS436

For doors without threshold. Conforms to Fed Spec. No. 1330. Height: 1" Base: 2" x 1 5/8". Stud Projection: 3/4".

Code	Material	Price
IVFS436-3	Polished Brass	<b>5.90</b>
IVFS436-10	Satin Bronze	<b>6.90</b>
IVFS436-26	Bright Chrome	<b>6.20</b>
IVFS436-26D	Satin Chrome	<b>5.00</b>

### FS438

For doors with threshold or undercut doors. Conforms to Fed Spec. No. 1330A. Height: 1 5/8". Base: 2" x 1 5/8". Stud Projection: 3/4".

Code	Material	Price
IVFS438-3	Polished Brass	<b>7.00</b>
IVFS438-10	Satin Bronze	<b>8.00</b>
IVFS438-26	Bright Chrome	<b>7.50</b>
IVFS438-26D	Satin Chrome	<b>5.60</b>

## DOOR HOLDERS

Replacement tip:

IVFSPART.1075



### FS452 DOOR HOLDER

Features rugged construction, stainless steel spring and foot-operated replaceable rubber tip. Commercial use; allows door to stay open in desired position. Conforms to Federal Spec. No. 1149A-4" and Federal Spec. No. 1149B-5" - brass only.

Hand Polished Cast Brass. Individually polybagged with sheet metal screws; 10 per box.

Code	Arm Length	Finish	Price
IVFS452-3-4	4"	Polished Brass	<b>26.50</b>
IVFS452-26D-4	4"	Satin Chrome	<b>25.50</b>
IVFS452-26D-5	5"	Satin Chrome	<b>31.60</b>
IVFS452-3-5	5"	Polished Brass	<b>36.70</b>

### FS455 DOOR HOLDER

Provides quality and sturdy construction with economy. Features stainless steel spring and foot-operated replaceable rubber tip. Allows door to stay open in desired position.

Arm Length: 4". Conforms to Federal Spec. No. 1149A - brass only. Available in Machine Polished Cast Brass or Burnished Cast Aluminum. Individually polybagged with sheet metal screws; 10 per box.

Code	Material	Finish	Price
IVFS455A3	Aluminum	Polished Brass	<b>7.10</b>
IVFS455A27	Aluminum	Satin Aluminum	<b>7.10</b>
IVFS455MB3	Brass	Polished Brass	<b>28.80</b>
IVFS455MB26D	Brass	Satin Chrome	<b>34.50</b>



**Accredited Lock Supply**

www.acclock.com

**•RUBBER WALL BUMPERS**

**•Concave •Convex •Cast •Wrought**

**401 SERIES WALL BUMPERS**

Positive attachment to the wall by tamper proof, concealed set screw. Soft, high grade light gray rubber cushion. The special retainer cup makes the rubber almost impossible to remove from the bumper.

Hand Polished Cast Brass. Individually polybagged, 10 per box; with socket head set screws

**406 SERIES WALL BUMPERS**

Lower cost alternative to the 401 Series; identical in size and similar in function, with high quality Ives finish. Hand Polished Wrought Brass. Individually polybagged, 10 per box; with socket head set screws

P/N	3	5	10	10B	26	26D	28	32D
WS401CCV	14.90		17.20	17.20	17.20	17.20		
WS401CVX	14.90		17.20	17.20	17.20	17.20		
WS402CCV	14.90	17.20	17.20	17.20	17.20	17.20		
WS402CVX	14.90		17.20	17.20	17.20	17.20	11.00	
WS404CVX	5.20	6.20	6.20	6.20	6.20	6.20		
WS406CCV	3.60		3.90	3.90	3.90	3.50		2.90
WS406CVX	3.60		3.90	3.90	3.50	3.90		2.90
WS407CCV	3.60	4.10	4.10	4.10	4.10	3.60		2.90
WS407CVX	3.60	4.10	4.10	4.10	4.10	3.60		2.90

WS401CVX

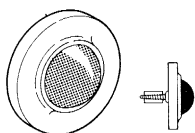

Cast Brass or Aluminum  
Convex Rubber  
Diameter: 2 1/2"

WS401CCV

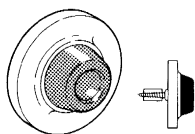

Cast Brass or Aluminum  
Concave Rubber  
Diameter: 2 1/2"

WS402CVX

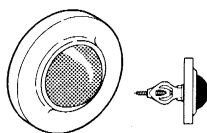

Cast Brass or Aluminum  
Convex Rubber  
Diameter: 2 1/2"

WS402CCV

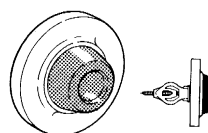

Cast Brass or Aluminum  
Concave Rubber  
Diameter: 2 1/2"

WS404CVX



Solid Brass  
Convex Rubber  
Rawl Plug  
Diameter: 1"

WS406CVX

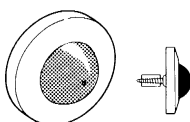

Wrought Brass, Stainless  
Steel or Aluminum  
Convex Rubber  
Diameter: 2 7/16"

WS406CCV

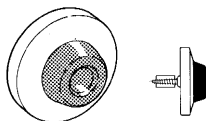

Wrought Brass, Stainless  
Steel or Aluminum  
Concave Rubber  
Diameter: 2 7/16"

WS407CVX

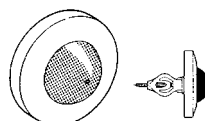

Wrought Brass, Stainless  
Steel or Aluminum  
Convex Rubber  
Diameter: 2 7/16"

WS407CCV

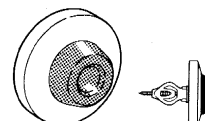

Wrought Brass, Stainless  
Steel or Aluminum  
Concave Rubber  
Diameter: 2 7/16"

**•HEAVY DUTY MAGNETIC CATCHES**  
**•DRAWER PULLS**    **•PUSH LATCHES**

### PUSH LATCH

For use of on cabinet doors; the ideal catch when concealed hardware is desired. Eliminates the need for pulls or knobs while enhancing styling and the clean look of fine furniture and cabinets. Narrow case design for minimum obstruction; facilitates cleaning and painting.

Features heavy gauge parts. Simple installation with metal template; no mortising required. CL11, CL12 and CL14 are designed for larger doors and panels.

Individually polybagged with screws template and instructions for installation.

#### CL14



Dimensions:  
Body: 2-15/16" Long x 1-11/16" Wide x 5/8" High

Code	Finish	Price
IVCL11-US3	Polished Brass	36.40
IVCL11-US4	Satin Brass	28.70
IVCL11-US26D	Satin Chrome	28.70
IVCL12-US4	Brass-Satin Brass	38.60
IVCL12-US10	Satin Bronze	38.60
IVCL12-US26D	Satin Chrome	38.60
IVCL12-US3	Polished Brass	43.60
IVCL14-US3	Polished Brass	38.60
IVCL14-US4	Brass-Satin Brass	32.30
IVCL14-US10	Satin Bronze	32.30
IVCL14-US26D	Satin Chrome	32.30



#### CL11

Dimensions:  
Body: 1-7/8" Tall x 1-1/4" Wide x 7/16" Thick  
Strike: 1-5/16" Tall x 9/16" Wide x 9/16" High



#### CL12

Dimensions:  
Body: 2-1/4" Tall x 1-1/4" Wide x 9/16" Thick  
Strike: 1-13/16" Tall x 5/8" Wide x 9/16" High

### DRAWER PULLS

**Nos. 32, 33, 34**  
**36, 37, 38**

**No. 133**

**No. 137**

Cast Brass or Aluminum

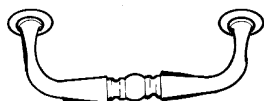

Solid Brass or Aluminum

- No. 32 – 2 1/2" C to C
- No. 33 – 5" C to C
- No. 34 – 6" C to C
- No. 36 – 3" C to C
- No. 37 – 3 1/2" C to C
- No. 38 – 4" C to C

Solid Brass  
C to C: 3", 3 1/2", 4"

C to C: 3"  
Overall: 3 1/2"  
Projection: 7/8"

For use on doors, drawers and cabinets. Size: C-C Projection: 1 5/16". Diameter: 5/16".

Hand Polished Solid Brass; polished brass finish. Individually polybagged, 10 per box; with 1" x 8-32 Truss Head machine screws.

P/N	C-C"	3	5	26	26D
IV33	5		7.60	7.90	
IV34	6	8.50	8.11	9.80	
IV36	3	5.30	5.80		6.10
IV37	3 1/2	5.80	6.40	6.70	6.70
IV38	4		7.00		
IV133-3"	3	16.20		13.52	
IV133-3 1/2"	3 1/2	19.40			
IV133-4"	4	20.20			
IV137		8.30			9.50

### HEAVY DUTY MAGNETIC CATCHES

**No. 326**

**No. 327**

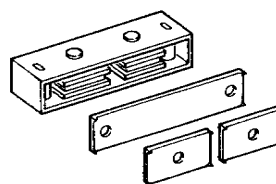

Aluminum Case  
Dual Double Pole  
Size: 3 1/8" x 1" x 9/16"

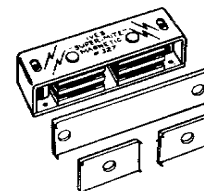

Aluminum Case  
Dual Triple Pole  
Size: 3 1/8" x 1" x 3/4"

### MIGHTY-MITE® HEAVY DUTY MAGNETIC CATCHES

Designed for full length doors. Features self-aligning pole piece and magnet. Unique aluminum case design permits surface mounting or mortising into stop. Individually polybagged with instructions, sheet metal screws, 1 long and 2 short strikes; 10 per box.

#### DUAL TRIPLE POLE

IV327A3	3 1/8" x 3/4"	Steel-Brass	13.00
IV327A92	3 1/8" x 3/4"	Steel-Aluminum	13.00

#### DUAL DOUBLE POLE

IV326A3	3 1/8" x 9/16"	Steel-Brass	7.60
IV326A92	3 1/8" x 9/16"	Steel-Aluminum	7.60



www.acclock.com

### •ROLLER CATCHES

- Standard
- Adjustable
- Adjustable Tension

### •CABINET CATCHES

- Roller
- Elbow

### •CUPBOARD LATCH

- BALL CATCHES

#### ELBOW CABINET CATCH

Used on the inactive side of a pair of cabinet doors. Plated dimensions: 1 3/8" x 5/8". Conforms to Federal Spec. No. 1075. Packed with screws.

Code	Material	Finish	Price
IV2A3	Aluminum	Bright Brass	3.80
IV2A92	Aluminum	Aluminum	3.80
IV2A15	Aluminum	Satin Nickel	4.20



Solid Brass or Aluminum  
Plate: 1 3/8" x 5/8"  
Strike: 13/16" x 5/8"

#### CUPBOARD TURN

A latch for cabinets and small doors. Case: 1 3/4" x 1 1/8". Strike: 1 3/4" x 3/8". Conforms to Federal Spec. No. 1082. Hand Polished Cast Brass. Packed with screws.

Code	Material	Price
IV540B26D	Satin Chrome	39.20

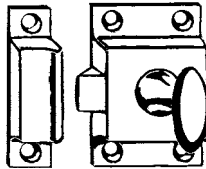

#### DUAL ADJUSTMENT BALL CATCHES

Ideal for louvered, bi-folding, accordion, wardrobe and service doors. The perfect catch to use with dummy trim. Dual adjustment provides door holding and clearance strength.

Faceplate: 2 1/8" x 1". Bore: 7/8" x 1 1/4".

Hand Polished Wrought Brass. Individually polybagged with screws.

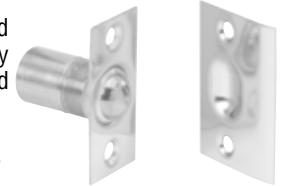

Solid Brass

Face Plate:

No. 345 - 1 1/2" x 3/4"

No. 346 - 2 1/8" x 1"

No. 347 - 2 1/8" x 1"

No. 346--narrow strike--designed for use when action catch is mounted in the jamb.

#### DUAL ADJUSTMENTS

##### FEATURE

For clearance and tension. Makes it easy to compensate for swelling, shrinking, drafts and weight of doors.

- A. Free rolling ball insures smooth, positive and trouble-free action.
- B. Adjustable threaded barrel to compensate for various clearances of doors.
- C. Adjustable spring tension for any desired action.

#### FOR CATCH IN DOOR INSTALLATIONS

Code	Strike	Strike Lip	Finish	Price
IV347B3	2 1/8" x 1 3/8"	7/8" to center	Polished Brass	11.30
IV347B26D	2 1/8" x 1 3/8"	7/8" to center	Satin Chrome	12.80

#### ADJUSTABLE TO CLEARANCE ONLY

For use on cabinets and small interior doors.

Faceplate: 1 1/2" x 3/4". Bore: 9/16" x 7/8".

Code	Strike	Strike Lip	Finish	Price
IV345B3	1 1/2" x 25/32"	13/32" to center	Polished Brass	7.60
IV345B26D	1 1/2" x 25/32"	13/32" to center	Satin Chrome	8.70
IV345B5	1 1/2" x 25/32"	13/32" to center	Antique Brass	8.30



Solid Brass Brackets w/Steel Chain  
Lengths: 20 1/2", 25 1/2", 30 1/2"

#### 115 CRASH STOPS

Plate Size: 1 1/2" x 1 1/2". Packed with sheet metal screws; 5 per box.

Code	Overall Length	Recommended Door Width	Chain Finish	Price
IVCS115-25-26D	25 1/2"	36"	Satin Chrome	46.30
IVCS115-30-26D	30 1/2"	42"	Satin Chrome	51.40
IVCS115-30-3	30 1/2"	42"	Polished Brass	37.90

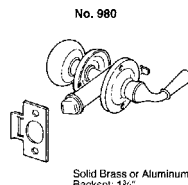

No. 980

Solid Brass or Aluminum Backset: 1 1/4"

#### STORM DOOR LATCH

Polished Wrought Brass for wood storm doors, 7/8" to 1 1/8" thick. Reversible; for right or left hand inswinging or outswinging doors. Backset: 1 3/4". Knob Diameter: 1 3/4". Rose Diameter: 1 7/8". Lever Length: 1 3/4". Lever Projection: 1 7/8". Case Diameter: 5/8". Case Length: 2 21/32". **IV980B5, 19, 26 30.20**

#### HEAVY DUTY ROLLER CATCHES FOR CABINET, WARDROBE AND INTERIOR DOORS

Narrow, 2 1/4" x 7/8" faceplate and 3/4" x 1 3/4" bore enable easy installation on thin doors. Smooth, positive latching action provided by powerful conical spring. Durable, uniform-action nylon roller. Quiet operation ensured by special rubber washer which cushions roller return.

Hand Polished Wrought Brass. Individually polybagged with sheet metal screws.

No. 335

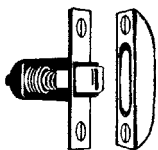

Solid Brass or Steel  
Face Plate: 2 1/4" x 7/8"

No. 333

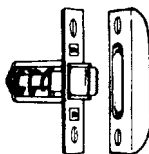

Solid Brass or Steel  
Face Plate: 2 1/4" x 1 1/4"

No. 336

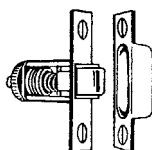

Solid Brass or Steel  
Face Plate: 2 1/4" x 7/8"

#### ROLLER CATCH

Full lip style strike simplified mortising.

Code	Strike	Strike Lip	Finish	Price
IV333B26	2 1/4" x 1 5/8"	1 3/16" to center	Polished Chrome	8.80
IV333B5	2 1/4" x 1 5/8"	1 3/16" to center	Antique Brass	8.80

#### ADJUSTABLE-TENSION ADJUSTABLE ROLLER CATCH

Full lip strike for simplified mortising.

Code	Strike	Strike Lip	Finish	Price
IV335B3	2 1/4" x 1 5/8"	1 3/16" to center	Polished Brass	13.00
IV335B26D	2 1/4" x 1 5/8"	1 3/16" to center	Satin Chrome	15.50
IV335B5	2 1/4" x 1 5/8"	1 3/16" to center	Antique Brass	15.50

#### ADJUSTABLE TENSION ADJUSTABLE ROLLER CATCH

Standard box type strike provides neat appearance.

Code	Strike	Strike Lip	Finish	Price
IV336B3	2 1/4" x 7/8"	1 1/8" to center	Polished Brass	11.90
IV336B26D	2 1/4" x 7/8"	1 1/8" to center	Satin Chrome	14.40
IV336B5	2 1/4" x 7/8"	1 1/8" to center	Antique Brass	15.50

- SASH LOCK**
- WINDOW LOCKS**
- CASEMENT ADJUSTER**
- SASH FASTENER**
- HOOKS**

**No. 4**

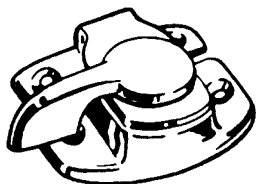

Solid Brass or Steel  
"Jimmy Proof"  
Base: 1<sup>3</sup>/<sub>8</sub>" × 2<sup>5</sup>/<sub>16</sub>"  
Strike: 9/16" × 2<sup>3</sup>/<sub>16</sub>"



No. 07-Solid Brass or Alum.  
Base: 1<sup>5</sup>/<sub>16</sub>" × 2<sup>5</sup>/<sub>8</sub>"  
Strike: 5/8" × 2<sup>5</sup>/<sub>8</sub>"

No. 9- Solid Brass or Cast Iron  
Base: 1<sup>1</sup>/<sub>16</sub>" × 3"  
Strike: 5/8" × 3"

**SECURITY SASH LOCK**

Spring lever pulls rails together to provide jimmy resistance and rattle-free fit. Hand Polished Wrought Brass. Individually polybagged with screws.

**IV4B26** Polished Chrome **15.70**

**SASH FASTENERS**

World-renowned Crescent sash fastener pioneered by Ives. Designed low to the sash for superior strength and greater resistance to breakage. Vertical-horizontal camming action lifts sash up and pulls them together for a snug, non-rattling fit. The heavy gauge, top quality springs provide snappy wearing action.

Code	Material	Finish	Price
<b>IV07A3</b>	Aluminum	Bright Brass	<b>2.50</b>
<b>IV07A92</b>	Aluminum	Aluminum	<b>2.50</b>
<b>IV07MB26</b>	Brass	BrightChrome	<b>18.90</b>
<b>IV07MB26D</b>	Brass	Satin Chrome	<b>18.90</b>
<b>IV07MB3</b>	Brass	Polished Brass	<b>15.50</b>
<b>IV07MB5</b>	Brass	Antique Brass	<b>18.70</b>



Solid Brass  
Positive Locking  
Length: 10", 12"

**FRICTION CASEMENT ADJUSTER**

With Positive Locking Device. 1" projection, 3/8" x 5/8" tube. Constant friction and the wing nut locking feature secures casement windows in any position.

Hand Polished Extruded Brass. Packed with screw.

Code	Length	Lbs. of Friction	Finish	Price
<b>IV288B3-10</b>	10"	15	Polished Brass	<b>91.60</b>
<b>IV288B26D-10</b>	10"	15	Satin Chrome	<b>109.60</b>
<b>IV288B3-12</b>	12"	15	Polished Brass	<b>103.40</b>



Aluminum  
Projection: 2<sup>1</sup>/<sub>2</sub>"

**405 COAT AND HAT HOOK**

Ideal for schools, dormitories and public areas. Engineered for extra strength and designed to withstand unusual strain.

Burnished Cast Aluminum. Individually poly-bagged with screw.

<b>IV405A3</b>	Bright Brass	<b>2.40</b>
<b>IV405A5</b>	Antique Brass	<b>2.40</b>
<b>IV405A92</b>	Aluminum	<b>2.40</b>



Solid Brass or Aluminum  
Projection: 3"

**571 ALL-PURPOSE HOOK**

3" projection. Conforms to Federal Spec. No. 1172 (brass), No. 1172AL (aluminum). Individually polybagged with screws. Brass (10 per box); Aluminum (20 per box).

Code	Material	Finish	Price
<b>IV571A3</b>	Aluminum	Polished Brass	<b>1.10</b>
<b>IV571A92</b>	Aluminum	Aluminum	<b>1.10</b>
<b>IV571A5</b>	Aluminum	Antique Brass	<b>1.70</b>
<b>IV571MB3</b>	Brass	Polished Brass	<b>7.60</b>
<b>IV571MB4</b>	Brass	Satin Brass	<b>9.10</b>
<b>IV571MB26D</b>	Brass	Satin Chrome	<b>9.10</b>
<b>IV571MB5</b>	Brass	Antique Brass	<b>9.10</b>
<b>IV571MB10</b>	Brass	Satin Bronze	<b>8.40</b>
<b>IV571MB15</b>	Brass	Satin Nickel	<b>9.60</b>



Solid Brass or Aluminum  
Projection: 3<sup>3</sup>/<sub>4</sub>"

**COAT AND HAT HOOK**

Decorative design for commercial and residential application. Height: 5". Projection: 3 3/4". Base: 1 5/8"(H), 1 1/4"(W). Solid Brass. Individually polybagged with screws;

<b>IV574B3</b>	Polished Brass	<b>26.10</b>
<b>IV574B26</b>	Bright Chrome	<b>31.10</b>

- HOOKS
- Wardrobe
- Utility
- Celing
- Garment
- Coat and Hat
- Multi-Purpose

### COAT AND HAT HOOK

All purpose hook for large hats. Size: 7". Projection: 3 3/4". Solid Brass. Individually polybagged with screws.

IV575B3	Polished Brass	22.90
IV575B5	Antique Brass	26.11
IV575B26D	Satin Chrome	28.70
IV575B15A	Satin Nickel Black	26.11
IV575A3	Alum, Brass Plated	4.60
IV575A92	Aluminum	4.60



Aluminum  
Projection: 3 3/4"

### 572 ALL PURPOSE HOOK

Provides extra strength and durability. 3 1/16" projection. Machine Polished Cast Brass. Individually polybagged with screws.

IV572MB3	Polished Brass	10.40
IV572MB5	Antique Brass	13.10
IV572MB26	Bright Chrome	12.60
IV572MB26D	Satin Chrome	12.60
IV572A3	Aluminum, Brass Plated	3.80
IV572A92	Aluminum	3.80



Solid Brass or Aluminum  
Projection: 3 1/16"

### WARDROBE HOOK

All-purpose hook for areas with limited space. Base: 1 1/8" x 1 1/8". Projection: 1 1/8". Machine Polished Cast Brass. Individually polybagged with screws.

IV582MB3	Polished Brass	6.90
IV582MB26	Bright Chrome	8.20
IV582MB5	Antique Brass	7.60
IV582MB26D	Satin Chrome	8.20
IV582A3	Alum, Brass Plate	1.70
IV582A92	Aluminum	1.70



Solid Brass or Aluminum  
Projection: 1 1/8" **No. 576**

### ALL PURPOSE CEILING HOOK

Ideal for use in closets. Projection: 2 1/4".

Individually polybagged with screws.

IV580A92	Aluminum	2.60
----------	----------	------



Solid Brass or Aluminum  
Projection: 2 1/4"

### ALL PURPOSE GARMENT HOOK

Useful where additional storage space is needed. Solid Brass. Individually polybagged with screws

IV576B3	Polished Brass	19.71
IV576A3	Alum, Brass Plate	4.13
IV576B26	Polished Aluminum	20.00

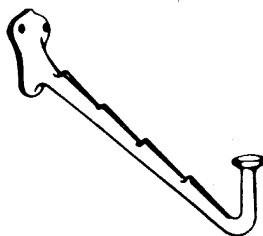

Aluminum  
Projection: 6 3/4"

**No. 577**

### UTILITY HOOK

All-purpose hook for utility areas. Base: 1 3/16" x 15/16". Projection: 1 1/8". Burnished Cast Aluminum. Packaged two per bag.

IV577A3	Alum, Brass Plated	1.91
IV577A14	Alum, Brt. Nickel	2.04
IV577B26	Bright Chrome	4.71
IV577B26D	Satin Chrome	4.71



Aluminum  
Projection: 1 1/8"

### WARDROBE HOOK

All-purpose hook for low-profile situations. Base: 1 1/8" x 1 1/8". Projection: 1 11/16".

Individually polybagged with screws.

IV581MB3	Polished Brass	5.20
IV581MB26	Bright Chrome	6.20
IV581MB26D	Satin Chrome	6.20
IV581MB5	Antique Brass	6.20
IV581A3	Brass Plated Aluminum	1.50
IV581A92	Burnished Aluminum	1.50
IV581A-W	Aluminum - White	2.20
IV581A-BLK	Aluminum - Black	2.20

Solid Brass or Aluminum  
Projection: 1 11/16"



- DOOR PULL
- PUSH PLATE
- PULL PLATES

### DOOR PULLS

Made from the finest architectural materials available. Carefully machined, polished and inspected before individually wrapped and packaged.

Packed with Ives standard type fasteners for 1 3/4" doors.

#### 8102 DOOR PULLS

3/4" Round Bar Stock.

Code	Center to Center	Finish	Price
IV8102-6B3	6"	Polished Brass	44.80
IV8102-6B26D	6"	Satin Chrome	44.80
IV8102-6PA28	6"	Satin Aluminum	17.90
IV8102-8B3	8"	Polished Brass	50.40
IV8102-8B26D	8"	Satin Chrome	50.40

#### 8103 DOOR PULLS

1" Round Bar Stock.

Code	Center to Center	Finish	Price
IV8103-8B3	8"	Polished Brass	89.40
IV8103-8B26D	8"	Satin Chrome	89.80
IV8103-8PA28	8"	Satin Aluminum	25.90

#### 8112 DOOR PULLS

Standard Pull. Exposed Screws.  
Mounting Surface: 1 7/8".

Code	Center to Center	Finish	Price
IV8112-5B26D	5 1/5"	Satin Chrome	36.10

#### 8111 DOOR PULLS

Stand Pull. Concealed Screw.  
Mounting Surface: 1".

Code	Center to Center	Finish	Price
IV8111-5B3	5 1/4"	Polished Brass	46.20
IV8111-5B10	5 1/4"	Satin Bronze	51.60
IV8111-5B26D	5 1/4"	Satin Chrome	49.40
IV8111-PA28	5 1/4"	Aluminum	28.80

### SERIES 8200 PUSH PLATES

Made from the finest architectural materials available. All plates meet ANSI A156.6 requirements for .050" thickness. Each plate is individually wrapped and packed with mounting screws. 10 per pack.

Code	Plate Size	Finish	Price
IV8200B3-3.5	3 1/2" x 15"	Polished Brass	20.30
IV8200B26D-3.5	3 1/2" x 15"	Satin Chrome	23.80
IV8200PA28-3.5	3 1/2" x 15"	Satin Aluminum	9.50
IV8200B3-4	4" x 16"	Polished Brass	23.80
IV8200S32D-4	4" x 16"	Satin Stainless Steel	13.60
IV8200PA28-4	4" x 16"	Satin Aluminum	9.00

### SERIES 8300 PULL PLATES

Made from the finest architectural materials available. Each plate is individually wrapped and boxed with mounting screws.

#### 8302 PULL PLATE

Code	Pull Size (C to C)	Plate Size	Finish	Price
IV8302-6B3	6"	3.5" x 15"	Polished Brass	67.70
IV8302-6B10B	6"	3.5" x 15"	Dark Satin Bronze	80.50
IV8302-6B26D	6"	3.5" x 15"	Satin Chrome	71.20
IV8302-6PA28	6"	3.5" x 15"	Satin Aluminum	29.70
IV8302-6S32D	6"	3.5" x 15"	Satin Stainless Steel	40.50
IV8302-8B3	8"	4" x 16"	Polished Brass	76.70
IV8302-8B26D	8"	4" x 16"	Satin Chrome	80.30
IV8302-8PA28	8"	4" x 16"	Satin Aluminum	29.80

#### 8303 PULL PLATE

Code	Pull Size (C TO C)	Plate Size	Finish	Price
IV8303-8B3	8"	3.5" x 15"	Polished Brass	112.30
IV8303-8B26D	8"	3.5" x 15"	Satin Chrome	116.10
IV8303-8PA28	8"	3.5" x 15"	Satin Aluminum	37.60
IV8303-8B3	8"	4" x 16"	Polished Brass	115.80
IV8303-8B26D	8"	4" x 16"	Satin Chrome	119.70
IV8303-8PA28	8"	4" x 16"	Satin Aluminium	37.10

#### 8305 PULL PLATE

Code	Pull Size (C to C)	Plate Size	Finish	Price
IV8305-6B3	6"	3.5" x 15"	Polished Brass	71.60
IV8305-6B26D	6"	3.5" x 15"	Satin Chrome	71.30
IV8305-6PA28	6"	3.5" x 15"	Satin Aluminum	32.20
IV8305-8B3	8"	4" x 16"	Polished Brass	102.20
IV8305-8B26D	8"	4" x 16"	Satin Chrome	108.90
IV8305-8PA28	8"	4" x 16"	Satin Aluminum	36.70

#### 8311 PULL PLATE

Code	Pull Size (C to C)	Plate Size	Finish	Price
IV8311-5B3	5"	3.5" x 15"	Polished Brass	69.00
IV8311-5B26D	5"	3.5" x 15"	Satin Chrome	75.80
IV8311-5B3	5"	4" x 16"	Polished Brass	72.60
IV8311-5B26D	5"	4" x 16"	Satin Chrome	79.30
IV8311-5PA28	5"	4" x 16"	Satin Aluminum	40.00



## KICK PLATES

All kickplates are .050 thick. They come with #6 x 5/8 Phillips Oval Head undercut stainless steel sheet metal screws, plated to match.

P/N	Size	Material & Finish	Price
IV8400B3-8X30	8 x 30	Brass, Polished Brass	84.72
IV8400PA28-8X30	8 x 30	Satin Aluminum	25.68
IV8400S32D-8X30	8 x 30	Satin Stainless Steel	29.28
IV8400B3-8X32	8 x 32	Brass, Polished Brass	90.37
IV8400PA28-8X32	8 x 32	Satin Aluminum	27.39
IV8400S32D-8X32	8 x 32	Satin Stainless Steel	31.23
IV8400B3-8X34	8 x 34	Brass, Polished Brass	96.02
IV8400PA28-8X34	8 x 34	Satin Aluminum	29.10
IV8400S32D-8X34	8 x 34	Satin Stainless Steel	33.18



### SLIDING DOOR PULL No.990



### SLIDING DOOR LOCK No.991



For doors 1 3/8" to 1 1/2" thick. Field reversible.  
Clear pack, for retail display. 5/box

P/N	Description	Finish	Price
IV990B26	Sliding Door Pull	Polished Chrome	12.10
IV990B3	Sliding Door Pull	Polished Brass	10.50
IV990B5	Sliding Door Pull	Antique Brass	11.44
IV991B26	Sliding Door Privacy	Polished Chrome	16.80
IV991B3	Sliding Door Privacy	Polished Brass	14.70
IV991B5	Sliding Door Privacy	Antique Brass	17.28

## 059 HANDRAIL BRACKET

Base: 2 1/4" x 1 3/8". Base to Center of Rail: 2 7/16". Burnished Cast Aluminum. Individually polybagged with screws; 20 per box.

P/N	Material	Price
IV059A3	Brass Plated	3.20
IV059A92	Aluminum	3.20



## 59 HANDRAIL BRACKET

Base: 2 13/16" x 1 1/2". Base to Center of Rail; 2 3/4". Conforms to Federal Spec. No. 1064B. Machine Polished Cast Brass. Individually polybagged with screws; 10 per box.

P/N	Material	Price
IV59MB3	Polished Brass	19.70
IV59MB26D	Satin Chrome	22.60

No. 059: Solid Brass or Alum  
Base: 2 1/4" x 1 3/8"  
Base to center of rail: 2 7/16"  
No. 59: Solid Brass or Alum.  
Base: 2 13/16" x 1 1/2"  
Base to center of rail: 2 3/4"

## WEATHER-TITE® LETTER BOX PLATES

Used on door exteriors for letter-sized mail. Conforms to U.S. Post Office specifications. Weather-Tite® construction features interlocking flap and frame for added weather protection.

IV624, and IV625 are supplied with a bronze spring which augments gravity to insure a tightly closed plate, and can be installed in vertical position. IV624B meets the code requirements of the city and county of San Francisco, para. 4306 E.I. for use on labeled corridor doors. Overall Size 10" x 3". Opening: 7 1/2" x 2".

Individually polybagged with template and screws.

624



## COVERED BACK PLATE

Set consists of front plate and gravity type covered back plate.

Code	Material	Finish	Price
IV624B26	Brass	Polished Chrome	56.07

625



Hooded Back Plate

## HOOD

Set Consists of front plate and hooded back plate.

Code	Material	Finish	Price
IV625B10B	Brass	Oxidized Satin Bronze	66.50



- MAGAZINE-SIZE MAIL SLOT
- MAGNETIC MAGAZINE MAIL SLOT

- PUSH THROUGH MAIL SLOTS

### WEATHER-TITE® MAGAZINE-SIZE LETTER BOX PLATES

Used on door exteriors for magazine-size mail. Conforms to U.S. Post Office specifications. Weather-Tite® construction features interlocking flap and frame for added weather protection.

Rugged construction; bronze spring augments gravity to insure a tightly closed plate. IV621B meets the code requirements of the city and county of San Francisco, para. 4306 E.I. for use on labeled corridor doors. Large Opening: 2".

Heavy-gauge Wrought Brass. Individually polybagged with screws and template.



### STANDARD BACK PLATE

Set consists of spring front plate and standard back plate.

IV620B3	Polished Brass	72.10
IV620B5	Antique Brass	88.90
IV620B26D	Satin Chrome	86.40
IV620PA28	Polished Aluminum	45.00

### COVERED BACK PLATE

Set consists of spring loaded front plate and gravity type covered back plate.

IV621B10	Satin Bronze	86.69
IV621B15A	Satin Nickel	108.20

### HOOD

Set consists of spring loaded front plate and hooded back plate.

IV622B10B	Oxidized Satin Bronze	116.90
-----------	-----------------------	--------



### SLEEVE FOR 620/621/622

Made of stainless steel for 1 3/4" hollow core doors. One per box.

IV601  
**1750**

### WEATHER-TITE® PUSH-THROUGH LETTER BOX PLATES

Used on door exteriors for letter-size mail. Conforms to U.S. Post Office specifications. Weather-Tite® construction features interlocking flap and frame for added weather protection. Bronze spring augments gravity to insure a tightly closed plate.

IV627B meets the code requirements of the city and county of San Francisco, para. 4306 E.I. for use on labeled corridor doors. IV626, IV627 and IV628 meet the code requirements of the City of New York, paragraph C-26-604.4(b).

Overall Size: 8 3/4" x 2 7/8".

Heavy-gauge Wrought Brass. Individually polybagged with screws and template.

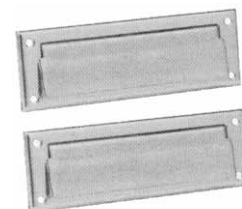

### STANDARD BACK PLATE

Set Consists of spring loaded front plate and standard back plate.

IV626B5	Antique Brass	40.20
IV626B10	Satin Bronze	64.72
IV626B15A	Satin Nickel	77.70
IV626B26	Polished Chrome	77.70

### COVERED BACK PLATE

Set consists of spring loaded front plate and gravity type covered back plate.

IV627B5	Antique Brass	65.50
IV627B15A	Satin Nickel	65.50
IV627B26	Polished Chrome	65.50

### HOOD

Set consists of spring loaded front plate and hooded back plate.

IV628B5	Antique Brass	41.44
---------	---------------	-------

### MAGNETRACT™ MAGAZINE SIZE LETTER BOX PLATES

Ideal for exterior doors; the projection lip assures easy grasp even when wearing gloves. Magnetic inlays on the plate and flap augment gravity for a weather-tite fit and rattle-free installation.

Rugged construction; with massive extrusions for strength and weather resistance, coupled with an exclusive interlocked hinge design that holds the flap securely in place. Concealed pin permanently locks flap in plate; tamper proof when used with sex bolts.

Heavy-gauge Wrought Brass. Individually polybagged with screws and template



### STANDARD BACK PLATE

Set consists of magnetic front plate assembly and standard back plate.

Overall Size: 12 1/2" x 3 1/4". Plate Opening: 11" x 1 7/8".

IV650B15A	Satin Nickel	134.10
IV650B26	Polished Chrome	128.90

### COVERED BACK PLATE

Set consists of magnetic front plate assembly and gravity type covered back plate. Overall Size: 12 1/2" x 3 1/4". Plate Opening: 11" x 1 7/8".

IV651B26	Polished Chrome	204.90
IV651B10B	Oxidized Satin Bronze	170.72
IV651B15A	Satin Nickel	213.10

### HOOD

Set consists of magnetic front plate assembly and hooded back plate.

Overall Size: 12 5/8" x 3 1/16". Plate Opening: 11" x 1 7/8".

IV652B10	Satin Bronze	132.49
IV652B26	Polished Chrome	170.00



**Accredited Lock Supply**

www.acclock.com

- FINGER PULLS
- SLIDING DOOR PULL
- DOOR PULL

**SCREEN DOOR PULL**

For use on screen doors, as window lift or drawer pull.  
Burnished Cast Aluminum. Overall Length: 4 7/8". Projection: 1 5/32".  
Packaged 25 per pack

IV25A3	Bright Brass	1.70
IV25A92	Aluminum	1.70



Aluminum  
Size: 4 7/8" C to C

**BUILT-IN PRONGS**  
**EXCLUSIVE IVES DESIGN**—No Screws or Brads Needed  
**QUICK AND EASY TO INSTALL**—Bore hole, insert pull, punch out prongs—that's all.  
**LOW IN COST**—Yet IVES highest quality finish.  
**ATTRACTIVE**—Neat convex style, good finger grip.

Showing Prongs Imbedded in Wood

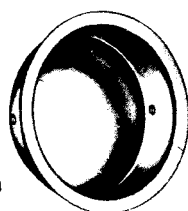

225

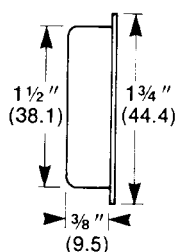

**FLUSH SLIDING DOOR PULL**

Ideal for louvered, bi-folding or sliding wardrobe doors. Deluxe quality heavy gauge wide flange - 2 1/8" bore. Hand Polished Wrought Brass. Individually polybagged with screws; 20 per box.

IV226B5	Antique Brass	5.80
IV226B26	Bright Chrome	6.10

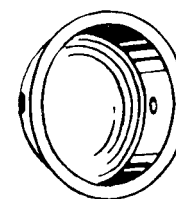

**FINGER PULL**

Used on sliding doors and doors requiring a flush mounted pull. 3/4" bore.  
Burnished Wrought Brass.  
Packed 4 per polybag; 25 bags per box.

IV218B3	Polished Brass	9.20/BAG
IV218B10	Satin Bronze	17.50/BAG
IV218B15	Satin Nickel	9.20/BAG
IV218B26	Polished Chrome	12.40/BAG
IV218B26D	Satin Chrome	12.40/BAG
IV218B10B	Dark Bronze	17.50/BAG



**FLUSH SLIDING DOOR PULL**

Ideal for louvered, bi-folding or wardrobe doors. Deluxe quality heavy gauge wide flange - 1 1/2" bore. Hand Polished Wrought Brass. Individually polybagged with brads; 20 per box.

IV225B3	Polished Brass	3.30
IV225B5	Antique Brass	3.60

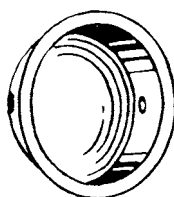

**FLUSH SLIDING DOOR PULLS**

Used on sliding doors and doors which require a flush mounted pull. Hand Polished Wrought Brass. Individually polybagged with two es-cutcheon pins. 20 per box.

Code	Bore	Finish	Price
IV220B5	2"	Antique Brass	3.01
IV220B26D	2"	Satin Chrome	3.50
IV220B26	2"	Bright Chrome	3.50
IV221B3	2 1/8"	Polished Brass	3.20
IV221B5	2 1/8"	Antique Brass	3.20
IV221B26	2 1/8"	Bright Chrome	3.80
IV221B26D	2 1/8"	Satin Chrome	3.80

**SLIDING DOOR PULLS**

For use on louvered, bi-fold or sliding wardrobe doors. With extra deep recess & reverse tapered grip. Size; 1 5/16" x 3 1/8".

Hand Polished Wrought Brass. Individually polybagged with screws; 20 per box.

IV22B3	Polished Brass	2.90
IV22B5	Antique Brass	3.30
IV22B26	Bright Chrome	3.30
IV22B26D	Satin Chrome	3.30



**SLIDING DOOR PULLS**

For use on louvered, bi-folding or sliding wardrobe doors. With reverse tapered grip. Size: 1 5/16" x 3 1/8".

Hand Polished Wrought Brass. Individually polybagged with screws; 10 per box.

IV222B3	Polished Brass	19.40
IV222B5	Antique Brass	22.20
IV222B26	Bright Chrome	22.20
IV222B26D	Satin Chrome	22.20

