

Architectural Door Accessories

ASSA ABLOY

The global leader in
door opening solutions

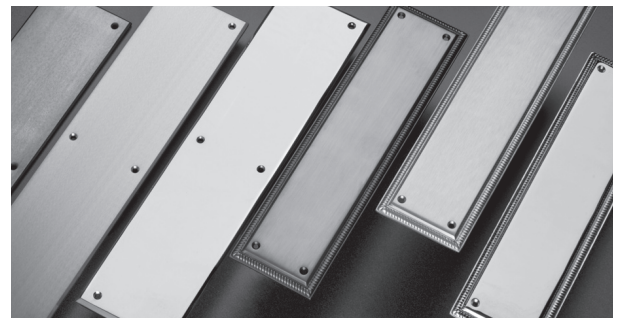
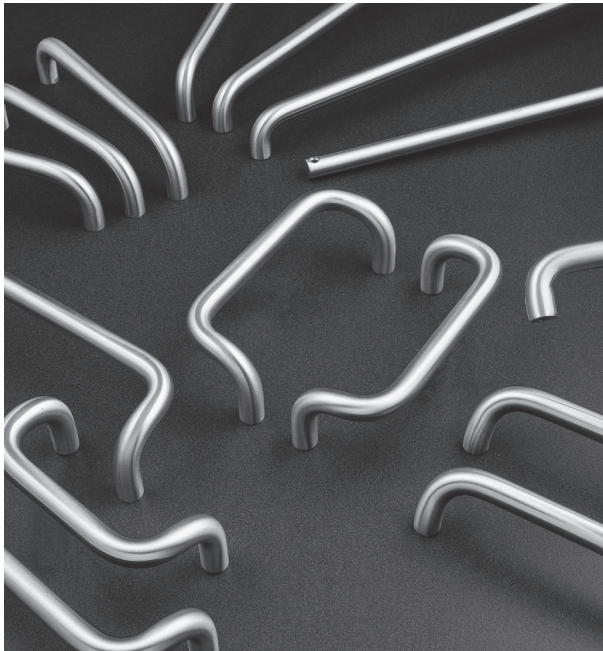

Rockwood Products Price Book - Accessories

Prices Effective September 1, 2017

Table of Contents	Page #
Architectural Finishes	33
Angle Plates	29
Auxiliary Hardware	27
Card Holder	25
Coordinators	27
Corner Guards	21
Covers	28
Custom Strikes	29
Decals	25
Door Edges	21-22
Door Guards	25
Door Knockers & Viewers	25
Door Plates - Kick Plates/Armor Plates	30-32
Door Pulls	16-20
Door Silencers	25
Door Stops	23-24
Fasteners - Spare Parts	38-41
Filler Plates & Shims	29
Flush Bolts	27
Flush Bolts - Manual	24
Flush Bolts - Residential	25
Flush Pulls	15
Gate Latch	24
Gravity Door Coordinators	24
General Information	8
Hospital Latches	24
Latch Protectors	22
Mounting Details	34-37
Mounting Kits	42
Numeric Index	4-7
Overhead Holders & Stops	28
Pivots	29
Privacy Door Latch	25
Pull Plate Sets	14
Pull Plates	20-21
Push and Pull Bars	9
Push Plate Ordering Information	12
Push Plates	13-15
Roller Latches	24
Series 47 Push Bars	10
Series 47 Tubular Push & Pull Bars	11
Signs	26
Surface Bolts	24-25
Trim Protector Bars	29
Vandal Resistant Trim & Vandal Resistant Pulls	20
Wall Guard	25

Prices Effective September 1, 2017

Copyright © 2017, Rockwood Manufacturing Company, an ASSA ABLOY Group company. All rights reserved.
 Reproduction in whole or in part without the express written permission of Rockwood Manufacturing Company is prohibited.

ASSA ABLOY

The global leader in
 door opening solutions

No.	Description	Page	No.	Description	Page
10-PB	Push Bar	9	102 x 70	Pull Plates	20
10BO	Bracket for #10.....	9	105	Straight Door Pull.....	16
11-PB – 18-PB	Push Bars.....	9	105 x 70	Pull Plates	20
19-PB	Push Bar	9	106-RKW	Straight Door Pull.....	16
20-PB – 23-PB	Pull Bars.....	9	106 x 70	Pull Plates	20
25-PB – 26-PB	Push Bars.....	9	107	Straight Door Pull.....	16
27-PB – 30-PB	Push Pull Bar Sets	9	107 x 70	Pull Plates	20
31-PB – 32-PB	Pull Bars.....	9	107 x 73B/73BL	Pull Plate Set.....	14
33-PB – 34-PB	Push Bars.....	9	107BTB5 – 112BTB5	Straight Door Pull Sets	16
35-PB – 36-PB	Push Pull Bar Sets	9	108 – 110-RKW	Straight Door Pull.....	16
40-PB – 42-PB	Screen Door Guards.....	9	110 x 70	Pull Plates	20
43-PB – 45-PB	Push Bars.....	9	110 x 73C/73CL	Pull Plate Set.....	14
47-PB, -2-PB, -3-PB	Series 47 Push Bars	10	110BTB13 – 112BTB13	Straight Door Pull Sets	16
48-PB	Series 47 Push Bar.....	10	110-6SP	Security Door Pull	16
50-PB	Pull Bar.....	9	111-RKW, 111A	Straight Door Pull.....	16
51-PB	Push Bar	9	111 x 70	Pull Plates	20
51BO	Bracket for #50.....	9	111 x 73C/73CL	Pull Plate Set.....	14
52-PB	Push Pull Bar Set	9	112	Straight Door Pull.....	16
53-PB	Push Pull Bar Set	9	118	Straight Door Pull.....	16
70 Series	Push Plates - .050" Thick	13	120 – 122-RKW	Door Pulls	17
71 Series	Push Plates - .062" Thick	13	122 x 70	Pull Plates	20
73 Series	Push Plates - .125" Thick	14	123	Door Pull.....	17
75 Series	Push Plates - .125" Thick	14	123 x 70	Pull Plates	20
76 Series	Decorative Push Plates - .050" Thick.....	14	125-RKW	Door Pull.....	17
77 Series	Decorative Push Plates - .050" Thick.....	14	125 x 70	Pull Plates	20
80 – 86	Push Plates - .050" Thick	15	126-RKW	Door Pull.....	17
87	Push Plate - .125" Thick	15	126 x 70	Pull Plates	20
90, 90B	Cylinder Pulls	15	130-RKW – 132-RKW	Cast Door Pulls	17
91-RKW – 93-RKW	Combination Push Pull Plates.....	15	132 x 70	Pull Plates	20
94, 94BTB	Flush Pulls.....	15	134-RKW – 137	Cast Door Pulls	17
94C	Flush Pull.....	15	137 x 70	Pull Plates	20
94DLL, 94DLS	Dead Lock Flush Pulls.....	15	138 – 139	Cast Door Pulls	17
94L, 94P	Flush Pulls.....	15	147, 147L	Cast Door Pulls	17
94P x 94L	Flush Pull Set	15	147 x 76, 77	Decorative Pull Plates	21
95A, 95B	Flush Pulls.....	15	148	Cast Door Pull	17
95R	Flush Pull - Round.....	15	148 x 76, 77	Decorative Pull Plates	21
96	Flush Pull.....	15	149	Cast Door Pull	17
102-RKW	Straight Door Pull.....	16	176-RKW – 177	Offset Door Pulls.....	19

ASSA ABLOY

The global leader in
 door opening solutions

Prices Effective September 1, 2017

Copyright © 2017, Rockwood Manufacturing Company, an ASSA ABLOY Group company. All rights reserved.
 Reproduction in whole or in part without the express written permission of Rockwood Manufacturing Company is prohibited.

No.	Description	Page	No.	Description	Page
185	Offset Door Pull.....	19	505-RKW – 508	Cast Brass Door Stops.....	24
193	Hospital Door Pull.....	19	517	Aluminum Door Stop	24
208	Wooden Door Pull	19	518 – 519	Cast Brass Door Stops.....	24
215, 215L	Tapered Door Pulls.....	19	520	Replacement Bumper	24
290 – 296	Corner Guards	21	525 – 526	Spring Base Door Stops	24
300 – 302B	Mortise Door Edges.....	21	528	Hinge Pin Stop.....	24
304 – 307	Non-Mortise Door Edges	22	550 Series	Lever Ext. Flush Bolt, Guide & Strike.....	24
308 – 310B-BS	Overlapping Door Edges	22	554 Series	Rabbit Piece, Guide & Strike	24
320-RKW – 330	Latch Protectors	22	555 Series	Lever Ext. Flush Bolt, Bolt Head, Guide & Strike.....	24
400 – 405	Solid Cast Wall Stops	23	555ROD	Optional Bolt Lengths	24
406 – 409	Wrought Wall Stops.....	23	555 x BFB	Flush Bolt w/Bottom Fire Bolt	24
412 – 416	Solid Cast Wall Stops	23	556WS	Lever Ext. Wind Storm Flush Bolt	24
426	Wall Stop	23	557 Series	Lever Ext. Flush Bolt & Strike	24
430-RKW	Solid Cast Wall Stop	23	570	Dust Proof Strike.....	24
431-RKW, 432W	Wall Stops	23	576, 576B	Gravity Door Coordinator.....	24
438 – 439	Light Duty Dome Stops	23	580 Series	Surface Bolts	24
440 – 441	Low Dome Stops	23	582 Series	Surface Bolts	24
441CU	Dome Stop Combination Unit.....	23	585 Series	Heavy Duty Surface Bolts.....	24
441H	Cast Universal Dome Stop.....	23	590 – 594	Roller Latches	24
442 – 443	High Dome Stops.....	23	596 Series	Hospital Push Pull Latches.....	24
444	Cast Door Stop Riser	23	602	Secret Gate Latch	24
445, 445H	Heavy Duty Door Stops	23	603 – 604 Shim	Door Guards w/Shim	25
446	Door Stop.....	23	605, 605SMS	Door Guard Protection Plates	25
449	Door Stop Riser.....	23	606-RKW	Wall Guard	25
455	Curved Roller Stop	23	607 (PDL)	Privacy Door Latch.....	25
456-RKW, 456L	Straight Roller Stops	23	608-RKW – 609	Door Silencers	25
458	Kick Down Door Stop.....	23	611	Door Knocker.....	25
459	Spring Loaded Plunger Stop	23	614, 614V	Door Knockers.....	25
460 – 461L	Kick Down Door Stops	23	619	160° Door Viewer	25
462 – 468-RKW	Heavy Duty Door Stops	23	620	160° Door Viewer	25
470 – 481	Door Stops.....	23	620VC	Viewer Cover for 619.....	25
481MP	Heavy Duty Mounting Plate.....	23	621	160° Door Viewer	25
482 – 485	Door Stops.....	23	622	190° Door Viewer	25
486	Angle Door Stop	23	622VC	Viewer Cover for 622.....	25
487	Heavy Duty Wall Stop.....	23	624	160° Door Viewer w/Cover	25
488 – 489	Door Stops.....	24	626 – 629	190° Door Viewers w/Cover	25
490	Door Holder & Stop	24	630 Series	Surface Bolts	25
491-RKW – 494S	Automatic Door Holders & Stops.....	24			

No.	Description	Page	No.	Description	Page
640, 640RE	Residential Flush Bolts	25	BF150 – BF159	90° Offset Door Pulls	18
651	Card Holder	25	BF156 – BF159 BTB16	90° Offset Door Pull Sets.....	18
660, 661, 662-RKW	Decals	25	BF156 – BF159 C17	90° Offset Door Pull Sets.....	18
670 Series	Engraved Signs.....	26	BF160 – BF169	45° Offset Door Pulls	19
674H, 674L	Engraved Signs.....	26	BF257 – BF260	Heavy Duty Offset Door Pulls.....	20
700 – 702	Hand Rail Brackets.....	27	BF680 Series	Engraved Signs w/Braille.....	26
790	Small Coat Hook.....	27	BF683 – BF689	ADA Tactile Signs w/Braille	26
796	Small Double Coat Hook.....	27	BF15647, -2, -3	Offset Push Pull Bar Sets.....	10
802, 806	Medium Coat Hooks.....	27	BF15747, -2, -3	Offset Push Pull Bar Sets.....	10
841	Ball Knob.....	27	BF157A47, -2, -3	Offset Push Pull Bar Sets.....	10
845	Utility Pull.....	27	BF15847, -2, -3	Offset Push Pull Bar Sets.....	10
850 – 856-RKW	Wire Pulls.....	27	BF15947	Offset Push Pull Bar Set.....	10
860	Flush Cup Pull.....	27	BFLG10 – BFLG16	Latch Guard Covers	28
870	Wrought Flush Pull	27	BFM682 – BFM689	Tactile ADA Molded Plastic Signs w/Braille.....	26
872	Cast Flush Pull	27	BFRC12, BFRC24	Vertical Rod Covers	28
880	Cast Lever Edge Pull.....	27	BP47, -2, -3	Series 47 Push Bars w/Base Plate.....	10
885-RKW	Concealed Edge Pull.....	27	CP10 – CP10HD	Pivots - Standard Head	29
890 – 891	Pocket Door Pulls	27	CP20 – CP20HD	Pivots - Standard Head Pivot	29
900 – 901	Magnetic Catches.....	27	CP40 – CP40HD	Pivots - Standard Floor	29
910 – 911	Adjustable Ball Catches	27	CP50 – CP50HD	Pivots - Standard Floor Pivot.....	29
1100	Carry Bar	27	CPK2840	Cover Plate Kit	27
1700	Door Coordinator	27	CS Series	Custom Strikes	29
2600 Series	Door Coordinators	27	D89	Security Flush Pull	15
2805	Self Latching Flush Bolt (Top Only).....	27	D133-RKW	Security Loop Door Pull.....	17
2840, 2842	Automatic Flush Bolt Sets.....	27	DF86	Door Edge Filler Plate.....	29
2845	Combination Flush Bolt Set	27	DFF4	Frame Hinge Filler Plates	29
2848, 2849	Flush Bolts w/Bottom Fire Bolt	27	DFF5	Frame Hinge Filler Plates	29
2905	Self Latching Flush Bolt (Top Only).....	27	DHF4B	Door Hinge Filler Plates	29
2940, 2942	Automatic Flush Bolt Set.....	27	DHF4S	Door Hinge Filler Plates	29
2945	Combination Flush Bolt Set	27	DHF5B	Door Hinge Filler Plates	29
2948, 2949	Flush Bolts w/Bottom Fire Bolt	27	DHF5S	Door Hinge Filler Plates	29
2960, 2962	Automatic Flush Bolts	27	FB-1, -2	Filler Bars.....	27
11047, -2, -3	Straight Push Pull Bar Sets	10	FBF48	Flush Bolt Filler Plate	29
11147, -2, -3	Straight Push Pull Bar Sets	10	FBS48	Flush Bolt Strike Filler Plate	29
111A47, -2, -3	Straight Push Pull Bar Sets	10	FC161	Door Face Filler Plate.....	29
11247, -2, -3	Straight Push Pull Bar Sets	10	FD160	Door Face Filler Plate.....	29
11847	Straight Push Pull Bar Set	10	HD2230	Heavy Duty Trim Protector Bars	29
BF97, BF97L	Barrier Free Flush Pulls.....	15			

ASSA ABLOY

The global leader in
door opening solutions

Prices Effective September 1, 2017

Copyright © 2017, Rockwood Manufacturing Company, an ASSA ABLOY Group company. All rights reserved.
Reproduction in whole or in part without the express written permission of Rockwood Manufacturing Company is prohibited.

No.	Description	Page	No.	Description	Page
HD2230M	Heavy Duty Trim Protector Bars	29	R116EDPL	Exit Device Protector	29
HD2240	Heavy Duty Trim Protector Bars	29	SD1230	Standard Duty Trim Protector Bar	29
HD2240M	Heavy Duty Trim Protector Bars	29	SD1240	Standard Duty Trim Protector Bar	29
HD2250	Heavy Duty Trim Protector Bars	29	SD1250	Standard Duty Trim Protector Bar	29
HD2250M	Heavy Duty Trim Protector Bars	29	SD1260	Standard Duty Trim Protector Bar	29
HG70C	Push Plate - .050" Thick Horizontal Grain	13	SF160	Strike Filler Plate	29
HS42	4 Hinge Shims	29	SFASA	Strike Filler Plate	29
HS44	4 1/2" Hinge Shims	29	SFB160	Strike Filler Plate	29
HS52	5" Hinge Shims	29	SP47	Series 47 Push Bar	10
HS54	5" Hinge Shims	29	SP1001 – SP1079	Fasteners - Spare Parts	38-41
K1038	Metal Door Plate - .038" Thick	31	T47, -2, -3	Tubular Push Bars	11
K1050, K1050F	Metal Door Plates - .050" Thick	31	T110 – T118	Tubular Door Pulls	16
K1050-1 – K1050-8	Shaped Metal Door Plates - .050" Thick	31	T110 – T112 BTB5	Tubular Door Pulls Sets	16
K1050A-1 – K1050A-8	Shaped Metal Door Plates - .050" Thick	31	T110 – T112 BTB13	Tubular Door Pulls Sets	16
K1062	Metal Door Plate - .062" Thick	32	T110 x 70	Tubular Pull Plates	21
K1125	Metal Door Plate - .125" Thick	32	T111 x 70	Tubular Pull Plates	21
K2060 Series	Plastic Door Plates - .060" Thick	32	T11047	Tubular Straight Push Pull Bar Sets	11
K2125 Series	Plastic Door Plates - .125" Thick	32	T11147	Tubular Straight Push Pull Bar Sets	11
K3125	Laminate Plastic Door Plate - .125" Thick	32	T111A47	Tubular Straight Push Pull Bar Sets	11
K4125	Clear Plastic Door Plate - .125" Thick	32	T11247	Tubular Straight Push Pull Bar Sets	11
KB1150 – KB1152	Angle Plates - .050" Thick	29	T11847	Tubular Straight Push Pull Bar Set	11
KIT Series	Mounting Kits for Door Pulls	42	TBF156 – TBF159	Tubular 90° Offset Door Pulls	18
LA86	Latch Adapter Plate	29	TBF156 – TBF159 BTB16	Tubular 90° Offset Door Pull Sets	18
LF161	Door Edge Filler Plate	29	TBF156 – TBF159 C17	Tubular 90° Offset Door Pull Sets	18
MFKIT	Multi-Function Friction & Hold Open Kit	28	TBF15647	Tubular Offset Push Pull Bar Sets	11
OH100	HD Concealed Overhead Stops	28	TBF15747	Tubular Offset Push Pull Bar Sets	11
OH200	Concealed Overhead Holders & Stops	28	TBF157A47	Tubular Offset Push Pull Bar Sets	11
OH900	HD Surface Overhead Stops	28	TBF15847	Tubular Offset Push Pull Bar Sets	11
OH1000	Surface Overhead Holders & Stops	28	TBF15947	Tubular Offset Push Pull Bar Set	11
OH103-ALM - OH1003S-ALM	Overhead Stops w/Aluminum Channel	28	VRP30	Vandal Resistant Pull	20
PDL (607)	Privacy Door Latch	25	VRT12 – VRT26	Vandal Resistant Trim	20
R101LPB	Trim Protector Bars	29	Y102 – Y112	Straight Door Pulls w/Base Plates	17
R102LPB	Trim Protector Bars	29	Y118	Straight Door Pulls w/Base Plate	17
R111LPB	Trim Protector Bars	29	YBF150 – YBF159	90° Offset Door Pulls w/Base Plates	19
R112LPB	Trim Protector Bars	29			
R115LPB	Trim Protector Bars	29			
R116EDPH	Exit Device Protector	29			

Ordering Information

This price list cancels and supersedes all prior listings.
Orders are accepted with the understanding that they will be billed at prices in effect at time of shipment.
Prices are subject to change without notice.
We reserve the right to decline the whole or part of orders in which the price or quantity of goods is not acceptable to us.

Easy Order Placement

By Phone: 1-800-458-2424 Monday through Thursday 8:00 am ET to 7:00 pm ET, Friday 8:00 am ET to 4:30 pm ET
By Fax: Orders may be faxed to 1-800-922-9212
By Email: orders.rockwood@assaabloy.com
By Internet: <http://extranet.assaabloydss.com/> and select Order Entry under the Customer Service Menu

Terms and Conditions of Sale

Terms: 1% 15 days, net 30 days
Remit Payment To: PNC Bank/Rockwood, PO Box 644489, Pittsburgh, PA 15264-4489

Freight Policy

Freight Allowance: All prices are F.O.B. Rockwood, Pennsylvania. Full freight will be allowed on shipments of \$1,000 net and over within the continental limits of the United States (excluding Alaska and Hawaii). All shipments are routed most cost effective route of our choice. We reserve the right to designate the carrier.

Special Order Material

Special items made to your specifications are not returnable. These items are not subject to cancellation without consideration of expense involved at the cancellation date.

Samples

Salable samples will be charged at regular prices.

Returned Goods

Return no merchandise without written permission from the factory. Authorization will insure your receiving proper credit. Errors in shipping may occasionally occur. If this is the case immediately notify the factory, and we will gladly make the proper adjustments. If the error is at the customer's end, a minimum charge of 25% plus freight will be incurred for handling. Unauthorized claims for labor or charges will not be allowed. No credit will be allowed beyond six months after invoice date.

Shortages

Claims for shortages must be made within 30 days of invoice date.

Templates

Upon request we will furnish templates for any of our standard items of manufacture. Commonly used templates are available on our website at www.rockwoodmfg.com.

Product Weight Information

NOTE: Weights indicated throughout the price list are approximate for brass, bronze or stainless steel base material. Aluminum base materials weigh approximately $\frac{1}{3}$ the listed weights.

Engraving

Engraving may be added on many pulls. Call factory for pricing.

ASSA ABLOY

The global leader in
door opening solutions

Prices Effective September 1, 2017

Copyright © 2017, Rockwood Manufacturing Company, an ASSA ABLOY Group company. All rights reserved.
Reproduction in whole or in part without the express written permission of Rockwood Manufacturing Company is prohibited.

Push and Pull Bars

Push and Pull Bars							
Part	28/628	3/605 4/606	10/612 10B/613	Stock PC 10BE	26/625 26D/626	32D/630	32DMS
10-PB		354	354	351	342		
10BO		114	114	113	111		
11-PB	143	291	333	178	322	152	174
12-PB	143	291	333	178	322	152	174
14-PB	143	333	373	195	362	166	191
15-PB	143	333	373	195	362	166	191
18-PB	143	333	373	195	362	166	191
19-PB	143	333	373	195	362	166	191
20-PB	349			427		364	419
21-PB	395	827	1014	476	984	406	467
22-PB	402			492		420	483
23-PB	427	933	1117	517	1084	441	507
25-PB	137			154		131	151
26-PB	143	312	373	162	362	138	159
27-PB	615			735		627	721
28-PB	678	1447	1758	798	1707	681	783
29-PB	671			798		681	783
30-PB	709	1550	1861	840	1805	716	824

Push and Pull Bars							
Part	28/628	3/605 4/606	10/612 10B/613	Stock PC 10BE	26/625 26D/626	32D/630	32DMS
31-PB	350			534		456	524
32-PB	368	840	942	547	914	466	537
33-PB	303			417		356	410
34-PB	321	679	761	430	738	366	422
35-PB	518			951		812	933
36-PB	532	1518	1699	977	1648	834	959
40-PB		307	307	274	297		
41-PB		217	217	194	210		
42-PB		157	157	140	152		
43-PB	162	487	583	345	565	294	338
44-PB	150	455	546	325	530	277	319
45-PB	141	413	495	307	480	263	301
50-PB		407	445	397	431		
51-PB		163	179	161	173		
51BO		32	36	32	35		
52-PB		727	799	713	776		
53-PB		139	156	140	151		

Push & Pull Extra Length Bars

Extra Length Bars						
Description	28/628	3/605 4/606	10/612 10B/613	Stock PC 10BE	26/625 26D/626	32D/630
Over 3/4" thru 1 1/2"	3	6	7	7	6	5
Over 1 1/2" thru 3"	4	8	9	9	8	7

Bars over 36" add per inch the following additional cost.

Mounting Types for Push Bars 10 through 45 and 50, 51, 52

Mounting charge included in list price.

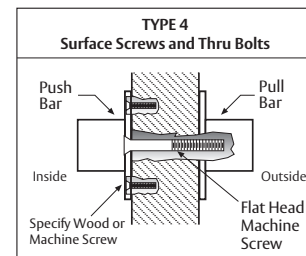
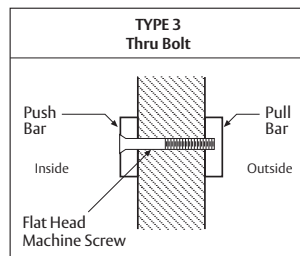
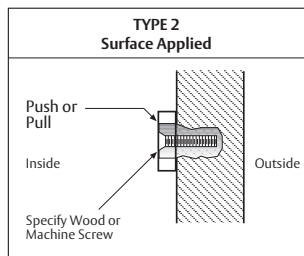
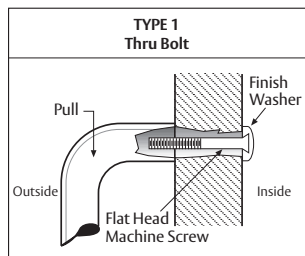

Series 47 Push Bars

Series 47 Push Bars											
Part	28/628	313/710 314 315/711	3/605 4/606	10/612 10B/613	Stock PC 10BE	26/625 26D/626	32D/630	32/629	32DMS	32D316	32316
SP47	78	93	235	294	242	226	211	242	239	274	294
47-PB	66	81	221	221	223	215	193	217	220	256	268
47-2-PB	130	158	442	442	445	428	386	435	440	509	534
47-3-PB	194	237	662	662	667	642	579	652	659	763	801
48-PB	66	78	174	205	141	168	113	153	139	164	187
BP47	104	117	259	259	259	250	227	254	256	293	305
BP47-2	208	235	553	553	554	537	489	544	548	621	645
BP47-3	271	313	786	786	789	763	694	773	780	888	926
Straight Single Bar Sets											
11047	94	112	315	339	303	305	262	296	300	351	375
111A47	95	113	318	355	305	308	264	303	302	355	380
11147	95	113	318	355	312	308	270	309	309	362	386
11247	96	115	330	366	321	321	278	315	317	372	398
11847	107	128	376	414	347	365	303	345	343	409	433
Straight Double Bar Sets											
11047-2	158	191	534	560	524	518	454	514	518	605	641
111A47-2	160	192	538	574	527	522	458	519	521	609	645
11147-2	160	192	538	574	534	522	464	525	528	615	653
11247-2	161	194	551	586	542	534	470	531	536	628	664
Straight Triple Bar Sets											
11047-3	222	268	754	780	746	732	648	731	737	858	908
111A47-3	223	269	757	794	748	735	650	736	739	862	913
11147-3	223	269	757	794	756	735	656	742	748	869	919
11247-3	225	272	771	807	764	748	665	749	755	883	931
Offset Single Bar Sets											
BF15647	111	134	352	379	332	341	287	327	329	401	427
BF157A47	115	139	361	388	337	350	291	330	333	407	432
BF15747	115	139	361	388	343	350	295	334	339	412	439
BF15847	123	146	369	398	352	358	304	344	348	423	449
BF15947	138	161	401	425	380	389	330	371	375	458	485
Offset Double Bar Sets											
BF15647-2	175	212	573	600	554	555	480	544	548	656	693
BF157A47-2	180	218	581	609	559	564	485	547	552	660	699
BF15747-2	180	218	581	609	566	564	489	551	560	666	704
BF15847-2	187	223	590	616	573	572	496	562	567	677	716
Offset Triple Bar Sets											
BF15647-3	240	290	793	820	776	770	673	760	768	910	961
BF157A47-3	244	297	802	829	782	777	677	763	773	914	965
BF15747-3	244	297	802	829	787	777	681	769	778	921	972
BF15847-3	252	302	810	837	795	786	691	778	786	931	981
Series 47 Extra Length Bars - Bars over 36" add per inch the following additional cost per bar.											
	3	3	4	4	5	3	3	5	5	5	6

See page 35 for detailed mounting drawings. Engraving "Push" or "Pull" on 1" Series 47 Push Bars add \$95.00 (1/2" Letter Height).



The global leader in
door opening solutions

Prices Effective September 1, 2017

Copyright © 2017, Rockwood Manufacturing Company, an ASSA ABLOY Group company. All rights reserved. Reproduction in whole or in part without the express written permission of Rockwood Manufacturing Company is prohibited.

Series 47 Tubular Push & Pull Bars

Series 47 Tubular Push Bars								
Part	3/605	4/606	10/612	10B/613	Stock PC 10BE	32D/630	32/629	32DMS
T47	192	192	203	203	156	131	151	150
T47-2	381	381	405	405	310	260	303	299
T47-3	572	572	606	606	465	390	454	448
Series 47 Tubular Straight Single Bar Sets								
T11047	292	292	306	306	225	189	228	217
T111A47	297	297	314	314	228	191	230	220
T11147	297	297	314	314	228	191	230	220
T11247	304	304	318	318	231	193	232	222
T11847	318	318	332	332	243	204	246	234
Series 47 Tubular Offset Single Bar Sets								
TBF15647	324	324	336	336	234	195	252	226
TBF157A47	327	327	342	342	237	200	254	229
TBF15747	327	327	342	342	237	200	254	229
TBF15847	332	332	346	346	241	202	257	232
TBF15947	348	348	365	365	258	216	272	248

See page 35 for detailed mounting drawings. Engraving "Push" or "Pull" on 1" Series 47 Push Bars add \$95.00 (1/2" Letter Height).

TYPICAL MOUNTING

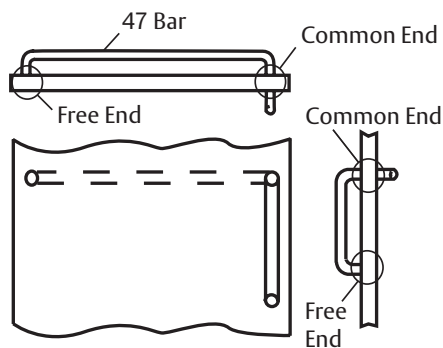

For Set Mounting Hardware, see page 34.

Location Standards

Positioning Applications:

- door pulls to plates
- engraving on plates
- cutouts on plates
- cutout and engraving on plates

Sizing:

- 1 1/4" standard cylinder hole cutout size
- 3/8" diameter standard thumbturn hole
- other cutout sizes and styles are readily available

NOTE: Be sure the pull you choose will fit on the plate, allowing for cutouts and/or engraving.

Pull Positioning on Plates 4" or Less in Width

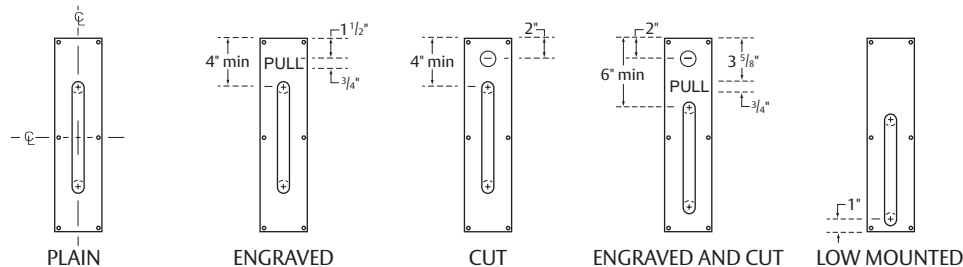

Pull Positioning on Plates Wider than 4" (Handing Required)

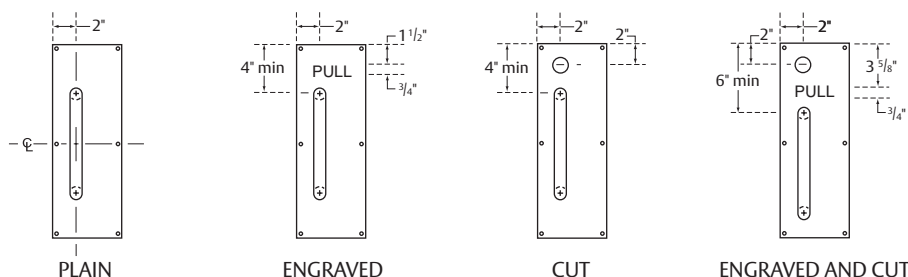

Recommended Locations on Door

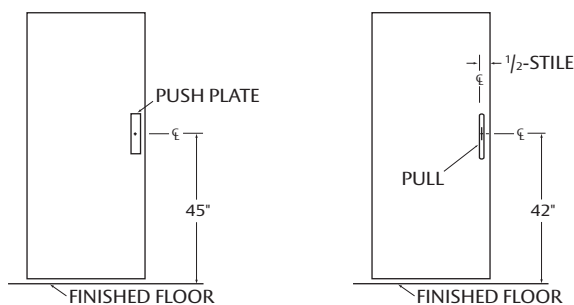

Engraving and Adhesive Mounting

Description	Price
Engraving "Push", "Pull", "Men" or "Women"	21 (24 for Stainless Steel)
Push Plate Adhesive Mounting	9

Engraving: 3/4" high condensed block letters with black enamel fill; other letter sizes and styles are readily available.

Additional Charges Per Thickness of Push Plate

Part	Description	70	71	73	74
CFC	Cut for Cylinder	2	3	5	9
CFTT	Cut for Thumbturn	2	3	5	9

ADA Accessibility Guidelines for Buildings and Facilities (ADAAG)

as amended through January 1998 4.13.9 Door Hardware. Handles, pulls, latches, locks, and other operating devices on accessible doors shall have a shape that is easy to grasp with one hand and does not require tight grasping, tight pinching, or twisting of the wrist to operate. Lever-operated mechanisms, push-type mechanisms, and U-shaped handles are acceptable designs. When sliding doors are fully open, operating hardware shall be exposed and usable from both sides. Hardware required for accessible door passage shall be mounted no higher than 48 in. (1220 mm) above finished floor.

Push Plates - .050" Thick

No. 70 - Square Ends									
Part	28/628	3/605 4/606	10/612 10B/613	Stock PC 10BE	26/625 26D/626	32D/630	32/629	32DMS	32D316
70A	13	23	24	15	23	13	17	15	22
70B	14	24	29	18	28	16	21	18	22
70C-RKW	14	29	32	19	31	16	23	19	24
70E	21	44	50	33	48	28	38	33	37
70F	23	50	59	35	56	30	42	35	45
70G	17	33	40	23	38	20	26	23	29
No. 70RC - Round Corners									
70RCA	17	27	28	18	27	16	20	18	25
70RCB	19	29	33	22	32	19	24	22	25
70RCC	19	32	36	24	35	21	26	24	27
70RCE	24	47	53	37	51	32	42	37	43
70RCF	26	54	63	40	61	35	46	40	49
70RCG	21	36	44	27	42	23	29	26	32
No. 70RE - Round Ends									
70REA	23	32	34	26	33	22	26	25	31
70REB	24	34	40	28	38	24	29	27	31
70REC	25	38	44	31	42	26	32	30	32
No. HG70C - Horizontal Grain									
HG70C	14	29				16	23		

See page 12 for standard locations and sizes of Cylinder Cutouts (CFC) and Thumbturn Cutouts (CFTT), engraving and pricing.

Push Plates - .062" Thick

No. 71 - Square Corners			
Part	Stock PC 10BE	32D/630	32DMS
71A	23	20	23
71B	26	22	25
71C	30	25	29
71E	39	34	39
71F	46	39	45
71G	34	29	34
No. 71RC - Round Corners			
71RCA	28	24	27
71RCB	31	26	30
71RCC	34	29	34
71RCE	46	39	45
71RCF	49	42	48
71RCG	39	34	39
No. 71RE - Round Ends			
71REA	37	32	37
71REB	39	34	39
71REC	42	36	41

Prices Effective September 1, 2017

Copyright © 2017, Rockwood Manufacturing Company, an ASSA ABLOY Group company. All rights reserved.
Reproduction in whole or in part without the express written permission of Rockwood Manufacturing Company is prohibited.

ASSA ABLOY

The global leader in
door opening solutions

Concealed Mount Pull Plate Sets

Pull Plate x Plate with Lug			
Part	32D/630	32DMS	Stock PC 10BE
107 x 73B/73BL	150	172	175
110 x 73C/73CL	197	226	230
111 x 73C/73CL	204	235	238

Pull (only) x Plate with Lug			
Part	32D/630	32DMS	Stock PC 10BE
107 x 73BL	105	120	123
110 x 73CL	147	169	171
111 x 73CL	156	180	183

See page 12 for standard locations and sizes of Cylinder Cutouts (CFC) and Thumbturn Cutouts (CFTT), engraving and pricing. See page 36 for detail drawing of Type 9 mounting.

Push Plates

No. 73 - Square Corners (.125" Thick)									
Part	28/628	3/605 4/606	10/612 10B/613	Stock PC 10BE	26/625 26D/626	32D/630	32/629	32DMS	32D316
73A	26	71	85	50	82	43	61	49	56
73B	31	78	89	54	86	46	63	54	60
73C	32	85	95	59	92	50	69	58	67
73E	39	114	125	81	120	69	88	80	98
73F	46	142	153	99	148	85	100	98	110
73G	34	101	114	66	110	57	80	65	79
No. 73RC - Round Corners (.125" Thick)									
73RCA	39	82	94	60	91	51	74	59	66
73RCB	41	87	99	64	96	55	75	63	70
73RCC	44	94	103	68	100	59	82	67	77
73RCE	52	124	133	92	129	79	101	90	108
73RCF	59	153	163	111	158	95	112	109	121
73RCG	47	110	124	76	119	65	91	75	89
No. 73RE - Round Ends (.125" Thick)									
73REA	58	98	110	79	107	67	89	78	83
73REB	62	103	116	82	112	70	91	81	87
73REC	63	110	121	88	117	76	98	87	94
Laminate and Clear Plastic - Square Corners (.125" Thick)									
Part	Black	Brown	Gray	Beige	Clear				
75A	13	13	13	13	13				
75B	14	14	14	14	14				
75C	14	14	14	14	15				
75E	18	18	17	17	18				
75F	20	20	19	19	20				
75G	17	17	16	16	17				
Decorative (.050" Thick)									
Part	3/605 4/606	10/612 10B/613	Stock PC 10BE	26/625 26D/626					
76B	42	46	42	44					
76C	45	49	45	47					
77B	42	46	42	44					
77C	45	49	45	47					

See page 12 for standard locations and sizes of Cylinder Cutouts (CFC) and Thumbturn Cutouts (CFTT), engraving and pricing.

ASSA ABLOY

The global leader in
door opening solutions

Prices Effective September 1, 2017

Copyright © 2017, Rockwood Manufacturing Company, an ASSA ABLOY Group company. All rights reserved. Reproduction in whole or in part without the express written permission of Rockwood Manufacturing Company is prohibited.

Push Plates (con't)

.050" Thick									
Part	28/628	3/605 4/606	10/612 10B/613	Stock PC 10BE	26/625 26D/626	32D/630	32/629	32DMS	32D316
80	39	64	70	47	68	40	53	46	58
81	41	67	72	51	70	44	57	50	62
82	44	71	80	55	77	47	60	55	65
84	68	114	122	93	118	80	93	91	96
85	25	48	49	37	47	32		37	
86	36	55	58	46	55	39		45	
.125" Thick									
87	64	131	141	109	136	93	112	107	

See page 12 for standard locations and sizes of Cylinder Cutouts (CFC) and Thumbturn Cutouts (CFTT), engraving and pricing.

Flush Pulls

Heavy Duty Security - Cast Brass										
Part	4/606	26D/626	Stock PC 10BE							
D89	98	66	75							
Cylinder Pulls - .125" Thick										
Part	28/628	3/605 4/606	10/612 10B/613	Stock PC 10BE	26/625 26D/626	32D/630	32/629	32DMS	32D316 32316	
90	45	50	56	53	54	44		53		
90B	38	48	50	47	48	41		47		
Combination Pulls - .125" Thick - See page 12 for standard locations and sizes of Cylinder Cutouts (CFC) and Thumbturn Cutouts (CFTT), engraving and pricing.										
91-RKW	43	80	84	62	81	54		61		
92-RKW	47	83	87	66	84	57		65		
93-RKW	70	147	156	120	151	104		119		
Flush Pulls - .125" Thick										
94		69	74	41	71	36	53	41	47	65
94BTB (pair)		144	152	90	147	78	107	90	100	135
94C		71	77	45	74	39	55	45	49	67
94L		80	83	52	80	45	61	52	58	76
94P		71	77	45	74	39	55	45	49	67
94P x 94L		150	157	96	152	83	114	96	105	141
Dead Lock Pulls - For Barrier Free grip specify BF94DLL or BF94DLS. Used with dead bolt lock. 1 1/4" cylinder hole is standard.										
94DLL		121	121	97	117	84	104	97	107	127
94DLS		102	102	77	98	66	87	77	89	107
Cast Brass - Fasteners concealed in cup.										
95A		31	32	35	31					
95B		32	34	38	33					
95R		42	44	48	42					
Flush Pull - .125" Thick - See page 12 for standard locations and sizes of Cylinder Cutouts (CFC) and Thumbturn Cutouts (CFTT), engraving and pricing.										
96		100	107	74	104	64		73		
Barrier Free - .125" Thick										
BF97		127	134	104	130	90		103		
BF97L		150	159	130	153	112		130		

Straight Door Pulls & Door Pull Sets

Straight Door Pulls & Door Pull Sets											
Part	28/628	313/710 315/711	3/605 4/606	10/612 10B/613	Stock PC 10BE	26/625 26D/626	32D/630	32/629	32DMS	32D316	32316
102-RKW	21	25	44	54	32	42	27	43	31		
105	22	26	49	61	35	47	29	44	33	50	61
106-RKW	22	26	50	63	36	48	30	46	34	51	63
107	24	29	56	68	39	53	32	47	37	54	64
108	26	31	64	81	48	62	42	54	47	61	73
109	29	32	69	89	54	67	46	59	52	65	79
110-RKW	30	34	94	120	81	90	69	81	78	95	108
111A	31	35	97	134	84	94	72	86	82	101	112
111-RKW	31	35	97	134	93	94	78	92	89	107	119
112	32	37	109	145	100	106	84	98	97	119	133
118	44	49	156	195	129	150	109	129	126	155	167
Straight Door Pull Sets — Type 5 Back-to-Back Mount for 1 3/4" Door.											
107BTB5	59	67	119	149	89	114	75	102	85	113	139
108BTB5	63	72	139	170	109	135	91	116	105	133	158
110BTB5	70	77	199	251	177	193	147	169	169	202	226
111BTB5	72	79	208	281	198	201	166	193	191	224	249
112BTB5	74	87	231	305	214	225	180	207	206	249	274
Straight Door Pull Sets — Type 13 Back-to-Back Mount for 1/2" Glass Door.											
110BTB13	77	87	208	260	184	201	154	176	177	210	234
111BTB13	79	90	215	288	207	208	172	202	198	231	257
112BTB13	83	94	240	312	223	231	187	213	215	257	283

See page 34 for mounting selection and charges. NOTE: For BF Barrier Free projection on applicable straight door pulls add: \$8.40 each list. Add \$52.50 for knurling — round pulls only.

Security Door Pull

Security Door Pull			
Part	Stock PC 10BE	32D/630	32DMS
110-6SP	212	180	189

For use on security hollow metal doors with reinforcing plate and access hole cover plate with *TORX® - security torx screws — all to be supplied by door manufacturer.

Tubular Door Pulls & Door Pull Sets

Tubular Straight Door Pulls — Type 1 Thru-Bolt Mount for 1 3/4" Door.						
Part	3/605 4/606	10/612 10B/613	Stock PC 10BE	32D/630	32/629	32DMS
T110	103	105	74	62	76	71
T111A	108	111	76	64	78	73
T111	108	111	76	64	78	73
T112	113	116	80	67	83	77
T118	127	129	91	76	96	87
Tubular Straight Door Pull Sets — Type 5 Back-to-Back Mount for 1 3/4" Door.						
T110BTB5	213	220	159	133	163	153
T111BTB5	226	232	165	137	170	159
T112BTB5	237	242	170	143	174	164
Tubular Straight Door Pull Sets — Type 13 Back-to-Back Mount for 1 3/4" Glass.						
T110BTB13	222	230	167	140	172	161
T111BTB13	234	240	172	145	176	166
T112BTB13	244	250	178	149	180	172

*Torx® is a registered trademark of Textron Inc.

ASSA ABLOY

The global leader in
door opening solutions

Prices Effective September 1, 2017

Copyright © 2017, Rockwood Manufacturing Company, an ASSA ABLOY Group company. All rights reserved. Reproduction in whole or in part without the express written permission of Rockwood Manufacturing Company is prohibited.

Door Pulls with Base Plates

Pulls with Base Plates											
Part	28/628	313/710 315/711	3/605 4/606	10/612 10B/613	Stock PC 10BE	26/625 26D/626	32D/630	32/629	32DMS	32D316	32316
Y102	37	43	66	80	54	64	45	61	51		
Y105	37	43	72	88	58	70	48	62	56	69	83
Y106	37	45	73	90	59	71	49	64	57	71	85
Y107	40	46	79	95	61	75	51	65	59	72	86
Y108	45	48	89	106	72	86	60	72	69	83	94
Y109	46	50	94	114	77	91	64	81	75	87	99
Y110	47	50	118	147	105	113	87	101	101	116	131
Y111A	48	51	122	162	107	118	89	106	103	122	135
Y111	48	51	122	162	116	118	98	111	111	130	140
Y112	49	55	135	173	124	131	104	119	120	140	152
Y118	60	66	181	223	154	175	129	148	148	175	188

Door Pulls

Pulls - Engraving available vertically. See page 12 for pricing.							
Part	28/628	3/605 4/606	10/612 10B/613	Stock PC 10BE	26/625 26D/626	32D/630	32DMS
120	88			128		110	127
121	93			138		119	136
122-RKW	25	58	77	40	74	34	40
123	29			48		42	48
125-RKW	29	62	66	54	64	46	53
126-RKW	31	73	81	60	78	51	59
Cast Pulls							
130-RKW	25	44	46	53	44	45	52
131-RKW	25	44	46	53	44	45	52
132-RKW	25	37	42	49	40	43	49
D133-RKW		57		60		51	59
134-RKW		56	60	66	58		
137		45	49	55	47	45	
137L		92	92	101	87		
138	38	64	70	79	68		
139	38	64	70	79	68		
Cast Pulls - See page 34 for mounting selection and charges.							
147		73	73	81	70		
147L		122	145	162	141		
148		109	109	122	106		
149		135	135	149	130		

90° Offset Door Pulls & Door Pull Sets

90° Offset Door Pulls & Door Pull Sets											
Part	28/628	313/710 315/711	3/605 4/606	10/612 10B/613	Stock PC 10BE	26/625 26D/626	32D/630	32/629	32DMS	32D316	32316
BF150	39	49	96	117	78	93	66	88	76	98	111
BF151	44	52	103	127	83	100	71	92	81	103	114
BF152	47	56	108	135	88	105	75	98	86	108	123
BF156	47	56	133	160	112	128	94	109	108	146	162
BF157A	52	61	140	168	117	136	99	113	113	151	166
BF157	52	61	140	168	122	136	103	119	119	158	171
BF158	59	67	148	177	130	144	110	128	127	169	183
BF159	72	84	180	205	162	175	136	156	157	205	218
Offset Door Pulls Sets - Type 16 Back-to-Back Mount for 1 3/4" Door. (Double Cone Head)											
BF156BTB16	107	123	279	331	238	269	200	234	230	307	334
BF157ABTB16	116	136	294	349	248	285	210	240	241	317	342
BF157BTB16	116	136	294	349	259	285	218	250	252	330	357
BF158BTB16	130	148	311	366	279	302	235	266	270	352	379
BF159BTB16	161	179	373	423	340	362	287	322	330	423	450
Offset Door Pulls - Type 17 Concealed Mount for 1 3/4" Aluminum Door. (Double Cone Head)											
BF156C17	62	69	146	174	127	141	107	126	123	163	174
BF157AC17	67	75	156	182	133	150	111	129	128	167	180
BF157C17	67	75	156	182	139	150	116	133	134	172	186
BF158C17	72	84	164	191	147	159	125	140	144	184	197
BF159C17	90	99	195	219	178	188	151	168	173	219	233
Tubular Offset Door Pulls - Type 1 Thru-Bolt Mount for 1 3/4" Door.											
TBF156			133	137	82		69	100	79		
TBF157A			138	140	85		71	103	82		
TBF157			138	140	85		71	103	82		
TBF158			142	146	87		73	105	84		
TBF159			158	164	108		90	120	104		
Tubular Offset Door Pull Sets - Type 16 Back-to-Back Mount for 1 3/4" Door. (Double Cone Head)											
TBF156BTB16			281	287	180		151	216	174		
TBF157ABTB16			290	295	188		158	220	181		
TBF157BTB16			290	295	188		158	220	181		
TBF158BTB16			297	304	195		163	225	188		
TBF159BTB16			332	343	230		192	257	221		
Tubular Offset Door Pull - Type 17 Concealed Mount for 1 3/4" Aluminum Door. (Double Cone Head)											
TBF156C17			150	153	102		85	116	98		
TBF157AC17			155	157	104		87	118	100		
TBF157C17			155	157	104		87	118	100		
TBF158C17			158	160	108		90	120	104		
TBF159C17			176	181	125		105	137	121		

See page 34 for mounting selection and charges.

ASSA ABLOY

The global leader in
door opening solutions

Prices Effective September 1, 2017

Copyright © 2017, Rockwood Manufacturing Company, an ASSA ABLOY Group company. All rights reserved.
Reproduction in whole or in part without the express written permission of Rockwood Manufacturing Company is prohibited.

90° Offset Door Pulls with Base Plates

Part	28/628	313/710 315/711	3/605 4/606	10/612 108/613	Stock PC 10BE	26/625 26D/626	32D/630	32/629	32DMS	32D316	32316
YBF150	58	66	120	143	102	116	85	108	98	119	134
YBF151	60	68	127	153	106	122	88	111	102	123	137
YBF152	63	71	134	163	112	129	93	119	108	131	144
YBF156	63	71	157	186	135	152	112	131	129	168	181
YBF157A	68	77	166	196	141	161	118	134	135	173	187
YBF157	68	77	166	196	147	161	122	139	141	179	192
YBF158	74	86	174	205	155	169	130	146	149	190	205
YBF159	92	101	207	233	186	200	156	175	180	226	242

See page 34 for mounting selection and charges.

45° Offset Door Pulls

Part	28/628	313/710 315/711	3/605 4/606	10/612 108/613	Stock PC 10BE	26/625 26D/626	32D/630	32/629	32DMS	32D316	32316
BF160	39	49	96	117	78	93	66	88	76	98	111
BF161	44	52	103	127	83	100	71	92	81	103	114
BF162	47	56	108	135	88	105	75	98	86	108	123
BF166	47	56	133	160	137	128	115	132	133	146	162
BF167A	52	61	140	168	142	136	120	136	138	151	166
BF167	52	61	140	168	147	136	125	139	144	158	171
BF168	59	67	148	177	157	144	132	151	152	169	183
BF169	72	84	180	205	188	175	159	177	183	205	218

See page 34 for mounting selection and charges.

Offset Door Pulls

Part	28/628	313/710 315/711	3/605 4/606	10/612 108/613	Stock PC 10BE	32D/630	32DMS
176-RKW	127	131	345	387	223	188	216
177	137	145	387	426	267	225	259
185	149	171	542	542	490	413	475

Call factory for engraving and pricing.

Hospital Door Pull

Part	3/605 4/606	10/612 108/613	Stock PC 10BE	26/625 26D/626	32D/630	32DMS
193	56	59	66	57	56	65

Wooden Door Pull

Part	28/628	313/710 315/711	3/605 4/606	10/612 108/613	Stock PC 10BE	26/625 26D/626	32D/630	32/629	32DMS
208	230	230	227	227	245	219	208	215	239

Wood available in Oiled or Clear Finish. See page 34 for mounting details.

Tapered Door Pull

Part	28/628	313/710 315/711	3/605 4/606	10/612 108/613	Stock PC 10BE	26/625 26D/626	32D/630	32/629	32DMS
215	218	231	358	401	313	389	261	304	300
215L	290	306	646	706	534	684	445	527	512

Larger sizes available upon request. See page 34 for mounting details.

ASSA ABLOY

The global leader in
door opening solutions

Heavy Duty Offset Pulls

Heavy Duty Offset Pulls											
Part	28/628	313/710 315/711	3/605 4/606	10/612 10B/613	Stock PC 10BE	26/625 26D/626	32D/630	32/629	32DMS	32D316	32316
BF257	137	149	333	383	264	324	223	285	256	279	310
BF258	149	162	359	407	287	348	242	305	279	297	331
BF259	154	170	407	468	317	396	267	331	307	324	357
BF260	170	181	468	543	347	454	293	359	337	351	382

Supplied with 3/8" -16 Thru Bolts.

Vandal Resistant Trim

Vandal Resistant Trim			
Part	Stock PC 10BE	32D/630	32DMS
VRT12	261	240	261
VRT14	307	284	307
VRT16	261	240	261
VRT22		292	
VRT24		337	
VRT26		295	

Specify Exit Device make and model to thru bolt directly to device.

Vandal Resistant Pull

Vandal Resistant Pull		
Part	Stock PC 10BE	BPC/FBPC/RPC/WPC
VRP30	120	120

Set up charge for custom powder coat will apply. Specify Exit Device make and model to thru bolt directly to device.

Pull Plates

Pull Plates									
Part	28/628	3/605 4/606	10/612 10B/613	Stock PC 10BE	26/625 26D/626	32D/630	32/629	32DMS	32D316
102 x 70B		68	85	49	82	41	61	47	
102 x 70C		71	88	51	85	43	63	49	
105 x 70B	34	73	92	51	88	43	62	49	70
105 x 70C	35	80	95	54	92	45	64	53	72
106 x 70B	34	75	94	53	91	44	64	51	71
106 x 70C	35	82	97	55	94	46	66	54	73
107 x 70B	37	82	99	55	96	46	65	54	72
107 x 70C	37	85	103	58	99	48	67	56	75
110 x 70B	44	119	150	99	146	83	100	96	117
110 x 70C	44	125	153	100	149	84	102	97	119
111 x 70B	46	125	165	110	160	92	110	106	127
111 x 70C	46	129	169	112	163	95	113	108	127
122 x 70B	37	85	109	56	105	47		55	
122 x 70C	39	88	112	60	109	49		57	
123 x 70B	41			66		56		63	
123 x 70C	41			67		57		65	
125 x 70B	41	89	98	70	95	60		68	
125 x 70C	41	93	102	72	98	61		69	
126 x 70B	46	101	112	76	109	64		74	
126 x 70C	46	105	115	79	112	66		76	
132 x 70B	37	64	71	69	69	59		67	
132 x 70C	39	67	75	70	72	60		68	
137 x 70B		70	82	72	79	61		69	
137 x 70C		73	85	73	82	62		71	

Barrier Free - Available in 2 1/2" clearance add \$9 list (excludes 132 and 137).

ASSA ABLOY

The global leader in
door opening solutions

Prices Effective September 1, 2017

Copyright © 2017, Rockwood Manufacturing Company, an ASSA ABLOY Group company. All rights reserved. Reproduction in whole or in part without the express written permission of Rockwood Manufacturing Company is prohibited.

Decorative Pull Plates

Decorative Pull Plates				
Part	3/605 4/606	10/612 10B/613	Stock PC 10BE	26/625 26D/626
147 x 76B	115	120	134	116
147 x 76C	119	124	137	119
147 x 77B	115	120	134	116
147 x 77C	119	124	137	119
148 x 76B	150	155	173	150
148 x 76C	155	160	178	154
148 x 77B	150	155	173	150
148 x 77C	155	160	178	154

Tubular Pull Plates

Tubular Pull Plates						
Part	3/605 4/606	10/612 10B/613	Stock PC 10BE	32D/630	32/629	32DMS
T110 x 70B	129	139	92	77	98	89
T110 x 70C	134	143	94	79	100	91
T111 x 70B	137	144	94	79	102	91
T111 x 70C	140	148	99	83	104	95

Corner Guards

Corner Guards				
Part	Size	3/605 4/606	10/612 10B/613	32D/630
290	2" x 2" x 40"	121	132	71
	2" x 2" x 48"	135	148	76
	3" x 3" x 40"	154	170	82
	3" x 3" x 48"	175	193	90
291	2" x 2" x 40"	128	137	76
	2" x 2" x 48"	140	154	82
	3" x 3" x 40"	162	176	88
	3" x 3" x 48"	182	198	95

Corner Guards						
Part	Size	3/605 4/606	10/612 10B/613	Stock PC 10BE	32D/630	32DMS
295	2" x 2" x 40"	99	109	61	53	60
	2" x 2" x 48"	112	127	70	59	69
	3" x 3" x 40"	135	148	77	65	75
	3" x 3" x 48"	153	171	85	73	84
296	2" x 2" x 40"	108	115	70	59	69
	2" x 2" x 48"	118	135	77	65	75
	3" x 3" x 40"	140	154	83	71	82
	3" x 3" x 48"	161	179	93	80	91

Other lengths available up to 96" and leg widths up to 6". Part number 290 and 291 includes self-adhesive mounting.

Mortised Door Edges (UL Approved)

Mortised Door Edges							
Part	Height	3/605 4/606	10/612 10B/613	Stock PC 10BE	32D/630	32DMS	32D316
300	Up to 42"	92	97	60	52	59	72
	43" - 66"	139	152	92	78	90	108
	67" - 96"	205	219	130	111	128	157
301	Up to 42"	92	97	60	52	59	72
	43" - 66"	139	152	92	78	90	108
	67" - 96"	205	219	130	111	128	157
302	Up to 42"	103	110	72	61	71	77
	43" - 66"	152	165	108	92	106	121
	67" - 96"	224	238	153	131	151	175
302B	Up to 42"	103	110	72	61	71	77
	43" - 66"	152	165	108	92	106	121
	67" - 96"	224	238	153	131	151	175

Available in stainless steel, brass and bronze. UL Listed for fire rated doors. Add \$13 per edge - specify UL when ordering (300-UL). Includes Phillips Flat Head Sheet Metal Screw Fasteners. To defray set up costs, add 30% for less than 10 pieces. Add an additional \$12 for each cutout.

Non-Mortise Door Edges (UL Approved)

Non-Mortise Door Edges							
Part	Height	3/605 4/606	10/612 10B/613	Stock PC 10BE	32D/630	32DMS	32D316
304	Up to 42"	92	97	60	52	59	72
	43"- 66"	139	152	92	78	90	108
	67"- 96"	205	219	130	111	128	157
305	Up to 42"	92	97	60	52	59	72
	43"- 66"	139	152	92	78	90	108
	67"- 96"	205	219	130	111	128	157
306-RKW	Up to 42"	103	110	72	61	71	77
	43"- 66"	152	165	108	92	106	121
	67"- 96"	224	238	153	131	151	175
306-AST	Up to 96"			452	386	444	
306B	Up to 42"	103	110	72	61	71	77
	43"- 66"	152	165	108	92	106	121
	67"- 96"	224	238	153	131	151	175
306B-AST	Up to 96"			452	386	444	
307	Up to 42"	118	126	89	76	88	95
	43"- 66"	177	190	137	117	135	146
	67"- 96"	263	275	195	166	192	216

Available in stainless steel, brass and bronze. UL Listed for fire rated doors. Add \$13 per edge - specify UL when ordering (304-UL). Includes Phillips Flat Head Sheet Metal Screw Fasteners. To defray set up costs, add 30% for less than 10 pieces. Add an additional \$12 for each cutout.

Overlapping Door Edges (UL Approved)

Overlapping Door Edges							
Part	Height	3/605 4/606	10/612 10B/613	Stock PC 10BE	32D/630	32DMS	32D316
308	Up to 42"	103	110	72	61	71	80
309	Up to 42"	103	110	72	61	71	80
310	Up to 42"	115	122	85	73	84	93
310B	Up to 42"	115	122	85	73	84	93
310BS	Up to 42"	115	122	85	73	84	93

Available in stainless steel, brass and bronze. UL Listed for fire rated doors. Add \$13 per edge - specify UL when ordering (308-UL). Includes Phillips Flat Head Sheet Metal Screw Fasteners. To defray set up costs, add 30% for less than 10 pieces. Add an additional \$12 for each cutout.

Latch Protectors

Latch Protectors				
Part	2C/603	Stock PC 10BE	26D/626	32D/630
320-RKW	18	37		31
320C	18	37		31
320CL	18	37		31
320CXL		37		31
321	21	32		27
322	21	33		28
325		54	46	
330		50		44

ASSA ABLOY

The global leader in
door opening solutions

Stops

Solid Cast Wall Stops - DuraFlex Bumpers					
Part	3/605 4/606	10/612 10B/613	Stock PC 10BE	15/619	26/625 26D/626
400	14	15	16	14	14
401	14	15	16	14	14
402	14	15	16	14	14
403	14	15	16	14	14
404	14	15	16	14	14
405	14	15	16	14	14

Wrought Wall Stops - DuraFlex Bumpers					
Part	3/605 4/606	10/612 10BE/613E	26/625 26D/626	32D/630	
406	9	9	8	6	
409	9	9	8	6	

Solid Cast Wall Stops - DuraFlex Bumper					
Part	3/605 4/606	10/612 10B/613	Stock PC 10BE	15/619	26/625 26D/626
412			25	22	22
415	33	33	37	32	32
416			25	22	22

Wrought Wall Stops - DuraFlex Bumpers					
Part	3/605	Stock PC 10BE	32D/630		
426	9	8	6		

Solid Cast Wall Stop - DuraFlex Bumper					
Part	3/605 4/606	10/612 10B/613	Stock PC 10BE	26/625 26D/626	
430-RKW	11	11	12	10	

Wall Stops - DuraFlex Bumpers					
Part	Gray	White			
431-RKW	3				
432W		3			

Light Duty Dome Stops - DuraFlex Bumper					
Part		10B/613	Stock PC 10BE	26D/626	
438		9	8	6	
439		10	9	8	

Dome Stops					
Part	3/605 4/606	10/612 10B/613	Stock PC 10BE	15/619	26/625 26D/626
440	10	11	12	32	10
441	12	13	13	36	11
441CU	14	15	16		14
441H	14	15	16	56	14
442	11	12	14	44	12
443	13	13	14	48	12

Cast Riser (for 440 & 441 Dome Stops)					
Part	8	8	8		6
444	8	8	8		6

Heavy Duty Door Stop							
Part	3/605 4/606	10B/613	Stock PC 10BE	10/612	15/619	26D/626	26/625
445	26	29	18	29	29	15	29
445H	38	43	29	38	42	25	37

Door Stop							
Part	27	31	33	31	31	29	29
446	27	31	33	31	31	29	29

Riser (for 440 & 442 Dome Stops)							
Part	Mill	Painted					
449	9	9					

Curved Roller Stop - DuraFlex Bumper					
Part	3/605 4/606	10/612 10B/613	Stock PC 10BE	26/625 26D/626	
455	37	37	41	36	

Straight Roller Stop - DuraFlex Bumpers				
Part	3/605 4/606	10/612 10B/613	Stock PC 10BE	26/625 26D/626
456-RKW	37	37	41	36
456B Gray (replacement bumper)				4
456L	42	42	46	40

Kick Down Door Stop - DuraFlex Bumper				
Part	Polished Brass (BRS)	Dull Bronze (BRZ)	Bright Chrome (CRM)	
458	12	12	12	

Spring Loaded Plunger Stop - DuraFlex Bumper				
Part	3/605 4/606	10/612 10B/613 15/619	Stock PC 10BE	26/625 26D/626
459	42	45	50	43

Kick Down Door Stop - DuraFlex Bumper				
Part	ALM, BRS, BRZ, ORB			16
460	ALM, BRS, BRZ, ORB			16
461	32	32	30	31
461B Gray (replacement bumper)				3
461L	44	43	49	42

Heavy Duty Door Stops				
Part	2C/603	26D/626	32D/630	Black
462	31			
463-RKW			42	
464-RKW		80		
465		52		
466-RKW				24
467-RKW				31
468-RKW				77

Door Stops - DuraFlex Bumpers				
Part	3/605 4/606	10/612 10B/613	Stock PC 10BE	26/625 26D/626
470	31	33	37	32
471	31	33	37	32
472	44	46	51	44
473	44	46	51	44
474	31	33	37	32
475	31	33	37	32
476	44	46	51	44
477	44	46	51	44
480	31	33	37	32
480H	33	36	40	34
481	38	42	46	40
481H	42	44	49	42
481MP Powder Coat Finish				54
482	32	36	40	34
483	32	36	40	34
485	46	53	58	51

Angle Door Stop - DuraFlex Bumper				
Part	2C/603			
486	13			

Heavy Duty Wall Stop - DuraFlex Bumper				
Part	26D/626			
487	34			

Prices Effective September 1, 2017

Copyright © 2017, Rockwood Manufacturing Company, an ASSA ABLOY Group company. All rights reserved.
Reproduction in whole or in part without the express written permission of Rockwood Manufacturing Company is prohibited.

ASSA ABLOY

The global leader in
door opening solutions

Door Stops (con't)

Door Stops				
Part	3/605 4/606	10/612 10B/613	Stock PC 10BE	14/618 15/619
488	44	49	56	49
489	54	60	69	60
Door Holder & Stop				
Part	26D/626			
490	46			
Automatic Door Holder & Stop				
Part	3/605 4/606	10/612 10B/613	Stock PC 10BE	26/625 26D/626
491-RKW	72	79	87	75
491R	78	83	92	80
491S	84	88	98	85
494-RKW	81	86	96	83
494R	84	89	99	86
494S	89	96	106	92
Door Stops - DuraFlex Bumpers				
505-RKW	17	17	19	16
508	28	28	30	27
517 Polished Brass (BRS), Burnished Aluminum (ALM)				9
518	20	20	22	19
519	20	20	22	19
520 White (replacement bumper)				3
Part	Antique Brass (ANT)	Polished Brass (BRS)	Bright Nickel (NP)	
525	4	4	4	
526		5	5	
528	8	8	8	

Flush Bolts, Guides & Strikes

Flush Bolts, Guides & Strikes				
Part	3/605 4/606	10/612 10B/613	Stock PC 10BE	26/625 26D/626
550	40	42	45	40
550G	6	6	6	5
550S	6	6	6	5
554	45	45	48	43
554G	30	30	32	29
554S	30	30	32	29
555	29	31	35	27
555B (1 1/2" standard bolt head)		6		
555B (extra long bolt head - specify length)		19		
555G	5	5	5	4
555S	5	5	5	4
555ROD/per ft. (specify length)		7		
555 x 18BFB				130
556WS				79
557	42	48	52	46
557S	6	6	6	5
557 x 19BFB				144
570	23	24	26	24

ASSA ABLOY

The global leader in door opening solutions

Gravity Door Coordinator

Gravity Door Coordinators				
Part	3/605 4/606	10/612 10B/613	Stock PC 10BE	26/625 26D/626
576	92	99	107	93
576B Gray				5

Surface Bolts

Surface Bolts				
Part	3/605 10/612 10B/613 Painted	Stock PC 10BE	26D/626	32D/630
580-8	35	43	38	63
580-12	45	46	42	
580-18	123	138	123	
580-24	132	148	132	
582-8				99
582-12				123
Heavy Duty Surface Bolts				
585-12			133	
585-24			165	

Roller Latches

Roller Latches				
Part	3/605 4/606	10/612 10B/613	Stock PC 10BE	26/625 26D/626
590	47	50	53	47
590DA (Strike Only)	83	83	83	83
590SO	16	16	17	15
591	53	57	60	54
591SO	19	19	19	17
592	47	50	53	47
592SO	16	16	17	15
593	87	94	100	89
593SO	16	16	17	15
594	53	57	60	54
594SO	16	16	17	15

Hospital Push/Pull Latches

Hospital Push/Pull Latches			
Part	Stock PC 10BE	32D/630	32DMS
596	273	244	277
596L	303	275	306
596S	273	244	277
596BS2		66	
596BS5		68	
596BS7		103	
Engraving (set)		60	
Lead Lining		84	
Latchbolt Only		60	
596STRK2 (Strike Only)		28	
596STRK5 (Strike Only)		28	

Gate Latch

Gate Latch				
Part	4/606	10/612 10B/613	Stock PC 10BE	26D/626
602	42	42	44	40
602 Spring (25 pk)				12

Prices Effective September 1, 2017

Copyright © 2017, Rockwood Manufacturing Company, an ASSA ABLOY Group company. All rights reserved. Reproduction in whole or in part without the express written permission of Rockwood Manufacturing Company is prohibited.

Door Guards

Door Guards				
Part	Antique Brass (ANT)	Polished Brass (BRS)	Bright Chrome (CRM)	
603	12	12	12	
603 Shim	Clear Plastic			6
Part	3/605 4/606	10/612 10B/613	26/625 26D/626	
604	30	30	29	
604 Shim	Clear Plastic			6

Door Guard Protection Plate

Door Guard Protection Plate				
Part	3/605 4/606	5/609	10/612 10B/613	26/625 26D/626
605	11	11	12	11
605SMS	11	10	12	11

Wall Guard

Wall Guard		
Part	Pack Size	Clear
606-RKW	55/sheet	62

Privacy Door Latch

Privacy Door Latch			
Part	BRS/DBRS	ORB	CRM, DCRM, STNN
PDL (607)	49	49	46

Door Silencers

Door Silencers			
Part	Pack Size	Clear	Gray Rubber
608-RKW	100		16
608CA	300	109	
609	100		16

Door Knockers

Door Knockers				
Part	3/605 4/606	10/612 10B/613	Stock PC 10BE	26/625 26D/626
611	68	68	73	66
614	36	39	42	37
614V	46	48	51	46

Door Viewers

Door Viewers				
Part	Antique Bronze (ANT)	Polished Brass (BRS)	Bright Chrome (CRM)	Satin Nickel (STNN)
619	13	13	13	13
620	11	11	11	
621	12	12	12	
622	13	13	13	14

Door Viewer Washers

Door Viewer Washers		
Part	Stainless Steel (SS)	Polished Brass (BRS)
619W 1/2" Hole	7	7
626W 9/16" Hole	7	7

Door Viewers with Covers

Door Viewers with Covers					
Part	Pack Size	Antique Bronze (ANT)	Polished Brass (BRS)	Bright Chrome (CRM)	Dull Chrome (DCRM)
620VC	10	80	80	80	
622VC	10	90	90	80	
624		14	14	14	
626		18	11	18	15
627				22	
628				20	
629				23	

Surface Bolts

Surface Bolts				
Part	3/605	10B/613	Stock PC 10BE	26D/626
630-4	34	38	42	37
630-8	61	67	66	59
630-12	93	103	111	99
630-24	175	193	209	188

Residential Flush Bolts

Residential Flush Bolts			
Part	3/605	5/609	26D/626
640	12	12	11
640RE	12	12	11

Card Holder

Card Holder				
Part	3/605 4/606	10/612 10B/613	Stock PC 10BE	26D/626
651	18	18	19	17

Decals

Decals	
Part	Price
660	10
661	10
662-RKW	10

670 Series Engraved Signs

670 Series Engraved								
Part	Black or Brown Plastic	28/628	3/605 4/606	10/612	10B/613	Stock PC 10BE	26/625 26D/626	32D/630
670 (1"H Letters or smaller)	9	15	17	18	17	18	16	15
670 (Over 1" up to 3")	13	20	21	21	21	25	20	22
670M	18	32	36	36	41	44	35	39
670W	20	44	49	50	51	61	46	53
670R	22	64	68	67	70	89	66	78
674H (PUSH)	21	27	38	39	44	46	37	41
674L (PULL)	21	27	38	39	44	46	37	41

Available in .125" thick plastic or .050" thick metal. Pricing is per letter for Part 670—minimum of 3 letters; per sign for Part's 670M, 670W, 670R. Call for pricing on multi-line signs.

BF680 Series Barrier Free Signs

BF680 Series Barrier Free								
Part	Black, Blue, Brown or Red Plastic	28/628	3/605 4/606	10/612	10BL/614	Stock PC 10BE	26/625 26D/626	32D/630
BF680	14	28	27	26	29	36	26	32
BF680M	31	71	67	66	69	92	64	79
BF680W	44	103	98	98	103	141	94	123
BF680R	62	150	142	142	151	218	138	190

Standard 1" letter height. Grade 2 Braille translations. Available in .125" non-glare plastic or .050" thick metal. Pricing is per letter for Part BF680—minimum of 3 letters per sign for Part's BF680M, BF680W, BF680R. Screw mounting provided. Self-adhesive mounting available.

BF Series ADA Tactile Signs

BF Series ADA Tactile							
Part	Black, Blue, Brown or Red Plastic	28/628	3/605 4/606	10/612 10BL/614	Stock PC 10BE	26/625 26D/626	32D/630
BF683	54	174	164	164	176	158	154
BF684	54	174	164	164	176	158	154
BF685	54	174	164	164	176	158	154
BF686	64	200	190	190	206	184	179
BF687	57	187	177	177	191	171	166
BF688	57	187	177	177	191	171	166
BF689	64	200	190	190	206	184	179

Standard 1" letter height. Grade 2 Braille translations. Available in .125" non-glare plastic or .050" thick metal. Screw mounting provided. Self-adhesive mounting available.

BFM Series ADA Molded Plastic Signs

BFM Series ADA Molded Plastic		
Part	Black	Blue
BFM682	22	22
BFM684	22	22
BFM685	22	22
BFM686	22	22
BFM687	22	22
BFM688	22	22
BFM689	22	22

Standard 5/8" letter height. Grade 2 Braille translations. Self-adhesive mounting.

ASSA ABLOY

The global leader in
door opening solutions

Prices Effective September 1, 2017

Copyright © 2017, Rockwood Manufacturing Company, an ASSA ABLOY Group company. All rights reserved.
Reproduction in whole or in part without the express written permission of Rockwood Manufacturing Company is prohibited.

Auxiliary Hardware

Hand Rail Brackets - Specify Wood or Metal Rail						
Part	3/605	4/606	10/612 10B/613	Stock PC 10BE	26D/626	
700	65	74	74	77	72	
701	61	70	70	73	67	
702	57	65	65	67	63	
Coat Hooks						
Part	3/605	4/606 10/612 10B/613 26/625	Stock PC 10BE	15/619	15A/620	26D/626
790	12	16	14	16	19	12
796	13	17	14	17	19	12
802	13	20	15	19	20	13
806	15	21	16	20	21	14
Ball Knob						
Part	3/605 26/625	4/606 10/612 10B/613	Stock PC 10BE	15/619	15A/620	26D/626
841	12	16	13	16	17	11
Utility Pull						
Part	3/605	4/606	10/612 10B/613	Stock PC 10BE	26/625 26D/626	Burnished Aluminum
845	28	28	32	34	31	10
Wire Pulls - Specify Door Thickness						
Part	3/605 4/606	10/612 10B/613	Stock PC 10BE	26/625 26D/626	32D/630	32DMS
850	25	27	26	24		
851	25	27	26	24		
852	25	27	26	24		
853	25	27	23	24	21	25
856-RKW	28	29	31	27		
Flush Pulls						
Part	3/605	10B/613	Stock PC 10BE	26D/626	32D/630	
860	8	9	9		8	
870	6	7	6		5	
872	20	23	21	19		
Edge Pulls						
880	18	19		18		
885-RKW	43	48	50	46		
Pocket Door Pulls - For use on 1 3/8" to 1 3/4" Doors						
Part	3/605	10B/613	26/625	26D/626		
890	18	20	17	17		
891	19	21	18	18		
Magnetic Catches						
Part	Brass	Aluminum				
900	11	11				
901	13	13				
Adjustable Ball Catches						
Part	3/605	26D/626				
910	11	10				
910RC	11	10				
911	12	11				
911RC	12	11				

Coordinators

Carry Bar for 2600 Series Coordinators				
Part	Black Prime Coated	3/605 4/606	10/612 10B/613	26/625 26D/626
1100	36	65	65	63
Mounting Brackets (For Soffit Applied Hardware)				
Part	Black Prime Coated	28/689		
2601AB	29	40		
2601C	29	40		
2600 Series Coordinators w/Filler and Filler Bars				
NX2648- NX2654	133	147		
2655-2660	145	158		
2661-2672	145	158		
2673-2696	162	204		
L2662- L26112	169	211		
FB-1	26	31		
FB-2	29	37		
1700 Universal Door Coordinator				
1700	106	117		

Flush Bolts

Flush Bolts					
Part	3/605 4/606 10/612 10B/613	Stock PC 10BE	26/625	26D/626	32D/630
2805	99	107	99	96	96
2840	99	107	99	96	96
2842	194	209	194	159	187
2845	194	209	194	187	187
2848	194	209	194	187	187
2849	194	209	194	187	187
2905	103	112	103	100	100
2940	103	112	103	100	100
2942	205	222	205	199	170
2945	205	222	205	199	199
2948	194	209	194	187	187
2949	194	209	194	187	187
2960	242	262	242	235	235
2962	242	262	242	235	235
BFB (wood or metal door)					99
CPK2840	19	20	19	18	18

Overhead Holders & Stops

Heavy Duty Concealed - Stop Only		
Part	10B/613	32D/630
OH101S	347	320
OH102S	347	320
OH103S	347	320
OH104S	347	320
OH105S	347	320
OH101H	347	320
OH102H	347	320
OH103H	347	320
OH104H	347	320
OH105H	347	320
Standard Duty Concealed - Multi-function		
OH201M	196	146
OH202M	196	146
OH203M	196	146
OH204M	196	146
OH205M	196	146
Heavy Duty Surface Mounted - Stop Only		
OH901S	329	285
OH902S	329	285
OH903S	329	285
OH904S	329	285
OH905S	329	285
OH901H	329	285
OH902H	329	285
OH903H	329	285
OH904H	329	285
OH905H	329	285
Standard Duty Surface Mounted - Multi-function		
OH1001M	233	158
OH1002M	233	158
OH1003M	233	158
OH1004M	233	158
OH1005M	233	158
Overhead Stops with Aluminum Channel (Coming Soon!)		
Part	Brushed Aluminum	
OH103S-ALM	*	
OH203S-ALM	*	
OH903S-ALM	*	
OH1003S-ALM	*	

*Prices available upon launch.

Covers

Latch Guard Covers - .062" Thick (Specify Handing)					
Part	3/605	10/612	10B/613	Stock PC 10BE	32D/630
BFLG10	227	227	227	116	106
BFLG12	244	244	244	122	110
BFLG16	274	274	274	135	123
Vertical Rod Covers - .050" Thick					
BFRC12	60	64	64	44	40
BFRC24	96	102	102	63	56

ASSA ABLOY

The global leader in door opening solutions

Prices Effective September 1, 2017

Copyright © 2017, Rockwood Manufacturing Company, an ASSA ABLOY Group company. All rights reserved. Reproduction in whole or in part without the express written permission of Rockwood Manufacturing Company is prohibited.

Pivots

Standard Head				
Part	3/605 4/606	10/612 10B/613	Stock PC 10BE	26/625 26D/626
CP10	250	274	285	265
CP10HD	364	387	404	376
Standard Head Pivot				
CP20	250	274	285	265
CP20HD	364	387	404	376
Standard Floor				
CP40	250	274	285	265
CP40HD	364	387	404	376
Standard Floor Pivot				
CP50	250	274	285	265
CP50HD	364	387	404	376

Prices are for 1 3/4" thick wood doors. Pivots for thicker doors are priced on application. Allow 4 weeks delivery. NOTE: Pivots are 3/8" x 7/8" wide; HD (heavy duty) pivots are 1/2" x 1" wide.

Custom Strikes

Custom Strikes						
Part	Quantity	3/605 4/606 10/612 10B/613	Stock PC 10BE	26/625 26D/626	32D/630	32/629
CS-ASA1, CS-ASA2, CS-OM, CS-T, 590-DA	Up to 5	62	61	66	54	65
	6 to 10	58	60	61	53	61
	11 to 20	53	54	57	48	56
	21 +	51	52	53	46	53

.090" Thick (\$94.50 minimum charge. Made to your specifications.)

Filler Plates & Shims

Filler Plates & Shims		
Part	Pack Size	Price
DF86	25	150
DFF4	25	100
DFF5	25	125
DHF4B	25	125
DHF4S	25	125
DHF5B	25	125
DHF5S	25	125
FBF48	25	125
FBS48	25	100
FC161	25	125
FD160	25	125
HS42	50	150
HS44	50	150
HS52	50	150

Sold in pack quantities only.

Part	Pack Size	Price
HS54	50	150
LA86	25	300
LF161	25	100
SFASA	25	100
SF160	25	100
SFB160	25	125

Angle Plates

Angle Plates		
Part	Description	Pricing
KB1150 Style A	One-Sided	Fax or Email Dimensions for Pricing
KB1151 Style C	Two-Sided	Fax or Email Dimensions for Pricing
KB1152 Style B	Bottom	Fax or Email Dimensions for Pricing

.050" Thick - Refer to page 41 for Angle Plate Fasteners. Add \$35 list per bend to plates price.

Trim Protector Bars

Heavy Duty - 3/8" thick stainless for heavy traffic. 5/8" in over 8" CTC.					
Part	CTC	Stock PC 10BE	32D/630	32DMS	
HD2230	8"	112	103	112	
HD2240	8"	112	103	112	
HD2250	8"	112	103	112	
Lever - 3/8" thick for heavy traffic. 5/8" in over standard CTC.					
Part	3/605	10/612 10B/613	Stock PC 10BE	32D/630	32DMS
R101LPB	190	218	138	128	138
R102LPB	231	285	179	166	179
R111LPB	204	243	152	140	152
R112LPB	243	298	206	190	206
R115LPB	218	257	165	152	165
Exit Device - 3/8" thick stainless for heavy traffic. Field cutting hinge end of exit device is required.					
R116EDPL			317	292	317
R116EDPH			317	292	317
Standard Duty - 3/16" thick stainless for moderate traffic.					
SD1230			56	52	56
SD1240			56	52	56
SD1250			56	52	56
SD1260			56	52	56

Door Plates Hundred Square Inch Size Chart

To calculate the list price of kick plate, use the hundred square inch number times the list price. Use the next higher even number for odd or fractional sizes. (Example: 9" x 33 1/2" — price as 10" x 34" which is 3.40 square inches.) Take that number times the list price from the following page. (Example: 32D list \$19 x 3.40 = \$64.60)

H/W	24"	26"	28"	30"	32"	34"	36"	38"	40"	42"	44"	46"	48"
4"	0.96	1.04	1.12	1.20	1.28	1.36	1.44	1.52	1.60	1.68	1.76	1.84	1.92
6"	1.44	1.56	1.68	1.80	1.92	2.04	2.16	2.28	2.40	2.52	2.64	2.76	2.88
8"	1.92	2.08	2.24	2.40	2.56	2.72	2.88	3.04	3.20	3.36	3.52	3.68	3.84
10"	2.40	2.60	2.80	3.00	3.20	3.40	3.60	3.80	4.00	4.20	4.40	4.60	4.80
12"	2.88	3.12	3.36	3.60	3.84	4.08	4.32	4.56	4.80	5.04	5.28	5.52	5.76
14"	3.36	3.64	3.92	4.20	4.48	4.76	5.04	5.32	5.60	5.88	6.16	6.44	6.72
16"	3.84	4.16	4.48	4.80	5.12	5.44	5.76	6.08	6.40	6.72	7.04	7.36	7.68
18"	4.32	4.68	5.04	5.40	5.76	6.12	6.48	6.84	7.20	7.56	7.92	8.28	8.64
20"	4.80	5.20	5.60	6.00	6.40	6.80	7.20	7.60	8.00	8.40	8.80	9.20	9.60
22"	5.28	5.72	6.16	6.60	7.04	7.48	7.92	8.36	8.80	9.24	9.68	10.12	10.56
24"	5.76	6.24	6.72	7.20	7.68	8.16	8.64	9.12	9.60	10.08	10.56	11.04	11.52
26"	6.24	6.76	7.28	7.80	8.32	8.84	9.36	9.88	10.40	10.92	11.44	11.96	12.48
28"	6.72	7.28	7.84	8.40	8.96	9.52	10.08	10.64	11.20	11.76	12.32	12.88	13.44
30"	7.20	7.80	8.40	9.00	9.60	10.20	10.80	11.40	12.00	12.60	13.20	13.80	14.40
32"	7.68	8.32	8.96	9.60	10.24	10.88	11.52	12.16	12.80	13.44	14.08	14.72	15.36
34"	8.16	8.84	9.52	10.20	10.88	11.56	12.24	12.92	13.60	14.28	14.96	15.64	16.32
36"	8.64	9.36	10.08	10.80	11.52	12.24	12.96	13.68	14.40	15.12	15.84	16.56	17.28
38"	9.12	9.88	10.64	11.40	12.16	12.92	13.68	14.44	15.20	15.96	16.72	17.48	18.24
40"	9.60	10.40	11.20	12.00	12.80	13.60	14.40	15.20	16.00	16.80	17.60	18.40	19.20
42"	10.08	10.92	11.76	12.60	13.44	14.28	15.12	15.96	16.80	17.64	18.48	19.32	20.16
44"	10.56	11.44	12.32	13.20	14.08	14.96	15.84	16.72	17.60	18.48	19.36	20.24	21.12
46"	11.04	11.96	12.88	13.80	14.72	15.64	16.56	17.48	18.40	19.32	20.24	21.16	22.08
48"	11.52	12.48	13.44	14.40	15.36	16.32	17.28	18.24	19.20	20.16	21.12	22.08	23.04

Options

Option	Add	12"H or Less	Over 12" - 48"H
BEV	Beveled Edges	6	10
HVBEV	Heavy Beveled Edges	7	12
CSK	Countersunk Holes	7	12
SA	Self-Adhesive Mount	17	36
CFC	CFC	40	
	Cut for Louver	124	
	Notch for Armor	57	
	Add Row of Screws	18	
	UL & WH Listing	18	
	TEK (SS)	42/c	
	TEK (Brass)	78/c	
	TORX	72/c	

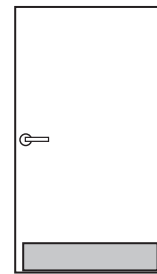

Mop Plate
Up to 8"H x 48"W

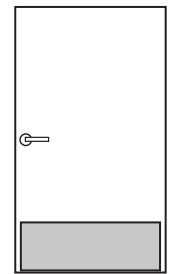

Kick Plate
6" to 12"H x 48"W

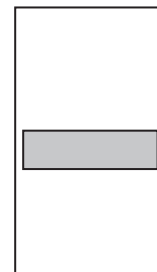

Stretcher Plate
6" to 12"H and up to 48"W

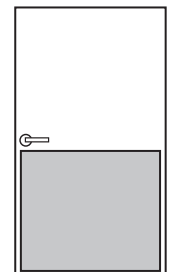

Armor Plate
Up to 48"H x 48"W

Screw Quantity Chart

Height/Length	17" - 24"	25" - 32"	33" - 40"	41" - 48"
4" - 12"	8 pcs.	10 pcs.	12 pcs.	14 pcs.
13" - 18"	10 pcs.	12 pcs.	14 pcs.	16 pcs.
19" - 24"	12 pcs.	14 pcs.	16 pcs.	18 pcs.
25" - 32"	16 pcs.	18 pcs.	20 pcs.	22 pcs.
33" - 40"	18 pcs.	20 pcs.	22 pcs.	24 pcs.
40" - 48"	20 pcs.	22 pcs.	24 pcs.	26 pcs.

ASSA ABLOY

The global leader in
door opening solutions

Prices Effective September 1, 2017

Copyright © 2017, Rockwood Manufacturing Company, an ASSA ABLOY Group company. All rights reserved. Reproduction in whole or in part without the express written permission of Rockwood Manufacturing Company is prohibited.

Door Plates

K1038 Economy Duty Metal Door Plates - .038" Thick										
Height	32D/630									
Up to 16"	16									
> 16" up to 48"	16									
K1050 & K1050F Custom Size Metal Plates - .050" Thick (UL Listed)										
See page 30 for other available options. For fire rated openings order K1050F and add \$15.75 per plate (maximum size 54"H x 46 1/2"W). K1050F screw mounted plates are UL approved for steel fire doors and frames rated up to and including 3 hours; wood composite type fire doors rated up to 1 1/2 hours.										
Height	28/628	3/605 4/606	9/611	10/612 10B/613	Stock PC 10BE	26/625 26D/626	32D/630	32/629	32DMS	32D316
4", 6", 8", 10", 12"	11	40	60	49	23	52	19	33	27	48
Special Height <12"	14	46	61	52	27	52	24	34	27	48
12.1" ≤ 36"	12	46	71	56	25		21	32	25	45
36.1" ≤ 48"	12	52	80	63	25		21	32	25	45

NOTE: Door Plate list pricing below is per Hundred Square Inches. Refer to "Hundred Square Inch Size Chart" on page 30 to calculate the list price of each door plate and other available options. See page 41 for special kick plate fasteners.



K1050-1 - K1050-8 & K1050A-1 - K1050A-8 (.050" Thick) Shaped Metal Plates Add-On Chart

Add unit price below to list price for kick plate from above chart. Prices are based on same size and same shape.			
Pieces	Up to 16"H 32D/630	>16" - 36"H 32D/630	>36" - 48"H 32D/630
1 - 10 Pieces	77	88	93
11 - 20 Pieces	57	68	74
21+ Pieces	50	61	67

To calculate Shapes™ metal plate price use the largest height x width dimension of the size required to make your design. Refer to "Hundred Square Inch Size Chart" on page 30 and the list price for 32D K1050 kick plates above. Then add the per plate charge using the appropriate row and column from the Shaped Metal Plates Add-On Chart on the left. See calculation example below.

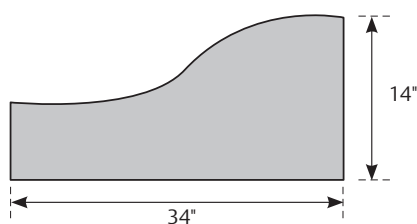

Example: 14" x 34" Per Plate Price Calculation:
 4.76 (Plate size from page 30) \times 521 (K1050 List Price above) $+$ 577 (Shapes™ Add On Price) = 5176.96 each.

Door Plates

K1062 Heavy Duty Metal Plates - .062" Thick							
Height	Stock PC 10BE	32D/630	32DMS				
Up to 24"	30	27	30				
>24" up to 36"	30	27	30				
>36" up to 48"		27	30				
K1125 Extra Heavy Duty Metal Plates - .125" Thick							
Height	28/628	3/605 4/606	9/611	10/612 10B/613	Stock PC 10BE	32D/630	ALM DIA
Up to 48"	37	130	149	140	75	68	38
K2060 Heavy Duty Plastic Plates - .060" Thick							
Part	Beige #72005	Calcutta Black #52000	Chocolate Brown #72010	Pewter Gray #52001			
K2060 Up to 48"	14	14	14	14			
K2060SA Up to 48"	19	19	19	19			
K2060SA-F	UL approved for use on 90-minute wood doors and 3-hour metal doors; order K2060SA-F. Add \$15 additional per plate. Maximum size for UL label is 48"H x 42"W.						
K2125 Extra Heavy Duty Plastic Plates - .125" Thick							
Part	Beige #72005	Calcutta Black #52000	Chocolate Brown #72010	Pewter Gray #52001			
Up to 48"	21	21	21	21			
K3125 Laminate Plastic Plates - .125" Thick							
Height	Beige	Black	Brown	Pewter Gray	White		
Up to 48"	12	12	12	12	12		
K4125 Clear Plastic Plates - .125" Thick							
Height	Clear						
Up to 48"	12						

ASSA ABLOYThe global leader in
door opening solutions

Prices Effective September 1, 2017

Copyright © 2017, Rockwood Manufacturing Company, an ASSA ABLOY Group company. All rights reserved.
Reproduction in whole or in part without the express written permission of Rockwood Manufacturing Company is prohibited.

Architectural Finishes

Most of Rockwood's products are available in all of the following architectural finishes. The catalog indicates exceptions. This finish list is grouped by base metal.

Base Metal	Description	Price Book Code	Rockwood Code	BHMA Code
Aluminum	Satin	27	US27	627
Aluminum	Clear Anodized	28	US28	628
Aluminum	Light Bronze Anodized	311	311	—
Aluminum	Medium Bronze Anodized	312	312	—
Aluminum	Dark Bronze Anodized	313	313	710
Aluminum	Extra Dark Bronze Anodized	314	314	—
Aluminum	Black Anodized	315	315	711
Aluminum	White Powder Coat	WPC	WPC	—
Aluminum	Red Powder Coat	RPC	RPC	—
Aluminum	Black Powder Coat	BPC	BPC	—
Brass	Polished Clear Coated	3	US3	605
Brass	Polished No Coating	3NL	US3NL	—
Brass	Satin Clear Coated	4	US4	606
Brass	Satin Oxidized Relieved	5	US5	609
Brass	Satin Nickel Plated Clear Coated	15	US15	619
Brass	Satin Nickel Blackened Relieved Clear Coated	15A	US15A	620
Brass	Flat Black Powder Coated	19	US19	622
Brass	Polished Chrome Plated	26	US26	625
Brass	Satin Chrome Plated	26D	US26D	626
Bronze*	Polished Clear Coated	9	US9	611
Bronze*	Satin Clear Coated	10	US10	612
Bronze*	Satin Black Oxidized Oil Rubbed	10A	US10A	—
Bronze*	Satin Oxidized Oil Rubbed	10B	US10B	613
Bronze*	Satin Oxidized Clear Coated	10BL	US10BL	614
Bronze*	Dark Oxidized Statuary Clear Coated	20A	US20A	624
Stainless Steel	Polished	32	US32	629
Stainless Steel	Satin	32D	US32D	630
Special Finishes (see descriptions)				
Stainless Steel	Satin MicroShield® Coated	32DMS***	US32DMS***	—
Stainless Steel	Polished 316 Alloy	32316***	US32316***	—
Stainless Steel	Satin 316 Alloy	32D316***	US32D316***	—
	Dark Oxidized Satin Bronze, Equivalent	10BE	US10BE	(613E)
	Black Suede Powder Coat	BSP	BSP	—

Special Finishes Description

32DMS (MicroShield®): As part of its promise to provide innovative solutions to their customers, ASSA ABLOY Group companies offer the MicroShield® technology, a silver-based antimicrobial coating designed to inhibit the spread of germs and bacteria.

32316 and 32D316 are made from alloy 316 stainless steel containing molybdenum and extra nickel giving it substantially higher corrosion resistance than the standard stainless steels typically used in door hardware. This finish is ideal for use in coastal, urban, and industrial areas that have harsh environmental conditions. **32316 (polish)** finishes offer the best corrosion resistance and should be used in caustic environments.

10BE Dark Oxidized Satin Bronze equivalent: This finish provides the richness and warmth of the 10B/613 "living" finish, but maintains its original color and appearance and will not fade or wear over time. The 10BE finish is offered by Corbin Russwin, McKinney, Norton, Rixson, Rockwood, SARGENT and Yale, providing visual consistency between ASSA ABLOY Group brands.

* On most bronze finishes we will supply solid bronze material. Where solid bronze material is not available, we will use brass as a base material with a bronze look powder coat in its place.

*** Available on select items as indicated by the finish icon throughout the catalog.



MicroShield® is a registered trademark of Yale Security Inc., an ASSA ABLOY Group company.

ASSA ABLOY

The global leader in door opening solutions

Set Mounting Charges

Mounting Spec #	Door Type	Pull Type	Mounting Type			Add On
			Pull Free End	Push Free End	Common End	
T1	Metal & Wood	Straight or Offset	12	12	5	24
T1HD	Metal & Wood	Straight or Offset	12HD	12HD	5HD	31
T2	Glass	Straight or Offset	15	15	13	29
T2HD	Glass	Straight or Offset	15HD	15HD	13HD	36
T3*	Metal & Wood	Straight or Offset	1	1	5	Included
T3HD	Metal & Wood	Straight or Offset	1HD	1HD	5HD	17
T4	Metal	Straight	6	6	5	12
T4HD	Metal	Straight	6HD	6HD	5HD	27
T4	Metal	Offset	17	17	16	21
T4HD	Metal	Offset	17HD	17HD	16HD	29
T5	Wood	Straight or Offset	8	8	5	21

*T3 is the standard mounting method for Metal and Wood Doors.
NOTE: Heavy Duty (HD) mounting features hex drive for positive tightening and large overall size for superior strength. Recommended for high frequency and rough service openings.

Mounting Types

Pull Style	PULL ON ONE SIDE OF DOOR								PULL ON BOTH SIDES OF DOOR (BTB)				
	Thru Bolt	Deco Thru Bolt		Concealed					Conehead/Set Screw				Lug Plate
Door Type	Wood/Metal	Glass	Metal	Metal	Wood	Wood	Wood	Wood	Wood/Metal	Glass		Any	
Coneheads	NA	NA	NA	Single	Single	Single	Double	Double	Single	Double	Single	Double	Single
Mounting Type	Type 1	Type 12	Type 15	Type 6	Type 6R	Type 8	Type 17	Type 17R	Type 5	Type 16	Type 13	Type 18	Type 9
Standard (STD) Bolt Size	1/4"-20	1/4"-20	1/4"-20	1/4"-20	1/4"-20	1/4"-20	1/4"-20	1/4"-20	1/4"-20	1/4"-20	1/4"-20	1/4"-20	1/4"-20
Price	INCL	24.00	26.00	10.00	12.00	10.00	14.00	16.00	10.00	14.00	17.00	20.00	25.00
Heavy Duty (HD) Bolt Size	5/16"-18	5/16"-18	5/16"-18	5/16"-18	5/16"-18	5/16"-18	5/16"-18	5/16"-18	5/16"-18	5/16"-18	5/16"-18	5/16"-18	
Price	5.00	29.00	31.00	14.00	17.00	14.00	18.00	20.00	14.00	18.00	21.00	25.00	
Extra Heavy Duty (XHD) Bolt Size	3/8"-16	3/8"-16	3/8"-16										
Price	10.00	29.00	31.00										

Straight Pulls

Pull Type	Dia.	MAXIMUM BOLT SIZE ALLOWED								MAXIMUM BOLT SIZE ALLOWED				
		Type 1	Type 12	Type 15	Type 6	Type 6R	Type 8	Type 17	Type 17R	Type 5	Type 16	Type 13	Type 18	Type 9
Straight	1/2"	STD	STD	STD			STD					STD		
Straight	5/8"	HD	HD	HD	HD		HD					HD		HD
Straight	1"	HD	HD	HD	HD	HD	HD					HD		STD
Straight	1 1/4"	HD	HD	HD	HD	HD	HD					HD		STD
Straight	1 1/2"	HD	HD	HD	HD	HD	HD					HD		STD

Offset Pulls

Pull Type	Dia.	MAXIMUM BOLT SIZE ALLOWED								MAXIMUM BOLT SIZE ALLOWED				
		Type 1	Type 12	Type 15	Type 6	Type 6R	Type 8	Type 17	Type 17R	Type 5	Type 16	Type 13	Type 18	Type 9
Offset	1/2"	STD	STD	STD								STD		
Offset	5/8"	HD	HD	HD								STD		
Offset	1"	XHD	XHD	XHD				HD	STD		HD	HD		
Offset	1 1/4"	XHD	XHD	XHD				HD	STD		HD	HD		
Offset	1 1/2"	XHD	XHD	XHD				HD	STD		HD	HD		

ASSA ABLOY

The global leader in door opening solutions

Prices Effective September 1, 2017

Copyright © 2017, Rockwood Manufacturing Company, an ASSA ABLOY Group company. All rights reserved. Reproduction in whole or in part without the express written permission of Rockwood Manufacturing Company is prohibited.

NOTE: Heavy Duty (HD) mounting features hex drive for positive tightening and large overall size for superior strength. Recommended for high frequency and rough service openings.

Free End Thru Bolt

TYPE 1 - Thru Bolt Wood or Metal Door

Labels: Pull, Finish Washer, Flat Head Machine Screw, Outside, Inside

Type	Bolt Size	Drill Size	Price
1	1/4"-20	9/32	Incl.
1HD	5/16"-18	11/32	5.00
1XHD	3/8"-16	13/32	10.00

TYPE 12 - Decorative Thru Bolt Wood or Metal Door

Labels: Pull, Thru Bolt

Type	Bolt Size	Drill Size	Price
12	1/4"-20	9/32	24.00
12HD	5/16"-18	11/32	29.00
12XHD	3/8"-16	13/32	29.00

TYPE 15 - Decorative Thru Bolt Glass Door

Labels: Plastic Washers, Pull, Thru Bolt, Neoprene Bushing 5/8" Dia. Hole

Type	Bolt Size	Drill Size	Price
15	1/4"-20	5/8	26.00
15HD	5/16"-18	5/8	31.00
15XHD	3/8"-16	5/8	31.00

TYPE 6 - Surface Concealed Metal Door

Minimum diameter of pull is 5/8"

Labels: Cone Head Machine Screw, Pull, Set Screw, Reinforcement by others

For doors with rivnuts specify Type 6R

Type	Bolt Size	Drill Size	Price
6	1/4"-20	1/4"-20 Tap	10.00
*6HD	5/16"-18	5/16"-18 Tap	14.00

TYPE 6R - Surface Concealed Metal Door

Minimum diameter of pull is 1"

Labels: Cone Head Machine Screw, Pull, Set Screw, Rivnut

Type	Bolt Size	Drill Size	Price
6	1/4"-20	N/A	12.00
*6HD	5/16"-18	N/A	17.00

TYPE 8 - Surface Concealed Wood Door

Labels: Cone Head Machine Screw, Pull, Set Screw, Knife Thread Insert, 1/4"-20 Set Screw

Type	Bolt Size	Drill Size	Price
8	1/4"-20	23/64-9/16 dp.	10.00
*8HD	5/16"-18	7/16-9/16 dp.	14.00

Free End Concealed

TYPE 17 - Surface Concealed Metal Door

Minimum diameter of pull is 1"

Labels: Cone Head Machine Screw, Pull, Set Screws, Reinforcement by others

Type	Bolt Size	Drill Size	Price
17	1/4"-20	1/4"-20 Tap	14.00
17HD	5/16"-18	5/16"-18 Tap	18.00

TYPE 17R - Surface Concealed Metal Door

Minimum diameter of pull is 1"

Labels: Cone Head Machine Screw, Pull, Set Screws, Rivnut

Type	Bolt Size	Drill Size	Price
17R	1/4"-20	N/A	16.00
17RHD	5/16"-18	N/A	20.00

*HD mountings feature 2 set screws 180° apart.

ASSA ABLOY

The global leader in door opening solutions

NOTE: Y base plates are recommended on wood or glass doors to make a stable and durable mounting (see page 40 for details).
NOTE: Heavy Duty (HD) mounting features hex drive for positive tightening and large overall size for superior strength.
Recommended for high frequency and rough service openings.

Flush Pull Mounting

Type 10 Mounting applies to the 94 Series Flush Pulls

TYPE 10 - Surface Mounted Wood or Metal Door

Type	Bolt Size	Drill Size	Price
10	#8-32	9/32	14.00

Wire or Small Post Mount Pull Mounting

NOTE: This mounting should only be used on pulls with mounting points that are 1/2" in diameter.

TYPE 55 - Back-to-Back Wood or Metal Door

Type	Bolt Size	Drill Size	Price
55	#8-32	13/64	14.00

Common End Back-to-Back

TYPE 5 - Back-to-Back Wood or Metal Door
Minimum diameter of pull is 5/8"

Type	Bolt Size	Drill Size	Price
5	1/4"-20	9/32	10.00
5HD	5/16"-18	11/32	14.00

TYPE 9 - Back-to-Back w/Lug Plate Any Door Type
Minimum diameter of pull is 5/8"

Type	Bolt Size	Drill Size	Price
9	1/4"-20	N/A	25.00

TYPE 11XHD - Back-to-Back w/Spanner Collar - Wood or Metal Door
Minimum diameter of pull is 1"

Type	Bolt Size	Drill Size	Price
11XHD	3/8"-16	13/32	29.00

TYPE 13 - Back-to-Back Glass Door

Type	Bolt Size	Drill Size	Price
13	1/4"-20	5/8	17.00
*13HD	5/16"-18	5/8	21.00

TYPE 14XHD - Back-to-Back Glass Door
Minimum diameter of pull is 1"

Type	Bolt Size	Drill Size	Price
14XHD	3/8"-16	5/8	31.00

TYPE 16 - Back-to-Back Wood or Metal Door
1" diameter offset pulls only

Type	Bolt Size	Drill Size	Price
16	1/4"-20	9/32	14.00
16HD	5/16"-18	11/32	18.00

TYPE 18 - Back-to-Back Glass Door

Type	Bolt Size	Drill Size	Price
18	1/4"-20	5/8	20.00
18HD	5/16"-18	5/8	25.00

*HD mountings feature 2 set screws 180° apart.

ASSA ABLOY

The global leader in door opening solutions

Prices Effective September 1, 2017

Copyright © 2017, Rockwood Manufacturing Company, an ASSA ABLOY Group company. All rights reserved. Reproduction in whole or in part without the express written permission of Rockwood Manufacturing Company is prohibited.

Push and Pull Bar Mounting Details

Sizing of Push Bars

Flush Doors

- Door width:
- minus 5" for bent end bars
 - minus 5" for square end post mount bars
 - minus 7" for round end post mount bars

Stile and Rail Doors or Doors with Lites

- Door width:
- minus width of one stile

CAUTION: Always confirm bars will not interfere with jamb or cause pinching hazard.

CAUTION: On narrow stile doors, be sure push bar base fits on the stile and bar does not interfere with the stop.

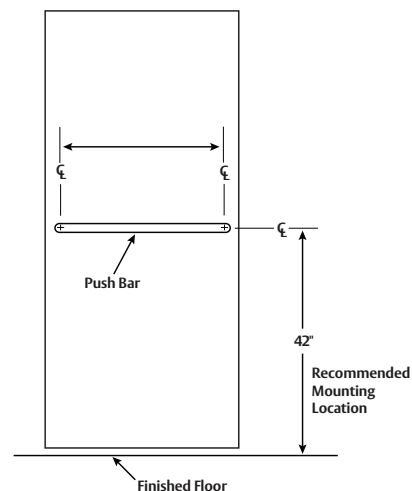

Handing of Doors

The handing of a door is determined from the outside of the opening.

Standing outside the door:

- If the hinges are on the right, it is a right hand door.
- If the hinges are on the left, it is a left hand door.
- If the door opens away from you, it is a regular bevel door.
- If the door opens toward you, it is a reverse bevel door.

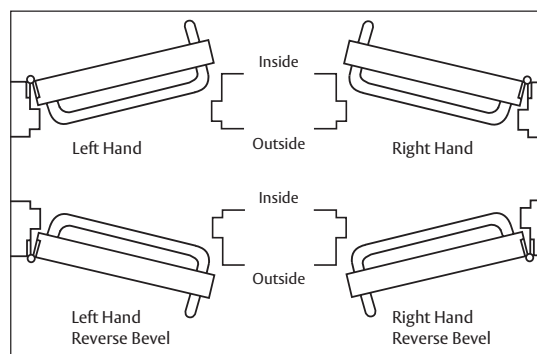

TYPICAL MOUNTING

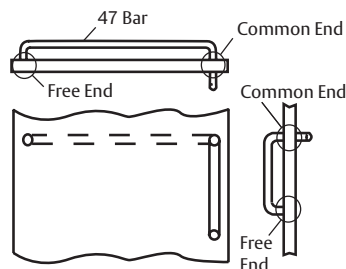

Thru Bolt Mounting - For 1 3/4" Wood and Metal Doors

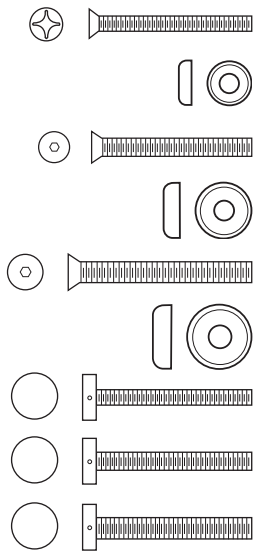

Part	Description	Mounting Type	Price
SP1004	1/4"-20 x 2 1/4" Flat Head Machine Screw Thru Bolt	1	1.50
SP1005	1/4"-20 Finishing Washer	1	0.90
SP1053	5/16"-18 x 2 1/2" Socket Flat Head Machine Screw Thru Bolt	1HD	3.20
SP1054	5/16"-18 Finishing Washer	1HD	1.20
SP1001	3/8"-16 x 2 1/2" Socket Flat Head Machine Screw Thru Bolt	1XHD	5.00
SP1002	3/8"-16 Finishing Washer	1XHD	1.50
SP1003	1" Diameter Decorative Thru Bolt 1/4"-20 x 2 1/4"	12	13.60
SP1055	1" Diameter Decorative Thru Bolt 5/16"-18 x 2 1/4"	12HD	16.20
SP1041	1 1/4" Diameter Decorative Thru Bolt 3/8"-16 x 2 1/4"	12XHD	16.20

Back-to-Back Mounting - For 1 3/4" Wood and Metal Doors

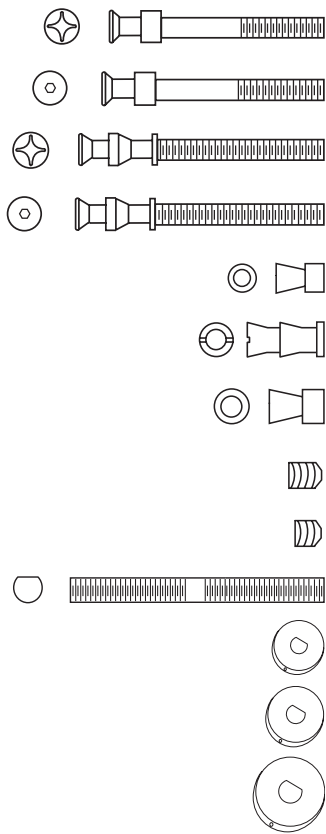

Part	Description	Mounting Type	Price
SP1025	1/4"-20 x 2 1/4" Cone Head Machine Screw	5	3.50
SP1056	5/16"-18 x 2 1/4" Cone Head Machine Screw	5HD	5.60
SP1052	1/4"-20 x 2 1/4" Double Cone Head Machine Screw (for use with offset pulls)	16	4.20
SP1057	5/16"-18 x 2 1/4" Double Cone Head Machine Screw (for use with offset pulls)	16HD	6.80
SP1027	1/4"-20 Cone Head Union (Used to Convert Cone Head to Thru Bolt Hole)	N/A	3.50
SP1079	1/4"-20 Double Cone Head Union (Used to Convert Double Cone Head to Thru Bolt Hole)	N/A	6.20
SP1068	5/16"-18 Cone Head Union (Used to Convert Cone Head to Thru Bolt Hole)	N/A	5.60
SP1026	1/4"-20 x 5/16" Set Screws (Standard)	N/A	0.90
SP1065	1/4"-20 x 3/16" Set Screw (Short)	N/A	1.10
SP1032	3/8"-16 x 2 7/8" LH/RH Bolt	11	7.40
SP1071	Spanner Collar 1" Diameter for LH/RH Bolt	11	11.10
SP1033	Spanner Collar 1 1/4" Diameter for LH/RH Bolt	11	11.10
SP1072	Spanner Collar 1 1/2" Diameter for LH/RH Bolt	11	12.40

ASSA ABLOYThe global leader in
door opening solutions

Prices Effective September 1, 2017

Copyright © 2017, Rockwood Manufacturing Company, an ASSA ABLOY Group company. All rights reserved.
Reproduction in whole or in part without the express written permission of Rockwood Manufacturing Company is prohibited.

Concealed Mounting - For 1 3/4" Wood and Metal Doors

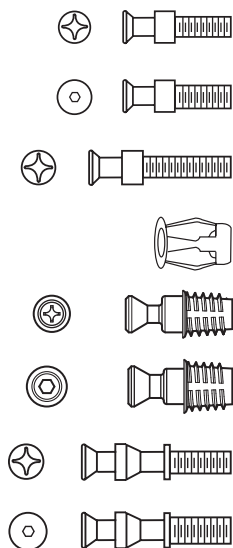

Part	Description	Mounting Type	Price
SP1039	1/4"-20 x 1/2" Cone Head Machine Screw	6 / 6R	3.50
SP1058	5/16"-18 x 1/2" Cone Head Machine Screw	6HD	5.60
SP1021	1/4"-20 x 1 1/8" Cone Head Machine Screw; For Use with Jack Nut - Type 7 Mount	7	3.50
SP1030	1/4"-20 Jack Nut Insert; Mounting Anchor for Concealed Mounting on Hollow Doors	7	3.70
SP1080	1/4"-20 Cone Head / Knife Thread Insert	8	5.90
SP1082	5/16"-18 Cone Head / Knife Thread Insert	8HD	5.90
SP1051	1/4"-20 x 1/2" Double Cone Head Machine Screw	17 / 17R	5.60
SP1059	5/16"-18 x 1/2" Double Cone Head Machine Screw	17HD	6.80

Bushings & Washers - For 1/2" Glass Doors

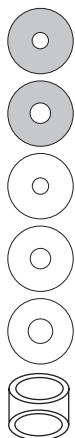

Part	Description	Mounting Type	Price
SP1022	Stainless Steel Washer for 1/4"-20 Cone Head Machine Screw .032" Thick	13	1.50
SP1060	Stainless Steel Washer for 5/16"-18 Cone Head Machine Screw .060" Thick	13HD	1.50
SP1023	Plastic Washer for 1/4"-20 Bolt; Specify Size	13	1.30
SP1061	Plastic Washer for 5/16"-18 Bolt; Specify Size	13HD	1.40
SP1062	Plastic Washer for 3/8"-16 Bolt; Specify Size	14	1.40
SP1024	Glass Door Bushing for 5/8" Hole in Glass; Specify Size	13 / 13HD / 14	1.50

Thru Bolt Mounting - For 1/2" Glass Doors

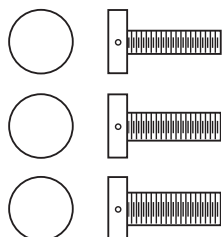

Part	Description	Mounting Type	Price
SP1020	1" Diameter Decorative Thru Bolt; 1/4"-20 x 1 1/8"	15	13.60
SP1063	1" Diameter Decorative Thru Bolt; 5/16"-18 x 1 1/8"	15HD	16.20
SP1040	1 1/4" Diameter Decorative Thru Bolt; 3/8"-16 x 1 1/8"	15XHD	16.20

Prices Effective September 1, 2017

Copyright © 2017, Rockwood Manufacturing Company, an ASSA ABLOY Group company. All rights reserved. Reproduction in whole or in part without the express written permission of Rockwood Manufacturing Company is prohibited.

ASSA ABLOY

The global leader in door opening solutions

Back-to-Back Mounting - For 1/2" Glass Doors

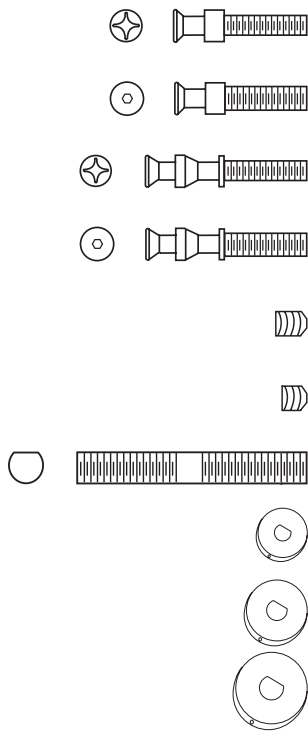

Part	Description	Mounting Type	Price
SP1021	1/4"-20 x 1 1/8" Cone Head Machine Screw	13	3.50
SP1064	5/16"-18 x 1 1/8" Cone Head Machine Screw	13HD	5.60
SP1067	1/4"-20 x 1 1/8" Double Cone Head Machine Screw	18	5.60
SP1066	5/16"-18 x 1 1/8" Double Cone Head Machine Screw	18HD	6.80
SP1026	1/4"-20 x 5/16" Set Screw (Standard)	N/A	0.90
SP1065	1/4"-20 x 3/16" Set Screw (Short)	N/A	1.10
SP1031	3/8"-16 x 1 3/4" LH/RH Bolt	14	7.40
SP1071	Spanner Collar 1" Diameter for LH/RH Bolt	14	11.10
SP1033	Spanner Collar 1 1/4" Diameter for LH/RH Bolt	14	11.10
SP1072	Spanner Collar 1 1/2" Diameter for LH/RH Bolt	14	12.40

Y Base Plates

Specify bolt hole size and finish. Standard pulls require two plates.

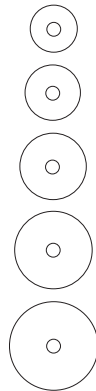

Part	Description	For Use With	Price
SP1073	1/8" Thick x 1 1/16" Diameter	3/4" Diameter Pulls	13.60
SP1074	1/8" Thick x 1 1/4" Diameter	1" Diameter Pulls and Posts	13.60
SP1075	1/8" Thick x 1 1/2" Diameter	1" Diameter Pulls and Posts	13.60
SP1076	1/8" Thick x 1 3/4" Diameter	1" Diameter Pulls and Posts	13.60
SP1077	1/8" Thick x 2" Diameter	1" Diameter Pulls and Posts	13.60

Flush Pull Fasteners

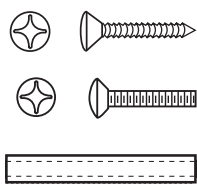

Part	Description	Door Type	Price
SP1006	#8 x 3/4" Oval Head Sheet Metal Screw	Wood or Metal	0.60
SP1007	#8-32 x 3/4" Oval Head Machine Screw	Metal	0.60
SP1034	#8-32 x 1 5/8" Brass Sleeve Machine Screw	Wood or Metal	3.70

ASSA ABLOYThe global leader in
door opening solutions

Prices Effective September 1, 2017

Copyright © 2017, Rockwood Manufacturing Company, an ASSA ABLOY Group company. All rights reserved.
Reproduction in whole or in part without the express written permission of Rockwood Manufacturing Company is prohibited.

Plate Fasteners

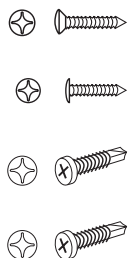

Part	Description	For Use With	Price
SP1008	#6 x 5/8" Oval Head Sheet Metal Screw	Push and Pull Plates; Kick Plates	16.10/c
SP1009	#6 x 3/4" Truss Head Sheet Metal Screw	Plastic / Laminate Kick Plates	16.10/c
SP1050	#6 x 5/8" Pan Head (TEK) Self-Drilling Screw - Stainless Steel	Stainless Steel Kick Plates	40.30/c
SP1069	#6 x 5/8" Pan Head (TEK) Self-Drilling Screw - Brass Plated	Brass Kick Plates	74.60/c

Sex Nuts

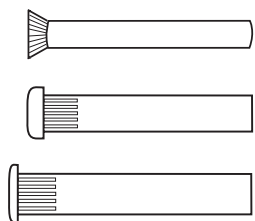

Part	Description	For Use With	Price
SP1018	#8-32 Flat Head Sex Nut	94 Series Flush Pulls	4.70
SP1019	#10-24 x 1 9/16" Sex Nut	580 Surface Bolts	2.70
SP1070	1/4"-20 x 1 9/16" Sex Nut	585 Surface Bolts	6.40

Tamperproof Torx® Head Security Fasteners

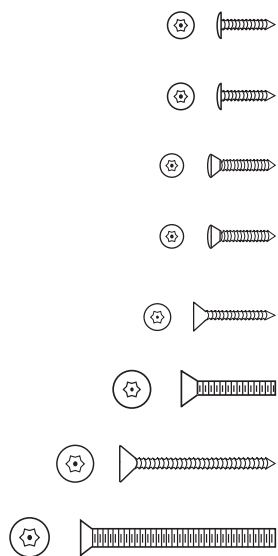

Part	Description	For Use With	Price
SP1016	#6 x 1/2" Button Head Sheet Metal Screw	Kick Plates (Stainless Steel)	0.80
SP1016B	#6 x 1/2" Button Head Sheet Metal Screw Brass Plated	Kick Plates (Stainless Steel)	2.30
SP1042	#6 x 5/8" Oval Head Sheet Metal Screw	Push and Pull Plates (Stainless Steel)	0.80
SP1042B	#6 x 5/8" Oval Head Sheet Metal Screw Brass Plated	Push and Pull Plates (Stainless Steel)	2.90
SP1017	#8 x 3/4" Flat Head Sheet Metal Screw	94 Flush Pulls, 131 Door Pulls, and 555 Flush Bolts	1.90
SP1035	#8-32 x 3/4" Flat Head Machine Screw	94 Flush Pulls, 131 Door Pulls, and 555 Flush Bolts	1.90
SP1037	#12 x 1 1/2" Flat Head Wood Screw	440/442 Door Stops	2.30
SP1038	1/4"-20 x 2 1/2" Flat Head Machine Screw	Door Pulls Type 1 Mount	3.50

Prices Effective September 1, 2017

Copyright © 2017, Rockwood Manufacturing Company, an ASSA ABLOY Group company. All rights reserved.
Reproduction in whole or in part without the express written permission of Rockwood Manufacturing Company is prohibited.

ASSA ABLOY

The global leader in
door opening solutions

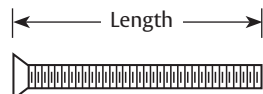

Standard Thru Bolt for Countersunk Holes

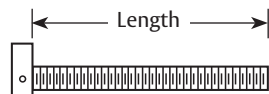

Decorative Thru Bolt for Wood or Metal Doors

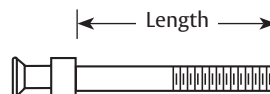

Cone Head Bolt for Back-to-Back Wood or Metal Doors

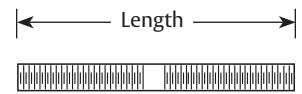

LH/RH Bolt without Heads

Mounting Kits for Door Pulls

Part	Mounting Type	Description	Price
KIT1	1	2 ea. 1/4"-20 x 2 1/4" Thru Bolts and 2 ea. Finish Washers; Specify Finish	4.10
KIT1HD	1HD	2 ea. 5/16"-18 x 2 1/2" Thru Bolts and 2 ea. Finish Washers; Specify Finish	8.10
KIT1XHD	1XHD	2 ea. 3/8"-16 x 2 1/2" Thru Bolts and 2 ea. Finish Washers; Specify Finish	11.90
KIT5	5	2 ea. 1/4"-20 x 2 1/4" Cone Head Bolts and 2 ea. Set Screws	8.10
KIT5HD	5HD	2 ea. 5/16"-18 x 2 1/4" Cone Head Bolts and 4 ea. Set Screws	12.10
KIT6	6	2 ea. 1/4"-20 x 1 1/2" Cone Head Bolts and 2 ea. Set Screws	8.10
KIT6HD	6HD	2 ea. 5/16"-18 x 1 1/2" Cone Head Bolts and 4 ea. Set Screws	12.10
KIT11	11	2 ea. 3/8"-16 x 3 1/2" LH/RH Bolt and 2 ea. Spanner Collars for 1 3/4" Doors; Specify Pull Diameter and Finish	30.90
KIT12-1	12	2 ea. 1/4"-20 x 2 1/4" Decorative Thru Bolts; 1" Dia.; Specify Finish	27.20
KIT12-1HD	12HD	2 ea. 5/16"-18 x 2 1/4" Decorative Thru Bolts; 1" Dia.; Specify Finish	32.50
KIT12-1.25XHD	12XHD	2 ea. 3/8"-16 x 2 1/4" Decorative Thru Bolts; 1 1/4" Dia.; Specify Finish	35.50
KIT12-1.5XHD	12XHD	2 ea. 3/8"-16 x 2 1/4" Decorative Thru Bolts; 1 1/2" Dia.; Specify Finish	41.30
KIT13	13	2 ea. 1/4"-20 x 1 1/8" Cone Head Bolts; 2 ea. Metal Washers; 4 ea. Plastic Washers; 2 ea. Bushings for 1/2" Glass Doors; 2 ea. Set Screws; Specify if other than 1/2" Glass	15.00
KIT13HD	13HD	2 ea. 5/16"-18 x 1 1/8" Cone Head Bolts; 2 ea. Metal Washers; 4 ea. Plastic Washers; 2 ea. Bushings for 1/2" Glass Doors; 4 ea. Set Screws; Specify if other than 1/2" Glass	18.90
KIT14	14	2 ea. 3/8"-16 x 2 1/4" LH/RH Bolt; 2 ea. Spanner Collars; 2 ea. Bushings; 4 ea. Washers for 1/2" Glass Doors; Specify Pull Diameter and Finish	36.90
KIT15	15	2 ea. 1/4"-20 x 1 1/8" Decorative Thru Bolts; 1" Dia.; 2 ea. Bushings; 4 ea. Plastic Washers; Specify Finish and Glass Thickness/Hole Size	32.50
KIT15HD	15HD	2 ea. 5/16"-18 x 1 1/8" Decorative Thru Bolts; 1" Dia.; 2 ea. Bushings; 4 ea. Plastic Washers; Specify Finish and Glass Thickness/Hole Size	38.10
KIT15-1.25XHD	15XHD	2 ea. 3/8"-16 x 1 1/8" Decorative Thru Bolts; 1 1/4" Dia.; 2 ea. Bushings; 4 ea. Plastic Washers; Specify Finish and Glass Thickness/Hole Size	41.30
KIT15-1.5XHD	15XHD	2 ea. 3/8"-16 x 1 1/8" Decorative Thru Bolts; 1 1/2" Dia.; 2 ea. Bushings; 4 ea. Plastic Washers; Specify Finish and Glass Thickness/Hole Size	47.30
KIT16	16	2 ea. 1/4"-20 x 2 1/4" Double Cone Head Bolts and 4 ea. Set Screws	12.10
KIT16HD	16HD	2 ea. 5/16"-18 x 2 1/4" Double Cone Head Bolts and 4 ea. Set Screws	15.00

Part	Mounting Type	Description	Price
KIT17	17	2 ea. 1/4"-20 x 1 1/2" Double Cone Head Bolts and 4 ea. Set Screws	12.10
KIT17HD	17HD	2 ea. 5/16"-18 x 1 1/2" Double Cone Head Bolts and 4 ea. Set Screws	15.00
KIT18	18	2 ea. 1/4"-20 x 1 1/8" Double Cone Head Bolts; 2 ea. Metal Washers; 4 ea. Plastic Washers; 2 ea. Bushings for 1/2" Glass Doors; Specify if other than 1/2" Glass and 4 ea. Set Screws	20.80
KIT18HD	18HD	2 ea. 5/16"-18 x 1 1/8" Double Cone Head Bolts; 2 ea. Metal Washers; 4 ea. Plastic Washers; 2 ea. Bushings for 1/2" Glass Doors; Specify if other than 1/2" Glass and 4 ea. Set Screws	23.80
KIT-T1	T1	1 ea. 1/4"-20 X 2 1/4" Cone Head Bolt; 1 ea. 1/4"-20 Cone Head Union; 2 ea. Set Screws; 2 ea. 1/4"-20 x 2 1/4" — 1" Dia. Decorative Thru Bolts; Specify Finish	35.40
KIT-T2	T2	1 ea. 1/4"-20 X 1 1/8" Cone Head Bolt; 1 ea. 1/4"-20 Cone Head Union; 2 ea. Set Screws; 2 ea. 1/4"-20 x 1 1/8" — 1" Dia. Decorative Thru Bolts; 1 ea. Metal Washer; 6 ea. Plastic Washers; 3 ea. Bushings; Specify Finish	44.10
KIT-T3	T3	1 ea. 1/4"-20 X 2 1/4" Cone Head Bolt; 1 ea. 1/4"-20 Cone Head Union; 2 ea. Set Screws; 2 ea. 1/4"-20 x 2 1/4" Thru Bolts; 2 ea. Finish Washers; Specify Finish	12.10
KIT-T4	T4	1 ea. 1/4"-20 X 2 1/4" Cone Head Bolt; 2 ea. 1/4"-20 x 1 1/2" Cone Head Bolts; 3 ea. Set Screws	12.10
KIT-T5	T5	1 ea. 1/4"-20 X 2 1/4" Cone Head Bolt; 2 ea. 1/4"-20 x 1 1/2" Cone Head Wood Screws; 3 ea. Set Screws	12.10
KITRM1.25	11x1XHD	2 ea. 3/8"-16 x 2 1/2" Thru-Bolts; 2 ea. Finish Washers; 1 ea. 3/8"-16 x 3 1/2" LH/RH Bolt; 1 ea. 1 1/4" Spanner Collar; Specify Finish	27.50
KITRM360	11x12XHD	2 ea. 3/8"-16 x 2 1/4" Decorative Thru Bolts 1 1/4" Dia.; 1 ea. 3/8"-16 x 3 1/2" LH/RH Bolt; 1 ea. 1 1/4" Spanner Collar; Specify Finish	50.90
KITRM360G	14x15XHD	2 ea. 3/8"-16 x 2 1/4" Decorative Thru Bolts 1 1/4" Dia.; 1 ea. 3/8"-16 x 2 1/4" LH/RH Bolt; 1 ea. 1 1/4" Spanner Collar; 3 ea. Bushings; 6 ea. Plastic Washers; Specify Finish	59.80
KITRM1.5	11x1XHD	2 ea. 3/8"-16 x 2 1/2" Thru Bolts; 2 ea. Finish Washers; 1 ea. 3/8"-16 x 3 1/2" LH/RH Bolt; 1 ea. 1 1/2" Spanner Collar; Specify Finish	30.30
KITRM380	11x12XHD	2 ea. 3/8"-16 x 2 1/4" Decorative Thru Bolts 1 1/2" Dia.; 1 ea. 3/8"-16 x 3 1/2" LH/RH Bolt; 1 ea. 1 1/2" Spanner Collar; Specify Finish	59.80
KITRM380G	14x15XHD	2 ea. 3/8"-16 x 2 1/4" Decorative Thru Bolts 1 1/2" Dia.; 1 ea. 3/8"-16 x 1 1/4" LH/RH Bolt; 1 ea. 1 1/2" Spanner Collar; 3 ea. Bushings; 6 ea. Plastic Washers; Specify Finish	68.50

ASSA ABLOY

The global leader in door opening solutions

Prices Effective September 1, 2017

Copyright © 2017, Rockwood Manufacturing Company, an ASSA ABLOY Group company. All rights reserved. Reproduction in whole or in part without the express written permission of Rockwood Manufacturing Company is prohibited.

ASSA ABLOY is the global leader in door opening solutions, dedicated to satisfying end-user needs for security, safety and convenience

ASSA ABLOY



300 Main Street
Rockwood, Pennsylvania 15557
P: 800-458-2424 • F: 800-922-9212
www.rockwoodmfg.com • orders.rockwood@assaabloy.com

(In Canada)
Door Security Solutions Canada
160 Four Valley Drive
Vaughan, ON L4K 4T9
P: 800-461-3007
www.assaabloy.ca