

LogiTrack User Guide

Contents

1. Safty Precautions	6
2. Introducing the System.....	9
3. LogiTrack Components.....	10
3.1. Base Station	10
3.2. Gate Locator.....	14
3.3. Gate Exciter GPRS	18
3.4. 4 Channel Exciter	22
3.5. 1 Channel Exciter	27
3.6. Remote Door indicator	30
3.7. LF antennas	34
3.6.1 Ceiling antenna	34
3.6.2 Door antenna	36
3.6.3 Antenna installation examples.....	38
3.7 Tags	39
3.7.1 General.....	39
3.7.2 Attaching tags to objects	42
3.7.3 Staff tag functionality.....	42
3.8 System Ranges	43
4. General Warning and instructions.....	44
4.1 Relay (Dry contact) connection.....	44
5. Infrastructure and data flow sketch	47
5.1 Site installation example.....	48
6. Software Installation.....	49

- 6.1 Installing the Technician-Station..... 49
- 6.2 Software Operation..... 49
- 6.3 Application Structure 50
- 6.4 Connecting to a unit..... 51
 - 6.4.1 Adding a Base-Station 51
 - 6.4.2 Adding a Gate locator 52
 - 6.4.3 Defining a unit ID to the Gate Locator 52
 - 6.4.4 Viewing Connectivity Status..... 53
 - 6.4.5 “Base-Station Setup” Tab..... 55
 - 6.4.6 RF zones (Lf antennas) configuration..... 56
 - 6.4.7 Advanced Operational Parameters..... 57
 - 6.4.8 “Tags Setup” Tab..... 58
 - 6.4.9 Sensors & tag definitions 59
 - 6.4.10 “Enrollment” Tab 61
 - 6.4.11 “Detection” Tab 63
 - 6.4.12 “Base-Station Operation” Tab..... 65
 - 6.4.13 “Reports” Tab..... 66
 - 6.4.14 “Log” Tab..... 67
- 7. Troubleshooting..... 68
 - 7.1 Connectivity issues..... 68
 - 7.1.1 Software connection 68
 - 7.1.2 Driver installation..... 69
 - 7.2 Hardware issues..... 70
 - 7.2.1 LF signal does not transmits..... 70

LT-D-0211 rev 16

- 7.2.2 Unit doesn't turn on..... 70
- 7.2.3 The unit is on but no response..... 70
- 7.2.4 Tag does not respond..... 71
- 8. Radio Approvals 72
 - 8.1 Base Station\Gate Locator\Gate Exciter GPRS\4 Channel Exciter 72
 - 8.1.1 USA (FCC) 72
 - 8.2 One Channel Exciter 73
 - 8.2.1 USA (FCC) 73
 - 8.3 Remote Door Indicator 74
 - 8.3.1 USA (FCC) 74
 - 8.4 Staff Tag 75
 - 8.4.1 USA (FCC) 75
 - 8.5 Resident Tag..... 76
 - 8.5.1 USA (FCC) 76
- 9. Power supply requirements..... 77
 - 9.1 Limited power source: 77
 - 9.2 Main supply network: 77

Abbreviations:



LT-D-0211 rev 16

Base station	CMU (Central Management Unit)
Gate locator	DMU (Door Management Unit)
4 channel Exciter	MLU (Multi Location Unit)
Gate Exciter GPRS	Door Management Unit GPRS
1 channel Exciter	SLU (Single Location Unit)
Remote Door indicator	LIU (Lights Indication Unit)
Ceiling antenna	CAU (Ceiling Antenna Unit)
Door antenna	DAU (Door Antenna Unit)
Staff tag	SIU (Staff Indication Unit)
Patient tag	PIU (Patient Indication Unit)

1. Safty Precautions

Precautions

WARNING	
In any case of smoke, strange odor or unusual noise – please shut down all equipment operation and perform a power shut down	
Be sure to use the specified power source	
In case of water or any liquid spilled into the equipment, do not continue to use the equipment. Perform an immediate power shutdown	

CAUTION	
Avoid water at all times when working with the system. Never touch or try repairing any electrical equipment or circuits with wet hands.	
Make sure that the direction and polarity (+/-) are correct when Connecting terminal blocks and connectors.	
Do not allow pieces of metal, wire clippings, or fine metallic shavings or filings from installation to enter the product. Doing so may occasionally result in minor electric shock, fire, or malfunctions.	
Do not attempt to disassemble, repair, or modify the product, or touch the internal parts of the product. Doing so may occasionally result in minor electric shock, fire, or malfunctions.	

Precautions for Safe Use

Be sure to observe the following precautions to ensure safe use of the product.

1. Transport the product in the box in which the product was packed. Making sure the product is not subjected to excessive vibrations or shock, or dropped.
2. Store the product within the specified environment.
3. Use the product within the specified temperature and humidity ranges.
4. Do not use the product in the following locations:
 - 4.1. Locations subject to extreme temperature changes resulting in condensation Locations subject to static electricity, excessive noise, or electric fields Locations where the product may come into contact with water, oil, or chemicals .
 - 4.2. Locations where corrosive gases or flammable gases are present
 - 4.3. Locations subject to spatters, iron chips, or filings
5. Do not install the product outdoors
6. Do not reverse the power supply connection or connect the product to an AC power supply.
7. Use the correct power supply voltage.
8. Do not apply voltage to the inputs exceeding the rated voltage range.
9. Always set the product after it is installed or replaced. Set the product correctly according to the manual, and be sure to perform the tests provided with the product before operating it.
10. When operating the product, check whether an existing system is present, and design the system carefully to prevent radio interference.
11. Do not apply excess vibrations or shock to this product. Do not drop this product.
12. Make sure that the antennas are not disconnected during operation.
13. Do not use this product near other devices that may cause a malfunction to the system such as electrical cabinet.
14. Turn OFF the power supply before performing any wiring or replacing devices.
15. Do not touch the product with wet hands.

Power supply requirements:

There are 2 options of power supply:

1. Local LPS 24V power supply. Use only certified power supply with relevant approvals.
The approved by LogiTag are:
 - EDAC p/n EA10721B-2404
 - MEAN WELL p/n GS60A24Customer may use equivalent power supply only.
2. Main power supply of 24V for few systems. A unit of up to 40A supply can be used, certified for the country/zone where the systems used. See at chapter 9 power supply requirements for power lines installation requirements.

Precautions for Correct Use

Always check operations before using the product.

Prevent faulty operation, malfunction, or adverse effect on the product's performance and functionality.

1. Communications performance will vary according to the operating environment.
2. Do not install the antenna in a location surrounded by metal.
3. Install the antenna cable as far away as possible from any electric wires or metal plates.
4. Do not use this product in areas exposed to extremely high humidity.
5. Make sure that the all connections are screwed properly and no exposed wires
6. Do not pull or bend cables with force.

Professional installation requirements

LogiTag's Active system products can only be installed by certified, professional personnel.

Certificate will be granted by LogiTag or Authorized 3rd party.

Each installer receives special training, which is a condition for receiving the license from LogiTag to become a "licensed" installer. The installation itself is a unique procedure.

2. Introducing the System

What is the LogiTrack?

The LogiTrack system is an Active-RFID based infrastructure, constructed from the following elements:

- Base Stations – a management unit that controls the gate locators
- Gate Locators – sub unit of the base station. LF exciting and UHF retrieval. Have the ability to run logical and business rules
- 4 channel exciter - sub unit of the base station. Up to 4 channel LF exciting antennas
- 1 channel exciter - sub unit of the base station. 1 channel of LF exciting antennas
- LF Antennas - detection antenna that generates RFID zones
- UHF antennas – UHF data retrieval and transmit
- Remote Door indicator – Wireless LEDs device. Operates by UHF commands from the base station
- Tags – RFID tags that contains a unique ID and have many functionalities

The system enables real time tracking on objects by placing RFID tags on the objects and detecting them by the use of all system components.

Technician software-

The Technician-Station is software provided by LogiTag, enabling system administrators to connect, activate and configure the various equipment, and set it up in a system perspective.

The detailed functionality provided by the Technician Station is:

- Define, connect and configure Base-Station
- Define, connect and configure Gate locator
- Activate and configure tags, including the configuration of specific sensors
- Receive and display messages received from tags
- Enable enrollment of tags to defined assets
- Provide detailed information through reports
- Provide a log file of all raw data received from the Base-Stations
- Enable interfaces to 3rd part systems

3. LogiTrack Components

The following describes the components of a LogiTrack system:

3.1. Base Station

The Base-Station functionalizes as the management unit. The base station purpose is to manage the subunits – gate locators. It carries out the following functionalities:

- **Management unit** –the data that is received on the gate locators is transferred to the base station with an indication on which unit sends the data.
The unit is able to send configuration info the gate locators via 869.85/916 MHz (area dependent)
- **Transferring data** – the Base-Station receives over the UHF band. the messages transmitted by the tags to the gate locator and then to the base station. It can send them a response (to acknowledge the reception); send data to a main server, trigger local hardware through dry-contact interfaces or start a continuous communication session with the tag.
- **Independent unit** – the unit can function and connect to a server.

Base station can connect the customer computer/management system via Ethernet, GPRS or WIFI.

Note that the base station installation must be separated from electricity and communication infrastructure

Technical details:

Power	
Power supply	24 VDC
Maximum current consumption	2 A
Backup battery	9Ah rechargeable
Fuse	PTC 2.5A
Air interface	
UHF interface	3 X 433 MHz, 1 X 869.85/916 MHz
UHF range	Up to 25 m
LF interface	None
LF range	N/A
Host interface	
USB	2 X USB (115.2 Kbps)
Ethernet	10/100 Mbps
Wi-Fi	802.11 b/g, up-to 54Mbps (optional)
GPRS	GPRS connection (optional)
I/O interfaces	
Relays	4 X normally open relay contacts. 250 VAC/5A each
Inputs	4 X low level signal analog/digital inputs

Outputs	4 X general use outputs, V=24V I _{max} = 20mA for each
LEDs	12 X LEDs
Memory	
EEPROM	128 MB
Flash	128 MB
Environmental	
Operational temperature	-10°C ÷ +45°C
Storage temperature	-20°C ÷ +70°C
Dimensions and weight	
Dimensions	L X W X H - 275 X 159 X 57 mm
Weight	1.23 Kg

Backup battery replacements

Warnings:

1. In any case before replacing advice your local supplier technical support or Logitag customers support.
2. Only authorized technician can replace battery.
3. Disconnect the unit from the power source.
4. Use battery which approved by Logitag for assembly at the unit.
5. Battery must be rechargeable type 3.7-4.2V.

Replacement procedure:

- Disconnect the unit from power source and all other cables connection to the connectors panel.
- Open the 4 screws of the device.
- Remove the battery
- Connect the new battery

Installation instructions

Installation positions:

- Vertically – placed on a shelf or a table, antennas adjusted and pointed to the ceiling.
- Wall mount - Screwed to the wall by using the side brackets, antennas adjusted and pointed to the ceiling.

Power Connection:

- Connect the power connection to the power socket and to the unit at "power" connection.

Relay and antennas:

- Relay connection – see [Relay \(Dry contact\) connection](#) section.
- Antennas – connect the antennas to any port available on LF antennas ports 1-4.

Service instructions

The unit must be kept away from metal, heat (above 60 ° Celsius \140 Fahrenheit) and water.

Cleaning instructions

No cleaning is required

Wiring instructions

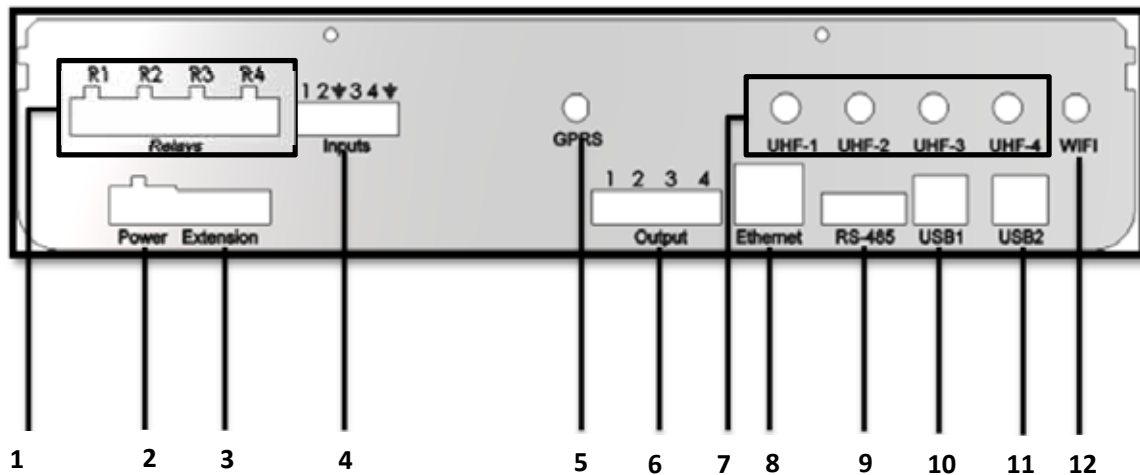

Connections:

1. Relays - see [Relay \(Dry contact\) connection](#) section.
2. **Power** – connect the unit to the power socket by using 24v adaptor
3. **Extension** – use for board hardware extensions
4. **Inputs** –connect digital control inputs.
5. **GPRS**-connect a GPRS antenna
6. **Output**–option to operate loads at 24V with software rules options.
7. UHF antennas – connect a 433 MHz antennas to UHF 1-3, UHF 4 can be either:
 - 916MHz (USA,IL)
 - 869.85Mhz(Europe)
8. Ethernet – connect a CAT5E Ethernet cable
9. **RS-485- communication port**
10. USB 1- connect a USB cable to communicate with the Low level controller
11. USB 1- connect a USB cable to communicate with the High level controller
12. **WI-FI-connector for WIFI antenna**

Front panel indications

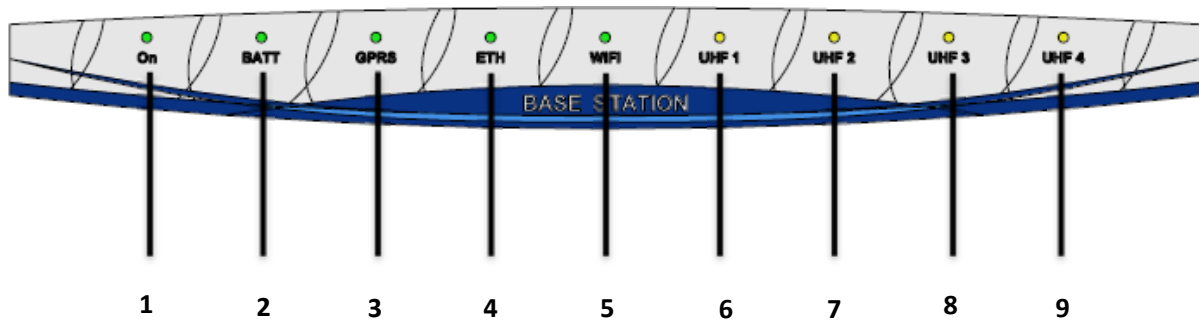

LED indication:

1. **On** –LED indication for power connection
2. **Batt**- LED indication for a battery connected and working
3. **GPRS**- LED indication for GPRS connection established
4. **ETH**- LED indication for ETH connection established
5. **Wi-Fi**- LED indication for WI-FI connection established
6. **UHF 1- DNA**
7. **UHF 2- DNA**
8. **UHF 3**- indication for receiving sensor tag
9. **UHF 4**- indication for communicating with exciter

Warnings

Battery - Risk of explosion if battery is exposed to extreme heat

Exposed wires – Risk of shock when touching exposed wires

Water Exposure- Risk of shock when touching the unit exposed to water

3.2. Gate Locator

The Gate Locator has 3 main functions:

- Generate RF-Zones using an internal 125 KHz transmitter. Each of the Gate Locator's channels carries a unique number as an identifier to the location/area where the RF-Zone is operates.
- Operates logical rules: based on events (tag detection, sensor detection, location decision, etc.) that the units detects it activates actions (I/O, parameter update, etc.)
- Function as a repeater to tag's transmissions, relaying it toward the Base-Station unit.
- Independent unit – the unit can function and connect to a server.

Gate Locator can connect the customer computer/management system via Ethernet or WIFI.

Note that the Gate locator installation must be separated from electricity and communication infrastructure

Technical details:

Power	
Power supply	24 VDC
Maximum current consumption	2.5 A
Backup battery	9Ah rechargeable
Fuse	PTC 2.5A
Air interface	
UHF interface	3 X 433 MHz, 1 X 869.85/916 MHz
UHF range	Up to 25 m
LF interface	4 X 125 KHz
LF range	0 – 10 m
Host interface	
RS232	2 X RS232 (115.2 Kbps)
Ethernet	10/100 Mbps
Wi-Fi	802.11 b/g, up-to 54Mbps (optional)
GPRS	none
I/O interfaces	
Relays	8 X normally open relay contacts. 250 VAC/5A each
Inputs	8 X low level signal analog/digital inputs
Outputs	8 X general use outputs, V=24V I _{max} = 20mA for each
LEDs	12 X LEDs
Memory	
EEPROM	128 MB
Flash	128 MB
Environmental	
Operational temperature	-10°C ÷ +45°C
Storage temperature	-20°C ÷ +70°C
Dimensions and weight	

LT-D-0211 rev 16

Dimensions	L X W X H - 275 X 159 X 57 mm
Weight	1.29 Kg

LF Antennas power settings:

For each LF antenna you can configure via software, the output power at range of between 10 to 100%.

Backup battery replacements:

Warnings:

1. In any case before replacing advice your local supplier technical support or Logitag customers support.
2. Only authorized technician can replace battery.
3. Disconnect the unit from the power source.
4. Use battery which approved by Logitag for assembly at the unit.
5. Battery must be rechargeable type 3.7-4.2V.

Replacement procedure:

- Disconnect the unit from power source and all other cables connection to the connectors panel.
- Open the 4 screws of the device.
- Remove the battery
- Connect the new battery

Installation instructions

Installation positions:

- Vertically – placed on a shelf or a table, antennas adjusted and pointed to the ceiling.
- Wall mount - Screwed to the wall by using the side brackets, antennas adjusted and pointed to the ceiling.

Power Connection:

- Connect the power connection to the power socket and to the unit at "power" connection.

Relay and antennas:

- Relay connection – see [Relay \(Dry contact\) connection](#) section.
- Antennas – connect the antennas to any port available on LF antennas ports 1-4.

Service instructions

The unit must be kept away from metal, heat (above 60 ° Celsius \140 Fahrenheit) and water.

Cleaning instructions

No cleaning is required

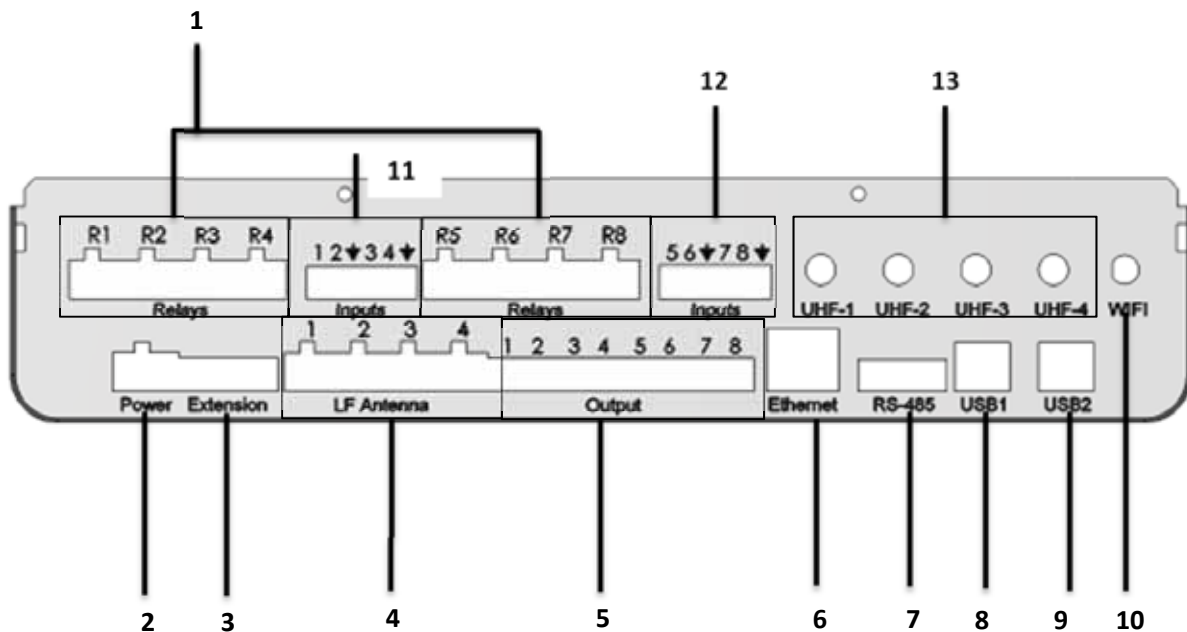

Wiring instructions

Connections:

1. Relays 1-8 - see [Relay \(Dry contact\) connection](#) section.
2. Power – connect the unit to the power socket by using 24v adaptor
3. Extension – use for board hardware extensions
4. LF antennas – connect the LF cable antenna to each one of the available ports 1- 4
5. Output– option to operate loads at 24V with software rules options.
6. Ethernet – connect a CAT5E Ethernet cable
7. RS-485-communication port connector
8. USB 1- connect a USB cable to communicate with the Low level controller
9. USB 1- connect a USB cable to communicate with the High level controller
10. WI-FI- connector for WIFI antenna
- 11, 12. Input 1-4; 5-8
13. UHF antennas – connect a 433 MHz antennas to UHF 1-3, UHF 4 can be either:
 - 916MHz (USA,IL)
 - 869.85Mhz(Europe)

Front panel indications

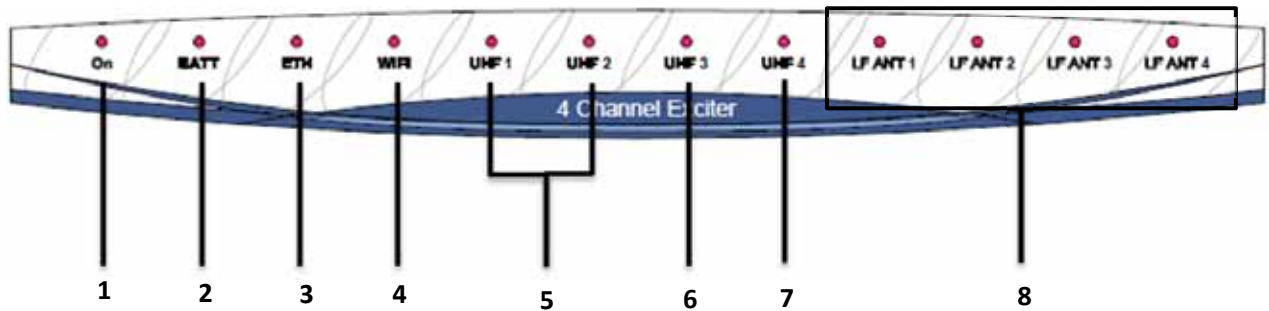

LED indication:

1. **On** –LED indication for power connection
2. **Batt**- LED indication for a battery connected and working
3. **ETH**- LED indication for ETH connection established
4. **Wi-Fi**- LED indication for WI-FI connection established
5. **UHF 1, 2** – LED indication for transmitting and receiving data to and from tags
6. **UHF 3** - LED indication for transmitting and receiving data to and from tag sensor
7. **UHF 4** - LED indication for communication with a base station unit.
8. **LF ant 1-4** – LED indication of antenna activated on the unit

Warnings

Battery - Risk of explosion if battery is exposed to extreme heat

Exposed wires – Risk of shock when touching exposed wires

Water Exposure- Risk of shock when touching the unit exposed to water

3.3. Gate Exciter GPRS

The Gate Locator GPRS functionalizes as a combination of Base Station and Gate Locator. Can be the management unit and also direct operation and control of RFID tags.

Unit can manage the subunits – gate locators. It carries out the following functionalities:

- **Management unit** –the data that is received on the gate locators is transferred to the unit with an indication on which unit sends the data.
The unit is able to send configuration info the gate locators via 869.85/916 MHz (area dependent)
- **Transferring data** – the unit receives over the UHF band. the messages transmitted by the tags to the gate locator and then to the Gate Exciter GPRS. It can send them a response (to acknowledge the reception); send data to a main server, trigger local hardware through dry-contact interfaces or start a continuous communication session with the tag.
- Generate RF-Zones using an internal 125 KHz transmitter. Each of the unit's channels carries a unique number as an identifier to the location/area where the RF-Zone is operates. The device has 4 LF antenna ports, only one works at a time.
- Operates logical rules: based on events (tag detection, sensor detection, location decision, etc.) that the units detects it activates actions (I/O, parameter update, etc.)
- Function as a repeater to tag’s transmissions, relaying it toward the Base-Station unit.

Independent unit – the unit can function and connect to a server.

Gate Exciter GPRS can connect the customer computer/management system via Ethernet, GPRS or WIFI.

Note that the Gate Exciter GPRS installation must be separated from electricity and communication infrastructure

Technical details:

Power	
Power supply	24 VDC
Maximum current consumption	2.5 A
Backup battery	9Ah rechargeable
Fuse	PTC 2.5A
Air interface	
UHF interface	3 X 433 MHz, 1 X 869.85/916 MHz
UHF range	Up to 25 m
LF interface	4 X 125 KHz
LF range	0 – 10 m
Host interface	
RS232	2 X RS232 (115.2 Kbps)
Ethernet	10/100 Mbps
Wi-Fi	802.11 b/g, up-to 54Mbps (optional)
GPRS	GPRS connection (optional)
I/O interfaces	

Relays	8 X normally open relay contacts. 250 VAC/5A each
Inputs	8 X low level signal analog/digital inputs
Outputs	8 X general use outputs, V=24V I _{max} = 20mA for each
LEDs	12 X LEDs
Memory	
EEPROM	128 MB
Flash	128 MB
Environmental	
Operational temperature	-10°C ÷ +45°C
Storage temperature	-20°C ÷ +70°C
Dimensions and weight	
Dimensions	L X W X H - 275 X 159 X 57 mm
Weight	1.29 Kg

LF Antennas power settings:

For each LF antenna you can configure via software, the output power at range of between 10 to 100%.

Backup battery replacements:

Warnings:

6. In any case before replacing advice your local supplier technical support or Logitag customers support.
7. Only authorized technician can replace battery.
8. Disconnect the unit from the power source.
9. Use battery which approved by Logitag for assembly at the unit.
10. Battery must be rechargeable type 3.7-4.2V.

Replacement procedure:

- Disconnect the unit from power source and all other cables connection to the connectors panel.
- Open the 4 screws of the device.
- Remove the battery
- Connect the new battery

Installation instructions

Installation positions:

- Vertically – placed on a shelf or a table, antennas adjusted and pointed to the ceiling.
- Wall mount - Screwed to the wall by using the side brackets, antennas adjusted and pointed to the ceiling.

Power Connection:

- Connect the power connection to the power socket and to the unit at "power" connection.

Relay and antennas:

- Relay connection – see [Relay \(Dry contact\) connection](#) section.
- Antennas – connect the antennas to any port available on LF antennas ports 1-4.

LT-D-0211 rev 16

Service instructions

The unit must be kept away from metal, heat (above 60 ° Celsius \140 Fahrenheit) and water.

Cleaning instructions

No cleaning is required

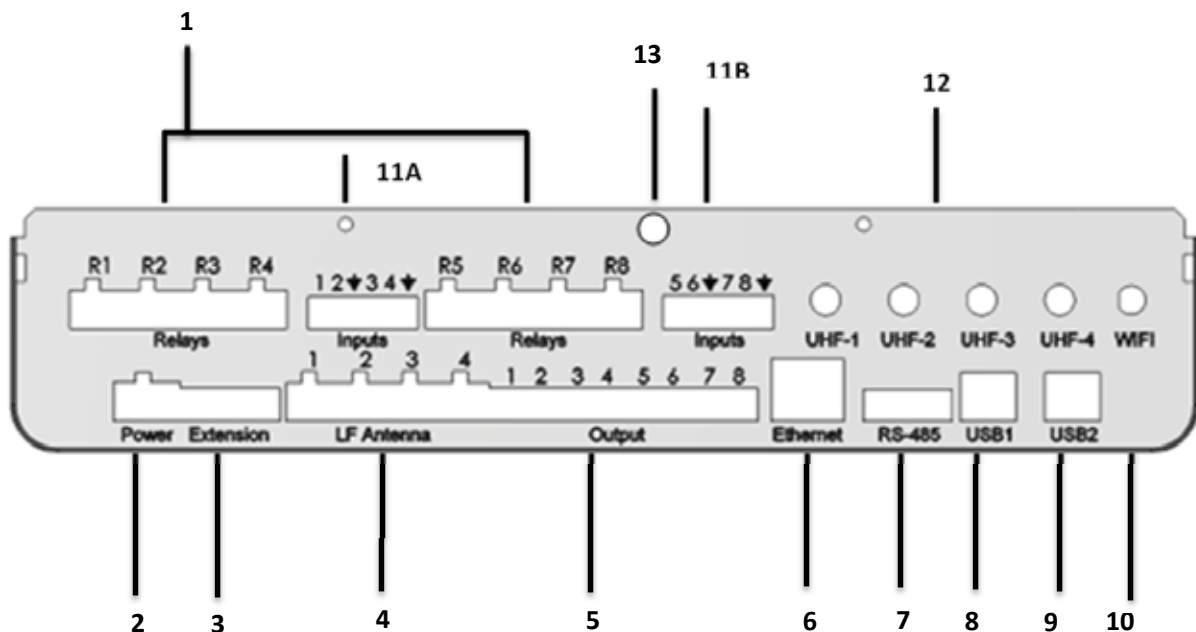

Wiring instructions

Connections:

1. Relays 1-8 - see [Relay \(Dry contact\) connection](#) section.
2. Power – connect the unit to the power socket by using 24v adaptor
3. Extension – use for board hardware extensions
4. LF antennas – connect the LF cable antenna to each one of the available ports 1- 4
5. Output– option to operate loads at 24V with software rules options.
6. Ethernet – connect a CAT5E Ethernet cable
7. RS-485-communication port connector
8. USB 1- connect a USB cable to communicate with the Low level controller
9. USB 1- connect a USB cable to communicate with the High level controller
10. WI-FI- connector for WIFI antenna
11. 11A,11B Input 1-4; 5-8

LT-D-0211 rev 16

12. UHF antennas – connect a 433 MHz antennas to UHF 1-3, UHF 4 can be either:

- 916MHz (USA,IL)
- 869.85Mhz(Europe)

13. GPRS

Front panel indications

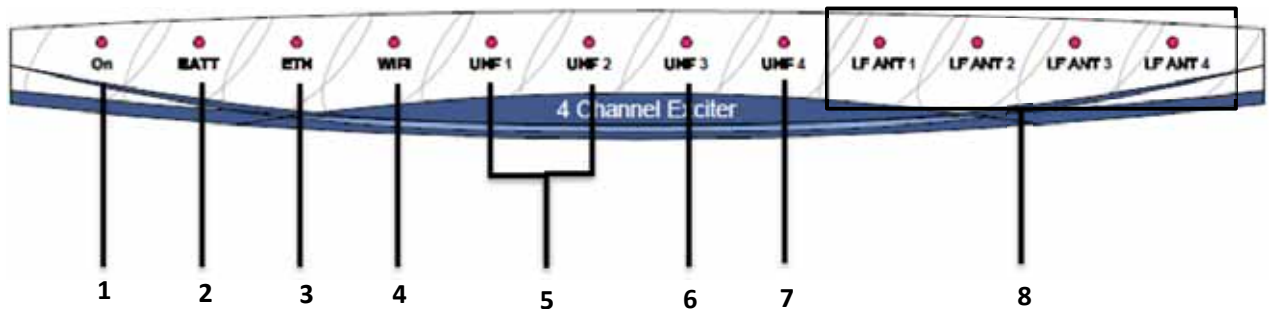

LED indication:

9. **On** –LED indication for power connection
10. **Batt**- LED indication for a battery connected and working
11. **ETH**- LED indication for ETH connection established
12. **Wi-Fi**- LED indication for WI-FI connection established
13. **UHF 1, 2** – LED indication for transmitting and receiving data to and from tags
14. **UHF 3** - LED indication for transmitting and receiving data to and from tag sensor
15. **UHF 4** - LED indication for communication with a base station unit.
16. **LF ant 1-4** – LED indication of antenna activated on the unit

Warnings

Battery - Risk of explosion if battery is exposed to extreme heat

Exposed wires – Risk of shock when touching exposed wires

LT-D-0211 rev 16

Water Exposure- Risk of shock when touching the unit exposed to water

3.4. 4 Channel Exciter

The 4 channel exciter is a unit that has 2 main functions:

- Generate RF-Zones using an internal 125 KHz transmitter. Each of the 4 channel exciter's channels carries a unique number as an identifier to the location/area where the RF-Zone is operates.
- Function as a repeater to tag's transmissions, relaying it toward the Base-Station unit. Independent unit – the gate locator can function and connect to a server.

Technical details:

Power	
Power supply	24 VDC
Maximum current consumption	2.5 A
Backup battery	9Ah rechargeable
Fuse	2.5A PTC
Air interface	
UHF interface	3 X 433 MHz, 1 X 869.85/916 MHz
UHF range	Up to 25 m
LF interface	4 X 125 KHz
LF range	0 – 10 m
Host interface	
RS232	2 X RS232 (115.2 Kbps)
Ethernet	None
Wi-Fi	None
GPRS	None
I/O interfaces	
Relays	8 X normally open relay contacts. 250 VAC/5A each
Inputs	8 X low level signal analog/digital inputs
Outputs	8 X general use outputs, V=24V I _{max} = 20mA for each
LEDs	12 X LEDs
Memory	
EEPROM	128 MB
Flash	128 MB
Environmental	
Operational temperature	-25°C ÷ +60°C
Storage temperature	-45°C ÷ +85°C
Dimensions and weight	
Dimensions	L X W X H - 275 X 159 X 57 mm
Weight	1.29 Kg

LT-D-0211 rev 16

LF Antennas power settings:

For each LF antenna you can configure via software, the output power at range of between 10 to 100%.

Backup battery replacements:

Warnings:

11. In any case before replacing advice your local supplier technical support or Logitag customers support.
12. Only authorized technician can replace battery.
13. Disconnect the unit from the power source.
14. Use battery which approved by Logitag for assembly at the unit.
15. Battery must be rechargeable type 3.7-4.2V.

Replacement procedure:

- Disconnect the unit from power source and all other cables connection to the connectors panel.
- Open the 4 screws of the device.
- Remove the battery
- Connect the new battery

Service instructions

The unit must be kept away from metal, heat (above 60 ° Celsius \140 Fahrenheit) and water.

Cleaning instructions

No cleaning is required

LT-D-0211 rev 16

Wiring instructions

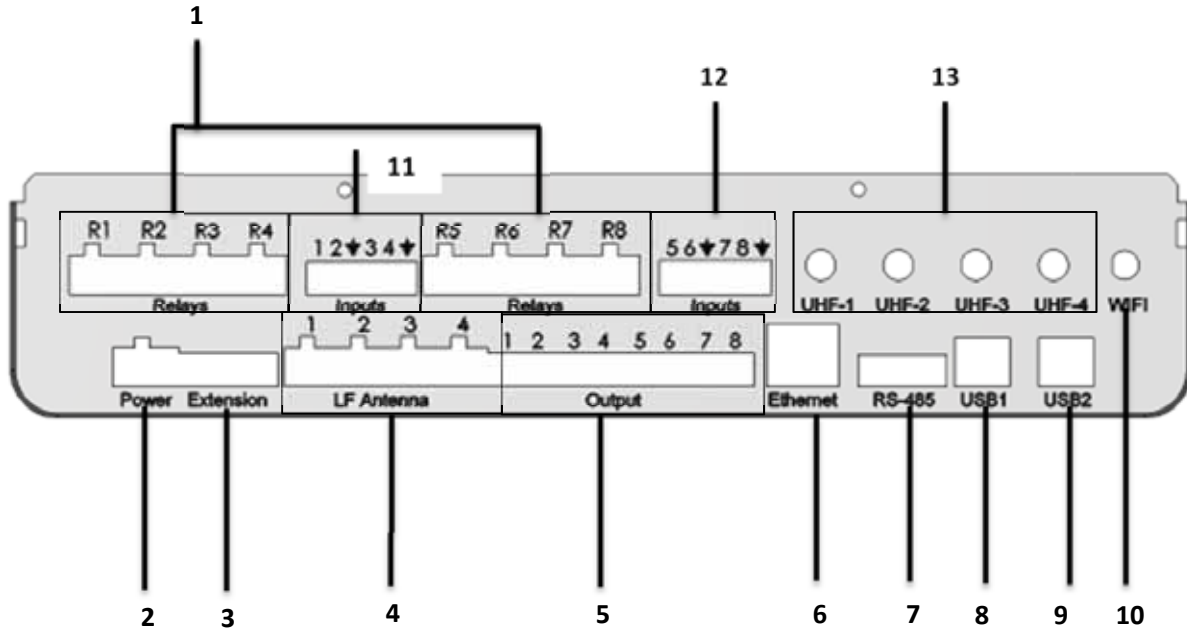

Connections:

1. Relays 1-8 - see [Relay \(Dry contact\) connection](#) section.
2. **Power** – connect the unit to the power socket by using 24v adaptor
3. **Extension** – use for board hardware extensions
4. **LF antennas** – connect the LF cable antenna to each one of the available ports 1- 4
5. **Output**– option to operate loads at 24V with software rules options.
6. Ethernet – connect a CAT5E Ethernet cable
7. **RS-485-communication port connector**
8. USB 1- connect a USB cable to communicate with the Low level controller
9. USB 1- connect a USB cable to communicate with the High level controller
10. **WI-FI- connector for WIFI antenna**
- 11, 12. **Input 1-4; 5-8**
14. UHF antennas – connect a 433 MHz antennas to UHF 1-3, UHF 4 can be either:
 - 916MHz (USA,IL)
 - 868Mhz(Europe)

LT-D-0211 rev 16

Front panel indications

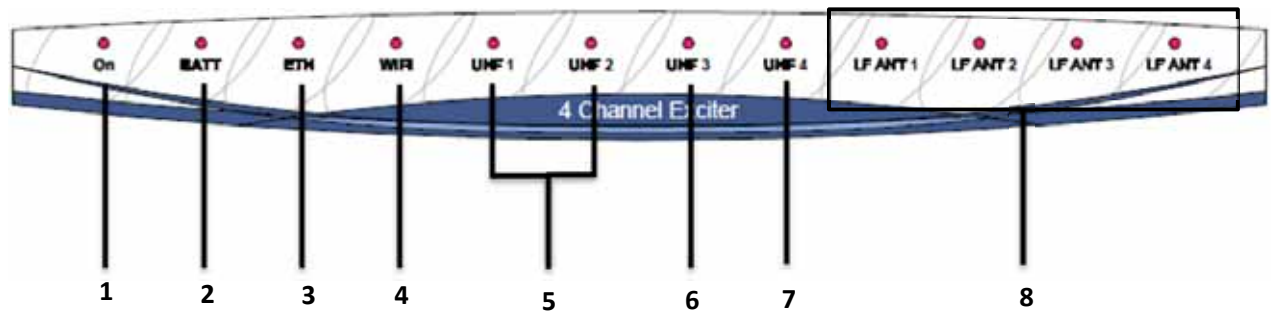

LED indication:

- 17. **On** –LED indication for power connection
- 18. **Batt**- LED indication for a battery connected and working
- 19. **ETH**- LED indication for ETH connection established
- 20. **Wi-Fi**- LED indication for WI-FI connection established
- 21. **UHF 1, 2** – LED indication for transmitting and receiving data to and from tags
- 22. **UHF 3** - LED indication for transmitting and receiving data to and from tag sensor
- 23. **UHF 4** - LED indication for communication with a base station unit.
- 24. **LF ant 1-4** – LED indication of antenna activated on the unit

Warnings

Battery - Risk of explosion if battery is exposed to extreme heat

Exposed wires – Risk of shock when touching exposed wires

Water Exposure- Risk of shock when touching the unit exposed to water

3.5. 1 Channel Exciter

The 1 channels locator is a unit that has 2 main functions:

- Generate 1 RF-Zone using an internal 125 KHz transmitter. The 1 channel exciter's channel carries a unique number as an identifier to the location/area where the RF-Zone is operates.
- Function as a repeater to tag's transmissions, relaying it toward the Base-Station unit.
Independent unit – the gate locator can function and connect to a server.

Technical details:

Power	
Power supply	24 VDC
Maximum current consumption	0.6 A (recommended to use 24V 1.5A minimum power supply)
Backup battery	None
Fuse	1.6A PTC
Air interface	
UHF interface	3 X 433 MHz, 1 X 869.85/916 MHz
UHF range	Up to 25 m
LF interface	1 X 125 KHz
LF range	0 – 10 m
Host interface	
USB	1 X RS232 (115.2 Kbps)
Ethernet	None
Wi-Fi	None
GPRS	None
I/O interfaces	
Relays	1 normally open relay contacts. 250 VAC/5A each
Inputs	1 low level signal analog/digital inputs
LEDs	6 X LEDs
Memory	
EEPROM	128 MB
Flash	128 MB
Environmental	
Operational temperature	-10°C ÷ +45°C
Storage temperature	-20°C ÷ +70°C
Dimensions and weight	
Dimensions	Diameter 185 mm Height 60 mm
Weight	0.48 Kg

LT-D-0211 rev 16

LF Antennas power settings:

For the LF antenna you can configure via software, the output power at range of between 10 to 100%.

Service instructions

The unit must be kept away from metal, heat (above 60 ° Celsius \140 Fahrenheit) and water.

Cleaning instructions

No cleaning is required

Wiring instructions

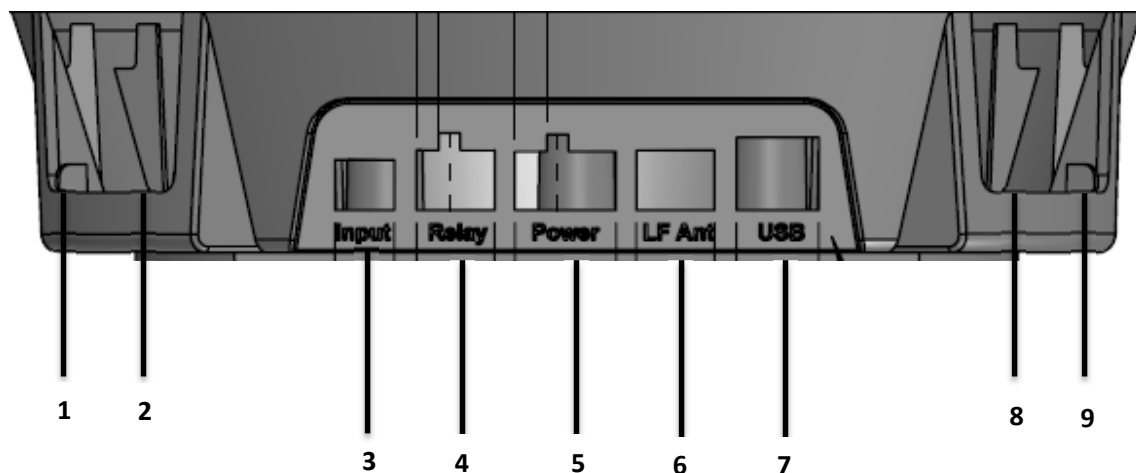

Connections

1, 2, 8, Connect a UHF 433 MHz antenna

9, can be either:

- 916MHz (USA,IL)
- 868Mhz(Europe)

3. **Input** –

4. Relay - see [Relay \(Dry contact\) connection](#) section.

5. **Power** – connect the unit to the power socket by using 24v adaptor

6. **LF antennas** – connect the LF cable antenna to the port –when connecting the external antenna to this port, the internal antenna will be deactivated

7. **USB** – connect a USB cable to connect to the low level controller.

LT-D-0211 rev 16

Front panel indications:

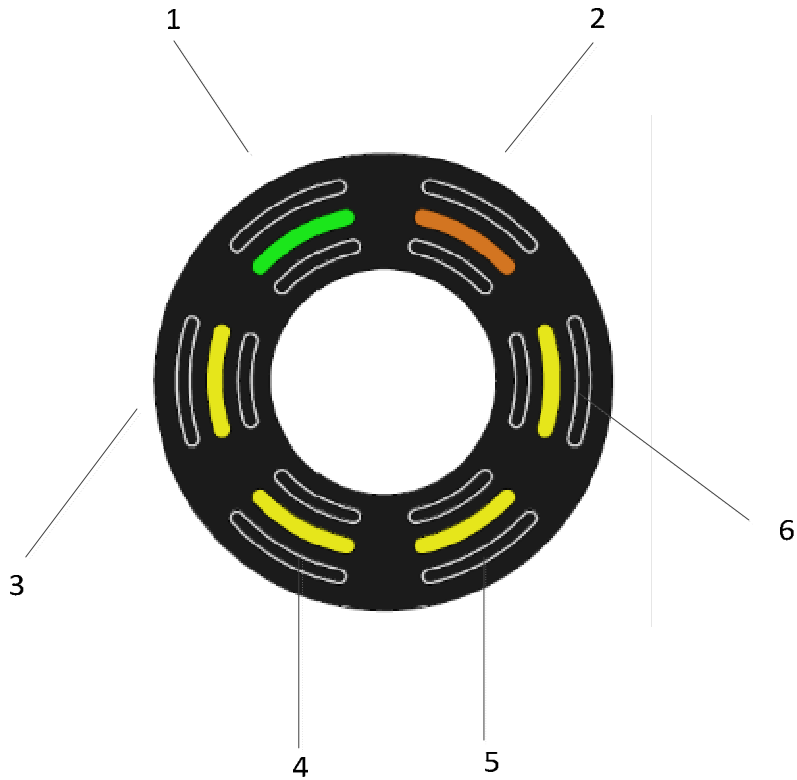

1. Power on
2. Tag identifier
3. Receive UHF from tags
4. Transmit UHF to tags
5. UHF Rx\Tx to sensor tag
6. Communicating with Base station/4 channel Exciter

Warnings

Exposed wires – Risk of shock when touching exposed wires

Water Exposure- Risk of shock when touching the unit exposed to water

3.6. Remote Door indicator

The Remote door indicator functions as a wireless LEDs driver device, activated remotely by UHF command from the base station\Gate Locator.

Technical details:

Power	
Power supply	24 VDC
Maximum current consumption	0.3A
Backup battery	500mAh rechargeable
Fuse	0.5A PTC
Air interface	
UHF interface	1 X 433 MHz
UHF range	Up to 25 m
LF interface	None
LF range	None
Host interface	
RS232	None
Ethernet	None
Wi-Fi	None
GPRS	None
I/O interfaces	
Relays	1 normally open relay contacts. 30 VDC/1A – not for use
Inputs	None
LEDs	External connection to LEDs device, up to 4 high current LEDs; Each can drive up to 200mA
Memory	
EEPROM	1 MB
Flash	None
Environmental	
Operational temperature	-10°C ÷ +45°C
Storage temperature	-20°C ÷ +70°C
Dimensions and weight	
Dimensions	L X W X H - 141X 67X 38 mm
Weight	0.13

LT-D-0211 rev 16

Connectors:

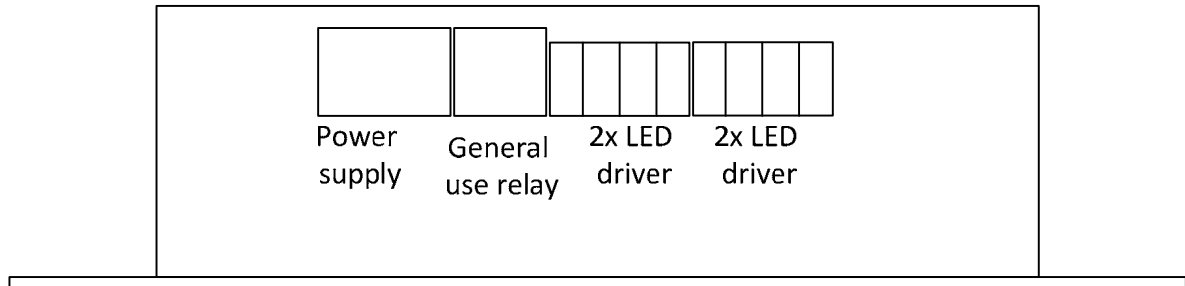

LT-D-0211 rev 16

Backup battery replacements

Contact your local support or Logitag customer support.

Installation instructions

This device is wall mount – connect the enclosure to the wall using 4 screws.

Service instructions

The unit must be kept away from metal, heat (above 60 ° Celsius \140 Fahrenheit) and water.

Cleaning instructions

No cleaning is required

Wiring instructions

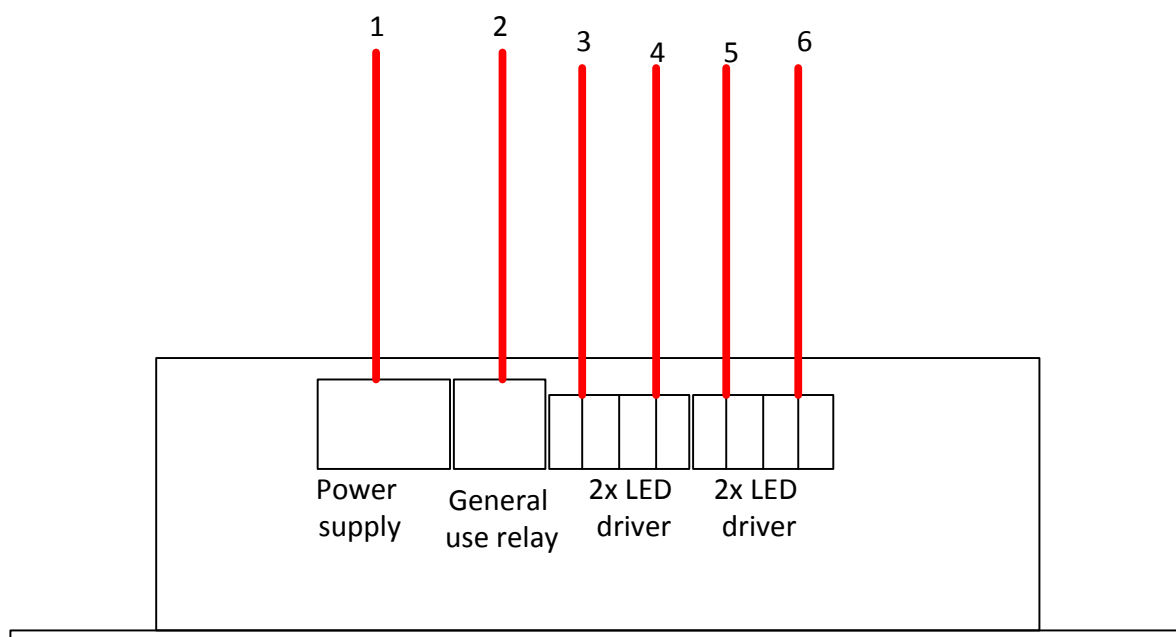

1. power supply (left pin +Vcc , right pin ground)
2. general use relay, normally open contacts – **not for use**
3. led driver 1 (left pin cathode, right pin anode)
4. led driver 2 (left pin cathode, right pin anode)
5. led driver 3 (left pin cathode, right pin anode)
6. led driver 4 (left pin cathode, right pin anode)

LT-D-0211 rev 16

Warnings

Battery - Risk of explosion if battery is exposed to extreme heat

Exposed wires – Risk of shock when touching exposed wires

Water Exposure- Risk of shock when touching the unit exposed to water

3.7. LF antennas

LF antenna generates RFID zones by transmitting in a frequency of 125 KHz and sending data. By generating the RF zones, a tag that is in the range of the detection area of the antenna, is excited and receives data transferred from the unit through the RFID field and eventually to the tag. Once the tag is excited, the tag starts to transmit on UHF band, directly to the main unit. After the tag has transmitted to the unit and receiving process has been made, the unit sends a confirmation signal on UHF band to the tag and confirming that the data has arrived.

The antenna installation should be in the correct angle (described in the next section), which affects the reception area of the tags.

By locating the antenna in correct position, the system enables a wide detection range.

3.6.1 Ceiling antenna

Technical details:

Air interface	
LF interface	125 KHz
LF range	0 – 10 m
Environmental	
Operational temperature	-10°C ÷ +45°C
Storage temperature	-20°C ÷ +70°C
Dimensions and weight	
Dimensions	Diameter 178 mm Height 56.5 mm
Weight	0.43 Kg

LT-D-0211 rev 16

Installation instructions

The antenna can be installed in one of the next options:

1. Mounted to the wall – opening the top of the box and inserting two screws
2. Shelf – installed on a shelf extension, antenna in horizontal angle

Service instructions

The Antenna must be kept away from metal, heat (above 60 ° Celsius \140 Fahrenheit) and water.

Cleaning instructions

No cleaning is required

Wiring instructions

Connect the antenna to the LF port and to the unit

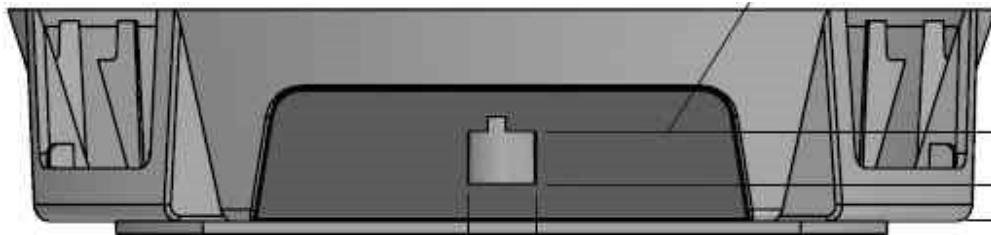

Warnings

Exposed wires – Risk of shock when touching exposed wires

Water Exposure- Risk of shock when touching the unit exposed to water

3.6.2 Door antenna

Technical details:

Air interface	
LF interface	125 KHz
LF range	0 – 5 m
Environmental	
Operational temperature	-10°C ÷ +45°C
Storage temperature	-20°C ÷ +70°C
Dimensions and weight	
Dimensions	Diameter 100 mm Height 43 mm
Weight	0.16 Kg

LT-D-0211 rev 16

Installation instructions

The antenna can be installed in one of the next options:

1. Mounted to the wall – opening the top of the box and inserting two screws
2. Shelf – installed on a shelf extension, antenna in horizontal angle
3. Antenna holder – connect the antenna holder by opening the top of the antenna box and connecting the holder. After connected to the antenna connect the holder to the wall.

Service instructions

The Antenna must be kept away from metal, heat (above 60 ° Celsius \140 Fahrenheit) and water.

Cleaning instructions

No cleaning is required

Wiring instructions

Connect the antenna to the LF port and to the unit

Warnings

Exposed wires – Risk of shock when touching exposed wires

Water Exposure- Risk of shock when touching the unit exposed to water

3.6.3 Antenna installation examples

1. LF antenna installation on door – facing down

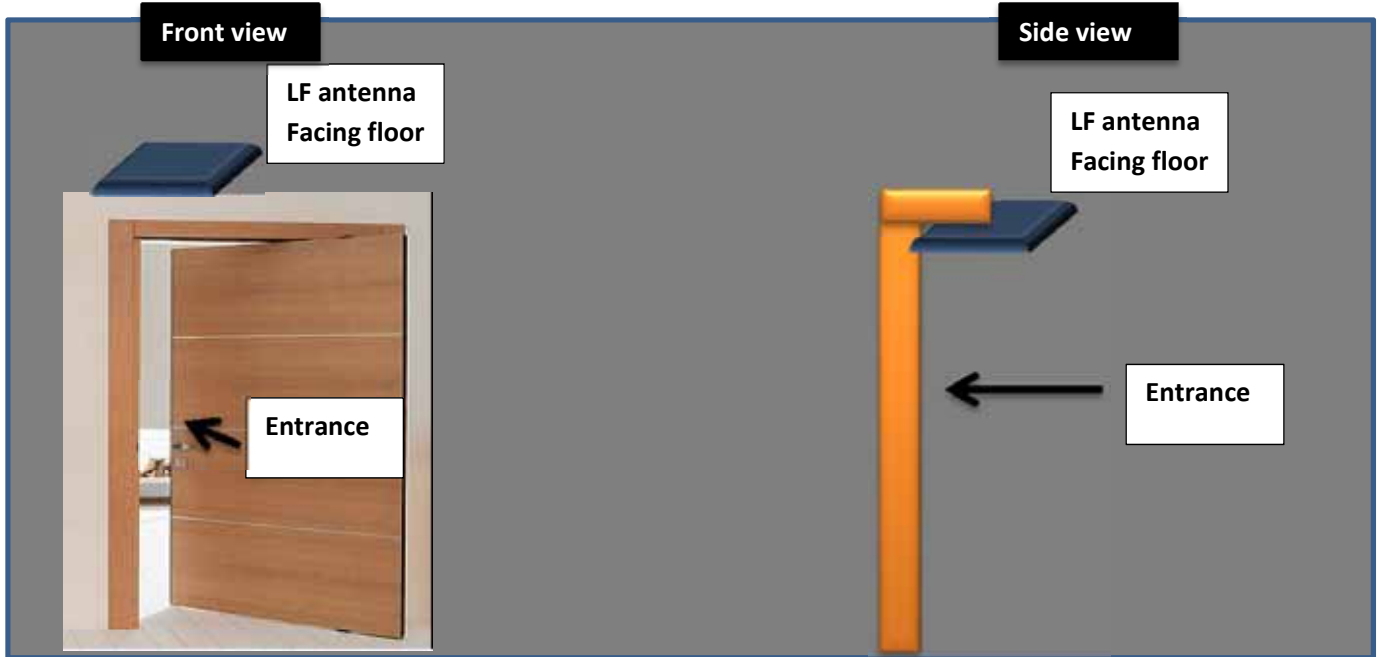

2. LF antenna installation on door – gate entrance

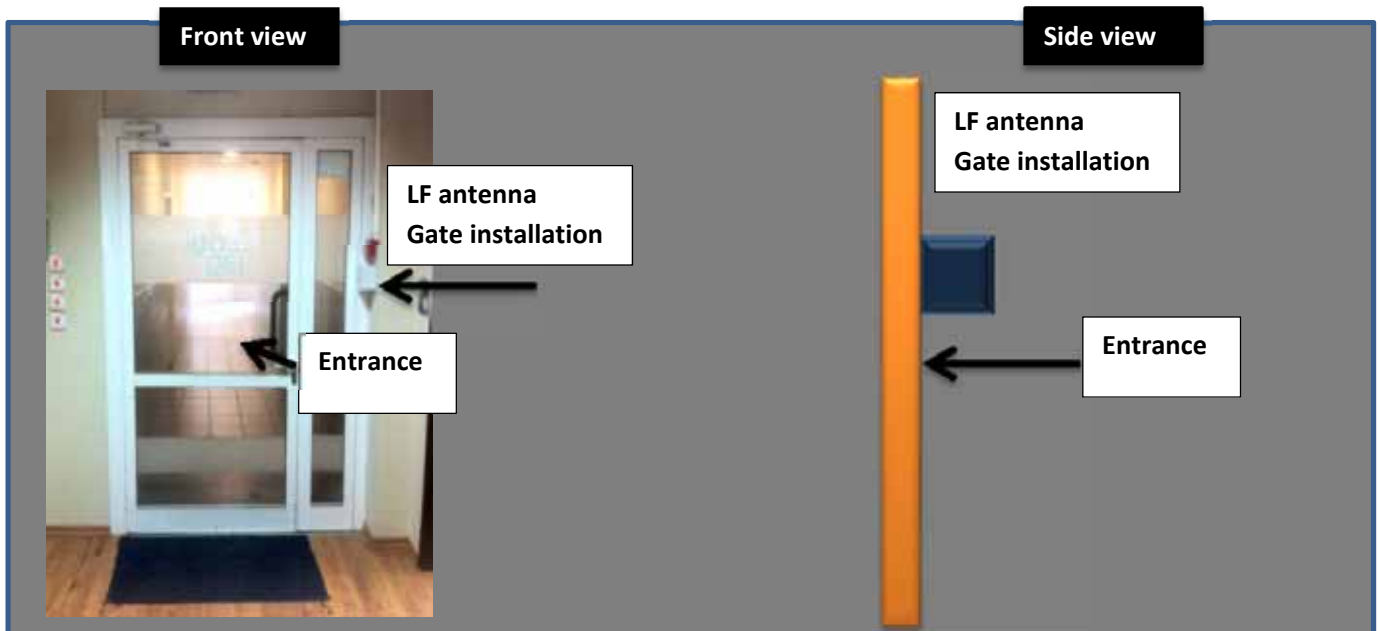

3.7 Tags

3.7.1 General

The LogiTrack tags are small and sophisticated transceivers.

A LogiTrack tag is typically dormant until 1 of the following happens:

1. The tag is excited when entering a RF-Zone generated by the LogiTrack infrastructure (Base-stations or exciters). This RF-Zone is created using a signal in 125 KHz, which the tag receives. As a result, the tag will wake-up, and transmit over UHF channel (433 MHz) its unique identity and the identity of the RF-Zone it just entered into.
After sending the message over the UHF channel, the Gate locator is able to exchange data with the tag through direct, bi-directional communication.
2. The tag takes the decision to send a message over the UHF band due to internal decision (usually sensor/timer based), or user interaction. For example:
 - a. The user pressed a button on the tag
 - b. The temperature sensed by the sensor exceed the threshold and requires raising an alarm
 - c. Motion was detected by the sensor
 - d. Tampering/removal was detected by the sensor

There are several tag options – different tag electronics in different plastic enclosure. Every tag can be used in any application where it delivers the required performances and operability, yet the majority was designed to answer specific applications.

#	ITEM	SENSORS			DESCRIPTION
		Motion	Tamper	Buzzer	
LTT-01	Round Tag				Designed for covert attachment to visitor badge.
LTT-02	Asset Tag NG	✓	✓	✓	New design, with cradle, all sensors and internal buzzer
LTT-03	Resident tag	✓	✓		Wristband tag with tamper detection and panic button
LTT-04	Asset tag – Panic	✓	✓		Asset tag with single button
LTT-05	Asset tag - Status	✓	✓		Asset Tag with 3 buttons for general status indications
LTT-06	Temp Tag Advanced	✓	✓		Asset Tag with external PT-1000 temperature sensor
LTT-07	Vehicle tag	✓			IP65 vehicle tag, attached with screws or adhesive
LTT-08	Staff Tag	✓	✓	✓	Staff ID tag with LCD, tag interrogation and 3 buttons



Tags technical details

Tag	Dimensions	Battery supply type	LF range	UHF range	Operational temperature	Storage temperature
LTT-01	Diameter 40mm Height 12 mm	Primary 3V	3 meters	20 meters	-10 - +45C	-20 - +70C
LTT-02	L X W X H 85X54X7.2 mm	Primary 3V	4.5 meters	25 meters	-10 - +45C	-20 - +70C
LTT-03	L X W X H 55X35X13 mm Adult one-size fits all wrist band (configurable)	Primary 3V	4.5 meters	9 meters	-10 - +45C	-20 - +70C
LTT-04	L X W X H 85X35X12 mm	Primary 3V	3.5 meters	25 meters	-10 - +45C	-20 - +70C
LTT-05	L X W X H 85X35X12 mm	Primary 3V	3.5 meters	25 meters	-10 - +45C	-20 - +70C
LTT-06	L X W X H 85X35X12 mm	Primary 3V	3.5 meters	25 meters	-10 - +45C	-20 - +70C
LTT-07	L X W X H 80X54X19 mm	Primary 3V	4 meters	25 meters	-10 - +45C	-20 - +70C
LTT-08	L X W X H 94X61X6.5 mm	Rechargeable 3.7-4.2V	3.5 meters	25 meters	-10 - +45C	-20 - +70C

Staff tag functionality:

3.7.2 Attaching tags to objects

Tags attached to objects especially electrical objects such as computers, laptops, servers trucks and different metals such as metal boards and etc., can cause RF disruption on tags transmission.

The disruption affects the ranges and transmission of the tag. In order to adjust the system an optimal location of the tag must be located by testing the tag on a variety of locations on top of the object and locating the optimal location.

For example the optimal location on an IPAD of an Opto type tag, is on the top right side of the IPAD.

3.7.3 Staff tag functionality

Staff tag has the following buttons and indications:

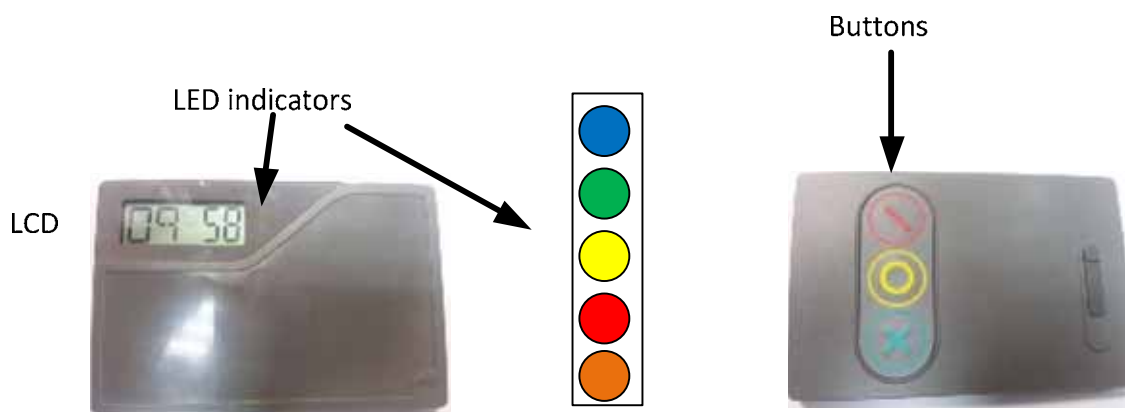

Staff tag has the ability to excite any other tag from 1m radius (in addition to the regular functionality explained above).

When pressing on the green button the tag creating a near field signal at 125KHz. if there is other transponder at its range the tag awakes and transmitting to the exciter/base station. The staff tag get respond from the exciter/base station with message view at the LCD. Message can be any type of up to 5 characters.

When pressing on the red and yellow button, the tag transmits the exciter/base station to the sensor antenna.

Led indicators:

Blue – battery charging

Green – replay from exciter/base station

LT-D-0211 rev 16

Yellow – pressing on yellow button

Red – pressing on red button

Orange – LF signal transmitting/receiving

3.8 System Ranges

System ranges is divided for three categories:

- **LF range** – the LF antennas generates RF zones which can detect and excite RFID tags from 0-7 meters. The ranges change when the tags are attached to an electrical\metal object.
- **UHF range**- the UHF range is generated by the unit that receives the tags info after the tag has been detected and excited in the LF RF zone. The ranges can be from 0 -25 meters from the tag to the unit.
The ranges change when the tags are attached to an electrical\metal object.
- **UHF range between units**- communication between the base station and the gate locator is through UHF band (which is different from the UHF band of the tag to gate locator).
The ranges are from 0 – 25 meters from one unit to another.
Environmental disruptions such as concrete with metal surrounding or electrical environment can cause reduction ranges.

Condition/ Range field	Components	Open space (meters)	Tag attached to electrical object (meters)
LF range	Antenna → tag	0 to 7	0 to 4 meters
UHF range	Tag → Gate Locator	0 to 25 meters	0 to 10 meters
UHF range between units	Gate locator → Base station	0 to 25 meters	-----

4. General Warning and instructions

LF cable – permitted LF cable type is (provided by LogiTag systems):

- **General Construction:** One twisted pair, cabled together with a drain-wire and overall aluminum-foil shielded.
 - **Conductor Size:** 7x0.32 mm
 - **Outer Jacket Material:** FR-PVC
 - **Outer Diameter:** 4.6 mm nom
- **Installation of the cable and units must be separated from communication and electricity infrastructure**
- Do not connect or cross 2 cables
- Make sure that cable polarity is equal on both ends as described in the picture



4.1 Relay (Dry contact) connection

The system enables to connect a device that can be connected to the power supply of the unit (24V), such as a buzzer or a light, connect it to the relay connection and the device will be activated when a tag is detected in the LF antenna range.

- Relay number 1 will be activated when antenna number 1 will detect tags
- Relay number 2 will be activated when antenna number 2 will detect tags
- Relay number 3 will be activated when antenna number 3 will detect tags
- Relay number 4 will be activated when antenna number 4 will detect tags
- Relay number 5 will be activated when **a sensor** will send a signal to the unit

LT-D-0211 rev 16

Connection sketch:

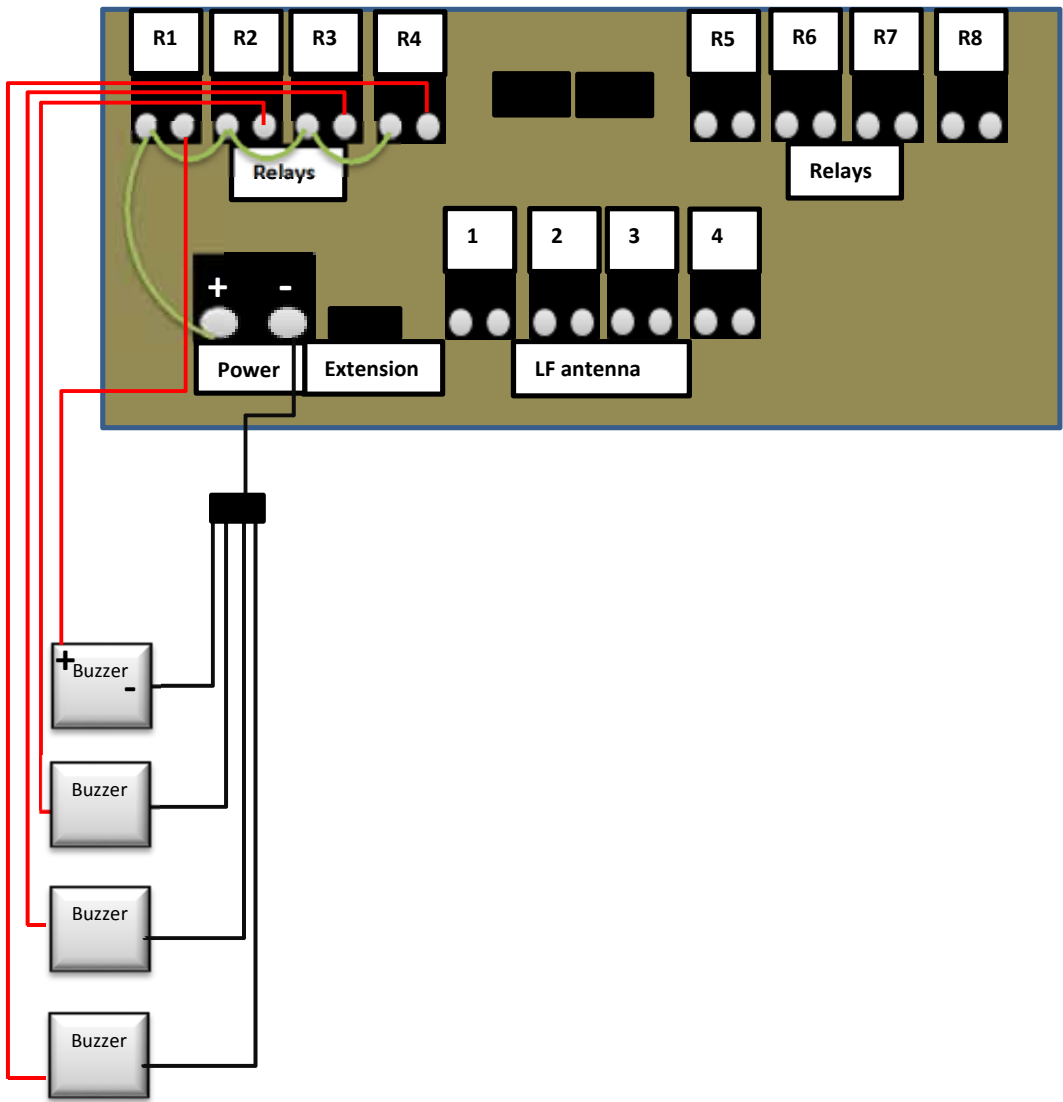

LT-D-0211 rev 16

Picture 1:



Picture 2:

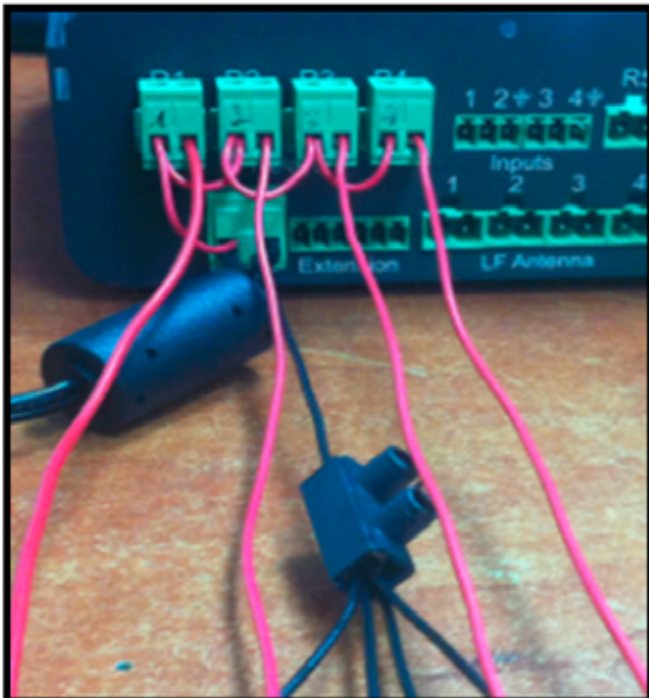

5. Infrastructure and data flow sketch

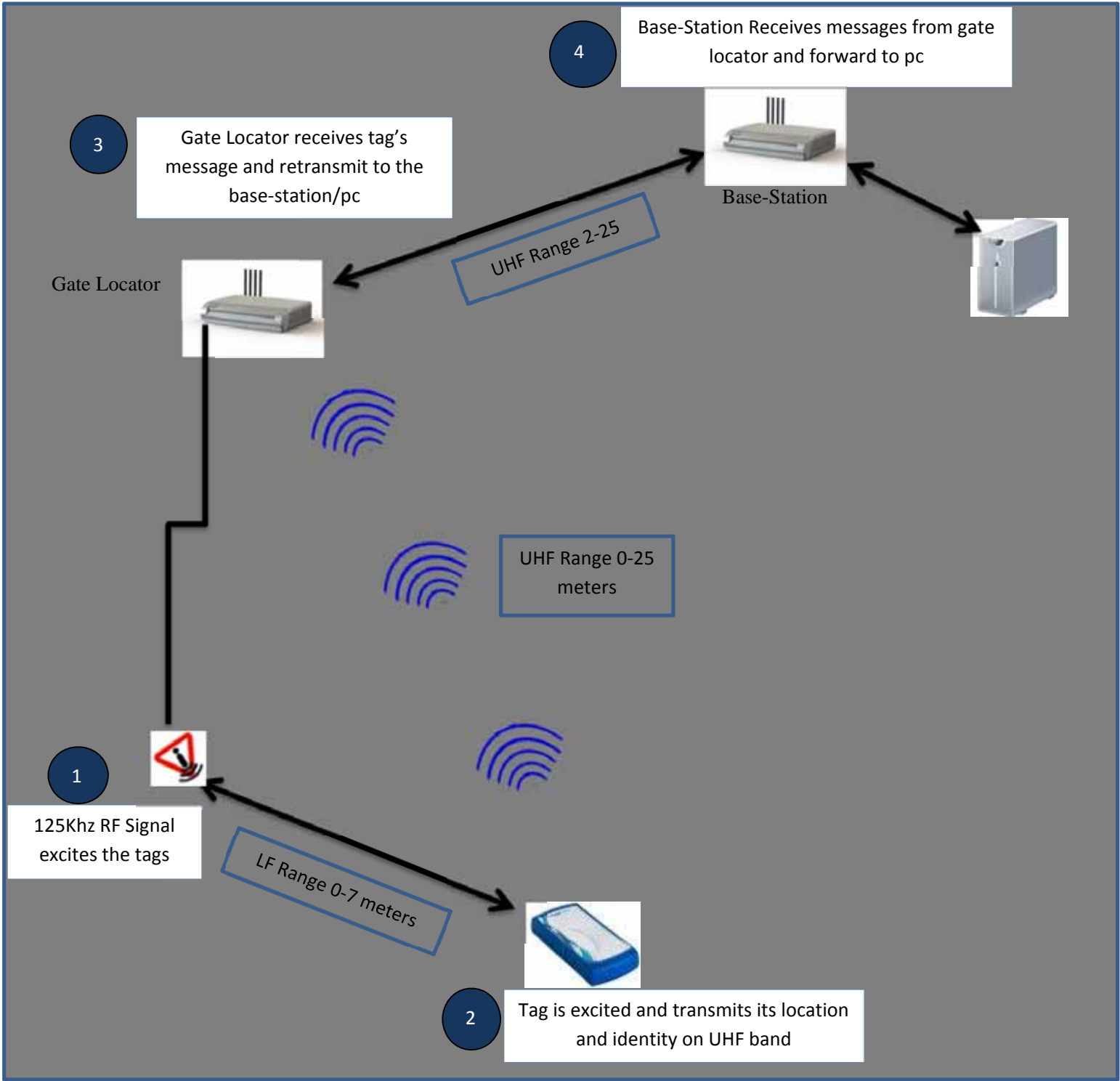

LT-D-0211 rev 16

5.1 Site installation example

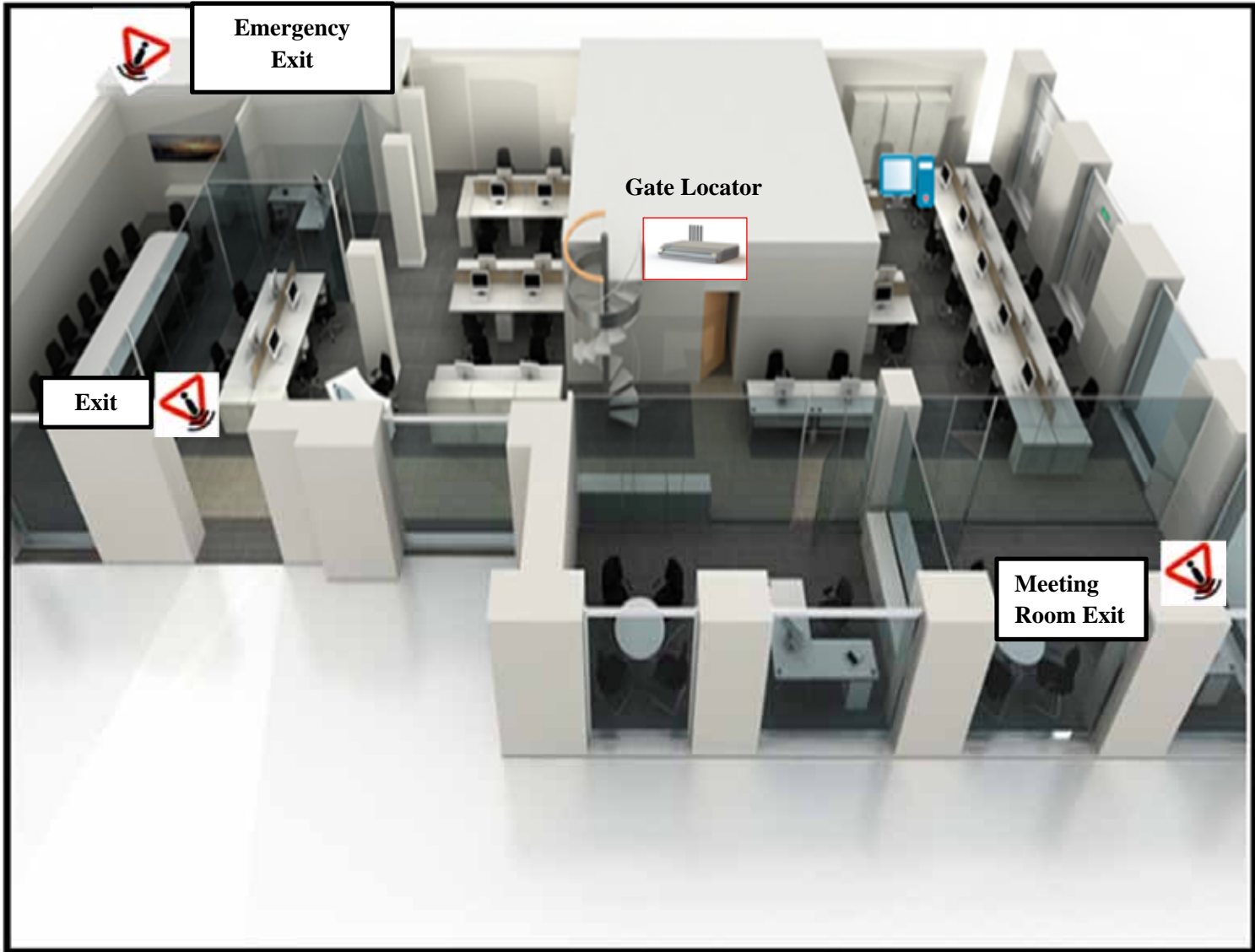

6. Software Installation

6.1 Installing the Technician-Station

- Ensure that the PC you are about to install the software on is running Windows XP or Windows 7, preferably from Professional edition and up.
- Install on the computer Microsoft .NET Framework 4.0 available from Microsoft's website.
- Execute the installation file "Setup.exe"

Running the Technician-Station software

- Locate the executable file "LogiTrackTechStation" at the designated destination folder.
- Run the executable file

Interfacing with a Base-Station

Connect the USB cable to the USB 1 connection.

Connect the USB cable to your PC.

Install the USB to RS232 converter driver provided by LogiTag (if windows have not installed the driver automatically)

6.2 Software Operation

After launching the application, the welcome screen is shown first.



6.3 Application Structure

The Technician-Station includes the following modules, each in a separate tab:

- **“Connection” Tab** – Enables managing connections to 1 or more Base-Stations\Gate Locators, through USB connection.
- **“Base Station Setup”** – Enables configuration of every programmable parameter in a connected Base-Station. The tab also enables configuring Gate Locators that are relayed through every Base-Station.
- **“Tag Setup”** – Enables activating and configuring the LogiTrack tags, including their specific sensor based features.
- **“Enrollment”** – Enables defining assets and people with their specific identifiers and information, and assigning them to a specific tag.
- **“Detection”** – Shows a list of all tags currently received by the application through any of the connected Base-Stations. The list is manageable and can be filtered and sorted.
- **“Base Station Operations”** – Enables interfacing the Base-Station’s I/O.
- **“Reports”** – Enables reviewing reports for more detailed data, and optionally export the information to Excel file format.
- **“LOG”** – Shows raw data received from connected Base-Stations
- **“Administration”** – General application settings and interfacing with 3rd party software

6.4 Connecting to a unit

6.4.1 Adding a Base-Station

To add a Base-Station

- Select the Connection tab from the tabs list
- The following tab is displayed:

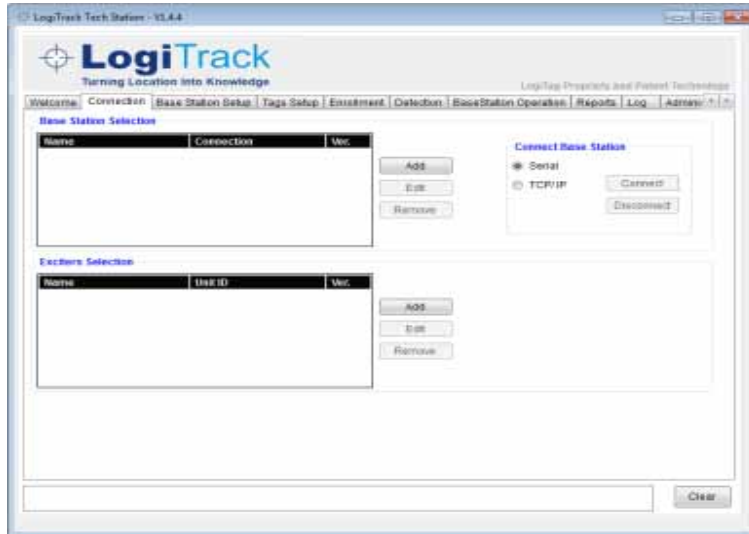

- Press the Add button.
- The following windows appear:

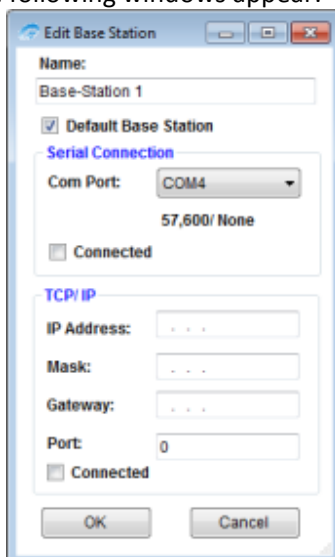

- Specify the following parameters for the Base-Station you are adding.
Name: Specifies an alias for the Base-Station you are adding.

Default base-Station: Check this box to make the Base-Station the default one in the application, if more than 1 is connected. Making a Base-Station the default one will undo any previously selected Base-Stations.

Serial Connection

Com Port: Select from the drop-down list the Com-Port on which the Base-Station is connected.

Connected – Check this checkbox to mark that Connection is a valid connection method.

- Press OK to finish the first step in connecting a new Base-Station

6.4.2 Adding a Gate locator

From the Connection tab press the Add button located at the Exciter Selection section.

The following window appears

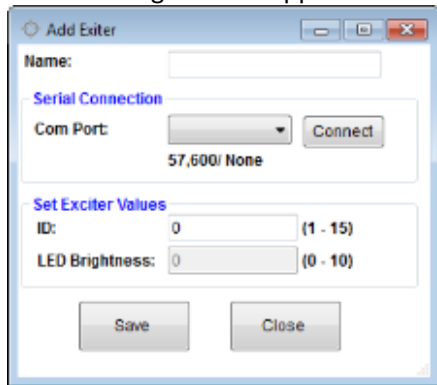

Choose the comport and click on connect if the unit is connected to the computer. If the unit is not connected the unit ID will not be saved **on the unit**.

6.4.3 Defining a unit ID to the Gate Locator

If this is the first time using this Gate Locator, you might want to assign it with a unique Device-ID for your system:

- Connect the Gate Locator to your computer using a USB cable
- Select the Com-Port from the drop-down list and press the Connect button.
- Set the Exciter ID value to a unique number and press the Save button.

When finished the unit will be saved. In order to add the unit to **the base station** move to "Base Station" tab and perform the following (note that the base station has to be connected):

1. From the "Base Station" drop down list, select the Base-Station through which the Exciter is to communicate (nearest installed Base-Station).
2. Press the "Add Exciter" button. The following window appears:



- From the “Name” drop-down list, select the Exciter you wish to add to this Base-Station (only Exciters added according to steps 1 & 2 of this section will appear in this list) and configure the exciter’s LF ports.

Note

For detailed explanations on Antenna ports configuration, see Defining RF-Zones (LF Antennas) in Base Station Configuration section Tab.

- Press the “OK” button to finish the operation.
- Click Set bottom in order to transfer the data to the base station.

6.4.4 Viewing Connectivity Status

The Base Station Selection list on the Connection tab shows all the Base-Stations that were added to the application and their current connectivity status.

The possible connectivity statuses are:

“Not Connected” (Red background) – Indicates that the application is unable to connect with the Base-Station.

Name	Connection
Base-Station 1	Not Connected

“Not Connected” (Yellow background) – Indicates that the Base-Station is not connected because of user-decision (“Disconnect” was pressed).

Name	Connection
Base-Station 1	Not Connected

“Serially Connected” – Base-Station is connected via serial connection

Name	Connection
Base-Station 1	Serially connected

LT-D-0211 rev 16

Changing Connectivity Status

- The Change the connectivity status, a user can:
- Press “Disconnect” to pause the connection to the Base-Station, regardless of the interface used
- The Base-Station’s status will change to “Not Connected” (Yellow background).
- Press “Connect” to restore connection
- The Base-Station status will change back to serially/TCPIP connected, depending on the interface configuration.
- Press “Edit” to open back the Edit Base Station window and possibly alter connectivity settings.

6.4.5 “Base-Station Setup” Tab

Selecting a Base-Station for Configuration Setup

With only 1 Base-Station Defined

As soon as switching to the “Base-Station Setup” tab, the Technician-Station application will retrieve from the single base-station currently defined the value of all parameters, and populates the data in the tab.

Operators of the applications should be aware that the data seen in this tab is the data currently defined in the Base-Station, and that any change should be saved in order to take effect.

Note – if the values seems not be loading by default into the text fields, it is most likely that the Base-Station is simply with factory defaults, which are probably zero values.

With more than 1 Base-Station Defined

When switching to the “Base-Station Setup” tab the Technician-Station application will retrieve the values from the Base-Station defined as default in the system.

To retrieve values for another Base-Station and enable them, users can select the desired Base-Station from the “Base Station” drop down list.

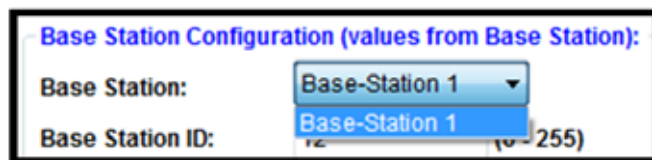

6.4.6 RF zones (Lf antennas) configuration

Each **Gate Locator** includes 4 ports of LF (Low-Frequency, 125 KHz) antennas, used for exciting tags (causing them to transmit). The tag will report to the base-station the identity of the antenna that excited it, so the Base-Station\Gate Locator can report where the tag is located.

The Technician-Station provides the system administrator with the ability to configure the Base-Station's ports, specifically the following parameters:

1. Enable/Disable the port – The system administrator may choose to enable 1 or more ports, depending on the deployment required.
2. LF TX Power – The power in which the Base-Station transmits the LF signal can be fine-tunes, thus affecting the range and diameter of the RF-Zone created from the antenna. The power is determined in percentage, at steps of 10% (10-100%).

In addition the following parameters can be determined:

- Antenna name – For continece, the administrator can change the default names "port 1" – " port 4" to names that better represent the location in which the antenna is installed, e.g. "meeting room", "Floor 1 elevators" etc.
- Tag UHF Power – When a base station is excited through a specific channel, the Base-Station is able to respond to the tag and modify its UHF transmission power. This value is determined in dbm, between 1 (min) to 20 dbm (max, default).

Available Antennas:			
Available:	Antenna Name:	LF Tx Power (%):	Tag UHF Tx Power (dBm):
Port 1: <input checked="" type="checkbox"/>	Meeting Room	100	20
Port 2: <input checked="" type="checkbox"/>	Floor 1 Elevators	70	20
Port 3: <input checked="" type="checkbox"/>	Port 3	50	20
Port 4: <input checked="" type="checkbox"/>	Port 4	80	20

6.4.7 Advanced Operational Parameters

The Technician-Software provides an interface to enable configuring several advanced operational parameters of the Base-Stations. These parameters should be left in their default value, unless a change is required.

Please consult with LogiTag’s Support before changing one of these values:

- Base-Station ID – A unique identifier of the Base-Station in a specific project. The default value is determined in LogiTag’s during production in accordance with known IDs already active.
- Mode :
 - Inventory- this mode defines that the unit will not be active until order has been sent to perform an inventory count from the base station.
 - Gate – this mode defines that the unit will be active and every tag that will be located in the RF zones will be detected.
- Tag TX UHF Channel (0-3)-To enable better usage of the UHF band, different Base-Stations may be set to various channels, thus reducing chances of collisions.
- Zero Tags Count – An operational parameters used in tags anti-collision algorithm. Default (and recommended) value is 0 (zero), higher values will increase Base-Station’s chances to receive all tag, but at lower speed.
- LED Brightness – Set the brightness of LED on the Base-Station’s front panel. Can be dimmed to reduce visibility in some installations.
- UHF TX Power- defines the power that the tag will transmit to the unit once detected in the RF zones.
- TX Interval – defines the amount of transmission that the tag will transmit to the unit per second.
- Max Tx- defines the number of transmission that the tags will transmit to the unit.

BaseStation Configuration (default values):

Base Station:

Base Station ID: (0 - 255)

Mode: Gate Inventory

Tag Tx UHF Channel:

Zero Tags Count: (0 - 15)

LED Brightness: (0 - 10)

UHF Tx Power (dBm):

Tx Interval: seconds

Max Tx:

Finalizing the Setup Process

LT-D-0211 rev 16

Upon completing setting values to all relevant parameters, the administrator can choose to save settings to the Base-Station by pressing the SET command.

The following message should appear to inform the user that the operation was completed successfully:

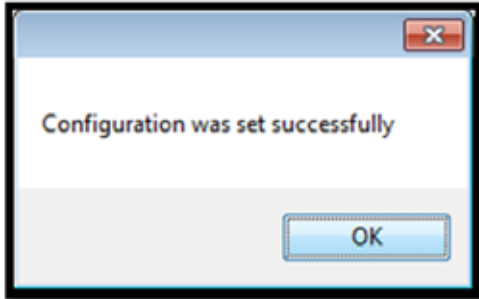

6.4.8 “Tags Setup” Tab

The Tags Setup tab provides the tool to configure tags with various operational parameters, primarily to enable various sensors and tune them to specific applications.

Selecting a Tag for Configuration Setup

In order to configure a tag, it must be excited through LF antenna and have communication with a Unit:

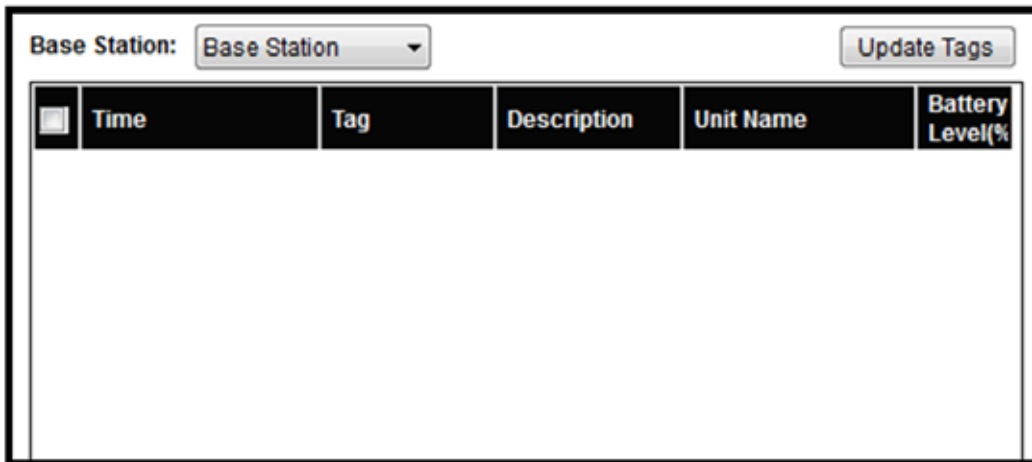

- Select the Base Station you are about to use for exciting the tag, from the “Select Base Station” dropdown list. It is recommended to use LogiTag’s technician Hardware for this purpose, as it includes Base-Station hardware and LF antenna in a single enclosure.
- Select the antenna port the tag will in front of during the setup process, from the “Select Location” dropdown list.
- Place the tag in front of the selected Base-Station\Antenna, and press the Update Tags button – the tag (or several tags) should appear in the list.

<input type="checkbox"/>	Time	Tag	Description	Unit Name	Batte Level
<input type="checkbox"/>	15/09/2013 13:19:59	3A15E8		Base Station	100
<input type="checkbox"/>	15/09/2013 13:19:58	6A9661		Base Station	100
<input type="checkbox"/>	15/09/2013 13:19:58	64112F		Base Station	100
<input type="checkbox"/>	15/09/2013 13:19:58	26A10C		Base Station	100
<input type="checkbox"/>	15/09/2013 13:19:57	268EA4		Base Station	100
<input type="checkbox"/>	15/09/2013 13:19:57	6AC839		Base Station	100
<input type="checkbox"/>	15/09/2013 13:19:57	6A7D80		Base Station	100

- Click the checkbox of every tag you wish to program in the current session

6.4.9 Sensors & tag definitions

The tamper sensor and status button indications for example, need to be enabled in supported tags.

To Enable sensors or define other parameters perform the following steps:

Note that a group of parameters can be set together in one command according to the group of commands (each group is marked by a different color) .

1. Press the Update button and select the tags to program from the list.
2. Change the Tamper software switch to the desired status.
3. Press the Send button to make the change in the tags.
4. Ensure you receive the confirmation message from the software
5. Press the Get button to read the actual status from the tag.

All tag parameters:

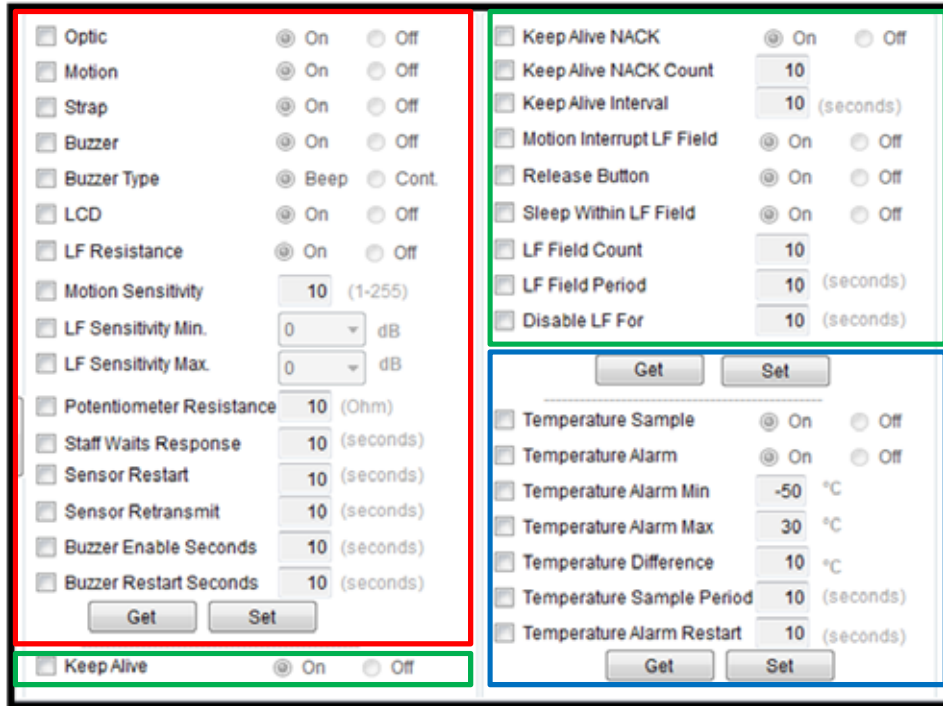

Managing Temperature Sensor:

Tags with temperature sensor can monitor the temperature sensed by the external PT-100 unit.

The tags include the following logic:

- Monitoring temperature thresholds: A tag can be configured to monitor the temperature compared with a Minimum and /or Maximum threshold.
- Sample period Reading: The tag can sample the temperature in fixed interval and send the value to a main server, where thresholds can be monitored.
To Set Minimum And / Or Maximum Thresholds

Preventing LF distractions

In some application and environment the LF signal may suffer from interferences that can cause 2 main issues:

- Unwanted tag activation (such as activating the buzzer in the tag)
 - Unwanted tag exciting that can be caused from electrical distractions such as servers or computers.
- To filter unwanted tag activation activates the LF Resistance parameter in order to avoid unwanted tag exciting.

6.4.10 “Enrollment” Tab

The Enrollment tab delivers a simple tool to define assets/people and associate them with a tag, enabling management of asset/people rather than tags.

Enrolling an Asset/People

1. Select the Base-Station from the Base Station Name dropdown list through which a tag will be read in the process
2. Press the Read button to get the tag number from the Base-Station. The tag’s number will populate the Tag ID parameter.
3. Select the Asset type
 - a. Select the Asset family from the dropdown list
 - b. Select the asset type from the dropdown list
 - c. Enter a description for the asset
 - d. Enter a serial number / ID number for the asset (if applicable)
4. Use an “Asset number” to enable easier management without long tag –IDs
5. To manually provide a number to each new asset, enter a number at the Item Number parameter.
6. To use an item number that automatically increments between assets
 - a. Check the Incremental checkbox
 - b. Enter the First Item Number value
7. Press the Save button to finish the operation, save the asset and its associated tag, and proceed to enrollment of a new asset.

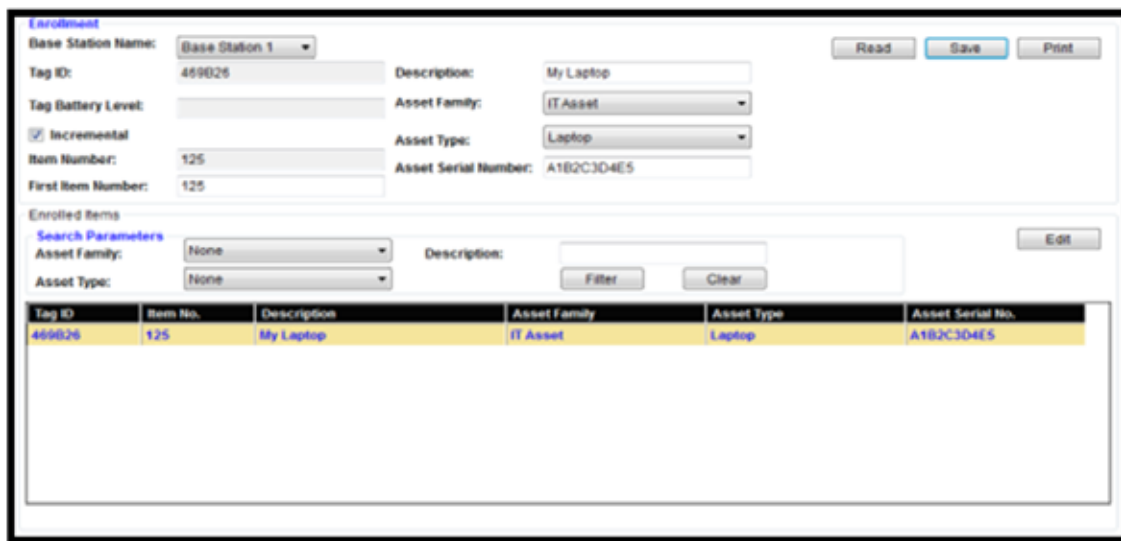

Enrollment

Base Station Name:

Tag ID: Description:

Tag Battery Level: Asset Family:

Incremental Asset Type:

Item Number: Asset Serial Number:

First Item Number:

Enrolled Items

Search Parameters: Asset Family: Description:

Asset Type:

Tag ID	Item No.	Description	Asset Family	Asset Type	Asset Serial No.
469026	125	My Laptop	IT Asset	Laptop	A1B2C3D4E5

Viewing Enrolled Assets

The Enrollment Tab also delivers the tools to manage the assets and modify their details.

To Search for a specific Asset

1. Select the Asset-Family and Asset-Type to narrow down the list of assets.
2. Locate the asset you are searching for in the list and click on it to select.
3. Press the Edit button to have its details appear on the top part of the tab.

LT-D-0211 rev 16

4. Edit the details as required, including association to a different tag, and press Save when you are done.

6.4.11 “Detection” Tab

The Detection tab shows a list of tags received by all Base-Stations currently connected (and selected) with the Technician-Station software.

Detected Tags List

The information shown in the list of detected tags:

- Count – The number of messages received from a tag in current session
- Time – Time and date of last message received
- Tag – ID of the tag being received
- Description – If the tag is enrolled with an asset, the asset description is displayed.
- Location – Shows the reason of transmission of the tag.
 - Tag transmitted because it was excited when located near one of the LF-Antennas (RF-Zones), the antenna name will be displayed
 - Tag transmitted because of sensor, button or external input. The exact reason will be displayed.
- Tamper – Shows True if the tag’s Tamper sensor reported a tamper event
- Motion - Shows True if the tag’s Motion sensor reported a tamper event
- Input - Shows True or False if the tag transmitted due to an even in the external input port. If the current status is ON, the indication is True, otherwise False.
- Key 1 – Key 3 – Indicated True if a button was pressed on the tag.
- Temperature Alarm – Indicated True if a threshold set in the tag was exceeded
- Temperature – Shows measured temperature in the tag’s sensor
- Tag Battery – The tag indicates its battery status with each transmission

The screenshot shows the 'Base Station Read Mode' interface. At the top, there is a 'Base Station' dropdown menu. Below it is a green indicator light. The main area is titled 'Detected Tags' and contains a table with the following columns: Select, Count, Time, Tag, Desc, Type, Unit Name, Location, Optic, Mofo, Key1, Key2, Key3, Key Release, D. C., and D.C. State. The table lists 15 rows of detected tags. At the bottom of the interface, there are buttons for 'Remove Selected', 'Filter Selected', 'Clear List', 'Clear Filter', and 'Export to Excel'. On the right side, there are two status indicators: 'Total Detected Tags: 1' and 'Total Tags: 97'.

Select	Count	Time	Tag	Desc	Type	Unit Name	Location	Optic	Mofo	Key1	Key2	Key3	Key Release	D. C.	D.C. State
<input type="checkbox"/>	3	15/09/2013 14:28:45	A4A4E3		Resident	2	Sensor			2					-
<input type="checkbox"/>	4	15/09/2013 14:28:43	A47BB7		Resident	2	Sensor			3					-
<input type="checkbox"/>	2	15/09/2013 14:28:36	6A84FA		Coin	Base Station	port 1								-
<input type="checkbox"/>	1	15/09/2013 14:28:36	39D4D0		Logitrack	Base Station	port 1								-
<input type="checkbox"/>	2	15/09/2013 14:28:36	6A8F51		Coin	Base Station	port 1								-
<input type="checkbox"/>	4	15/09/2013 14:28:36	3A0DC9		Coin	Base Station	port 1								-
<input type="checkbox"/>	2	15/09/2013 14:28:36	26A8A3		Logitrack	Base Station	port 1								-
<input type="checkbox"/>	1	15/09/2013 14:28:35	3A0103		Logitrack	Base Station	port 1								-
<input type="checkbox"/>	1	15/09/2013 14:28:35	39D3F8		Logitrack	Base Station	port 1								-
<input type="checkbox"/>	3	15/09/2013 14:28:36	26A10C		Logitrack	Base Station	port 1								-
<input type="checkbox"/>	3	15/09/2013 14:28:36	6A9661		Coin	Base Station	port 1								-
<input type="checkbox"/>	1	15/09/2013 14:28:34	3A0B27		Logitrack	Base Station	port 1								-
<input type="checkbox"/>	4	15/09/2013 14:28:36	26A405		Logitrack	Base Station	port 1								-
<input type="checkbox"/>	3	15/09/2013 14:28:35	269234		Logitrack	Base Station	port 1								-

To Filter Selected Tags and Manage Filtered Lists

LT-D-0211 rev 16

1. Select the checkbox of tags you wish to manage
2. Press the Remove Selected button to filter out the selected tags. These tags will not be shown in the list until filter settings are cleared
3. Press the Filter Selected button to filter out all unchecked tags. Unchecked tags will not be shown until the filter settings are cleared.
4. Press the Clear Filter button to restore back all tags filtered out.
5. Press the Clear List button to remove all tags from the list and have it re-populated with newly received tags only.

Detected Tags Indications

The Detection tab shows 2 indications about detected tags

- Tag detected – a green circle is showing for every tag message detected.
- Total Tag – Shows the total number of tags currently shown in the list
- Detected tags – Shows the number of tags detected by the Base-Station in its last scan.



6.4.12 “Base-Station Operation” Tab

The Base Station Operation tab enables the user to toggle the Unit's dry-contact relays.

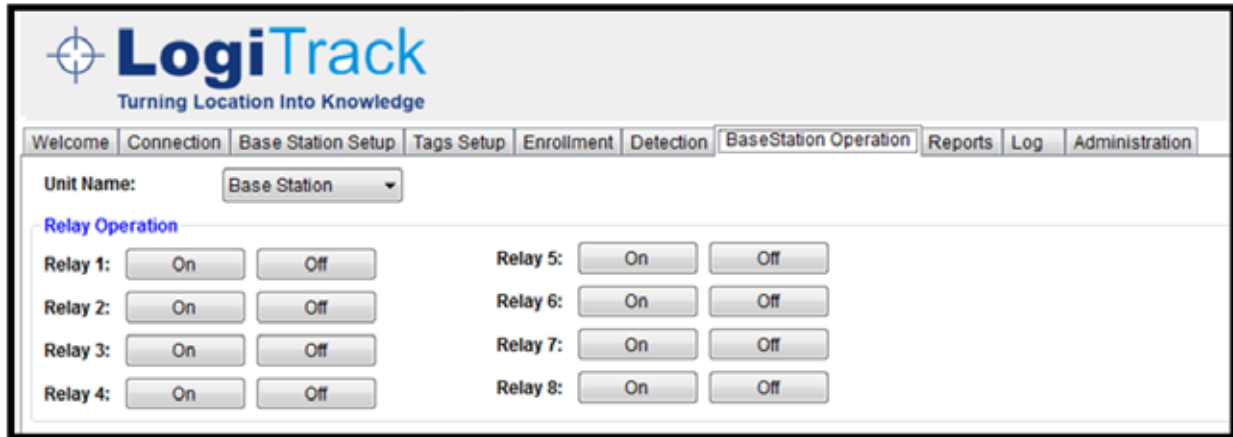

The screenshot shows the LogiTrack web interface. At the top left is the LogiTrack logo with the tagline "Turning Location Into Knowledge". A navigation menu includes: Welcome, Connection, Base Station Setup, Tags Setup, Enrollment, Detection, Base Station Operation (highlighted), Reports, Log, and Administration. Below the menu, there is a "Unit Name:" dropdown menu currently set to "Base Station". Underneath, a section titled "Relay Operation" contains eight rows, each with a relay label (Relay 1 through Relay 8) and two buttons: "On" and "Off".

To toggle a dry-contact relay

1. Select the Base-Station from the drop-down list
2. Press the On button for every relay you wish to toggle ON
3. Press the Off button accordingly.

6.4.13 “Reports” Tab

The Reports tab delivers several administrative reports that shows in depth detailed information to help manage the LogiTrack system.

Operating the Reports Tab

To Issue a report

1. Select a report from the list shown on the left panel
2. Press the Show button to display the report’s results
3. Press Export To Excel to have the results from the grid exported to an Excel file
4. Select the path to save the Excel file and press Save

Available Reports

Battery State Report - Shows all tags detected by the Technician station and their latest battery status.

Tag ID	Tag SN	Last Detection Time	Battery Level
298036		16-07-12 11:12 AM	2.95v
449826	1	16-07-12 11:10 AM	1.7v

Extended Detection Report – Shows a detailed list of all tags received by the Technician-Station, the date & time of their first and last detection, known sensors/inputs indications and other detailed information.

Tag ID	Tag SN	Tag Description	Tag Asset SN	First Detection Time	Last Detection Time	Base Station ID	Base Station Name	Location	Temp	Motion
298036				16-07-2012 11:...	16-07-2012 11:...	0	Base Station 1	Sensor		
298036				16-07-2012 11:...	16-07-2012 11:...	0	Base Station 1	Sensor		
449826	1	CEO Laptop	A1B2C3D4E5	16-07-2012 11:...	16-07-2012 11:...	12	Base Station 1	Port 1		
298036				16-07-2012 11:...	16-07-2012 11:...	0	Base Station 1	Sensor		
298036				16-07-2012 11:...	16-07-2012 11:...	0	Base Station 1	Sensor		
298036				16-07-2012 11:...	16-07-2012 11:...	0	Base Station 1	Sensor		

Enrolled Tags – Shows a list of all enrolled assets in the system, their details and associated tags.

Tag ID	Tag SN	Tag Description	Asset Family	Asset Type	Asset SN
449826	1	CEO Laptop	IT Asset	Laptop	A1B2C3D4E5

6.4.14 “Log” Tab

The Log tab displays raw data received from Base-Stations connected to the Technician-Station. The content of the information displayed in the Log tab is saved to files stored in Logs directory at the installation folder of the application (C:\Program Files\LogiTag\Technician Station by default).

7. Troubleshooting

7.1 Connectivity issues

7.1.1 Software connection

If a software connection is not able, check:

- Check that the unit is connected to the power and that LED lights are on.
- Check that the correct comport is selected. To view the correct comport enter the device manager
Right click on My Computer - Manage – Device Manger
On the right screen the comport number will appear (the number changes from one computer to other)

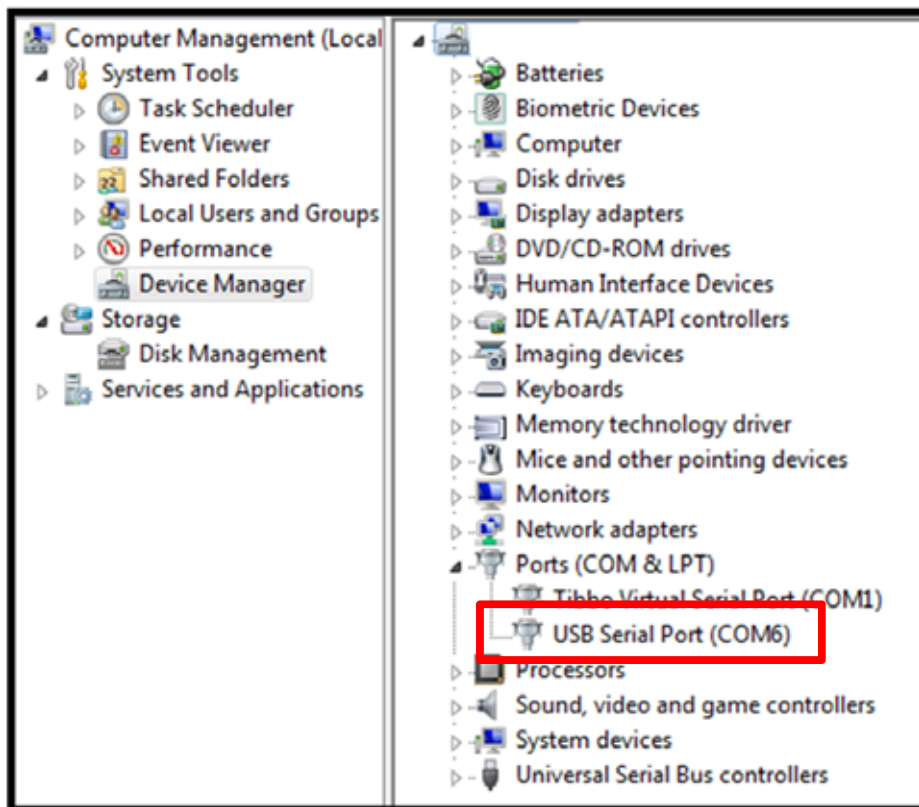

1. When finished go back to the technician software and choose the correct comport

7.1.2 Driver installation

If the USB driver is not installed properly on the device manager screen a notification of an Unknown device will appear:

1. In this case, install the driver again and check driver status again by performing the next steps:

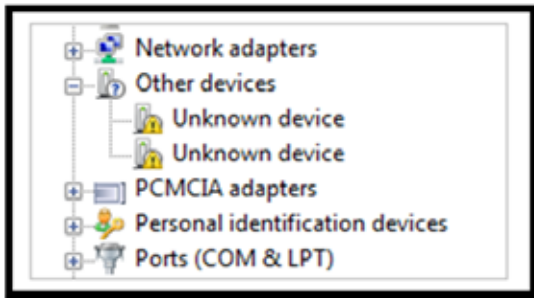

2. Right click on the unknown device and click on update driver software

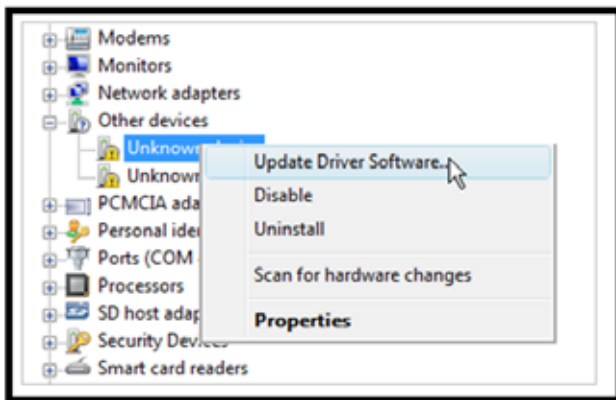

3. On the browse for the driver software on your computer, click on the browse button and browse to the folder which contains the driver provided on the CD provided from LogiTag.

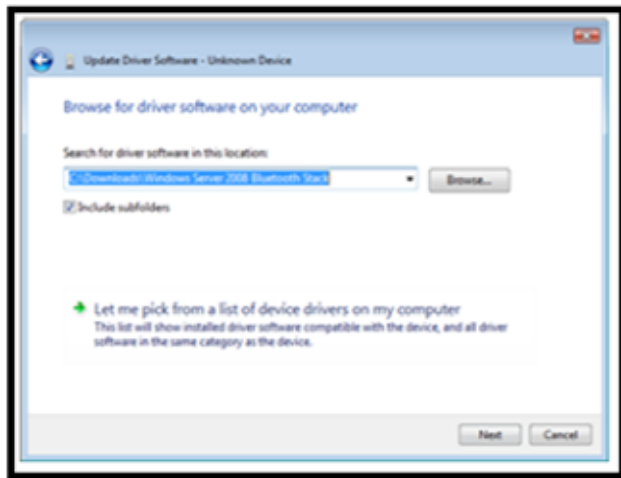

7.2 Hardware issues

7.2.1 LF signal does not transmits

In case that the unit does not transmits the LF signal check:

Installation of the cable must be separated from communication and electricity infrastructure

- Do not connect or cross 2 cables
- Make sure that cable polarity is equal on both ends as described in the picture →
- Check configuration through technician station as described on section [RF zones \(Lf antennas\) configuration](#)
- Check LED light on the antenna- open the top of the antenna's box and check if the LED light inside is on. In case the light is off, check the polarity on both ends or switch the antenna



7.2.2 Unit doesn't turn on

In case that the unit does not turn on check:

1. The power supply adaptor is connected
2. The connector that connects to the unit is connected properly and wires are connected.
3. If steps number 1 and 2 does not help change the power supply adaptor

7.2.3 The unit is on but no response

In case the unit is on and all LED lights are on but the unit does not detect RFID tags on LF field perform the next steps:

LT-D-0211 rev 16

1. Check that the LF antenna is activated as described on section- [LF signal does not transmits](#)
2. Check that all UHF antennas are connected to the unit (UHF 1-4)
3. Disconnect the power adaptor from the unit and connect back
When the unit is back on wait for 1 minute for all components to reset.
Click on **connect** through the technician software

7.2.4 Tag does not respond

- In case a tag does not respond please perform steps on chapter - [LF signal does not transmits](#)
- In case the step above did not help, connect a second antenna to a different port and check tag response. This check is in case the tag is configured to stop transmitting after a certain amount of time near the LF antenna. The second antenna should reactivate the tag.
- **Note** that if the parameter "sleep within LF filed" is on it might be that the tag has been detected a large number of time near the antenna and has been disabled for a period of time defined.

If the steps above does not help perform steps on section- [The unit is on but no response](#)

8. Radio Approvals

8.1 Base Station\Gate Locator\Gate Exciter GPRS\4 Channel Exciter

The following systems share the same FCC ID:

- Base station
- Gate Locator
- Gate Exciter GPRS
- 4 Channel Exciter

8.1.1 USA (FCC)

- FCC ID: Z97 Z97LTG2-01

Note: This equipment has been tested and found to comply with the limits for a Class B digital device, pursuant to part 15 of the FCC Rules. These limits are designed to provide reasonable protection against harmful interference in a residential installation. This equipment generates, uses and can radiate radio frequency energy and, if not installed and used in accordance with the instructions, may cause harmful interference to radio communications. However, there is no guarantee that interference will not occur in a particular installation. If this equipment does cause harmful interference to radio or television reception, which can be determined by turning the equipment off and on, the user is encouraged to try to correct the interference by one or more of the following measures:

- Reorient or relocate the receiving antenna.
- Increase the separation between the equipment and receiver.
- Connect the equipment into an outlet on a circuit different
- From that to which the receiver is connected.
- Consult the dealer or an experienced radio/TV technician For help.

Warning:

Changes or modifications to this equipment not expressly approved by the party responsible for compliance (LogiTag Systems Ltd.) could void the user's authority to operate the equipment.

To comply with FCC RF radiation exposure limits for general population, the antenna(s) used for this transmitter must be installed such that a minimum separation distance of 20cm is maintained between the radiator (antenna) and all persons at all times and must not be co-located or operating in conjunction with any other antenna or transmitter.

8.2 One Channel Exciter

8.2.1 USA (FCC)

- FCC ID: Z97LTG2-04

Note: This equipment has been tested and found to comply with the limits for a Class B digital device, pursuant to part 15 of the FCC Rules. These limits are designed to provide reasonable protection against harmful interference in a residential installation. This equipment generates, uses and can radiate radio frequency energy and, if not installed and used in accordance with the instructions, may cause harmful interference to radio communications. However, there is no guarantee that interference will not occur in a particular installation. If this equipment does cause harmful interference to radio or television reception, which can be determined by turning the equipment off and on, the user is encouraged to try to correct the interference by one or more of the following measures:

- Reorient or relocate the receiving antenna.
- Increase the separation between the equipment and receiver.
- Connect the equipment into an outlet on a circuit different
- From that to which the receiver is connected.
- Consult the dealer or an experienced radio/TV technician For help.

Warning:

Changes or modifications to this equipment not expressly approved by the party responsible for compliance (LogiTag Systems Ltd.) could void the user's authority to operate the equipment.

8.3 Remote Door Indicator

8.3.1 USA (FCC)

- FCC ID:Z97 LTG2-05

Note: This equipment has been tested and found to comply with the limits for a Class B digital device, pursuant to part 15 of the FCC Rules. These limits are designed to provide reasonable protection against harmful interference in a residential installation. This equipment generates, uses and can radiate radio frequency energy and, if not installed and used in accordance with the instructions, may cause harmful interference to radio communications. However, there is no guarantee that interference will not occur in a particular installation. If this equipment does cause harmful interference to radio or television reception, which can be determined by turning the equipment off and on, the user is encouraged to try to correct the interference by one or more of the following measures:

- Reorient or relocate the receiving antenna.
- Increase the separation between the equipment and receiver.
- Connect the equipment into an outlet on a circuit different
- From that to which the receiver is connected.
- Consult the dealer or an experienced radio/TV technician For help.

Warning:

Changes or modifications to this equipment not expressly approved by the party responsible for compliance (LogiTag Systems Ltd.) could void the user's authority to operate the equipment.

8.4 Staff Tag

8.4.1 USA (FCC)

- FCC ID:Z97 LTT-08

Note: This equipment has been tested and found to comply with the limits for a Class B digital device, pursuant to part 15 of the FCC Rules. These limits are designed to provide reasonable protection against harmful interference in a residential installation. This equipment generates, uses and can radiate radio frequency energy and, if not installed and used in accordance with the instructions, may cause harmful interference to radio communications. However, there is no guarantee that interference will not occur in a particular installation. If this equipment does cause harmful interference to radio or television reception, which can be determined by turning the equipment off and on, the user is encouraged to try to correct the interference by one or more of the following measures:

- Reorient or relocate the receiving antenna.
- Increase the separation between the equipment and receiver.
- Connect the equipment into an outlet on a circuit different
- From that to which the receiver is connected.
- Consult the dealer or an experienced radio/TV technician For help.

Warning:

Changes or modifications to this equipment not expressly approved by the party responsible for compliance (LogiTag Systems Ltd.) could void the user's authority to operate the equipment.

This device complies with Part 15 of the FCC Rules.

Operation is subject to the following two conditions:

- (1) This device may not cause harmful interference, and
- (2) This device must accept any interference received, including interference that may cause undesired operation.

8.5 Resident Tag

8.5.1 USA (FCC)

- FCC ID:Z97 LTT-03

Note: This equipment has been tested and found to comply with the limits for a Class B digital device, pursuant to part 15 of the FCC Rules. These limits are designed to provide reasonable protection against harmful interference in a residential installation. This equipment generates, uses and can radiate radio frequency energy and, if not installed and used in accordance with the instructions, may cause harmful interference to radio communications. However, there is no guarantee that interference will not occur in a particular installation. If this equipment does cause harmful interference to radio or television reception, which can be determined by turning the equipment off and on, the user is encouraged to try to correct the interference by one or more of the following measures:

- Reorient or relocate the receiving antenna.
- Increase the separation between the equipment and receiver.
- Connect the equipment into an outlet on a circuit different
- From that to which the receiver is connected.
- Consult the dealer or an experienced radio/TV technician For help.

Warning:

Changes or modifications to this equipment not expressly approved by the party responsible for compliance (LogiTag Systems Ltd.) could void the user's authority to operate the equipment.

This device complies with Part 15 of the FCC Rules.

Operation is subject to the following two conditions:

(1) This device may not cause harmful interference, and

(2) This device must accept any interference received, including interference that may cause undesired operation.

9. Power supply requirements

For supplying power to the different systems one may use 2 different options:

- Local Limited power supply source
- Main power supply unit for several units

9.1 Limited power source:

When using local power supply, use LPS certified type equivalent to:

- EDAC p/n EA10721B-2404
- MEAN WELL p/n GS60A24

9.2 Main supply network:

When using mains power supply, for supplying power to several units, you must follow the following installation requirements:

- Use main power supply 24V with maximum output of 40A
- The unit must be certified according to local authority's rules.
- Make sure the unit has internal output circuit breaker with short circuit and over current protection. If not connect external certified double pole DC circuit breaker (as the above) at ratings maximum allowed output current of the power supply (equal or lower than the power supply current output ratings).
- When connecting a cable between power supply to a system, use a cable that can stand the maximum allowed output current from the power supply (according to local authority's rules) for example:
 - For 40A current use 2*10mm² copper cable
 - For 30A current use 2*10mm² copper cable
 - For 25A current use 2*6mm² copper cable
 - For 20A current use 2*4mm² copper cable
- To each end unit connect a certified double pole DC circuit breaker with short circuit and over current protection with ratings according to the following list:
 - Base station ---- 6A . use 2*1mm² copper cable
 - Gate Locator/4 Channel exciter ---- 6A . use 2*1mm² copper cable
 - One Channel Exciter ---- 2A . use 2*0.5mm² copper cable
 - Remote Door Indicator ---- 2A . use 2*0.5mm² copper cable

LT-D-0211 rev 16

f. Use the following circuit breaker, or equivalent;

2A:

- EATON p/n FAZ-C2/2-NA
- ABB p/n S202-C2

6A:

- EATON p/n FAZ-C6/2-NA
- ABB p/n S202-C6

Connect the circuit breaker between the end unit and the main power supply.