

# PowerUp

Setup Guide | Setup Guide

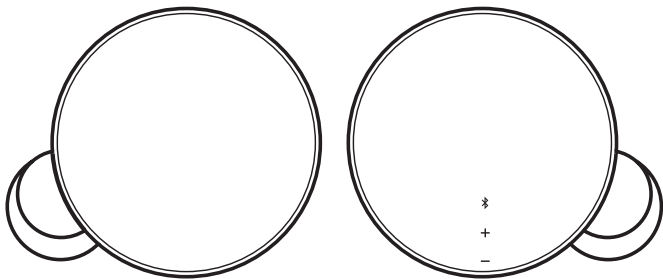

logitech®

English . . . . . 3

English . . . . . 3

## WHAT'S IN THE BOX

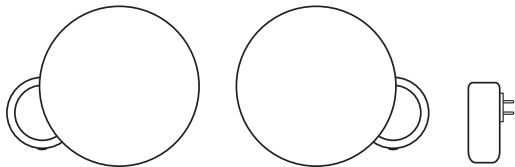

1. 2 MX Sound speakers
2. Power adapter

## CONTROL

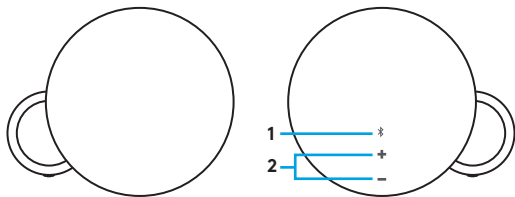

### **Touch control with LED**

1. *Bluetooth*<sup>®</sup> (white LED)
2. Volume (white LED)

## CONNECTOR

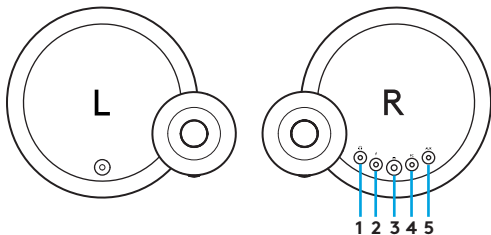

1. Audio output: 3.5mm jack
2. Power
3. Link to left SAT: RCA
4. Audio input: 3.5mm jack
5. Audio input: 3.5mm jack

## CONNECTIVITY

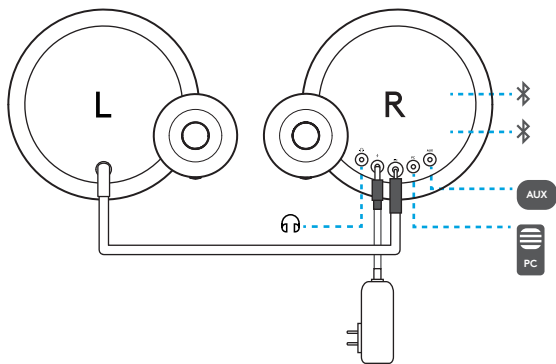

## POWER

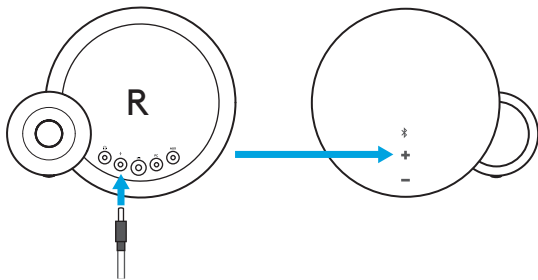

MX Sound doesn't have power button. The product is on when power plugged in.

All three icons light up.

## STANDBY

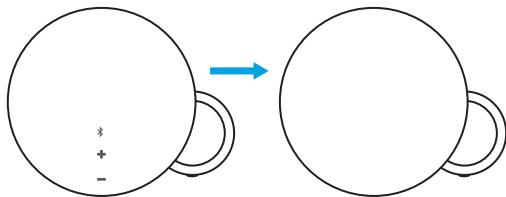

If proximity sensor doesn't sense anything for 1 min.

Standby - all lights are off.



## WAKE UP - PROXIMITY SENSOR

1. Stand by - Dead front

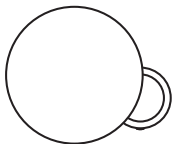

2. Waking up by gesture  
Activation distance:  
3 inches/70mm

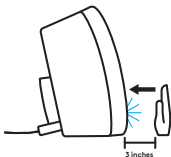

3. All icons appear.

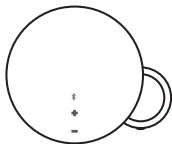

## BLUETOOTH® PAIRING

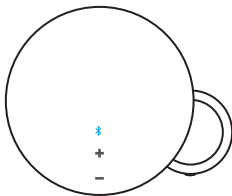

1. One sec-long touch BT icon to enter pairing mode with MX Sound
2. BT icon fast blinks (lasting for 3 mins)
3. Audio cue appears to confirm the successful pairing.

## BLUETOOTH® RECONNECT

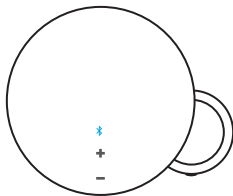

1. Double click *Bluetooth*® icon
2. Audio cue appears to confirm that MX Sound is in Reconnect mode
3. MX Sound is searching last connected device.

## VOLUME TONE

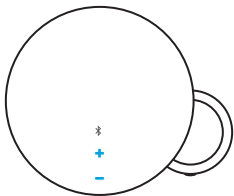

- When operate touch/control Volume, there is sound feedback for each step.
- When reaching minimum/maximum volume, MX Sound will give sound notification.

## HEADPHONE VOLUME

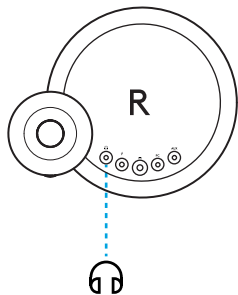

The volume of headphone out can be adjusted independently from speaker volume through V+ and V- touches.

Support copy?

[www.logitech.com/support/mxsound](http://www.logitech.com/support/mxsound)

© 2017 Logitech. All rights reserved. Logitech, Logi and other Logitech marks are owned by Logitech and may be registered. *Bluetooth*® is a registered trademark of Bluetooth SIG, Inc. All other trademarks are the property of their respective owners.

© 2017 Logitech. All rights reserved. Logitech, Logi and other Logitech marks are owned by Logitech and may be registered. *Bluetooth*® is a registered trademark of Bluetooth SIG, Inc. All other trademarks are the property of their respective owners.

620-0XXXXX.002