

VIDEO BABY MONITOR

USER'S GUIDE

BB2411

Version 1.0





Safety Precautions

- Adult assembly is required. Keep small parts away from children when assembling.
- This product is not a toy. Do not allow children to play with it.
- This video monitor is not a substitute for responsible adult supervision.
- Test the video monitor before use. Become familiar with its functions.
- Keep the cords out of reach from children.
- Never use extension cords with power adapters.
- Only use the chargers and power adapters provided. Do not use other chargers or power adapters as this may damage the device and battery pack.
- Only insert batteries/battery pack of the same type.
- Insert batteries with the correct polarity.
- Do not mix new and used batteries.
- Do not mix alkaline, standard, and rechargeable batteries.
- Remove exhausted batteries from the product.
- Keep all batteries away from children.
- Dispose or recycle batteries in accordance with local laws, which may vary by location.
- Do not cover the video monitor with a towel or blanket.
- Do not use the video monitor near water.
- Do not install the video monitor near a heat source.
- Do not touch the plug contacts with sharp or metal objects.
- Keep this user's guide for future reference.



To Avoid Injury to Children & Infants:

- **MAKE SURE** to keep the camera and all power cords are least 3ft / 1m away from cribs and out of reach of your child.

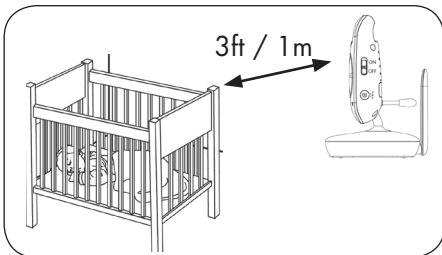
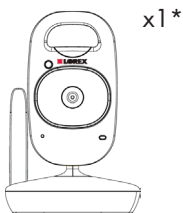

Table of Contents:

Product Includes	2
Monitor Overview	2
Camera Overview	3
Getting Started	4
Optional - Camera Batteries	6
Optional - Wall Mounting the Camera	7
Using Your Baby Monitor	8
Using the Menus	8
Talking to Your Baby.....	9
Changing Channels.....	9
Adjusting Volume	10
Adjusting Screen Brightness.....	10
Using Digital Zoom.....	11
Turning on the Night-Light.....	11
Playing Lullabies	12
Temperature Alerts.....	13
Selecting Fahrenheit or Celsius.....	14
Enabling VOX Mode (Voice Trigger)	14
Video On/Off (Audio Only Mode)	15
Pairing Additional Cameras	16
Technical Specifications	18
Camera	18
Monitor.....	18
Troubleshooting	19
Need Help?	19

Product Includes



Camera

x1*

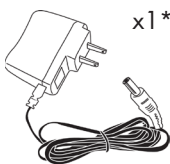

Power Adapter

x1*



x2*



x2*

Screws & Anchors

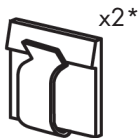

Cable Clips

x2*



Monitor

x1

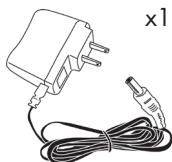

Power Adapter

x1

*Contents may vary by model

Monitor Overview

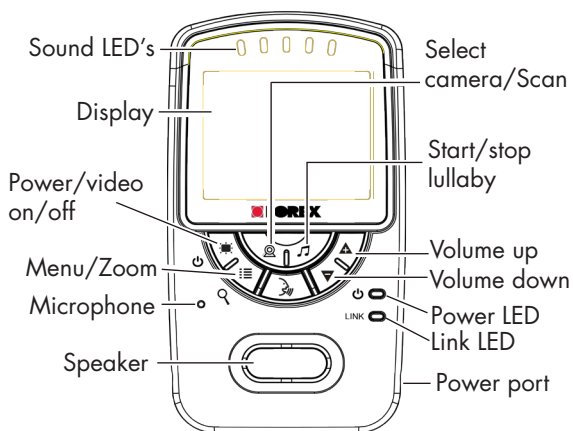

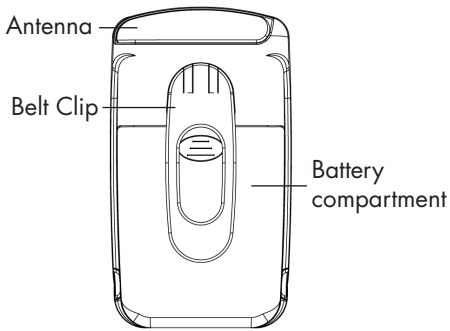

Camera Overview

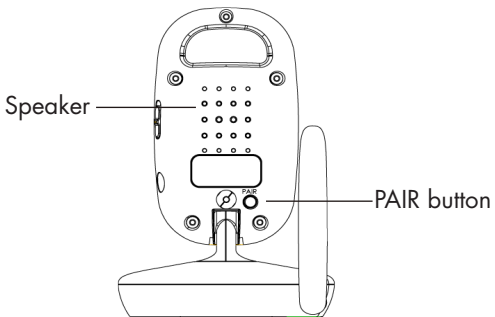
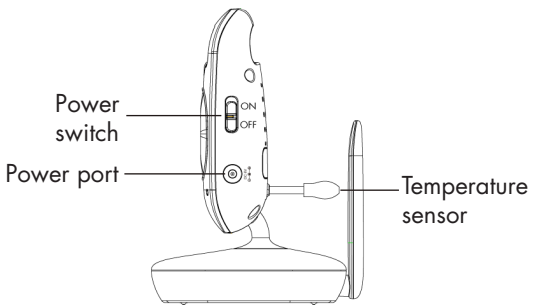
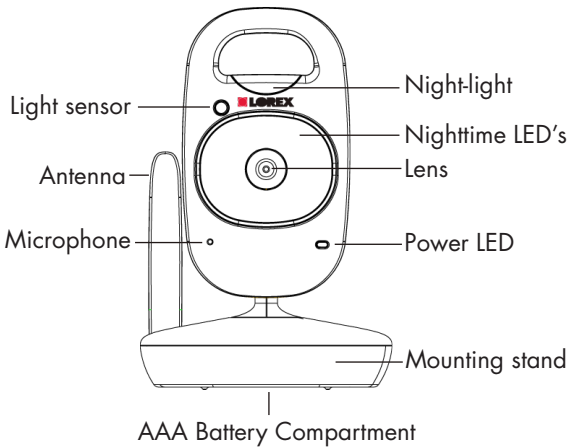

Getting Started

1

Connect the power adapter to the camera.

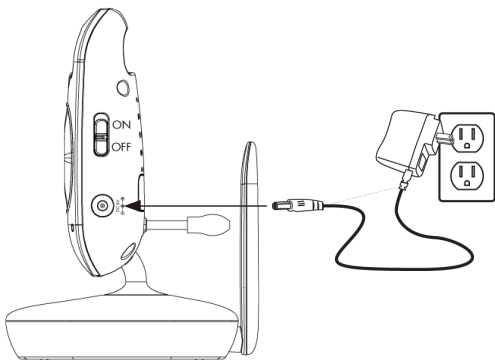

Make sure all power cables are at least 3ft / 1m away from the crib and out of reach of your child.

2

Slide the power switch to ON.

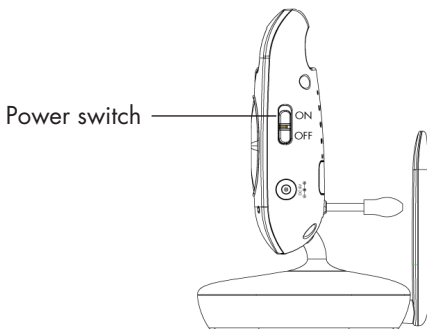

3

Press down on the battery compartment door and slide it off the monitor.

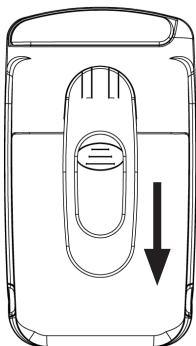

4

Connect the battery cable to the monitor.

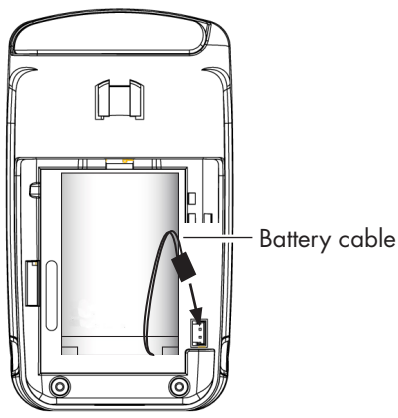

The battery cable only connects one way. Do not force the battery cable.

5

Replace the battery compartment door.

6

Connect the power adapter to the monitor.

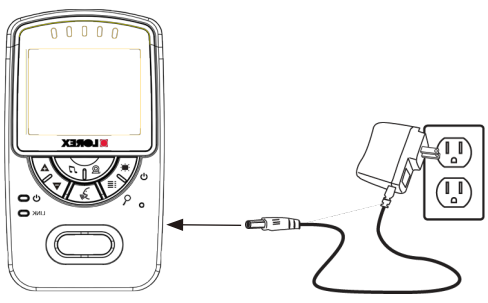

7

Press and hold the power button to turn on the monitor.



Tips

- It is recommended to charge the battery for 6 hours before use.
- For overnight monitoring, it is recommended to connect the power adapter. The monitor will stay on about 6 hours when fully charged.
- For better reception, extend the monitor's antenna.

Pull up to extend
antenna

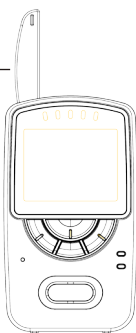

Optional - Camera Batteries

Unscrew the battery compartment under the camera and insert 4x AAA batteries (not included). Replace the battery compartment door and screw.

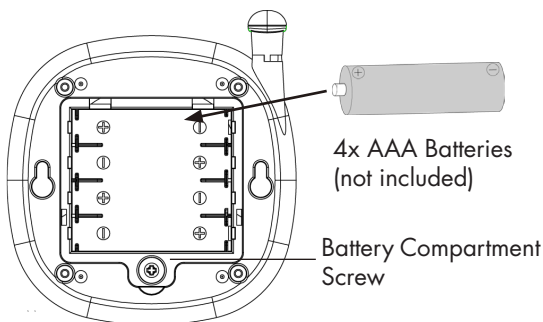

4x AAA Batteries
(not included)

Battery Compartment
Screw



AAA batteries are not intended for overnight monitoring. The camera can operate for about 5 hours on battery power.

Notes

- If using batteries, it is recommended to use the power adapter whenever possible to save battery life.
- The camera power adapter cannot charge rechargeable AAA batteries.

Optional - Wall Mounting the Camera

Before permanently mounting the camera:

- Determine where you will get the best view of your baby.
- Ensure the power cable is long enough to power the camera.



Make sure all power cables are at least 3ft / 1m away from the crib and out of reach of your child. Use the included cable clips to help manage the power cable.

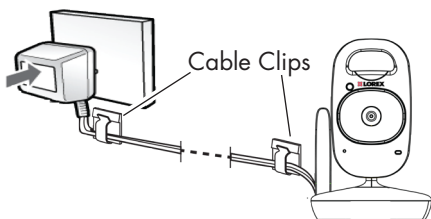

1

Drill 2 holes in the wall with centers exactly 68mm apart.

2

Tap anchors into holes with a hammer. Insert screws 2/3 of the way.

3

Align the mounting points with the screws and push the camera down.

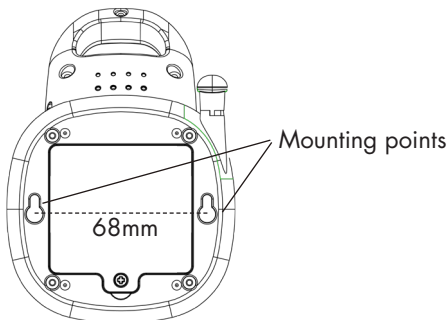
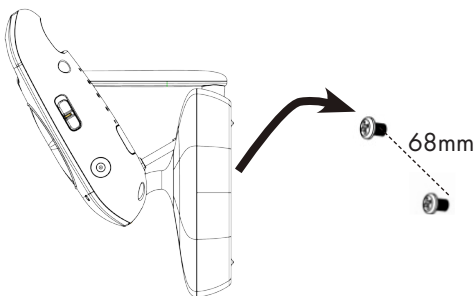

Using Your Baby Monitor

The monitor shows the following icons during use:

Icon	Meaning
	Signal strength
	Selected channel
Scan	Scan mode activated
	Volume muted
X2	Digital zoom activated
	Song currently playing
	Talk activated

Icon	Meaning
VOX	VOX (Voice Trigger) on
	Battery full
	Battery low
	Battery charging
68°F	Current room temperature
	Camera out of range or off (e.g. batteries dead)

Using the Menus

1

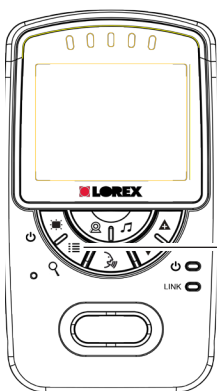

Press to cycle through menus

2

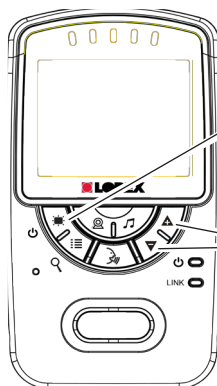

Press to exit menu

Press to adjust menu options

Talking to Your Baby



Press and hold to talk to the selected camera

Changing Channels

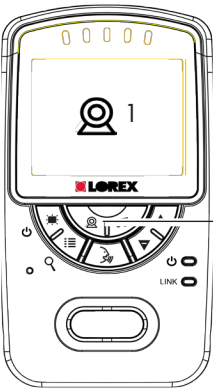

Press to cycle through connected cameras or select Scan mode.

The currently selected camera is shown on screen.

The monitor only plays sound from the camera that is currently being viewed.

When Scan mode is activated, the monitor changes channel automatically every few seconds. A Scan icon appears next to the currently selected channel number.

Currently selected channel



Scan mode activated

To connect additional cameras to the monitor, see "Pairing Additional Cameras" on page 16.

Adjusting Volume

Press to adjust the volume coming from the camera



Adjusting Screen Brightness

1

Press until  is shown

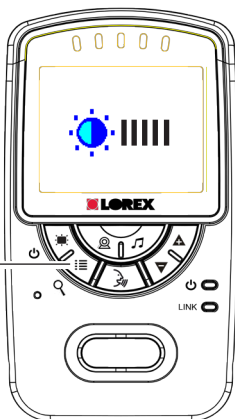

2

Press to adjust brightness

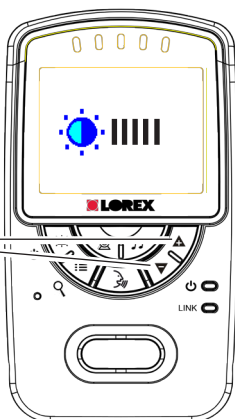

3

Press  to exit menu.

Using Digital Zoom

1

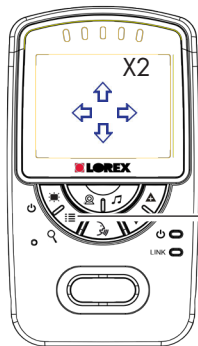

Press and hold to zoom in. An X2 icon and arrows appear on the screen.

2



Press to move zoom area left/right

Press to move zoom area up/down

3

Press and hold  to zoom out.

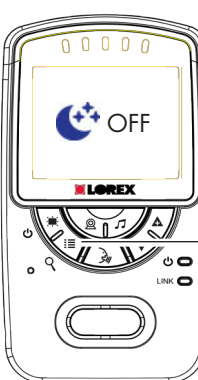

Turning on the Night-Light

1



Press until  is shown

2

Press   to turn the night-light on or off for the currently selected camera.

3

Press  to exit menu.

Playing Lullabies

The camera can play 5 different pre-loaded songs.

To play songs:

1

Press to play a song on the selected camera.



2

Right after pressing , press to change the song.

The song number is shown on the monitor.

If volume controls appear, press  twice to restart the song. Volume controls will appear if you press   a few seconds after pressing .



3

Press  to stop playing the song.

Temperature Alerts

The temperature alert feature allows you to ensure the baby's room is at a comfortable, safe temperature. The monitor beeps if the temperature gets too hot or cold.

You can control the high and low temperatures that trigger alerts or disable temperature alerts.

To setup temperature alerts:

1

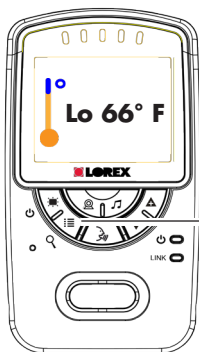

Press until  **Lo** is shown.

2

Press   to adjust the low temperature.

If the temperature at the selected camera goes below this temperature, the monitor will beep and the temperature reading on the monitor will say "Lo".

If you select a temperature below 62°F / 17°C, the low temperature alert will be turned OFF.

3

Press  until  **Hi** is shown.

4

Press   to adjust the high temperature.

If the temperature at the selected camera goes above this temperature, the monitor will beep and the temperature reading on the monitor will say "Hi".

If you select a temperature above 86°F / 30°C, the high temperature alert will be turned OFF.







5

Press  to exit menu.

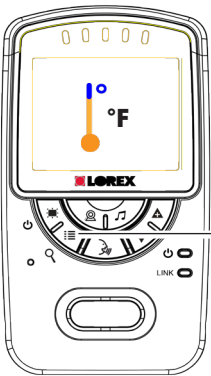
Selecting Fahrenheit or Celsius

You can select if you would like temperature readings and alerts to be in Fahrenheit or Celsius.

To select temperature units:

-  1 Press until  is shown.
-  2 Press   to select F (Fahrenheit) or C (Celsius)
-  3 Press  to exit menu.

Enabling VOX Mode (Voice Trigger)

In VOX mode, the monitor goes into standby. When sound is detected by the camera at the preset audio level, the monitor's screen instantly turns on. This conserves battery power, and alerts you only when needed.

To activate VOX mode:

-  1 Press until **VOX** is shown

2 Press   to adjust the audio sensitivity for VOX mode.

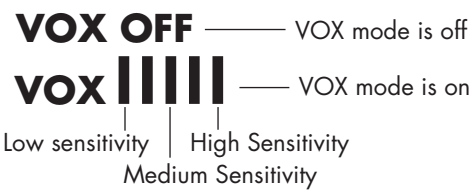

If you want softer noises to trigger the monitor (such as a faint whimper), set the sensitivity setting higher. If you only want louder noises to trigger the monitor (such as a loud cry), set the sensitivity setting lower.

3 Press  to exit menu.

While VOX is activated, the monitor’s screen and speaker will turn off after a minute unless sound is detected at the selected sensitivity level. Press any button to turn the screen back on. When VOX is on, a **VOX** icon is shown on the screen.

VOX mode will not work while Scan mode is activated.

Video On/Off (Audio Only Mode)

1 Press  to turn the screen off and monitor sound only.

The monitor will play sound from the selected channel only.

Notes

- If Scan mode is enabled, the monitor will play sound from the channel that is currently selected.
- If VOX mode is activated, the speaker will turn off if sound is not detected at the selected sensitivity level for a minute. The screen will turn on when a sound is loud enough to trigger VOX. See “Enabling VOX Mode (Voice Trigger)” on page 14 for details.

2 Press any button to turn the screen back on.

Pairing Additional Cameras

The camera(s) included have already been paired with the monitor. If you have purchased additional add-on cameras (model# BB2411AC1), **OR** if your monitor and camera are not paired up, follow the steps below.

To pair a camera to your monitor:

1



Place the camera and monitor next to each other. Make sure the camera is turned on.

2

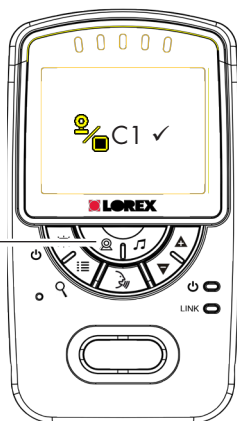
Press and hold until  is shown



3

Press   to select the channel you would like to pair the camera to.

If a camera is already connected to this channel, the new camera will replace the existing camera.

4

Press to begin pairing

The LINK LED flashes to show that pairing mode is on.

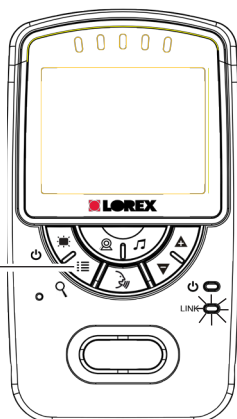

5

Press the PAIR button on the back of the camera.

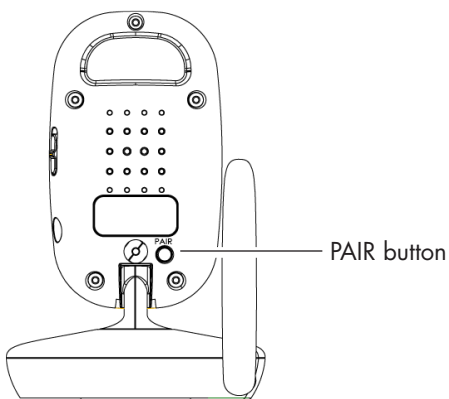

Images from the camera are immediately shown on the monitor once the camera is successfully paired.

Notes

- Immediately move the camera away from the monitor to avoid speaker feedback.
- The monitor can connect up to 4 cameras.

Technical Specifications

Camera

Frequency	2.4GHz
Maximum Range	Up to 450ft / 138m outdoors* Up to 150ft / 46m indoors*
Image Sensor	1/5" Color CMOS
Lens	3.6mm F2.8
IR LED	6 pcs
Power Adapter	6.0V DC 800mA
Battery	Supports 4x AAA Batteries (not included)
Weight	0.3lbs 0.1kg



Monitor

Frequency	2.4GHz
Display	2.4" TFT Color LCD
Power Adapter	6.0V DC 800mA
Battery	Li-ion Rechargeable Battery 3.7V DC 1500mAh
Weight	0.3lbs 0.1kg

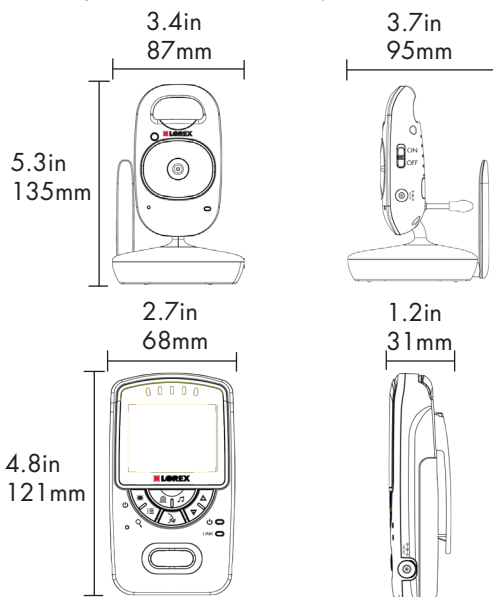
*Based on unobstructed line of sight. Actual range will vary based on surroundings.



Troubleshooting

Problem	Solution
No video displayed on the monitor	<ul style="list-style-type: none">• Press and hold the  button to power on the monitor.• Monitor is out of batteries. Plug in the monitor power adapter.• Video Off or VOX mode is on. Press any button to turn the screen back on.
Monitor screen keeps turning off	<ul style="list-style-type: none">• VOX mode is on. See "Enabling VOX Mode (Voice Trigger)" on page 14 for details on disabling VOX mode.• The monitor battery is low. Plug in the monitor power adapter
The camera is not detected; "Out of Range" is shown on the monitor	<ul style="list-style-type: none">• Wrong channel selected. Press  repeatedly to select the channel.• Make sure the camera is powered on.• Camera may be out of batteries. Replace the batteries.• The camera and monitor may be out of range. Move the monitor and camera closer together.• You may need to pair the camera and the monitor again. See "Pairing Additional Cameras" on page 16 for details.
Feedback / squealing noise coming from the monitor	<ul style="list-style-type: none">• Your camera and monitor may be too close to each other. Move them further apart.• Press  to lower the monitor volume.

Need Help?

Product Support is available 24/7 including product information, user guides, quick start guides, and FAQ's at www.lorextechnology.com/support

CLEANING

Clean the monitor and camera with a slightly damp cloth or an anti-static cloth. Never use cleaning agents or abrasive solvents.

- Do not clean any part of the product with cleaners with thinners or other solvents and chemicals. This may cause permanent damage to the product, which is not covered by the Warranty. When necessary, clean it with a damp cloth.
- Keep your camera and monitor away from hot, humid areas or strong sunlight, and do not get it wet.
- Every effort has been made to ensure high standards of reliability for your baby monitor. However, if something does go wrong, please do not try to repair it yourself. Contact Customer Service for assistance.

DISPOSAL OF THE DEVICE

At the end of the product life cycle, you should not dispose of this product with normal household waste, but take the product to a collection point for the recycling of electrical and electronic equipment. The symbol on the product, user's guide, and/or box indicates this.



Some of the product materials can be re-used if you take them to a recycling point. By reusing some parts or raw materials from used products you make an important contribution to the protection of the environment.

Please contact your local authorities in case you need more information on the collection points in your area. Dispose of the battery pack in an environmentally-friendly manner according to your local regulations.

NOTICES

WARNING: Any changes or modifications not expressly approved by the grantee of this device could void the user's authority to operate the device.

FCC NOTICE

This device complies with Part 15, subpart C, of the FCC Rules. Operation is subject to the following two conditions: (1) this device may not cause harmful interference, and (2) this device must accept any interference received, including interference that may cause undesired operation.

The manufacturer is not responsible for any radio or TV interference caused by unauthorized modifications to this equipment. Such modifications could void the user's authority to operate the equipment. However, it is imperative that the user follows the guidelines in this manual to avoid improper usage which may result in damage to the unit, electrical shock and fire hazard injury.

CAUTION: To maintain compliance with the FCC's RF exposure guidelines, place the camera at least 20cm (7.87in) from nearby persons.

The video monitor has been tested and meets the FCC RF exposure guidelines when used with the belt clip supplied with or designated for this product. Use of other accessories may not ensure compliance with FCC RF exposure guidelines.

CANADA/IC NOTICE

This device complies with Industry Canada licence-exempt RSS standard(s). Operation is subject to the following two conditions: (1) this device may not cause interference, and (2) this device must accept any interference, including interference that may cause undesired operation of the device.

Under Industry Canada regulations, this radio transmitter may only operate using an antenna of a type and maximum (or lesser) gain approved for the transmitter by Industry Canada. To reduce potential radio interference to other users, the antenna type and its gain should be so chosen that the equivalent isotropically radiated power (e.i.r.p.) is not more than that necessary for successful communication.



USER'S GUIDE
BB2411
Version 1.0

www.lorexttechnology.com

Copyright © Lorex Technology Inc. 2013