



# LOREX<sup>®</sup>

En

## W881AA Series Quick Start Guide

[lorex.com](http://lorex.com)





Thank you for your purchase!

# How to get started with your Wi-Fi Camera





## Safety precautions

- Read this guide carefully and keep it for future reference.
- Follow all instructions for safe use and handling of the product.
- Operate the camera within the specified temperature, humidity and voltage and use manufacturer approved accessories.
- Do not disassemble the camera.
- Do not point the camera directly at the sun or a source of intense light.
- Periodic cleaning may be required. Use a damp cloth only. Do not use any harsh, chemical-based cleaners.

## Disclaimers

- A regulated UL / CSA approved power supply is required for use with this camera (included). Use of a non-regulated, non-conforming power supply can damage this product and voids the warranty.
- Not intended for submersion in water. Installation in a sheltered location recommended.
- Audio recording without consent is illegal in certain jurisdictions. Lorex Corporation assumes no liability for use of its products that does not conform with local laws.
- This camera includes an Auto Mechanical IR Cut Filter. When the camera changes between Day/Night viewing modes, an audible clicking noise may be heard from the camera. This clicking is normal, and indicates that the camera filter is working.
- Some channels on the 5GHz Wi-Fi band are restricted in Canada. This means certain Wi-Fi networks may not be available to connect to during setup.
- Audio recording without consent is illegal in certain jurisdictions. Lorex Corporation assumes no liability for use of its products that does not conform with local laws.





# Contents

- Section 1** Package Contents & Dimensions
- 2** Overview
- 3** Status Indicator
- 4** Camera Setup
- 5** App Live View
- 6** Camera Placement
- 7** Optimize Motion Detection
- 8** Wall Mounting
- 9** Ceiling Mounting





# 1 Package contents



2K Wi-Fi Camera  
(x1)



Power Adapter  
(x1)



9.8 ft (3m)  
Weatherproof Extension  
Cable (x1)



Wall Mounting  
Bracket (x1)

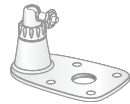

Ceiling/Table  
Mounting Bracket  
(x1)



Pre-inserted Memory  
Card (x1)

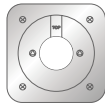

Mounting Template  
(x1)



Mounting Plate  
(x1)



Anchors (x8)  
Screws (x8)



Wrench (x1)



Cable Clips (x4)

**Note:** The following contents is based on 1 camera

## Dimensions

### Camera with Wall Mount

- Height: 3.1" (78mm)
- Width: 3.1" (78mm)
- Length: 5.0" (128mm)

### Camera with Ceiling Mount

- Height: 4.2" (107mm)
- Width: 3.1" (78mm)
- Length: 5.2" (132mm)





## 2 Overview

FRONT

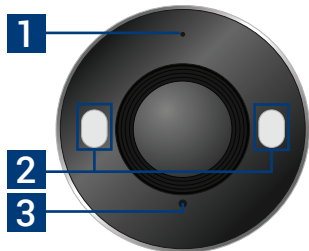

SIDE

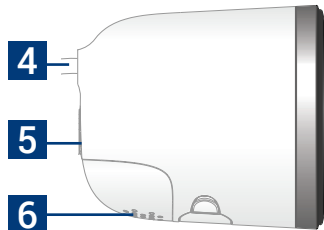

BOTTOM

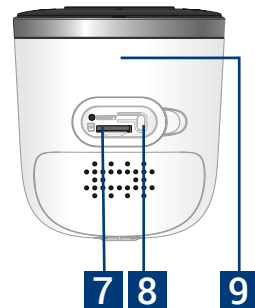

1. Microphone
2. Warning light
3. Status indicator





4. 9.2ft (2.8m) USB power cord
5. Threaded insert (for mounting)
6. Speaker

7. MicroSD slot (card included)
8. Pairing / reset button
9. QR code





### 3 Status indicator

 (solid)	Connected to network
 (flashing)	Ready to connect to network
 (solid)	Factory reset
 (flashing)	Disconnected from network
 (alternating)	Firmware update in progress





## 4 Camera setup

1. Connect power to the camera with the provided power adapter. When you hear the chime and the status indicator is flashing green, the device is ready for setup.

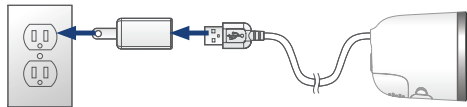

**Optional:** Connect the weatherproof extension cable to the camera's cable.

2. Download the **Lorex Home app** by scanning the QR code.
3. Open the Lorex Home app, and sign in or create an account.
4. Tap  in the app, then follow the in-app instructions to complete the device setup.

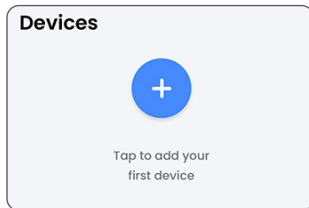

Ensure you update to the latest app and camera firmware version.





## 5 App Live View

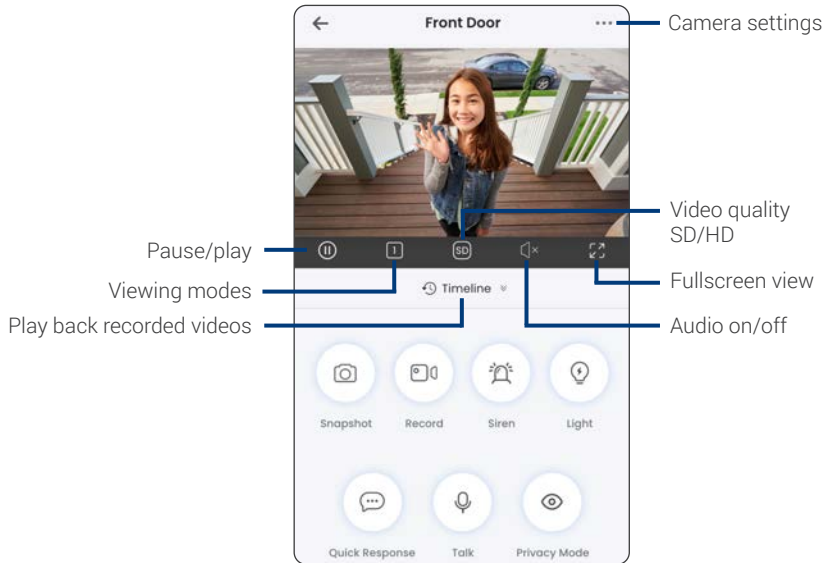



## 6 Camera Placement

- Place the camera close to your Wi-Fi router as possible.
- Reduce the number of obstructive materials between the camera and the router or access point. Concrete, brick, metal and wood are the most common materials in your house that can cause poor signal strength.
- Other electronic devices such as microwaves, TVs, cordless phones, and baby monitors can cause signal interference. It is recommended to install the camera as far away from these devices as possible.





## 7 Optimize Motion Detection

**Distance** Optimal accuracy for objects within 5ft to 50ft (1.5~15m).

**Angle** Angle the camera around 30°-60° down from the level position.

**Height** Install the camera between 8-16ft (2.5~5m) off of the ground.

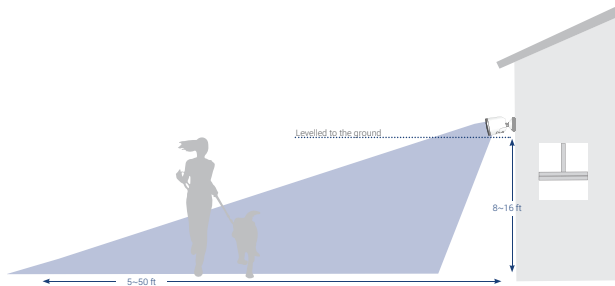

**Note:** Accuracy of person detection will be influenced by multiple factors, such as the person's distance from the camera, the height of the person, and the height and angle of the camera. Night vision will also impact the accuracy and distance of detection.



## 8 Wall Mounting

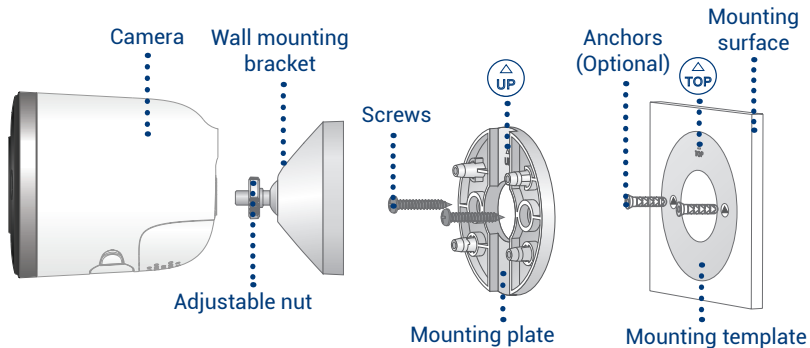

### To wall mount the camera:

1. Place the mounting template onto the desired location.  
**Note:** Ensure an outlet is nearby, and keep in mind the cable lengths.
2. Using a  $15/64"$  (6mm) drill bit, drill 2 holes over the triangle symbols on the template.  
**Optional:** Drill  $15/64"$  (6mm) holes for the anchors.

3. Align the arrows of the mounting plate and template. Using a screwdriver and the provided screws, secure the mounting plate to the surface.
4. Align the arrows between the wall mounting bracket and plate. Push the bracket in to install, then slide down to lock in place. You will hear a 'click' when the bracket is installed.
5. Attach the camera to the mounting bracket using the threaded insert at the rear of the camera. Rotate the camera clockwise until attached, then tighten into place with the adjustable nut.
6. Adjust the camera to the desired angle.

**Note:** If the camera is not holding in place or difficult to adjust, unplug the camera and slide the bracket up to detach from the mounting plate. Tighten or loosen the 3 screws at the back of the mounting bracket to adjust accordingly. Repeat steps 4-6 to re-install.

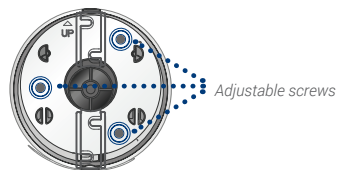
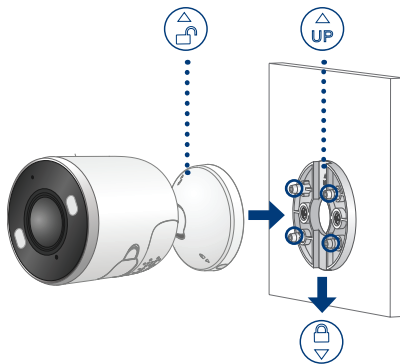

Back - Wall mounting bracket



## 9 Ceiling Mounting

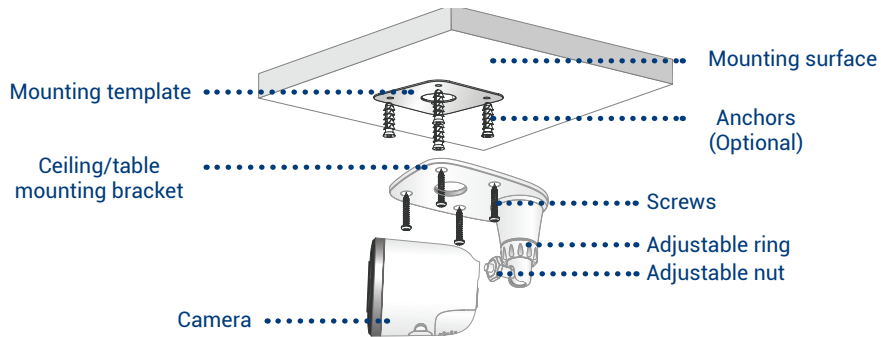

### To ceiling mount the camera:

1. Place the mounting template onto the desired location.  
**Note:** Ensure an outlet is nearby, and keep in mind the cable lengths.
2. Using a 15/64" (6mm) drill bit, drill 4 holes over the **X** symbols on the template.  
**Optional:** Drill 15/64" (6mm) holes for the anchors.





3. Remove the 4 pre-inserted plugs from the ceiling/table mounting bracket.
4. Attach the camera to the ceiling/table mounting bracket using the threaded insert at the rear of the camera. Rotate the camera clockwise until attached, then use the wrench to tighten the adjustable nut in place.
5. Place the bracket over the drilled holes. Using a screwdriver and the provided screws, secure the bracket to the surface.
6. Rotate the adjustable ring counter-clockwise to loosen and adjust the camera to the desired position, then tighten to secure.

#### Optional:

- Feed the camera cable through the hole at the base of the bracket or the mounting surface.
- Open the camera's settings in the app and enable **Image Rotation** to flip the camera image.

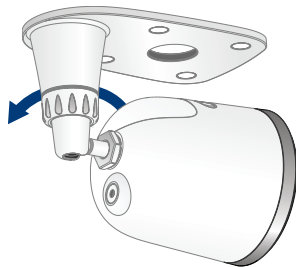
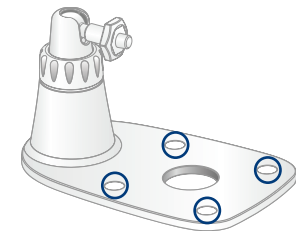

Please take attention that changes or modification not expressly approved by the party responsible for compliance could void the user's authority to operate the equipment.

This device complies with Part 15 of the FCC Rules. Operation is subject to the following two conditions:

- (1) This device may not cause harmful interference, and
- (2) This device must accept any interference received, including interference that may cause undesired operation.

This device complies with Industry Canada licence-exempt RSS standard(s). Operation is subject to the following two conditions:

- (1) this device may not cause interference, and
- (2) this device must accept any interference, including interference that may cause undesired operation of the device.

Le présent appareil est conforme aux CNR d'Industrie Canada applicables aux appareils radioexempts de licence. L'exploitation est autorisée aux deux conditions suivantes :

- (1) l'appareil ne doit pas produire de brouillage, et
- (2) l'utilisateur de l'appareil doit accepter tout brouillage radioélectrique subi, même si le brouillage est susceptible d'en compromettre le fonctionnement.

This equipment complies with FCC/IC RSS-102 radiation exposure limits set forth for an uncontrolled environment. This equipment should be installed and operated with minimum distance 20cm between the radiator & your body.

ce matériel est conforme aux limites de dose d'exposition aux rayonnements, FCC / CNR-102 énoncée dans un autre environnement. cette equipment devrait être installé et exploité avec distance minimale de 20 entre le radiateur et votre corps.



The user manual for local area network devices shall contain instructions related to the restrictions mentioned in the above sections, namely that:

- (i) the maximum antenna gain permitted for devices in the bands 5250-5350 MHz and 5470-5725 MHz shall comply with the e.i.r.p. limit; and
- (ii) the maximum antenna gain permitted for devices in the band 5725-5825 MHz shall comply with the e.i.r.p. limits specified for point-to-point and non point-to-point operation as appropriate.

- (i) le gain d'antenne maximal autorisé pour les appareils dans les bandes 5250-5350 MHz et 5470-5725 MHz doivent respecter le pire limiter; et
- (ii) le gain d'antenne maximal autorisé pour les appareils dans la bande 5725-5825 MHz doivent respecter le pire limites spécifiées pour le point-à-point et l'exploitation non point à point, le cas échéant.

Users should also be advised that high-power radars are allocated as primary users (i.e. priority users) of the bands 5250-5350 MHz and 5650-5850 MHz and that these radars could cause interference and/or damage to LE-LAN devices.

Les utilisateurs de radars de haute puissance sont désignés utilisateurs principaux (c.-à-d., qu'ils ont la priorité) pour les bandes 5250-5350 MHz et 5650-5850 MHz et que ces radars pourraient causer du brouillage et/ou des dommages aux dispositifs LAN-EL.



## Need help?

Visit [help.lorex.com](https://help.lorex.com) for up-to-date information and resources:

- Download product guides
- Watch how-to-videos
- Find related troubleshooting tips & FAQs

## Register your product

Please see our full Terms of Service and Limited Hardware Warranty Policy visit, [lorex.com/warranty](https://lorex.com/warranty).



This device complies with part 15 of the FCC Rules. Operation is subject to the following two conditions: (1) This device may not cause harmful interference, and (2) This device must accept any interference received, including interference that may cause undesired operation.

Copyright © 2021 Lorex Corporation

As our products are subject to continuous improvement, Lorex reserves the right to modify product design, specifications and prices, without notice and without incurring any obligation. E&OE. All rights reserved.

W482CAD\_QSG\_TRILINGUAL\_R1

