



VIDEO BABY MONITOR

INSTRUCTION MANUAL
ENGLISH VERSION 1.0



LIVE VIEW

LW2004 SERIES

www.lorextechnology.com

Welcome!

Thank you for purchasing the Lorex LIVE View video monitor.

Before you start...

Please make sure to charge the handheld monitor before use. See the quick start guide or "Getting Started" on page 7 for instructions.

Contents

Make sure you have the following:

- 1x Handheld monitor
- 1x Camera*
- 1x Rechargeable Li-Ion battery for the handheld monitor **(pre-installed)**
- 1x Camera power adapter*
- 1x Handheld monitor power adapter
- 1x Camera stand*
- 1x Handheld monitor stand
- 1x Camera mounting screw kit*
- 1x User's guide
- 1x Quick start guide

* Contents may vary by model.

Safety Instructions

WARNING

This baby monitor is compliant with all relevant standards regarding electromagnetic fields and is, when handled as described in the User's Guide, safe to use. Therefore, always read the instructions in this User's Guide carefully before using the device.

- Adult assembly is required. Keep small parts away from children when assembling.
- This product is not a toy. Do not allow children to play with it.
- This video monitor is not a substitute for responsible adult supervision.
- Do not place the camera or cords in the cot or within arm's reach of the baby (the unit and cords should be at least 3 ft. / 1m away).
- Keep the cords out of reach of children.
- Do not cover the video monitor with a towel or blanket.
- Never use extension cords with power adapters.
- Test the video monitor before use. Become familiar with its functions.
- Do not use the video monitor near water.
- Do not install the video monitor near a heat source.
- Only use the chargers and power adapters provided. Do not use other chargers or power adapters as this may damage the device and battery pack.
- Only insert battery pack of the same type.
- Do not touch the plug contacts with sharp or metal objects.
- Keep this User's Guide for future reference.

CAUTION

Risk of explosion if battery is replaced by an incorrect type.
Dispose of used batteries according to the instructions.

To Avoid Injury to Children/Infants:

We advise you to take the following precautions to avoid possible injury to infants:

- **DO NOT** place baby audio and video camera monitors too close to cribs, bassinets, play yards, and other safe sleep environments for infants.
- **MAKE SURE** to run all power adapter cords where they are unlikely to be tripped over and are out of arms reach of your infant. Keep them at least **3 ft. / 1m** away.
- **MAKE SURE** baby audio and video camera monitors are on a stable footing so they cannot be easily knocked over.

NOTE: These precautions are important even if your infant is not yet standing or mobile

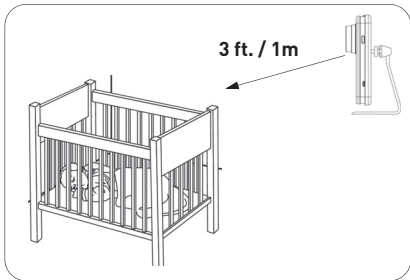
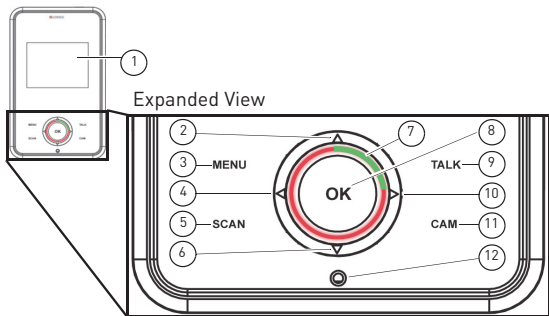

TABLE OF CONTENTS

1. Handheld Monitor Overview	1
2. Camera Overview	5
3. Getting Started	7
3.1 Installing The Handheld Monitor Stand	7
3.2 Connecting The Handheld Monitor	8
3.3 Setting Up The Camera	9
4. Using The Handheld Monitor	10
4.1 Selecting The Camera	10
4.2 Viewing Options	10
4.3 Adjusting Volume	11
4.4 Talk Function	12
4.5 Adjusting Screen Brightness	12
4.6 Navigating The Menu	13
4.7 Menu Options	14
4.8 Voice Trigger (Audio Activated Alerts)	15
4.9 Sleep Mode (Audio Only Mode)	16
4.10 Adjusting Scan Duration	16
4.11 Key Lock	17
4.12 Paging The Handheld Monitor	17
5. Pairing Up Cameras	18
6. Help	20
7. Cleaning and Disposal	22
7.1 Cleaning	22
7.2 Disposal Of The Device	22
8. Notices	23
9. Technical Specifications	24
10. Mounting The Camera On A Wall / Ceiling	25
11. Replacing The Monitor Battery	27
12. Battery Saving Tips	28

1. HANDHELD MONITOR OVERVIEW



- 1. Display:** Displays video from the camera(s).
- 2. Up button / Increase volume:** Press to increase volume. Press to scroll up in menus.
- 3. Menu button:** Press to open / close the menu.
- 4. Left button / Decrease brightness:** Press to decrease the brightness of the display. Press to scroll left in menus.
- 5. Scan button:** Press to turn on Scan View. In Scan View, the monitor automatically switches between all connected cameras*. See "Scan View" on page 11 for details.
- 6. Down button / Decrease volume:** Press to decrease volume. Press to scroll down in the menu.
- 7. Power / Audio Level Indicator:** Top glows green to indicate power is on and flashes to indicate battery is low. Glow expands to indicate sound level.

- 8. **Ok button:** Press to select menu options. Press to save setting changes and exit the current menu screen.
- 9. **Talk button:** Press and hold to activate the intercom on the selected camera.
- 10. **Right button / Increase brightness:** Press to increase the brightness of the display. Press to scroll right in the menu.
- 11. **Cam button:** Press to switch between connected cameras*.
- 12. **Microphone**

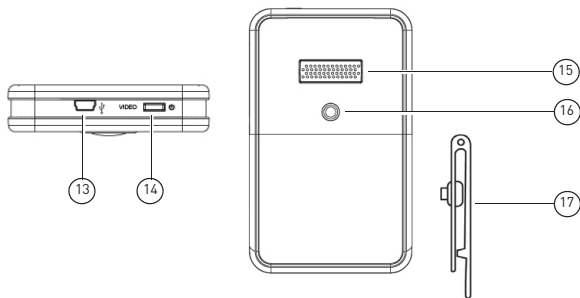

- 13. **AC adapter port:** Plug in the power adapter to charge the monitor.
- 14. **Power / Video button:** Press and hold for 3 seconds to power the monitor on / off. Press to enter / exit Sleep Mode (audio only monitoring).
- 15. **Speaker:** Allows you to listen to audio from the camera.
- 16. **Stand mounting hole:** Install the monitor stand by screwing it in here.
- 17. **Monitor Stand:** Stand doubles as a belt clip.

* Scan and Cam buttons only work if more than one camera has been paired with the handheld monitor.

Monitor icons overview

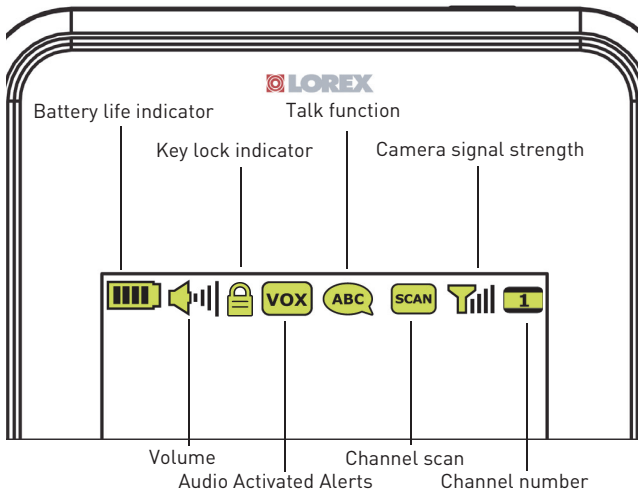

English

Reading the battery life indicator



The battery life indicator fills up when the monitor is charging and flashes when the battery is low.

NOTE: When the battery is fully charged, the handheld monitor can last up to 4 hours, or up to 7 hours in Sleep Mode (see page 16 for details). For overnight monitoring, use the included power adapter.

Reading the audio level indicator

- Wheel glows to display the sound level from selected camera.
- Green indicates no / quiet sound. Red expands as volume increases.

Medium sound



No / quiet sound



Loud sound



Reading the signal strength indicator



Signal strength icon flashes when signal is low.

NOTE: If you hear a beeping sound from the monitor, and your monitor displays "CAMERA NOT DETECTED":

- The camera may be out of range. Try placing the camera and monitor closer together.
- Camera may be powered off. Press and hold the **Power** button on the camera for 3 seconds to turn the camera on.
- You may have the wrong channel selected. Press the **CAM** button until the correct channel is shown.
- For more details, See "Help" on page 20.

2. CAMERA OVERVIEW

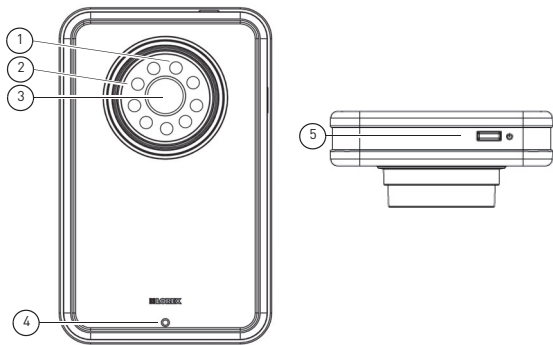

1. **Power Indicator LED:** Glows green to indicate camera power is on.
2. **Infrared LEDs:** Allow the camera to view in the dark. LEDs glow red when night vision is activated.
3. **Camera lens**
4. **Microphone**
5. **Power button:** Press and hold for 3 seconds to power camera on/off.

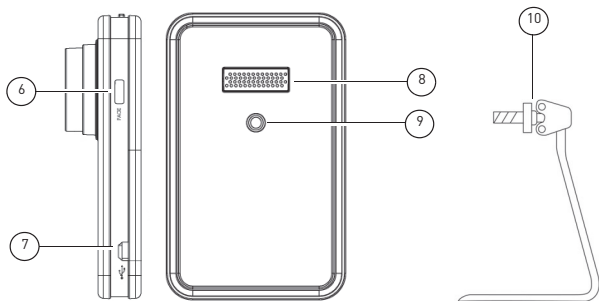

6. **Page button:** Press to page handheld monitor. Press and hold to connect camera to monitor when the pairing process is activated. See “Pairing Up Cameras” on page 18 for details.
7. **AC adapter port:** Plug in the camera power adapter here.
8. **Speaker:** Enables the camera to play sound from the monitor when the intercom is activated.
9. **Stand mounting hole:** Install the camera stand by screwing it in here.
10. **Camera stand:** Camera can be permanently mounted to a wall or ceiling. See “Mounting The Camera On A Wall / Ceiling” on page 25 for details.

3. GETTING STARTED

3.1 INSTALLING THE HANDHELD MONITOR STAND

NOTE: If a protective sleeve was included, attach it to your handheld monitor before installing the stand.

1. Screw the monitor stand into the stand mounting hole at the back of the handheld monitor.
2. Adjust the angle of the stand to your liking.

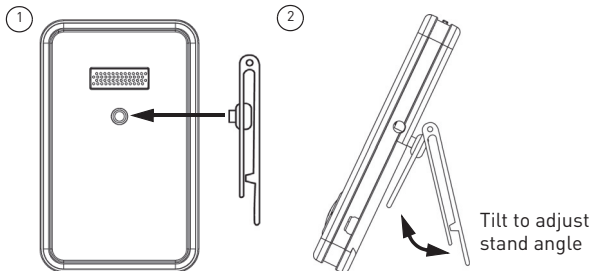

TIP: The handheld monitor stand can also be used as a belt clip, which allows you to keep the monitor with you at all times.

3.2 CONNECTING THE HANDHELD MONITOR

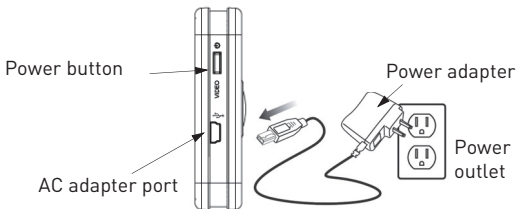

It is recommended to charge your monitor for **6 hours** before initial use.

1. Connect the power adapter to the AC adapter port on top of the monitor.
2. Plug the power adapter into a power outlet.
 - The battery life indicator will fill up when the monitor is charging.
3. Press and hold the **Power** button for 3 seconds to power on the monitor.

TIP: Charge the monitor for **6 hours** to fully charge. The monitor can remain on while charging.

3.3 SETTING UP THE CAMERA

NOTE: If a protective sleeve was included, attach it to the camera before installing the stand.

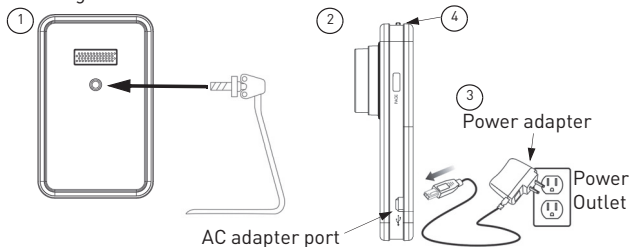

1. Screw the camera stand into the stand mounting hole at the back of the camera. See “Mounting The Camera On A Wall / Ceiling” on page 25 for mounting instructions.
2. Connect the AC power connector from the power adapter into the AC adapter port on the side of the camera.
3. Plug the power adapter into a power outlet.
4. Press and hold the **Power** button at the top of the camera for 3 seconds to power on the camera. A green LED turns on next to the lens to indicate power is on.
5. Adjust the camera so that it provides a satisfactory view of the area you would like to monitor.

ATTENTION:

- Only use the included power adapters with the monitor and camera(s).
- Place the camera in a location where the baby cannot easily reach or knock over the camera.
- Make sure all power adapter cables are out of arm’s reach of infants and children. **Keep them at least 3 ft. / 1m away.**

4. USING THE HANDHELD MONITOR

4.1 SELECTING THE CAMERA

By default, the included camera is paired to channel 1. If you have added additional cameras, press the **CAM** button to manually switch between camera channels, or press the **SCAN** button to automatically switch between connected cameras.

To add additional cameras or to move cameras to empty channels, simply follow the pairing process. See "Pairing Up Cameras" on page 18.

4.2 VIEWING OPTIONS

The monitor has 2 viewing modes:

- Full Screen
- Scan

Full Screen View

By default, the monitor is in Full Screen View. The channel number indicates the camera you are viewing.



Channel number indicator

Scan View

Scan View allows you to monitor multiple cameras in full screen. By default, Scan View automatically switches cameras every 5 seconds.

To enable Scan View:

Press the **SCAN** button while viewing. To return to full screen view, press the **SCAN** button again.

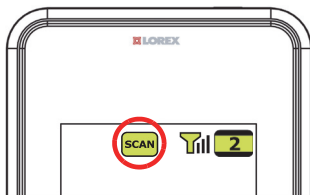

Scan View turned on

NOTE: Scan View will not work unless 2 or more cameras are connected. The monitor only shows cameras that are paired up and turned on.

4.3 ADJUSTING VOLUME

To adjust the volume, press the ▲ ▼ buttons during viewing.

When the volume is set to 0, a mute icon (🔇) is shown.

Tips to avoid speaker squealing:

- Place the camera and monitor at least 1ft. apart.
- Lower the monitor volume.

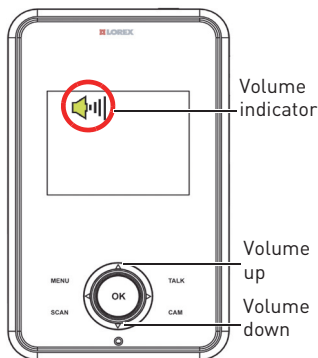

4.4 TALK FUNCTION

Press and hold the **TALK** button. Your voice will be heard on the selected camera and a talk icon (ABC) is shown.

NOTE: To listen to audio from the camera, you must release the TALK button. You cannot talk and listen at the same time.

4.5 ADJUSTING SCREEN BRIGHTNESS

To adjust the screen brightness, press the ◀ ▶ buttons while viewing. Press the ▶ button to increase brightness and the ◀ button to decrease brightness. A brightness indicator appears to show the current brightness level.

NOTE: Brightness is set to 3 (out of 5) by default. Decreasing the brightness will increase the battery life of the monitor.

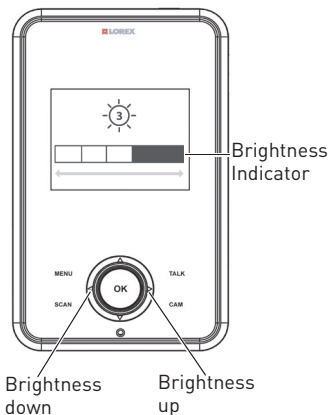

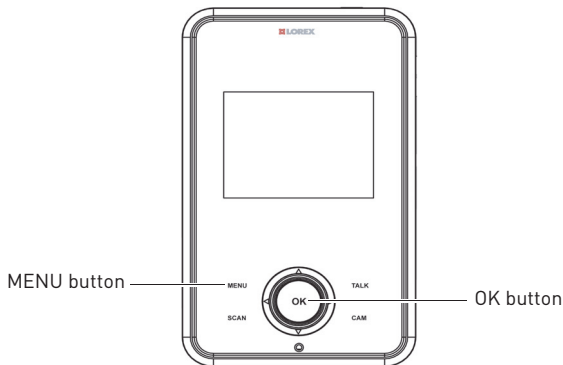

4.6 NAVIGATING THE MENU

To open the monitor menu, press the **MENU** button.



Use the ◀ ▶ ▲ ▼ buttons to switch between menu options, and press **OK** to select menu options or save changes to your settings. Press **MENU** to exit a menu or submenu *without* saving your changes.

4.7 MENU OPTIONS

<p>VOICE TRIGGER</p> 	<p>Enable Sound Activated Alerts and adjust volume sensitivity for Sound Activated Alerts.</p>
<p>SCAN DURATION</p> 	<p>Adjust the length of time the monitor shows a camera before switching to the next camera in Scan View.</p>
<p>PAIRING</p> 	<p>Add a new camera to the monitor or change the order of connected cameras.</p>

4.8 VOICE TRIGGER (AUDIO ACTIVATED ALERTS)

In Voice Trigger mode, the monitor goes into standby. When sound is detected by the camera at the preset audio level, the monitor's screen instantly turns on. This conserves battery power, and alerts you only when needed.

To turn on Voice Trigger and set the sensitivity level:

1. Press the **MENU** button.
 2. Press ◀ ▶ until **VOICE TRIGGER** is shown and press **OK**.
 3. Press ◀ ▶ to select the volume sensitivity. On the lowest setting, Audio Activated Alerts are turned *off*. As you turn up the sensitivity, alerts will be activated by quieter noises.
 4. Press **OK** to save your changes and **MENU** to return to viewing.
- When Voice Trigger is enabled, a VOX icon appears in the display.

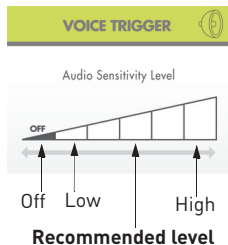

TIP: Medium sensitivity is recommended (3 bars).

NOTE: If you want softer noises to trigger the monitor (such as a faint whimper), set the sensitivity setting HIGHER. If you only want louder noises to trigger the monitor (such as a loud cry), set the sensitivity setting LOWER.

4.9 SLEEP MODE (AUDIO ONLY MODE)

Sleep Mode allows the monitor display to be turned off while continuing audio monitoring. This is also a great way to conserve battery life.

To enter Sleep Mode:

Press the **VIDEO** button at the top of the monitor. The monitor turns off the screen but will continue to play audio from the selected camera.

Press the **VIDEO** button again to exit Sleep Mode.

Note: Voice Trigger mode will not work when Sleep Mode is activated. The screen will remain off until the **VIDEO** button is pressed.



Press VIDEO button to enter / exit Sleep Mode

4.10 ADJUSTING SCAN DURATION

By default, Scan View switches cameras every 5 seconds. You can adjust this time to a number of pre-set options.

To change the time cameras will be shown before switching:

1. Press the **MENU** button.
2. Use the ◀ ▶ buttons to until **SCAN DURATION** is shown and press **OK**.
3. Use the ▲ ▼ buttons to select the amount of time you would like cameras to be shown before switching.
4. Press **OK** to save your changes and press **MENU** to return to viewing.



4.11 KEY LOCK

Key Lock prevents any of the buttons on the monitor from being pressed by accident.

To activate / deactivate Key Lock:
Press and hold the **OK** button for 3 seconds.

When Key Lock is active, a lock icon appears on the monitor.



Key Lock icon

4.12 PAGING THE HANDHELD MONITOR

If you cannot find the handheld monitor, press the **PAGE** button on the side of the camera to page it. The monitor makes a beeping sound for 30 seconds.

Press any button on the monitor to turn off the beeping.

NOTE: The Page function will not work if the handheld monitor is turned off or if the battery has died.

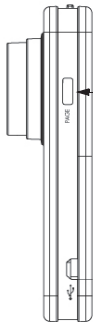

Press the **PAGE** button on the camera to page the monitor

5. PAIRING UP CAMERAS

The camera(s) included have already been paired up with the monitor. If for any reason your monitor and camera are not paired up, **OR** if you have purchased additional add-on cameras (model # LW2004AC1), follow the steps below.

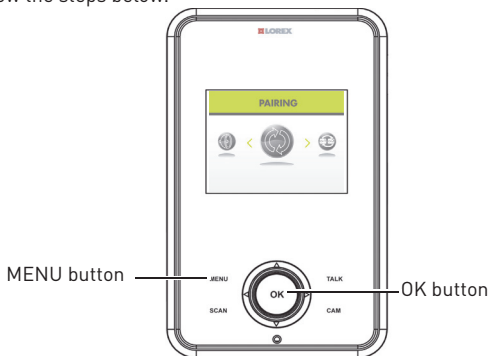

To pair a camera to your monitor:

1. Place the camera and monitor around 1 ft. apart.
2. Make sure the camera you would like to pair up is powered on.
3. Press the **MENU** button on the monitor to open the menu.
4. Press the ◀ ▶ buttons until the **PAIRING** option is shown and press **OK**.

- Select the channel you wish to pair up the camera to by pressing the ▲ ▼ buttons.
- Press **OK**. The monitor displays a "PAIRING" message on the screen.

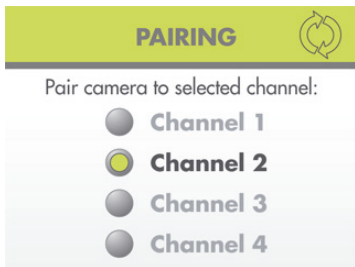

- Press and hold the **PAGE** button on the side of the camera. The monitor displays "Device Found" when the camera has been successfully paired.

NOTE:

- The monitor can connect to up to 4 cameras.

TIPS:

- Immediately after successful pairing, move the camera and monitor apart to avoid speaker feedback.

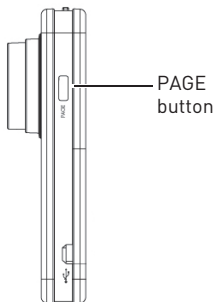

6. HELP

No video displayed on the monitor

- Ensure the camera(s) is plugged into a power outlet and is powered on.
- Ensure the monitor is powered on.

1. If the power LED is off:

- Press and hold the **Power** button on the top of the monitor for 3 seconds to power on the monitor.
- Recharge the monitor battery.

2. If the power LED is on:

- The monitor is in Sleep Mode. Press the **VIDEO** button to turn on the screen.
- The monitor is in Voice Trigger mode. Press any button to turn the screen on.
- Reset the monitor by disconnecting the power adapter and removing the battery. Then re-insert the battery.

The camera and monitor are not detecting each other

- Ensure you have selected the correct camera channel. Press the **CAM** button to switch channels.
- Make sure the camera is plugged in.
- Make sure the camera is powered on.
- The camera and monitor may be out of range. Move the monitor and camera closer together.
- You may need to pair the camera and the monitor again. See "Pairing Up Cameras" on page 18 for details.

Feedback / squealing noise coming from the monitor

- Your camera and monitor may be too close to each other. Move them further apart.
- For optimal performance, avoid placing the monitor and camera near televisions, computers, cordless/mobile phones, or other electrical equipment.
- Lower the monitor volume.

7. CLEANING AND DISPOSAL

7.1 CLEANING

Clean the monitor and camera with a slightly damp cloth or an anti-static cloth. Never use cleaning agents or abrasive solvents.

- Do not clean any part of the product with cleaners with thinners or other solvents and chemicals. This may cause permanent damage to the product, which is not covered by the Warranty. When necessary, clean it with a damp cloth.
- Keep your camera and monitor away from hot, humid areas or strong sunlight, and do not get it wet.
- Every effort has been made to ensure high standards of reliability for your baby monitor. However, if something does go wrong, please do not try to repair it yourself. Contact Customer Service for assistance.

7.2 DISPOSAL OF THE DEVICE

At the end of the product lifecycle, you should not dispose of this product with normal household waste, but take the product to a collection point for the recycling of electrical and electronic equipment. The symbol on the product, user's guide, and/or box indicates this.

Some of the product materials can be re-used if you take them to a recycling point. By reusing some parts or raw materials from used products you make an important contribution to the protection of the environment.

Please contact your local authorities in case you need more information on the collection points in your area. Dispose of the battery pack in an environmentally-friendly manner according to your local regulations.



8. NOTICES

Warning: Any changes or modifications not expressly approved by the grantee of this device could void the user's authority to operate the device.

FCC Notice

This device complies with Part 15, subpart C, of the FCC Rules. Operation is subject to the following two conditions: (1) this device may not cause harmful interference, and (2) this device must accept any interference received, including interference that may cause undesired operation.

The manufacturer is not responsible for any radio or TV interference caused by unauthorized modifications to this equipment. Such modifications could void the user's authority to operate the equipment.

However, it is imperative that the user follows the guidelines in this manual to avoid improper usage which may result in damage to the unit, electrical shock and fire hazard injury.

In order to improve the features, functions, and quality of this product, the specifications are subject to change without notice from time to time.

Caution: To maintain compliance with the FCC's RF exposure guidelines, place the camera at least 20cm (7.87in) from nearby persons.

The video monitor has been tested and meets the FCC RF exposure guidelines when used with the belt clip supplied with or designated for this product. Use of other accessories may not ensure compliance with FCC RF exposure guidelines.

Canada/IC Notice

This device complies with Industry Canada licence-exempt RSS standard(s). Operation is subject to the following two conditions: (1) this device may not cause interference, and (2) this device must accept any interference, including interference that may cause undesired operation of the device.

Le présent appareil est conforme aux CNR d'Industrie Canada applicables aux appareils radio exempts de licence. L'exploitation est autorisée aux deux conditions suivantes: (1) l'appareil ne doit pas produire de brouillage, et (2) l'utilisateur de l'appareil doit accepter tout brouillage radioélectrique subi, même si le brouillage est susceptible d'en compromettre le fonctionnement.

CE 1313 The Lorex Live View Handheld Video Monitor model LW2004 is in compliance with the essential requirements and other relevant provisions of Directive 1999/5/EC.

9. TECHNICAL SPECIFICATIONS

Camera

Frequency	2.4 to 2.4835 GHz
Maximum Range	Up to 450 ft. / 135m outdoors* / Up to 150 ft. / 46m indoors* *Based on unobstructed line of sight. Actual range will vary depending on surroundings.
Image Sensor	Color CMOS
Lens	6.1mm F2.8
IR LED	9 pcs
Power	Adapter: DC 5V, 600mA

Video Monitor

Frequency	2.4GHz to 2.4853GHz
Display	2.4" TFT LCD
Display colors	262K
Power	Adapter: DC 5V, 1000mA Battery: 3.7V, 1050mA

10. MOUNTING THE CAMERA ON A WALL / CEILING

The camera comes with a versatile stand that can be placed on a flat surface, such as a table or dresser, or can be permanently mounted to a wall or ceiling.

To mount the camera:

1. Determine where you would like to mount the camera. The position of the stand changes depending whether you choose to mount the camera on a wall or ceiling.

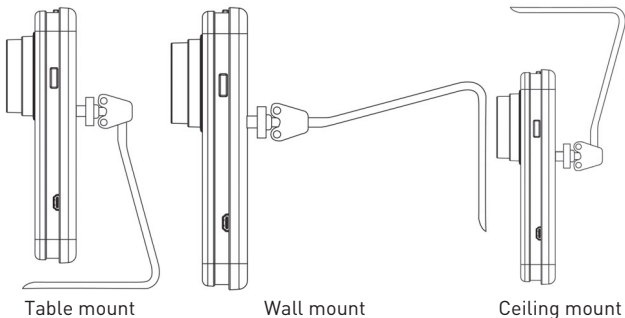

2. Place the camera stand against the wall or ceiling (you should keep the camera separate from the stand while doing this and attach it later) as shown below.

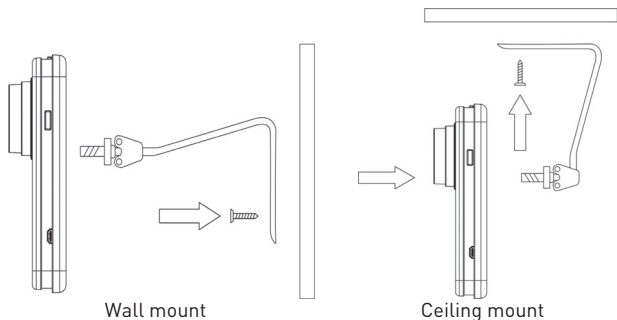

2. Use a pen or pencil to mark the locations where you will need to drill holes for the mounting screws.
3. Remove the mounting stand from the wall or ceiling and drill holes for the mounting screws.
4. Return the mounting stand to the wall or ceiling and insert the included mounting screws into the holes and tighten the screws all the way.
5. Attach the camera to the stand and adjust the camera so that it provides a satisfactory view of the area you would like to monitor.

11. REPLACING THE MONITOR BATTERY

NOTE: The monitor battery has been pre-installed for your convenience. Replacement batteries are available at www.lorextechnology.com

Changing the monitor battery:

NOTE: Unplug the monitor power adapter before changing the battery.

1. Push down on the cover and slide it off of the monitor.
2. Remove the existing battery by placing your finger in the notch at the bottom of the battery compartment and pulling the battery towards you to remove it.
3. Align the metallic contact points on the new battery with the metallic contact points on the monitor by ensuring the \oplus \ominus symbols are shown in the top-left corner.
4. Press down on the battery so it is held firmly in place inside the compartment.
5. Replace the cover on the monitor.

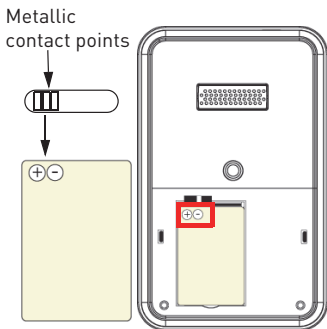

NOTE: To improve the life and longevity of your battery, see “Battery Saving Tips” on page 28.

12. BATTERY SAVING TIPS

Follow the tips below to improve the life and longevity of your battery.

- Turn down the screen brightness on the handheld monitor. Press ◀ ▶ while viewing to adjust the brightness.
- Use Sleep Mode to turn off the screen and monitor audio only. Press the **VIDEO** button to activate/deactivate sleep mode. **OR**
- Use Voice Trigger Mode to turn off the screen until sound is detected. See “Voice Trigger (Audio Activated Alerts)” on page 15 for details.
- Only charge the monitor battery when the battery is low (the battery icon flashes to indicate battery is low).
- Use the monitor power adapter when monitoring at night, and keep the monitor unplugged while monitoring during the day.
- Remove the battery during long periods of non-use.
- Remove the battery if you intend to leave the monitor plugged in all the time.



LOREX[®]
VIEW YOUR WORLD™

LIVE VIEW

LW2004 SERIES

Version 1.0

www.lorexttechnology.com

Copyright © 2011 Lorex Technology Inc.