

User's Manual (Installation instructions)

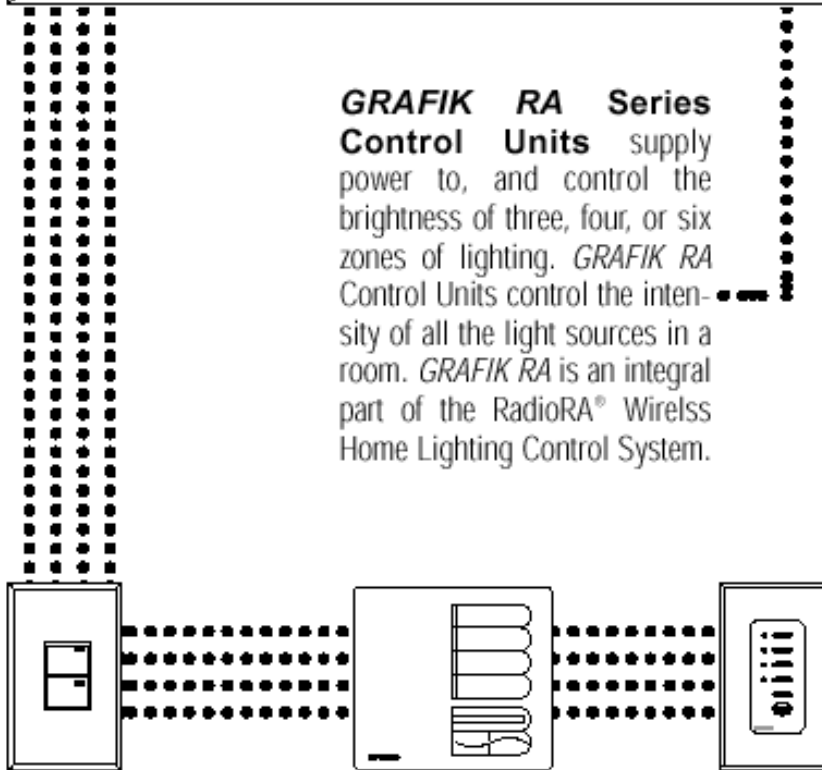

GRAFIK RA Series Control Units supply power to, and control the brightness of three, four, or six zones of lighting. *GRAFIK RA* Control Units control the intensity of all the light sources in a room. *GRAFIK RA* is an integral part of the RadioRA® Wireless Home Lighting Control System.



IMPORTANT! *GRAFIK RA* lighting controls must be installed by a qualified electrician in accordance with all applicable regulations. Improper wiring can result in personal injury or damage to *GRAFIK RA* lighting controls or other equipment. Always turn off circuit breaker/MCB or remove main fuse from power line before doing any work. To avoid overheating and possible damage to equipment, do not install dimming devices to dim receptacles, motor-operated appliances, or fluorescent lighting not equipped with Lutron Hi-Lume®, Eco-10™, or Yu-Wire™ Electronic Dimming Ballasts. In dimmed magnetic low-voltage circuits, you can prevent transformer overheating and failure by avoiding excessively high current flow. Do not operate *GRAFIK RA* lighting controls with any lamps removed or burned out; Replace any burned out lamps immediately. Use only transformers that incorporate thermal protection or fused primary windings. This lighting control is designed for residential and commercial use. *GRAFIK RA* Controls are designed for indoor use only.



User's Manual (Installation instructions)

Do you have:	Then read this on page:
Control Unit only? Follow Step 1 and Step 3	STEP 1: Installing GRAFIK RA Control Units How to wire and mount GRAFIK RA Control Units.	3
Accessory Controls too?	STEP 2: Installing Accessory Controls DIP switch address settings, wiring, and mounting.	4
	STEP 3: Setting Up Control Units Identifying load types and setting up lighting scenes.	6
	STEP 4: Setting Up System Communications Assigning Accessory Controls to the Control Units they should operate.	10
Questions about Class 2/PELV wiring?	Appendix A: More about Class 2/PELV Wiring	12
	Appendix B: Special Mounting Considerations	14
	Appendix C: Power Boosters, Electronic Low Voltage Interfaces, and Fluorescent Dimming Ballast Interfaces	14
	Appendix D: GRX-TVI 0-10 Volt Ballast Interface	15
	Appendix E: HP 2•4•6 Dimming Modules	17
	Appendix F: Infrared Controls	18
Problems?	Appendix G: Troubleshooting	18

Questions? Need technical assistance?

Phone Assistance . . . Worldwide!

- **In the U.S., Canada and the Caribbean:**
1-800-523-9465
- **In Mexico, Central and South America:**
1-610-282-3800
- **In Japan:** 03-5405-7333
- **In Hong Kong:** 2104-7733
- **In the U.K.:** 0800-282-107
- **In Europe:** 44-171-702-0657
- **All others:** 1-610-282-3800
- **Website address:** www.lutron.com
- **E-mail:** product@lutron.com

Warranty

Lutron warrants each new unit to be free from defects in materials and workmanship and to perform under normal use and service. This warranty shall run only for a period of one year from the date of purchase and Lutron's obligations under this warranty are limited to remedying any defect or replacing any defective part and shall be effective only if the defective unit is shipped to Lutron postage prepaid within 12 months after purchase. Damage due to abuse, misuse, inadequate wiring or installation is not covered by this warranty. In no event shall Lutron or any other seller be liable for any other loss or damage, including consequential or special damages that may arise through the use by a purchaser or others of this device and the purchaser assumes and will hold harmless Lutron in respect of all such loss. Although every attempt is made to ensure that catalogue information is accurate and up-to-date, please check with Lutron before specifying or purchasing this equipment to confirm availability, exact specifications and suitability for your application. This product may be covered by one or more of the following U.S. patents: 4,797,599; 4,803,380; 4,825,075; 4,893,062; 5,030,899; 5,191,265; 5,430,366; 5,463,286; 5,530,322; 5,800,417; DES 308,647; DES 310,349; DES 311,170; DES 311,371; DES 311,382; DES 311,485; DES 311,678; DES 313,738; DES 335,867; DES 344,264; DES 370,663; DES 378,814 and corresponding foreign patents. U.S. and foreign patents pending. Lutron, GRAFIK Eye, RadioRA, and Hi-Lume are registered trademarks; GRAFIK RA, Hi-Power, Eco-10, LANSON, Designer, Tu-Wire, and Architrave are trademarks of Lutron Electronics Co., Inc. © 2001 Lutron Electronics Co., Inc.



Safety standards listed above apply to one or more products in the GRAFIK Eye and GRAFIK RA product line. Consult factory for specific information.

User's Manual (Installation instructions)

STEP 1: Installing *GRAFIK RA* Control Units

This section shows how to install Control Units and make sure they are properly operating all connected loads.

CAUTION!

First test loads for short circuits.

1. Turn power OFF at the breaker/MCB panel or fuse box.
2. Connect standard light switch between live lead and the load wire to test circuit.
3. Turn power on and check for short or open circuits: If load does not operate, circuit is open. If the breaker/MCB trips (fuse blows or opens), circuit is shorted. Correct short or open circuits and test again.



Load Types

The *GRAFIK RA* Control Units can control incandescent, halogen (tungsten), magnetic low-voltage, and neon/cold cathode load types. Electronic low-voltage and fluorescent load types can be controlled with an appropriate interface.

- Not all zones need to be connected; however, connected zones must have a load of at least 25W.
- No zone may be loaded with more than 800 W.
- Unit must not carry more than 16A of total lighting load.
- All Electronic Low-Voltage (ELV) lighting used with the Electronic Low-Voltage Interface must be rated for **reverse phase-control dimming**. Before installing an ELV light source, verify with the manufacturer that their transformer can be dimmed. When dimming, an Electronic Low-Voltage Interface **MUST** be used with the Series Control Unit.

Control Unit Capacities

Model Number	Wallbox Size/Max. Unit Load
RA-GRX-3/RB-GRX-3	3-Gang U.S./1500W/VA
RA-GRX-4/RB-GRX-4	4-Gang U.S./2000W/VA
RA-GRX-6/RB-GRX-6	4-Gang U.S./2000W/VA

† Lutron offers a 4-gang wallbox, P/N 241-400.

Installation instructions. First, turn power off.

Preparation

1. **Mount Wallbox.** Use standard U.S. wallbox, 3 1/2 in. (87 mm) deep is strongly recommended, 2 3/4 in. (68 mm) deep minimum. Always allow at least 4 1/2 in. (110 mm) clearance above and below the faceplate to ensure proper heat dissipation.
2. **Pull Wires.** Use the rearmost knockouts when pulling wires into the wallbox. This will provide the most clearance when mounting the Control Unit.
3. **Remove Cover.** Remove the Control Unit's cover and hinged faceplate by pulling outward at each corner.

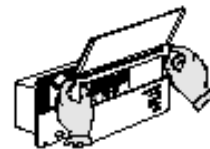
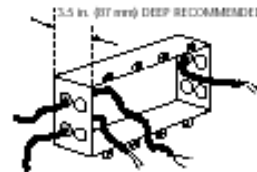

Line Voltage/Mains Wiring

IMPORTANT WIRING NOTES!

- Use properly certified cable for all line voltage/mains cables and Class 2/PELVY cables.
- In Europe, acceptable types of cable include HAR certified cable with insulated cores enclosed in a sheath. This cable must bear the appropriate certification mark pertaining to national wiring rules for load installations. If certified cable with insulated cores enclosed in a sheath is used for the Power cables, the Class 2/PELVY wiring can be any of the specified cables in **Appendix A: More about Class 2/PELVY Wiring**.
- Proper short-circuit and overload protection must be provided at the distribution panel. You can use up to a 20A maximum circuit breaker/MCB or equivalent (tripping curve C according to IEC60898/EN60898 is recommended) with adequate short-circuit breaking capacity for your installation.
- Install in accordance with all local and national electrical codes.
- **CAUTION!** Do not connect line voltage/mains cable to Class 2/PELVY terminals.
- Earth/Ground terminal connection must be made as shown in wiring diagrams.
- Do not mix different load types on the same zone!
- Fluorescent and electronic low voltage loads require interfaces. Zone loads that exceed 800W/VA and total unit loads that exceed the unit capacity require power boosters. Refer to Appendices C, D, E, and F.

Wire the Control Unit (see Page 16)

1. Strip 1/2 in. (12 mm) insulation from all wires in wallbox and connect them to appropriate terminals on the back of the Control Units. The recommended installation torque is 9.0 in.-lbs. (1.0 N-m) for line-voltage connections and 10 in.-lbs. (1.3 N-m) for the earth/ground connection. Each power terminal can accept up to two #12 AWG (2.5 mm) wires. (Does not apply to Class 2/PELVY terminal block.)

User's Manual (Installation instructions)

Class 2/PELV Wiring

Connect Class 2/PELV wiring only if your project has Accessory Controls and/or more than one Control Unit.

Use recommended cable as specified in **Appendix A: More About Class 2/PELV Wiring**.

Wiring Note

- Use the rearmost knockouts when pulling wires into the wallbox. This will provide the most clearance when mounting the Control Unit.
1. Strip 1 in. (25 mm) of insulation from the Class 2/PELV cable.
 2. Strip 3/8 in. (9.5 mm) of insulation from each wire.
 3. **Connect the Class 2/PELV wires to the Class 2/PELV terminal block.** Make sure no bare wire is exposed after making connections. The recommended installation torque is 3.5 in.-lbs. (0.4 N•m) for Class 2/PELV connections.
 4. The Class 2/PELV cable and terminal block should be separated from line voltage/mains cables by at least 1/4 in. (7 mm).

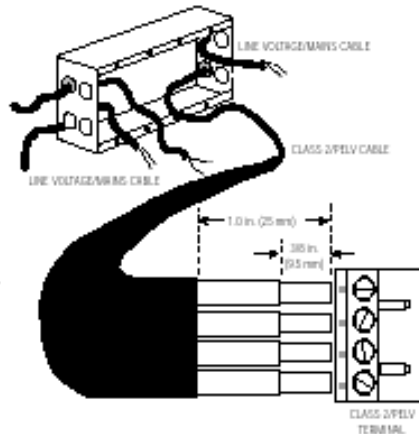

Mounting

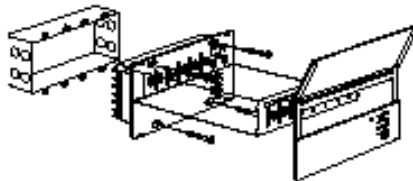

1. Mount as shown using the four screws provided. (When mounted in the wallbox, the Class 2/PELV cable and terminal block should remain separated from the line voltage/mains cables.)
2. Reattach the faceplate to the Control Unit by pushing inward at each corner.

Testing: Do the lights work?

1. **Restore Power.**
2. **Press Scene 1 button** on front of the GRAFK RA Control Unit. The Scene 1 LED will light.
3. **Press zone** **or** **to raise or lower the light levels.** Make sure that the Control Unit is dimming all connected loads. Refer to **Appendix G: Troubleshooting**, or call Lutron.

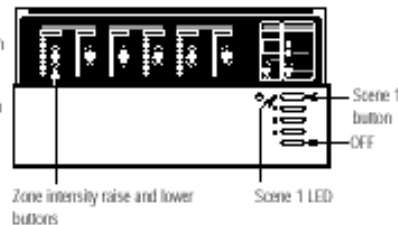

STEP 2: Installing Accessory Controls

IMPORTANT WIRING NOTES!

Review Appendix A BEFORE wiring!

- Accessory Controls must be installed by a qualified electrician.
- Accessory Controls use Class 2 or PELV wiring methods as applicable in your locale.
 - **Using Class 2 wiring methods:** Accessory Controls must be connected in accordance with the 1996 National Electrical Code, Article 725-54(a), (1) Exception No. 3 or the Canadian 1994 CE Code Handbook, Rule 16-212, Subrule (4). Check with your local electrical inspector to comply with local codes and wiring practices.
 - **Using PELV wiring methods:** Accessory Controls that are connected to terminals 1—4 must always meet the requirements of DIN VDE 0100 Part 410 and IEC 60364-4-41 for PELV circuits. See "What is PELV?" in Appendix A.
- Accessory Controls must be mounted in a wallbox. Please refer to instruction sheet included with each Accessory Control to determine wallbox requirements.
- Note that the NTGRX-1S can use line voltage/mains branch circuit wiring. Refer to the installation instructions packaged with the Accessory Control.

Examples of Accessory Controls

NTGRX-2B-SL	Entrance/Special Function Control
NTGRX-4S	Scene Selection Control with Raise/Lower
NTGRX-4S-IR	Scene Selection Control/Infrared Receiver
NTGRX-4B	Scene Selection Control
NTGRX-4M	Master Control
NTGRX-4PS	Position Control
GRX-C-IR*	Infrared Ceiling Receiver
GRX-4S-DW*	Architrave™ Door Jamb Control
GRX-AV*	Interface Control
GRX-RS232*	RS-232 Interface Control
GRX-PRG*	Personal Computer Interface
GRX-IT/GRX-BIT	Infrared Handheld Transmitter (see Appendix C)
EGRX-4S*	European Style 4S Control
EGRX-4S-IR*	European Style 4S Control/Infrared Receiver

... and more!

User's Manual (Installation instructions)

Set DIP switches 1—4 with unique system address

Each Accessory Control must have a unique system address (1—16) to identify the Accessory Control and enable it to communicate with the Control Unit. To set its address, set DIP switches 1—4 to one of the configurations shown at right (GRX-PRG automatically assumes address 16). Document your assignments by noting each Accessory Control's address.

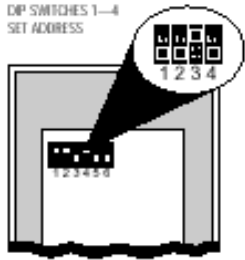

FOR THIS ADDRESS ...

	SET SWITCHES LIKE THIS:	RECORD LOCATION AND TYPE OF CONTROL HERE		SET SWITCHES LIKE THIS:	RECORD LOCATION AND TYPE OF CONTROL HERE
1			9		
2			10		
3			11		
4			12		
5			13		
6			14		
7			15		
8			16		

* Reserved for GRX-PRG, if present on link.

Set DIP switches 5, 6 and/or 7 to specify function

For most Accessory Controls, you must also set DIP switches to specify exactly how the Accessory Control is to function. Please refer to the instructions shipped with each Accessory Control for more detailed information.

NTGRX-4S, -4S-D/W, -4S-IR, -CIR, -4B

Scene Selection Control

Switches 5 and 6 determine which scenes the unit will select:

Scenes 1 to 4		Scenes 9 to 12*	
Scenes 5 to 8*		Scenes 13 to 16*	

NTGRX-4M

Master Control

Switches 5 and 6 determine whether bottom button turns lights on or off:

ON only		OFF only	
---------	--	----------	--

NTGRX-2B-SL

Multi-Control

Switches 5, 6 and 7 determine the function of the unit's two buttons:

Scene 1 and Off		Fine-Tuning Control	
Scene 9/ Scene 10*		Partition Status	
Scene 13/ Scene 14*		Zone Lockout	
Panic Control		Sequencing Scenes 5—16*	

* When using an Accessory Control to access scenes 5—16, the scene LEDs will illuminate only on the Accessory Control—not on the GRAFIK Eye Control Unit.

Turn off power and wire

Review Appendix A: More About Class 2/PELV Wiring before proceeding!

1. Mount 1-gang U.S. wallbox*, 2 3/4 in. deep (68 mm) **minimum**.
2. Strip 3/8 in. (9 mm) insulation from both twisted pairs in the wallbox.
3. Connect two #18 AWG (1.0 mm²) twisted pairs for Class 2/PELV wiring (daisy-chain between stations)¹.
4. Confirm all connections.

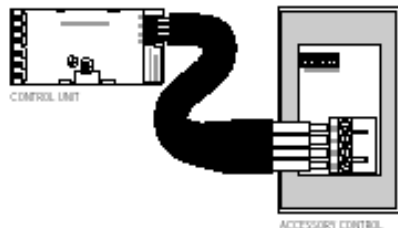

Mounting

Place twisted pairs in wallbox and mount as shown. Restore power.

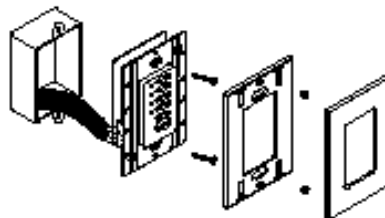

* Some Accessory Controls have special mounting considerations. Please refer to the detailed instructions supplied with each Accessory Control.

¹ If shielded wire is used, the drain wire must also be daisy-chained. **Do not** connect drain wire to earth/ground or Accessory Control (unless a "0" terminal is present).

User's Manual (Installation instructions)

STEP 3: Setting Up *GRAFIK RA* Control Units

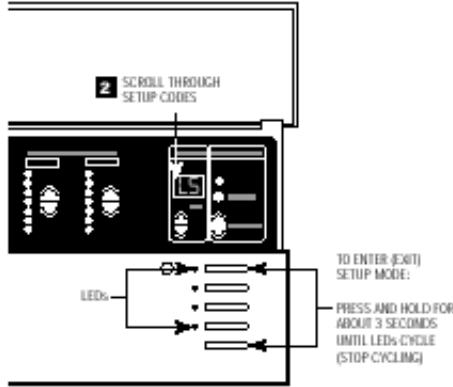

This section shows how to set up a *GRAFIK RA* Control Unit, including:

- Identifying the load type for each zone of lighting connected to the Control Unit.
- Setting up the scenes to create the desired lighting effects, and make sure the Control Unit is working correctly.

To set up the *GRAFIK RA* Control Unit, enter the "setup mode" and use the menu of setup codes that appear in the FADE window. Step-by-step instructions for using the setup codes are on the following pages.

How to enter and exit setup mode

To enter setup mode: Press and hold the Scene 1 and OFF button for about three seconds, until the scene LEDs start cycling.

To exit setup mode: Exit setup mode the same way you entered it. Press and hold the Scene 1 and OFF button for about 3 seconds, until scene LEDs stop cycling. The Control Unit is out of setup mode; back in normal operating mode. In setup mode, the FADE window displays the setup codes. To scroll through the menu of setup codes, press the FADE or buttons.

The following is a list of the setup codes and their descriptions:

Code	Stands for	Description
Sd	Save Options	Select from several save options (p. 9)
Sc	Scene	Set unaffected zones and set any of the 16 scenes (p. 9)
R-	Address	Identify Control Units when setting up system communications (p. 10)
LS*	Load Select	Identify load type (p. 7)
LE	Low End	Set low end trim (p. 8)

- *When you enter setup mode, this code appears first.
- If you press FADE , you will see R-, Sc, then Sd.
 - If you press FADE , you will see LE.

Identifying the load type for each zone

Lutron ships *GRAFIK RA* & *GRAFIK Eye* Control Units with all zones set for incandescent/halogen (tungsten) lighting. If your project has non-incandescent loads, change all non-incandescent zones to the correct load type.

1. **Enter setup mode.** Press and hold Scene 1 and OFF buttons for about 3 seconds, until scene LEDs cycle.
2. **Check for LS in FADE window.** (LS is the first code to appear when you enter setup mode. For the LS mode, ZONE LEDs turn on from top to bottom.)
3. **Set each zone's load type.** Press ZONE and until ZONE LEDs match the load type connected to each zone. Refer to chart on next page.
4. **Exit setup mode.** Press and hold Scene 1 and OFF buttons for about 3 seconds, until scene LEDs stop cycling.

In the 6-Zone Control Unit shown here:

- Zone 5 is set for incandescent or magnetic low-voltage.
- Zone 6 is set for neon/cold cathode.

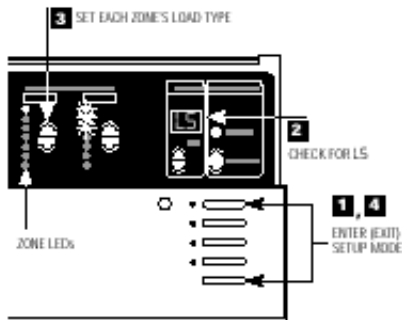

User's Manual (Installation instructions)

FOR TRG LOAD TYPE...	INCANDESCENT HALOGEN (TRIMESTEM)	MAGNETIC LOW VOLTAGE	HP 2+4+6 LOADS ¹ (120V SUPPLY ONLY)	ELECTRONIC LOW VOLTAGE ²	Hi-Lume [®] OR Eco-10™ FLUORESCENT ³	TU-TUBE™ COMPACT FLUORESCENT ⁴	NEON/COLD CATHODE	NO DIM ⁵ (LAST ON, FIRST OFF)	NON-DIM ⁶ (FIRST ON, FIRST OFF)
----------------------	----------------------------------	----------------------	--	-------------------------------------	--	---	-------------------	--	--

- Set all zones connected to HP 2+4+6 Dimming Modules as shown—no matter what load type they are (including non-dim or switching). The HP 2+4+6 can be used to switch non-capacitive ballasts. To fine-tune the dimming of these "HP-powered" zones, you must adjust high and low end trim on the HP 2+4+6 Dimming Module as described in the Instruction Sheet supplied with the unit. Do **NOT** use HP 2+4+6 Dimming Modules with generator-supplied line/mains voltage.
- All electronic low-voltage (ELV) lighting used with the Electronic Low-Voltage Interface (ELVI) must be rated for reverse phase control dimming. Before installing an ELV light source, verify with the manufacturer that their transformer can be dimmed. When dimming, an ELVI **MUST** be used with the 3000-Series Control Unit.
- Any zones set for Lutron Hi-Lume or Eco-10 fluorescent lighting **must** have GRX-FDBI or GRX-TV Fluorescent Interfaces. Consult Lutron for more information.
- Please note that the Tu-Tube Compact Fluorescent, unlike other fluorescent load types, **does not** require an FDBI interface. This load type is not available in GRX-CE models.
- Use non-dim for any lights to be switched on and off only—not dimmed (unless using HP Dimming Module).
 - Fluorescent non-dim loads with electronic or magnetic ballasts must use a GRX-TV Interface and be set for non-dim mode, or use an HP 2+4+6 and be set for HP 2+4+6 loads.

What is a scene?

Scenes are the preset light levels and fade times stored in the Control Unit. To create a scene, set the appropriate intensity for each ZONE. To recall a scene, simply press one of the buttons. The first button calls up Scene 1; the second, Scene 2; and so on. The last button turns lights OFF. For example, typical scene settings for a living room might be:

SCENE	ACTIVITY OR EVENT	LIGHT LEVELS FOR ZONES			Scenes
		Cove Lights	Hanging Lights	Down Lights	
1	General use	70%	10%	20%	20%
2	Entertaining	80%	25%	90%	40%
3	Reading	10%	60%	40%	0%
4	TV	20%	0%	30%	20%

Scenes 1—4 can be selected on the Control Unit. However, all Control Units are capable of storing up to 16 scenes. Scenes 5 through 16 can be selected using Wallstations.

How to set up lighting scenes

Note: Control Unit must be in **5d** mode. See page 9 for more information regarding Save Options.

To set up scenes 1 through 4:

- Select a scene.** Press the Scene button for the scene you want to adjust. (First button for Scene 1, second button for Scene 2, and so on.) Note that the last button is the "OFF" Scene. You do not set intensities for this button.
- Set each zone's light levels.** Press ZONE [] and [] to adjust each ZONE to the right visual intensity for this scene. (ZONE LEDs show intensity bargraph-style. Each LED represents a 15% intensity change. In this example, ZONE 6 is set to 60%.) To program scenes 5 through 16, refer to page 8.
- Set scene's FADE-in time.** Press FADE [] and [] to make FADE-in time anything from 0—59 seconds or 1—60 minutes*. (*A scene's FADE-in time is how long it takes light intensities to adjust to their new levels when the scene is selected.)

Repeat this process to set up each of the remaining scenes. Note that you can also set up a "FADE-to-off" time. Press the OFF button and adjust FADE as desired.

* The S and M indicators under the FADE window show whether FADE is "M"inutes or "S"econds. To set FADE in minutes, you press FADE [] to scroll through 1—59 seconds ... the M lights. FADE is now expressed in minutes. To get back to seconds, press FADE [] until the window shows "S"econds.

User's Manual (Installation instructions)

How to adjust light levels temporarily

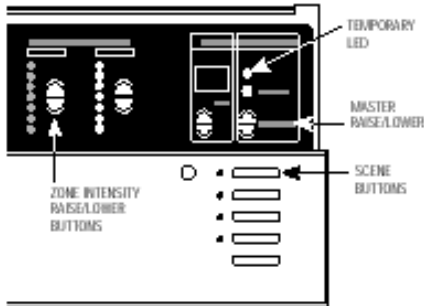

Control Unit must be in either **5d** or **5b** mode. See page 9 for more information regarding Save Options.

To adjust an entire scene:
 Press the appropriate scene button.
 Press MASTER **▲** or **▼** to raise or lower the intensity of all zones.

To adjust a zone:
 If the TEMPORARY LED is not already lit, press the TEMPORARY ZONES button. The TEMPORARY LED above the TEMPORARY ZONES button will light.
 Press ZONE **▲** or **▼** to adjust any zone's intensity.

Note: These adjustments are temporary and remain only until a new scene selection occurs—the **GRAPHIX RA** Control Unit does not store them as permanent scene settings.

How to set low-end trim—OPTIONAL

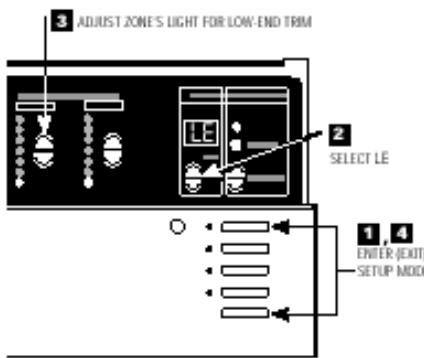

If necessary, adjust the low-end trim to achieve uniform low-intensity dimming and to eliminate flicker (especially with neon/cold-cathode and fluorescent loads).

- Enter setup mode.** Press and hold Scene 1 and OFF buttons for about 3 seconds, until scene LEDs start cycling.
- Select LE (for low end)** by pressing FADE **▲** once. All zones go to their lowest possible dim levels and only their bottom LED is lit*.
- Adjust zone's lights for low-end trim.** Use ZONE **▲** and **▼** to dim the zone's lights as much as possible without causing flicker. This setting becomes the "optimum lowest level" to which the zone will dim before going off. Repeat this process for any other zones that require low-end trim.
- Exit setup mode.** Press and hold Scene 1 and OFF buttons until scene LEDs stop cycling.

Note: The ZONE LED bargraph does not change while you make low-end trim adjustments. The bargraph remains set to its lowest level in this mode.

* Except zones set for non-dim. For these, all zone LEDs are lit, and you cannot adjust the low-end trim.

Advanced Scene Programming Options—OPTIONAL

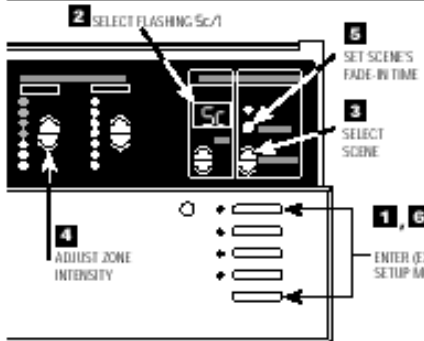

Programming Scenes 5 through 16.

- Enter setup mode.** Press and hold Scene 1 and OFF buttons about 3 seconds until scene LEDs start cycling.
- Select Sc** (the code for scene setup) by pressing FADE twice. Sc and 1 (for Scene 1) will alternately flash in the FADE window.
- Select scene.** Press MASTER **▲** or **▼** to select the scene to be programmed.
- Adjust ZONE-intensity.** Press ZONE **▲** or **▼** to display exact percentage light output. Press again to adjust light levels in 1% increments.
- Set scene's FADE-in time.** Press and hold the TEMPORARY ZONES button. The current FADE-in time is displayed. Adjust using the FADE **▲** and **▼** while still holding the TEMPORARY ZONES button.
- Exit setup mode.** Press and hold Scene 1 and OFF buttons until LEDs stop cycling.

User's Manual (Installation instructions)

How to set an "unaffected zone" — OPTIONAL

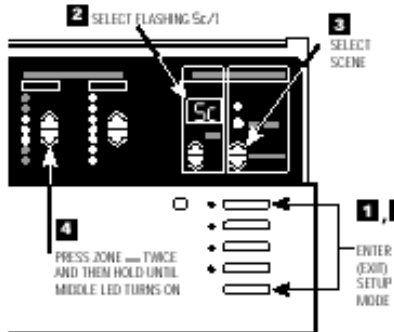

You can set up a zone to be "unaffected" when a certain scene is selected. (The unaffected zone's light levels remain unchanged when the new specified scene is selected.)

- 1. Enter setup mode.** Press and hold Scene 1 and OFF buttons about 3 seconds until scene LEDs start cycling.
- 2. Select SC** (the code for scene setup) by pressing FADE ____ twice. SC and 1 (for scene 1) will alternately flash in the FADE window.
- 3. Select scene.** Press MASTER ____ and ____ to select the scene that will have the unaffected zone.
- 4. Program any ZONE as unaffected.** Press ZONE ____ twice and then hold until all the bargraph LEDs go out and the middle LED light. (It may take up to 10 seconds after the last LED goes out until the middle LED lights.) This zone's light levels will no longer be affected when this scene is selected. Note that you can set up several zones to be unaffected in a scene.
- 5. Exit setup mode.** Press and hold Scene 1 and OFF buttons until LEDs stop cycling.

How to set Save Options — OPTIONAL

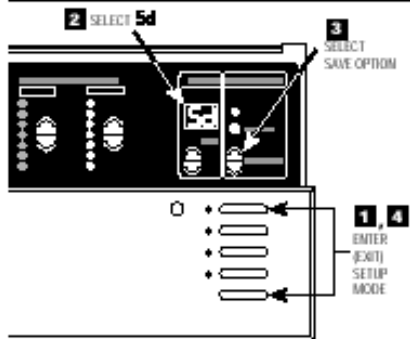

The GRAFW A4 Control Units allow selection of several different Save Options. Follow these steps to access the Save Options.

- 1. Enter setup mode.** Press and hold Scene 1 and OFF buttons for about 3 seconds until scene LEDs start cycling.
- 2. Select Sd.** Press FADE ____ until Sd is displayed in the FADE window.
- 3. Select Save Options.** Press MASTER ____ and ____ to select between the Save Options:
 - Sb Save by Default.** Changing a zone's intensity level or fade time permanently changes the preset scene. To temporarily change a light level, see "How to adjust light levels temporarily" on page 8.
 - Sr Save by Button.** TEMPORARY ZONES LED is normally ON and all intensity and fade changes are temporary unless the TEMPORARY ZONES LED is turned OFF with the TEMPORARY ZONES button.
 - bd Save Never.** TEMPORARY ZONES LED is permanently ON and cannot be turned OFF. In this mode, all intensity changes are temporary.
 - MS Four Scenes.** This only allows the four Scene buttons, OFF button, IR receiver and the MASTER ____ or ____ to operate. All other buttons on the Control Unit are disabled.
 - Button Disable.** All buttons on the Control Unit are disabled. IR Receiver, and Wallstations are still functional. (Setup mode is still accessible by repeating Step 1.)
- 4. Exit setup mode.** Press and hold Scene 1 and OFF buttons until scene LEDs stop cycling.

User's Manual (Installation instructions)

STEP 4: Setting Up System Communications

This section shows how to set up communications between Wallstations and the Control Units they should operate.

Do not set up communications . . .

- If you have only one *GRAFIK RA* Control Unit and . . .
 - you have up to three of the following Wallstations: NTGRX-4S, -4B, -4S-IR, -4S-DW, or EGRX-4S, -4S-IR, in any combination.

Close this manual and relax — your project will work as specified without any further wiring or setup!

Do set up communications . . .

- If you have one *GRAFIK RA* Control Unit and one or more *GRAFIK Eye* 3000 Series Control Units. . .
- You have Wallstations other than the NTGRX-4S, -4B, -4S-IR, -4S-DW, or EGRX-4S, -4S-IR.

IMPORTANT!

First check Class 2/PELVY wiring. Before you set up communications, make sure your Class 2/PELVY system interconnections are working.

- Select Scene 1 (press the top button) on one of the Control Units.
- Is Scene 1 selected on all other Control Units and NTGRX-4S controls?

YES: Class 2/PELVY wiring is OK. Proceed.

NO: Class 2/PELVY wiring has a miswire. Check for loose connections, shorted or crossed links. Refer to Appendix A for details on Class 2/PELVY wiring.

OR

GRAFIK Eye Control Unit has been addressed to other than R- (factory default). See below for more information on addressing Control Units.

GRAFIK RA Control Unit



GRAFIK Eye 3000 Series Control Unit

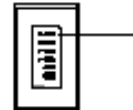

Assign addresses to *GRAFIK RA* & *GRAFIK Eye* Control Units.

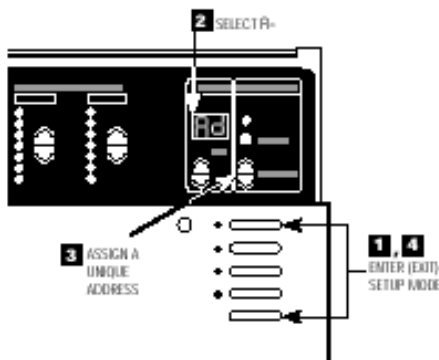

Assign each *GRAFIK RA* & *GRAFIK Eye* Control Unit in a room a unique system address (R1 through R8).

To assign an address:

- 1. Enter setup mode.** Press and hold Scene 1 and OFF buttons about 3 seconds, until scene LEDs cycle.
- 2. Select R-** (the address display). Press FADE ____ once, R- appears in the FADE window.
- 3. Assign a unique address.** Press MASTER ____ once, the next "free" (unassigned) address automatically appears in the FADE window. This will be the Control Unit's address. (If you are working on the first Control Unit in the project, R1 will appear.)
- 4. Exit setup mode.** Press and hold Scene 1 and OFF buttons about 3 seconds, until the LEDs stop cycling.
- 5. Repeat** steps 1 through 4 for each *GRAFIK RA* & *GRAFIK Eye* Control Unit.

User's Manual (Installation instructions)

Set up a Wallstation to "talk" to a "listening" Control Unit

In order for Wallstation to communicate with a Control Unit, each Wallstation must be individually configured to "talk."

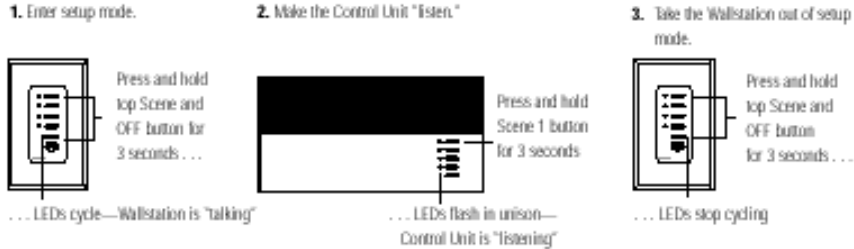

The communication link is now established. The Control Unit will "listen" when the user presses a button on the Wallstation. You can proceed to the next Wallstation and set up its communications.
 For more specific, step-by-step instructions about setting up communications for each type of GRAFIK Eye Wallstation, please refer to the instructions included with each Wallstation.

Set up 2-way communication between 2 Control Units

This page explains how to use 2-way communications to set up lighting effects for more than six zones (the maximum number of zones any one GRAFIK RA or GRAFIK Eye Control Unit can operate).

Important Note: Only **ONE** (1) GRAFIK RA Control Unit may be used when more than 6 zones are needed. All other control Units **MUST** be GRAFIK Eye Control Units.

When you set up two-way communications between Control Units, selecting a scene at any one of these Units automatically activates the same scene in the others. By linking eight 6-Zone Control Units, you can create scenes that control the intensity of up to 48 zones. This "large-zone" capability is ideal for large spaces with dramatic lighting that changes frequently (e.g., churches).

Set up communications in one direction ...

... then the other.

For example: 16-Zone Control

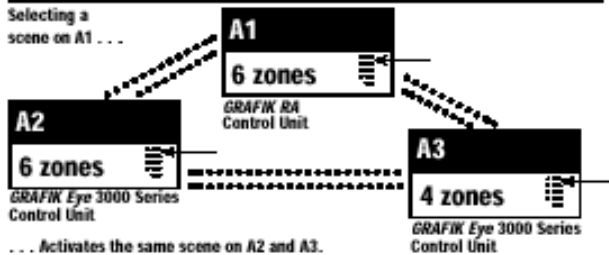

Linked by two-way communications, these Control Units act like a 16-Zone Control Unit. Note that you must set up communications **both ways** among all Control Units:

- A1 "talks" to A2 and A3 — and "listens" to them as well.
- A2 "talks" and "listens" to A1 and A3.
- A3 "talks" and "listens" to A1 and A2.

Make sure you have addressed the Control Units (as described on page 10) before setting up two-way communications.

1. **Put A1 in setup mode.** Press and hold Scene 1 and OFF buttons for about 3 seconds, until LEDs cycle.
2. **Identify the Control Units to "listen"** (A2 and up to 6 others). Press and hold the Scene 1 button for about 3 seconds until LEDs flash in unison, showing that these Control Unit(s) are "listening" to A1. (To make a "listening" Control Unit not listen to A1: Put A1 in setup mode, then press the "listening" Control Unit's OFF button until the LEDs stop flashing.)
3. **Take A1 out of setup mode.** Press and hold Scene 1 and OFF buttons for about 3 seconds, until LEDs on A1, and all other linked Control Unit(s), stop cycling. You have set up communications in one direction between A1 and all "listening" Control Units.
4. To complete the two-way communication, reverse the process described above: Put A2 in setup mode; then make A1 (and any other Control Units) "listen"; then take A2 out of setup mode.

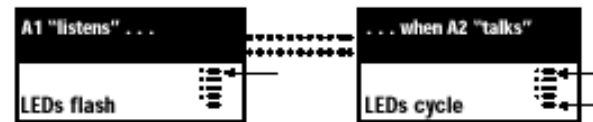

5. **Program the GRAFIK RA Control Unit to communicate with the RadioRA System.** Refer to the RadioRA Setup Guide: Addressium (P/N 044-020) or the RadioRA Setup Guide (P/N 044-001).

User's Manual (Installation instructions)

Appendix A: More about Class 2/PELV Wiring

This appendix explains the Class 2/PELV wiring used to carry communications between GRAFIK RA or GRAFIK Eye 3000 Series Control Unit Control Units and Wallstations.

Lutron requires that you connect (daisy-chain) the GRAFIK RA/LI GRAFIK Eye 3000 Series Control Units, and Wallstations with two twisted pair for operation. If shielded wire is used, the drain wires must be connected to each other or to Terminal D, if present. Drain wires should not be connected to Earth/Ground.

- One pair is for the low-voltage power wiring that enables the GRAFIK RA or GRAFIK Eye Control Unit to supply power to up to three Wallstations. Connect this twisted pair to terminals 1 (COMMON) and 2 (12VDC). Terminate the 12VDC power to ensure that each Control Unit powers **no more than three Wallstations**.
- The second pair is for a data link (up to 2000 ft. or 450 m long) that enables Wallstations to communicate with a GRAFIK RA Control Unit or GRAFIK Eye Control Units. Connect this twisted pair to terminals 3 (MLD) and 4 (MLD) of every Control Unit and Wallstation. Each twisted pair in the Class 2/PELV wiring link should consist of two #18 AWG (1.0 mm²) stranded conductors.

- Lutron offers a one-cable (non-plenum), low-voltage solution. Please ask for P/N GRX-CBL-346S.

Recommended unshielded cables:

- For non-plenum installations, use (2) Belden 9470, (1) Belden 9156, or (2) Liberty 1B1P/2C-EX-GRN, or equivalent.
- For plenum installations, use (2) Belden 82740, or equivalent.

Wallstation circuits are classified as Class 2 circuits (U.S.A.) and PELV circuits (IEC). Unless otherwise specified, the voltages do not exceed 24VAC or 15VDC. As Class 2 circuits, they comply with the requirements of NFPA 70, National Electrical Code (NEC). As PELV circuits, they comply with the requirements of IEC 60364-4-41, VDE 0100 Part 410, BS7671:2002 and other equivalent standards. When installing and wiring to these Wallstations, follow all applicable national and/or local wiring regulations. External circuits connected to input, output, RS232, DM9512, and other communication terminals of Wallstations, must be supplied from a Listed Class 2 source or comply with the requirements for PELV circuits as applicable in your country.

The GRAFIK Eye 3000 Series Control Unit Class 2/PELV circuit is 12VDC.

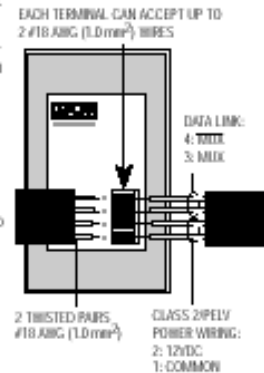

What is PELV?

In countries that abide by the IEC regulations, PELV is commonly referred to as Protective Extra-Low Voltage. A PELV circuit is an earthed circuit in which the voltage cannot exceed 50VAC or 120V ripple-free DC. The power source must be supplied by a safety isolating transformer or equivalent.

IMPORTANT WIRING NOTE!

Proper separation is required between the Line Voltage/Mains cables and PELV cables. Use certified cable for all Line Voltage/Mains cables and PELV cables. Cable bearing HAR or national certification marks are acceptable, provided it covers all applicable wiring regulations for fixed installations. See Important Wiring Note on page 3.

Typical Small Room: A Control Unit with up to three Wallstations

Each Control Unit can power up to three Wallstations. If you need to power more than three Wallstations from one Control Unit, install an external 12VDC power supply as described later in this section.

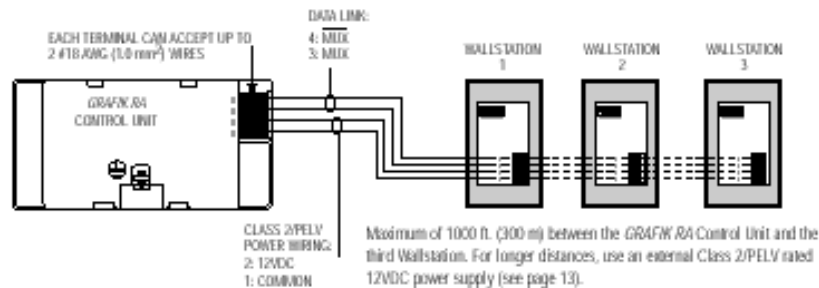

IMPORTANT WIRING NOTES!

1. Daisy-chain the terminal 1, terminal 2, terminal 3, and terminal 4 connections to all Control Units and Wallstations. The Control Unit has its own power supply.
2. Each Control Unit can power up to three Wallstations. If you need to power more than three Wallstations from one Control Unit, install an external 12VDC power supply as described later in this section.
3. Lutron recommends that all connections be made in the unit wallbox. Remote connection must be in a switchbox or junction box with a maximum wire length of 8 ft. (2.5m) from the link to the connected unit.

Note: Do not allow Class 2/PELV wires to contact line/mains wires. Refer to Class 2/PELV wiring on page 4.

User's Manual (Installation instructions)

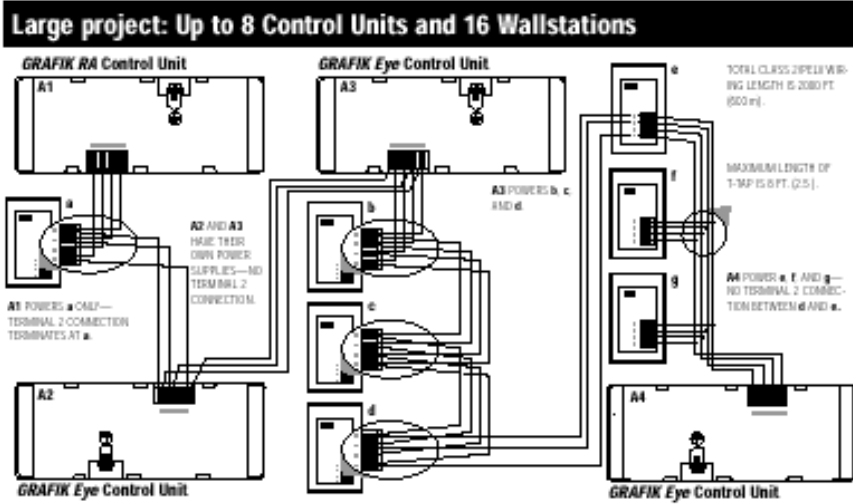

IMPORTANT WIRING NOTES!

1. Daisy-chain the terminal 1, terminal 3, and terminal 4 connections to all Control Units and Wallstations. Each Control Unit has its own power supply. Terminate the terminal 2 connection (12VDC power) so that:
 - Each Control Unit supplies power to a maximum of three Wallstations.
 - Each Wallstation receives power from only one Control Unit.
2. Lutron recommends that all connections be made in the Control Units wallbox. Remote connection must be in a switchbox or junction box with a maximum wire length of 8 ft. (2.5 m) from the link to the connected unit.

Note: Do not allow Class 2/PELV wires to contact line/mains wires. Refer to Class 2/PELV wiring on page 2.

Installing an external power supply

Install an external Class 2/PELV rated 12VDC power supply as shown below. This power must be Class 2/PELV rated and be a regulated supply rated for at least 50 mA per Wallstation on the link. It can supply power to up to 16 Wallstations, enabling you to use up to 16 Wallstations with one Control Unit.

Use an external power supply if you need to power more than 3 Wallstations from a single Control Unit or if your wire lengths exceed maximums. Power supplies do not boost data line signals. The distance limitation for the data line is 2000 ft. (450 m). Make sure you review the manufacturer's instructions before installing.

Lutron offers a 12VDC transformer for 120V applications. Please ask for PM GRX-12VDC.

IMPORTANT WIRING NOTES!

1. Connect the +12VDC wire from the power supply to the terminal 2 connection on all Wallstations. Do not connect this wire to any Control Units on the link. Be sure that the terminal 1 connection is made to all Wallstations and Control Units.
2. Lutron recommends these maximum distances from the external 12VDC power supply to the sixteenth Wallstation:
 - #18 AWG (1.0 mm²) wire: 300 ft. (90 m).
 - #12 AWG (2.5 mm²) wire: 1000 ft. (300 m).

Note that the allowable maximum distance depends on the number of Wallstations in the system. Please see Application Note WT4 or consult the Lutron Technical Assistance Hotline for more detailed information.

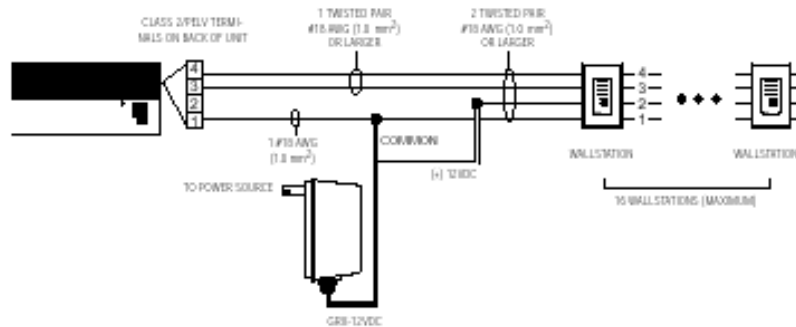

User's Manual (Installation instructions)

Appendix B: Special Mounting Considerations

Wallbox Mounting

Spacing of the GRAFIK RA & GRAFIK Eye 3000 Series Control Unit
 When mounting multiple GRAFIK RA & GRAFIK Eye 3000 Series Control Units near each other, the following spacing and ventilation guidelines are required for proper operation.

- All GRAFIK RA & GRAFIK Eye 3000 Series Control Units **MUST** be mounted in a standard U.S. Wallbox. These are available from Lutron.
 - For two-zone Control Units, Power Boosters, Fluorescent Interfaces, and Electronic Low-Voltage Interfaces, use two P/N 241-519 single-gang wallboxes.
 - For three-zone Control Units, use three P/N 241-519 single-gang wallboxes.
 - For four-zone (or larger) Control Units, use one P/N 241-400 four-gang wallbox.
- All GRAFIK Eye 3000 Series Control Units, Power Boosters, Fluorescent Interfaces, and Electronic Low-Voltage Interfaces **MUST** have 4 1/2 in. (11 cm) of space above and below the faceplate to dissipate the heat caused by normal operation.

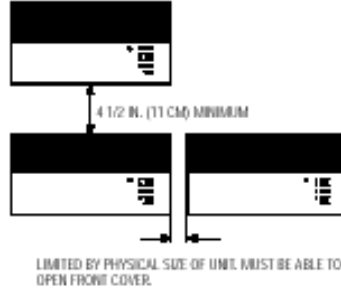

Panel Mounting

- The enclosure must be in accordance with all local and national electrical codes.
- Lutron does not recommend using a door to enclose the front of a panel, since this restricts airflow to the GRAFIK RA & GRAFIK Eye 3000 Series Control Units and Interface Devices.
- If mounting multiple GRAFIK RA & GRAFIK Eye 3000 Series Control Units or Interface Devices in an enclosure:
 - Ambient temperature within an enclosure **MUST remain between 32°—104° F (0°—40° C)**.
 - If not mounting in a metal enclosure, all units **MUST** be mounted in a wallbox. Refer to Wallbox Mounting above.
- To improve heat dissipation of Interface Units, (i.e., NGRC-PB, GRC-ELVI, etc.), remove the faceplate from the unit.

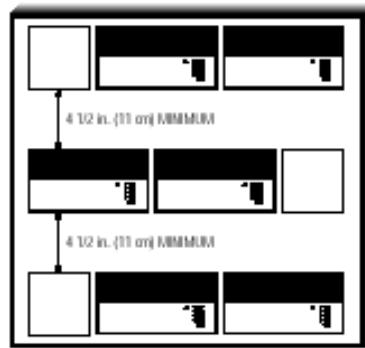

IMPORTANT NOTE:

GRAFIK RA, GRAFIK Eye 3000 Series Control Units, and Interface Devices, such as NGRC-PB, dissipate heat when operating. Obstructing these units can cause malfunction to both the Control Unit and the Interface Device if ambient temperature does not remain between 32°—104° F (0°—40° C).

Appendix C: Power Boosters and Interfaces

This "load-side" equipment installs on the zone wiring between the Control Unit and the lighting load.

The **PB** increases a Control Unit's CAUTION! Test load for short circuits, zone load capacity for Incandescent/Halogen (tungsten), Magnetic Low Voltage, and Neon/cold Cathode load types.

The **ELVI** enables a zone of the Control Unit to control electronic low-voltage loads.

The **FDBI** enables a zone on the Control Unit to operate fluorescent loads outfitted with Lutron's Hi-Lume or Eco-10 phase-controlled dimming ballasts.

CAUTION! Test load for short circuits.

- Turn power off.
- PB/ELVI: Connect standard switch between hot/live lead and the load wire to test circuit.
- FDBI: Connect standard switch between hot/live lead and the dimmed hot/live and switched hot/live leads of the ballast.
- Turn power on and check for short or open circuits.

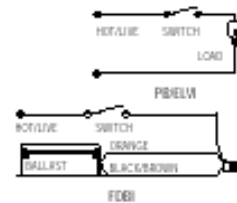

Wiring instructions

- Turn off power to the Control Unit and the feed to the PB, ELVI, or FDBI.
- Mount 2-gang wallbox: 3 1/2 in. (87.5 mm) deep recommended, 2 3/4 in. (68.75 mm) deep minimum. When mounting several units in a vertical layout (one underneath the other), allow at least 4 1/2 in. (11 cm) between units.
- Strip 1/2 in. (12 mm) insulation from #12 (2.5 mm²) 75 °C copper (CU) AWG wires and connect as shown. Please see the Instruction Sheet supplied with the unit for more detailed wiring diagrams.

Unit	120V	220-240V (AU)	230V (CE)
PB	1500VA/0A	2400VA/0A	1840VA/0A
FDBI	1500VA/0A	2400VA/0A	2400VA/0A
ELVI	1000VA/0A	1200VA/0A	1200VA/0A

* 1840VA/0A surface mount, 1200VA/0A flush mount.

User's Manual (Installation instructions)

Wiring detail Mounting

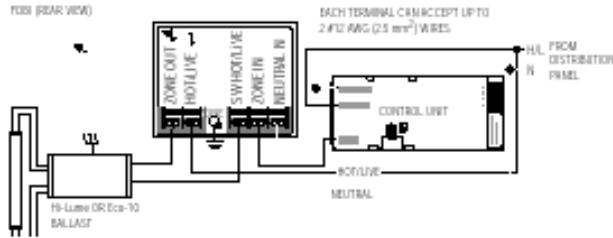
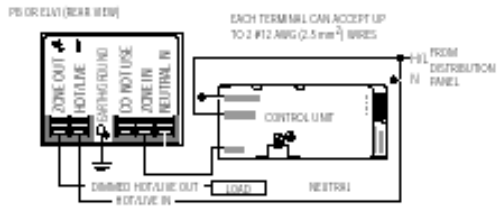

IMPORTANT WIRING NOTES!

Connect ZONE OUT only to Lutron Hi-Lume or Eco-10 Electronic Dimming Ballasts. Do not use this connection with any other fluorescent ballast or transformer.

* Can be on the same or different phases.

Appendix D: GRX-TVI 0-10 Volt Ballast/Switching Interface

Specifications

The GRX-TVI provides 0-10V control and ballast switching capabilities in one enclosure. The interface gives GR4FW RA & GR4FW Eye 3000 Series Control Units the ability to control 0-10V ballasts powered by 100V to 277V and provides switching relays that can handle the in-rush current of ballasts. The interface gives GR4FW RA & GR4FW Eye 3000 Series Control Units the ability to both dim and switch electronic ballasts, such as Lutron's Eco-10 (TVE models).

FEATURES	<ul style="list-style-type: none"> Provides a Class 2/PELV isolated 0-10V output signal that conforms to EN60929 and IEC60929. Complies with UL Standard 508. Accepts a constant-gate drive fluorescent signal. (100-127V, 220-240V, 50/60Hz). 																								
CONTROL INPUT POWER RATING	100-127/220-240V, 50/60Hz																								
L2/H2 TERMINAL INPUT RATING	20mA																								
DL2/DH2 TERMINAL INPUT RATING	100mA																								
0-10V OUTPUT RATING	10µA-300mA (maximum 150 ballasts)																								
OUTPUT SWITCHING CAPACITIES	<table border="0"> <tr> <td>Fluorescent (with Lutron TVE ballasts)</td> <td>16A</td> <td>10A</td> </tr> <tr> <td>Fluorescent (with ballasts by others)</td> <td>5A</td> <td>5A</td> </tr> <tr> <td>Incandescent</td> <td>16A</td> <td>10A</td> </tr> <tr> <td>Low Voltage</td> <td>16A</td> <td>10A</td> </tr> <tr> <td>Metal Halide</td> <td>16A</td> <td>10A</td> </tr> <tr> <td>Neon/Cold Cathode</td> <td>16A</td> <td>10A</td> </tr> <tr> <td>Motor @ 100-127V</td> <td>1/4hp</td> <td>—</td> </tr> <tr> <td>Motor @ 220-277V</td> <td>1/2hp</td> <td>—</td> </tr> </table>	Fluorescent (with Lutron TVE ballasts)	16A	10A	Fluorescent (with ballasts by others)	5A	5A	Incandescent	16A	10A	Low Voltage	16A	10A	Metal Halide	16A	10A	Neon/Cold Cathode	16A	10A	Motor @ 100-127V	1/4hp	—	Motor @ 220-277V	1/2hp	—
Fluorescent (with Lutron TVE ballasts)	16A	10A																							
Fluorescent (with ballasts by others)	5A	5A																							
Incandescent	16A	10A																							
Low Voltage	16A	10A																							
Metal Halide	16A	10A																							
Neon/Cold Cathode	16A	10A																							
Motor @ 100-127V	1/4hp	—																							
Motor @ 220-277V	1/2hp	—																							
TERMINALS	Two #12-20AWG (0.5-2.5 mm ²) conductors per terminal.																								
MOUNTING	NEMA Type 1 enclosure, indoor use only.																								
ENVIRONMENTAL	32—104 °F (0—40 °C).																								
WEIGHT	4.25 lb. (2kg)																								

Installation

Mount on a wall using four screws. Use the unit to mark the position of the holes. Terminal blocks on the PCB accept up to two #12 AWG (2.5 mm²) wires. This allows the interface to be wired in multiple ways. The GRX-TVI can be wired from one or two distribution panels. The switched power can be from a different source than the control power.

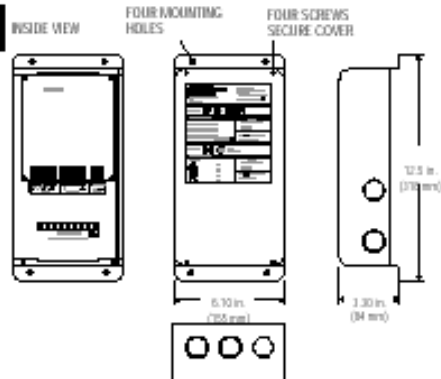

User's Manual (Installation instructions)

GRAFIK Eye Control Unit

Labels: HINGED COVER, ZONE LABEL, LIGHT LEVEL LED DIAGRAM, ZONE RAISE/LOWER BUTTONS, INFRARED WIRELESS REMOTE CONTROL RECEIVER, BASE, INSTRUCTION LABEL, FADE WINDOW (F 'S' IS LIT, TIME IS IN SECONDS; F 'M' IS LIT, TIME IS IN MINUTES), MASTER RAISE/LOWER FADE BUTTONS, SCENE 1, SCENE 2, SCENE 3, SCENE 4, OFF, SCENE INDICATOR LEDS.

Wiring details: RA-GRX6

Wiring Labels: EARTH/GROUND FROM DISTRIBUTION PANEL, DISTRIBUTION PANEL, HOT/LINE, INPUT POWER FROM DISTRIBUTION PANEL, NEUTRAL FROM DISTRIBUTION PANEL.

Changing the GRAFIK RA Control Unit Operating Frequency

If your line frequency is 60 Hz (United States), **DO NOT** change the operating frequency. The default is 60 Hz. If your line frequency is 50 Hz, proceed with changing the operating frequency to 50 Hz as shown below.

60 Hz LED turns OFF 50 Hz LED turns ON

Using a pointed object, such as the point of a pen or pencil, press and hold the 50 Hz button until the 60 Hz LED turns OFF and the 50 Hz LED turns ON (approximately 3 seconds).

WORLD HEADQUARTERS
 Lutron Electronics Co., Inc.
 7300 Sutar Road
 Coopersburg, PA 18936-1299 U.S.A.
 TOLL FREE: (800) 523-9466 (U.S.A., Canada, Caribbean)
 Tel: (610) 282-3000; International 1 610-282-3000
 Fax: (610) 282-3080; International 1 610-282-3090

EUROPEAN HEADQUARTERS
 Lutron (UK) Ltd.
 Lutron House
 6 Sovereign Close
 Wapping
 London, E1W 3JF United Kingdom
 FREEPHONE: 0800-282107 (U.K.)
 Tel: (207) 702-0657; International 44 207 702-0657
 Fax: (207) 488-6889; International 44 207 488-6889

ASIAN HEADQUARTERS
 Lutron Asuka Corporation
 2nd Floor, Kowa Shiba-Koen Bldg.
 1-1-11, Shiba-Koen
 Minato-ku, Tokyo
 105-8001 Japan
 TOLL FREE: (0120) 083417 (Japan)
 Tel: (03) 5405-7333; International 81-3-5405-7333
 Fax: (03) 5405-7498; International 81-3-5405-7498

HONG KONG SALES OFFICE
 Lutron (H.K.) Ltd.
 Unit 2206, 22th Floor
 MLC Tower
 248 Queen's Road East
 Wanchai, Hong Kong
 Tel: 2104-7733; International 852-2104-7733
 Fax: 2104-7633; International 852-2104-7633

SINGAPORE SALES OFFICE
 Lutron (S.E.) Ltd.
 6A Upper Cross Street
 Singapore 058326
 Tel: 220-4666; International 65-220-4666
 Fax: 220-4333; International 65-220-4333

Lutron Electronics Co., Inc., reserves the right to make improvements or changes in its products without prior notice. Although every attempt is made to ensure that this information is accurate and up to date, please check with Lutron to confirm product availability, latest specifications and suitability for your application.



©2001 Lutron Electronics Co., Inc.
 MADE AND PRINTED IN U.S.A. 12/01 P/N 044-024 Rev. A

User's Manual (Installation instructions)

Appendix D: Wiring overview

A GRC Interface is required for each fluorescent dimming zone. (A 3-zone Control Unit with two fluorescent zones and one incandescent zone is shown as an example.)

Please note that the power feed to the Control Unit and H₂/L₂ of the GRX-TV1 must be the same phase!

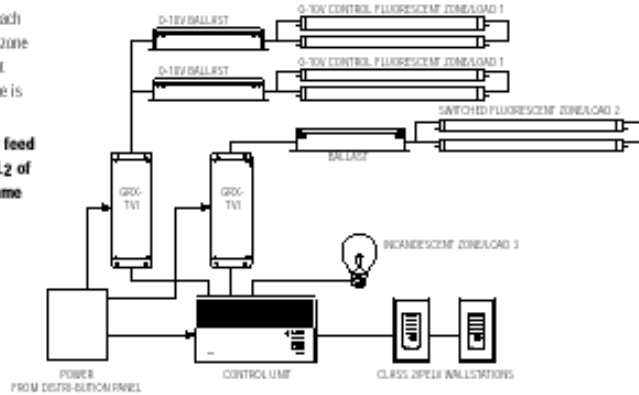

Appendix E: HP Dimming Modules (120V control feed only)

Not for use with generator-supplied power!

HP 2•4•6 Modules increase the load capacity of a Control Unit zone from 800WVA to:

- 1920WVA with the HP•2
- 3840WVA with the HP•4
- 5760WVA with the HP•6
- Up to 28,800WVA by daisy-chaining five HP•6 Modules.

HP 2•4•6 Modules can also accept 277V input load power feeds to integrate 277V fluorescent dimming loads controlled by Hi-Lume or Eco-10 Electronic Dimming Ballasts with 120V 3000 Series Control Units.

Specifications

DESCRIPTION	MODEL NUMBER	No. OF OUTPUTS TO LOAD CIRCUITS	CAPACITY@ 120VAC, 20A
	HP•2	1	1920WVA
	HP•4	2	3840WVA
	HP•6	3	5760WVA

POWER
Operating power: 0.20W per HP-Module, 120WAC supplied to control circuit. Input power for load circuit(s): 120 or 277, 60Hz VAC, 32—104 °F (0—40 °C).

ENVIRONMENTAL CAPACITIES PER LOAD CIRCUIT OUTPUT	LOAD TYPE	DIMMED 120VAC/277VAC	SWITCHED 120 VAC/277VAC
	Incandescent	16A	10A
	Magnetic/electronic low voltage; neon/cold cathode*	16A	10A
	Hi-Lume or Eco-10 Fluorescent	16A	16A
	Fluorescent (non-dim)	—	16A
	Metal Halide	N/A	10A

Dimmed and switched not available for each output. 50WVA minimum load per output.

MAXIMUM HEAT DISSIPATION 200BTU per hour per load circuit output.
* For neon/cold cathode light sources, consult Lutron Application Note #25.

Choose a mounting location

- Must be within 1000 ft. (300 m) of the Control Unit.
- Must allow for adequate cooling. (Make sure ambient temperature is 32°—104 °F (0°—40 °C). Allow for adequate air space.)
- Must be **at least** 6 ft. (1.8 m) away from sensitive electronic equipment.
- Must be placed where the HP 2•4•6's slight operating noise is acceptable.

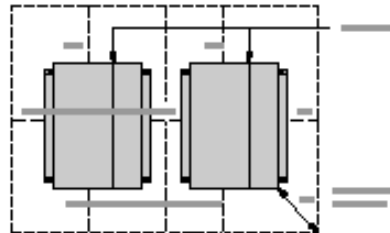

IMPORTANT!

Leave the HP 2•4•6's factory-installed bypass jumpers in place until you have installed and tested the Module.

Mounting

1. Hang unit vertically.
2. Mark and drill holes.
3. Using the keyed upper holes for easy positioning, secure the unit to the wall.

Please see the Instruction Sheet provided with the unit for more detailed programming instructions.

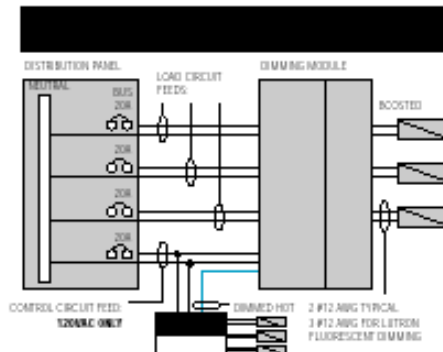

User's Manual (Installation instructions)

Appendix F: Infrared Transmitters

Infrared Transmitters

GRAFIK Eye Control Units are equipped with an Infrared Receiver. This allows control of the Control Unit with the optional Handheld Infrared Wireless Remote Control Transmitters. The Infrared Transmitters control 4 (or 8) scenes plus master raiselower and Off. With this you can recall scenes or fine-tune light levels.



Infrared Interference

All GRAFIK RA Control Units are equipped with an IR Receiver for use with Lutron GRX-IT and GRX-8IT handheld remote-controls. The IR frequency for all Control Units is 40,000 KHz. Any other device continuously operating in the frequency range from 30 KHz to 50 KHz may cause either no response or unwanted scene changes on the Control Unit. Fluorescent ballasts are a known cause of IR interference to the Control Unit and Wallstations. Lutron dimming ballasts have been thoroughly tested to ensure that there is no IR interference with any GRAFIK RA product. However, other manufacturer's ballasts may cause interference. It is the responsibility of the contractor to determine the operating frequency of the ballasts used on the project. Lutron takes no responsibility for ballast interference to the GRAFIK RA system.

Appendix G: Troubleshooting

If the GRAFIK RA lighting controls in your project aren't working as specified . . .

- Review carefully the GRAFIK RA submittal documentation prepared for your project — especially the project's One-Line Diagram, which gives an overview of the wiring and shows how all GRAFIK RA equipment connects. A sample One-Line Diagram is shown at right.
- Consult the chart below to identify and correct the problem.
- If necessary, call Lutron.

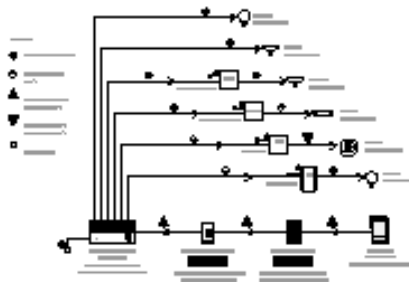

Problem	Cause	Remedy
Unit does not turn lights on	Breaker/MCB is off Long fade time Low zone settings Miswire System short circuit System overload	Switch breaker/MCB on. Set FADE time to 0 seconds. Use zone _____ for each scene. Check wiring (refer to wiring details). Find and correct shorts in fixtures and/or wall box. Make sure lighting loads don't exceed Unit's maximum rated load.
Unit does not control load ZONE control does not work	Miswire Disconnected wires Burned-out lamps	Check wiring (refer to wiring details). Connect zone wires to loads (refer to wiring details). Replace bad lamps.
1 or more zones are "Full-on" when any scene is on and zone intensity is not adjustable (and zone is not a non-dim)	Miswire Shorted triac	Make sure loads are connected to the right zones (refer to wiring details). Replace Control Unit.
A ZONE control affects more than one zone	Miswire	Check wiring (refer to wiring detail).
Wallstation does not function properly	Miswire or loose connection Wallstation not set up properly	Check and tighten loose connections at Class 2/PELV terminals on Unit and Wallstations (refer to Appendix A). Confirm programming.
Faceplate is warm	Normal	Solid-state controls dissipate about 2% of the connected load as heat.
Unit does not allow scene changes or zone adjustments	Unit may be set to an optional Save Option.	Refer to page 9 for Save Options.

User's Manual (Programming instructions)

RadioRA®



Wireless Home Lighting Control

Setup Guide Addendum

For GRAFIK RA™ Control Units (RA-GRX-x, RB-GRX-x)

A Comprehensive Step-by-Step Guide for Programming
and Operating Lutron GRAFIK RA™ Control Units

Note: Please leave this manual with homeowner.

English

P/N 044-020

User's Manual (Programming instructions)

Notes on this Manual

This manual is an addendum to the original RadioRA[®] Setup Guide. The procedures to setup a RadioRA[®] GRAFIK RA™ Control Unit are contained in this manual. For more information on programming the remainder of your RadioRA[®] System, or for advanced features (copying button programming, erasing button programming, setting up a column of buttons as SCENE buttons, BEEP Mode, etc.) refer to the original RadioRA[®] Setup Guide (p/n 044-001).

Consumer Information



This symbol is intended to alert the user to the presence of important installation and operating instructions.

Danger

This RadioRA[®] system must not be used to control equipment, other than lighting, which is not visible from every master or local control location. It also must not be used to control equipment which could create hazardous situations such as entrapment if operated accidentally. Examples of equipment which must not be controlled by this RadioRA[®] system include (but are not limited to) motorized gates, garage doors, industrial doors, and microwave ovens, heating pads, etc. It is the installer's responsibility to ensure that the equipment, other than lighting, being controlled is visible from every master or local control location and that only suitable equipment is connected to this RadioRA[®] system.

FCC Information

NOTE: This equipment has been tested and found to comply with the limits for a Class B digital device, pursuant to part 15 of the FCC rules. These limits are designed to provide reasonable protection against harmful interference in a residential installation. This equipment generates, uses and can radiate radio frequency energy and, if not installed and used in accordance with the instructions, may cause harmful interference to radio or television reception, which can be determined by turning the equipment off and on, the user is encouraged to try to correct the interference by one or more of the following measures:

- Reorient or relocate the receiving antenna.
- Increase the separation between the equipment and receiver.
- Connect the equipment into an outlet on a circuit different from that to which the receiver is connected.
- Consult the dealer or an experienced radio/TV technician for help.

Caution: Changes or modifications not expressly approved by Lutron Electronics Co. could void the user's authority to operate this equipment.

User's Manual (Programming instructions)

Table of Contents

Section 1 - Start-Up

Activating Your System

Activating/Adding GRAFIK RA™ Control Unit 1-1

ROOM Programming

Assigning a GRAFIK RA™ Control Unit to ROOM Buttons 1-3

GRAFIK RA™ Scene Selection for ROOM Buttons 1-5

Section 2 - Advance Features

SCENE Programming

Assigning a GRAFIK RA™ Control Unit to SCENE Buttons 2-1

GRAFIK RA™ Scene Selection for SCENE Buttons 2-3

Section 3 - Troubleshooting

Troubleshooting Guide 3-1

Returning Components to Default Factory Settings

GRAFIK RA™ Interface 3-2

Important Application Notes

1. It is required that only one GRAFIK RA™ Control Unit be wired on each GRAFIK Eye® link. Multiple GRAFIK Eye® Control Units may be wired (linked) to the same GRAFIK RA™ Control Unit, however, all GRAFIK Eye® Control Units on that link will respond in unison to the commands from the GRAFIK RA™ Control Unit. ALL GRAFIK Eye® Control Units wired to the same GRAFIK RA™ Control Unit will carry out ALL commands from the GRAFIK RA™ Control Unit (i.e. go to GRAFIK Eye® scene 3, Turn OFF, etc...). RadioRA® commands cannot be sent to one individual GRAFIK Eye® Control Unit on a link of multiple GRAFIK Eye® Control Units.
 - This application may be desired if multiple GRAFIK Eye® Control Units are in the same room and it is intended that the same scene be selected on each GRAFIK Eye® Control Unit simultaneously.
 - Lutron does **not** recommend using one GRAFIK RA™ Control Unit to linked GRAFIK Eye® Control Units located in more than one room.
2. Scene 1 on a GRAFIK Eye® Control Unit is the default scene for ALL ON, SECURITY, and FLASH MODES. It is recommended scene 1 on GRAFIK Eye® Control Units be set to full intensity with a fade time of zero seconds.
3. Setting the light levels for GRAFIK Eye® scenes should be done prior to any operations in this Setup Guide.
4. A GRAFIK Eye® scene may be added to any RadioRA® Master Control button which has been previously programmed without altering that buttons existing programming.

User's Manual (Programming instructions)

Activating Your System

Activating/Adding a GRAFIK RA™ Control Unit



GRAFIK Eye® links in multiple rooms may be activated in any order.

Step 1 Begin Control activation

Press and hold the ACTIVATE CONTROLS button on *any* Repeater until the green LED turns ON (approximately 3 seconds).

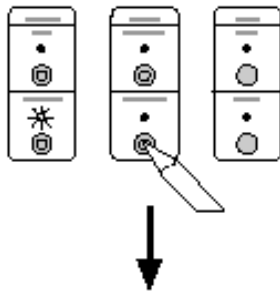

The green ACTIVATE CONTROLS LED on **ALL** Repeaters will turn ON.

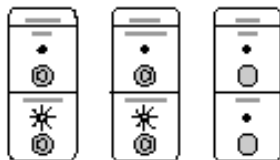

If the Activate Controls LED fails to turn ON, consult the Troubleshooting Guide, Section I.

Step 2 Activate a GRAFIK Eye® Control Unit

Go to the GRAFIK RA™ Control Unit. Change the scene by pressing any of the preset buttons on the GRAFIK RA™ Control Unit.

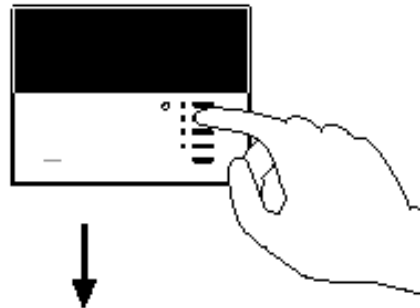

The lights that the GRAFIK RA™ controls will cycle between scene 1 and OFF a few times when it has been activated. (May be difficult to observe if scene 1 has a long fade time or low light levels are set.)



If a GRAFIK RA™ Control Unit fails to respond as described above, consult the Troubleshooting Guide, Section II.

- Repeat Step 2 to activate any remaining GRAFIK RA™ Control Units.



Activate one GRAFIK RA™ Control Unit at a time. Wait for the GRAFIK RA™ Control Unit to flash its light(s) before activating any remaining GRAFIK RA™ Control Units.

- Proceed to Step 3 when all GRAFIK RA™ Control Units have been activated.

User's Manual (Programming instructions)

Activating Your System

Step 3 Complete Control activation

Press and hold the ACTIVATE CONTROLS button on **any** Repeater until the green LED turns OFF (approximately 3 seconds).

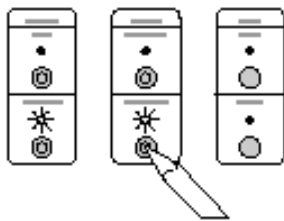

The green ACTIVATE CONTROLS LED on **ALL** Repeaters will turn OFF. The MAIN or AUXILIARY LED will remain on.



Step 4 Verify that all GRAFIK RA™ Control Units have been activated

Press and hold the FLASH button on any Repeater until the green LED turns ON (approximately 3 seconds).

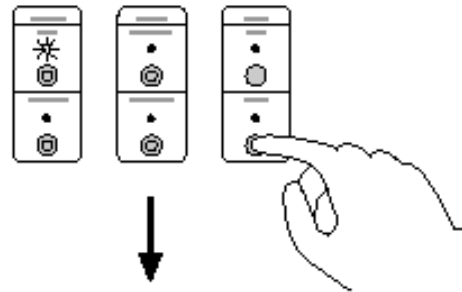

The green FLASH LED on all Repeaters will turn ON.



GRAFIK RA™ Control Units, if activated, will flash the light(s) they control. (May be difficult to observe if scene 1 has a long fade time or low light levels are set.) Make note of any GRAFIK RA™ Control Units which are not activated.



After verifying that all GRAFIK RA™ Control Units are activated, press and hold the FLASH button on any Repeater until the green LED turns OFF (approximately 3 seconds). The green FLASH LED on all Repeaters will turn OFF.



If any GRAFIK RA™ Control Unit has not been activated, repeat Steps 1 through 4.

- **GRAFIK RA™ Control Units are now activated.**

User's Manual (Programming instructions)

ROOM Programming

Assigning a GRAFIK RA™ Control Unit to ROOM Buttons

All buttons are factory set as ROOM Buttons.

What is a ROOM button?

ROOM buttons can be used to turn a light or a group of lights ON or OFF. Pressing a ROOM button once will turn ON all controls assigned to that button to their pre-selected light level. Pressing the same ROOM button again will turn OFF all controls assigned to that button. A ROOM LED will be ON if any control assigned to that button is ON, regardless of its light level.

Step 1 Begin assigning GRAFIK RA™ Control Units to ROOM buttons

Simultaneously press and hold the 2nd and 4th buttons in the right most column until the upper right LED begins to flash (approximately 3 seconds).

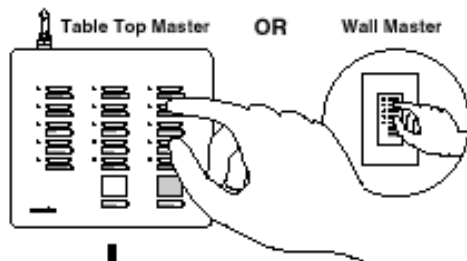

Upper right LED flashes.

 All GRAFIK RA™ Control Units will turn OFF.

Step 2 Select a ROOM button

Press and release the ROOM button that you want to program. Its LED will begin to flash.

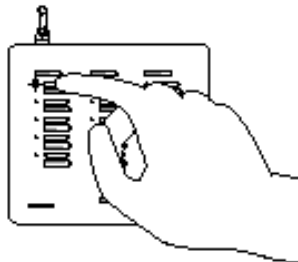

Step 3 Assign a GRAFIK RA™ Control Unit to button

Notes:

- Multiple Dimmers, Switches or GRAFIK RA™ Control Units can be assigned to a single ROOM button.
- Controls must be assigned to a Master Control button while its LED is flashing.

Assign a GRAFIK RA™ Control Unit to the Master Control ROOM button by turning the GRAFIK RA™ Control Unit ON to any scene.

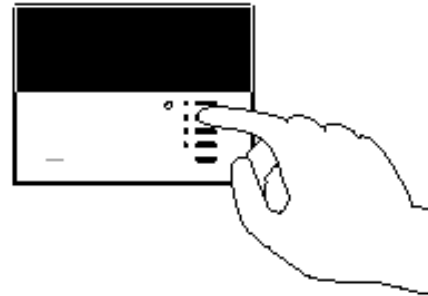

Note: GRAFIK RA™ Control Units will automatically turn ON to scene 1 once assigned.



 If you assign the wrong GRAFIK RA™ Control Unit to a Master Control button, turn the GRAFIK RA™ Control Unit OFF to unassign it.



User's Manual (Programming instructions)

ROOM Programming

Step 4 Select next ROOM button

To assign a GRAFIK RA™ Control Unit to another Master Control ROOM button, press and release that button. Its LED will begin to flash.

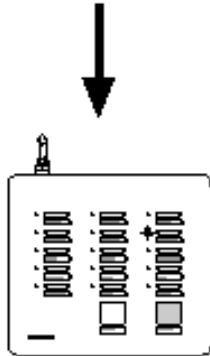
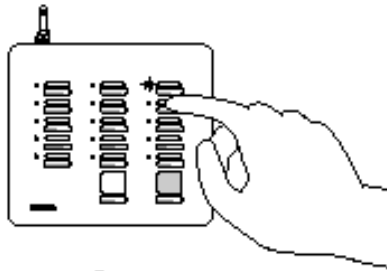

Turn ON the GRAFIK RA™ that is to be assigned to the selected ROOM button.

- Repeat Step 4 for all ROOM buttons to have a GRAFIK RA™ Control Unit assigned to them.

Step 5 Complete assigning GRAFIK RA™ Control Units

Simultaneously press and hold the 2nd and 4th buttons in the right most column until all LEDs begin to flutter (approximately 3 seconds).

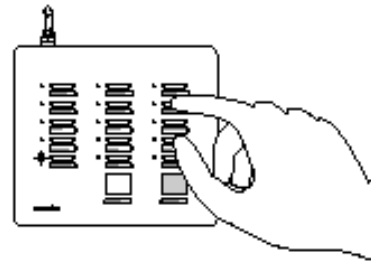

- Repeat Steps 1 through 5 to assign GRAFIK RA™ Control Units to ROOM buttons on any additional Master Controls.
- Proceed to GRAFIK RA™ Scene Selection on page 1-5.

User's Manual (Programming instructions)

ROOM Programming

GRAFIK RA™ Scene Selection for ROOM Buttons

Note: Programming the light levels of GRAFIK RA™ Control Unit scenes should be done prior to this step and in accordance with the GRAFIK Eye® Installer's Guide.

Step 1 Begin GRAFIK RA™ scene selection

Simultaneously press and hold the 1st and 5th buttons in the right most column until the upper right LED begins to blink (approximately 3 seconds).

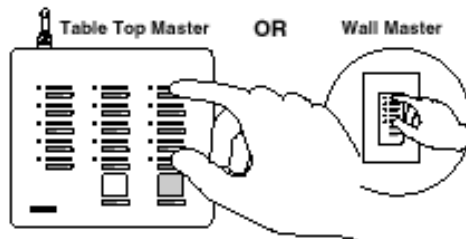

Upper right LED blinks.

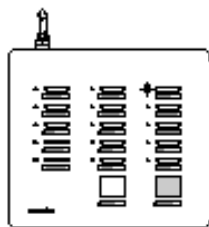

Step 2 Select a ROOM button

Press and release the ROOM button that you want to program. Its LED will begin to blink.

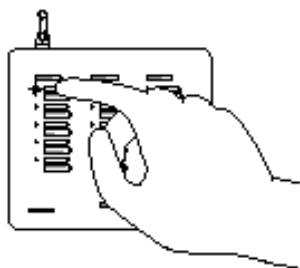

GRAFIK RA™ Control Units that have been assigned to that button will turn ON to scene 1.

Step 3 Select a GRAFIK RA™ scene

At the GRAFIK RA™ Control Unit, select one of the pre-programmed scenes (1 through 4) by turning that scene ON.

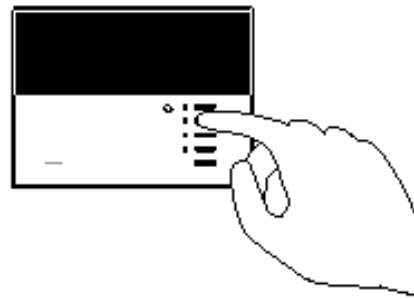

The GRAFIK RA™ Control Unit will turn ON to the scene selected in this step when the ROOM button is pushed. The last scene selected on the GRAFIK RA™ Control Unit will be the scene programmed to the ROOM button.

Note: If the GRAFIK RA™ Control Unit has been assigned an address (A1-A8), pre-programmed scenes 5 through 16 may be selected by putting the GRAFIK RA™ Control Unit into setup mode and recalling the desired scene. (Refer to the GRAFIK Eye® Installer's Guide for required steps.) The GRAFIK RA™ Control Unit should remain in setup mode until Step 5 of this section is completed.

User's Manual (Programming instructions)

ROOM Programming

Step 4 Select the next ROOM button

To select a GRAFIK RA™ scene for another Master Control ROOM button, press and release that button. Its LED will begin to blink.

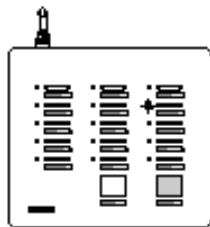
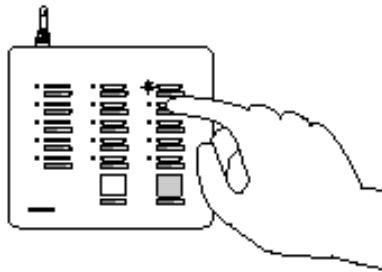

Select another pre-programmed scene on any GRAFIK RA™ Control Unit assigned to that ROOM button.

- Repeat Step 4 until GRAFIK RA™ scenes have been selected for all ROOM buttons which have a GRAFIK RA™ Control Unit assigned.

Step 5 Complete GRAFIK RA™ Scene Selection

Simultaneously press and hold the 1st and 5th buttons in the right most column until all LEDs begin to flutter (approximately 3 seconds).

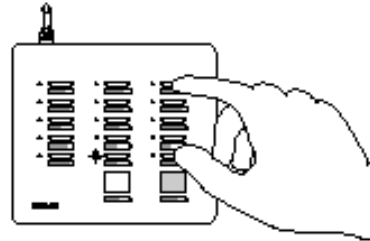

- Repeat Steps 1 through 5 to set GRAFIK RA™ scenes on any remaining Master Controls with ROOM buttons.

Congratulations. Your GRAFIK RA™ Control Unit is now programmed to work with your RadioRA® system. Relax and enjoy your system.

User's Manual (Programming instructions)

SCENE Programming

Assigning a GRAFIK RA™ Control Unit to SCENE Buttons

See the RadioRA® Setup Guide (P/N 044-001) for steps to assign a column of buttons as SCENE buttons.

What is a SCENE button?

SCENE buttons can be used to direct any combination of controls to a pre-selected state or light level. Pressing a SCENE button once will turn ON any control assigned to turn ON, and turn OFF any control assigned to turn OFF. Pressing the same SCENE button again will turn OFF all controls assigned to that button. A SCENE LED on a Master Control will be ON if, and only if, that SCENE button was pressed on that Master Control.

Step 1 Begin assigning GRAFIK RA™ Control Units to SCENE buttons

Simultaneously press the 2nd and 4th buttons in the right most column until the upper right LED begins to flash (approximately 3 seconds).

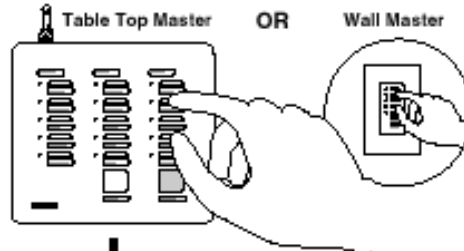

Upper right LED flashes.

Step 2 Select a SCENE button

Press and release the SCENE button that you want to program. Its LED will begin to flash

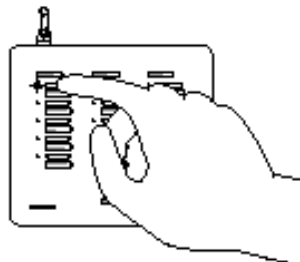

Step 3 Assign a GRAFIK RA™ Control Unit to button

Note: Multiple Dimmers, Switches or GRAFIK RA™ Control Units can be assigned to a single SCENE button.

Assign a GRAFIK RA™ Control Unit to the Master Control SCENE button by turning the GRAFIK RA™ Control Unit ON to any scene.



Be sure to assign all GRAFIK RA™ Control Units which will be turned OFF when activating this SCENE button.

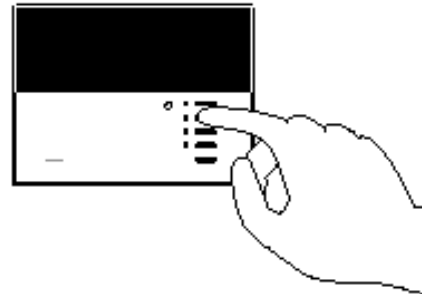

Note: GRAFIK RA™ Control Units will automatically turn ON to scene 1 once assigned.



If you assign the wrong GRAFIK RA™ Control Unit to a Master Control button, turn the GRAFIK RA™ Control Unit OFF to unassign it.



User's Manual (Programming instructions)

SCENE Programming

Step 4 Select next SCENE button

To assign a GRAFIK RA™ Control Unit to another Master Control SCENE button, press and release that button. Its LED will begin to flash.

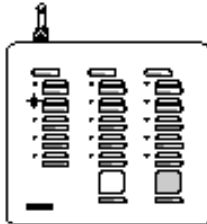
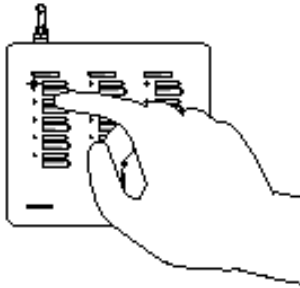

Turn ON the GRAFIK RA™ that is to be assigned to the selected SCENE button.

- Repeat Step 4 for all SCENE buttons to have GRAFIK RA™ Control Units assigned to them.

Step 5 Complete assigning GRAFIK RA™ Control Units

Simultaneously press and hold the 2nd and 4th buttons in the right most column until all LEDs begin to flutter (approximately 3 seconds).

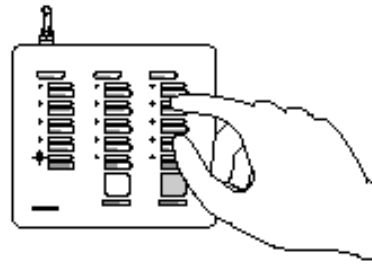

- Repeat Steps 1 through 5 to assign GRAFIK RA™ Control Units to SCENE buttons on any additional Master Controls.
- Proceed to GRAFIK RA™ Scene Selection on page 2-3.

User's Manual (Programming instructions)

SCENE Programming

GRAFIK RA™ Scene Selection for SCENE Buttons

Note: Programming the light levels of GRAFIK RA™ Control Unit scenes should be done prior to this step and in accordance with the GRAFIK Eye® Installer's Guide.

Step 1 Begin GRAFIK RA™ scene selection

Simultaneously press the 1st and 5th buttons in the right most column until the upper right LED begins to blink (approximately 3 seconds).

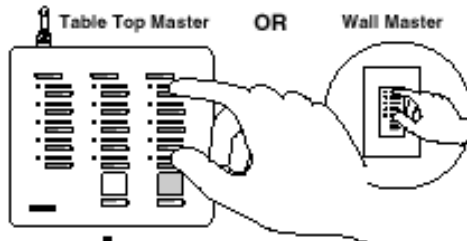

Upper right LED blinks.

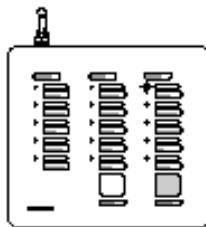

Step 2 Select a SCENE button

Press and release the SCENE button that you want to program. Its LED will begin to blink.

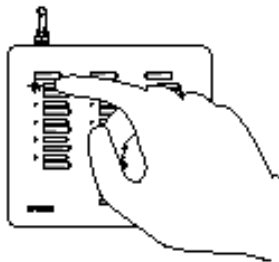

GRAFIK RA™ Control Units that have been assigned to that button will turn ON to scene 1.

Step 3 Select a GRAFIK RA™ scene

At the GRAFIK RA™ Control Unit, select from one of the pre-programmed scenes (1 through 4) by turning that scene ON *or* select OFF if this GRAFIK RA™ Control Unit is to be turned OFF when the Master Control SCENE button is pressed.

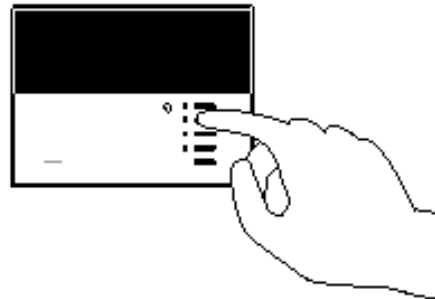

The GRAFIK RA™ Control Unit will turn ON to the scene selected in this step when the SCENE button is pushed. The last scene selected on the GRAFIK RA™ Control Unit will be the scene programmed to the SCENE button.

Note: If the GRAFIK RA™ Control Unit has been assigned an address (A1-A8), pre-programmed scenes 5 through 16 may be selected by putting the GRAFIK RA™ Control Unit into setup mode and recalling the desired scene. (Refer to the GRAFIK Eye® Installer's Guide for required steps.) The GRAFIK RA™ Control Unit should remain in setup mode until Step 5 of this section is completed.

User's Manual (Programming instructions)

SCENE Programming

Step 4 Select next SCENE button

To select a GRAFIK RA™ scene for another Master Control SCENE button, press and release that button. Its LED will begin to blink.

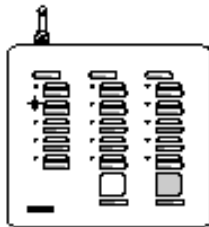
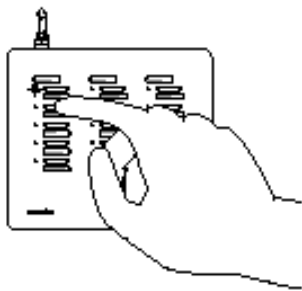

Select another pre-programmed scene on the GRAFIK RA™ Control Unit to be turned ON by pressing that Master Control SCENE button, *or* turn OFF the GRAFIK RA™ Control Units to be turned OFF by pressing that Master Control SCENE button.

- Repeat Step 4 until GRAFIK RA™ scenes have been selected for all SCENE buttons which have a GRAFIK RA™ Control Unit assigned.

Step 5 Complete GRAFIK RA™ scene selection

Simultaneously press the 1st and 5th buttons in the right most column until all LEDs begin to flutter (approximately 3 seconds).

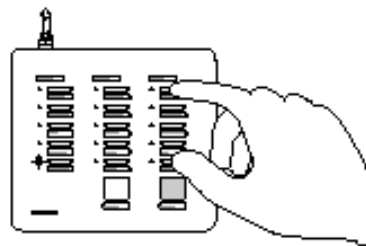

- Repeat Steps 1 through 5 to select GRAFIK RA™ scenes on any remaining Master Controls with SCENE buttons.

You may now operate your Master Control SCENE buttons

User's Manual (Programming instructions)

Troubleshooting Guide

Proper operation of the RadioRA® Wireless Central Home Lighting Control System is based upon a complex series of radio frequency (RF) communications between system components. As such, it is highly dependent upon proper system installation and programming of controls.

If you experience difficulties programming or operating your RadioRA® system, please refer to this guide. Many symptoms of common system activation or programming errors are contained in this Troubleshooting Guide. If you are having a problem with your system not described here, or if you have any questions, call the **Lutron Technical Support Center** at 1-800-523-9466.

	Symptom	Possible Cause	Remedy	Page
I	ACTIVATE CONTROLS LED on MAIN or AUXILIARY Repeater turns ON and then back OFF when attempting to go into ACTIVATE CONTROLS mode.	Your system has encountered a neighboring system within RF communication range also in ACTIVATE CONTROLS mode.	Discontinue activating your RadioRA® system until activation of the neighboring system is complete.	1-1
II	After activating a GRAFIK RA™ Control Unit, the Control Unit changes state, but does not flash the light(s) it controls.	GRAFIK RA™ Control Unit is out of RF communication range of nearest system Repeater.	Move a system Repeater closer to the control in question, or you may have to add another Repeater.	
		System is not in ACTIVATE CONTROLS mode.	Place system in ACTIVATE CONTROLS mode.	1-1
		GRAFIK RA™ Control Unit scene 1 has either a long fade time or low light levels are set.	Set GRAFIK RA™ Control Unit scene 1 to a zero second fade rate and full light intensity on all zones.	
III	A GRAFIK RA™ Control Unit appears to not be working at all.	Burned out or missing light bulbs	Replace light bulb.	
		No power available to the GRAFIK RA™ Control Unit.	Check that breaker is on and not tripped.	
		Unit has been wired incorrectly.	Refer to wiring instructions supplied with unit.	
IV	A GRAFIK RA™ Control Unit performs normally when operated manually, but fails to respond correctly to Master Control button pushes.	The GRAFIK RA™ Control Unit may be out of RF communication range of the nearest Repeater.	Verify that the GRAFIK RA™ Control Unit is in range of a Repeater by placing the system in FLASH mode.	1-2
		The GRAFIK RA™ Control Unit or Master Control has been incorrectly activated.	Verify that each GRAFIK RA™ Control Unit has been activated correctly by placing the system into FLASH mode.	1-2
		Master Control was not programmed properly.	Reprogram the Master Control.	
		The Master Control may be out of RF communication range of the nearest Repeater.	Verify whether the Master Control is in range of a Repeater by placing the system in BEEP mode.	
		Poor power line frequency regulation.	Call the Lutron Technical Support Center (1-800-523-9466) for further assistance.	

User's Manual (Programming instructions)

Returning Components to Default Factory Settings

GRAFIK RA™ Control Unit

 Returning a GRAFIK RA™ Control Unit to Default Factory Settings will delete all programming information. Do not do this unless you are sure that it is necessary. For more information call the *Lutron Technical Support Center*.

Step 1 Remove faceplate

Remove the faceplate from the GRAFIK RA™ Control Unit

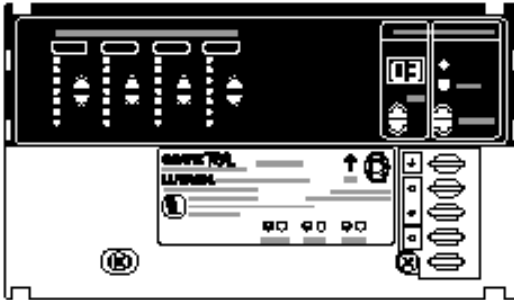

Step 2 Return to Default Factory Settings

Press and hold the ON/OFF button until the orange LED begins to blink (approximately 5 seconds).

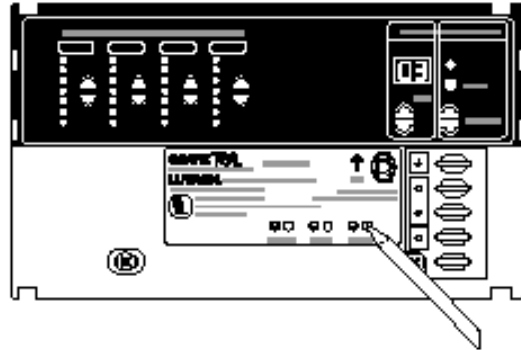

The GRAFIK RA™ Control Unit will turn ON and OFF a few times indicating that the interface has been returned to Default Factory Settings. Reattach the faceplate.

User's Manual (Programming instructions)

Limited Warranty

Lutron will, at its option, repair or replace any unit that is defective in materials or manufacture within one year after purchase. For warranty service, return unit to place of purchase or mail to Lutron Electronics Co., Inc. at 7200 Suter Rd., Coopersburg, PA 18036-1299, postage pre-paid.

THIS WARRANTY IS IN LIEU OF ALL OTHER EXPRESS WARRANTIES, AND THE IMPLIED WARRANTY OF MERCHANTABILITY IS LIMITED TO ONE YEAR FROM PURCHASE. THIS WARRANTY DOES NOT COVER THE COST OF INSTALLATION, REMOVAL OR REINSTALLATION, OR DAMAGE RESULTING FROM MISUSE, ABUSE, OR DAMAGE FROM IMPROPER WIRING OR INSTALLATION. THIS WARRANTY DOES NOT COVER INCIDENTAL OR CONSEQUENTIAL DAMAGES. LUTRON'S LIABILITY ON ANY CLAIM FOR DAMAGES ARISING OUT OF OR IN CONNECTION WITH THE MANUFACTURE, SALE, INSTALLATION, DELIVERY, OR USE OF THE UNIT SHALL NEVER EXCEED THE PURCHASE PRICE OF THE UNIT.

This warranty gives you specific legal rights, and you may have other rights which vary from state to state. Some states do not allow the exclusion or limitation of incidental or consequential damages, or limitation on how long an implied warranty may last, so the above limitations may not apply to you.

This product may be covered under one or more of the following U.S. patents: 4,835,343; 4,954,768; 5,248,919; 5,399,940; 5,637,930; 5,736,965; 5,798,581; 5,838,226; 5,848,054; 5,905,442; 5,982,103; DES 353,798; DES 378,814; DES 389,461; DES 389,805; DES 395,037; DES 404,013; DES 422,969; DES 428,855; DES 436,579; DES 439,220 and corresponding foreign patents. U.S. and foreign patents pending. Lutron, RadioRA, and GRAFIK Eye are registered trademarks, and FASS and GRAFIK RA are trademarks of Lutron Electronics Co., Inc.

© 2001 Lutron Electronics Co., Inc.

Technical Assistance

If you have questions concerning the installation or operation of this product, call the **Lutron Technical Support Center**. Please provide exact model number when calling.

(800) 523-9466 (U.S.A., Canada, and the Caribbean)

Other countries call (610) 282-3800

Fax (610) 282-3090

Visit our web site at www.lutron.com

World Headquarters

Lutron Electronics Co., Inc.

7200 Suter Road

Coopersburg, PA 18036-1299 U.S.A.

TOLL FREE: (800) 523-9466 (U.S.A., Canada, and the Caribbean)

Tel: (610) 282-3800

Fax: (610) 282-3090

Lutron Electronics Co., Inc., reserves the right to make improvements or changes in its products without prior notice. Although every attempt is made to ensure that this information is accurate and up to date, please check with Lutron to confirm product availability, latest specifications and suitability for your application.

