

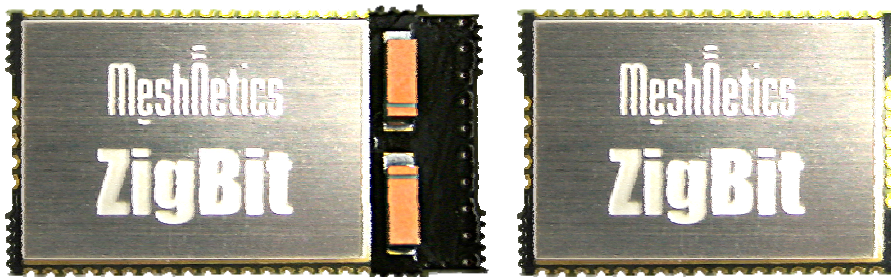

ZigBit™ OEM Modules

ZDM-A1281-*

**Ultra-Compact 2.4GHz 802.15.4/ZigBee Modules
for Wireless Networking Applications**



Product Datasheet

Table of Contents

Summary	3
Applications	3
Key features	3
Benefits.....	3
ZigBit™ Module Overview	4
Specifications	5
Absolute Maximum Ratings***	6
Physical/Environmental Characteristics and Outline	7
Pin Configuration.....	8
Mounting Information.....	12
Sample Antenna Reference Designs	13
Agency Certifications.....	18
Technical Support	20
Development Support	20
Ordering Information.....	20
Related Documents	21
Disclaimer.....	21
Trademarks	21
Contact Information.....	21

Summary

ZigBit™ stands for ultra-compact, low-power, high-sensitivity 2.4GHz 802.15.4/ZigBee 2006 OEM modules from MeshNetics, based on the innovative Atmel's mixed-signal hardware platform. They are designed for wireless sensing, control and data acquisition applications. The ZigBit modules eliminate the need for costly and time-consuming RF development, and shorten time to market for a wide range of wireless applications.

Two different versions of ZigBit modules are available: ZDM-A1281-B0 module with balanced RF port for applications where the benefits of PCB or external antenna can be utilized and ZDM-A1281-A2 module with chip antenna satisfying the needs of size sensitive applications.

Applications

ZigBit features standards-based networking stack, based on IEEE802.15.4 PHY and MAC layers, and ZigBee NWK/APS/ZDO layers. It enables multipoint, multihop communications over an area of thousands of square meters at moderate data rates without expensive infrastructure support. The architecture of the Wireless Sensor Networks (WSN) allows for use of low powered devices. The applications include, but are not limited to:

- Building automation & monitoring
 - Lighting controls
 - Wireless smoke and CO detectors
 - Structural integrity monitoring
 - HVAC monitoring & control
 - Inventory management
 - Environmental monitoring
 - Security
 - Water metering
 - Industrial monitoring
 - Machinery condition and performance monitoring
 - Monitoring of plant system parameters such as temperature, pressure, flow, tank level, humidity, vibration, etc.
 - Automated meter reading (AMR)
-

Key features

- Ultra compact size (24 x 13.5 mm for ZDM-A1281-A2 module and 18,8 x 13.5 mm for ZDM-A1281-B0 module)
- Innovative (patent-pending) balanced chip antenna design with antenna gain of approximately 0 dBi (for ZDM-A1281-A2 version)
- High RX sensitivity (-101 dBm)
- Outperforming link budget (104 dB)
- Up to 3 dBm output power
- Very low power consumption (<6 µA in deep sleep mode)
- Ample memory resources (128 kBytes of flash memory, 8 kBytes RAM, 4 kBytes EEPROM)
- Wide range of interfaces (both analog and digital):
 - 10 spare GPIO, 2 spare IRQ lines
 - 4 ADC lines
 - UART with CTS/RTS control
 - I²C, USART/SPI
- Up to 30 lines can be configured as GPIO
- Capability to write own MAC address into the EEPROM
- Optional antenna reference designs
- IEEE 802.15.4 compliant
- 2.4 GHz ISM band
- eZeeNet embedded software, including UART bootloader and AT command set

Benefits

- Less physical space constraints
- Best-in-class RF link range
- Longer battery life
- Easy prototyping with 2-layer PCB
- More memory for user software application
- Mesh networking capability
- Easy-to-use low cost Evaluation Kit
- Single source of support for HW and SW
- Worldwide license-free operation

ZigBit™ Module Overview

ZigBit is a low-power, high-sensitivity IEEE802.15.4/ZigBee-2006 compliant OEM module. This multi-functional device occupies less than a square inch of space, which is comparable to a typical size of a single chip. Based on a solid combination of Atmel's latest AVR Z-Link hardware platform [1], the ZigBit offers superior radio performance with exceptional ease of integration.

ZigBit modules comply with the FCC (Part 15), IC and ETSI (CE) rules applicable to the devices radiating in uncontrolled environment. For details, see section Agency Certifications below.

ZigBit fully satisfies the requirements of the "Directive 2002/95/EC of the European Parliament and the Council of 27 January 2003 on the restriction of the use of certain hazardous substances in electrical and electronic equipment" (RoHS). MeshNetics provides fully compliant product in all regions where the directive is enforced July 1, 2006.

The ZigBit contains Atmel's ATmega1281V Microcontroller [1] and AT86RF230 RF Transceiver [2]. The module features 128kb flash memory and 8 kb RAM.

The ZigBit already contains a complete RF/MCU-related design with all the necessary passive components included. The module can be easily mounted on a simple 2-layer PCB. Compared to a single-chip, a module-based solution offers considerable savings in development time & NRE cost per unit during the design & prototyping phase.

Innovative (patent-pending) chip antenna design in ZDM-A1281-A2 module eliminates the balun and achieves good performance over ZigBee frequency band.

MeshNetics provides tools for building ready-to-use applications around the ZigBit module. The Evaluation Kit and the Development Kit help prototyping and testing an 802.15.4 or ZigBee networking solution. It includes the sensor boards with multiple interfaces, an out-of-the-box data acquisition software suite, as well as accessories and documentation. The sample sensor data acquisition application allows network monitoring and data collection, all visualized via graphic interface.

The ZigBit modules come bundled with the eZeeNet networking firmware. The eZeeNet enables the module-based OEM products to form self-healing, self-organizing mesh networks. The eZeeNet stack conforms to IEEE802.15.4/ZigBee specifications [3], [4], [5].

Depending on your design requirements, you can use the ZigBit to operate a sensor node, where it would function as a single MCU. Or you can pair it to a host processor, where the module would serve essentially as a modem.

In the former case, a user application should be bundled with the eZeeNet software. The eZeeNet's programming interface gives users flexibility to manage network and minimize power consumption.

ZDM-A1281-B0 Block Diagram

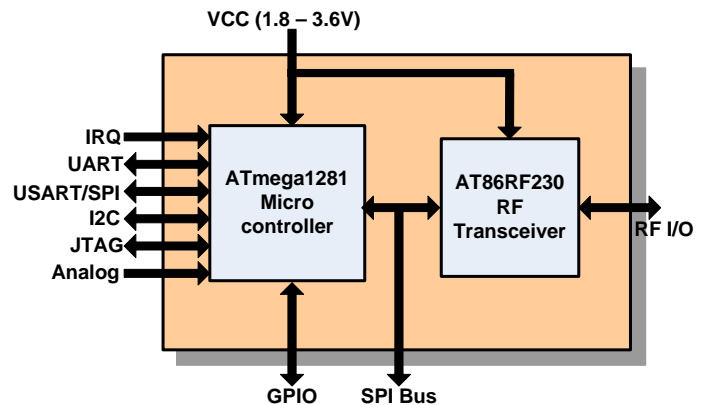

ZDM-A1281-A2 Block Diagram

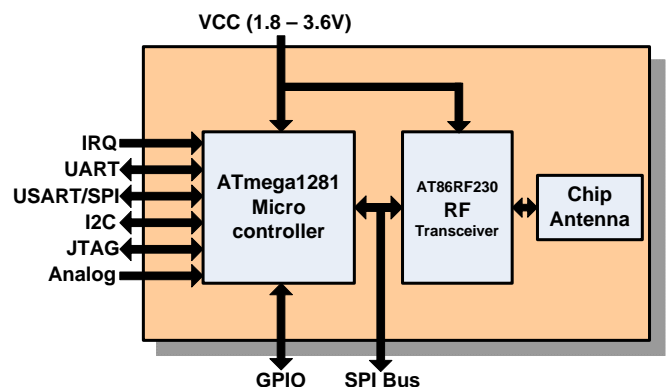

eZeeNet™ Block Diagram

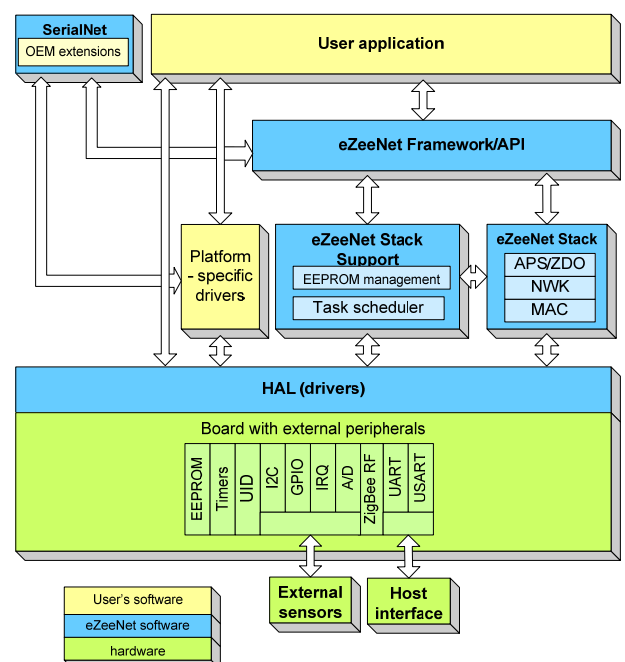

In the latter case, the host processor can control data transmission and manage module peripherals via powerful set of AT commands. This way, a minimum engineering effort for development of customer's devices is required. Additionally, the sensors can be connected directly to the module, thus expanding the existing set of sensor interfaces. The over-the-air control via AT-commands makes debugging and network testing easier. It also enables wireless module configuration during OEM mass-production process and provides flexible commissioning protocol for installation and maintenance of ZigBit-based devices.

The eZeeNet is compact private profile software from MeshNetics that is specifically tailored for data acquisition applications. It allows optimizing the network traffic, reducing power consumption, scheduling, and smart power management. The eZeeNet software comes with a set of drivers for standard peripherals (I²C, GPIO, ADC, etc.) that ensure the ZigBit module easy integration.

Specifications

Test Conditions (unless otherwise stated): $V_{cc} = 3\text{ V}$, $f = 2.45\text{ GHz}$, $T_{amb} = 25\text{ °C}$

Module Operating Conditions			
Parameters	Range	Unit	Condition
Supply Voltage (V_{cc})	1.8 to 3.6	V	
Current Consumption: RX mode	19	mA	see Note
Current Consumption: TX mode	18	mA	see Note
Current Consumption: Radio is turned off, MCU is active for 50% of the time.	14	mA	see Note
Current Consumption: Power Save mode	6	μA	see Note

Note: Parameters specified above are measured under the following conditions:

- eZeeNet software is running at 4 MHz clock rate, DTR line management is turned off
- all interfaces are set to the default state (see *Pin Assignment Table*)
- output TX power is 0 dBm
- JTAG is not connected
- $V_{cc} = 3.0\text{ V}$
- actual current consumption depends on multiple factors, including but not limited to the board design and materials, extra MCU load by user application, peripherals usage, EEPROM reading/writing, eZeeNet settings, network activity and so on.

RF Characteristics			
Parameters	Range	Unit	Condition
Frequency Band	2.400 to 2.4835	GHz	
Number of Channels	16		
Channel Spacing	5	MHz	
Transmitter Output Power	-17 to +3	dBm	Adjusted in 16 steps
Receiver Sensitivity	- 101	dBm	PER = 1%
On-Air Data Rate	250	kbps	
TX Output / Rx Input Nominal Impedance	100	Ohms	For balanced output

<i>ATmega1281V Microcontroller Characteristics</i>			
Parameters	Range	Unit	Condition
On-Chip Flash Memory Size	128	kBytes	
On-Chip RAM Size	8	kBytes	
On-Chip EEPROM Size	4	kBytes	
Operation Frequency	4	MHz	

<i>Module Interfaces Characteristics</i>			
Parameters	Range	Unit	Condition
UART Maximum Baud Rate	38.4	kbps	
ADC Resolution / Conversion Time	10 / 200	Bits / μ s	In the single conversion mode
ADC Input Resistance	100	MOhm	
ADC Reference Voltage (Vref)	1.0 to $V_{cc} - 0.3$	V	
ADC Input Voltage	0 ÷ Vref	V	
I ² C Maximum Clock	222	kHz	
GPIO Output Voltage (High/Low)	2.3 / 0.5	V	(-10 / 5 mA)
Real Time Oscillator Frequency	32.768	kHz	

Absolute Maximum Ratings***

Parameter	Min Value	Max Value
Voltage of any Pin except RESET with respect to Ground	-0.5 V	$V_{cc} + 0.5$ V
DC Current per I/O Pin		40 mA
DC Current D_VCC and DGND Pins		200 mA
Input RF Level		+10 dBm

*****Absolute Maximum Ratings** are the values beyond which damage to the device may occur. Under no circumstances must the absolute maximum ratings given in the following table be violated. Stresses beyond those listed under “Absolute Maximum Ratings” may cause permanent damage to the device.

This is a stress rating only and functional operation of the device at these or other conditions, beyond those indicated in the operational sections of this specification, is not implied. Exposure to absolute maximum rating conditions for extended periods may affect device reliability.

******Caution!** ESD-sensitive device. Precaution should be used when handling the device in order to prevent permanent damage.

Physical/Environmental Characteristics and Outline

Parameter	Value	Notes
Size	18.8 x 13.5 x 2.8 mm	ZDM-A1281-B0
	24.0 x 13.5 x 2.8 mm	ZDM-A1281-A2
Weight	1.3 g	ZDM-A1281-B0
	1.5 g	ZDM-A1281-A2
Operating Temperature Range	-20°C to +70°C	-40°C to +85°C operational*
Operating Relative Humidity Range	no more than 80%	

ZDM-A1281-B0 Mechanical Drawing

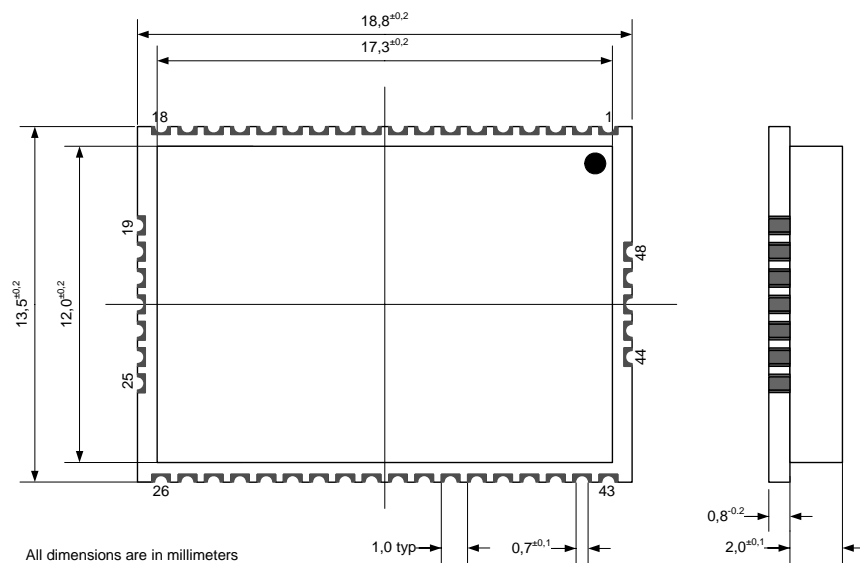

ZDM-A1281-A2 Mechanical Drawing

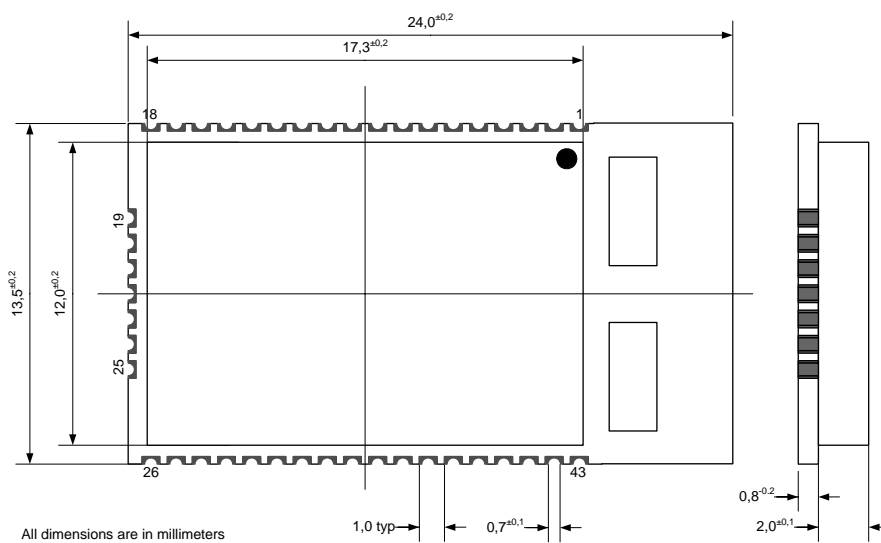

* Minor degradation of clock stability may occur

Pin Configuration

ZDM-A1281-B0 Pinout

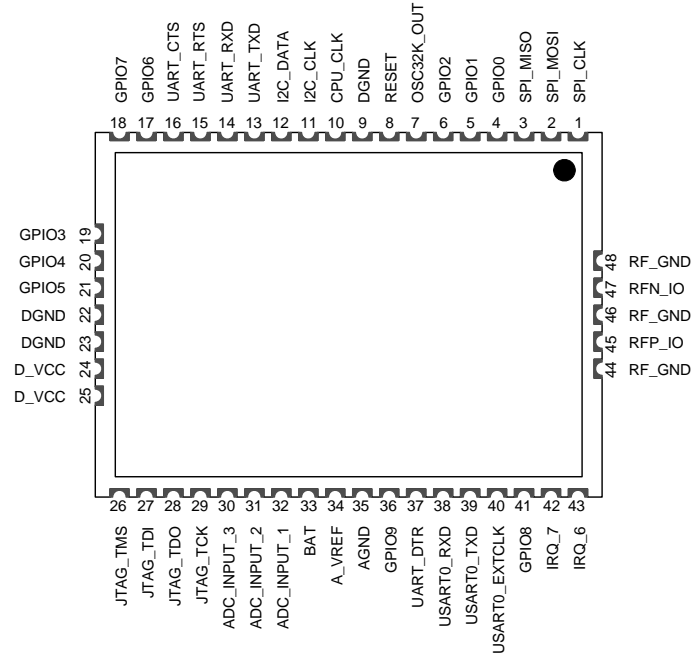

ZDM-A1281-A2 Pinout

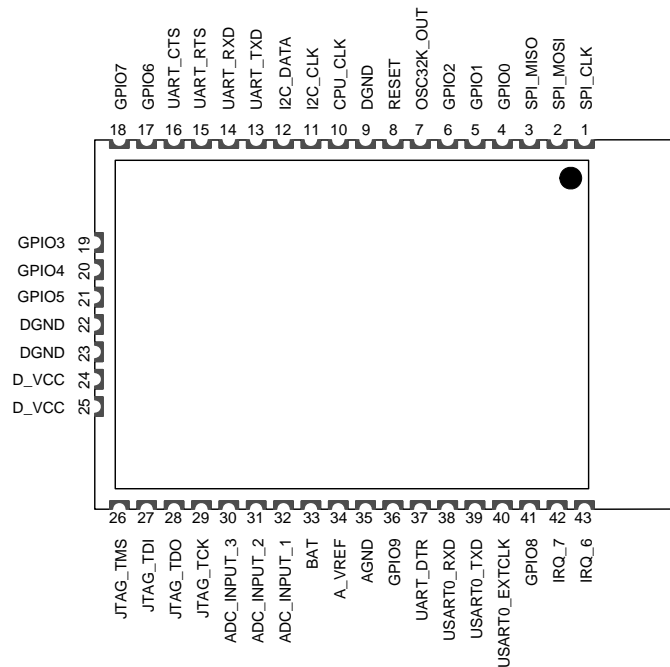

Pin Assignment Table

Connector Pin	Pin Name	Description	I/O	Default State after power on	Port ATmega 1281V	ATmega 1281v Datasheet Reference*	Notes, see list below
1	SPI_CLK	Reserved for stack operation	O		PB1	Page 189	3
2	SPI_MOSI	Reserved for stack operation	O		PB3		3
3	SPI_MISO	Reserved for stack operation	I/O		PB2		3
4	GPIO0	General purpose digital input/output 0	I/O	tri-state	PB5	Pages 78-79, 86-87, 109	1, 2, 3, 6
5	GPIO1	General purpose digital input/output 1	I/O	tri-state	PB6		1, 2, 3, 6
6	GPIO2	General purpose digital input/output 2	I/O	tri-state	PB7		1, 2, 3, 6
7	OSC32K_OUT	32.768 kHz clock output.	O		PG3	Page 99	3, 4
8	RESET	Reset input (active low).	I		RESET	Page 56	3
9, 22, 23	DGND	Digital ground					
10	CPU_CLK	RF clock output. When module is in active state, 4 MHz signal is present on this line. While module is in the sleeping state, clock generation is stopped also.	O		XTAL_In		3
11	I2C_CLK	I ² C serial clock output	O	tri-state	PD0	Pages 233-264,364	1, 2, 3, 6
12	I2C_DATA	I ² C serial data input/output	I/O	tri-state	PD1		1, 2, 3, 6
13	UART_TXD	UART receive pin	I	tri-state	PD2	Page 198	1, 2, 3, 6
14	UART_RXD	UART transmit pin	O	tri-state	PD3		1, 2, 3, 6
15	UART_RTS	RTS input (Request To Send) for UART hardware flow control. Active low.	I	tri-state	PD4	Pages 78-79, 91, 110	1, 2, 3, 6
16	UART_CTS	CTS output (Clear To Send) for UART hardware flow control. Active low.	O	tri-state	PD5		1, 2, 3, 6, 7
17	GPIO6	General purpose digital input/output 6	I/O	tri-state	PD6		1, 2, 3, 6
18	GPIO7	General purpose digital input/output 7	I/O	tri-state	PD7		1, 2, 3, 6
19	GPIO3	General purpose digital input/output 3	I/O	tri-state	PG0	Pages 79, 99, 111	1, 2, 3, 6
20	GPIO4	General purpose digital input/output 4	I/O	tri-state	PG1		1, 2, 3, 6
21	GPIO5	General purpose digital input/output 5	I/O	tri-state	PG2		1, 2, 3, 6
24, 25	D_VCC	Digital supply voltage (Vcc)					8
26	JTAG_TMS	JTAG test mode select	I		PF5	Pages 7,	1, 2, 3, 5

Connector Pin	Pin Name	Description	I/O	Default State after power on	Port ATmega 1281V	ATmega 1281v Datasheet Reference*	Notes, see list below
27	JTAG_TDI	JTAG test data input	I		PF7	97, 288	1, 2, 3, 5
28	JTAG_TDO	JTAG test data output	O		PF6		1, 2, 3, 5
29	JTAG_TCK	JTAG test clock	I		PF4		1, 2, 3, 5
30	ADC_INPUT_3	ADC input channel 3	I	tri-state	PF3	Pages 97, 266-287	1, 2, 6
31	ADC_INPUT_2	ADC input channel 2	I	tri-state	PF2		1, 2, 6
32	ADC_INPUT_1	ADC input channel 1	I	tri-state	PF1		1, 2, 6
33	BAT	ADC input channel 0. Used by the stack for battery level measurement. Nominal voltage is 1 V in respect to AGND.	I	tri-state	PF0		1, 2, 6
34	A_VREF	Output/Input reference voltage for ADC	I/O	tri-state	AREF	Pages 274, 280	
35	AGND	Analog ground					
36	GPIO9	General purpose digital input/output 9	I/O		PG5		1, 2, 3, 6
37	UART_DTR	DTR input (Data Terminal Ready) for UART. Active low.	I	tri-state	PE4	Pages 73, 93	1, 2, 3, 6
38	USART0_RXD	UART/SPI receive pin	I	tri-state	PE0	Pages 198, 224, 198-232	1, 2, 3, 6
39	USART0_TXD	UART/SPI transmit pin	O	tri-state	PE1		1, 2, 3, 6
40	USART0_EXT_CLK	UART/SPI external clock	I	tri-state	PE2		1, 2, 3, 6
41	GPIO8	General purpose digital input/output 8	I/O	tri-state	PE3	Pages 73, 93-96	1, 2, 3, 6
42	IRQ_7	Digital input interrupt request 7	I	tri-state	PE7		1, 2, 3, 6
43	IRQ_6	Digital input interrupt request 6	I	tri-state	PE6		1, 2, 3, 6
44, 46, 48	RF_GND	RF analog ground					9
45	RFP_IO	Differential RF input/output.	I/O				9
47	RFN_IO	Differential RF input/output.	I/O				9

Notes:

- *Most of pins can be configured for general purpose I/O or for some alternative functions as described in details in the ATmega1281V Datasheet [1].
- GPIO pins can be programmed either for output, or input with/without pull-up resistors. Output pin drivers are strong enough to drive LED displays directly (refer to figures on pages 387-388, [1]).
- All digital pins are provided with protection diodes to D_VCC and DGND
- It is strongly recommended to avoid assigning an alternative function for OSC32K_OUT pin because it is used by eZeeNet Framework. However, this signal can be used if another peripheral or host processor requires 32.768 kHz clock, otherwise this pin can be disconnected.
- Normally, JTAG_TMS, JTAG_TDI, JTAG_TDO, JTAG_TCK pins are used for on-chip debugging and flash burning. They can be used for A/D conversion if JTAGEN fuse is disabled.
- eZeeNet software can configure as general-purpose I/O lines the following pins: GPIO0, GPIO1, GPIO2, GPIO3, GPIO4, GPIO5, GPIO6, GPIO7, GPIO8, GPIO9, I2C_CLK, I2C_DATA, UART_TXD, UART_RXD, UART_RTS, UART_CTS, ADC_INPUT_3, ADC_INPUT_2, ADC_INPUT_1, BAT, UART_DTR, USART0_RXD, USART0_TXD, USART0_EXTCLK, IRQ_7, IRQ_6. Additionally, four JTAG lines could be

programmed with software as GPIO as well, but this requires changing the fuse bits and will disable JTAG debugging.

7. CTS pin can be configured by eZeeNet to indicate sleep/active condition of the module thus providing mechanism for power management of host processor. If such functionality is needed, it is recommended to connect external pull-down resistor to this pin to prevent undesirable transients during module reset process.
8. It is recommended to use ferrite bead and 1 μ F capacitor located closely to the power supply pin, as shown below.

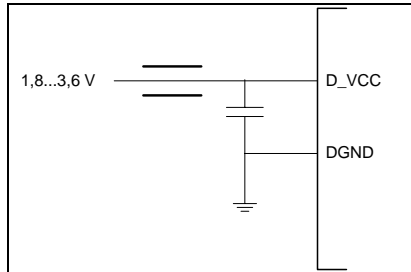

9. Pins 44 through 48 are not present on the module with chip antennas

Typical schematics

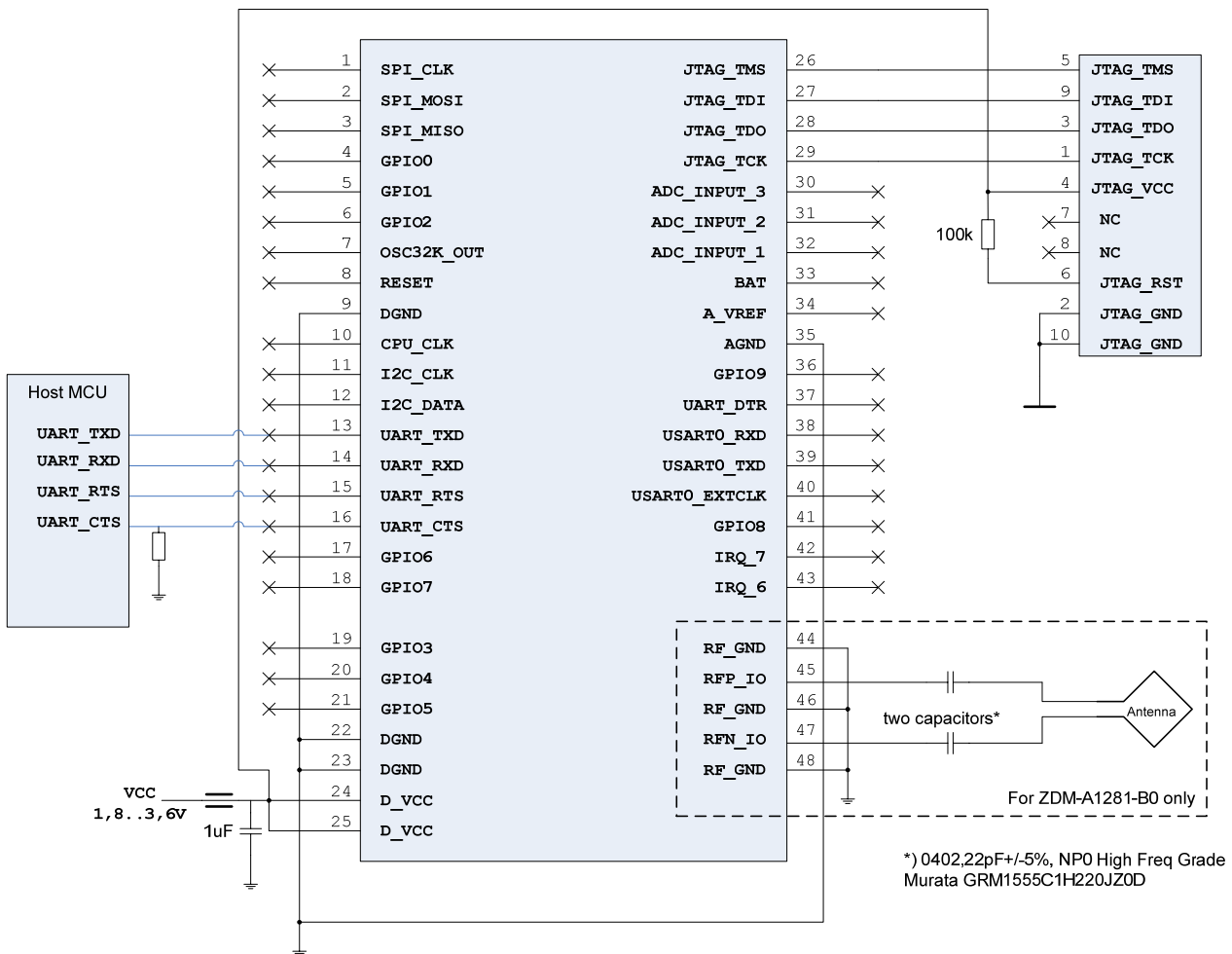

Mounting Information

ZDM-A1281-B0 PCB Recommended Layout, Top View

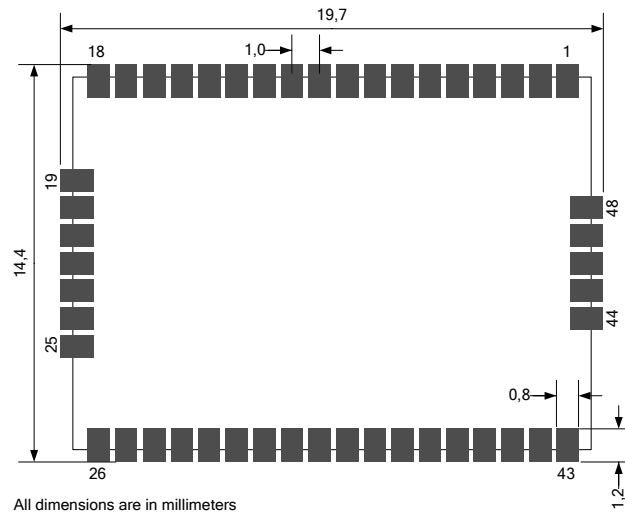

ZDM-A1281-A2 PCB Recommended Layout, Top View

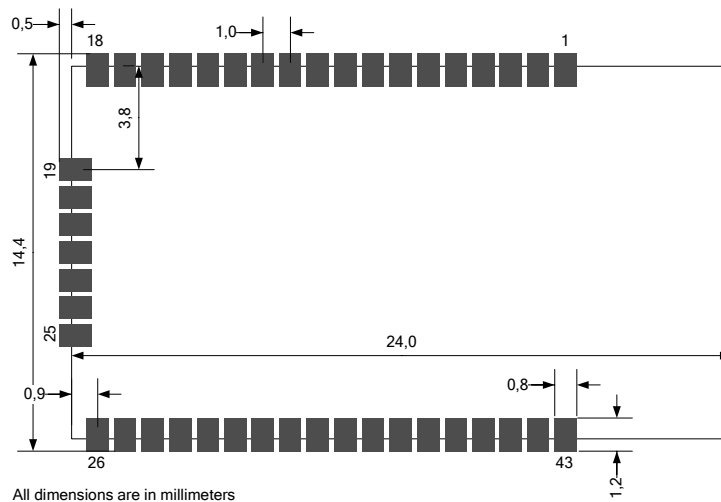

The above diagrams show the recommended PCB layout for ZigBit module. No via-holes and no wires are allowed on the PCB upper layer in the area occupied by the module. As a critical requirement, RF_GND pins should be grounded via several holes located very close to pins thus minimizing inductance and preventing mismatch and losses.

Sample Antenna Reference Designs

The following reference antenna design shows an example that can serve as a basis for further optimization. The symmetric dipole antenna shown below has been tuned for a particular case, so the cut-and-paste approach would not necessarily ensure an optimum performance because of multiple factors affecting the antenna matching and pattern (for instance, the board material and thickness, shields, the material of enclosure, the board neighborhood, other components located next to antenna and so on). As a general recommendation, metal enclosures or setting high profile components closely to antenna should be avoided. Using low profile enclosures can, furthermore, cause antenna tuning. The holes shown located around the board eliminate the undesirable antenna pattern distortions which might be induced by radiation from the board edges. The ZigBit module should not be placed next to components causing undesirable interference in its operating frequency band or adjacent bands, such as GSM, CDMA, WiFi, and Bluetooth.

PCB Layout: Symmetric Dipole Antenna recommended for ZDM-A1281-B0

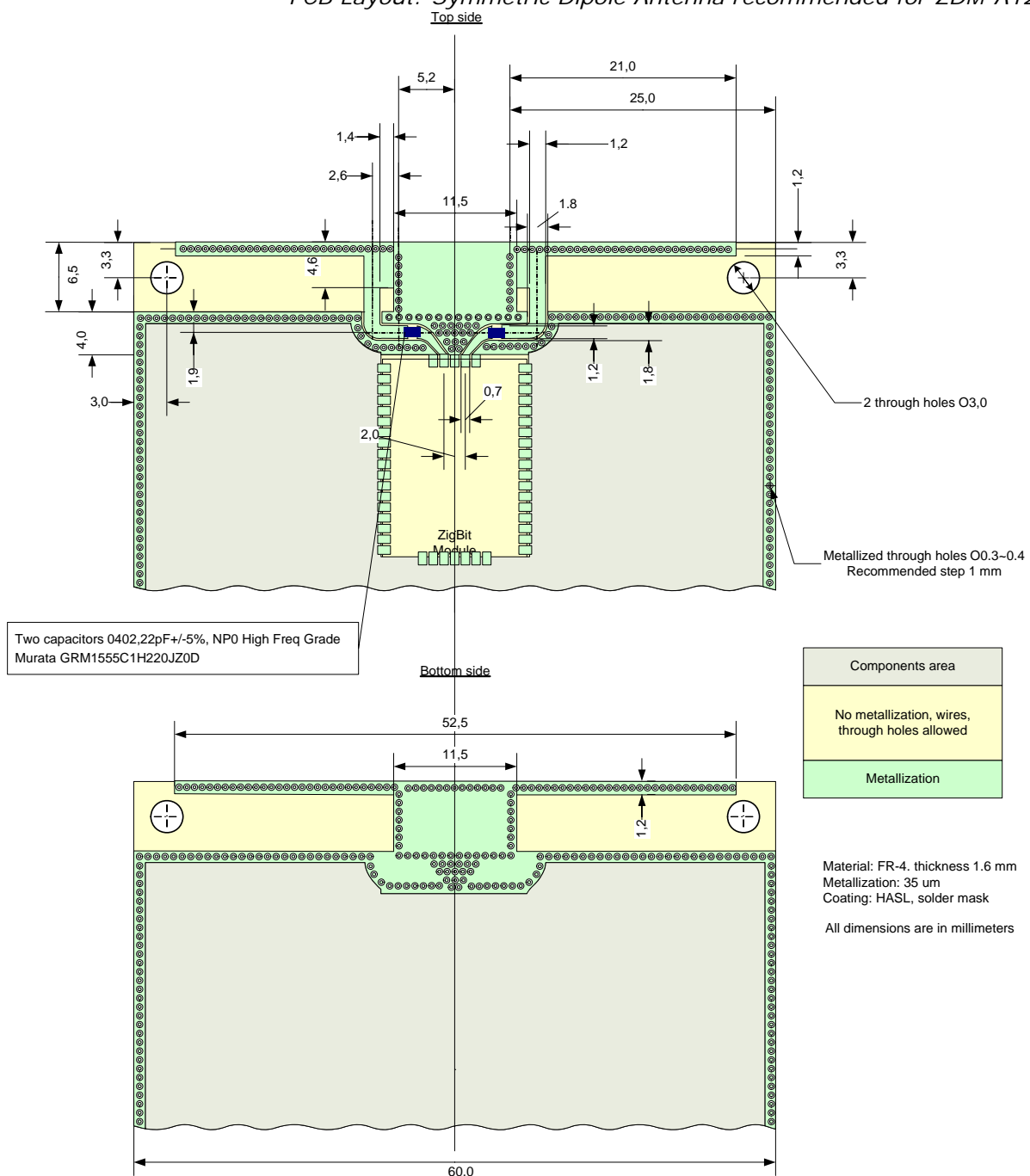

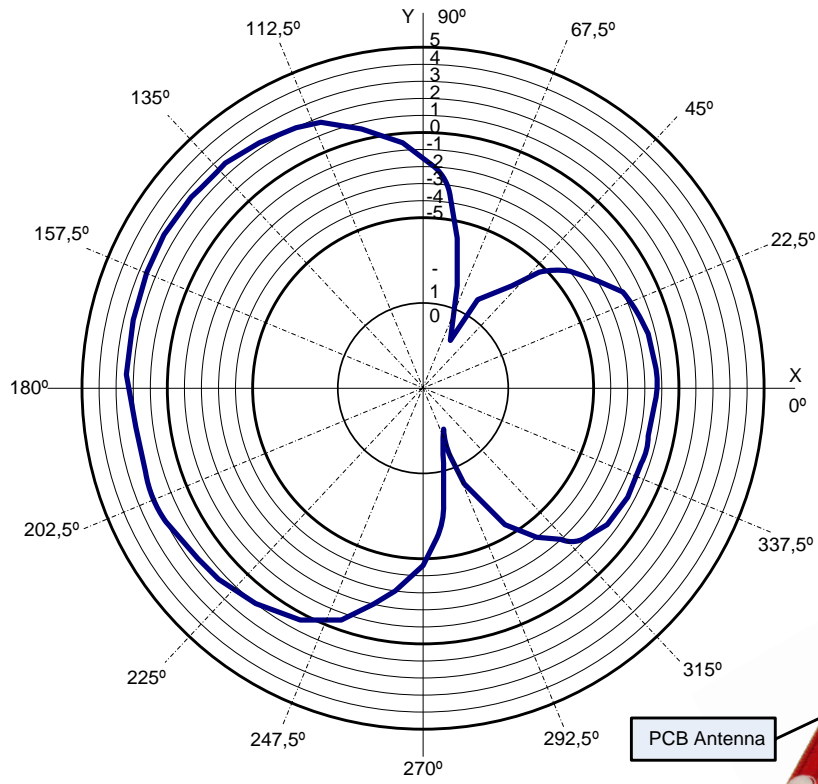

ZDM-A1281-B0 Pattern:
Symmetric Dipole Antenna
(horizontal plane)

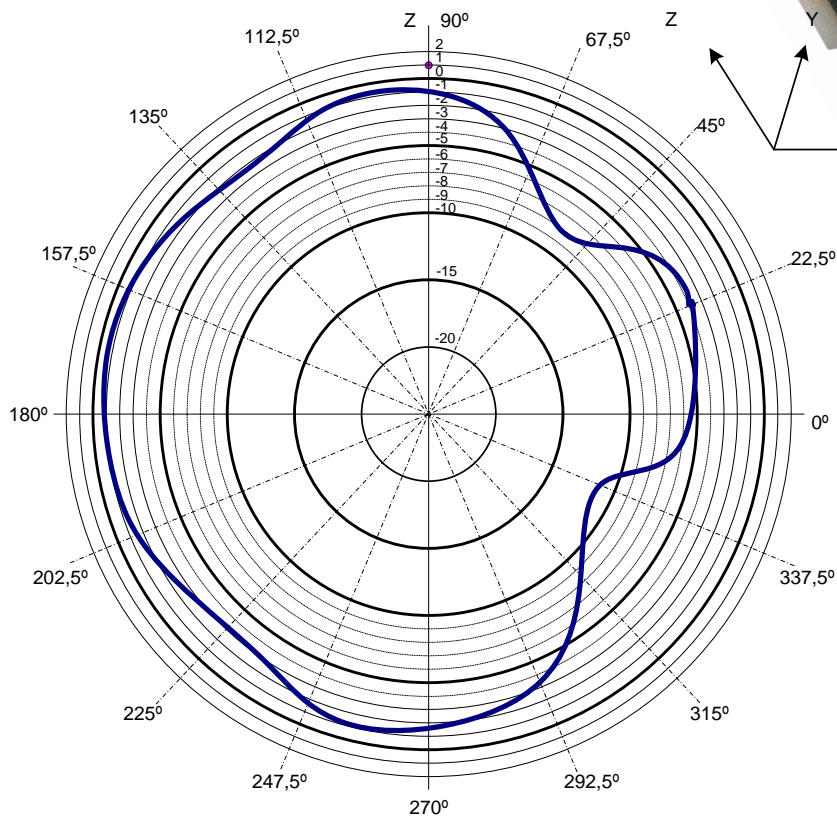
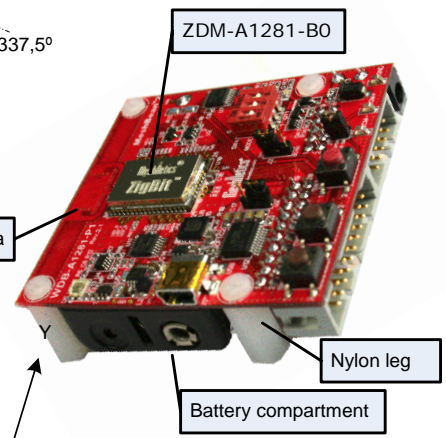

ZDM-A1281-B0 Pattern
(vertical plane)

ZDM-A1281-A2 Pattern
(horizontal plane)

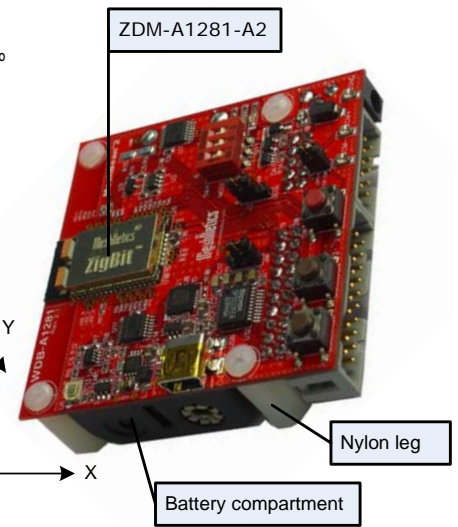
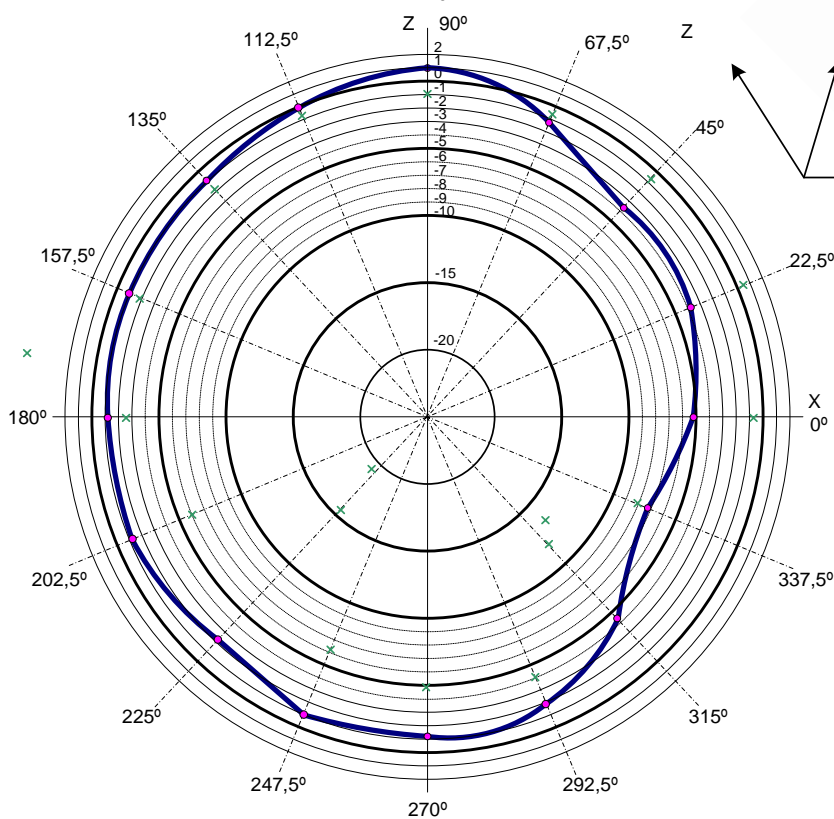
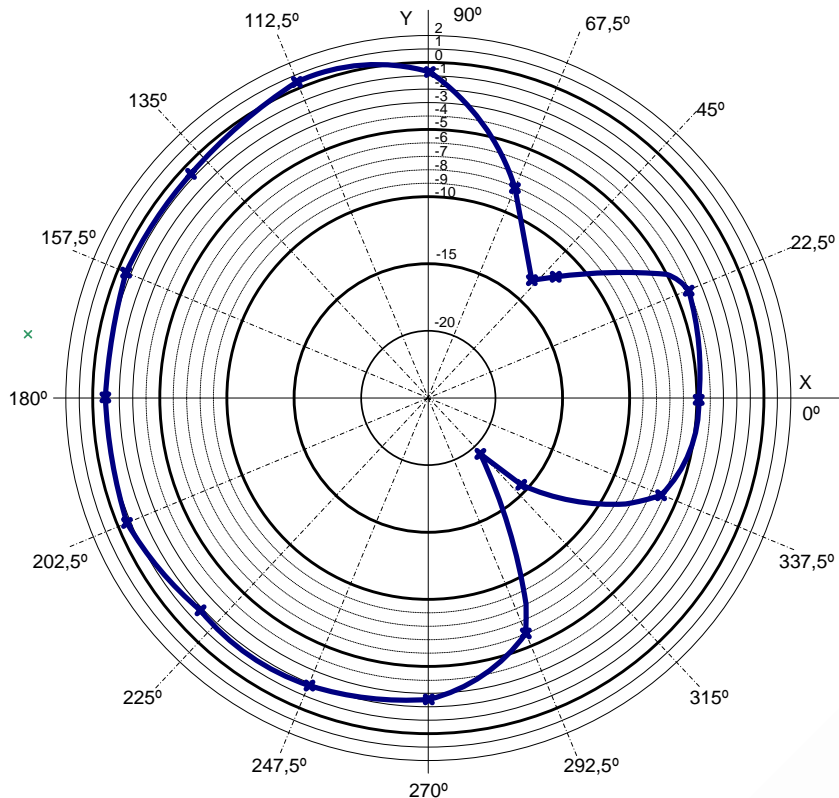

ZDM-A1281-A2 Pattern
(vertical plane)

Note: The presented antenna patterns were observed using PCB enhanced with legs made of original nylon.

Normally chip antennas are more tolerant of board and enclosure materials, and ZigBit module neighborhood; however, general recommendations for board design for the PCB antenna version still apply.

The board should be designed such that it prevents propagation of microwave field inside the board material itself. High frequency electromagnetic field may penetrate the board and radiate from the edges of the board causing undesirable pattern distortions. To eliminate this effect, it is often enough to surround the board with metallized holes connected to module ground.

Since the module with chip antenna is tuned for installation on FR-4 board with thickness 1.6 mm, the performance is guaranteed only if the board is designed according to the diagram below. Deviations from this design may change the performance.

Recommended Layout for Chip Antenna Module (ZDM-A1281-A2)

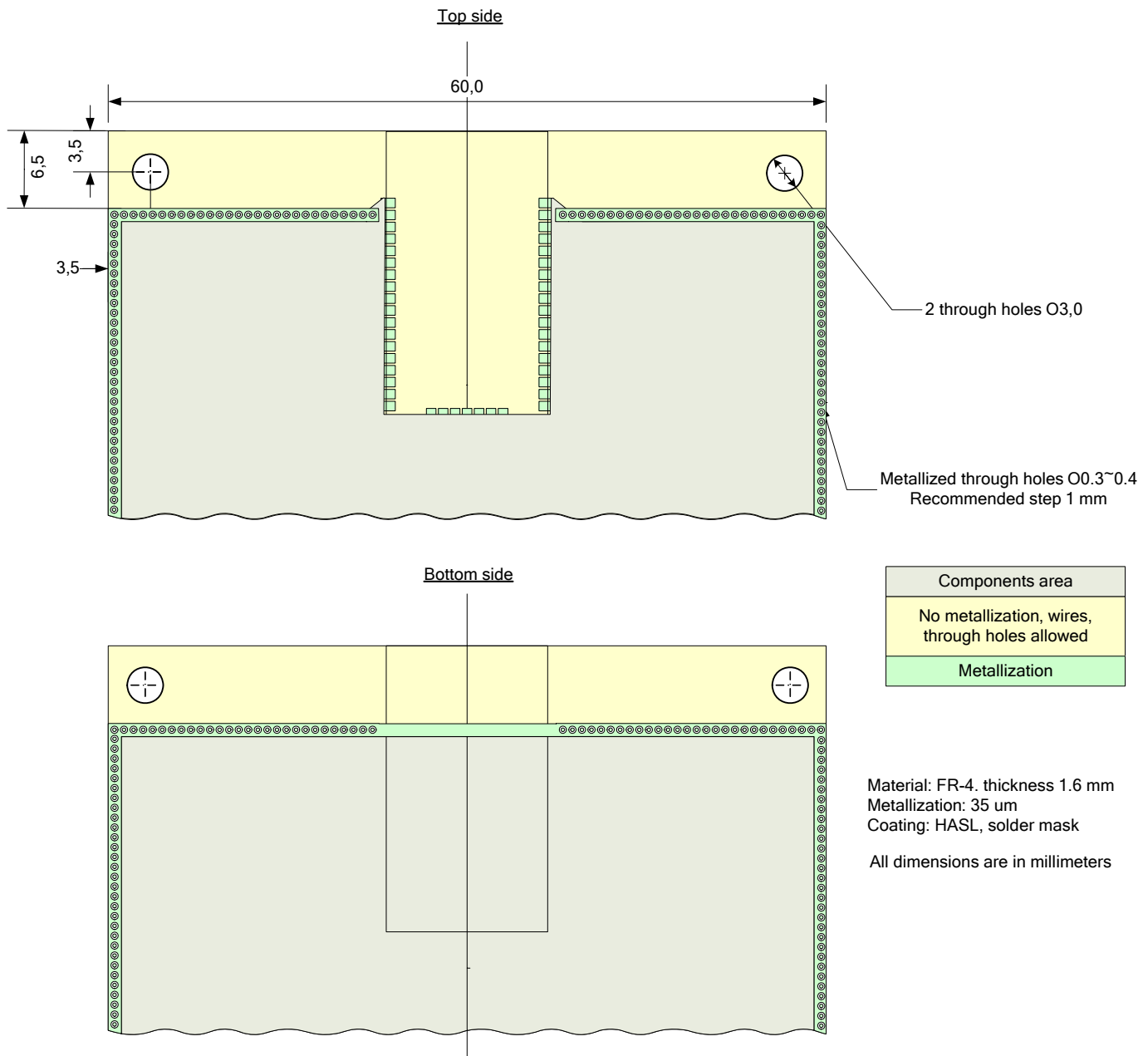

Recommended PCB Layout for 50 Ohm External Antenna (ZDM-A1281-B0)

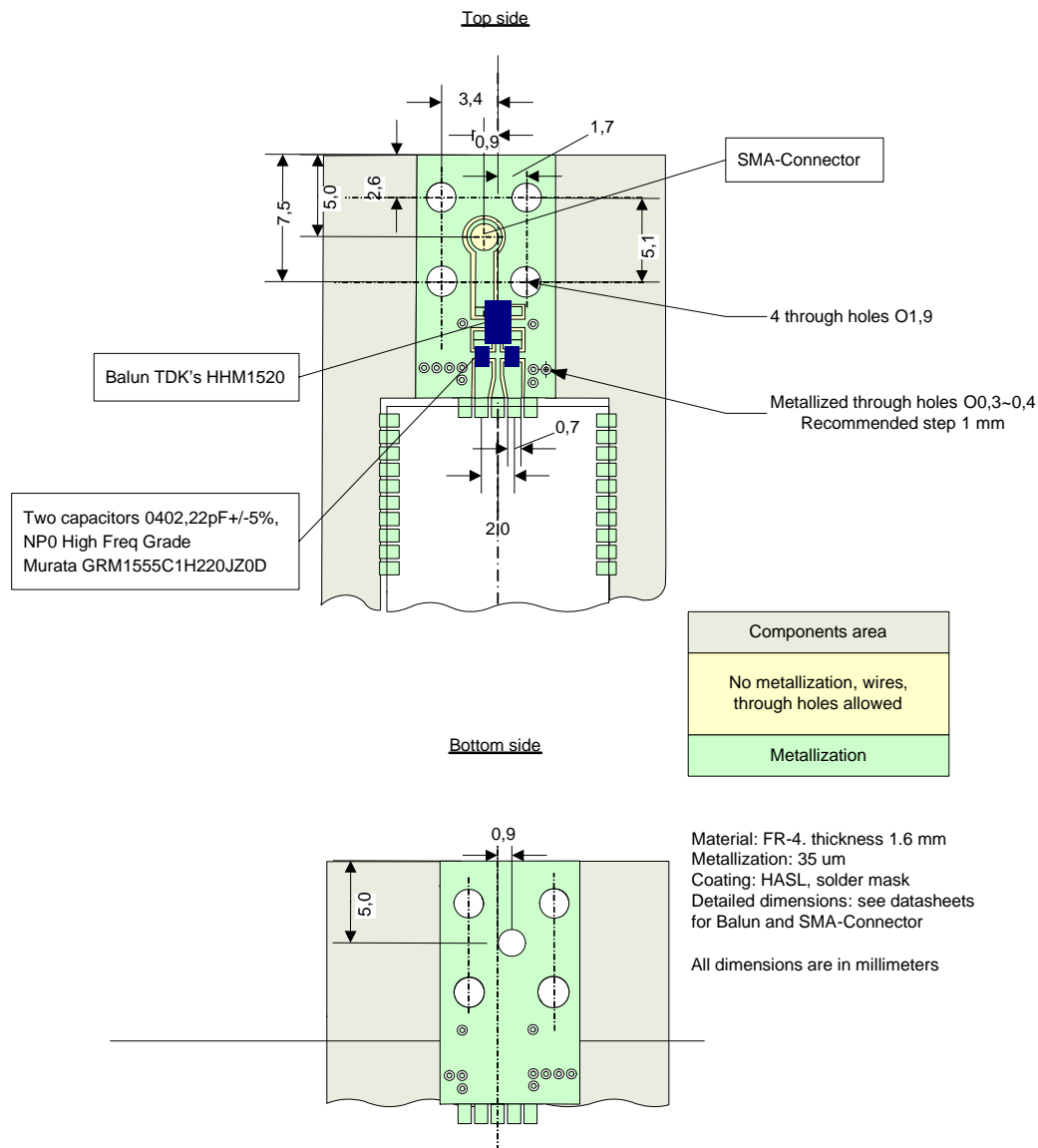

In case an external antenna or a 50 Ohm unbalanced antenna is required, they can be easily interfaced to ZigBit module ZDM-A1281-B0 by using 2:1 balun as shown above. This recommended sample demonstrates how to use low-profile Murata connector. It can be simply replaced with 50 Ohm microstrip line as shown in TDK's HHM1520 Balun Datasheet [6].

Agency Certifications

UNITED STATES (FCC)

This equipment complies with Part 15 of the FCC rules and regulations.

To fulfill FCC Certification requirements, an OEM manufacturer must comply with the following regulations:



1. The modular transmitter must be labelled with its own FCC ID number, and, if the FCC ID is not visible when the module is installed inside another device, then the outside of the device into which the module is installed must also display a label referring to the enclosed module. This exterior label can use wording such as the following:

Example of label required for OEM product containing ZDM-A1281-A2 module

Contains FCC ID: U6TZIGBIT-A2

The enclosed device complies with Part 15 of the FCC Rules. Operation is subject to the following two conditions: (i.) this device may not cause harmful interference and (ii.) this device must accept any interference received, including interference that may cause undesired operation.

Example of label required for OEM product containing ZDM-A1281-B0 module

Contains FCC ID: U6TZIGBIT-B0

The enclosed device complies with Part 15 of the FCC Rules. Operation is subject to the following two conditions: (i.) this device may not cause harmful interference and (ii.) this device must accept any interference received, including interference that may cause undesired operation.

Any similar wording that expresses the same meaning may be used.

2. To be used with the ZDM-A1281-B0 module, the external antennas have been tested and approved which are specified in *Approved Antenna List* herebelow. The ZDM-A1281-B0 Module may be integrated with other custom design antennas which OEM installer must authorize following the FCC 15.21 requirements.

WARNING: The Original Equipment Manufacturer (OEM) must ensure that the OEM modular transmitter must be labeled with its own FCC ID number. This includes a clearly visible label on the outside of the final product enclosure that displays the contents shown below. If the FCC ID is not visible when the equipment is installed inside another device, then the outside of the device into which the equipment is installed must also display a label referring to the enclosed equipment.

IMPORTANT: This equipment complies with Part 15 of the FCC Rules. Operation is subject to the following two conditions: (1) this device may not cause harmful interference, and (2) this device must accept any interference received, including interference that may cause undesired operation (FCC 15.19).

The internal / external antenna(s) used for this mobile transmitter must provide a separation distance of at least 20 cm from all persons and must not be co-located or operating in conjunction with any other antenna or transmitter.

Installers must be provided with antenna installation instructions and transmitter operating conditions for satisfying RF exposure compliance. This device is approved as a mobile device with respect to RF exposure compliance, and may only be marketed to OEM installers. Use in portable exposure conditions (FCC 2.1093) requires separate equipment authorization.

IMPORTANT: Modifications not expressly approved by this company could void the user's authority to operate this equipment (FCC section 15.21).

IMPORTANT: This equipment has been tested and found to comply with the limits for a Class A digital device, pursuant to Part 15 of the FCC Rules. These limits are designed to provide reasonable protection against harmful interference when the equipment is operated in a commercial environment. This equipment generates, uses, and can radiate radio frequency energy and, if not installed and used in accordance with the instruction manual, may cause harmful interference to radio communications. Operation of this equipment in a residential area is likely to cause harmful interference in which case the user will be required to correct the interference at his own expense (FCC section 15.105).

CANADA (IC)

Equipment is subject to certification under the applicable RSSs, shall be permanently labelled on each item, or as an inseparable combination. The label must contain the following information for full compliance:

For ZDM-A1281-A2 module:

Certification Number:	IC: 7036A-ZIGBITA2
Manufacturer's Name, Trade Name or Brand Name:	ZIGBIT
Model Name:	ZDM-A1281-A2

For ZDM-A1281-B0 module:

Certification Number:	IC: 7036A-ZIGBITB0
Manufacturer's Name, Trade Name or Brand Name:	ZIGBIT
Model Name:	ZDM-A1281-B0

IMPORTANT: This equipment for which a certificate has been issued is not considered certified if it is not properly labelled. The information on the Canadian label can be combined with the manufacturer's other labelling requirements

IMPORTANT: Operation is subject to the following two conditions: (1) this device may not cause harmful interference, and (2) this device must accept any interference received, including interference that may cause undesired operation.

IMPORTANT: To reduce potential radio interference to other users, the antenna type and its gain should be so chosen that the equivalent isotropically radiated power (e.i.r.p.) is not more than that permitted for successful communication.

IMPORTANT: The installer of this radio equipment must ensure that the antenna is located or pointed such that it does not emit RF field in excess of Health Canada limits for the general population. Consult Safety Code 6, obtainable from Health Canada's website www.hc-sc.gc.ca/rpb.

EUROPEAN UNION (ETSI)

The ZDM-A1281-A2 and ZDM-A1281-B0 Modules has been certified for use in European Union countries.

If the ZDM-A1281-A2 and ZDM-A1281-B0 Modules are incorporated into a product, the manufacturer must ensure compliance of the final product to the European harmonized EMC and low-voltage/safety standards. A Declaration of Conformity must be issued for each of these standards and kept on file as described in Annex II of the R&TTE Directive.

Furthermore, the manufacturer must maintain a copy of the ZDM-A1281-A2 and ZDM-A1281-B0 Modules documentation and ensure the final product does not exceed the specified power ratings, antenna specifications, and/or installation requirements as specified in the user manual. If any of these specifications are exceeded in the final product, a submission must be made to a notified body for compliance testing to all required standards.

IMPORTANT: The 'CE' marking must be affixed to a visible location on the OEM product. The CE mark shall consist of the initials "CE" taking the following form:



- If the CE marking is reduced or enlarged, the proportions given in the above graduated drawing must be respected.
- The CE marking must have a height of at least 5mm except where this is not possible on account of the nature of the apparatus.
- The CE marking must be affixed visibly, legibly, and indelibly.

More detailed information about CE marking requirements you can find at **"DIRECTIVE 1999/5/EC OF THE EUROPEAN PARLIAMENT AND OF THE COUNCIL"** on 9 March 1999 at section 12.

Certification Approved Antennas list is presented in *Approved Antenna List* below.

Approved Antenna List

ZDM-A1281-A2 Module has only possibility to work with installed chip-antenna. The design of the chip-antenna is fully tested and satisfies all the legislation mentioned above.

ZDM-A1281-B0 Module has been tested and approved for use with the antennas listed in the table below. The ZDM-A1281-B0 Module may be integrated with other custom design antennas which OEM installer must authorize following the respective legislation requirements.

Part Number	Manufacturer & Description	Gain, dBi	Min. Separation, cm
2010B4844-01	Antenova Titanis, swivel antenna (1/4 wave antenna) with SMA connector, frequency range 2.4-2.5 GHz	4.1	20
17010.10	WiMo, swivel antenna (1/2 wave antenna) with SMA connector, frequency range 2.35-2.5 GHz	2.1	20

Technical Support

Tel: +7 (495) 725 8125

E-mail: support@meshnetics.com

Development Support

- Easy-to-use Evaluation and Development Kits are available.
- Source code samples and RF reference designs are available to qualified customers.
- MeshNetics runs the ZigBit Priority Support Program to facilitate faster delivery of ZigBit-based applications to the market. The qualified customers enjoy priority samples policy, direct access to MeshNetics RF experts, 802.15.4 MAC-, eZeeNet stack- and Gateways- development teams, dedicated FAE for application consulting and other technical resources to accelerate the development of ZigBit-based products and applications. To qualify for the Program, please contact us at zigbit@meshnetics.com for more details.

Ordering Information

You can contact MeshNetics for additional modules, the Evaluation Kit or the Developer's Kit to build your custom network. Please e-mail us at zigbit@meshnetics.com, or visit us online at www.meshnetics.com/contacts.

Please specify the product part number and description when ordering.

Part Number	Description
ZDM-A1281-B0	2.4 GHz IEEE802.15.4/ZigBee OEM Module w/ Balanced RF Port
ZDM-A1281-A2	2.4 GHz IEEE802.15.4/ZigBee OEM Module with chip antennas

Related Documents

- [1] Atmel 8-bit AVR Microcontroller with 64K/128K/256K Bytes In-System Programmable Flash. 2549F-AVR-04/06
 - [2] Atmel Low-Power Transceiver for ZigBee Applications. AT86RF230 Target Specification. 5131A-ZIGB-08/15/05
 - [3] IEEE Std 802.15.4-2003 IEEE Standard for Information technology – Part 15.4 Wireless Medium Access Control (MAC) and Physical Layer (PHY) Specifications for Low-Rate Wireless Personal Area Networks (LR-WPANs)
 - [4] ZigBee Specification. ZigBee Document 053474r14, November 03, 2006
 - [5] eZeeNet™ IEEE802.15.4/ZigBee Software. Product Datasheet. MeshNetics Doc. M-251~02
 - [6] Multilayer Baluns, HHM Series. HHM1520 For Bluetooth & IEEE802.11b/g, www.tdk.co.jp/tefe02/e8balun_hhm.pdf
-

Disclaimer

MeshNetics believes that all information is correct and accurate at the time of issue. MeshNetics reserves the right to make changes to this product without prior notice. Please visit MeshNetics website for the latest available version. MeshNetics does not assume any responsibility for the use of the described product or convey any license under its patent rights.

Trademarks

MeshNetics®, ZigBit, eZeeNet, ZigBeeNet, SensiLink, LuxLabs, Luxoft Labs, and MeshNetics, Luxoft Labs and ZigBit logos are trademarks of LuxLabs Ltd.

All other product names, trade names, trademarks, logos or service names are the property of their respective owners.

© 2007 MeshNetics. All rights reserved.

No part of the contents of this manual may be transmitted or reproduced in any form or by any means without the written permission of MeshNetics.

Contact Information

MeshNetics

9 Dmitrovskoye Shosse

Moscow 127434, Russia

Tel: +7 (495) 725 8125

Fax: +7 (495) 725 8116

E-mail: zigbit@meshnetics.com

Website: www.meshnetics.com

Office hours: 8:00am – 5:00pm (Central European Time)

