

XAP-1440 Mounting Guide

Mounting Installation Package Contents

1

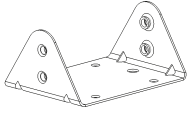

Stainless steel mount #1 (qty 1)

2

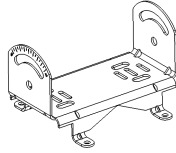

Stainless steel mount #2 (qty 1)

3



M4 machine screws (qty 4)
W4 flat washers (qty 4)

4



Screw anchors (qty 4)
Stainless steel screws (qty 4)

5

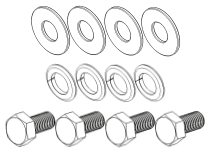

M5 machine screws (qty 4)
W5 flat washers (qty 4)
SW5 washers (qty 4)

6

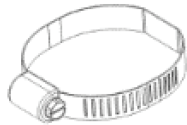

1-1/2" stainless pipe strap (qty 1)

Install Mount on Bottom Cover

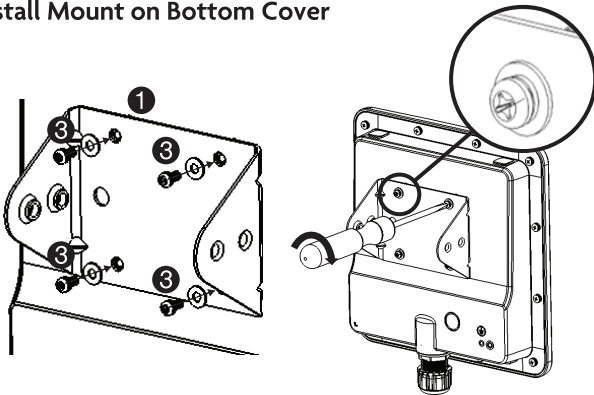

Use the M4 screws & W4 flat washers to attach the mount #1 to the access point.

Use a Phillips screwdriver to tighten all four the M4 screws.

Mounting on a Pole 1-1/2" to 2-1/2" (40-64 mm)

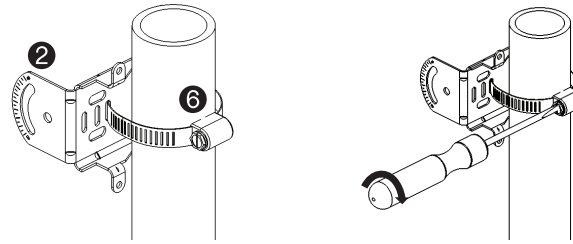

Attach stainless steel mount(2) to the pole using pipe strap/clamp. Installer may need to supply larger clamp if pole is larger than 1-1/2" diameter. Ensure strap/clamp is securely fastened.

Attach AP/Mount Assembly to Pole Mount

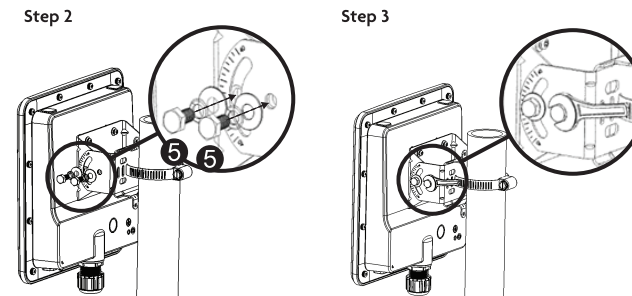
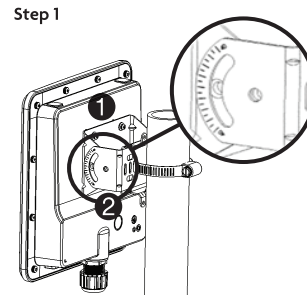

Step 1: Align mount #1 and mount #2 threaded holes.
Step 2: Attach mount halves using M5 screw, W5 flat washer, SW5 lock washer
Step 3: Use a wrench to tighten the four locking M5 screws.

Mounting on a Wall

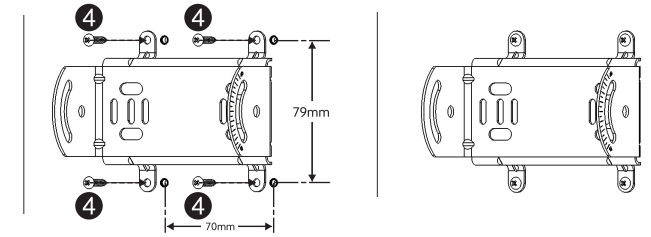

Pre-drill four blind holes in the wall. Hole spacing is 70mm horizontal and 79mm vertical.

Attach mount #2 to the wall using four screws or screws and anchors.

Attach AP/Mount Assembly to Wall Mount

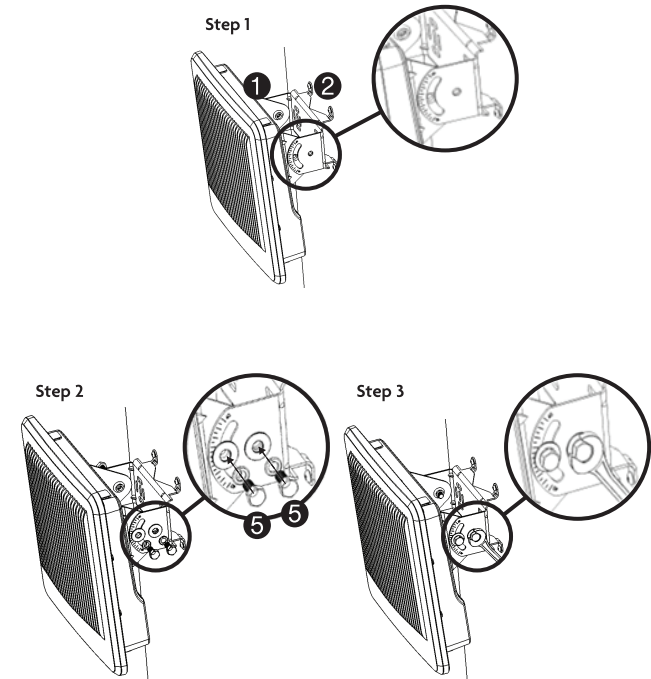

Step 1: Align mount #1 and mount #2 threaded holes.
Step 2: Attach mount halves using M5 screw, W5 flat washer, SW5 lock washer
Step 3: Use a wrench to tighten the four locking M5 screws.

Sales
801-822-5450
sales@luxul.com

Technical Support
801-822-5450
support@luxul.com

Copyright and Trademark Notices

No part of this document may be modified or adapted in any way, for any purposes without permission in writing from Luxul. The material in this document is subject to change without notice. Luxul reserves the right to make changes to any product to improve reliability, function, or design. No license is granted, either expressly or by implication or otherwise under any Luxul intellectual property rights. An implied license only exists for equipment, circuits and subsystems contained in this or any Luxul product.

© Copyright 2017 Luxul. All rights reserved. The name Luxul, the Luxul logo, the Luxul logo mark and Simply Connected are all trademarks and or registered trademarks of Luxul Wireless, Inc. All other trademarks and registered trademarks are property of their respective holders.

LUX-QIG-XAP-1440-v1 05121709

A brand of  **legrand**®

Fold



QUICK INSTALL GUIDE



AC1200 Dual-Band Outdoor Wireless Access Point XAP-1440

Includes:

- ▶ XAP-1440 Wireless Access Point
- ▶ PoE Injector and Power Cord
- ▶ Mounting Bracket and Hardware
- ▶ Ethernet Cable

LUXUL

Fold

READ ME FIRST - CONTROLLER COMPATIBILITY

This XAP-1440 is compatible with the Luxul Wireless Controller for fast, easy configuration and deployment of wireless networks with multiple APs.

- ✔ **Note:** *If you'll be using this AP with a Wireless Controller, refer to the Quick Install Guide included with the Wireless Controller for setup instructions.*

AP SETUP AND CONFIGURATION

1 Physical Installation

The XAP-1440 access point is designed for simple and efficient installation. However, due to the inherent complexity of outdoor installation, installation shall be performed only by experienced professionals.

Because the signal generated by the XAP-1440 is directional, the unit should be located at the perimeter of the desired coverage area, with the large flat surface aimed toward the center.

Mounting the Access Point

Mounting the access point is a simple process outlined in the following steps.

1. Refer to the included Mounting Guide leaflet to assemble the mount and secure the AP to a pole or wall mount.

Fold

2. Thread the Ethernet cable through the cable gland assembly as shown, connect it to the Ethernet connector, secure the cable gland to the threaded recess on the access point, then tighten the cable gland nut to secure and seal the cable gland.

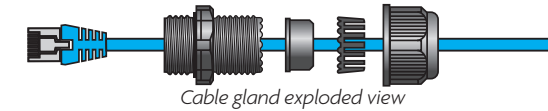

3. Adjust the access point for best performance. The vertical elevation angle can be adjusted with the four hex screws on the mount, while the horizontal angle can be adjusted by loosening the clamp and rotating the assembly on the pipe.

⚠ CAUTION: *To comply with RF regulations, the AP should be adjusted from 0 to -20 degrees (horizontal to downward-facing).*

⊗ Warning: *Do not locate the access point where it can come into contact with overhead power lines or other electric circuits. When installing the antenna, take extreme care not to come into contact with such circuits, as they may cause serious injury or death.*

✔ **Note:** *For proper installation and grounding of the antenna, please refer to national and local codes (e.g. U.S.: NFPA 70, National Electrical Code, Article 810, Canada: Canadian Electrical Code, Section 54). Statement 280.*

Fold

Fold

Fold

AP SETUP AND CONFIGURATION CONT.

2 Connecting Ethernet and Power

Ethernet and Power

The XAP-1440 is PoE ready and supports 802.3at PoE. A PoE injector is included with the device. To apply power, simply connect the end of the Ethernet cable to which the access point is connected to the provided PoE injector or other PoE switch. An Ethernet cable length of up to 300 feet can be used.

✔ **Note:** Luxul recommends at least Cat-5e unshielded twisted pair (CAT5e UTP) cabling. To ensure best performance and stable data transmission at 1000 Mbps, use Category-6 unshielded twisted pair (CAT6 UTP).

PoE Injector Setup

- ▶ **Data In:** Connect an Ethernet cable from your router or switch to the **Data In** port of the included PoE Injector
- ▶ **Data & PWR Out:** Connect an Ethernet cable from the **Data & PWR Out** port of the included PoE Injector to the PoE Port of the XAP-1440
- ▶ **AC Power:** Connect the included AC Cord to the Power Input of the Included Injector first and then to the AC outlet.



3 Preparing for Access

IP Addressing

If the XAP-1440 is connected to a network with a 192.168.0.X address scheme, and your computer shares a similar address on the same network, you can skip to the next step, **Access and Setup**.

✔ **Note:** If another device on your network shares the 192.168.0.10 address, you'll need to temporarily reassign or remove that device while you configure the XAP-1440.

If your network uses an address scheme other than 192.168.0.X, you'll need to set a temporary static IP address on the computer you're using for configuration. To do so, set the IP address of your computer to an address in the 192.168.0.X range.

Once you're finished configuring the AP, you can return your computer's IP configuration to normal, typically "Obtain Automatically/DHCP."

✔ **Note:** Visit <http://luxul.com/ip-addressing> to learn more about changing your computer's IP address and getting connected.

✔ **Note:** The XAP-1440 is not a router and will need to be connected to a network with a router in order to deliver Internet access.

4 Access and Setup

Getting Connected

- ▶ **Connecting Via an Ethernet Device:** Use Ethernet cable to connect your computer to the PoE switch or PoE injector to which the XAP-1440 is connected. Ethernet is the preferred method of connection.
- ▶ **Connecting Via a Wireless Device:** Connect your client device to the XAP-1440 default wireless network named **Luxul_XAP-1440**. The wireless network will run in Open Security mode, so no passphrase is required until Wireless Security is configured.

Logging In

To access the AP's web configuration, open your web browser and enter the AP's default 192.168.0.10 IP address in the address field. Log in to the AP using the default user name and password:

Default IP: 192.168.0.10

Username: admin

Password: admin

Once logged in, use Quick Setup and follow the online help to configure the access point as desired.

5 Hardware Operation

LED Indicators

The LED indicators are located on the bottom portion of the enclosure, near the cable gland.

PWR: If the green Power LED is On, the XAP-1440 is powered. If the Power LED is Off, the XAP-1440 is not receiving power. The Power LED blinks when the XAP-1440 is booting.



WLAN: If the blue LED is On, the wireless radio is active and wireless access is enabled. Off indicates the wireless radio is not active and wireless access is disabled.

PoE Injector: If the Green ON LED is illuminated, power is connected to the injector. If the ON LED is not lit, the injector is not receiving power.

Reset Button: The Reset button is located inside the cable gland opening of the XAP-1440 and is used to restore factory default settings. To Restore Default Settings, with the XAP-1440 powered on, press and hold the Reset button for approximately 10 seconds, then release.



⚠ **CAUTION:** Holding the Reset button for more than a few seconds will restore the AP to factory default and remove any custom configuration.

Fold

Fold

Fold

Frequency/Band Information

| | Channel | Frequency (MHz) | US (FCC) | Europe (ETSI)* |
|-------------|---------|-----------------|----------|----------------|
| 2.4GHz Band | 1 | 2412 | ✓ | ✓ |
| | 2 | 2417 | ✓ | ✓ |
| | 3 | 2422 | ✓ | ✓ |
| | 4 | 2427 | ✓ | ✓ |
| | 5 | 2432 | ✓ | ✓ |
| | 6 | 2437 | ✓ | ✓ |
| | 7 | 2442 | ✓ | ✓ |
| | 8 | 2447 | ✓ | ✓ |
| | 9 | 2452 | ✓ | ✓ |
| | 10 | 2457 | ✓ | ✓ |
| | 11 | 2462 | ✓ | ✓ |
| | 12 | 2467 | | ✓ |
| | 13 | 2472 | | ✓ |
| 5GHz Band | 36 | 5180 | ✓ | ✓ |
| | 40 | 5200 | ✓ | ✓ |
| | 44 | 5220 | ✓ | ✓ |
| | 48 | 5240 | ✓ | ✓ |
| | 149 | 5745 | ✓ | |
| | 153 | 5765 | ✓ | |
| | 157 | 5785 | ✓ | |
| | 161 | 5805 | ✓ | |
| | 165 | 5825 | ✓ | |

* On the European version of this product the maximum output power is 19.97dBm on frequencies 2412-2472MHz and 22.98dBm on frequencies 5180-5240MHz.



12884 S. Frontrunner Blvd, Suite 201
Draper, UT 84020-5490

1-801-822-5450

REGULATORY, COMPLIANCE AND SAFETY DOCUMENT

XAP-1440

AC1200 Dual-Band Outdoor Wireless Access Point

Last Update: 05/12/17

This documentation contains regulatory compliance and safety information. No part of this publication, or any other publication may be modified or adapted in any way, for any purposes without written permission from Luxul.

©2017 Luxul. All Rights Reserved.

The name Luxul, the Luxul logo, the Luxul logo mark and Simply Connected are all trademarks and/or registered trademarks of Luxul Wireless, Inc. All other trademarks and registered trademarks are property of their respective holders.

LUX-REG-COM- XAP1440-51217

FCC STATEMENT—WIRELESS FCC 2.4GHZ 802.11B/G/N

FCC Compliance

This device complies with Part 15 of the FCC Rules. Operation is subject to the following two conditions: (1) this device may not cause harmful interference, and (2) this device must accept any interference received, including interference that may cause undesired operation.

FCC ID: W59XAP1440

IC: 8584A-XAP1440

FCC Statement

This equipment has been tested and found to comply with the limits for a Class B digital device, pursuant to Part 15 of the FCC Rules. This equipment generates, uses and can radiate radio frequency energy and, if not installed and used in accordance with the instructions, may cause harmful interference to radio communications. However, there is no guarantee that interference will not occur in a particular installation. If this equipment does cause harmful interference to radio or television reception, which can be determined by turning the equipment off and on, the user is encouraged to try to correct the interference by one of the following measures:

- ▶ Reorient or relocate the receiving antenna.
- ▶ Increase the separation between the equipment and receiver.
- ▶ Connect the equipment to an outlet on a circuit different from that to which the receiver is connected.
- ▶ Consult the dealer or an experienced radio/TV technician for help.

Refer to included Quick Installation Guide for device-specific FCC Class information.

FCC Caution: Any changes or modifications not expressly approved by the party responsible for compliance could void the user's authority to operate this equipment.

- ▶ This device complies with part 15 of the FCC Rules.
- ▶ This transmitter must not be co-located or operated in conjunction with any other antenna or transmitter.

The XAP-1440 access point is designed for simple and efficient installation. However, due to the inherent complexity of outdoor installation, installation shall be performed only by experienced professionals.

Radiation Exposure Statement

This equipment complies with FCC radiation exposure limits set forth for an uncontrolled environment. This equipment should be installed and operated with a minimum distance of 20cm between the radiator & your body.

REGULATORY COMPLIANCE

The device complies with internationally-recognized standards covering human exposure to electromagnetic fields from radio devices. This equipment also complies with FCC radiation exposure set forth for an uncontrolled environment. In order to avoid the possibility of exceeding the FCC radio frequency exposure limits, human proximity to the antenna shall not be less than 20cm (15.7 in) during normal operation. Unauthorized antennas, modifications, or attachments could cause damage and may violate regulatory approvals. Any changes or modifications not expressly approved by the party responsible for compliance could void the authority to operate the equipment.

Luxul equipment marketed in the U.S. is restricted to usage of channels 1-11 only for 2.4GHz and channels 36-48/149-165 for 5GHz.

Warnings and Safety Information

- ▶ Ensure that the electrical circuits have appropriate grounding, overload and surge protection.
- ▶ Attach only approved power cords to the device.
- ▶ Verify there is adequate ventilation around the device, and that ambient temperatures meet equipment operation specifications.
- ▶ DO NOT install in or near hot or humid places, such as a kitchen or bathroom. Take care to minimize exposure to excessive heat or moisture.
- ▶ Small parts and plastic bags used for packaging may be harmful to small children. KEEP ALL ACCESSORIES OUT OF THE REACH OF CHILDREN!
- ▶ This product may become hot when in use for extended time periods. This is normal and is not a malfunction. DO NOT install where it will be exposed to paper, cloth or other flammable materials.
- ▶ Operation within the 5.15-5.25GHz frequency range is restricted to indoor use.

Fold

Health and Safety Recommendations

Warnings for the use of Wireless Devices: Please observe all warning notices with regard to the use of wireless devices

Potentially Hazardous Atmospheres: You are reminded of the need to observe restrictions on the use of radio devices in fuel depots, chemical plants, and other similar areas where the air contains chemicals or particles (such as grain, dust, or metal powders).

Safety in Hospitals: Wireless devices transmit radio frequency energy and may affect medical electrical equipment. When installed adjacent to other equipment, it is advised to verify that the adjacent equipment is not adversely affected.

RF Exposure Guidelines

Safety Information: The device complies with internationally-recognized standards covering human exposure to electromagnetic fields from radio devices.

Warning: Exposure to Radio Frequency (RF) Radiation:

The radiated output of this device is below FCC radio frequency exposure limits. Nevertheless, the device should be used in such a manner that the potential for human contact during normal operation is minimized.

- ▶ The end user must avoid any extended human RF exposure directly in front of the device, up to a distance of 20cm, when the unit is on.
- ▶ When servicing the equipment and selecting a location for the antennas, it is important to note that a minimum distance of 20cm is required between personnel and the device or antenna, to comply with radio frequency exposure limits.
- ▶ The antenna used for this transmitter must be installed to provide a separation distance of at least 20cm from all persons and must not be co-located or operating in conjunction with any other antenna or transmitter.

The following safety precautions should be observed:

- ▶ Do not touch or move the antenna while the unit is transmitting or receiving.
- ▶ Do not hold any component containing the radio such that the antenna is very close or touching any exposed parts of the body, especially the face or eyes, while transmitting.
- ▶ Do not operate the radio or attempt to transmit data unless the antenna is connected; this behavior may cause damage to the radio.

ErP Statement

The purpose of this product is to create a constant network connection for your devices. It does not have a standby mode or use a power management mode. If you wish to power down this product, please unplug it from the power socket.

Industry Canada

This device complies with Industry Canada licence-exempt RSS-247 standard(s). Operation is subject to the following two conditions: (1) this device may not cause interference, and (2) this device must accept any interference, including interference that may cause undesired operation of the device.

Le présent appareil est conforme aux CNR-247 d'Industrie Canada applicables aux appareils radio exempts de licence. L'exploitation est autorisée aux deux conditions suivantes : (1) l'appareil ne doit pas produire de brouillage, et (2) l'utilisateur de l'appareil doit accepter tout brouillage radioélectrique subi, même si le brouillage est susceptible d'en compromettre le fonctionnement.

The device meets the exemption from the routine evaluation limits in section 2.5 of RSS-102 and compliance with RSS-102 RF exposure; users can obtain Canadian information on RF exposure and compliance.

Le dispositif rencontre l'exemption des limites courantes d'évaluation dans la section 2.5 de RSS-102 et la conformité à l'exposition de RSS-102 rf, utilisateurs peut obtenir l'information canadienne sur l'exposition et la conformité de rf.

Fold

This transmitter must not be co-located or operating in conjunction with any other antenna or transmitter. This equipment should be installed and operated with a minimum distance of 20 centimeters between the radiator and your body. Cet émetteur ne doit pas être Co-placé ou ne fonctionnant en même temps qu'aucune autre antenne ou émetteur. Cet équipement devrait être installé et actionné avec une distance minimum de 20 centimètres entre le radiateur et votre corps.

Caution:

To comply with RF regulations, the AP should be adjusted from 0 to -20 degrees (horizontal to downward-facing).

(i) the device for operation in the band 5150-5250 MHz is only for indoor use to reduce the potential for harmful interference to co-channel mobile satellite systems;

(ii) the maximum antenna gain permitted for devices in the band 5725-5850 MHz shall be such that the equipment still complies with the e.i.r.p. limits specified for point-to-point and non-point-to-point operation as appropriate.

Avertissement:

(i) les dispositifs fonctionnant dans la bande 5150-5250 MHz sont réservés uniquement pour une utilisation à l'intérieur afin de réduire les risques de brouillage préjudiciable aux systèmes de satellites mobiles utilisant les mêmes canaux;

(ii) le gain maximal d'antenne permis (pour les dispositifs utilisant la bande de 5725 à 5850 MHz) doit être conforme à la limite de la p.i.r.e. spécifiée pour l'exploitation point à point et l'exploitation non point à point, selon le cas;

CAN ICES-3(B)/NMB-3(B)

Fold

Simplified EU declaration of conformity

Hereby, **Luxul** declares that the radio equipment type **XAP-1440** is in compliance with Directive 2014/53/EU.

The full text of the EU declaration of conformity is available at the following internet address: **<http://luxul.com/regulatory-compliance>**

Le soussigné, **Luxul**, déclare que l'équipement radioélectrique du type **XAP-1440** est conforme à la directive 2014/53/UE.

Le texte complet de la déclaration UE de conformité est disponible à l'adresse internet suivante: **<http://luxul.com/regulatory-compliance>**

Hiermit erklärt **Luxul**, dass der Funkanlagentyp **XAP-1440** der Richtlinie 2014/53/EU entspricht.

Der vollständige Text der EU-Konformitätserklärung ist unter der folgenden Internetadresse verfügbar: **<http://luxul.com/regulatory-compliance>**

Hierbij verklaar ik, **Luxul**, dat het type radioapparatuur **XAP-1440** conform is met Richtlijn 2014/53/EU.

De volledige tekst van de EU-conformiteitsverklaring kan worden geraadpleegd op het volgende internetadres: **<http://luxul.com/regulatory-compliance>**

A brand of  **legrand**